

Graduate Textbook in Mathematics

LINFAN MAO

**AUTOMORPHISM GROUPS OF MAPS, SURFACES AND
SMARANDACHE GEOMETRIES**

Second Edition

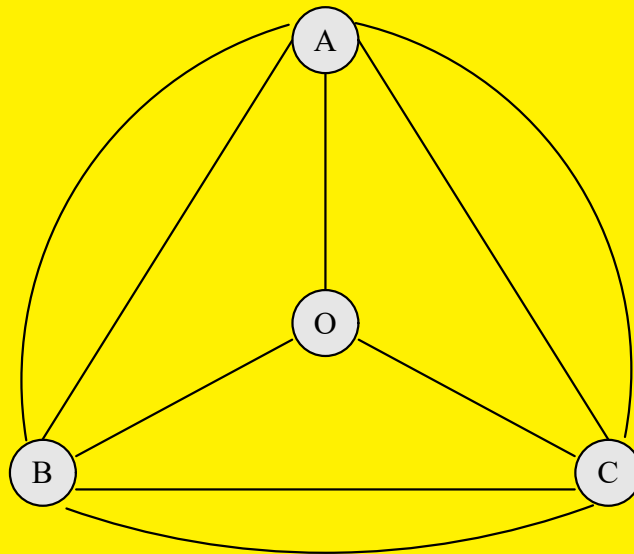

The Education Publisher Inc.

2011

Linfan MAO

Academy of Mathematics and Systems
Chinese Academy of Sciences
Beijing 100190, P.R.China

and

Beijing Institute of Civil Engineering and Architecture
Beijing 100044, P.R.China

Email: *maolinfan@163.com*

**Automorphism Groups of Maps, Surfaces and
Smarandache Geometries**

Second Edition

The Education Publisher Inc.

2011

This book can be ordered from:

The Educational Publisher, Inc.

1313 Chesapeake Ave.

Columbus, Ohio 43212, USA

Toll Free: 1-866-880-5373

E-mail: *info@edupublisher.com*

Website: *www.EduPublisher.com*

Peer Reviewers:

F.Tian, Academy of Mathematics and Systems, Chinese Academy of Sciences, Beijing 100080, P.R.China.

Y.P.Liu and R.X.Hao, Department of Applied Mathematics, Beijing Jiaotong University, Beijing 100044, P.R.China. S.Bhattacharya, Alaska Pacific University, AK, USA.

H.Iseri, Department of Mathematics and Computer Information Science, Mansfield University, Mansfield, PA 16933, USA.

Copyright 2011 by The Education Publisher Inc. and Linfan Mao

Many books can be downloaded from the following **Digital Library of Science:**

<http://www.gallup.unm.edu/~smarandache/eBooks-otherformats.htm>

ISBN: 978-1-59973-154-4

Printed in America

Preface to the Second Edition

Automorphism groups survey similarities on mathematical systems, which appear nearly in all mathematical branches, such as those of algebra, combinatorics, geometry, \dots and theoretical physics, theoretical chemistry, etc.. In geometry, configurations with high symmetry born symmetrical patterns, a kind of beautiful pictures in aesthetics. Naturally, automorphism groups enable one to distinguish systems by similarity. More automorphisms imply more symmetries of that system. This fact has established the fundamental role of automorphism groups in modern sciences. So it is important for graduate students knowing automorphism groups with applications.

The first edition of this book is in fact consisting of my post-doctoral reports in Chinese Academy of Sciences in 2005, not self-contained and not suitable as a textbook for graduate students. Many friends of mine suggested me to extend it to a textbook for graduate students in past years. That is the initial motivation of this edition. Besides, I also wish to survey applications of Smarandache's notion with combinatorics, i.e., mathematical combinatorics to automorphism groups of maps, surfaces and Smarandache geometries in this edition. The two objectives advance me to complete this self-contained book.

Indeed, there are many ways for introducing automorphism groups. I plan them for graduate students both in combinatorics and geometry. The materials in this book include groups with actions, graphs with symmetries, graphs on surfaces with enumeration, regular maps, isometries on finitely or infinitely pseudo-Euclidean spaces and an interesting notion for developing mathematical sciences in 21th century, i.e. the CC conjecture.

Contents in in this book are outlined following.

Chapters 1 and 2 are an introduction to groups. Topics such as those of groups and

subgroups, regular representations, homomorphism theorems, structures of finite Abelian groups, transitive groups, automorphisms of groups, characteristic subgroups, p -groups, primitive groups, regular normal subgroups are discussed and a few useful results, for examples, these Burnside lemma, Sylow theorem and O’Nan-Scott theorem are established. Furthermore, an elementary introduction to multigroups and permutation multigroups, including locally or globally transitive groups, locally or globally regular groups can be also found in Chapters 1 and 2.

For getting automorphism groups of graphs, these symmetric graphs, including vertex-transitive graphs, edge-transitive graphs, arc-transitive graphs and semi-arc transitive graphs are introduced in Chapter 3. Indeed, the automorphism group of a normally Cayley graph or GRR of a finite group can be completely determined. For classifying maps on surfaces underlying a graph G , one needs to consider the action of semi-arc automorphism group $\text{Aut}_{\frac{1}{2}}G$ on its semi-arc set $X_{\frac{1}{2}}G$. Such groups are not very different from that of automorphism group of G . In fact, $\text{Aut}_{\frac{1}{2}}G = \text{Aut}G$ if G is loop-free. This chapter also discusses multigroup action graphs, which make a few results on globally transitive groups in Chapter 2 simple.

As a preparing for combinatorial maps with applications to Klein surfaces, Chapter 4 is mainly on surfaces, including both topological surfaces and Klein surfaces. Indeed, Sections 4.1-4.3 can be used to an introduction on topological surfaces and Sections 4.4-4.5 on Klein surfaces. These fundamental techniques or results on surfaces, such as those of classifying theorem of surfaces by elementary operations, Seifert-Van Kampen theorem, fundamental groups of surfaces, NEC groups and automorphism groups of Klein surfaces are well discussed in this chapter.

Chapters 5-7 are an introduction on algebraic maps, i.e., graphs on surfaces, particularly, automorphisms of maps. The rotation embedding scheme on graphs and its contribution to algebraic maps can be found in Sections 5.1-5.2. Then map groups, regular maps and the technique for constructing regular maps by triangle groups are interpreted in Sections 5.3-5.5.

Chapter 6 concentrates on lifting automorphisms of maps by that of voltage assignment technique. A condition for a group being that of a lifted map and a combinatorial refinement of the Hurwitz theorem on Riemann surfaces are gotten in Sections 6.1-6.4. After that, Section 6.5 concerns the order of an automorphism of Klein surfaces by that of map, which is an interesting problem in Klein surfaces.

The objective of Chapter 7 is to find presentations of automorphisms of maps underlying a graph. A general condition for a graph group being that of map is established in the first section. Then all these presentations for automorphisms of maps underlying a complete graph, a semi-regular graph or a bouquet are found, which are useful for enumerating maps underlying such a graph.

Applying results in Chapter 7 enables one to classify maps, i.e., enumerating rooted maps or maps underlying a graph in Chapter 8. These enumerating results on rooted maps underlying a graph are presented in Sections 8.1-8.2 by group action. It is worth to celebrate that a sum-free formula for rooted maps underlying a graph is found by the action semi-arc automorphism group of graph. Then a general scheme for enumerating maps underlying a graph is established in Section 8.3. By applying this scheme and those presentations of automorphisms of maps in Chapter 7, these complete maps, semi-regular maps and one-vertex maps are enumerated in Sections 8.4-8.6, respectively.

Chapter 9 turns on a special kind of automorphisms, i.e., isometries on Smarandache geometry, a mixed geometry with an axiom validated or invalidated, or only invalidated but in at least two distinct ways. A formal definition with examples for such geometry can be found in Sections 9.1-9.2. Then all isometries on finitely or infinitely pseudo-Euclidean spaces (\mathbf{R}^n, μ) are determined in Sections 9.3-9.4. It should be noted that for the finite case, all such isometries can be combinatorially characterized by graphs embedded in the Euclidean space \mathbf{R}^n .

The final chapter concentrates on an important notion for developing mathematical sciences in 21st century, i.e., the CC conjecture appeared in Chapter 5 of the first edition in 2005. That is the originality of *mathematical combinatorics*. Its contributions to mathematics and physics are introduced, and research problems are presented in this chapter. These interested readers are referred to [Mao25] for its further applications to geometry or Riemann geometry.

This edition was began to prepare in 2009. Many colleagues and friends of mine have given me enthusiastic support and endless helps in writing. Here I must mention some of them. On the first, I would like to give my sincerely thanks to Dr.Perze for his encourage and endless help. Without his encourage, I would do some else works, can not investigate mathematical combinatorics for years and finish this edition. Second, I would like to thank Professors Feng Tian, Yanpei Liu, Mingyao Xu, Jiyi Yan, Fuji Zhang and Wenpeng Zhang for them interested in my research works. Their encouraging and warm-

hearted supports advance this book. Thanks are also given to Professors Han Ren, Yanqiu Huang, Junliang Cai, Rongxia Hao, Wenguang Zai, Goudong Liu, Weili He and Erling Wei for their kindly helps and often discussing problems in mathematics altogether. Partially research results of mine were reported at Chinese Academy of Mathematics & System Sciences, Beijing Jiaotong University, Beijing Normal university, East-China Normal University and Hunan Normal University in past years. Some of them were also reported at *The 2nd and 3rd Conference on Graph Theory and Combinatorics of China* in 2006 and 2008. My sincerely thanks are also give to these audiences discussing mathematical topics with me in these periods.

Of course, I am responsible for the correctness all of these materials presented here. Any suggestions for improving this book or solutions for open problems in this book are welcome.

L.F.Mao

June 24, 2011

Contents

Preface to the Second Edition	i
Chapter 1 Groups	1
§1.1 Sets	2
1.1.1 Set	2
1.1.2 Cardinality	3
1.1.3 Subset Enumeration	5
§1.2 Groups	6
1.2.1 Algebra System	6
1.2.2 Group	8
1.2.3 Group Property	10
1.2.4 Subgroup	12
1.2.5 Symmetric Group	16
1.2.6 Regular Representation	18
§1.3 Homomorphism Theorems	20
1.3.1 Homomorphism	20
1.3.2 Quotient Group	21
1.3.3 Isomorphism Theorem	23
§1.4 Abelian Groups	24
1.4.1 Direct Product	24
1.4.2 Basis	26
1.4.3 Finite Abelian Group Structure	28
§1.5 MultiGroups	30
1.5.1 MultiGroup	30
1.5.2 Submultigroup	31
1.5.3 Normal Submultigroup	33
1.5.4 Abelian Multigroup	36
1.5.5 Bigroup	37
1.5.6 Constructing Multigroup	38
§1.6 Remarks	39

Chapter 2 Action Groups	41
§2.1 Permutation Groups.....	42
2.1.1 Group Action.....	42
2.1.2 Stabilizer.....	43
2.1.3 Burnside Lemma.....	44
§2.2 Transitive Groups.....	45
2.2.1 Transitive Group.....	45
2.2.2 Multiply Transitive Group.....	46
2.2.3 Sharply k-Transitive Group.....	47
§2.3 Automorphisms of Groups.....	49
2.3.1 Automorphism Group.....	49
2.3.2 Characteristic Subgroup.....	52
2.3.3 Commutator Subgroup.....	53
§2.4 P-Groups.....	55
2.4.1 Sylow Theorem.....	55
2.4.2 Application of Sylow Theorem.....	57
2.4.3 Listing p-Group.....	58
§2.5 Primitive Groups.....	61
2.5.1 Imprimitve Block.....	61
2.5.2 Primitive Group.....	62
2.5.3 Regular Normal Subgroup.....	64
2.5.4 O' Nan-Scott Theorem.....	66
§2.6 Local Action and Extended Groups.....	69
2.6.1 Local Action Group.....	69
2.6.2 Action Extended Group.....	71
2.6.3 Action MultiGroup.....	74
§2.7 Remarks.....	77
Chapter 3 Graph Groups	79
§3.1 Graphs.....	80
3.1.1 Graph.....	80
3.1.2 Graph Operation.....	83
3.1.3 Graph Property.....	85

3.1.4 Smarandachely Graph Property	89
§3.2 Graph Groups	92
3.2.1 Graph Automorphism	92
3.2.2 Graph Group	92
3.2.3 Γ -Action	94
§3.3 Symmetric Graphs	96
3.3.1 Vertex-Transitive Graph	96
3.3.2 Edge-Transitive Graph	100
3.3.3 Arc-Transitive Graph	101
§3.4 Graph Semi-Arc Groups	103
3.4.1 Semi-Arc Set	103
3.4.2 Graph Semi-Arc Group	104
3.4.3 Semi-Arc Transitive Graph	105
§3.5 Graph Multigroups	106
3.5.1 Graph Multigroup	106
3.5.2 Multigroup Action Graph	110
3.5.3 Globally Transitivity	113
§3.6 Remarks	114
Chapter 4 Surface Groups	117
§4.1 Surfaces	118
4.1.1 Topological Space	118
4.1.2 Continuous Mapping	119
4.1.3 Homeomorphic Space	120
4.1.4 Surface	121
4.1.5 Quotient Space	123
§4.2 Classification Theorem	125
4.2.1 Connected Sum	125
4.2.2 Polygonal Presentation	126
4.2.3 Elementary Equivalence	128
4.2.4 Classification Theorem	131
4.2.5 Euler Characteristic	134
§4.3 Fundamental Groups	136

4.3.1	Homotopic Mapping	136
4.3.2	Fundamental Group	137
4.3.3	Seifert-Van Kampen Theorem	141
4.3.4	Fundamental Group of Surface	143
§4.4	NEC Groups	145
4.4.1	Dianalytic Function	145
4.4.2	Klein Surface	146
4.4.3	Morphism of Klein Surface	148
4.4.4	Planar Klein Surface	149
4.4.5	NEC Group	150
§4.5	Automorphisms of Klein Surfaces	156
4.5.1	Morphism Property	156
4.5.2	Double Covering of Klein Surface	158
4.5.3	Discontinuous Action	159
4.5.4	Automorphism of Klein Surface	161
§4.6	Remarks	165
Chapter 5 Map Groups		167
§5.1	Graphs on Surfaces	168
5.1.1	Cell Embedding	168
5.1.2	Rotation System	170
5.1.3	Equivalent Embedding	172
5.1.4	Euler-Poincaré Characteristic	173
§5.2	Combinatorial Maps	174
5.2.1	Combinatorial Map	174
5.2.2	Dual Map	177
5.2.3	Orientability	178
5.2.4	Standard Map	179
§5.3	Map Groups	181
5.3.1	Isomorphism of Maps	181
5.3.2	Automorphism of Map	184
5.3.3	Combinatorial Model of Klein Surface	190
§5.4	Regular Maps	191

5.4.1	Regular Map	191
5.4.2	Map NEC-Group	194
5.4.3	Cayley Map	195
5.4.4	Complete Map	197
§5.5	Constructing Regular Maps by Groups	199
5.5.1	Regular Tessellation	199
5.5.2	Regular Map on Finite Group	201
5.5.3	Regular Map on Finite Multigroup	205
§5.6	Remarks	208
Chapter 6	Lifting Map Groups	211
§6.1	Voltage Maps	212
6.1.1	Covering Space	212
6.1.2	Covering Mapping	213
6.1.3	Voltage Map with Lifting	215
§6.2	Group being That of a Map	218
6.2.1	Lifting Map Automorphism	218
6.2.2	Map Exponent Group	221
6.2.3	Group being That of a Lifted Map	223
§6.3	Measures on Maps	226
6.3.1	Angle on Map	227
6.3.2	Non-Euclid Area on Map	227
§6.4	A Combinatorial Refinement of Huriwitz Theorem	229
6.4.1	Combinatorially Huriwitz Theorem	229
6.4.2	Application to Klein Surface	230
§6.5	The Order of Automorphism of Klein Surface	233
6.5.1	The Minimum Genus of a Fixed-Free Automorphism	233
6.5.2	The Maximum Order of Automorphisms of a Map	236
§6.6	Remarks	239
Chapter 7	Map Automorphisms Underlying a Graph	241
§7.1	A Condition for Graph Group Being That of Map	242
7.1.1	Orientation-Preserving or Reversing	242
7.1.2	Group of a Graph Being That of Map	244

§7.2 Automorphisms of a Complete Graph on Surfaces	248
7.2.1 Complete Map	248
7.2.2 Automorphisms of Complete Map	250
§7.3 Map-Automorphism Graphs	256
7.3.1 Semi-Regular Graph	256
7.3.2 Map-Automorphism Graph	260
§7.4 The Automorphisms of One-Face Maps	261
7.4.1 One-Face Map	261
7.4.2 Automorphisms of One-Face Map	262
§7.5 Remarks	265
Chapter 8 Enumerating Maps on Surfaces	267
§8.1 Roots Distribution on Embeddings	268
8.1.1 Roots on Embedding	268
8.1.2 Root Distribution	269
8.1.3 Rooted Map	272
§8.2 Rooted Map on Genus Underlying a Graph	275
8.2.1 Rooted Map Polynomial	275
8.2.2 Rooted Map Sequence	278
§8.3 A Scheme for Enumerating Maps Underlying a Graph	283
§8.4 The Enumeration of Complete Maps on Surfaces	286
§8.5 The Enumeration of Maps Underlying a Semi-Regular Graph	292
8.5.1 Crosscap Map Group	292
8.5.2 Enumerating Semi-Regular Map	294
§8.6 The Enumeration of a Bouquet on Surfaces	299
8.6.1 Cycle Index of Group	299
8.6.2 Enumerating One-Vertex Map	299
§8.7 Remarks	303
Chapter 9 Isometries on Smarandache Geometry	306
§9.1 Smarandache Geometry	307
9.1.1 Geometrical Axiom	307
9.1.2 Smarandache Geometry	307
9.1.3 Mixed Geometry	308

§9.2 Classifying Iseri' s Manifolds	310
9.2.1 Iseri' s Manifold	310
9.2.2 A Model of Closed Iseri' s Manifold	310
9.2.3 Classifying Closed Iseri' s Manifolds	311
§9.3 Isometries of Smarandache 2-Manf olds	317
9.3.1 Smarandachely Automorphism	317
9.3.2 Isometry on R^2	317
9.3.3 Finitely Smarandache 2-Manifold	321
9.3.4 Smarandachely Map	325
9.3.5 Inf nitely Smarandache 2-Manifold	327
§9.4 Isometries of Pseudo-Euclidean Spaces	332
9.4.1 Euclidean Space	332
9.4.2 Linear Isometry on Euclidean Space	333
9.4.3 Isometry on Euclidean Space	334
9.4.4 Pseudo-Euclidean Space	335
9.4.5 Isometry on Pseudo-Euclidean Space	340
§9.5 Remarks	343
Chapter 10 CC Conjecture	346
§10.1 CC Conjecture on Mathematics	347
10.1.1 Combinatorial Speculation	347
10.1.2 CC Conjecture	347
10.1.3 CC Problems in Mathematics	349
§10.2 CC Conjecture to Mathematics	352
10.2.1 Contribution to Algebra	352
10.2.2 Contribution to Metric Space	355
§10.3 CC Conjecture to Physics	358
10.3.1 M-Theory	359
10.3.2 Combinatorial Cosmos	361
References	364
Index	377

There are many wonderful things in nature, but the most wonderful of all is man.

Sophocles, an ancient Greek dramatist

CHAPTER 1.

Groups

A *group* is surely the laws of combinations on its symbols, an important conception of mathematics. One classifies groups into two categories, i.e., the *abstract groups* and *permutation groups*. Its application fields includes physics, chemistry, biology, crystallography,...., etc.. Now it has become a fundamental of all branches of mathematical sciences. For introducing readers to abstract groups, these algebraic systems, groups with subgroups, regular representation, homomorphism theorems, Abelian groups with structures, multigroups and submultigroups with elementary properties are discussed in this chapter, where multigroups are generalized algebraic systems of groups by Smarandache multi-space, i.e., a union of groups, different two by two.

§1.1 SETS

1.1.1 Set. A set \mathfrak{S} is a category consisting of parts, i.e., a collection of objects possessing with a property \mathcal{P} . Usually, a set \mathfrak{S} is denoted by

$$\mathfrak{S} = \{ x \mid x \text{ possesses the property } \mathcal{P} \}.$$

If an element x possesses the property \mathcal{P} , we say that x is an element of the set \mathfrak{S} , denoted by $x \in \mathfrak{S}$. On the other hand, if an element y does not possess the property \mathcal{P} , then it is not an element of \mathfrak{S} , denoted by $y \notin \mathfrak{S}$.

For examples,

$$Z^+ = \{1, 2, \dots, n, \dots\},$$

$$P = \{\text{cities with more than 2 million peoples in China}\},$$

$$E = \{(x, y) \mid 0 \leq x \leq 1, 0 \leq y \leq 1\}$$

are 3 sets by definition, and the number $n \geq 1$, city with more than 2 million peoples in China and point (x, y) with $0 \leq x, y \leq 1$ are elements of sets Z^+ , P and E , respectively.

Let S, T be two sets. These binary operations *union* $S \cup T$ and *intersection* $S \cap T$ of sets S and T are defined by

$$S \cup T = \{x \mid x \in S \text{ or } x \in T\}, \quad S \cap T = \{x \mid x \in S \text{ and } x \in T\}.$$

These operations \cup and \cap have the following laws.

Theorem 1.1.1 *Let X, T and R be sets. Then*

$$(i) \quad X \cup X = X \text{ and } X \cap X = X;$$

$$(ii) \quad X \cup T = T \cup X \text{ and } X \cap T = T \cap X;$$

$$(iii) \quad X \cup (T \cup R) = (X \cup T) \cup R \text{ and } X \cap (T \cap R) = (X \cap T) \cap R;$$

$$(iv) \quad X \cup (T \cap R) = (X \cup T) \cap (X \cup R),$$

$$X \cap (T \cup R) = (X \cap T) \cup (X \cap R).$$

Proof These laws (i)-(iii) can be verified immediately by definition. For the law (iv), let $x \in X \cup (T \cap R) = (X \cup T) \cap (X \cup R)$. Then $x \in X$ or $x \in T \cap R$, i.e., $x \in T$ and $x \in R$. Now if $x \in X$, we know that $x \in X \cup T$ and $x \in X \cup R$. Whence, we get that

$x \in (X \cup T) \cap (X \cup R)$. Otherwise, $x \in T \cap R$, i.e., $x \in T$ and $x \in R$. We also get that $x \in (X \cup T) \cap (X \cup R)$.

Conversely, for $\forall x \in (X \cup T) \cap (X \cup R)$, we know that $x \in X \cup T$ and $x \in X \cup R$, i.e., $x \in X$ or $x \in T$ and $x \in R$. If $x \in X$, we get that $x \in X \cup (T \cap R)$. If $x \in T$ and $x \in R$, we also get that $x \in X \cup (T \cap R)$. Therefore, $X \cup (T \cap R) = (X \cup T) \cap (X \cup R)$ by definition.

Similarly, we can also get the law $\overline{X \cap T} = \overline{X} \cup \overline{T}$. \square

Let \mathfrak{S}_1 and \mathfrak{S}_2 be two sets. If for $\forall x \in \mathfrak{S}_1$, there must be $x \in \mathfrak{S}_2$, then we say that \mathfrak{S}_1 is a *subset* of \mathfrak{S}_2 , denoted by $\mathfrak{S}_1 \subseteq \mathfrak{S}_2$. A subset \mathfrak{S}_1 of \mathfrak{S}_2 is *proper*, denoted by $\mathfrak{S}_1 \subset \mathfrak{S}_2$ if there exists an element $y \in \mathfrak{S}_2$ with $y \notin \mathfrak{S}_1$ hold. It should be noted that the void (empty) set \emptyset is a subset of all sets by definition. All subsets of a set \mathfrak{S} naturally form a set $\mathcal{P}(\mathfrak{S})$, called the *power set* of \mathfrak{S} .

Now let \mathfrak{S} be a set and $X \in \mathcal{P}(\mathfrak{S})$. We define the complement \overline{X} of $X \subset \mathfrak{S}$ to be

$$\overline{X} = \{y \mid y \in \mathfrak{S} \text{ but } y \notin X\}.$$

Then we know the following result.

Theorem 1.1.2 *Let \mathfrak{S} be a set, $S, T \subset \mathfrak{S}$. Then*

- (i) $X \cap \overline{X} = \emptyset$ and $X \cup \overline{X} = \mathfrak{S}$;
- (ii) $\overline{\overline{X}} = X$;
- (iii) $\overline{X \cup T} = \overline{X} \cap \overline{T}$ and $\overline{X \cap T} = \overline{X} \cup \overline{T}$.

Proof The laws (i) and (ii) can be immediately verified by definition. For (iii), let $x \in \overline{X \cup T}$. Then $x \in \mathfrak{S}$ but $x \notin X \cup T$, i.e., $x \notin X$ and $x \notin T$. Whence, $x \in \overline{X}$ and $x \in \overline{T}$. Therefore, $x \in \overline{X} \cap \overline{T}$. Now for $\forall x \in \overline{X} \cap \overline{T}$, there must be $x \in \overline{X}$ and $x \in \overline{T}$, i.e., $x \in \mathfrak{S}$ but $x \notin X$ and $x \notin T$. Hence, $x \notin X \cup T$. This fact implies that $x \in \overline{X \cup T}$. By definition, we find that $\overline{X \cup T} = \overline{X} \cap \overline{T}$. Similarly, we can also get the law $\overline{X \cap T} = \overline{X} \cup \overline{T}$. This completes the proof. \square

1.1.2 Cardinality. A *mapping* f from a set S to T is a subset of $S \times T$ such that for $\forall x \in S$, $|f \cap (\{x\} \times T)| = 1$, i.e., $f \cap (\{x\} \times T)$ only has one element. Usually, we denote a mapping f from S to T by $f : S \rightarrow T$ and $f(x)$ the second component of the unique element of $f \cap (\{x\} \times T)$, called the *image* of x under f .

A mapping $f : S \rightarrow T$ is called *injection* if for $\forall y \in T$, $|f^{-1}(y)| \leq 1$ and *surjection* if $|f^{-1}(y)| \geq 1$. If it is both injection and surjection, i.e., $|f^{-1}(y)| = 1$, then it is called a *bijection* or a *1 – 1 mapping*.

Def nition 1.1.1 Let S, T be two sets. If there is a bijection $f : S \rightarrow T$, then the cardinality of S is equal to that of T . Particularly, if $T = \{1, 2, \dots, n\}$, the cardinal number, usually called the order of S is defined to be n , denoted by $|S| = n$.

Def nition 1.1.2 A set S is finite if and only if $c(S) < \infty$. Otherwise, S is infinite.

Def nition 1.1.3 A set S is countable if there is a bijection $f : S \rightarrow \mathbb{Z}^+$.

By this definition, one can enumerate all elements of S by an infinite sequence $s_1, s_2, \dots, s_n, \dots$. These \mathbb{Z}^+ , P and E in Subsection 1.1.1 are countable, finite and infinite set, respectively. Generally, we have the following result.

Theorem 1.1.3 A set S is infinite if and only if it contains a countable subset.

Proof If S contains a countable subset, by Definition 1.1.3 it is infinite. Now if S is infinite, choose $s_1 \in S$, $s_2 \in S \setminus \{s_1\}$, $s_3 \in S \setminus \{s_1, s_2\}$, ..., $s_n \in S \setminus \{s_1, s_2, \dots, s_{n-1}\}$, By assumption, S is infinite, so for any integer $n \geq 1$, the set $S \setminus \{s_1, s_2, \dots, s_{n-1}\}$ can never be empty. Therefore, we can always choose an element s_n from it and this process will never stop until we get an infinite sequence $s_1, s_2, \dots, s_n, \dots$, a countable subset of S . \square

Theorem 1.1.4 The set \mathbb{R} of all real numbers is not countable.

Proof Assume there is an enumeration $r_1, r_2, \dots, r_n, \dots$ of all real numbers. Then list the decimal expansion of these numbers after the decimal point in their enumerated order in a square array:

$$\begin{aligned} r_1 &= \dots .a_{11}a_{12}a_{13}a_{14} \dots \\ r_2 &= \dots .a_{21}a_{22}a_{23}a_{24} \dots \\ r_3 &= \dots .a_{31}a_{32}a_{33}a_{34} \dots \\ r_4 &= \dots .a_{41}a_{42}a_{43}a_{44} \dots \\ &\dots \dots \dots \end{aligned}$$

where a_{mn} is the n th digit after the decimal point of r_m . Then we construct a new real number ζ between 0 and 1 as follows:

Let the b th digit b_n in the decimal expansion of b be $a_{nn} - 1$ if $a_{nn} \neq 0$ and 1 if $a_{nn} = 0$. Then $b = .b_1b_2b_3b_4 \dots$ is the decimal expansion of b , which is a real number by

definition but differs from the n th number r_n of the enumeration in the n th decimal place for any integer $n \geq 1$. Whence, b is not in the sequence $r_1, r_2, \dots, r_n, \dots$. This contradicts our assumption. \square

1.1.3 Subset Enumeration. Let \mathfrak{S} be a countable set, i.e.,

$$\mathfrak{S} = \{s_1, s_2, \dots, s_n, \dots\}.$$

We adopt the following convention for subsets.

Convention 1.1.1 For a subset $S = \{s_{i_1}, s_{i_2}, \dots, s_{i_l}\}$ of \mathfrak{S} , $l \geq 1$, assign it to a monomial $s_{i_1} s_{i_2} \cdots s_{i_l}$.

Applying this convention, we can find the generator of subsets of a set \mathfrak{S} .

Theorem 1.1.5 Under Convention 1.1.1, the generator of elements in the power set $\mathcal{P}(\mathfrak{S})$ is

$$G(\mathcal{P}(\mathfrak{S})) = \sum_{\epsilon_s=0 \text{ or } 1} \prod_{s \in \mathfrak{S}} s^{\epsilon_s}.$$

Proof Let $T = \{s_{i_1}, s_{i_2}, \dots, s_l\}$, $l \geq 1$ be an element in $\mathcal{P}(\mathfrak{S})$. Then it is the term $s_{i_1} s_{i_2} \cdots s_l$ in $G(\mathcal{P}(\mathfrak{S}))$. Conversely, let $s_{i_1} s_{i_2} \cdots s_k$, $k \geq 1$ be a term in $G(\mathcal{P}(\mathfrak{S}))$. Then it is the subset $\{s_{i_1}, s_{i_2}, \dots, s_k\}$ by Convention 1.1.1. \square

For a finite set \mathfrak{S} , we can get a closed formula for counting its subsets following.

Theorem 1.1.6 Let \mathfrak{S} be a finite set. Then the number of its subsets is

$$|\mathcal{P}(\mathfrak{S})| = 2^{|\mathfrak{S}|}.$$

Proof Notice that for any integer i , $1 \leq i \leq |\mathfrak{S}|$, there are $\binom{|\mathfrak{S}|}{i}$ subsets of cardinality i in \mathfrak{S} . Therefore, we find that

$$|\mathcal{P}(\mathfrak{S})| = \sum_{i=1}^{|\mathfrak{S}|} \binom{|\mathfrak{S}|}{i} = 2^{|\mathfrak{S}|}. \quad \square$$

§1.2 GROUPS

1.2.1 Algebra System. Let \mathcal{A} be a nonempty set. A *binary operation on \mathcal{A}* is a bijection $o : \mathcal{A} \times \mathcal{A} \rightarrow \mathcal{A}$. Thus o associates each ordered pair (a, b) of elements of \mathcal{A} with an element $o(a, b)$ that of \mathcal{A} . For simplicity, we write $a \circ b$ for $o(a, b)$ and refer to \circ as a binary operation on \mathcal{A} . A set \mathcal{A} associated with a binary operation \circ is called to be an *algebraic system*, denoted by $(\mathcal{A}; \circ)$.

If \mathcal{A} is finite, let $\mathcal{A} = \{x_1, x_2, \dots, x_n\}$, we can present an algebraic system $(\mathcal{A}; \circ)$ easily by operation table following.

\circ	x_1	x_2	\dots	x_n
x_1	$x_1 \circ x_1$	$x_1 \circ x_2$	\dots	$x_1 \circ x_n$
x_2	$x_2 \circ x_1$	$x_2 \circ x_2$	\dots	$x_2 \circ x_n$
\dots	\dots	\dots	\dots	\dots
x_n	$x_n \circ x_1$	$x_n \circ x_2$	\dots	$x_n \circ x_n$

Table 1.2.1

For example, let $K = \{1, \alpha, \beta, \gamma\}$ with an operation \circ determined by the following table.

\circ	1	α	β	γ
1	1	α	β	γ
α	α	1	γ	β
β	β	γ	1	α
γ	γ	β	α	1

Table 1.2.2

Then we easily get that

$$\begin{aligned}
 1 \circ 1 &= \alpha \circ \alpha = \beta \circ \beta = \gamma \circ \gamma = 1, \\
 1 \circ \alpha &= \alpha \circ 1 = \alpha, 1 \circ \beta = \beta \circ 1 = \beta, 1 \circ \gamma = \gamma \circ 1 = \gamma, \\
 \alpha \circ \beta &= \beta \circ \alpha = \gamma, \alpha \circ \gamma = \gamma \circ \alpha = \beta, \beta \circ \gamma = \gamma \circ \beta = \alpha
 \end{aligned}$$

by Table 1.2.2. Notice that $x \circ (y \circ z) = (x \circ y) \circ z$ and $x \circ y = y \circ x$ for $\forall x, y, z \in K$ in Table 1.2.2. These properties enables us to introduce the associative and commutative laws for operation following.

Definition 1.2.1 An algebraic system $(\mathcal{A}; \circ)$ is associative if for $\forall a, b, c \in \mathcal{A}$,

$$(a \circ b) \circ c = a \circ (b \circ c).$$

An associative system $(\mathcal{A}; \circ)$ is usually called a semigroup. A system $(\mathcal{A}; \circ)$ is Abelian if for $\forall a, b \in \mathcal{A}$,

$$a \circ b = b \circ a.$$

There are many non-Abelian systems. For example, let $M_n(\mathbb{R})$ be all $n \times n$ matrixes with matrix multiplication \circ . We have known that the equality

$$A \circ B = B \circ A$$

does not always hold for $\forall A, B \in M_n(\mathbb{R})$ from linear algebra. Whence, $(M_n(\mathbb{R}), \circ)$ is a non-Abelian system. Notice that each element associated with the element $1_{n \times n}$ is unchanging in $M_n(\mathbb{R})$. Such an element is called to be a unit defined following, which also enables us to introduce the inverse element of an element in (\mathcal{A}, \circ) .

Definition 1.2.2 Let $(\mathcal{A}; \circ)$ be an algebraic system. An element $1^l \in \mathcal{A}$ (or $1^r \in \mathcal{A}$, or $1 \in \mathcal{A}$) is called to be a left unit (or right unit, or unit) if for $\forall a \in \mathcal{A}$

$$1^l \circ a = a \quad (\text{or } a \circ 1^r = a, \text{ or } 1 \circ a = a \circ 1 = a).$$

Definition 1.2.3 Let $(\mathcal{A}; \circ)$ be an algebraic system with a unit $1_{\mathcal{A}}$. An element $b \in \mathcal{A}$ is called to be a right inverse of $a \in \mathcal{A}$ if $a \circ b = 1_{\mathcal{A}}$.

Certainly, there are algebra systems without unit. For example, let $H = \{a, b, c, d\}$ with an operation \cdot determined by the following table.

\cdot	a	b	c	d
a	b	c	a	d
b	c	d	b	a
c	a	b	d	c
d	d	a	c	b

Table 1.2.3

Then (H, \cdot) is an algebraic system without unit.

1.2.2 Group. A group is an algebraic associative system with unit and inverse elements, formally defined in the following.

Definition 1.2.4 An algebraic system $(\mathcal{G}; \circ)$ is a group if conditions (1)-(3) following hold:

- (1) $(x \circ y) \circ z = x \circ (y \circ z), \forall x, y, z \in \mathcal{G};$
- (2) $\exists 1_{\mathcal{G}} \in \mathcal{G}$ such that $1_{\mathcal{G}} \circ x = x \circ 1_{\mathcal{G}} = x, x \in \mathcal{G};$
- (3) $\forall x \in \mathcal{G}, \exists y \in \mathcal{G}$ such that $x \circ y = y \circ x = 1_{\mathcal{G}}.$

A group $(\mathcal{G}; \circ)$ is *Abelian* if it is itself Abelian, i.e., an additional condition (4) following holds:

- (4) $\forall x, y \in G, x \circ y = y \circ x, \forall x, y \in \mathcal{G}.$

For example, the system $(K; \circ)$ determined by Table 1.2.2 is such an Abelian group, usually called *Klein 4-group*. More examples of groups are shown following.

Example 1.2.1(Groups of Numbers) Let $\mathbb{Z}, \mathbb{Q}, \mathbb{R}$ and \mathbb{C} denote respectively sets of all integers, rational numbers, real numbers and complex numbers and $+, \cdot$ the ordinary addition, multiplication. Then we know

- (1) $(\mathbb{Z}; +), (\mathbb{Q}; +), (\mathbb{R}; +)$ and $(\mathbb{C}; +)$ are four Abelian infinite groups with identity 0 and inverse $-x$ for $\forall x \in \mathbb{Z}, \mathbb{Q}, \mathbb{R}$ or $\mathbb{C};$
- (2) $(\mathbb{Z} \setminus \{0\}; \cdot), (\mathbb{Q} \setminus \{0\}; \cdot), (\mathbb{R} \setminus \{0\}; \cdot)$ and $(\mathbb{C} \setminus \{0\}; \cdot)$ are four Abelian infinite groups with identity 1 and inverse $1/x$ for $\forall x \in \mathbb{Z}, \mathbb{Q}, \mathbb{R}$ or $\mathbb{C}.$
- (3) Let n be an integer. Define an equivalent relation \sim on \mathbb{Z} following:

$$a \sim b \Leftrightarrow a \equiv b \pmod{n}.$$

Denoted by \bar{i} the equivalent class including i . We get n equivalent classes $\bar{0}, \bar{1}, \dots, \overline{n-1}$. Let $\mathbb{Z}_n = \{\bar{0}, \bar{1}, \dots, \overline{n-1}\}$. Then $(\mathbb{Z}_n; +)$ is an Abelian n -group with identity $\bar{0}$, inverse $\overline{-x}$ for $\bar{x} \in \mathbb{Z}_n$ and $(\mathbb{Z}_n \setminus \{\bar{0}\}; \cdot)$ an Abelian $(n-1)$ -group with identity $\bar{1}$, inverse $\overline{1/x}$ for $\bar{x} \in \mathbb{Z}_n \setminus \{\bar{0}\}$, where $\overline{1/x}$ denotes the equivalent class including such $1/x$ with $x \cdot (1/x) \equiv 1 \pmod{n}.$

Example 1.2.2(Groups of Matrixes) Let $GL(n, \mathbb{R})$ be the set of all invertible $n \times n$ matrixes with coefficients in \mathbb{R} and $+, \cdot$ the ordinary matrix addition and multiplication. Then

- (1) $(GL(n, \mathbb{R}); +)$ is an Abelian infinite group with identity $0_{n \times n}$, the $n \times n$ zero matrix

and inverse $-A$ for $A \in GL(n, \mathbb{R})$, where $-A$ is the matrix replacing each entry a by $-a$ in matrix A .

(2) $(GL(n, \mathbb{R}); \cdot)$ is a non-Abelian infinite group if $n \geq 2$ with identity $1_{n \times n}$, the $n \times n$ unit matrix and inverse A^{-1} for $A \in GL(n, \mathbb{R})$, where $A \cdot A^{-1} = 1_{n \times n}$. For its non-Abelian, let $n = 2$ for simplicity and

$$A = \begin{bmatrix} 1 & 2 \\ 2 & 1 \end{bmatrix}, \quad B = \begin{bmatrix} 2 & -3 \\ 3 & 1 \end{bmatrix}.$$

Calculations show that

$$\begin{bmatrix} 1 & 2 \\ 2 & 1 \end{bmatrix} \cdot \begin{bmatrix} 2 & -3 \\ 3 & 1 \end{bmatrix} = \begin{bmatrix} 8 & -1 \\ 7 & -5 \end{bmatrix}, \quad \begin{bmatrix} 2 & -3 \\ 3 & 1 \end{bmatrix} \cdot \begin{bmatrix} 1 & 2 \\ 2 & 1 \end{bmatrix} = \begin{bmatrix} -4 & 1 \\ 5 & 7 \end{bmatrix}.$$

Whence, $A \cdot B \neq B \cdot A$.

Example 1.2.3(Groups of Linear Transformation) Let V be an n -dimensional vector space over \mathbb{R} and $GL(V, \mathbb{R})$ the set of all bijection linear transformation of V . We have known that each bijection linear transformation of V is associated with a non-singular $n \times n$ matrix and the composition \circ of two such transformations is correspondent with that of matrixes if a fixed basis of V is chosen. Therefore, $(GL(V, \mathbb{R}); \circ)$ is a group by Example 1.2.2.

Example 1.2.4(Isometries of E^2) Let E^2 be a Euclidean plane. There are three basic isometries in E^2 , i.e., *rotations* about a point, *reflections* in a line and *translations* moving a point (x, y) to $(x_a, y + b)$ for some fixed $a, b \in \mathbb{R}$. We have know that any isometry is a rotation, a reflection, a translation, or their product.

If X is a bounded subset of E^2 , for example, the regular polygon shown in Fig.1.2.1 in the next page, then it is clear that an isometry leaving X invariant must be a rotation or a reflection, can not be a translation. In this case, the rotations that leave X invariant are about the center of X through angles $2\pi i/n$ for $i = 0, 1, 2, \dots, n - 1$. The reflections which preserve X are lines joining opposite vertices if $n \equiv 0(\text{mod}2)$ (see Fig.1.2.1) or lines through a vertex and the midpoint of the opposite edge if $n \equiv 1(\text{mod}2)$.

Let ρ be a rotation about the center of X through angles $2\pi/n$ from the vertex 1 in counterclockwise and τ a reflection joining the vertex 1 with its opposite vertex if $n \equiv 0(\text{mod}2)$ or midpoint of its opposite edge if $n \equiv 1(\text{mod}2)$.

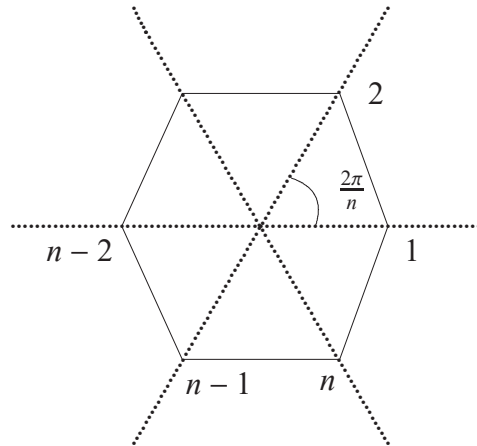

Fig.1.2.1

Then we know that

$$\rho^n = 1_X, \quad \tau^2 = 1_X, \quad \tau^{-1}\rho\tau = \rho^{-1}.$$

We thereafter get the isometry group D_n of regular n -polygon to be

$$D_n = \{\rho^i \tau^j | 0 \leq i \leq n-1, 0 \leq j \leq 1\}.$$

This group is usually called the *dihedral group* of order $2n$.

Definition 1.2.5 Let $(\mathcal{G}; \circ)$, $(\mathcal{H}; \cdot)$ be groups. A bijection $\phi : \mathcal{G} \rightarrow \mathcal{H}$ is an isomorphism if

$$\phi(a \circ b) = \phi(a) \cdot \phi(b)$$

for $\forall a, b \in \mathcal{G}$. If such an isomorphism ϕ exists, the group $(\mathcal{G}; \circ)$ is called to be isomorphic to $(\mathcal{H}; \cdot)$, denoted by $(\mathcal{G}; \circ) \simeq (\mathcal{H}; \cdot)$.

Example 1.2.5 Each group pair in the following is isomorphic.

- (1) $(\langle x \rangle; \cdot)$, $x^n = 1$ with $(\mathbb{Z}_n; +)$;
- (2) Klein 4-group in Table 2.2 with $\mathbb{Z}_2 \times \mathbb{Z}_2$;
- (3) $GL(V, \mathbb{R})$, $\dim V = n$ with $(GL(n, \mathbb{R}); \cdot)$.

1.2.3 Group Property. Elementary properties of groups are listed following.

P1. There is only one unit $1_{\mathcal{G}}$ in a group $(\mathcal{G}; \circ)$.

In fact, if there are two units $1_{\mathcal{G}}$ and $1'_{\mathcal{G}}$ in $(\mathcal{G}; \circ)$, then we get $1_{\mathcal{G}} = 1_{\mathcal{G}} \circ 1'_{\mathcal{G}} = 1'_{\mathcal{G}}$, a contradiction.

P2. *There is only one inverse a^{-1} for $a \in \mathcal{G}$ in a group $(\mathcal{G}; \circ)$.*

If a_1^{-1}, a_2^{-1} both are the inverses of $a \in \mathcal{G}$, then we get that $a_1^{-1} = a_1^{-1} \circ a \circ a_2^{-1} = a_2^{-1}$, a contradiction.

P3. $(a^{-1})^{-1} = a, a \in \mathcal{G}$.

This is by the definition of inverse, i.e., $a \circ a^{-1} = a^{-1} \circ a = 1_{\mathcal{G}}$.

P4. *If $a \circ b = a \circ c$ or $b \circ a = c \circ a$, where $a, b, c \in \mathcal{G}$, then $b = c$.*

If $a \circ b = a \circ c$, then $a^{-1} \circ (a \circ b) = a^{-1} \circ (a \circ c)$. According to the associative law, we get that $b = 1_{\mathcal{G}} \circ b = (a^{-1} \circ a) \circ b = a^{-1} \circ (a \circ c) = (a^{-1} \circ a) \circ c = 1_{\mathcal{G}} \circ c = c$. Similarly, if $b \circ a = c \circ a$, we can also get $b = c$.

P5. *There is a unique solution for equations $a \circ x = b$ and $y \circ a = b$ in a group $(\mathcal{G}; \circ)$ for $a, b \in \mathcal{G}$.*

In fact, $x = a^{-1} \circ b$ and $y = b \circ a^{-1}$ are such solutions.

Denote by $a^n = \underbrace{a \circ a \circ \cdots \circ a}_n$. Then the following property is obvious.

P6. *For any integers n, m and $a, b \in \mathcal{G}$, $a^n \circ a^m = a^{n+m}$, $(a^n)^m = a^{nm}$. Particularly, if $(\mathcal{G}; \circ)$ is Abelian, then $(a \circ b)^n = a^n \circ b^n$.*

Definition 1.2.6 *Let $(\mathcal{G}; \circ)$ be a group, $a \in \mathcal{G}$. If there exists a least integer $k \geq 0$ with $a^k = 1_{\mathcal{G}}$, such k is called the order of a and denoted by $o(a) = k$. If there are no positive power of a equal to $1_{\mathcal{G}}$, a has order infinity.*

Theorem 1.2.1 *Let $(\mathcal{G}; \circ)$ be a group, $x \in \mathcal{G}$ and $o(x) = k$. Then*

- (1) $x^l = 1_{\mathcal{G}}$ if and only if $k|l$;
- (2) if $o(x) < +\infty$, $x^l = x^m$ if and only if $k|l - m$, and if $o(x) = +\infty$, then $x^l = x^m$ if and only if $l = m$.

Proof If $k|l$, let $l = kd$ for an integer d . Then

$$x^l = x^{kd} = (x^k)^d = 1_{\mathcal{G}}^d = 1_{\mathcal{G}}.$$

Conversely, if k is not a divisor of l , let $l = kd + r$ for integers d and r , $0 < r < k - 1$. Then we know that

$$x^l = x^{kd+r} = x^{kd} \circ x^r = 1_{\mathcal{G}} \circ x^r \neq 1_{\mathcal{G}}$$

by the definition of order. So we get (1).

Notice that $x^l = x^m$ if and only if $x^{l-m} = 1_{\mathcal{G}}$, i.e., $l - m | k$ by (1). Furthermore, if $o(x) = +\infty$, then $x^l = x^m$ only if $l = m$ by definition. We get conclusion (2). \square

1.2.4 Subgroup. Let \mathcal{H} be a subset of a group $(\mathcal{G}; \circ)$. If $(\mathcal{H}; \circ)$ is a group itself, then it is called a *subgroup* of $(\mathcal{G}; \circ)$, denoted by $\mathcal{H} \leq \mathcal{G}$. If $\mathcal{H} \leq \mathcal{G}$ but $\mathcal{H} \neq \mathcal{G}$, then \mathcal{H} is called a *proper subgroup* of \mathcal{G} , denoted by $\mathcal{H} < \mathcal{G}$. We know a criterion of subgroups following.

Theorem 1.2.2 *Let \mathcal{H} be a subset of a group $(\mathcal{G}; \circ)$. Then $(\mathcal{H}; \circ)$ is a subgroup of $(\mathcal{G}; \circ)$ if and only if $\mathcal{H} \neq \emptyset$ and $a \circ b^{-1} \in \mathcal{H}$ for $\forall a, b \in \mathcal{H}$.*

Proof By definition if $(\mathcal{H}; \circ)$ is a group itself, then $\mathcal{H} \neq \emptyset$, there is $b^{-1} \in \mathcal{H}$ and $a \circ b^{-1}$ is closed in \mathcal{H} , i.e., $a \circ b^{-1} \in \mathcal{H}$ for $\forall a, b \in \mathcal{H}$.

Now if $\mathcal{H} \neq \emptyset$ and $a \circ b^{-1} \in \mathcal{H}$ for $\forall a, b \in \mathcal{H}$, then,

(1) there exists an $h \in \mathcal{H}$ and $1_{\mathcal{G}} = h \circ h^{-1} \in \mathcal{H}$;

(2) if $x, y \in \mathcal{H}$, then $y^{-1} = 1_{\mathcal{G}} \circ y^{-1} \in \mathcal{H}$ and hence $x \circ (y^{-1})^{-1} = x \circ y \in \mathcal{H}$;

(3) the associative law $x \circ (y \circ z) = (x \circ y) \circ z$ for $x, y, z \in \mathcal{H}$ is hold in $(\mathcal{G}; \circ)$. By (2), it is also hold in \mathcal{H} . Thus $(\mathcal{H}; \circ)$ is a group. \square

Corollary 1.2.1 *Let $\mathcal{H}_1 \leq \mathcal{G}$ and $\mathcal{H}_2 \leq \mathcal{G}$. Then $\mathcal{H}_1 \cap \mathcal{H}_2 \leq \mathcal{G}$.*

Proof Obviously, $1_{\mathcal{G}} = 1_{\mathcal{H}_1} = 1_{\mathcal{H}_2} \in \mathcal{H}_1 \cap \mathcal{H}_2$. So $\mathcal{H}_1 \cap \mathcal{H}_2 \neq \emptyset$. Let $x, y \in \mathcal{H}_1 \cap \mathcal{H}_2$. Applying Theorem 1.2.2, we get that

$$x \circ y^{-1} \in \mathcal{H}_1, \quad x \circ y^{-1} \in \mathcal{H}_2.$$

Whence,

$$x \circ y^{-1} \in \mathcal{H}_1 \cap \mathcal{H}_2.$$

Thus, $(\mathcal{H}_1 \cap \mathcal{H}_2; \circ)$ is a subgroup of $(\mathcal{G}; \circ)$. \square

Let X be a subset of a group $(\mathcal{G}; \circ)$. Define the subgroup $\langle X \rangle$ generated by X to be the intersection of all subgroups of $(\mathcal{G}; \circ)$ which contains X . Notice that there will be one such subgroup, i.e., $(\mathcal{G}; \circ)$ at least. So $\langle X \rangle$ is a subgroup of $(\mathcal{G}; \circ)$ by Corollary 1.2.1. A subgroup generated by one element $x \in \mathcal{G}; \circ)$ is usually called a *cyclic group*, denoted by $\langle x \rangle$. The next result determines the form of each element in the subgroup $\langle X \rangle$.

Theorem 1.2.3 *Let X be a nonempty subset of a group $(\mathcal{G}; \circ)$. Then $\langle X \rangle$ is the set of all elements of the form $x_1^{\epsilon_1} x_2^{\epsilon_2} \cdots x_s^{\epsilon_s}$, where $x_i \in X$, $\epsilon_i = \pm 1$ and $s \geq 0$ (if $s = 0$, this product is interpreted to be $1_{\mathcal{G}}$).*

Proof Let S denote the set of all such elements. Applying Theorem 1.2.2, we know that $(S; \circ)$ is a subgroup of $(\mathcal{G}; \circ)$. It is clear that $X \subset S$. Whence, $\langle X \rangle \subset S$. But by definition, it is obvious that $S \subset \langle X \rangle$. So we get that $S = \langle X \rangle$. \square

For a finite subgroup \mathcal{H} of $(\mathcal{G}; \circ)$, the criterion of Theorem 1.2.2 can be simplified to the following.

Theorem 1.2.4 *Let \mathcal{H} be a finite subset of a group $(\mathcal{G}; \circ)$. Then $(\mathcal{H}; \circ)$ is a subgroup of $(\mathcal{G}; \circ)$ if and only if $\mathcal{H} \neq \emptyset$ and $a \circ b \in \mathcal{H}$ for $\forall a, b \in \mathcal{H}$.*

Proof The necessity is clear. We prove the sufficiency. By Theorem 1.2.2, we only need to check $b^{-1} \in \mathcal{H}$ in this case. In fact, let $b \in \mathcal{H}$. Then we get $b^m \in \mathcal{H}$ for any integer $m \in \mathbb{Z}^+$ by assumption. But \mathcal{H} is finite. Whence, there are integers $k, l, k \neq l$ such that $b^k = b^l$. Not loss of generality, we assume $k > l$. Then $b^{k-l-1} = b^{-1} \in \mathcal{H}$. Whence, $(\mathcal{H}; \circ)$ is a subgroup of $(\mathcal{G}; \circ)$. \square

Definition 1.2.7 *Let (\mathcal{G}, \circ) be a group, $\mathcal{H} \leq \mathcal{G}$ and $a \in \mathcal{G}$. Define*

$$a \circ \mathcal{H} = \{a \circ h \mid h \in \mathcal{H}\}$$

and

$$\mathcal{H} \circ a = \{h \circ a \mid h \in \mathcal{H}\},$$

called the left or right coset of \mathcal{H} , respectively.

Because the behavior of left coset is the same of that the right. We only discuss the left coset following.

Theorem 1.2.5 *Let $\mathcal{H} \leq \mathcal{G}$ with an operation \circ and $a, b \in \mathcal{G}$. Then*

- (1) for $\forall b \in a \circ \mathcal{H}$, $a \circ \mathcal{H} = b \circ \mathcal{H}$;
- (2) $a \circ \mathcal{H} = b \circ \mathcal{H}$ if and only if $b^{-1} \circ a \in \mathcal{H}$;
- (3) $a \circ \mathcal{H} = b \circ \mathcal{H}$ or $a \circ \mathcal{H} \cap b \circ \mathcal{H} = \emptyset$.

Proof (1) If $b \in a \circ \mathcal{H}$, then there exists an element $h \in \mathcal{H}$ such that $b = a \circ h$. Therefore, $b \circ \mathcal{H} = (a \circ h) \circ \mathcal{H} = a \circ (h \circ \mathcal{H}) = a \circ \mathcal{H}$.

(2) If $a \circ \mathcal{H} = b \circ \mathcal{H}$, then there exist elements $h_1, h_2 \in \mathcal{H}$ such that $a \circ h_1 = b \circ h_2$. Whence, $b^{-1} \circ a = h_2 \circ h_1^{-1} \in \mathcal{H}$. Conversely, if $b^{-1} \circ a \in \mathcal{H}$, then there exists $h \in \mathcal{H}$ such that $b^{-1} \circ a = h$, i.e., $a \in b \circ \mathcal{H}$. Applying the conclusion (1), we get $a \circ \mathcal{H} = b \circ \mathcal{H}$.

(3) In fact, if $a \circ \mathcal{H} \cap b \circ \mathcal{H} \neq \emptyset$, let $c \in (a \circ \mathcal{H} \cap b \circ \mathcal{H})$. Then, $c \circ \mathcal{H} = a \circ \mathcal{H}$ and $c \circ \mathcal{H} = b \circ \mathcal{H}$ by the conclusion (1). Therefore, $a \circ \mathcal{H} = b \circ \mathcal{H}$. \square

Let us denote by \mathcal{G}/\mathcal{H} all these left (or right) cosets and $\mathcal{G} : \mathcal{H}$ the resulting sets by selecting an element from each left coset of \mathcal{H} , called the *left coset representation*. By Theorem 1.2.5, we get that

$$\mathcal{G} = \bigcup_{t \in \mathcal{G} : \mathcal{H}} t \circ \mathcal{H}$$

and $\forall g \in \mathcal{G}$ can be uniquely written in the form $t \circ h$ for $t \in \mathcal{G} : \mathcal{H}$, $h \in \mathcal{H}$. Usually, $|\mathcal{G} : \mathcal{H}|$ is called the *index* of \mathcal{H} in \mathcal{G} . For such indexes, we have a theorem following.

Theorem 1.2.6 (Lagrange) *Let $\mathcal{H} \leq \mathcal{G}$. Then $|\mathcal{G}| = |\mathcal{H}| |\mathcal{G} : \mathcal{H}|$.*

Proof Let

$$\mathcal{G} = \bigcup_{t \in \mathcal{G} : \mathcal{H}} t \circ \mathcal{H}.$$

Notice that $t_1 \circ \mathcal{H} \cap t_2 \circ \mathcal{H} = \emptyset$ if $t_1 \neq t_2$ and $|t \circ \mathcal{H}| = |\mathcal{H}|$. We get that

$$|\mathcal{G}| = \sum_{t \in \mathcal{G} : \mathcal{H}} |t \circ \mathcal{H}| = |\mathcal{H}| |\mathcal{G} : \mathcal{H}|. \quad \square$$

Generally, we know the following theorem for indexes of subgroups. In fact, Theorem 1.2.6 is just its a special case of $\mathcal{H} = \{1_{\mathcal{H}}\}$, the *trivial group*.

Theorem 1.2.7 *Let $\mathcal{K} \leq \mathcal{H} \leq \mathcal{G}$ with an operation \circ . Then $(\mathcal{G} : \mathcal{H})(\mathcal{H} : \mathcal{K})$ is a left coset representation of \mathcal{K} in \mathcal{G} . Thus*

$$|\mathcal{G} : \mathcal{K}| = |\mathcal{G} : \mathcal{H}| |\mathcal{H} : \mathcal{K}|.$$

Proof Let $\mathcal{G} = \bigcup_{t \in \mathcal{G} : \mathcal{H}} t \circ \mathcal{H}$ and $\mathcal{H} = \bigcup_{u \in \mathcal{H} : \mathcal{K}} u \circ \mathcal{K}$. Whence,

$$\mathcal{G} = \bigcup_{t \in \mathcal{G} : \mathcal{H}, u \in \mathcal{H} : \mathcal{K}} t \circ u \circ \mathcal{K}.$$

We show that all these cosets $t \circ u \circ \mathcal{K}$ are distinct. In fact, if $t \circ u \circ \mathcal{K} = t' \circ u' \circ \mathcal{K}$ for some $t, t' \in \mathcal{G} : \mathcal{H}$, $u, u' \in \mathcal{H} : \mathcal{K}$, then $t^{-1} \circ t' \in \mathcal{H}$ and $t \circ \mathcal{H} = t' \circ \mathcal{H}$ by Theorem 1.2.5. By the uniqueness of left coset representations in $\mathcal{G} : \mathcal{H}$, we find that $t = t'$. Consequently, $u \circ \mathcal{K} = u' \circ \mathcal{K}$. Applying the uniqueness of left coset representations in $\mathcal{H} : \mathcal{K}$, we get that $u = u'$. \square

Let $\mathcal{H} \leq \mathcal{G}$ and $\mathcal{K} \leq \mathcal{G}$ with an operation \circ . Define

$$\mathcal{H}\mathcal{G} = \{h \circ g | h \in \mathcal{H}, g \in \mathcal{G}\}.$$

The subgroups \mathcal{H} and \mathcal{K} are said to be *permute* if $\mathcal{H}\mathcal{G} = \mathcal{G}\mathcal{H}$. Particularly, if for $\forall g \in \mathcal{G}$, $g \circ \mathcal{H} = \mathcal{H} \circ g$, such subgroups \mathcal{H} are very important, called the *normal subgroups* of $(\mathcal{G}; \circ)$, denoted by $\mathcal{H} \triangleleft \mathcal{G}$.

Theorem 1.2.8 *Let $(\mathcal{G}; \circ)$ be a group and $\mathcal{H} \leq \mathcal{G}$. Then the following three statements are equivalent.*

- (1) $x \circ \mathcal{H} = \mathcal{H} \circ x$ for $\forall x \in \mathcal{G}$;
- (2) $x^{-1} \circ \mathcal{H} \circ x = \mathcal{H}$ for $\forall x \in \mathcal{G}$;
- (3) $x^{-1} \circ h \circ x \in \mathcal{H}$ for $\forall x \in \mathcal{G}$ and $h \in \mathcal{H}$.

Proof For (1) \Rightarrow (2), multiply both sides of (1) by x^{-1} , we get (2). The (2) \Rightarrow (3) is clear by definition. Now for (3) \Rightarrow (1), let $h \in \mathcal{H}$ and $x \in \mathcal{G}$. Then we find that $h \circ x = x \circ (x^{-1} \circ h \circ x) \in x \circ \mathcal{H}$ and $x \circ h = (x^{-1})^{-1} \circ h \circ x \in \mathcal{H} \circ x$. Therefore, $x \circ \mathcal{H} = \mathcal{H} \circ x$. \square

Obviously, $\{1_{\mathcal{G}}\} \triangleleft \mathcal{G}$ and $\mathcal{G} \triangleleft \mathcal{G}$. A group $(\mathcal{G}; \circ)$ is called *simple* if there are no normal subgroups different from $(\{1_{\mathcal{G}}\}; \circ)$ and $(\mathcal{G}; \circ)$ in $(\mathcal{G}; \circ)$.

Although it is an arduous work for determining all subgroups, or normal subgroups of a given group. But there is little difficulty in the case of cyclic groups.

Theorem 1.2.9 *Let $\mathcal{G} = \langle x \rangle$ and $\mathcal{H} \leq \mathcal{G}$ with an operation \circ . Then*

- (1) if \mathcal{G} is infinite, \mathcal{H} is either infinite cyclic or trivial;
- (2) if \mathcal{G} is finite, \mathcal{H} is cyclic of order dividing n . Conversely, to each positive divisor d of n , there is exactly one subgroup of order d , i.e., $\langle x^{n/d} \rangle$.

Proof (1) If \mathcal{H} is trivial, the conclusion is obvious. So let $\mathcal{H} \neq \{1_{\mathcal{H}}\}$. Then there is a minimal positive number k such that \mathcal{H} contains some positive power $x^k \neq 1_{\mathcal{H}}$. Obviously, $\langle x^k \rangle \subset \mathcal{H}$. If $x^t \in \mathcal{H}$, we write $t = kq + r$, where $0 \leq r \leq k - 1$. Then we find that $x^r = (x^k)^{-q} \circ x^t \in \mathcal{H}$. Contradicts the minimality of k . Whence, $r = 0$ and $k|t$. Hence $x^t \in \langle x^k \rangle$ and $\mathcal{H} = \langle x^k \rangle$. If \mathcal{G} is infinite, then x has infinite order, as does x^k . Therefore, \mathcal{H} is also infinite.

(2) Let $o(x) = n$. Then $|\mathcal{H}|$ divides n by Theorem 1.2.6. Conversely, suppose $d|n$. Then $o(x^{n/d}) = d$ and $|\langle x^{n/d} \rangle| = d$. If there is another subgroup $\langle x^s \rangle$ of order d . Then $x^{sd} = 1_{\mathcal{H}}$ and $n|sd$. Consequently, we get n/d divides s . Whence, $\langle x^s \rangle \leq \langle x^{n/d} \rangle$. But they both have the same order d , so $\langle x^s \rangle = \langle x^{n/d} \rangle$. \square

Certainly, every subgroup of a cyclic group is normal. The following result com-

pletely determines simply cyclic groups.

Theorem 1.2.10 *A cyclic group $\langle x \rangle$ is simple if and only if $o(x)$ is prime.*

Proof The sufficiency is immediately by Theorems 1.2.6 and 1.2.9. Moreover, $\langle x \rangle$ should be finite. Otherwise, the subgroup $\langle x^2 \rangle$ would be its a normal subgroup, contradicts to the assumption. By Theorem 1.2.9, we know that $o(x)$ must be a prime number. \square

1.2.5 Symmetric Group. Let $\Omega = \{a_1, a_2, \dots, a_n\}$ be an n -set. A *permutation* on Ω is a bijection $\sigma : \Omega \rightarrow \Omega$. The cardinality $|\Omega|$ of Ω is called the *degree* of such a permutation σ . Denoted by a_i^σ the image of $\sigma(a_i)$ for $1 \leq i \leq n$. Then σ can be also represented by

$$\sigma = \begin{pmatrix} a_1 & a_2 & \cdots & a_n \\ a_1^\sigma & a_2^\sigma & \cdots & a_n^\sigma \end{pmatrix}.$$

Usually, we adopt $\Omega = \{1, 2, \dots, n\}$ for simplicity. In this case, we represent σ by

$$\sigma = \begin{pmatrix} 1 & 2 & \cdots & n \\ 1^\sigma & 2^\sigma & \cdots & n^\sigma \end{pmatrix}.$$

Let σ, τ be two permutations on Ω . The product $\sigma\tau$ is defined by

$$i^{\sigma\tau} = (i^\sigma)^\tau, \text{ for } i = 1, 2, \dots, n.$$

For example, let

$$\sigma = \begin{pmatrix} 1 & 2 & 3 & 4 \\ 2 & 4 & 1 & 3 \end{pmatrix}, \quad \tau = \begin{pmatrix} 1 & 2 & 3 & 4 \\ 2 & 1 & 4 & 3 \end{pmatrix}.$$

Then we get that

$$\sigma\tau = \begin{pmatrix} 1 & 2 & 3 & 4 \\ 2 & 4 & 1 & 3 \end{pmatrix} \begin{pmatrix} 1 & 2 & 3 & 4 \\ 2 & 1 & 4 & 3 \end{pmatrix} = \begin{pmatrix} 1 & 2 & 3 & 4 \\ 1 & 3 & 2 & 4 \end{pmatrix}.$$

Let σ be a permutation on Ω such that

$$a_1^\sigma = a_2, a_2^\sigma = a_3, \dots, a_{m-1}^\sigma = a_m, a_m^\sigma = a_1$$

and fixes each element $\Omega \setminus \{a_1, a_2, \dots, a_m\}$. We call such a permutation σ a *m-cycle*, denoted it by (a_1, a_2, \dots, a_m) and its elements by $[\sigma]$. If $m = 1$, σ is the identity; if $m = 2$, i.e., (a_1, a_2) , such a σ is called *involution*.

Theorem 1.2.11 *Any permutation σ can be written as a product of disjoint cycles, and these cycles are unique.*

Proof Let σ be a permutation on $\Omega = \{1, 2, \dots, n\}$. Choose an element $a \in \Omega$. Construct a sequence

$$a = a^{\sigma^0}, a^\sigma, a^{\sigma^2}, \dots, a^{\sigma^k}, \dots,$$

where $a^{\sigma^k} \in \Omega$ for any integer $k \geq 0$. Whence, there must be a least positive integer m such that $a^{\sigma^m} = a^{\sigma^i}$, $0 \leq i < m$. Now if $i \neq 0$, we get that $(a^{\sigma^{m-1}})^\sigma = (a^{\sigma^{i-1}})^\sigma$. But $a^{\sigma^{m-1}} \neq a^{\sigma^{i-1}}$ by assumption. Whence, $a^{\sigma^m} = (a^{\sigma^{m-1}})^\sigma \neq (a^{\sigma^{i-1}})^\sigma a^{\sigma^i}$, a contradiction. So $i = 0$, i.e., $a^{\sigma^m} = a$, or in other words, $\tau_1 = (a, a^\sigma, a^{\sigma^2}, \dots, a^{\sigma^{m-1}})$ is an m -cycle.

If $\Omega \setminus [\tau_1] = \emptyset$, then $m = n$ and σ is an n -cycle. Otherwise, we can choose $b \in \Omega \setminus [\tau_1]$ and get a s -cycle $\tau_2 = (b, b^\sigma, \dots, b^{\sigma^{s-1}})$.

Similarly, if choose $\Omega \setminus ([\tau_1] \cup [\tau_2]) \neq \emptyset$, choose c in it and find a l -cycle $\tau_3 = (c, c^\sigma, \dots, c^{\sigma^{l-1}})$.

Continue this process. Because of the finiteness of Ω , we finally get an integer t and cycles $\tau_1, \tau_2, \dots, \tau_t$ such that $\Omega \setminus ([\tau_1] \cup [\tau_2] \cup \dots \cup [\tau_t]) = \emptyset$ and $\sigma = \tau_1 \tau_2 \dots \tau_t$ with disjoint cycles τ_i , $1 \leq i \leq t$. The uniqueness of τ_i , $1 \leq i \leq t$ is clear by their construction.

□

Notice that

$$(a_1, a_2, \dots, a_m) = (a_1, a_2)(a_1, a_2) \dots (a_1, a_m).$$

We can always represent a permutation by product of involutions by Theorem 1.2.11. For example,

$$\begin{aligned} \sigma &= \begin{pmatrix} 1 & 2 & 3 & 4 & 5 \\ 2 & 3 & 1 & 5 & 4 \end{pmatrix} = (1, 2, 3)(4, 5) \\ &= (1, 2)(1, 3)(4, 5) = (2, 3)(1, 2)(4, 5) \\ &= (2, 3)(1, 2)(1, 3)(4, 5)(1, 3). \end{aligned}$$

Definition 1.2.8 *A permutation is odd (even) if it can be presented by a product of odd (even) involutions.*

Theorem 1.2.12 *The property of odd or even of a permutation σ is uniquely determined by σ itself.*

Proof Let P be a homogeneous polynomial with form

$$P = \prod_{1 \leq i < j \leq n} (x_i - x_j).$$

Clearly, any permutation leaves P unchanged as to its sign. For example, the involution $(x_1 x_2)$ changes $(x_1 - x_2)$ into its negative $(x_2 - x_1)$, interchanges $(x_1 - x_j)$ with $(x_2 - x_j)$, $j > 2$ and leaves the other factor unchanged. Whence, it changes P to $-P$. This fact means that an odd (even) permutation σ always changes P to $-P$ (P), only dependent on σ itself. \square

The next result is clear by definition.

Theorem 1.2.13 *All permutations and all even permutations on Ω form groups, called the symmetric group S_Ω or alternating group A_Ω , respectively.*

Let τ, σ be permutations on Ω and $\sigma = (a_1, a_2, \dots, a_m)$. A calculation shows that

$$\tau\sigma\tau^{-1} = (a_1^\tau, a_2^\tau, \dots, a_m^\tau).$$

Generally, if

$$\sigma = \sigma_1\sigma_2 \cdots \sigma_s$$

is written a product of disjoint cycles for an integer $s \geq 1$, Then

$$\tau\sigma\tau^{-1} = \sigma'_1\sigma'_2 \cdots \sigma'_s,$$

where the σ'_i is obtained from σ_i replacing each entry a in σ_i by $\tau(a)$.

1.2.6 Regular Representation. Let $(\mathcal{G}; \circ)$ be a group with

$$\mathcal{G} = \{a_1 = 1_{\mathcal{G}}, a_2, \dots, a_n\}.$$

For $\forall a_i \in \mathcal{G}$, we know these elements

$$a_1 \circ a_i, a_2 \circ a_i, \dots, a_n \circ a_i$$

or

$$a_i^{-1} \circ a_1, a_i^{-1} \circ a_2, \dots, a_i^{-1} \circ a_n$$

still in \mathcal{G} . Whence, they are both rearrangements of a_1, a_2, \dots, a_n . We get permutations

$$\sigma_{a_i} = \begin{pmatrix} a_1 & a_2 & \cdots & a_n \\ a_1 \circ a_i & a_2 \circ a_i & \cdots & a_n \circ a_i \end{pmatrix} = \begin{pmatrix} a \\ a \circ a_i \end{pmatrix},$$

$$\tau_{a_i} = \begin{pmatrix} a_1 & a_2 & \cdots & a_n \\ a_i^{-1} \circ a_1 & a_i^{-1} \circ a_2 & \cdots & a_i^{-1} \circ a_n \end{pmatrix} = \begin{pmatrix} a \\ a_i^{-1} \circ a \end{pmatrix}.$$

In this way, we get two sets of n permutations

$$R_{\mathcal{G}} = \{\sigma_{a_1}, \sigma_{a_2}, \dots, \sigma_{a_n}\} \text{ and } L_{\mathcal{G}} = \{\tau_{a_1}, \tau_{a_2}, \dots, \tau_{a_n}\}.$$

Notice that each permutation ζ in $R_{\mathcal{G}}$ or $L_{\mathcal{G}}$ is fixed-free, i.e., $a^\zeta = a, a \in \Omega$ only if $\zeta = 1_{\mathcal{G}}$.

We say $R_{\mathcal{G}}, L_{\mathcal{G}}$ the *right or left regular representation* of \mathcal{G} , respectively. The cardinality $|\mathcal{G}| = n$ is called the *degree* of $R_{\mathcal{G}}$ or $L_{\mathcal{G}}$.

Example 1.2.6 Let $K = \{1, \alpha, \beta, \gamma\}$ be the Klein 4-group with an operation \circ determined by Table 1.2.2. Then we get elements $\sigma_1, \sigma_\alpha, \sigma_\beta, \sigma_\gamma$ in R_K as follows.

$$\begin{aligned} \sigma_1 &= (1)(\alpha)(\beta)(\gamma), \\ \sigma_\alpha &= \begin{pmatrix} 1 & \alpha & \beta & \gamma \\ \alpha & 1 & \gamma & \beta \end{pmatrix} = (1, \alpha)(\beta, \gamma), \\ \sigma_\beta &= \begin{pmatrix} 1 & \alpha & \beta & \gamma \\ \beta & \gamma & 1 & \alpha \end{pmatrix} = (1, \beta)(\alpha, \gamma), \\ \sigma_\gamma &= \begin{pmatrix} 1 & \alpha & \beta & \gamma \\ \gamma & \beta & \alpha & 1 \end{pmatrix} = (1, \gamma)(\alpha, \beta), \end{aligned}$$

That is,

$$R_K = \{(1)(\alpha)(\beta)(\gamma), (1, \alpha)(\beta, \gamma), (1, \beta)(\alpha, \gamma), (1, \gamma)(\alpha, \beta)\}.$$

Theorem 1.2.14 $R_{\mathcal{G}}$ and $L_{\mathcal{G}}$ both are subgroups of the symmetric group $S_{\mathcal{G}}$.

Proof Applying Theorem 1.2.4, we only need to prove that for two integers $i, j, 1 \leq i, j \leq n, \sigma_{a_i}\sigma_{a_j} \in R_{\mathcal{G}}$ and $\tau_{a_i}\tau_{a_j} \in L_{\mathcal{G}}$. In fact,

$$\begin{aligned} \sigma_{a_i}\sigma_{a_j} &= \begin{pmatrix} a \\ a \circ a_i \end{pmatrix} \begin{pmatrix} a \\ a \circ a_j \end{pmatrix} = \begin{pmatrix} a \\ a \circ a_i \circ a_j \end{pmatrix} = \sigma_{a_i \circ a_j} \in R_{\mathcal{G}}, \\ \tau_{a_i}\tau_{a_j} &= \begin{pmatrix} a \\ a_i^{-1} \circ a \end{pmatrix} \begin{pmatrix} a \\ a_j^{-1} \circ a \end{pmatrix} = \begin{pmatrix} a \\ a_j^{-1} \circ a_i^{-1} \circ a \end{pmatrix} \\ &= \begin{pmatrix} a \\ (a_i \circ a_j)^{-1} \circ a \end{pmatrix} = \tau_{a_i \circ a_j} \in L_{\mathcal{G}}. \end{aligned}$$

Therefore, $R_{\mathcal{G}}$ and $L_{\mathcal{G}}$ both are subgroups of $S_{\mathcal{G}}$. □

The importance of $R_{\mathcal{G}}$ and $L_{\mathcal{G}}$ are shown in the proof of next result.

Theorem 1.2.15(Cayley) *Any group \mathcal{G} is isomorphic to a subgroup of $S_{\mathcal{G}}$.*

Proof Let $(\mathcal{G}; \circ)$ be a group with $\mathcal{G} = \{a_1 = 1_{\mathcal{G}}, a_2, \dots, a_n\}$. Define mappings $f : \mathcal{G} \rightarrow R_{\mathcal{G}}$ and $h : \mathcal{G} \rightarrow L_{\mathcal{G}}$ by $f(a_i) = \sigma_{a_i}$, $h(a_i) = \tau_{a_i}$. Then f and h both are one-to-one because of $f(a_i) \neq f(a_j)$, $h(a_i) \neq h(a_j)$ if $a_i \neq a_j$. By the proof of Theorem 1.2.14, we know that

$$f(a_i \circ a_j) = \sigma_{a_i \circ a_j} = \sigma_{a_i} \sigma_{a_j} = f(a_i) f(a_j),$$

$$h(a_i \circ a_j) = \tau_{a_i \circ a_j} = \tau_{a_i} \tau_{a_j} = h(a_i) h(a_j)$$

for integers $1 \leq i, j \leq n$. So f and h are isomorphisms by definition. Consequently, \mathcal{G} is respective isomorphic to permutations $R_{\mathcal{G}}$ and $L_{\mathcal{G}}$. Both of them are subgroups of $S_{\mathcal{G}}$ by Theorem 1.2.14. □

§1.3 HOMOMORPHISM THEOREMS

1.3.1 Homomorphism. Let $(\mathcal{G}; \circ)$, $(\mathcal{G}'; \cdot)$ be groups. A mapping $\phi : \mathcal{G} \rightarrow \mathcal{G}'$ is a *homomorphism* if

$$\phi(a \circ b) = \phi(a) \cdot \phi(b)$$

for $\forall a, b \in \mathcal{G}$. A homomorphism ϕ is called to be a *monomorphism* or *epimorphism* if it is one-to-one or surjective. Particularly, if ϕ is a bijection, such a homomorphism ϕ is nothing but an *isomorphism* by definition.

Now let ϕ be a homomorphism. Define the *image* $\text{Im}\phi$ and *kernel* $\text{Ker}\phi$ respectively as follows:

$$\text{Im}\phi \equiv \mathcal{G}^{\phi} = \{ \phi(g) \mid g \in \mathcal{G} \},$$

$$\text{Ker}\phi = \{ g \mid \phi(g) = 1_{\mathcal{G}'} \},$$

For example, let $(\mathbb{Z}; +)$ and $(\mathbb{Z}_n; +)$ be groups defined in Example 1.2.1. Define $\phi : \mathbb{Z} \rightarrow \mathbb{Z}_n$ by $\phi(x) = x(\text{mod } n)$. Then ϕ is a surjection from $(\mathbb{Z}; +)$ to $(\mathbb{Z}_n; +)$.

Let $\phi : \mathcal{G} \rightarrow \mathcal{H}$ be a homomorphism. Some elementary properties of homomorphism are listed following.

H1. $\phi(x^n) = \phi^n(x)$ for all integers n , $x \in \mathcal{G}$, whence, $\phi(1_{\mathcal{G}}) = 1_{\mathcal{H}}$ and $\phi(x^{-1}) = \phi^{-1}(x)$.

By induction, this fact is easily proved for $n > 0$. If $n = 0$, by $\phi(x) = \phi(x \circ 1_{\mathcal{G}}) = \phi(x) \cdot \phi(1_{\mathcal{G}})$, we know that $\phi(1_{\mathcal{G}}) = 1_{\mathcal{H}}$. Now let $n < 0$. Then $1_{\mathcal{H}} = \phi(1_{\mathcal{G}}) = \phi(x^n \circ x^{-n}) = \phi(x^n) \cdot \phi(x^{-n})$, i.e., $\phi(x^n) = \phi^{-1}(x^{-n}) = (\phi^{-n}(x))^{-1} = \phi^n(x)$.

H2. $o(\phi(x)) | o(x)$, $x \in \mathcal{G}$.

In fact, Let $o(x) = k$. Then $x^k = 1_{\mathcal{G}}$. Applying the property H1, we get that

$$\phi^k(x) = \phi(x^k) = \phi(1_{\mathcal{G}}) = 1_{\mathcal{H}}.$$

By Theorem 1.2.1, we get that $o(\phi(x)) | o(x)$.

The following property is obvious by definition.

H3. If $x \circ y = y \circ x$, then $\phi(x) \cdot \phi(y) = \phi(y) \cdot \phi(x)$.

H4. $\text{Im}\phi \leq \mathcal{H}$ and $\text{Ker}\phi \triangleleft \mathcal{G}$.

This is an immediately conclusion of Theorems 1.2.2 and 1.2.8.

Theorem 1.3.1 A homomorphism $\phi : \mathcal{G} \rightarrow \mathcal{H}$ is an isomorphism if and only if $\text{Ker}\phi = \{1_{\mathcal{G}}\}$.

Proof The necessity is clear. We prove the sufficiency. Let $\text{Ker}\phi = \{1_{\mathcal{G}}\}$. We prove that ϕ is a bijection. If not, let $\phi(x) = \phi(y)$ for two different element $x, y \in \mathcal{G}$, then

$$\phi(x \circ y^{-1}) = \phi(x) \cdot \phi^{-1}(y) = 1_{\mathcal{H}}$$

by definition. Therefore, $x \circ y^{-1} \in \text{Ker}\phi$, i.e., $x \circ y^{-1} = 1_{\mathcal{G}}$. Whence, we get $x = y$, a contradiction. \square

1.3.2 Quotient Group. Let $(\mathcal{G}; \circ)$ be a group, $\mathcal{H}_1, \mathcal{H}_2, \mathcal{H}_3 \leq \mathcal{G}$. Define the multiplication and inverse of set by

$$\mathcal{H}_1 \mathcal{H}_2 = \{ x \circ y \mid x \in \mathcal{H}_1, y \in \mathcal{H}_2 \} \quad \text{and} \quad \mathcal{H}_1^{-1} = \{ x^{-1} \mid x \in \mathcal{H}_1 \}.$$

It is clear that $\mathcal{H}_1(\mathcal{H}_2 \mathcal{H}_3) = (\mathcal{H}_1 \mathcal{H}_2) \mathcal{H}_3$. By this definition, the criterion for a subset $\mathcal{H} \subset \mathcal{G}$ to be a subgroup of \mathcal{G} can be written by

$$\mathcal{H} \mathcal{H}^{-1} \subset \mathcal{H}.$$

Now we can consider this operation in \mathcal{G}/\mathcal{H} and determine when it is a group. Generally, for $\forall a, b \in \mathcal{G}$, we do not always get

$$(a \circ \mathcal{H})(b \circ \mathcal{H}) \in \mathcal{G}/\mathcal{H}$$

unless $\mathcal{H} \triangleleft \mathcal{G}$. In fact, we have the following result for \mathcal{G}/\mathcal{H} .

Theorem 1.3.2 \mathcal{G}/\mathcal{H} is a group if and only if \mathcal{H} is normal.

Proof If \mathcal{H} is a normal subgroup, then

$$(a \circ \mathcal{H})(b \circ \mathcal{H}) = a \circ (\mathcal{H} \circ b) \circ \mathcal{H} = a \circ (b \circ \mathcal{H}) \circ \mathcal{H} = (a \circ b) \circ \mathcal{H}$$

by the definition of normal subgroup. This equality enables us to check laws of a group following.

(1) Associative laws in \mathcal{G}/\mathcal{H} .

$$\begin{aligned} [(a \circ \mathcal{H})(b \circ \mathcal{H})](c \circ \mathcal{H}) &= [(a \circ b) \circ c] \circ \mathcal{H} = [a \circ (b \circ c)] \circ \mathcal{H} \\ &= (a \circ \mathcal{H})[(b \circ \mathcal{H})(c \circ \mathcal{H})]. \end{aligned}$$

(2) Existence of identity element $1_{\mathcal{G}/\mathcal{H}}$ in \mathcal{G}/\mathcal{H} .

In fact, $1_{\mathcal{G}/\mathcal{H}} = 1 \circ \mathcal{H} = \mathcal{H}$.

(3) Inverse element for $\forall x \circ \mathcal{H} \in \mathcal{G}/\mathcal{H}$.

Because of $(x^{-1} \circ \mathcal{H})(x \circ \mathcal{H}) = (x^{-1} \circ x) \circ \mathcal{H} = \mathcal{H} = 1_{\mathcal{G}/\mathcal{H}}$, we know the inverse element of $x \circ \mathcal{H} \in \mathcal{G}/\mathcal{H}$ is $x^{-1} \circ \mathcal{H}$.

Conversely, if \mathcal{G}/\mathcal{H} is a group, then for $a \circ \mathcal{H}, b \circ \mathcal{H} \in \mathcal{G}/\mathcal{H}$, we have

$$(a \circ \mathcal{H})(b \circ \mathcal{H}) = c \circ \mathcal{H}.$$

Obviously, $a \circ b \in (a \circ \mathcal{H})(b \circ \mathcal{H})$. Therefore,

$$(a \circ \mathcal{H})(b \circ \mathcal{H}) = (a \circ b) \circ \mathcal{H}.$$

Multiply both sides by a^{-1} , we get that

$$\mathcal{H} \circ b \circ \mathcal{H} = b \circ \mathcal{H}.$$

Notice that $1_{\mathcal{G}} \in \mathcal{H}$, we know that

$$b \circ \mathcal{H} \subset \mathcal{H} \circ b \circ \mathcal{H} = b \circ \mathcal{H},$$

i.e., $b \circ \mathcal{H} \circ b^{-1} \subset \mathcal{H}$. Consequently, we also find $b^{-1} \circ \mathcal{H} \circ b \subset \mathcal{H}$ if replace b by b^{-1} , i.e., $\mathcal{H} \subset b \circ \mathcal{H} \circ b^{-1}$. Whence,

$$b^{-1} \circ \mathcal{H} \circ b = \mathcal{H}$$

for $\forall b \in \mathcal{G}$. Namely, \mathcal{H} is a normal subgroup of \mathcal{G} . □

Definition 1.3.1 If \mathcal{G}/\mathcal{H} is a group under the set multiplication, we say it is a quotient group of \mathcal{G} by \mathcal{H} .

1.3.3 Isomorphism Theorem. If \mathcal{H} is a normal subgroup of \mathcal{G} , by Theorem 1.3.2 we know that \mathcal{G}/\mathcal{H} is a group. In this case, the mapping $\phi : \mathcal{G} \rightarrow \mathcal{G}/\mathcal{H}$ determined by $\phi(x) = x \circ \mathcal{H}$ is a homomorphism because

$$\phi(x \circ y) = (x \circ y) \circ \mathcal{H} = (x \circ \mathcal{H})(y \circ \mathcal{H}) = \phi(x)\phi(y)$$

for all $x, y \in \mathcal{G}$. It is clear that $\text{Im}\phi = \mathcal{G}/\mathcal{H}$ and $\text{Ker}\phi = \mathcal{H}$. Such a ϕ is called to be *natural homomorphism* of groups. Generally, we know the following result.

Theorem 1.3.3(First Isomorphism Theorem) If $\phi : \mathcal{G} \rightarrow \mathcal{H}$ is a homomorphism of groups, then the mapping $\zeta : x \circ \text{Ker}\phi \rightarrow \phi(x)$ is an isomorphism from $\mathcal{G}/\text{Ker}\phi$ to $\text{Im}\phi$.

Proof We have known that $\text{Ker}\phi \triangleleft \mathcal{G}$ by the property (H4) of homomorphism. So $\mathcal{G}/\text{Ker}\phi$ is a group by Theorem 1.3.2. Applying Theorem 1.3.1, we only need to check that $\text{Ker}\zeta = \{1_{\mathcal{G}/\text{Ker}\phi}\}$. In fact, $x \circ \text{Ker}\phi \in \text{Ker}\zeta$ if and only if $x \in \text{Ker}\phi$. Thus ζ is an isomorphism from $\mathcal{G}/\text{Ker}\phi$ to $\text{Im}\phi$. □

Particularly, if $\text{Im}\phi = \mathcal{H}$, we get a conclusion following, usually called the *fundamental homomorphism theorem*.

Corollary 1.3.1(Fundamental Homomorphism Theorem) If $\phi : \mathcal{G} \rightarrow \mathcal{H}$ is an epimorphism, then $\mathcal{G}/\text{Ker}\phi$ is isomorphic to \mathcal{H} .

Theorem 1.3.4(Second Isomorphism Theorem) Let $\mathcal{H} \leq \mathcal{G}$ and $\mathcal{N} \triangleleft \mathcal{G}$. Then $\mathcal{H} \cap \mathcal{N} \triangleleft \mathcal{G}$ and $x \circ (\mathcal{H} \cap \mathcal{N}) \rightarrow x \circ \mathcal{N}$ is an isomorphism from $\mathcal{H}/\mathcal{H} \cap \mathcal{N}$ to $\mathcal{H}\mathcal{N}/\mathcal{N}$.

Proof Clearly, the mapping $\tau : x \rightarrow x \circ \mathcal{N}$ is an epimorphism from \mathcal{H} to $\mathcal{N}\mathcal{H}/\mathcal{N}$ with $\text{Ker}\tau = \mathcal{H} \cap \mathcal{N}$. Applying Theorem 1.3.3, we know that it is an isomorphism from $\mathcal{H}/\mathcal{H} \cap \mathcal{N}$ to $\mathcal{H}\mathcal{N}/\mathcal{N}$. □

Theorem 1.3.5(Third Isomorphism Theorem) Let $\mathcal{M}, \mathcal{N} \triangleleft \mathcal{G}$ with $\mathcal{N} \leq \mathcal{M}$. Then $\mathcal{M}/\mathcal{N} \triangleleft \mathcal{G}/\mathcal{N}$ and $(\mathcal{G}/\mathcal{N})/(\mathcal{M}/\mathcal{N}) \simeq \mathcal{G}/\mathcal{M}$.

Proof Define a mapping $\varphi : \mathcal{G}/\mathcal{N} \rightarrow \mathcal{G}/\mathcal{M}$ by $\varphi(x \circ \mathcal{N}) = x \circ \mathcal{M}$. Then

$$\begin{aligned} \varphi[(x \circ \mathcal{N}) \circ (y \circ \mathcal{N})] &= \varphi[(x \circ y) \circ \mathcal{N}] = (x \circ y) \circ \mathcal{M} \\ &= (x \circ \mathcal{M}) \circ (y \circ \mathcal{M}) = \varphi(x \circ \mathcal{N}) \circ \varphi(y \circ \mathcal{N}) \end{aligned}$$

and $\text{Ker}\varphi = \mathcal{M}/\mathcal{N}$, $\text{Im}\varphi = \mathcal{G}/\mathcal{M}$. So φ is an epimorphism. Applying Theorem 1.3.3, we know that φ is an isomorphism from $(\mathcal{G}/\mathcal{N})/(\mathcal{M}/\mathcal{N})$ to \mathcal{G}/\mathcal{M} . \square

§1.4 ABELIAN GROUPS

1.4.1 Direct Product. An *Abelian group* is such a group $(\mathcal{G}; \circ)$ with the commutative law $a \circ b = b \circ a$ hold for $a, b \in \mathcal{G}$. The structure of such a group can be completely characterized by *direct product of subgroups* following.

Definition 1.4.1 Let $(\mathcal{G}; \circ)$ be a group. If there are subgroups $A, B \leq \mathcal{G}$ such that

- (1) for $\forall g \in \mathcal{G}$, there are uniquely $a \in A$ and $b \in B$ such that $g = a \circ b$;
- (2) $a \circ b = b \circ a$ for $a \in A$ and $b \in B$, then we say $(\mathcal{G}; \circ)$ is a *direct product of A and B* , denoted by $\mathcal{G} = A \otimes B$.

Theorem 1.4.1 If $\mathcal{G} = A \otimes B$, then

- (1) $A \triangleleft \mathcal{G}$ and $B \triangleleft \mathcal{G}$;
- (2) $\mathcal{G} = AB$;
- (3) $A \cap B = \{1_{\mathcal{G}}\}$.

Conversely, if there are subgroups A, B of \mathcal{G} with conditions (1)-(3) hold, then $\mathcal{G} = A \otimes B$.

Proof If $\mathcal{G} = A \otimes B$, by definition we immediately get that $\mathcal{G} = AB$. If there is $c \in A \cap B$ with $c \neq 1_{\mathcal{G}}$, we get

$$c = c \circ 1_{\mathcal{G}}, \quad c \in A, \quad 1_{\mathcal{G}} \in B$$

and

$$c = 1_{\mathcal{G}} \circ c, \quad 1_{\mathcal{G}} \in A, \quad c \in B,$$

contradicts the uniqueness of direct product. So $A \cap B = \{1_{\mathcal{G}}\}$.

Now we prove $A \triangleleft \mathcal{G}$. For $\forall a \in A, g \in \mathcal{G}$, by definition there are uniquely $g_1 \in A, g_2 \in B$ such that $g = g_1 \circ g_2$. Therefore,

$$\begin{aligned} g^{-1} \circ a \circ g &= (g_1 \circ g_2)^{-1} \circ a \circ (g_1 \circ g_2) = g_2^{-1} \circ g_1^{-1} \circ a \circ g_1 \circ g_2 \\ &= g_1^{-1} \circ a \circ g_1 \circ g_2^{-1} \circ g_2 = g_1^{-1} \circ a \circ g_1 \in A. \end{aligned}$$

So $A \triangleleft \mathcal{G}$. Similarly, we get $B \triangleleft \mathcal{G}$.

Conversely, if there are subgroups A, B of \mathcal{G} with conditions (1)-(3) hold, we prove $\mathcal{G} = A \otimes B$. For $\forall g \in \mathcal{G}$, by $\mathcal{G} = AB$ there are $a \in A$ and $b \in B$ such that $g = a \circ b$. If there are $a' \in A, b' \in B$ also with $g = a' \circ b'$, then

$$a'^{-1} \circ a = b' \circ b^{-1} \in A \cap B.$$

But $A \cap B = \{1_{\mathcal{G}}\}$. Whence, $a'^{-1} \circ a = b' \circ b^{-1} = 1_{\mathcal{G}}$, i.e., $a = a'$ and $b = b'$. So the equality $g = a \circ b$ is unique.

Now we prove $a \circ b = b \circ a$ for $a \in A$ and $b \in B$. Notice that $A \triangleleft \mathcal{G}$ and $B \triangleleft \mathcal{G}$, we know that

$$a \circ b \circ a^{-1} \circ b^{-1} = a \circ (b \circ a^{-1} \circ b^{-1}) \in A$$

and

$$a \circ b \circ a^{-1} \circ b^{-1} = (a \circ b \circ a^{-1}) \circ b^{-1} \in B.$$

But $A \cap B = \{1_{\mathcal{G}}\}$. So

$$a \circ b \circ a^{-1} \circ b^{-1} = 1_{\mathcal{G}}, \text{ i.e., } a \circ b = b \circ a.$$

By Definition 1.4.1, we know that $\mathcal{G} = A \otimes B$. □

Generally, we define the *semidirect product* of two groups as follows:

Definition 1.4.2 Let \mathcal{G} and \mathcal{H} be two subgroups of a group $(\mathcal{T}; \circ)$, $\alpha : \mathcal{H} \rightarrow \text{Aut}\mathcal{G}$ a homomorphism. Define the semidirect product $\mathcal{G} \rtimes_{\alpha} \mathcal{H}$ of \mathcal{G} and \mathcal{H} respect to α to be

$$\mathcal{G} \rtimes_{\alpha} \mathcal{H} = \{(g, h) | g \in \mathcal{G}, h \in \mathcal{H}\}$$

with operation \cdot determined by

$$(g_1, h_1) \cdot (g_2, h_2) = (g_1 \circ g_2^{\alpha(h_1)^{-1}}, h_1 \circ h_2).$$

Clearly, if α is the identity homomorphism, then the semidirect product $\mathcal{G} \rtimes_{\alpha} \mathcal{H}$ is nothing but the direct product $\mathcal{G} \otimes \mathcal{H}$.

Definition 1.4.3 Let $(\mathcal{G}; \circ)$ be a group. If there are subgroups $A_1, A_2, \dots, A_s \leq \mathcal{G}$ such that

(1) for $\forall g \in \mathcal{G}$, there are uniquely $a_i \in A_i$, $1 \leq i \leq s$ such that

$$g = a_1 \circ a_2 \circ \dots \circ a_s;$$

(2) $a_i \circ a_j = a_j \circ a_i$ for $a \in A_i$ and $b \in A_j$, where $1 \leq i, j \leq s$, $i \neq j$, then we say $(\mathcal{G}; \circ)$ is a direct product of A_1, A_2, \dots, A_s , denoted by

$$\mathcal{G} = A_1 \otimes A_2 \otimes \dots \otimes A_s.$$

Applying Theorem 1.4.1, by induction we can easily get the following result.

Theorem 1.4.2 If $A_1, A_2, \dots, A_s \leq \mathcal{G}$, then $\mathcal{G} = A_1 \otimes A_2 \otimes \dots \otimes A_s$ if and only if

- (1) $A_i \triangleleft \mathcal{G}$, $1 \leq i \leq s$;
- (2) $\mathcal{G} = A_1 A_2 \dots A_s$;
- (3) $(A_1 \dots A_{i-1} A_{i+1} \dots A_s) \cap A_i = \{1_{\mathcal{G}}\}$, $1 \leq i \leq s$.

1.4.2 Basis. Let $\mathcal{G} = \langle a_1, a_2, \dots, a_s \rangle$ be an Abelian group with an operation \circ . If

$$a_1^{k_1} \circ a_2^{k_2} \circ \dots \circ a_s^{k_s} = 1_{\mathcal{G}}$$

for integers k_1, k_2, \dots, k_s implies that $a_i^{k_i} = 1_{\mathcal{G}}$, $i = 1, 2, \dots, s$, then such a_1, a_2, \dots, a_s are called a *basis* of the Abelian group $(\mathcal{G}; \circ)$, denoted by $\mathcal{B}(\mathcal{G}) = \{a_1, a_2, \dots, a_s\}$. The following properties on basis of a group are clear by definition.

B1. If $\mathcal{G} = A \otimes B$ and $\mathcal{B}(A) = \{a_1, a_2, \dots, a_s\}$, $\mathcal{B}(B) = \{b_1, b_2, \dots, b_t\}$, then $\mathcal{B}(\mathcal{G}) = \{a_1, a_2, \dots, a_s, b_1, b_2, \dots, b_t\}$.

B2. If $\mathcal{B}(\mathcal{G}) = \{a_1, a_2, \dots, a_s\}$ and $A = \langle a_1, a_2, \dots, a_l \rangle$, $B = \langle a_{l+1}, a_{l+2}, \dots, a_s \rangle$, where $1 < l < s$, then $\mathcal{G} = A \otimes B$.

An importance of basis is shown in the next result.

Theorem 1.4.3 Any finite Abelian group has a basis.

Proof Let $\mathcal{G} = \langle a_1, a_2, \dots, a_r \rangle$ be an Abelian group with an operation \circ . If $r = 1$, then \mathcal{G} is a cyclic group with a basis $\mathcal{B}(\mathcal{G}) = \{a_1\}$.

Assume our conclusion is true for generators less than r . We prove it is also true for r generators. Let

$$a_1^{k_1} \circ a_2^{k_2} \circ \dots \circ a_r^{k_r} = 1_{\mathcal{G}} \quad (1-1)$$

for integers k_1, k_2, \dots, k_r . Define $m = \min\{k_1, k_2, \dots, k_r\}$. Without loss of generality, we assume $m = k_1$. If $m = 1$, we find that

$$a_1 = a_2^{-k_2} \circ a_3^{-k_3} \circ \dots \circ a_r^{-k_r}.$$

Hence, $\mathcal{G} = \langle a_2, a_3, \dots, a_r \rangle$ and the conclusion is true by the induction assumption.

So we can assume our conclusion is true for the power of a_1 less than m and find integers t_i, s_i for $i = 2, \dots, r$ such that

$$k_i = t_i m + s_i, \quad 0 \leq s_i < m.$$

Let

$$a_1^* = a_1 \circ a_2^{t_2} \circ \dots \circ a_r^{t_r}. \quad (1 - 2)$$

Substitute (1 - 2) into (1 - 1), we know that

$$(a_1^*)^m \circ a_2^{s_2} \circ \dots \circ a_r^{s_r} = 1_{\mathcal{G}}.$$

If there is an integer $i, 1 \leq i \leq r$ such that $s_i \neq 0$, then by the induction assumption, \mathcal{G} has a basis. So we can assume that

$$s_2 = s_3 = \dots = s_r = 0$$

and get

$$(a_1^*)^m = 1_{\mathcal{G}}.$$

Notice that

$$a_1 = a_1^* \circ a_2^{-t_2} \circ \dots \circ a_r^{-t_r}.$$

Whence, $\mathcal{G} = \langle a_1^*, a_2, \dots, a_r \rangle$. Now we prove that

$$\mathcal{G} = \langle a_1^* \rangle \otimes \langle a_2, \dots, a_r \rangle.$$

For this objective, we only need to check that

$$\langle a_1^* \rangle \cap \langle a_2, \dots, a_r \rangle = \{1_{\mathcal{G}}\}.$$

In fact, let $a \in \langle a_1^* \rangle \cap \langle a_2, \dots, a_r \rangle$. Then we know that

$$a = (a_1^*)^l = (a_1 \circ a_2^{t_2} \circ \dots \circ a_r^{t_r})^l = a_1^l \circ \dots \circ a_r^{l t_r}.$$

Therefore,

$$a_1^l \circ a_2^{t_2^l - l_2} \circ \cdots \circ a_r^{t_r^l - l_r} = 1_{\mathcal{G}} \quad (1 - 3)$$

By the Euclidean algorithm, we can always find an integer d such that

$$0 \leq l - dm < m.$$

By equalities (1 - 1) and (1 - 3), we get that

$$a_1^{l-dm} \circ a_2^{t_2^{l-dm} - l_2 - dm} \circ \cdots \circ a_r^{t_r^{l-dm} - l_r - dm} = 1_{\mathcal{G}}.$$

By the induction assumption, we must have $l - dm = 0$. So

$$a = (a_1^*)^l = (a_1^*)^{dm} = 1_{\mathcal{G}}.$$

Whence, we get that

$$\mathcal{G} = \langle a_1^* \rangle \otimes \langle a_2, \dots, a_r \rangle.$$

By the induction assumption again, let $\langle a_2, \dots, a_r \rangle = \langle b_2 \rangle \otimes \cdots \otimes \langle b_r \rangle$. We know that

$$\mathcal{G} = \langle a_1^* \rangle \otimes \langle b_2 \rangle \otimes \cdots \otimes \langle b_r \rangle.$$

This completes the proof. □

Corollary 1.4.1 *Any finite Abelian group is a direct product of cyclic groups.*

1.4.3 Finite Abelian Group Structure. Theorem 1.4.3 enable us to know that a finite Abelian group is the direct product of its cyclic subgroups. In fact, the structure of a finite Abelian group is completely determined by its order. That is the objective of this subsection.

Definition 1.4.4 *Let p be a prime number, $(\mathcal{G}; \circ)$ a group, $g \in \mathcal{G}$ and $\mathcal{H} \leq \mathcal{G}$. Then g is called a p -element, or \mathcal{H} a p -subgroup if $o(g) = p^k$ or $|\mathcal{H}| = p^l$ for some integers $k, l \geq 0$.*

Definition 1.4.5 *Let (\mathcal{G}, \circ) be a group with $|\mathcal{G}| = p^\alpha n$, $(p, n) = 1$. Then each subgroup $\mathcal{H} \leq \mathcal{G}$ with $|\mathcal{H}| = p^\alpha$ is called a Sylow p -subgroup of $(\mathcal{G}; \circ)$.*

Theorem 1.4.4 *Let $(\mathcal{G}; \circ)$ be a finite Abelian group with $|\mathcal{G}| = p_1^{\alpha_1} p_2^{\alpha_2} \cdots p_s^{\alpha_s}$, where p_1, p_2, \dots, p_s are prime numbers, different two by two. Then*

$$\mathcal{G} = \langle a_1 \rangle \otimes \langle a_2 \rangle \otimes \cdots \otimes \langle a_s \rangle$$

with $o(a_i) = p^{\alpha_i}$ for $1 \leq i \leq s$.

Proof By Corollary 1.4.1, a finite Abelian group is a direct product of cyclic groups, i.e.,

$$\mathcal{G} = \langle a_1 \rangle \otimes \langle a_2 \rangle \otimes \cdots \otimes \langle a_r \rangle.$$

If there is an integer i , $1 \leq i \leq r$ such that $o(a_i)$ is not a prime power, let $o(a_i) = p_1^{\beta_1} p_2^{\beta_2} \cdots p_l^{\beta_l}$ with $p_j \in \{p_i, 1 \leq i \leq s\}$, $\beta_j > 0$ for $1 \leq j \leq l$. We prove that a_i can be uniquely written as $a_i = b_1 \circ b_2 \circ \cdots \circ b_l$ such that $o(b_j) = p_j^{\beta_j}$, $b_i \circ b_j = b_j \circ b_i$, $1 \leq i, j \leq l$.

Now let $o(a_i) = m_1 m_2$ with $(m_1, m_2) = 1$. By a result in elementary number theory, there are integers u_1, u_2 such that $u_1 m_1 + u_2 m_2 = 1$. Whence, $a_i^{u_1 m_1 + u_2 m_2} = a_i^{u_1 m_1} \circ a_i^{u_2 m_2} = a_i^{u_2 m_2} \circ a_i^{u_1 m_1}$. Choose $c_1 = a_i^{u_2 m_2}$ and $c_2 = a_i^{u_1 m_1}$. Then $c_1^{m_1} = 1_{\mathcal{G}}$ and $c_2^{m_2} = 1_{\mathcal{G}}$. Whence, $o(c_1) | m_1$, $o(c_2) | m_2$. Because $c_1 \circ c_2 = c_2 \circ c_1$ and $(o(c_1), o(c_2)) = 1$, we know that $m_1 m_2 = o(a_i) = o(c_1 \circ c_2) = o(c_1) o(c_2)$. So there must be $o(c_1) = m_1$ and $o(c_2) = m_2$. Repeating the previous process, we finally get elements $b_1, b_2, \dots, b_l \in \mathcal{G}$ such that $a_i = b_1 \circ b_2 \circ \cdots \circ b_l$ with $o(b_j) = p_j^{\beta_j}$, $b_i \circ b_j = b_j \circ b_i$, $1 \leq i, j \leq l$.

Whence, we can assume that the order of each cyclic group in the direct product

$$\mathcal{G} = \langle a_1 \rangle \otimes \langle a_2 \rangle \otimes \cdots \otimes \langle a_r \rangle.$$

is a prime power. Now if the order of $\langle a_{i_1} \rangle, \langle a_{i_2} \rangle, \dots, \langle a_{i_k} \rangle$ are all with a same base p_i , replacing $a_{i_1} \circ a_{i_2} \circ \cdots \circ a_{i_k}$ by a_i we get a direct product

$$\mathcal{G} = \langle a_1 \rangle \otimes \langle a_2 \rangle \otimes \cdots \otimes \langle a_s \rangle$$

with $o(a_i) = p_i^{\alpha_i}$, $1 \leq i \leq l$. □

Theorem 1.4.5 *Let $(\mathcal{G}; \circ)$ be a finite Abelian p -group. If*

$$\mathcal{G} = A_1 \otimes A_2 \otimes \cdots \otimes A_r \text{ and } \mathcal{G} = B_1 \otimes B_2 \otimes \cdots \otimes B_s,$$

where A_i, B_j are cyclic p -groups for $1 \leq i \leq r$, $1 \leq j \leq s$, then $s = r$ and there is a bijection $\varpi : \{A_1, A_2, \dots, A_r\} \rightarrow \{B_1, B_2, \dots, B_r\}$ such that $|A_i| = |\varpi(A_i)|$, $1 \leq i \leq r$.

Proof We prove this result by induction on $|\mathcal{G}|$. If $|\mathcal{G}| = p$, the conclusion is clear. Define $\mathcal{G}_p = \{a \in \mathcal{G} | a^p = 1_{\mathcal{G}}\}$ and $\mathcal{G}^p = \{a^p | a \in \mathcal{G}\}$. Notice that

$$\mathcal{G} = A_1 \otimes A_2 \otimes \cdots \otimes A_r.$$

If $a_i \in A_i$ is the generator of A_i , $1 \leq i \leq r$, then $\mathcal{B}(\mathcal{G}) = \{a_1, a_2, \dots, a_r\}$. Let $o(a_i) = p^{e_i}$. Without loss of generality, we can assume that $e_1 \geq e_2 \geq \cdots \geq e_r \geq 1$. Then $\mathcal{B}(\mathcal{G}_p) =$

$\{a_1^{p^{e_1-1}}, a_2^{p^{e_2-1}}, \dots, a_r^{p^{e_r-1}}\}$ and $|\mathcal{G}_p| = p^r$. If $e_1 = e_2 = \dots = e_r = 1$, then $\mathcal{G}^p = \{1_{\mathcal{G}}\}$. Otherwise, let $e_1 \geq e_2 \geq \dots \geq e_m > e_{m+1} = \dots = e_r = 1$. Then $\mathcal{B}(\mathcal{G}^p) = \{a_1^p, a_2^p, \dots, a_m^p\}$.

Now let $b_i \in B_i$ be its a generator for $1 \leq i \leq s$. Then $\mathcal{B}(\mathcal{G}) = \{b_1, b_2, \dots, b_s\}$. Let $o(b_i) = p^{f_i}$, $1 \leq i \leq s$ with $f_1 \geq f_2 \geq \dots \geq f_s$. Similarly, we know that $|\mathcal{G}_p| = p^s$. So $s = r$. Now if $\mathcal{G}^p = \{1_{\mathcal{G}}\}$, there must be $f_1 = f_2 = \dots = f_s = 1$. Otherwise, if $\mathcal{G}^p \neq \{1_{\mathcal{G}}\}$, let $f_1 \geq f_2 \geq \dots \geq f_{m'} > f_{m'+1} = \dots = f_s = 1$. Then $\mathcal{B}(\mathcal{G}^p) = \{b_1^p, b_2^p, \dots, b_{m'}^p\}$. Notice that $|\mathcal{G}^p| < |\mathcal{G}|$, by the induction assumption, we get that $m = m'$ and $e_i = f_i$ for $1 \leq i \leq r$. Therefore, $o(a_i) = o(b_i)$ for $1 \leq i \leq r$. Now define $\varpi : \{A_1, A_2, \dots, A_r\} \rightarrow \{B_1, B_2, \dots, B_r\}$ by $\varpi(A_i) = B_i$, $1 \leq i \leq r$. We get $|A_i| = |\varpi(A_i)|$ for integers $1 \leq i \leq r$. \square

Combining Theorems 1.4.4 and 1.4.5, we get the fundamental theorem of finite Abelian groups following.

Theorem 1.4.6 *Any finite Abelian group $(\mathcal{G}; \circ)$ is a direct product*

$$\mathcal{G} = \langle a_1 \rangle \otimes \langle a_2 \rangle \otimes \dots \otimes \langle a_s \rangle$$

of cyclic p -groups uniquely determined up to their cardinality.

These cardinalities $|\langle a_1 \rangle|, |\langle a_2 \rangle|, \dots, |\langle a_s \rangle|$ in Theorem 1.4.6 are defined to be the *invariants* of Abelian group $(\mathcal{G}; \circ)$, denoted by $\text{Invar}\mathcal{G}$. Then we immediately get the following conclusion by Theorem 1.4.6.

Corollary 1.4.2 *Let \mathcal{G}, \mathcal{H} be finite Abelian groups. Then $\mathcal{G} \simeq \mathcal{H}$ if and only if $\text{Invar}\mathcal{G} = \text{Invar}\mathcal{H}$.*

§1.5 MULTIGROUPS

1.5.1 MultiGroup. Let $\widetilde{\mathcal{G}}$ be a set with binary operations $\widetilde{\mathcal{O}}$. A pair $(\widetilde{\mathcal{G}}; \widetilde{\mathcal{O}})$ is an *algebraic multi-system* if for $\forall a, b \in \widetilde{\mathcal{G}}$ and $\circ \in \widetilde{\mathcal{O}}$, $a \circ b \in \widetilde{\mathcal{G}}$ provided $a \circ b$ existing.

We consider algebraic multi-systems in this section.

Definition 1.5.1 *For an integer $n \geq 1$, an algebraic multi-system $(\widetilde{\mathcal{G}}; \widetilde{\mathcal{O}})$ is an n -multigroup if there are $\mathcal{G}_1, \mathcal{G}_2, \dots, \mathcal{G}_n \subset \widetilde{\mathcal{G}}$, $\widetilde{\mathcal{O}} = \{\circ_i, 1 \leq i \leq n\}$ with*

- (1) $\widetilde{\mathcal{G}} = \bigcup_{i=1}^n \mathcal{G}_i$;
- (2) $(\mathcal{G}_i; \circ_i)$ is a group for $1 \leq i \leq n$.

For $\forall \circ \in \tilde{O}$, denoted by \mathcal{G}_\circ the group $(\mathcal{G}; \circ)$ and \mathcal{G}_\circ^{\max} the maximal group $(\mathcal{G}; \circ)$, i.e., $(\mathcal{G}_\circ^{\max}; \circ)$ is a group but $(\mathcal{G}_\circ^{\max} \cup \{x\}; \circ)$ is not for $\forall x \in \tilde{\mathcal{G}} \setminus \mathcal{G}_\circ^{\max}$ in $(\tilde{\mathcal{G}}; \tilde{O})$.

Definition 1.5.2 Let $(\tilde{\mathcal{G}}_1; \tilde{O}_1)$ and $(\tilde{\mathcal{G}}_2; \tilde{O}_2)$ be multigroups. Then $(\tilde{\mathcal{G}}_1; \tilde{O}_1)$ is isomorphic to $(\tilde{\mathcal{G}}_2; \tilde{O}_2)$, denoted by $(\vartheta, \iota) : (\tilde{\mathcal{G}}_1; \tilde{O}_1) \rightarrow (\tilde{\mathcal{G}}_2; \tilde{O}_2)$ if there are bijections $\vartheta : \tilde{\mathcal{G}}_1 \rightarrow \tilde{\mathcal{G}}_2$ and $\iota : \tilde{O}_1 \rightarrow \tilde{O}_2$ such that for $a, b \in \tilde{\mathcal{G}}_1$ and $\circ \in \tilde{O}_1$,

$$\vartheta(a \circ b) = \vartheta(a)\iota(\circ)\vartheta(b)$$

provided $a \circ b$ existing in $(\tilde{\mathcal{G}}_1; \tilde{O}_1)$. Such isomorphic multigroups are denoted by $(\tilde{\mathcal{G}}_1; \tilde{O}_1) \simeq (\tilde{\mathcal{G}}_2; \tilde{O}_2)$

Clearly, if $(\tilde{\mathcal{G}}_1; \tilde{O}_1)$ is an n -multigroup with (ϑ, ι) an isomorphism, the image of (ϑ, ι) is also an n -multigroup. Now let $(\vartheta, \iota) : (\tilde{\mathcal{G}}_1; \tilde{O}_1) \rightarrow (\tilde{\mathcal{G}}_2; \tilde{O}_2)$ with $\tilde{\mathcal{G}}_1 = \bigcup_{i=1}^n \mathcal{G}_{1i}$, $\tilde{\mathcal{G}}_2 = \bigcup_{i=1}^n \mathcal{G}_{2i}$, $\tilde{O}_1 = \{\circ_{1i}, 1 \leq i \leq n\}$ and $\tilde{O}_2 = \{\circ_{2i}, 1 \leq i \leq n\}$, then for $\circ \in \tilde{O}$, \mathcal{G}_\circ^{\max} is isomorphic to $\vartheta(\mathcal{G}_{\iota(\circ)}^{\max})$ by definition. The following result shows that its converse is also true.

Theorem 1.5.1 Let $(\tilde{\mathcal{G}}_1; \tilde{O}_1)$ and $(\tilde{\mathcal{G}}_2; \tilde{O}_2)$ be n -multigroups with

$$\tilde{\mathcal{G}}_1 = \bigcup_{i=1}^n \mathcal{G}_{1i}, \quad \tilde{\mathcal{G}}_2 = \bigcup_{i=1}^n \mathcal{G}_{2i},$$

$\tilde{O}_1 = \{\circ_{1i}, 1 \leq i \leq n\}$, $\tilde{O}_2 = \{\circ_{2i}, 1 \leq i \leq n\}$. If $\phi_i : \mathcal{G}_{1i} \rightarrow \mathcal{G}_{2i}$ is an isomorphism for each integer i , $1 \leq i \leq n$ with $\phi_k|_{\mathcal{G}_{1k} \cap \mathcal{G}_{1l}} = \phi_l|_{\mathcal{G}_{1k} \cap \mathcal{G}_{1l}}$ for integers $1 \leq k, l \leq n$, then $(\tilde{\mathcal{G}}_1; \tilde{O}_1)$ is isomorphic to $(\tilde{\mathcal{G}}_2; \tilde{O}_2)$.

Proof Define mappings $\vartheta : \tilde{\mathcal{G}}_1 \rightarrow \tilde{\mathcal{G}}_2$ and $\iota : \tilde{O}_1 \rightarrow \tilde{O}_2$ by

$$\vartheta(a) = \phi_i(a) \text{ if } a \in \mathcal{G}_i \subset \tilde{\mathcal{G}} \text{ and } \iota(\circ_{1i}) = \circ_{2i} \text{ for each integer } 1 \leq i \leq n.$$

Notice that $\phi_k|_{\mathcal{G}_{1k} \cap \mathcal{G}_{1l}} = \phi_l|_{\mathcal{G}_{1k} \cap \mathcal{G}_{1l}}$ for integers $1 \leq k, l \leq n$. We know that ϑ, ι both are bijections. Let $a, b \in \mathcal{G}_{1s}$ for an integer s , $1 \leq s \leq n$. Then

$$\vartheta(a \circ_{1s} b) = \phi_s(a \circ_{1s} b) = \phi_s(a) \circ_{2s} \phi_s(b) = \vartheta(a)\iota(\circ_{1s})\vartheta(b).$$

Whence, $(\vartheta, \iota) : (\tilde{\mathcal{G}}_1; \tilde{O}_1) \rightarrow (\tilde{\mathcal{G}}_2; \tilde{O}_2)$. □

1.5.2 Submultigroup. Let $(\tilde{\mathcal{G}}; \tilde{O})$ be a multigroup, $\tilde{\mathcal{H}} \subset \tilde{\mathcal{G}}$ and $O \subset \tilde{O}$. If $(\tilde{\mathcal{H}}; O)$ is multigroup itself, then $(\tilde{\mathcal{H}}; O)$ is called a *submultigroup*, denoted by $(\tilde{\mathcal{H}}; O) \leq (\tilde{\mathcal{G}}; \tilde{O})$.

Then the following criterion is obvious for submultigroups.

Theorem 1.5.2 *An multi-subsystem $(\widetilde{\mathcal{H}}; O)$ of a multigroup $(\widetilde{\mathcal{G}}; \widetilde{O})$ is a submultigroup if and only if $\widetilde{\mathcal{H}} \cap \mathcal{G}_\circ \leq \mathcal{G}_\circ^{\max}$ for $\forall \circ \in O$.*

Proof By definition, if $(\widetilde{\mathcal{H}}; O)$ is a multigroup, then for $\forall \circ \in O$, $\widetilde{\mathcal{H}} \cap \mathcal{G}_\circ$ is a group. Whence, $\widetilde{\mathcal{H}} \cap \mathcal{G}_\circ \leq \mathcal{G}_\circ^{\max}$.

Conversely, if $\widetilde{\mathcal{H}} \cap \mathcal{G}_\circ \leq \mathcal{G}_\circ^{\max}$ for $\forall \circ \in O$, then $\widetilde{\mathcal{H}} \cap \mathcal{G}_\circ$ is a group. Therefore, $(\widetilde{\mathcal{H}}; O)$ is a multigroup by definition. \square

Applying Theorem 1.2.2, we get corollaries following.

Corollary 1.5.1 *An multi-subsystem $(\widetilde{\mathcal{H}}; O)$ of a multigroup $(\widetilde{\mathcal{G}}; \widetilde{O})$ is a submultigroup if and only if $a \circ b^{-1} \in \widetilde{\mathcal{H}} \cap \mathcal{G}_\circ^{\max}$ for $\forall \circ \in O$ and $a, b \in \widetilde{\mathcal{H}}$ provided $a \circ b$ existing in $(\widetilde{\mathcal{H}}; O)$.*

Particularly, if $O = \{\circ\}$, we get a conclusion following.

Corollary 1.5.2 *Let $\circ \in \widetilde{O}$. Then $(\mathcal{H}; \circ)$ is submultigroup of a multigroup $(\widetilde{\mathcal{G}}; \widetilde{O})$ for $\mathcal{H} \subset \widetilde{\mathcal{G}}$ if and only if $(\mathcal{H}; \circ)$ is a group, i.e., $a \circ b^{-1} \in \mathcal{H}$ for $a, b \in \mathcal{H}$.*

A multigroup $(\widetilde{\mathcal{G}}; \widetilde{O})$ is said to be a *symmetric n -multigroup* if there are $\mathcal{S}_1, \mathcal{S}_2, \dots, \mathcal{S}_n \subset \widetilde{\mathcal{G}}$, $\widetilde{O} = \{\circ_i, 1 \leq i \leq n\}$ with

$$(1) \widetilde{\mathcal{G}} = \bigcup_{i=1}^n \mathcal{S}_i;$$

(2) $(\mathcal{S}_i; \circ_i)$ is a symmetric group S_{Ω_i} for $1 \leq i \leq n$. We call the n -tuple $(|\Omega_1|, |\Omega_2|, \dots, |\Omega_n|)$ the *degree of the symmetric n -multigroup $(\widetilde{\mathcal{G}}; \widetilde{O})$.*

Now let multigroup $(\widetilde{\mathcal{G}}; \widetilde{O})$ be a n -multigroup with $\mathcal{G}_1, \mathcal{G}_2, \dots, \mathcal{G}_n \subset \widetilde{\mathcal{G}}$, $\widetilde{O} = \{\circ_i, 1 \leq i \leq n\}$. For any integer i , $1 \leq i \leq n$. Let $\mathcal{G}_{\circ_i} = \{a_{i1} = 1_{\mathcal{G}_{\circ_i}}, a_{i2}, \dots, a_{in_{\circ_i}}\}$. For $\forall a_{ik} \in \mathcal{G}_{\circ_i}$, define

$$\sigma_{a_{ik}} = \begin{pmatrix} a_{i1} & a_{i2} & \cdots & a_{in} \\ a_{i1} \circ a_{ik} & a_{i2} \circ a_{ik} & \cdots & a_{in_{\circ_i}} \circ a_{ik} \end{pmatrix} = \begin{pmatrix} a \\ a \circ a_{ik} \end{pmatrix},$$

$$\tau_{a_{ik}} = \begin{pmatrix} a_{i1} & a_{i2} & \cdots & a_{in_{\circ_i}} \\ a_{ik}^{-1} \circ a_{i1} & a_{ik}^{-1} \circ a_{i2} & \cdots & a_{ik}^{-1} \circ a_{in_{\circ_i}} \end{pmatrix} = \begin{pmatrix} a \\ a_{ik}^{-1} \circ a \end{pmatrix}$$

Denote by $R_{\mathcal{G}_i} = \{\sigma_{a_{i1}}, \sigma_{a_{i2}}, \dots, \sigma_{a_{in_{\circ_i}}}\}$ and $L_{\mathcal{G}_i} = \{\tau_{a_{i1}}, \tau_{a_{i2}}, \dots, \tau_{a_{in_{\circ_i}}}\}$ and \times_i^r or \times_i^l the induced multiplication in $R_{\mathcal{G}_i}$ or $L_{\mathcal{G}_i}$. Then we get two sets of permutations

$$R_{\widetilde{\mathcal{G}}} = \bigcup_{i=1}^n \{\sigma_{a_{i1}}, \sigma_{a_{i2}}, \dots, \sigma_{a_{in_{\circ_i}}}\} \text{ and } L_{\widetilde{\mathcal{G}}} = \bigcup_{i=1}^n \{\tau_{a_{i1}}, \tau_{a_{i2}}, \dots, \tau_{a_{in_{\circ_i}}}\}.$$

We say $R_{\tilde{\mathcal{G}}}$, $L_{\tilde{\mathcal{G}}}$ the *right* or *left regular representation* of $\tilde{\mathcal{G}}$, respectively. Similar to Theorem 1.2.15, the *Cayley* theorem, we get the following representation result for multi-groups.

Theorem 1.5.3 *Every multigroup is isomorphic to a submultigroup of symmetric multigroup.*

Proof Let multigroup $(\tilde{\mathcal{G}}; \tilde{O})$ be a n -multigroup with $\mathcal{G}_1, \mathcal{G}_2, \dots, \mathcal{G}_n \subset \tilde{\mathcal{G}}$, $\tilde{O} = \{\circ_i, 1 \leq i \leq n\}$. For any integer i , $1 \leq i \leq n$. By Theorem 1.2.14, we know that $R_{\mathcal{G}_i}$ and $L_{\mathcal{G}_i}$ both are subgroups of the symmetric group $S_{\mathcal{G}_i}$ for any integer $1 \leq i \leq n$. Whence, $(R_{\tilde{\mathcal{G}}}; O^r)$ and $(L_{\tilde{\mathcal{G}}}; O^l)$ both are submultigroup of symmetric multigroup by definition, where $O^r = \{\times'_i | 1 \leq i \leq n\}$ and $O^l = \{\times^l_i | 1 \leq i \leq n\}$.

We only need to prove that $(\tilde{\mathcal{G}}; \tilde{O})$ is isomorphic to $(R_{\tilde{\mathcal{G}}}; O^r)$. For this objective, define a mapping $(f, \iota) : (\tilde{\mathcal{G}}; \tilde{O}) \rightarrow (R_{\tilde{\mathcal{G}}}; O^r)$ by

$$f(a_{ik}) = \sigma_{a_{ik}} \text{ and } \iota(\circ_i) = \times'_i$$

for integers $1 \leq i \leq n$. Such a mapping is one-to-one by definition. It is easily to see that

$$f(a_{ij} \circ_i a_{ik}) = \sigma_{a_{ij} \circ_i a_{ik}} = \sigma_{a_{ij}} \times'_i \sigma_{a_{ik}} = f(a_{ij}) \iota(\circ_i) f(a_{ik})$$

for integers $1 \leq i, k, l \leq n$. Whence, (f, ι) is an isomorphism from $(\tilde{\mathcal{G}}; \tilde{O})$ to $(R_{\tilde{\mathcal{G}}}; O^r)$. Similarly, we can also prove that $(\tilde{\mathcal{G}}; \tilde{O}) \simeq (L_{\tilde{\mathcal{G}}}; O^l)$. \square

1.5.3 Normal Submultigroup. A submultigroup $(\tilde{\mathcal{H}}; O)$ of $(\tilde{\mathcal{G}}; \tilde{O})$ is *normal*, denoted by $(\tilde{\mathcal{H}}; O) \triangleleft (\tilde{\mathcal{G}}; \tilde{O})$ if for $\forall g \in \tilde{\mathcal{G}}$ and $\forall \circ \in O$

$$g \circ \tilde{\mathcal{H}} = \tilde{\mathcal{H}} \circ g,$$

where $g \circ \tilde{\mathcal{H}} = \{g \circ h | h \in \tilde{\mathcal{H}} \text{ provided } g \circ h \text{ existing}\}$ and $\tilde{\mathcal{H}} \circ g$ is similarly defined. Then we get a criterion for normal submultigroups of a multigroup following.

Theorem 1.5.4 *Let $(\tilde{\mathcal{H}}; O) \leq (\tilde{\mathcal{G}}; \tilde{O})$. Then $(\tilde{\mathcal{H}}; O) \triangleleft (\tilde{\mathcal{G}}; \tilde{O})$ if and only if*

$$\tilde{\mathcal{H}} \cap \mathcal{G}_\circ^{\max} \triangleleft \mathcal{G}_\circ^{\max}$$

for $\forall \circ \in O$.

Proof If $\tilde{\mathcal{H}} \cap \mathcal{G}_\circ^{\max} \triangleleft \mathcal{G}_\circ^{\max}$ for $\forall \circ \in O$, then $g \circ \tilde{\mathcal{H}} = \tilde{\mathcal{H}} \circ g$ for $\forall g \in \mathcal{G}_\circ^{\max}$ by definition, i.e., all such $g \in \tilde{\mathcal{G}}$ and $h \in \tilde{\mathcal{H}}$ with $g \circ h$ and $h \circ g$ defined. So $(\tilde{\mathcal{H}}; O) \triangleleft (\tilde{\mathcal{G}}; \tilde{O})$.

Now if $(\widetilde{\mathcal{H}}; O) \triangleleft (\widetilde{\mathcal{G}}; \widetilde{O})$, it is clear that $\widetilde{\mathcal{H}} \cap \mathcal{G}_o^{\max} \triangleleft \mathcal{G}_o^{\max}$ for $\forall o \in O$. □

For a normal submultigroup $(\widetilde{\mathcal{H}}; O)$ of $(\widetilde{\mathcal{G}}; \widetilde{O})$, we know that

$$(a \circ \widetilde{\mathcal{H}}) \cap (b \cdot \widetilde{\mathcal{H}}) = \emptyset \text{ or } a \circ \widetilde{\mathcal{H}} = b \cdot \widetilde{\mathcal{H}}.$$

In fact, if $c \in (a \circ \widetilde{\mathcal{H}}) \cap (b \cdot \widetilde{\mathcal{H}})$, then there exists $h_1, h_2 \in \widetilde{\mathcal{H}}$ such that

$$a \circ h_1 = c = b \cdot h_2.$$

So a^{-1} and b^{-1} exist in \mathcal{G}_o^{\max} and \mathcal{G}_o^{\max} , respectively. Thus,

$$b^{-1} \cdot a \circ h_1 = b^{-1} \cdot b \cdot h_2 = h_2.$$

Whence,

$$b^{-1} \cdot a = h_2 \circ h_1^{-1} \in \widetilde{\mathcal{H}}.$$

We find that

$$a \circ \widetilde{\mathcal{H}} = b \cdot (h_2 \circ h_1) \circ \widetilde{\mathcal{H}} = b \cdot \widetilde{\mathcal{H}}.$$

This fact enables one to find a partition of $\widetilde{\mathcal{G}}$ following

$$\widetilde{\mathcal{G}} = \bigcup_{g \in \widetilde{\mathcal{G}}, o \in \widetilde{O}} g \circ \widetilde{\mathcal{H}}.$$

Choose an element h from each $g \circ \widetilde{\mathcal{H}}$ and denoted by H all such elements, called the *representation* of a partition of $\widetilde{\mathcal{G}}$, i.e.,

$$\widetilde{\mathcal{G}} = \bigcup_{h \in H, o \in \widetilde{O}} h \circ \widetilde{\mathcal{H}}.$$

Define the *quotient set* of $\widetilde{\mathcal{G}}$ by $\widetilde{\mathcal{H}}$ to be

$$\widetilde{\mathcal{G}}/\widetilde{\mathcal{H}} = \{h \circ \widetilde{\mathcal{H}} \mid h \in H, o \in O\}.$$

Notice that $\widetilde{\mathcal{H}}$ is normal. We find that

$$(a \circ \widetilde{\mathcal{H}}) \cdot (b \bullet \widetilde{\mathcal{H}}) = \widetilde{\mathcal{H}} \circ a \cdot b \bullet \widetilde{\mathcal{H}} = (a \cdot b) \circ \widetilde{\mathcal{H}} \bullet \widetilde{\mathcal{H}} = (a \cdot b) \circ \widetilde{\mathcal{H}}$$

in $\widetilde{\mathcal{G}}/\widetilde{\mathcal{H}}$ for $\circ, \bullet, \cdot \in \widetilde{O}$, i.e., $(\widetilde{\mathcal{G}}/\widetilde{\mathcal{H}}; O)$ is an algebraic system. It is easily to check that $(\widetilde{\mathcal{G}}/\widetilde{\mathcal{H}}; O)$ is a multigroup by definition, called the *quotient multigroup* of $\widetilde{\mathcal{G}}$ by $\widetilde{\mathcal{H}}$.

Now let $(\widetilde{\mathcal{G}}_1; \widetilde{\mathcal{O}}_1)$ and $(\widetilde{\mathcal{G}}_2; \widetilde{\mathcal{O}}_2)$ be multigroups. A mapping pair (ϕ, ι) with $\phi : \widetilde{\mathcal{G}}_1 \rightarrow \widetilde{\mathcal{G}}_2$ and $\iota : \widetilde{\mathcal{O}}_1 \rightarrow \widetilde{\mathcal{O}}_2$ is a *homomorphism* if

$$\phi(a \circ b) = \phi(a)\iota(\circ)\phi(b)$$

for $\forall a, b \in \mathcal{G}$ and $\circ \in \widetilde{\mathcal{O}}_1$ provided $a \circ b$ existing in $(\widetilde{\mathcal{G}}_1; \widetilde{\mathcal{O}}_1)$. Define the *image* $\text{Im}(\phi, \iota)$ and *kernel* $\text{Ker}(\phi, \iota)$ respectively by

$$\text{Im}(\phi, \iota) = \{ \phi(g) \mid g \in \widetilde{\mathcal{G}}_1 \},$$

$$\text{Ker}(\phi, \iota) = \{ g \mid \phi(g) = 1_{\mathcal{G}_2}, g \in \widetilde{\mathcal{G}}_1, \circ \in \widetilde{\mathcal{O}}_2 \}.$$

Then we get the following isomorphism theorem for multigroups.

Theorem 1.5.5 *Let $(\phi, \iota) : (\widetilde{\mathcal{G}}_1; \widetilde{\mathcal{O}}_1) \rightarrow (\widetilde{\mathcal{G}}_2; \widetilde{\mathcal{O}}_2)$ be a homomorphism. Then*

$$\widetilde{\mathcal{G}}_1 / \text{Ker}(\phi, \iota) \simeq \text{Im}(\phi, \iota).$$

Proof Notice that $\text{Ker}(\phi, \iota)$ is a normal submultigroup of $(\widetilde{\mathcal{G}}_1; \widetilde{\mathcal{O}}_1)$. We prove that the induced mapping (σ, ω) determined by $(\sigma, \omega) : x \circ \text{Ker}(\phi, \iota) \rightarrow \phi(x)$ is an isomorphism from $\widetilde{\mathcal{G}}_1 / \text{Ker}(\phi, \iota)$ to $\text{Im}(\phi, \iota)$.

Now if $(\sigma, \omega)(x_1) = (\sigma, \omega)(x_2)$, then we get that $(\sigma, \omega)(x_1 \circ x_2^{-1}) = 1_{\mathcal{G}_2}$ provided $x_1 \circ x_2^{-1}$ existing in $(\widetilde{\mathcal{G}}_1; \widetilde{\mathcal{O}}_1)$, i.e., $x_1 \circ x_2^{-1} \in \text{Ker}(\phi, \iota)$. Thus $x_1 \circ \text{Ker}(\phi, \iota) = x_2 \circ \text{Ker}(\phi, \iota)$, i.e., the mapping (σ, ω) is one-to-one. Whence it is a bijection from $\widetilde{\mathcal{G}}_1 / \text{Ker}(\phi, \iota)$ to $\text{Im}(\phi, \iota)$.

For $\forall a \circ \text{Ker}(\phi, \iota), b \circ \text{Ker}(\phi, \iota) \in \widetilde{\mathcal{G}}_1 / \text{Ker}(\phi, \iota)$ and $\cdot \in \widetilde{\mathcal{O}}_1$, we get that

$$\begin{aligned} & (\sigma, \omega)[a \circ \text{Ker}(\phi, \iota) \cdot b \bullet \text{Ker}(\phi, \iota)] \\ &= (\sigma, \omega)[(a \cdot b) \circ \text{Ker}(\phi, \iota)] = \phi(a \cdot b) \\ &= \phi(a)\iota(\cdot)\phi(b) = (\sigma, \omega)[a \circ \text{Ker}(\phi, \iota)]\iota(\cdot)(\sigma, \omega)[b \bullet \text{Ker}(\phi, \iota)]. \end{aligned}$$

Whence, (σ, ω) is an isomorphism from $\widetilde{\mathcal{G}}_1 / \text{Ker}(\phi, \iota)$ to $\text{Im}(\phi, \iota)$. □

Particularly, let $(\widetilde{\mathcal{G}}_2; \widetilde{\mathcal{O}}_2)$ be a group in Theorem 1.5.4, we get a generalization of the fundamental homomorphism theorem, i.e., Corollary 1.3.1 following.

Corollary 1.5.3 *Let $(\widetilde{\mathcal{G}}; \widetilde{\mathcal{O}})$ be a multigroup and $(\omega, \iota) : (\widetilde{\mathcal{G}}; \widetilde{\mathcal{O}}) \rightarrow (\mathcal{A}; \circ)$ an epimorphism from $(\widetilde{\mathcal{G}}; \widetilde{\mathcal{O}})$ to a group $(\mathcal{A}; \circ)$. Then*

$$\widetilde{\mathcal{G}} / \text{Ker}(\omega, \iota) \cong (\mathcal{A}; \circ).$$

1.5.4 Abelian Multigroup. For an integer $n \geq 1$, an n -multigroup $(\tilde{\mathcal{G}}; \tilde{\mathcal{O}})$ is *Abelian* if there are $\mathcal{A}_1, \mathcal{A}_2, \dots, \mathcal{A}_n \subset \tilde{\mathcal{G}}, \tilde{\mathcal{O}} = \{\circ_i, 1 \leq i \leq n\}$ with

- (1) $\tilde{\mathcal{G}} = \bigcup_{i=1}^n \mathcal{A}_i$;
- (2) $(\mathcal{A}_i; \circ_i)$ is Abelian for integers $1 \leq i \leq n$.

For $\forall \circ \in \tilde{\mathcal{O}}$, a commutative set of \mathcal{G}_\circ^{\max} is defined by

$$C(\mathcal{G}_\circ) = \{a, b \in \mathcal{G}_\circ^{\max} \mid a \circ b = b \circ a\}.$$

Such a set is called *maximal* if $C(\mathcal{G}_\circ) \cup \{x\}$ for $x \in \mathcal{G}_\circ^{\max} \setminus C(\mathcal{G}_\circ)$ is not commutative again. Denoted by $Z^{\max}(\mathcal{G}_\circ)$ the maximal commutative set of \mathcal{G}_\circ^{\max} . Then it is clear that $Z^{\max}(\mathcal{G}_\circ)$ is an Abelian subgroup of \mathcal{G}_\circ^{\max} .

Theorem 1.5.6 *An n -multigroup $(\tilde{\mathcal{G}}; \tilde{\mathcal{O}})$ is Abelian if and only if there are $Z^{\max}(\mathcal{G}_\circ)$ for $\forall \circ \in \tilde{\mathcal{O}}$ such that*

$$\tilde{\mathcal{G}} = \bigcup_{\circ \in \tilde{\mathcal{O}}} Z^{\max}(\mathcal{G}_\circ).$$

Proof If $\tilde{\mathcal{G}} = \bigcup_{\circ \in \tilde{\mathcal{O}}} Z^{\max}(\mathcal{G}_\circ)$, it is clear that $(\tilde{\mathcal{G}}; \tilde{\mathcal{O}})$ is Abelian since $Z^{\max}(\mathcal{G}_\circ)$ is an Abelian subgroup of \mathcal{G}_\circ^{\max} . Now if $(\tilde{\mathcal{G}}; \tilde{\mathcal{O}})$ is Abelian, then there are $\mathcal{A}_1, \mathcal{A}_2, \dots, \mathcal{A}_n \subset \tilde{\mathcal{G}}, \tilde{\mathcal{O}} = \{\circ_i, 1 \leq i \leq n\}$ such that

$$\tilde{\mathcal{G}} = \bigcup_{i=1}^n \mathcal{A}_i$$

and $(\mathcal{A}_i; \circ_i)$ is an Abelian group for $1 \leq i \leq n$. Whence, there exists a maximal commutative set $Z^{\max}(\mathcal{G}_{\circ_i}) \subset \mathcal{G}_{\circ_i}^{\max}$ such that $\mathcal{A}_i \subset Z^{\max}(\mathcal{G}_{\circ_i})$. Consequently, we get that

$$\tilde{\mathcal{G}} = \bigcup_{i=1}^n Z^{\max}(\mathcal{G}_{\circ_i}).$$

This completes the proof. □

Combining Theorems 1.5.6 with 1.4.6, we get the structure of finite Abelian multigroup following.

Theorem 1.5.7 *A finite multigroup $(\tilde{\mathcal{G}}; \tilde{\mathcal{O}})$ is Abelian if and only if there are generators $a_i^\circ, 1 \leq i \leq s_\circ$ for $\forall \circ \in \tilde{\mathcal{O}}$ such that*

$$\tilde{\mathcal{G}} = \bigcup_{\circ \in \tilde{\mathcal{O}}} \langle a_1^\circ \rangle \otimes \langle a_2^\circ \rangle \otimes \dots \otimes \langle a_{s_\circ}^\circ \rangle.$$

1.5.5 Bigroup. A *bigroup* is nothing but a 2-multigroup. There are many examples of bigroups in algebra. For example, these natural number field $(\mathbb{Q}; +, \cdot)$, real number number field $(\mathbb{R}; +, \cdot)$ and complex number field $(\mathbb{C}; +, \cdot)$ are all Abelian bigroups. Generally, a field $(F; +, \cdot)$ is an algebraic system F with two operations $+, \cdot$ such that

- (1) $(F; +)$ is an Abelian group with identity 0;
- (2) $(F \setminus \{0\}; \cdot)$ is an Abelian group;
- (3) $a \cdot (b + c) = a \cdot b + a \cdot c$ for $\forall a, b, c \in F$.

Thus a field is an Abelian 2-group with an additional condition (3) called the *distributive law* following.

Definition 1.5.3 A bigroup $(\mathcal{C}; +, \cdot)$ is distributive if

$$a \cdot (b + c) = a \cdot b + a \cdot c$$

hold for all $a, b, c \in \mathcal{B}$.

Theorem 1.5.8 Let $(\mathcal{C}; +, \cdot)$ be a distributive bigroup of order ≥ 2 with $\mathcal{C} = A_1 \cup A_2$ such that $(A_1; +)$ and (A_2, \cdot) are groups. Then there must be $A_1 \neq A_2$.

Proof Denoted by $0_+, 1_+$ the identities in groups $(A_1; +)$, (A_2, \cdot) , respectively. If $A_1 = A_2 = \mathcal{C}$, we get $1_+, 1_+ \in A_1$ and A_2 . Because (A_2, \cdot) is a group, there exists an inverse element 0_+^{-1} in A_2 such that $0_+^{-1} \cdot 0_+ = 1_+$. By the distributive laws, we know that

$$a \cdot 0_+ = a \cdot (0_+ + 0_+) = a \cdot 0_+ + a \cdot 0_+$$

hold for $\forall a \in \mathcal{C}$. Whence, $a \cdot 0_+ = 0_+$. Particularly, let $a = 0_+^{-1}$, we get that $0_+^{-1} \cdot 0_+ = 0_+$, which means that $0_+ = 1_+$. But if so, we must get that

$$a = a \circ 1_+ = a \circ 0_+ = 0_+,$$

contradicts to the assumption $|\mathcal{C}| \geq 2$. □

Theorem 1.5.8 implies the following conclusions.

Corollary 1.5.3 Let $(\mathcal{G}; \circ)$ be a non-trivial group. Then there are no operations $\cdot \neq \circ$ on \mathcal{G} such that $(\mathcal{G}; \circ, \cdot)$ is a distributive bigroup.

Corollary 1.5.4 Any bigroup $(\mathcal{C}; \circ, \cdot)$ of order ≥ 2 with groups $(\mathcal{C}; \circ)$ and (\mathcal{C}, \cdot) is not distributive.

Corollary 1.5.4 enables one to classify bigroups into the following categories:

Class 1. $(\{1_{\mathcal{C}}\}; +, \cdot)$, i.e., which is a union of two trivial groups $(\{1_{\mathcal{C}}\}; +)$ and $(\{1_{\mathcal{C}}\}; \cdot)$.

Class 2. *Non-distributive bigroups of order ≥ 2 .*

This kind of bigroup is easily found. Let $(\mathcal{G}_1; \circ)$ and $(\mathcal{G}_2; \cdot)$ be two groups without the definition $a \circ b \cdot c$ and $a \cdot b \circ$ for $a, b, c \in \mathcal{C}$, where $\mathcal{C} = \mathcal{G}_1 \cup \mathcal{G}_2$. Then $(\mathcal{C}; \circ, \cdot)$ is a non-distributive bigroup with order ≥ 2 .

Class 3. *Distributive bigroups of order ≥ 2 .*

In fact, any field is such a distributive Abelian bigroup. Certainly, we can find a more general result for the existence of finite distributive bigroups.

Theorem 1.5.9 *There are finite distributive Abelian bigroups $(\mathcal{C}; +, \cdot)$ of order ≥ 2 with groups $(A_1; +)$ and (A_2, \cdot) such that $\mathcal{C} = A_1 \cup A_2$ for $|A_1 - A_2| = |\mathcal{C}| - m$, where $(m + 1) \parallel |\mathcal{C}|$.*

Proof In fact, let $(\mathcal{F}; +, \cdot)$ be a field. Then $(\mathcal{F}; +)$ and $(\mathcal{F} \setminus \{0_+\}; \cdot)$ both are Abelian group. Applying Theorem 1.4.6, we know that there are subgroups $(A'_2; \cdot)$ of $(\mathcal{F} \setminus \{0_+\}; \cdot)$ with order m , where $(m + 1) \parallel |\mathcal{C}|$. Obviously, $\mathcal{C} = A_1 \cup A'_2$. So $(\mathcal{F}; +, \cdot)$ is also a distributive Abelian bigroup with groups $(A_1; +)$ and (A'_2, \cdot) such that $\mathcal{C} = A_1 \cup A_2$ and $|A_1 - A_2| = |\mathcal{C}| - m$. \square

A group $(\mathcal{H}; \circ)$ (or $(\mathcal{H}; \cdot)$) is *maximum* in a bigroup $(\mathcal{G}; \circ, \cdot)$ if there are no groups $(\mathcal{T}; \circ)$ (or $(\mathcal{T}; \cdot)$) in $(\mathcal{G}; \circ, \cdot)$ such that $|\mathcal{H}| < |\mathcal{T}|$. Combining Theorem 1.5.9 with Corollaries 1.5.3 and 1.5.4, we get the following result on fields.

Theorem 1.5.10 *A field $(\mathcal{F}; +, \cdot)$ is a distributive Abelian bigroup with maximum groups $(\mathcal{F}; +)$ and $(\mathcal{F} \setminus \{0_+\}; \cdot)$.*

1.5.6 Constructing Multigroup. There are many ways to get multigroups. For example, let \mathcal{G} be a set. Define n binary operations $\circ_1, \circ_2, \dots, \circ_n$ such that $(\mathcal{G}; \circ_i)$ is a group for any integer i , $1 \leq i \leq n$. Then $(\mathcal{G}; \{\circ_i, 1 \leq i \leq n\})$ is a multigroup by definition. In fact, the structure of a multigroup is dependent on its combinatorial structure, i.e., its underlying graph, which will be discussed in Chapter 3. In this subsection, we construct multigroups only by one group or one field.

Construction 1.5.1 Let $(\mathcal{G}; \circ)$ be a group and $S_{\mathcal{G}}$ the symmetric group on \mathcal{G} . For $\forall a, b \in$

\mathcal{G} and

$$\omega = \begin{pmatrix} a \\ a^\omega \end{pmatrix} \in S_{\mathcal{G}},$$

define a binary operation \circ_ω on $\mathcal{G}^\omega = \mathcal{G}$ by

$$a \circ_\omega b = (a^{\omega^{-1}} \circ b^{\omega^{-1}})^\omega$$

for $\forall a, b \in \mathcal{G}$, Clearly, $(\mathcal{G}^\omega; \circ_\omega)$ is a group and $\omega : (\mathcal{G}; \circ) \rightarrow (\mathcal{G}^\omega; \circ_\omega)$ is an isomorphism. Now for an integer $n \geq 1$, choose n permutations $\omega_1, \omega_2, \dots, \omega_n$. Then we get a multigroup $(\mathcal{G}; \{\circ_{\omega_i} | 1 \leq i \leq n\})$, where groups $(\mathcal{G}; \circ_{\omega_i})$ is isomorphic to $(\mathcal{G}; \circ_{\omega_j})$ for integers $1 \leq i, j \leq n$. Therefore, we get the following result of multigroups.

Theorem 1.5.11 *There is a multigroup \mathcal{P} such that each of its group is isomorphic to others in \mathcal{P} .*

Construction 2.5.2 Let $(\mathcal{F}; +, \cdot)$ be a field and $S_{\mathcal{F}}$ the symmetric group acting on \mathcal{F} . For $\forall c, d \in \mathcal{F}$ and $\omega \in S_{\mathcal{F}}$, define a binary operation $+\omega$ on $\mathcal{F}^\omega = \mathcal{F}$ by

$$a +_\omega b = (a^{\omega^{-1}} + b^{\omega^{-1}})^\omega$$

and

$$a \cdot_\omega b = (a^{\omega^{-1}} \cdot b^{\omega^{-1}})^\omega$$

for $\forall a, b \in \mathcal{F}$. Choose n permutations $\varsigma_1, \varsigma_2, \dots, \varsigma_n \in S_{\mathcal{F}}$. Then we get a multigroup

$$\widetilde{\mathcal{F}} = (\mathcal{F}; \{+_{\varsigma_i}, 1 \leq i \leq n\}, \{\cdot_{\varsigma_i}, 1 \leq i \leq n\}),$$

which enables us immediately to get a result following.

Theorem 1.5.12 *There is a multigroup $(\widetilde{\mathcal{F}}; \{+_{\varsigma_i}, 1 \leq i \leq n\}, \{\cdot_{\varsigma_i}, 1 \leq i \leq n\})$ such that for any integer i , $(\widetilde{\mathcal{F}}; +_{\varsigma_i}, \cdot_{\varsigma_i})$ is a field and it is isomorphic to $(\widetilde{\mathcal{F}}; +_{\varsigma_j}, \cdot_{\varsigma_j})$ for any integer j , $1 \leq i, j \leq n$.*

§1.6 REMARKS

1.6.1 There are many standard books on abstract groups, such as those of [BiM1], [Rob1], [Wan1], [Xum1] and [Zha1] for examples. In fact, the materials in Sections 1.1-1.4 are

mainly extracted from references [BiM1] and [Wan1] as an elementary introduction to groups.

1.6.2 For an integer $n \geq 1$, a *Smarandache multi-space* is a union of spaces A_1, A_2, \dots, A_n different two by two. Let A_i , $1 \leq i \leq n$ be mathematical structures appeared in sciences, such as those of groups, rings, fields, metric spaces or physical fields, we therefore get multigroups, multrings, multfields, multmetric spaces or physical multi-fields. The material of Section 1.5 is on multigroups with new results. More results on multi-spaces can be found in references [Mao4]-[Mao10], [Mao20], [Mao24]-[Mao25] and [Sma1]-[Sma2].

1.6.3 The conceptions of bigroup and sub-bigroup were first appeared in [Mag1] and [MaK1]. Certainly, they are special cases of multigroup and submultigroup, i.e., special cases of Smarandache multi-spaces. More results on bigroups can be found in [Kan1]. In fact, Theorems 1.5.2-1.5.5 are the generalization of results on bigroups appeared in [Kan1].

1.6.4 The applications of groups to other sciences are mainly by surveying symmetries of objects, i.e., the action groups. For this objective, an elementary introduction has been appeared in Subsection 1.2.6, i.e., regular representation of group. In fact, those approaches can be only surveying global symmetries of objects. For locally surveying symmetries, we are needed *locally action groups*, which will be introduced in the following chapter.

CHAPTER 2.

Action Groups

Action groups, i.e., group actions on objects are the oldest form, also the origin of groups. The action idea enables one to measure similarity of objects, classify algebraic systems, geometrical objects by groups, which is the fountain of applying groups to other sciences. Besides, it also allows one to find symmetrical configurations, satisfying the aesthetic feeling of human beings. Topics covered in this chapter including permutation groups, transitive groups, multiply transitive groups, primitive and non-primitive groups, automorphism groups of groups and p -groups. Generally, we globally measure the symmetry of an object by group action. If allowed the action locally, then we need the conception of locally action group, i.e., action multi-group, a generalization of group actions to multi-groups discussed in this chapter.

§2.1 PERMUTATION GROUPS

2.1.1 Group Action. Let $(\mathcal{G}; \circ)$ be a group and $\Omega = \{a_1, a_2, \dots, a_n\}$. By a *right action* of \mathcal{G} on Ω is meant a mapping $\rho : \Omega \times \mathcal{G} \rightarrow \Omega$ such that

$$(x, g_1 \circ g_2)\rho = ((x, g_1)\rho, g_2)\rho \quad \text{and} \quad (x, 1_{\mathcal{G}})\rho = x.$$

It is more convenient to write x^g instead of $(x, g)\rho$. Then the defining equations become

$$x^{g_1 g_2} = (x^{g_1})^{g_2} \quad \text{and} \quad x^{1_{\mathcal{G}}} = x, \quad x \in \Omega, g_1, g_2 \in \mathcal{G}.$$

For a fixed $g \in \mathcal{G}$, the inverse mapping of $x \rightarrow x^g$ is $x \rightarrow x^{g^{-1}}$. Whence, $x \rightarrow xg$ is a permutation of Ω . Denote this permutation by g^γ . Then $(g_1 \circ g_2)^\gamma$ maps x to $x^{g_1 g_2}$, as does $g_1^\gamma g_2^\gamma$. We find that $(g_1 \circ g_2)^\gamma = g_1^\gamma g_2^\gamma$. Therefore, the group action determines a homomorphism $\gamma : \mathcal{G} \rightarrow S_\Omega$. Such a homomorphism γ is called a *permutation representation* of \mathcal{G} on Ω .

Two permutation representations of a group $\gamma : \mathcal{G} \rightarrow S_X$ and $\delta : \mathcal{G} \rightarrow S_Y$ of a group \mathcal{G} on X and Y are said to be *equivalent* if there exists a bijection $\theta : X \rightarrow Y$ such that

$$\theta g^\delta = g^\gamma \theta, \quad \text{i.e.,} \quad x^{\theta g^\delta} = x^{g^\gamma \theta}$$

for all $x \in X$ and $g \in \mathcal{G}$. Particularly, if $X = Y$, then there are some $\theta \in S_X$ such that $g^\delta = \theta^{-1} g^\gamma \theta$. Certainly, we do not distinguish equivalent representations of permutation groups in the view of action.

Let $\gamma : \mathcal{G} \rightarrow S_\Omega$ be a permutation representation of \mathcal{G} on Ω . The cardinality of Ω is called the *degree* of this representation. A permutation representation is *faithful* if $\text{Ker } \gamma = \{1_{\mathcal{G}}\}$. So the subgroups \mathcal{P} of S_Ω are particularly important, called *permutation groups*. For $a \in \Omega$ and $\tau \in \mathcal{P}$, we usually denote the image of a under τ by a^τ ,

$$\tau = \begin{pmatrix} a_1 & a_2 & \cdots & a_n \\ a_1^\tau & a_2^\tau & \cdots & a_n^\tau \end{pmatrix} = \begin{pmatrix} a \\ a^\tau \end{pmatrix}.$$

As a special case of equivalent representations of groups, let \mathcal{P}_1 and \mathcal{P}_2 be two permutation groups action on Ω_1, Ω_2 , respectively. A *similarity* from \mathcal{P}_1 to \mathcal{P}_2 is a pair (γ, θ) consisting of an isomorphism $\gamma : \mathcal{P}_1 \rightarrow \mathcal{P}_2$ and a bijection $\theta : \Omega_1 \rightarrow \Omega_2$ which are related by

$$\pi \theta = \theta \pi^\gamma, \quad \text{i.e.,} \quad a^{\pi \theta} = a^{\theta \pi^\gamma}$$

for all $a \in \Omega_1$ and $\pi \in \mathcal{P}_1$. Particularly, if $\Omega_1 = \Omega_2$, this equality means that $\pi^\gamma = \theta^{-1}\pi\theta$ for $\forall \pi, \theta \in \mathcal{P}_1$.

2.1.2 Stabilizer. The *stabilizer* \mathcal{P}_a and *orbit* $a^\mathcal{P}$ of an element a in \mathcal{P} are respectively defined as follows:

$$\mathcal{P}_a = \{ \sigma \mid a^\sigma = a, \sigma \in \mathcal{P} \} \text{ and } a^\mathcal{P} = \{ b \mid a^\sigma = b, \sigma \in \mathcal{P} \}.$$

Then we know the following result.

Theorem 2.1.1 *Let \mathcal{P} be a permutation group acting on Ω , $x, y \in \mathcal{P}$ and $a, b \in \Omega$. Then*

- (1) $a^\mathcal{P} \cap b^\mathcal{P} = \emptyset$ or $a^\mathcal{P} = b^\mathcal{P}$, i.e., all orbits forms a partition of Ω ;
- (2) \mathcal{P}_a is a subgroup of \mathcal{P} and if $b = a^x$, then $\mathcal{P}_b = x^{-1}\mathcal{P}_ax$. Moreover, if $a^x = b^y$, then $x\mathcal{P}_a = y\mathcal{P}_a$;
- (3) $|a^\mathcal{P}| = |\mathcal{P} : \mathcal{P}_a|$, particularly, if \mathcal{P} is finite, then $|\mathcal{P}| = |\mathcal{P}_a||a^\mathcal{P}|$ for $\forall a \in \Omega$.

Proof If $c \in a^\mathcal{P}$, then there is $z \in \mathcal{P}$ such that $c = a^z$. Whence,

$$c^\mathcal{P} = \{c^x \mid x \in \mathcal{P}\} = \{a^{zx} \mid x \in \mathcal{P}\} = a^\mathcal{P}.$$

So $a^\mathcal{P} \cap b^\mathcal{P} = \emptyset$ or $a^\mathcal{P} = b^\mathcal{P}$. Notice that an element $a \in \mathcal{P}$ lies in at least one orbit $a^\mathcal{P}$, we know that all orbits forms a partition of the set Ω . This proves (1).

For (2), it is clear that $1_\mathcal{P} \in \mathcal{P}_a$ and for $x, y \in \mathcal{P}_a$, $xy^{-1} \in \mathcal{P}_a$. So \mathcal{P}_a is a subgroup of \mathcal{P} by Theorem 1.2.2. Now if $b = a^x$, then we know that

$$y \in \mathcal{P}_b \Leftrightarrow a^{xy} = a^x \Leftrightarrow xyx^{-1} \in \mathcal{P}_a,$$

i.e., $y \in x^{-1}\mathcal{P}_ax$, Whence, $x^{-1}\mathcal{P}_ax = \mathcal{P}_b$. Finally,

$$a^x = a^y \Leftrightarrow a^{xy^{-1}} = a \Leftrightarrow xy^{-1} \in \mathcal{P}_a \Leftrightarrow x\mathcal{P}_a = y\mathcal{P}_a.$$

So (2) is proved.

Applying the conclusion (2), we know that there is a bijection between the distinct elements in $a^\mathcal{P}$ and right cosets of \mathcal{P}_a in \mathcal{P} . Therefore $|a^\mathcal{P}| = |\mathcal{P} : \mathcal{P}_a|$. Particularly, if \mathcal{P} is finite, then $|a^\mathcal{P}| = |\mathcal{P} : \mathcal{P}_a| = |\mathcal{P}|/|\mathcal{P}_a|$. So we get that $|\mathcal{P}| = |\mathcal{P}_a||a^\mathcal{P}|$. \square

Now let $\Delta \subset \Omega$. We define the *pointwise stabilizer* and *setwise stabilizer* respectively by

$$\mathcal{P}_{(\Delta)} = \{ \sigma \mid a^\sigma = a, a \in \Delta \text{ and } \sigma \in \mathcal{P} \}$$

and

$$\mathcal{P}_{\{\Delta\}} = \{ \sigma \mid \Delta^\sigma = \Delta, \sigma \in \mathcal{P} \}.$$

It is clear that $\mathcal{P}_{(\Delta)}$ and $\mathcal{P}_{\{\Delta\}}$ are subgroups of \mathcal{P} . By definition, we know that

$$\mathcal{P}_{(\Delta)} = \bigcap_{a \in \Delta} \mathcal{P}_a,$$

and

$$\mathcal{P}_{(\Delta_1 \cup \Delta_2)} = \mathcal{P}_{(\Delta_1)} \bigcap \mathcal{P}_{(\Delta_2)} = (\mathcal{P}_{(\Delta_1)})_{(\Delta_2)}.$$

Applying Theorem 2.1.1, for $a, b \in \Omega$ we also know that

$$|\mathcal{P} : \mathcal{P}_{a,b}| = |a^\mathcal{P}| |b^{\mathcal{P}_a}| = |b^\mathcal{P}| |a^{\mathcal{P}_b}|.$$

Clearly, $\mathcal{P}_{(\Delta)} \leq \mathcal{P}_{\{\Delta\}}$. Furthermore, we have the following result.

Theorem 2.1.2 $\mathcal{P}_{(\Delta)} \triangleleft \mathcal{P}_{\{\Delta\}}$.

Proof Let $g \in \mathcal{P}_{(\Delta)}$ and $h \in \mathcal{P}_{\{\Delta\}}$. We prove that $h^{-1}gh \in \mathcal{P}_{(\Delta)}$. In fact, let $a \in \Delta$, we know that $a^{h^{-1}} \in \Delta$. Therefore,

$$a^{h^{-1}gh} = [(a^{h^{-1}})^g]^h = [a^{h^{-1}}]^h = a.$$

Whence, $h^{-1}gh \in \mathcal{P}_{(\Delta)}$. □

2.1.3 Burnside Lemma. For counting the number of orbital sets $Orb(\Omega)$ of Ω under the action of \mathcal{P} , the following result, usually called *Burnside Lemma* is useful.

Theorem 2.1.3(Cauchy-Frobenius Lemma) *Let \mathcal{P} be a permutation group action on Ω . Then*

$$|Orb(\Omega)| = \frac{1}{|\mathcal{P}|} \sum_{x \in \mathcal{P}} |fix(x)|,$$

where $fix(x) = \{a \in \Omega \mid a^x = a\}$.

Proof Define a set $\mathcal{A} = \{(a, x) \in \Omega \times \mathcal{P} \mid a^x = a\}$. We count the number of elements of \mathcal{A} in two ways. Assuming the orbits of Ω under the action of \mathcal{P} are $\Omega_1, \Omega_2, \dots, \Omega_{|Orb(\Omega)|}$.

Applying Theorem 2.1.1(3), we get that

$$\begin{aligned} |\mathcal{A}| &= \sum_{i=1}^{|Orb(\Omega)|} \sum_{a \in \Omega_i} |\mathcal{P}_a| \\ &= \sum_{i=1}^{|Orb(\Omega)|} \sum_{a \in \Omega_i} \frac{|\mathcal{P}|}{|\Omega_i|} = \sum_{i=1}^{|Orb(\Omega)|} |\mathcal{P}| = |Orb(\Omega)| |\mathcal{P}|. \end{aligned}$$

By definition, $|\mathcal{A}| = \sum_{x \in \mathcal{P}} |f x(x)|$. Therefore,

$$|Orb(\Omega)| = \frac{1}{|\mathcal{P}|} \sum_{x \in \mathcal{P}} |f x(x)|.$$

This completes the proof. \square

Notice that $|f x(x)|$ remains constant on each conjugacy class of \mathcal{P} , we get the following conclusion by Theorem 2.1.3.

Corollary 2.1.1 *Let \mathcal{P} be a permutation group action on Ω with conjugacy classes C_1, C_2, \dots, C_k . Then*

$$|Orb(\Omega)| = \frac{1}{|\mathcal{P}|} \sum_{i=1}^k |C_i| |f x(x_i)|,$$

where $x_i \in C_i$.

Example 2.1.1 Let $\mathcal{P} = \{\sigma_1, \sigma_2, \sigma_3, \sigma_4, \sigma_5, \sigma_6, \sigma_7, \sigma_8\}$ be a permutation group action on $\Omega = \{1, 2, 3, 4, 5, 6, 7, 8\}$, where

$$\begin{aligned} \sigma_1 &= 1_{\mathcal{P}}, & \sigma_2 &= (1, 4, 3, 2)(5, 8, 7, 6), \\ \sigma_3 &= (1, 3)(2, 4)(5, 7)(6, 8), & \sigma_4 &= (1, 2, 3, 4)(5, 6, 7, 8), \\ \sigma_5 &= (1, 7, 3, 5)(2, 6, 4, 8), & \sigma_6 &= (1, 8, 3, 6)(2, 7, 4, 5), \\ \sigma_7 &= (1, 5, 3, 7)(2, 8, 4, 6), & \sigma_8 &= (1, 6, 3, 8)(2, 5, 4, 7). \end{aligned}$$

Calculation shows that

$$f x(1) = f x(2) = f x(3) = f x(4) = f x(5) = f x(6) = f x(7) = f x(8) = \{1_{\mathcal{P}}\},$$

Applying Theorem 2.1.3, the number of orbits of Ω under the action of \mathcal{P} is

$$|Orb(\Omega)| = \frac{1}{|\mathcal{P}|} \sum_{x \in \mathcal{P}} |f x(x)| = \frac{1}{8} \times \sum_{i=1}^8 1 = 1.$$

In fact, for $\forall i \in \Omega$, the orbit of i under the action of \mathcal{P} is

$$i^{\mathcal{P}} = \{1, 2, 3, 4, 5, 6, 7, 8\}.$$

§2.2 TRANSITIVE GROUPS

2.2.1 Transitive Group. A permutation group \mathcal{P} action on Ω is *transitive* if for $x, y \in \Omega$, there exists a permutation $\pi \in \mathcal{P}$ such that $x^\pi = y$. Whence, a transitive group \mathcal{P} only has

one orbit, i.e., Ω under the action of \mathcal{P} . A permutation group \mathcal{P} which is not transitive is called *intransitive*. According to Theorem 2.1.1, we get the following result for transitive groups.

Theorem 2.2.1 *Let \mathcal{P} be a transitive group acting on Ω , $a \in \Omega$. Then $|\mathcal{P}| = |\Omega||\mathcal{P}_a|$, i.e., $|\mathcal{P} : \mathcal{P}_a| = |\Omega|$.*

A permutation group \mathcal{P} action on Ω is said to be *semi-regular* if $\mathcal{P}_a = \{1_{\mathcal{P}}\}$ for $\forall a \in \Omega$. Furthermore, if \mathcal{P} is transitive, Such a semi-regular group is called *regular*.

Corollary 2.2.1 *Let \mathcal{P} be a regular group action on Ω . Then $|\mathcal{P}| = |\Omega|$.*

Particularly, we know the following result for Abelian transitive groups.

Theorem 2.2.2 *Let \mathcal{P} be a transitive group action on Ω . If it is Abelian group, it must be regular.*

Proof Let $a \in \Omega$ and $\pi \in \mathcal{P}$. Then $(\mathcal{P}_a)^\pi = \mathcal{P}_{a^\pi}$ by Theorem 2.1.1(2). But $\mathcal{P}_a \triangleleft \mathcal{P}$ because \mathcal{P} is Abelian. We know that $\mathcal{P}_a = \mathcal{P}_{a^\pi}$ for $\forall \pi \in \mathcal{P}$. By assumption, \mathcal{P} is transitive. It follows that if $a^\pi = a$, then $b^\pi = b$ for $\forall b \in \Omega$. Thus $\mathcal{P}_a = \{1_{\mathcal{P}}\}$. \square

2.2.2 Multiply Transitive Group. Let \mathcal{P} be a permutation group acting on $\Omega = \{a_1, a_2, \dots, a_n\}$ and

$$\Omega^k = \{(a_1, a_2, \dots, a_k) | a_i \in \Omega, 1 \leq i \leq k\}.$$

Define \mathcal{P} act on Ω^k by

$$(a_1, a_2, \dots, a_k)^\pi = (a_1^\pi, a_2^\pi, \dots, a_k^\pi), \quad \pi \in \mathcal{P}.$$

If \mathcal{P} acts transitive on Ω^k , then \mathcal{P} is said to be *k-transitive* on Ω . The following result is a criterion on multiply transitive groups.

Theorem 2.2.3 *For an integer $k > 1$, a transitive permutation group \mathcal{P} acting on Ω is k-transitive if and only if for a fixed element $a \in \Omega$, \mathcal{P}_a is $(k-1)$ -transitive on $\Omega \setminus \{a\}$.*

Proof Assume that \mathcal{P} is k-transitive acting on Ω and

$$(a_1, a_2, \dots, a_{k-1}), (b_1, b_2, \dots, b_{k-1}) \in \Omega \setminus \{a\}.$$

Then $a_i \neq a \neq b_i$ for $1 \leq i \leq k-1$. Notice that \mathcal{P} is k-transitive. There is a permutation π such that

$$(a_1, a_2, \dots, a_{k-1}, a)^\pi = (b_1, b_2, \dots, b_{k-1}, a).$$

Thus π fixes a and maps $(a_1, a_2, \dots, a_{k-1})$ to $(b_1, b_2, \dots, b_{k-1})$, which shows that \mathcal{P}_a acts $(k-1)$ -transitively on $\Omega \setminus \{a\}$.

Conversely, let \mathcal{P}_a is $(k-1)$ -transitive on $\Omega \setminus \{a\}$, $(a_1, a_2, \dots, a_k), (b_1, b_2, \dots, b_k) \in \Omega^k$. By the transitivity of \mathcal{P} acting on Ω , there exist elements $\pi, \pi' \in \mathcal{P}$ such that $a_1^\pi = a$ and $b_1^{\pi'} = a$. Because \mathcal{P}_a is $(k-1)$ -transitive on $\Omega \setminus \{a\}$, there is an element $\sigma \in \mathcal{P}_a$ such that

$$((a_2^\pi)^\sigma, \dots, (a_k^\pi)^\sigma) = (b_2^{\pi'^{-1}}, \dots, b_k^{\pi'^{-1}}).$$

Whence, $a_i^{\pi\sigma} = b_i^{\pi'^{-1}}$, i.e., $a_i^{\pi\sigma\pi'} = b_i$ for $2 \leq i \leq k$. Since $\sigma \in \mathcal{P}_a$, we know that $a_1^{\pi\sigma\pi'} = a_1^{\sigma\pi'} = a_1^{\pi'} = b_1$. Therefore, the element $\pi\sigma\pi'$ maps (a_1, a_2, \dots, a_k) to (b_1, b_2, \dots, b_k) . \square

A simple calculation shows that

$$|\Omega^k| = n(n-1) \cdots (n-k+1).$$

Applying Theorems 2.2.1 and 2.2.3, we get the next conclusion.

Theorem 2.2.4 *Let \mathcal{P} be k -transitive on Ω . Then*

$$n(n-1) \cdots (n-k+1) \mid |\mathcal{P}|.$$

2.2.3 Sharply k -Transitive Group. A transitive group \mathcal{P} on Ω is said to be *sharply k -transitive* if \mathcal{P} acts regularly on Ω^k , i.e., for two k -tuples in Ω^k , there is a unique permutation in \mathcal{P} mapping one k -tuple to another. The following is an immediately conclusion by Theorem 2.1.1.

Theorem 2.2.5 *A k -transitive group \mathcal{P} acting on Ω with $|\Omega| = n$ is sharply k -transitive if and only if $|\mathcal{P}| = n(n-1) \cdots (n-k+1)$.*

These symmetric and alternating groups are examples of multiply transitive groups shown in the following.

Theorem 2.2.6 *Let $n \geq 1$ be an integer and $\Omega = \{1, 2, \dots, n\}$. Then*

- (1) S_Ω is sharply n -transitive;
- (2) If $n \geq 3$, the alternating group A_Ω is sharply $(n-2)$ -transitive group of degree n .

Proof For the claim (1), it is obvious by definition. We prove the claim (2). First, it is easy to find that A_Ω is transitive. Notice that if $\Omega = \{1, 2, 3\}$, A_Ω is generated by $(1, 2, 3)$. It is regular and therefore sharply 1-transitive. Whence, the claim is true for $n = 3$. Now

assume this claim is true for all integers $< n$. Let $n \geq 4$ and define H to be the stabilizer of n . Then H acts on the set $\Omega \setminus \{n\}$, produce all even permutations. By induction, H is $(n-3)$ -transitive group on $\Omega \setminus \{n\}$. Applying Theorem 2.2.3, A_Ω is $(n-2)$ -transitive. Thus $|A_\Omega| = \frac{1}{2}(n!) = n(n-1) \cdots 3$. By Theorem 2.2.5, it is sharply $(n-2)$ -transitive. \square

More sharply multiply transitive groups are shown following. The reader is referred to references [DiM1] and [Rob1] for their proofs.

Sharply 2, 3-transitive group. Let F be a Galois field $GF(q)$ with $q = p^m$ for a prime number p . Define $X = F \cup \{\infty\}$ and think it as the projective line consisting of $q+1$ lines. Let $L(q)$ be the set of all functions $f : X \rightarrow X$ of the form

$$f(x) = \frac{ax + b}{cx + d}$$

for $a, b, c, d \in F$ with $ad - bc \neq 0$, where the symbol ∞ is subject to rules $x + \infty = \infty$, $\infty/\infty = 1$, etc. Then it is easily to verify that $L(q)$ is a group under the functional composition. Define $H(q)$ to be the stabilizer of ∞ in $L(q)$, which is consisting of all functions $x \rightarrow ax + b$, $a \neq 0$. Then $H(q)$ is sharply 2-transitive on $GF(q)$ of degree q and $L(q)$ is sharply 3-transitive on $F \cup \{\infty\}$ of degree $q+1$.

Particularly, if $c = d = 0$, i.e., for a linear transformation a and a vector $\bar{v} \in F^d$, we define the *affine transformation*

$$t_{a, \bar{v}} : F^d \rightarrow F^d \text{ by } t_{a, \bar{v}} : \bar{u} \rightarrow \bar{u}a + \bar{v}.$$

Then the set of all $t_{a, \bar{v}}$ form the *affine group* $AGL_d(q)$ of dimensional $d \geq 1$.

Sharply 4, 5-transitive group Let $\Omega = \{1, 2, 3, \dots, 11, 12\}$ and

$$\begin{aligned} \varphi &= (4, 5, 6)(7, 8, 9)(10, 11, 12), & \chi &= (4, 7, 10)(5, 8, 11)(6, 9, 12), \\ \psi &= (5, 7, 6, 10)(8, 9, 12, 11), & \omega &= (5, 8, 6, 12)(7, 11, 10, 9), \\ \pi_1 &= (1, 4)(7, 8)(9, 11)(10, 12), & \pi_2 &= (1, 2)(7, 10)(8, 11)(9, 12); \\ \pi_3 &= (2, 3)(7, 12)(8, 10)(9, 11). \end{aligned}$$

Define $M_{11} = \langle \varphi, \chi, \psi, \omega, \pi_1, \pi_2, \pi_3 \rangle$ and $M_{12} = \langle \varphi, \chi, \psi, \omega, \pi_1, \pi_2 \rangle$, called Mathieu groups. Then M_{11} is sharply 5-transitive of degree 12 with order 95040, and M_{12} is sharply 4-transitive of degree 11 on $\Omega \setminus \{3\}$ with order 7920.

Theorem 2.2.7(Jordan) *For an integer $k \geq 4$, let \mathcal{P} be a sharply k -transitive group of degree n which is neither symmetric nor alternating groups. Then either $k = 4$ and $n = 11$, or $k = 5$ and $n = 12$.*

Combining Examples 2.2.1, 2.2.2 with Theorem 2.2.7, we know that there are sharply k -transitive group of finite degree if and only if $1 \leq k \leq 5$.

§2.3 AUTOMORPHISMS OF GROUPS

2.3.1 Automorphism Group. An automorphism of a group $(\mathcal{G}; \circ)$ is an isomorphism from \mathcal{G} to \mathcal{G} . All automorphisms of a group form a group under the functional composition, i.e., $\theta\zeta(x) = \theta(\zeta(x))$ for $x \in \mathcal{G}$. Denoted by $\text{Aut}\mathcal{G}$, which is a permutation group action on \mathcal{G} itself. We discuss this kind of permutation groups in this section.

Example 2.3.1 Let $\mathcal{G} = \{e, a, b, c\}$ be an Abelian 4-group with operation \cdot determined by the following table.

\cdot	e	a	b	c
e	e	a	b	c
a	a	e	c	b
b	b	c	e	a
c	c	b	a	e

Table 2.3.1

We determine the automorphism group $\text{Aut}\mathcal{G}$. Notice that e is the identity element of \mathcal{G} . By property (H1) of homomorphism, if θ is an automorphism on \mathcal{G} , then $\theta(e) = e$. Whence, there are six cases for possible θ following:

$$\theta_1 = \begin{pmatrix} e & a & b & c \\ e & a & b & c \end{pmatrix}, \quad \theta_2 = \begin{pmatrix} e & a & b & c \\ e & a & c & b \end{pmatrix},$$

$$\theta_3 = \begin{pmatrix} e & a & b & c \\ e & b & a & c \end{pmatrix}, \quad \theta_4 = \begin{pmatrix} e & a & b & c \\ e & b & c & a \end{pmatrix},$$

$$\theta_5 = \begin{pmatrix} e & a & b & c \\ e & c & a & b \end{pmatrix}, \quad \theta_6 = \begin{pmatrix} e & a & b & c \\ e & c & b & a \end{pmatrix}.$$

It is easily to check that all these θ_i , $1 \leq i \leq 6$ are automorphisms of $(\mathcal{G}; \cdot)$. We get the automorphism group

$$\text{Aut}\mathcal{G} = \{\theta_1, \theta_2, \theta_3, \theta_4, \theta_5, \theta_6\}.$$

Let $x, g \in \mathcal{G}$. An element $x^g = g^{-1} \circ x \circ g$ is called the *conjugate* of x by g . Define a mapping $g^\tau : \mathcal{G} \rightarrow \mathcal{G}$ by $g^\tau(x) = x^g$. Then $(x \circ y)^g = x^g \circ y^g$ and $g^\tau(g^{-1})^\tau = 1_{\text{Aut}\mathcal{G}} = (g^{-1})^\tau g^\tau$. So $g^\tau \in \text{Aut}\mathcal{G}$, i.e., an automorphism on $(\mathcal{G}; \circ)$. Such an automorphism g^τ is called the *inner automorphism* of $(\mathcal{G}; \circ)$ induced by g . It is easily to check that all such inner automorphisms form a subgroup of $\text{Aut}\mathcal{G}$, denoted by $\text{Inn}\mathcal{G}$.

Theorem 2.3.1 *Let $(\mathcal{G}; \circ)$ be a group. Then the mapping $\tau : \mathcal{G} \rightarrow \text{Aut}\mathcal{G}$ defined by $\tau(x) = g^\tau(x) = x^g$ for $\forall x \in \mathcal{G}$ is a homomorphism with image $\text{Inn}\mathcal{G}$ and kernel the set of elements commuting with every element of \mathcal{G} .*

Proof By definition, we know that $x^{(g \circ h)^\tau} = (g \circ h)^{-1} \circ x \circ (g \circ h) = h^{-1} \circ g^{-1} \circ x \circ g \circ h = (x^{g^\tau})^{h^\tau}$. So $(g \circ h)^\tau = g^\tau h^\tau$, which means that τ is a homomorphism.

Notice that $g^\tau = 1_{\text{Aut}\mathcal{G}}$ is equivalent to $g^{-1} \circ x \circ g = x$ by definition. Namely, $g \circ x = x \circ g$ for $\forall x \in \mathcal{G}$. This completes the proof. \square

Definition 2.3.1 *The center $Z(\mathcal{G})$ of a group $(\mathcal{G}; \circ)$ is defined by*

$$Z(\mathcal{G}) = \{x \in \mathcal{G} \mid x \circ g = g \circ x \text{ for all } g \in \mathcal{G}\}.$$

Then Theorem 2.3.1 can be restated as follows.

Theorem 2.3.2 *Let $(\mathcal{G}; \circ)$ be a group. Then $Z(\mathcal{G}) \triangleleft \mathcal{G}$ and $\mathcal{G}/Z(\mathcal{G}) \simeq \text{Inn}\mathcal{G}$.*

The properties of inner automorphism group $\text{Inn}\mathcal{G}$ induced it to be a normal subgroup of $\text{Aut}\mathcal{G}$ following.

Theorem 2.3.3 *Let $(\mathcal{G}; \circ)$ be a group. Then $\text{Inn}\mathcal{G} \triangleleft \text{Aut}\mathcal{G}$.*

Proof Let $g \in \mathcal{G}$ and $h \in \text{Aut}\mathcal{G}$. Then for $\forall x \in \mathcal{G}$,

$$\begin{aligned} hg^\tau h^{-1}(x) &= hg^\tau(h^{-1}(x)) = h(g^{-1} \circ h^{-1}(x) \circ g) \\ &= h^{-1}(g) \circ x \circ h(g) = x^{h(g)} \in \text{Inn}\mathcal{G}. \end{aligned}$$

Whence, $\text{Inn}\mathcal{G} \triangleleft \text{Aut}\mathcal{G}$. □

Definition 2.3.2 The quotient group $\text{Aut}\mathcal{G}/\text{Inn}\mathcal{G}$ is usually called the outer automorphism group of a group $(\mathcal{G}; \circ)$.

Similarly, we can also consider the conjugating relation between subgroups of a group.

Definition 2.3.3 Let $(\mathcal{G}; \cdot)$ be a group, $\mathcal{H}, \mathcal{H}' \triangleleft \mathcal{G}$. Then \mathcal{H}' is conjugated to \mathcal{H} if there is $x \in \mathcal{G}$ such that

$$x^{-1} \cdot \mathcal{H} \cdot x = \mathcal{H}'.$$

Definition 2.3.4 Let $(\mathcal{G}; \circ)$ be a group, $\mathcal{H} \triangleleft \mathcal{G}$. The normalizer $N_{\mathcal{G}}(\mathcal{H})$ of \mathcal{H} in $(\mathcal{G}; \circ)$ is defined by

$$N_{\mathcal{G}}(\mathcal{H}) = \{ x \in \mathcal{G} \mid x^{-1} \circ \mathcal{H} \circ x = \mathcal{H} \}.$$

Theorem 2.3.4 The set of conjugates of \mathcal{H} in \mathcal{G} has cardinality $|\mathcal{G} : N_{\mathcal{G}}(\mathcal{H})|$.

Proof Notice that $|\mathcal{G} : N_{\mathcal{G}}(\mathcal{H})|$ is the number of left cosets of $N_{\mathcal{G}}(\mathcal{H})$ in \mathcal{G} . Now if $a^{-1} \circ \mathcal{H} \circ a = b^{-1} \circ \mathcal{H} \circ b$, then

$$b \circ a^{-1} \circ \mathcal{H} \circ a \circ b^{-1} = \mathcal{H}.$$

That is,

$$(a \circ b)^{-1} \circ \mathcal{H} \circ (a \circ b) = \mathcal{H}.$$

By definition, $a \circ b \in N_{\mathcal{G}}(\mathcal{H})$. This completes the proof. □

Definition 2.3.5 Let $(\mathcal{G}; \circ)$ be a group, $\mathcal{H} \triangleleft \mathcal{G}$ and $a, b \in \mathcal{G}$. If there is an element $x \in \mathcal{G}$ such that $x^{-1} \circ a \circ x = b$, a and b is called to be conjugacy. The centralizer $Z_{\mathcal{G}}(a)$ of a in \mathcal{G} is defined by

$$Z_{\mathcal{G}}(a) = \{ \{ g \in \mathcal{G} \mid g^{-1} \circ a \circ g = a \} \}.$$

It is easily to check that $Z_{\mathcal{G}}(a)$ is a subgroup of \mathcal{G} .

Theorem 2.3.5 Let $(\mathcal{G}; \circ)$ be a group and $a \in \mathcal{G}$. Then the number of conjugacy elements to a in \mathcal{G} is $|\mathcal{G} : Z_{\mathcal{G}}(a)|$.

Proof We only need to prove that if $x^{-1} \circ a \circ x = y^{-1} \circ a \circ y$, then $x \circ y^{-1} \in Z_{\mathcal{G}}(a)$. In fact, if $x^{-1} \circ a \circ x = y^{-1} \circ a \circ y$, then $y \circ x^{-1} \circ a \circ x \circ y^{-1} = a$, i.e., $(x \circ y^{-1})^{-1} \circ a \circ (x \circ y^{-1}) = a$. Therefore, $x \circ y^{-1} \in Z_{\mathcal{G}}(a)$. □

A relation between the center and normalizer of subgroup of a group is determined in the next result.

Theorem 2.3.6 Let $(\mathcal{G}; \circ)$ be a group, $\mathcal{H} \leq \mathcal{G}$. Then $Z(\mathcal{H}) \triangleleft N_{\mathcal{G}}(\mathcal{H})$.

Proof If $g \in N_{\mathcal{G}}(\mathcal{H})$, let g^{τ} denote the mapping $h \rightarrow g^{-1} \circ h \circ g$. It is clear an automorphism of \mathcal{H} . Furthermore, $\tau : N_{\mathcal{G}}(\mathcal{H}) \rightarrow \text{Aut } \mathcal{H}$ is a homomorphism with kernel $Z(\mathcal{H})$. Then this result follows from Theorem 1.3.3. \square

2.3.2 Characteristic Subgroup. Let $(\mathcal{G}; \circ)$ be a group, $\mathcal{H} \leq \mathcal{G}$ and $g \in \text{Aut } \mathcal{G}$. By definition, there must be $g(\mathcal{H}) \simeq \mathcal{H}$ but $g(\mathcal{H}) \neq \mathcal{H}$ in general. If $g(\mathcal{H}) = \mathcal{H}$ for $\forall g \in \text{Aut } \mathcal{G}$, then such a subgroup is particular and called a *characteristic subgroup* of $(\mathcal{G}; \circ)$. For example, the center of a group is in fact a characteristic subgroup by Definition 2.3.1.

According to the definition of normal subgroup, For $\forall h \in \text{Inn } \mathcal{G}$, a subgroup \mathcal{H} of a group $(\mathcal{G}; \circ)$ is normal if and only if $h(\mathcal{H}) = \mathcal{H}$ for $\forall h \in \text{Inn } \mathcal{G}$. So a characteristic subgroup must be a normal subgroup. But the converse is not always true.

Example 2.3.2 Let $\mathcal{D}_8 = \{e, a, a^2, a^3, b, b \cdot a, b \cdot a^2, b \cdot a^3\}$ be a dihedral group of order 8 with an operation \cdot determined by the following table.

\cdot	e	a	a^2	a^3	b	$a \cdot b$	$a^2 \cdot b$	$a^3 \cdot b$
e	e	a	a^2	a^3	b	$a \cdot b$	$a^2 \cdot b$	$a^3 \cdot b$
a	a	a^2	a^3	e	$a \cdot b$	$a^2 \cdot b$	$a^3 \cdot b$	b
a^2	a^2	a^3	e	a	$a^2 \cdot b$	$a^3 \cdot b$	b	$a \cdot b$
a^3	a^3	e	a	a^2	$a^3 \cdot b$	b	$a \cdot b$	$a^2 \cdot b$
b	b	$a^3 \cdot b$	$a^2 \cdot b$	$a \cdot b$	a^2	a	e	a^3
$a \cdot b$	$a \cdot b$	b	$a^3 \cdot b$	$a^2 \cdot b$	a^3	a^2	a	e
$a^2 \cdot b$	$a^2 \cdot b$	$a \cdot b$	b	$a^3 \cdot b$	e	a^3	a^2	a
$a^3 \cdot b$	$a^3 \cdot b$	$a^2 \cdot b$	$a \cdot b$	b	a	e	a^3	a^2

Table 2.3.2

Notice that all subgroups of \mathcal{D}_8 are normal and $\langle a \rangle$ is a unique element of degree 2. So $(\langle a^2 \rangle; \circ)$ is a characteristic subgroup of \mathcal{D}_8 .

Now let $\langle b \rangle = \{e, b, a^2, a^2 \cdot b\}$. Clearly, it is a subgroup of \mathcal{D}_8 . We prove it is not a characteristic subgroup of \mathcal{D}_8 . In fact, let $\phi : \mathcal{D} \rightarrow \mathcal{D}$ be a one-to-one mapping defined by

$$e \rightarrow e, \quad a \rightarrow a, \quad a^2 \rightarrow a^2, \quad a^3 \rightarrow a^3,$$

$$b \rightarrow a \cdot b, \quad a \cdot b \rightarrow a^2 \cdot b, \quad a^2 \cdot b \rightarrow a^3 \cdot b, \quad a^3 \cdot b \rightarrow b.$$

Then ϕ is an automorphism. But

$$\phi(\langle b \rangle) = \{e, a \cdot b, a^2 \cdot b, a^3 \cdot b\} \neq \langle b \rangle.$$

Therefore, it is not a characteristic subgroup of \mathcal{D}_8 .

The following result is clear by definition.

Theorem 2.3.7 *If $\mathcal{G}_1 \leq \mathcal{G}$ is a characteristic subgroup of \mathcal{G} and $\mathcal{G}_2 \leq \mathcal{G}_1$ a characteristic subgroup of \mathcal{G}_1 , then \mathcal{G}_2 is also a characteristic subgroup of \mathcal{G} .*

2.3.3 Commutator Subgroup. Let $(\mathcal{G}; \circ)$ be a group and $a, b \in \mathcal{G}$. The element

$$[a, b] = a^{-1} \circ b^{-1} \circ a \circ b$$

is called the *commutator* of a and b . Obviously, a group $(\mathcal{G}; \circ)$ is commutative if and only if $[a, b] = 1_{\mathcal{G}}$ for $\forall a, b \in \mathcal{G}$. The *commutator subgroup* is generated by all commutators of $(\mathcal{G}; \circ)$, denoted by \mathcal{G}' or $[\mathcal{G}, \mathcal{G}]$, i.e.,

$$\mathcal{G}' = \langle [a, b] \mid a, b \in \mathcal{G} \rangle.$$

Theorem 2.3.8 $[S_n, S_n] = A_n$.

Proof Notice that we can always represent a permutation by product of involutions. By the definition of commutator, it is obvious that $[S_n, S_n] \subset A_n$. Now for $\forall g \in A_n$ we can always write it as $g = (a_{s_{11}}, a_{s_{21}})(a_{s_{12}}, a_{s_{22}}) \cdots (a_{s_{1m}}, a_{s_{2m}})$ with $m \equiv 0 \pmod{2}$ by definition, where $a_{s_{ij}} \in \{1, 2, \dots, n\}$ for $i = 1, 2$ and $1 \leq j \leq m$. Calculation shows that

$$(i, j)(j, k) = (j, k)(i, j)(j, k)(i, j) = [(j, k), (i, j)]$$

if $i \neq j, j \neq k$ and

$$(i, j)(k, l) = (i, j)(j, k)(j, k)(k, l) = [(j, k), (i, j)][(k, l), (j, k)]$$

if i, j, k, l are all distinct. Whence, each element in A_n can be written as a product of elements in $[S_n, S_n]$, i.e., $A_n \subset [S_n, S_n]$. \square

A commutator subgroup is always a characteristic subgroup, such as those shown in the next result.

Theorem 2.3.9 Any commutator subgroup of a group $(\mathcal{G}; \circ)$ is a characteristic subgroup.

Proof Let $\phi \in \mathcal{G}$. We prove $\phi(\mathcal{G}') = \mathcal{G}'$. In fact, for $\forall a, b \in \mathcal{G}$, we know that

$$\begin{aligned}\phi([a, b]) &= \phi(a^{-1} \circ b^{-1} \circ a \circ b) \\ &= \phi(a^{-1}) \circ \phi(b^{-1}) \circ \phi(a) \circ \phi(b) \\ &= \phi^{-1}(a) \circ \phi^{-1}(b) \circ \phi(a) \circ \phi(b) = [\phi(a), \phi(b)].\end{aligned}$$

Whence, \mathcal{G}' is a characteristic subgroup of $(\mathcal{G}; \circ)$. □

Corollary 2.3.1 Any non-commutative group $(\mathcal{G}; \circ)$ has a non-trivial characteristic subgroup.

Proof If $(\mathcal{G}; \circ)$ is non-commutative, then there are elements $a, b \in \mathcal{G}$ such that $[a, b] \neq 1_{\mathcal{G}}$. Whence, it has a non-trivial characteristic subgroup \mathcal{G}' at least. □

The most important properties of commutator subgroups is the next.

Theorem 2.3.10 Let $(\mathcal{G}; \circ)$ be a group. Then

- (1) The quotient group \mathcal{G}/\mathcal{G}' is commutative;
- (2) The quotient group \mathcal{G}/\mathcal{H} is commutative for $\mathcal{H} \triangleleft \mathcal{G}$ if and only if $\mathcal{H} \geq \mathcal{G}'$.

Proof (1) Let $a, b \in \mathcal{G}$. Then

$$\begin{aligned}(a \circ \mathcal{G}')^{-1} \circ (b \circ \mathcal{G}')^{-1} \circ (a \circ \mathcal{G}') \circ (b \circ \mathcal{G}') \\ &= a^{-1} \circ \mathcal{G}' \circ b^{-1} \circ \mathcal{G}' \circ a \circ \mathcal{G}' \circ b \circ \mathcal{G}' \\ &= (a^{-1} \circ b^{-1} \circ a \circ b) \circ \mathcal{G}' = \mathcal{G}'.\end{aligned}$$

Therefore, $a \circ \mathcal{G}' \circ b \circ \mathcal{G}' = b \circ \mathcal{G}' \circ a \circ \mathcal{G}'$.

(2) Notice that \mathcal{G}/\mathcal{H} is commutative if and only if for $a, b \in \mathcal{G}$,

$$a \circ \mathcal{H} \circ b \circ \mathcal{H} = b \circ \mathcal{H} \circ a \circ \mathcal{H}.$$

This equality is equivalent to

$$(a \circ \mathcal{H})^{-1} \circ (b \circ \mathcal{H})^{-1} \circ (a \circ \mathcal{H}) \circ (b \circ \mathcal{H}) = \mathcal{H},$$

i.e., $(a^{-1} \circ b^{-1} \circ a \circ b) \circ \mathcal{H} = \mathcal{H}$. Whence, we find that $[a, b] = a^{-1} \circ b^{-1} \circ a \circ b \in \mathcal{H}$, which means that $\mathcal{H} \geq \mathcal{G}'$. □

§2.4 P-GROUPS

As one applying fields of permutations to abstract groups, we discuss p -groups in this section.

2.4.1 Sylow Theorem. By definition, a Sylow p -subgroup of a group (\mathcal{G}, \circ) with $|\mathcal{G}| = p^\alpha n$, $(p, n) = 1$ is essentially a subgroup with maximum order p^α . Such p -subgroups are important for knowing the structure of finite groups, for example, the structure Theorems 1.4.4-1.4.6 for Abelian groups.

Theorem 2.4.1(Sylow's First Theorem) *Let $(\mathcal{G}; \circ)$ be a finite group, p a prime number and $|\mathcal{G}| = p^\alpha n$, $(p, n) = 1$. Then for any integer i , $1 \leq i \leq \alpha$, there exists a subgroup of order p^i , particularly, the Sylow subgroup always exists.*

Proof The proof is by induction on $|\mathcal{G}|$. Clearly, our conclusion is true for $n = 1$. Assume it is true for all groups of order $\leq p^\alpha n$.

Denoted by z the order of center $\mathcal{Z}(\mathcal{G})$. Notice that $\mathcal{Z}(\mathcal{G})$ is a Abelian subgroup of \mathcal{G} . If $p|z$, there exists an element a of order p by Theorem 1.4.6. So $\langle a \rangle$ is a normal subgroup of \mathcal{G} with order p . We get a quotient group $\mathcal{G}/\langle a \rangle$ with order $p^{\alpha-1}n < n$. By the induction assumption, we know that there are subgroups $P_i/\langle a \rangle$ of order p^i , $i = 1, 2, \dots, \alpha - 1$ in $\mathcal{G}/\langle a \rangle$. So P_i , $i = 1, 2, \dots, \alpha - 1$ are subgroups of order p^{i+1} in \mathcal{G} .

Now if $p \nmid z$, let C_1, C_2, \dots, C_s be conjugacy classes of \mathcal{G} . Notice that $p||\mathcal{G}|$ but $p \nmid z$. By

$$|\mathcal{G}| = |\mathcal{Z}(\mathcal{G})| + \sum_{i=1}^s |C_i|,$$

we know that there must be an integer l , $1 \leq l \leq s$ such that $p \nmid |C_l|$. Let $b \in C_l$. Then

$$N_{\mathcal{G}}(b) = \{g \in \mathcal{G} | g^{-1} \circ b \circ g = b\}$$

is a subgroup of \mathcal{G} with index

$$|\mathcal{G} : N_{\mathcal{G}}(b)| = h_l > 1.$$

Since p^α and $N_{\mathcal{G}}(b) < p^\alpha n$, by the induction assumption we know that there are subgroups of order p^i for $1 \leq i \leq \alpha$ in $N_{\mathcal{G}}(b) \leq \mathcal{G}$. □

Corollary 2.4.1 *Let $(\mathcal{G}; \circ)$ be a finite group and p a prime number. If $p||\mathcal{G}|$, then there are elements of order p in $(\mathcal{G}; \circ)$.*

Theorem 2.4.2(Sylow's Second Theorem) *Let $(\mathcal{G}; \circ)$ be a finite group, p a prime with $p \mid |\mathcal{G}|$. Then*

- (1) *If n_p is the number of Sylow p -subgroups in \mathcal{G} , then $n_p \equiv 1 \pmod{p}$;*
- (2) *All Sylow subgroups are conjugate in $(\mathcal{G}; \circ)$.*

Proof Let P, P_1, P_2, \dots, P_r be all Sylow p -subgroups in \mathcal{G} . Notice that a conjugacy subgroup of Sylow p -subgroup is still a Sylow subgroup of \mathcal{G} . For $\forall a \in \mathcal{G}$, define a permutation

$$\sigma_a = \begin{pmatrix} P & P_1 & \cdots & P_r \\ a^{-1} \circ P \circ a & a^{-1} \circ P_1 \circ a & \cdots & a^{-1} \circ P_r \circ a \end{pmatrix}.$$

and $S_p = \{\sigma_a \mid a \in P\}$. Then S_p is a homomorphic image of P . It is also a p -subgroup.

If P_k is invariant under the action S_p for an integer $1 \leq k \leq r$, then $a \circ P_k = P_k \circ a$ for $\forall a \in P$. Whence, PP_k is a p -subgroup of \mathcal{G} . But P, P_k are Sylow p -subgroups of \mathcal{G} . We get $PP_k = P = P_k$, contradicts to the assumption. So all P_k , $1 \leq k \leq r$ are not invariant under the action of S_p except P . By Theorem 2.1.1, we know that $|P_k^{S_p}| \mid |S_p|$ for $1 \leq k \leq r$. Let $P_{k_1}^{S_p}, P_{k_2}^{S_p}, \dots, P_{k_t}^{S_p}$ be a partition of $\{P_1, P_2, \dots, P_r\}$. Then

$$n_p = 1 + r = 1 + \sum_{i=1}^t |P_{k_i}^{S_p}| \equiv 1 \pmod{p}.$$

This is the conclusion (1).

For the conclusion (2), assume there are s conjugate subgroups to P . Similarly, we know that $s \equiv 1 \pmod{p}$. If there exists another conjugacy class in which there are s_1 Sylow p -subgroups, we can also find $s_1 \equiv 1 \pmod{p}$, a contradiction. So there are just one conjugate class of Sylow p -subgroups. This fact enables us to know that all Sylow subgroups are conjugate in $(\mathcal{G}; \circ)$. \square

Corollary 2.4.2 *Let P be a Sylow p -subgroup of $(\mathcal{G}; \circ)$. Then*

- (1) *$P \triangleleft \mathcal{G}$ if and only if P is uniquely the Sylow p -subgroup of $(\mathcal{G}; \circ)$;*
- (2) *P is uniquely the Sylow p -subgroup of $N_{\mathcal{G}}(P)$.*

Theorem 2.4.3(Sylow's Third Theorem) *Let $(\mathcal{G}; \circ)$ be a finite group, p a prime with $p \mid |\mathcal{G}|$. Then each p -subgroup A is a subgroup of a Sylow p -subgroup of $(\mathcal{G}; \circ)$.*

Proof Let σ_a be the same in the proof of Theorem 2.4.2 and $S_A = \{\sigma_a \mid a \in A\}$. Consider the action of S_A on Sylow p -subgroups $\{P, P_1, \dots, P_r\}$. Similar to the proof of

Theorem 2.4.2(1), we know that $|P_k^{S_A}| \mid |S_A|$ for $1 \leq k \leq r$. Because of $r \equiv 0 \pmod{p}$. Whence, there are at least one orbit with only one Sylow p -subgroups. Let it be P_l . Then for $\forall a \in A$, $a^{-1} \circ P_l \circ a = P_l$. So AP_l is a p -subgroup. Notice that $P_l \leq AP_l$. We get that $AP_l = P_l$, i.e., $A \leq P_l$. \square

2.4.2 Application of Sylow Theorem. Sylow theorems enables one to know the p -subgroup structures of finite groups.

Theorem 2.4.4 *Let P be a Sylow p -subgroup of $(\mathcal{G}; \circ)$. Then*

- (1) *If $N_{\mathcal{G}}(P) \leq \mathcal{H} \leq \mathcal{G}$, then $\mathcal{H} = N_{\mathcal{G}}(\mathcal{H})$;*
- (2) *If $N \triangleleft \mathcal{G}$, then $P \cap N$ is a Sylow p -subgroup of $(N; \circ)$ and PN/N is a Sylow p -subgroup of $(\mathcal{G}/N; \circ)$.*

Proof (1) Let $x \in N_{\mathcal{G}}(\mathcal{H})$. Because $P \leq \mathcal{H} \triangleleft N_{\mathcal{G}}(\mathcal{H})$, we know that $x^{-1} \circ P \circ x \leq \mathcal{H}$. Clearly, P and $x^{-1} \circ P \circ x$ are both Sylow p -subgroup of \mathcal{H} . By Theorem 2.4.2, there is an element $h \in \mathcal{H}$ such that $x^{-1} \circ P \circ x = h^{-1} \circ P \circ h$. Whence, $x \circ h^{-1} \in N_{\mathcal{G}}(P) \leq \mathcal{H}$. So $x \in \mathcal{H}$, i.e., $\mathcal{H} = N_{\mathcal{G}}(\mathcal{H})$.

(2) Notice that PN is a union of cosets $a \circ P$, $a \in N$ and N a union of cosets $b \circ (P \cap N)$, $b \in N$. Now let $a, b \in N$. By

$$a \circ P = b \circ P \Leftrightarrow a^{-1} \circ b \in P \Leftrightarrow a^{-1} \circ b \in N \cap P \Leftrightarrow a \circ N \cap P = b \circ N \cap P,$$

we get that $|N : P \cap N| = |PN : P|$, which is prime to p . Since $N \cap P, NP/N$ are respective p -subgroups of N or \mathcal{G}/N by Theorem 1.2.6, this relation implies that they must be Sylow p -subgroup of N or \mathcal{G}/N . \square

Theorem 2.4.5(Fratini) *Let $N \triangleleft \mathcal{G}$ and P a Sylow p -subgroup of $(N; \circ)$. Then $\mathcal{G} = N_{\mathcal{G}}(P)N$.*

Proof Choose $a \in \mathcal{G}$. Since $N \triangleleft \mathcal{G}$, we know that $a^{-1} \circ P \circ a \leq N$, which implies that $a^{-1} \circ P \circ a$ is also a Sylow p -subgroup of $(N; \circ)$. According to Theorem 2.4.2, there is $b \in N$ such that $b^{-1} \circ (a^{-1} \circ P \circ a) \circ b = P$. Whence, $a \circ b \in N_{\mathcal{G}}(P)$, i.e., $a \in N_{\mathcal{G}}(P)N$. Thus $\mathcal{G} = N_{\mathcal{G}}(P)N$. \square

As we known, a finite group with prime power p^α for an integer α is called a p -group in group theory. For p -groups, we know the following results.

Theorem 2.4.6 *Let $(\mathcal{G}; \circ)$ be a non-trivial p -group. Then $Z(\mathcal{G}) > \{1_{\mathcal{G}}\}$.*

Proof Let $|\mathcal{G}| = p^m$, m an integer and $C_1 = \{1_{\mathcal{G}}\}, C_2, \dots, C_s$ conjugate classes of \mathcal{G} .
By

$$\sum_{i=1}^s |C_i| = |\mathcal{G}| = p^m,$$

we know that $|C_i| = 1$ or a multiple of p by Theorem 2.4.5. But $|C_1| = 1$. Whence, there are at least an integer k , $1 \leq k \leq s$ such that $|C_k| = 1$, i.e., $C_k = \{a\}$. Then $a \in Z(\mathcal{G})$. \square

Theorem 2.4.7 *Let p be a prime number. A group $(\mathcal{G}; \circ)$ of order p or p^2 is Abelian.*

Proof If $|\mathcal{G}| = p$, then $\mathcal{G} = \langle a \rangle$ with $a^p = 1_{\mathcal{G}}$ by Theorem 1.2.6.

Now let $|\mathcal{G}| = p^2$. If there is an element $b \in \mathcal{G}$ with $o(b) = p^2$, then $\mathcal{G} = \langle b \rangle$, a cyclic group of order p^2 by Theorem 1.2.6. If such b does not exist, by Theorem 2.4.6 $Z(\mathcal{G}) > \{1_{\mathcal{G}}\}$, we can always choose $1_{\mathcal{G}} \neq a \in Z(\mathcal{G})$ and $b \in \mathcal{G} \setminus Z(\mathcal{G})$. Then $o(a) = o(b) = p$ by Theorem 1.2.6. We get that $Z(\mathcal{G}) = \langle a \rangle$ and $\mathcal{G}/Z(\mathcal{G}) = \langle b \circ Z(\mathcal{G}) \rangle$. Whence, $\mathcal{G} = \langle a, b \rangle$ with $a \circ b = b \circ a$ and $o(a) = o(b) = p$. So it is Abelian. \square

For groups of order pq or p^2q , we have the following result.

Theorem 2.4.8 *Let p, q be odd prime numbers, $p \neq q$. Then groups $(\mathcal{G}; \circ)$ of order pq or p^2q are not simple groups.*

Proof By Sylow's theorem, we know that there are $n_p \equiv 1 \pmod{p}$ Sylow q -subgroups P in $(\mathcal{G}; \circ)$. Let $n_p = 1 + kp$ for an integer k .

If $|\mathcal{G}| = pq$, $p \geq q$, we get that $p(1 + kp) | pq$, i.e., $1 + kp | q$. So $k = 0$ and there is only one p -subgroup P in $(\mathcal{G}; \circ)$. We know that $P \triangleleft \mathcal{G}$. Similarly, if $p \leq q$, then the Sylow q -subgroup $Q \triangleleft \mathcal{G}$. So a group of order pq is not simple.

If $|\mathcal{G}| = p^2q$ and $p \geq q$, then $1 + kp | q$ implies that $k = 0$, and the only one p -subgroup $P \triangleleft \mathcal{G}$. Otherwise, $p \leq q$, we know $1 + lq | p^2$. Notice that $p \leq q$, we know that $n_q = 1$ or p^2 . But if $n_q = p^2$, i.e., $lq = p^2 - 1$, we get that $q | (p - 1)(p + 1)$. Whence, $q = p + 1$. It is impossible since p and $p + 1$ can not both be prime numbers. So $n_q = 1$. Let Q be the only one Sylow q -subgroup in $(\mathcal{G}; \circ)$. Then $Q \triangleleft \mathcal{G}$. Therefore, a group of order p^2q is not simple. \square

2.4.3 Listing p -Group. For listing p -groups, we need a symbol $\left(\frac{\lambda}{p}\right)$, i.e., the *Legendre symbol* in number theory. For a prime $p \nmid \lambda$, the number $\left(\frac{\lambda}{p}\right)$ is defined by

$$\left(\frac{\lambda}{p}\right) = \begin{cases} 1, & \text{if } x^2 \equiv \lambda \pmod{p} \text{ has solution;} \\ -1, & \text{if } x^2 \equiv \lambda \pmod{p} \text{ has no solution.} \end{cases}$$

We have known that

$$\left(\frac{\lambda}{p}\right) \equiv \lambda^{\frac{p-1}{2}} \pmod{p}$$

and the well-known Gauss reciprocity law

$$\left(\frac{q}{p}\right)\left(\frac{p}{q}\right) = (-1)^{\frac{(p-1)(q-1)}{4}}$$

for prime numbers p and q in number theory, .

Completely list all p -groups is a very difficult work. Today, we can only list those of p -groups with small power. For example, these p -groups of orders p^n for $1 \leq n \leq 4$ are listed in Tables 2.4.1 – 2.4.4 without proofs.

$ \mathcal{G} $	p -group	Abelian?
p	(1) $\langle a \rangle, a^p = 1_{\mathcal{G}}$	Yes
p^2	(1) $\langle a \rangle, a^{p^2} = 1_{\mathcal{G}}$	Yes
	(2) $\langle a, b \rangle, a^p = b^p = 1_{\mathcal{G}}, a \circ b = b \circ a$	Yes
p^3 ($p \neq 2$)	(1) $\langle a \rangle, a^{p^3} = 1_{\mathcal{G}}$	Yes
	(2) $\langle a, b \rangle, a^{p^2} = b^p = 1_{\mathcal{G}}, a \circ b = b \circ a$	Yes
	(3) $\langle a, b, c \rangle, a^p = b^p = c^p = 1_{\mathcal{G}}, a \circ b = b \circ a,$ $a \circ c = c \circ a, b \circ c = c \circ b$	Yes
	(4) $\langle a, b \rangle, a^{p^2} = b^p = 1_{\mathcal{G}}, b^{-1} \circ a \circ b = a^{1+p}$	No
	(5) $\langle a, b, c \rangle, a^p = b^p = c^p = 1_{\mathcal{G}}, a \circ b = b \circ a \circ c,$ $c \circ a = a \circ c, c \circ b = b \circ c$	No

Table 2.4.1

For $p = 2$, these 2-groups of order 2^3 are completely listed in Table 2.4.2.

$ \mathcal{G} $	2-group	Abelian?
2^3	(1) $\langle a \rangle, a^8 = 1_{\mathcal{G}}$	Yes
	(2) $\langle a, b \rangle, a^4 = b^2 = 1_{\mathcal{G}}, a \circ b = b \circ a$	Yes
	(3) $\langle a, b, c \rangle, a^2 = b^2 = c^2 = 1_{\mathcal{G}}, a \circ b = b \circ a,$ $a \circ c = c \circ a, b \circ c = c \circ b$	Yes
	(4) $Q_8 = \langle a, b \rangle, a^4 = 1_{\mathcal{G}}, b^2 = a^2, b^{-1} \circ a \circ b = a^{-1}$	No
	(5) $D_8 = \langle a, b \rangle, a^4 = b^2 = 1_{\mathcal{G}}, b^{-1} \circ a \circ b = a^{-1}$	No

Table 2.4.2

$ \mathcal{G} $	p -group	Abelian?
p^4 $p \neq 2$	(1) $\langle a \rangle, a^4 = 1_{\mathcal{G}}$	Yes
	(2) $\langle a, b \rangle, a^{p^3} = b^p = 1_{\mathcal{G}},$	Yes
	(3) $\langle a, b \rangle, a^{p^2} = b^{p^2} = 1_{\mathcal{G}},$	Yes
	(4) $\langle a, b, c \rangle, a^{p^2} = b^p = c^p = 1_{\mathcal{G}},$	Yes
	(5) $\langle a, b, c, d \rangle, a^p = b^p = c^p = d^p = 1_{\mathcal{G}} \langle a, b \rangle,$ $a^{p^3} = b^p = 1_{\mathcal{G}},$	Yes
p^4 $p \neq 2$	(1) $\langle a, b \rangle, a^{p^3} = b^p = 1_{\mathcal{G}}, b^{-1} \circ a \circ b = a^{1+p^2}$	No
	(2) $\langle a, b \rangle, a^{p^2} = b^{p^2} = 1_{\mathcal{G}}, b^{-1} \circ a \circ b = a^{1+p}$	No
	(3) $\langle a, b, c \rangle, a^{p^2} = b^p = c^p = 1_{\mathcal{G}}, [a, b] = [a, c] = 1_{\mathcal{G}},$ $[b, c] = a^p$	No
	(4) $\langle a, b, c \rangle, a^{p^2} = b^p = c^p = 1_{\mathcal{G}}, [a, b] = [b, c] = 1_{\mathcal{G}},$ $[a, c] = a^p$	No
	(5) $\langle a, b, c \rangle, a^{p^2} = b^p = c^p = 1_{\mathcal{G}}, [a, b] = [a, c] = 1_{\mathcal{G}},$ $[a, c] = b$	No
	(6) $\langle a, b, c \rangle, a^{p^2} = b^p = c^p = 1_{\mathcal{G}}, b^{-1} \circ a \circ b = a^{1+p},$ $c^{-1} \circ a \circ c = a \circ b, c^{-1} \circ b \circ c = b$	No
	(7) $\langle a, b, c \rangle, a^{p^2} = b^p = 1_{\mathcal{G}}, c^p = a^p, b^{-1} \circ a \circ b = a^{1+p},$ $c^{-1} \circ a \circ c = a \circ b, c^{-1} \circ b \circ c = b$	No
	(8) $\langle a, b, c \rangle, a^{p^2} = b^p = 1_{\mathcal{G}}, c^p = a^{\lambda p}, \left(\frac{\lambda}{p}\right) = -1$ $c^{-1} \circ a \circ c = a \circ b, c^{-1} \circ b \circ c = b, b^{-1} \circ a \circ b = a^{1+p},$	No
	(9) $\langle a, b, c, d \rangle, a^{p^2} = b^p = c^p = d^p = 1_{\mathcal{G}}, [c, d] = a,$ $[a, b] = [a, c] = [a, d] = [b, c] = [b, d] = 1_{\mathcal{G}},$	No
	(10-1) $\langle a, b, c, d \rangle, p > 3, a^p = b^p = c^p = d^p = 1_{\mathcal{G}},$ $[a, b] = [a, c] = [a, d] = [b, c] = 1_{\mathcal{G}},$ $d^{-1} \circ b \circ d = a \circ b, d^{-1} \circ c \circ d = b \circ c$	No
(10-2) $\langle a, b, c \rangle, p = 3, a^9 = b^3 = c^3 = 1_{\mathcal{G}}, [a, b] = 1_{\mathcal{G}},$ $c^{-1} \circ a \circ c = a \circ b, c^{-1} \circ b \circ c = a^{-3} \circ b$	No	

Table 2.4.3

For groups of order 2^n , the situation is more complex. For example, there are 6 types for $n = 3$, 14 types for $n = 4$, 31 types for $n = 5$ and 267 types for $n = 6$. Generally, we do not know the relation for the number of types with n . We have listed 2-groups of order

2^3 in Table 2.4.2. Similarly, these non-Abelian 2-groups of order 2^4 are listed in Table 2.4.4 following.

$ \mathcal{G} $	2-group	Abelian?
2^4	(1) $\langle a, b \rangle, a^8 = b^2 = 1_{\mathcal{G}}, b^{-1} \circ a \circ b = a^{-1}$	No
	(2) $\langle a, b \rangle, a^8 = b^2 = 1_{\mathcal{G}}, b^{-1} \circ a \circ b = a^3$	No
	(3) $\langle a, b \rangle, a^8 = b^2 = 1_{\mathcal{G}}, b^{-1} \circ a \circ b = a^5$	No
	(4) $\langle a, b \rangle, a^8 = 1_{\mathcal{G}}, b^2 = a^4, b^{-1} \circ a \circ b = a^{-1}$	No
	(5) $\langle a, b \rangle, a^4 = b^4 = 1_{\mathcal{G}}, b^{-1} \circ a \circ b = a^{-1}$	No
	(6) $\langle a, b, c \rangle, a^4 = b^2 = c^2 = 1_{\mathcal{G}}, b^{-1} \circ a \circ b = a, c^{-1} \circ a \circ c = a, [b, c] = a^2$	No
	(7) $\langle a, b, c \rangle, a^4 = b^2 = c^2 = 1_{\mathcal{G}}, b^{-1} \circ a \circ b = a, c^{-1} \circ a \circ c = a^{-1}, [b, c] = a^2$	No
	(8) $\langle a, b, c \rangle, a^4 = b^2 = 1_{\mathcal{G}}, c^2 = a^2, b^{-1} \circ a \circ b = a, c^{-1} \circ a \circ c = a^{-1}, [b, c] = 1_{\mathcal{G}}$	No
	(9) $\langle a, b, c \rangle, a^4 = b^2 = c^2 = 1_{\mathcal{G}}, b^{-1} \circ a \circ b = a, c^{-1} \circ a \circ c = a \circ b, [b, c] = 1_{\mathcal{G}}$	No

Table 2.4.4

A complete proof for listing results in Tables 2.4.1-2.4.4 can be found in references, for example, [Zha1] or [Xum1].

§2.5 PRIMITIVE GROUPS

2.5.1 Imprimitve Block. Let \mathcal{P} be a permutation group action on Ω . A proper subset $A \subset \Omega, |A| \geq 2$ is called an *imprimitve block* of \mathcal{P} if for $\forall \pi \in \mathcal{P}$, either $A = A^\pi$ or $A \cap A^\pi = \emptyset$. If such blocks A exist, we say \mathcal{P} *imprimitve*. Otherwise, it is called *primitive*, i.e., \mathcal{P} has no imprimitve blocks.

Example 2.5.1 Let \mathcal{P} be a permutation group generated by

$$g = (1, 2, 3, 4, 5, 6) \quad \text{and} \quad h = (2, 6)(3, 5).$$

Notice that \mathcal{P} is transitive on $\Omega = \{1, 2, 3, 4, 5, 6\}$ and $hg = g^5h$. There are only 12

elements with form $g^l h^m$, where $l = 0, 1, 2, 3, 4, 5$ and $m = 0, 1$. Let $A = \{1, 4\}$. Then

$$\begin{aligned} \{1, 4\}^g &= \{2, 5\}, & \{1, 4\}^{g^2} &= \{3, 6\}, \\ \{1, 4\}^{g^3} &= \{1, 4\}, & \{1, 4\}^h &= \{1, 4\}. \end{aligned}$$

Whence, $A^\tau = A$ or $A^\tau \cap A = \emptyset$ for $\forall \tau \in \mathcal{P}$, i.e., A is an imprimitive block.

The following result is followed immediately by Theorem 2.1.1 on primitive groups.

Theorem 2.5.1 *Let \mathcal{P} be a transitive group actin on Ω , A an imprimitive block of \mathcal{P} and H the subgroup of all π in \mathcal{P} such that $A^\pi = A$. Then*

- (1) *The subsets $A^\tau, \tau \in \mathcal{P} : H$ form a partition of Ω ;*
- (2) $|\Omega| = |A||\mathcal{P} : H|$.

Proof Let $a \in \Omega$ and $b \in A$. By the transitivity of \mathcal{P} on Ω , there is a permutation $\pi \in \mathcal{P}$ such that $a = b^\pi$. Writing $\pi = \sigma\tau$ with $\sigma \in H$ and $\tau \in \mathcal{P} : H$, we find that $a = (b^\sigma)^\tau \in A^\tau$. Whence, Ω is certainly the union of $A^\tau, \tau \in H$. Now if $A^\tau \cap A^{\tau'} \neq \emptyset$, then $A \cap (A^{\tau'})^{\tau^{-1}} \neq \emptyset$. Consequently, $A = (A^{\tau'})^{\tau^{-1}}$ and $\tau'\tau^{-1} \in H$. But $\tau, \tau' \in \mathcal{P} : H$, we get that $\tau = \tau'$. So $A^\tau, \tau \in \mathcal{P} : H$ is a partition of Ω . Thus we establish (1).

Notice that $|A| = |A^\tau|$ for $\tau \in \mathcal{P} : H$. We immediately get that $|\Omega| = |A||\mathcal{P} : H|$ by (1). □

2.5.2 Primitive Group. Applying Theorem 2.3.1, the following result on primitive groups is obvious.

Theorem 2.5.2 *A transitive group of prime degree is primitive.*

These multiply at least 2-transitive groups constitute a frequently encountered primitive groups shown following.

Theorem 2.5.3 *Every 2-transitive group is primitive.*

Proof Let \mathcal{P} be a 2-transitive group action on Ω . If it is imprimitive, then there exists an imprimitive block A of \mathcal{P} . Whence we can find elements $a, b \in A$ and $c \in \Omega \setminus A$. By the 2-transitivity, there is an element $\pi \in \mathcal{P}$ such that $(a, b)^\pi = (a, c)$. So $a \in A \cap A^\pi$. Consequently, $A = A^\pi$. But this will implies that $c = b^\pi \in A$, a contradiction. □

Let $(\mathcal{G}; \circ)$ be a group. A subgroup $\mathcal{H} < \mathcal{G}$ is *maximal* if there are no subgroups $\mathcal{K} < \mathcal{G}$ such that $\mathcal{H} < \mathcal{K} < \mathcal{G}$. The next result is a more valuable criterion on primitivity of permutation groups.

Theorem 2.5.4 *A transitive group \mathcal{P} action on Ω is primitive if and only if \mathcal{P}_a is maximal for $\forall a \in \Omega$.*

Proof If \mathcal{P}_a is not maximal, then there exists a subgroup \mathcal{H} of \mathcal{P} such that $\mathcal{P}_a < \mathcal{H} < \mathcal{P}$. Define a subset of Ω by

$$A = \{a^\tau \mid \tau \in \mathcal{H}\}.$$

Then $|A| \geq 2$ because of $\mathcal{H} > \mathcal{P}_a$. First, if $A = \Omega$, then for $\forall \pi \in \mathcal{P}$ we can find an element $\sigma \in \mathcal{H}$ such that $a^\pi = a^\sigma$. Thus $\pi\sigma^{-1} \in \mathcal{P}_a$, which gives $\pi \in \mathcal{H}$ and $\mathcal{H} = \mathcal{P}$. Now if there is $\pi \in \mathcal{P}$ with $A \cap A^\pi \neq \emptyset$ hold, then there are $\sigma_1, \sigma_2 \in \mathcal{H}$ such that $a^{\sigma_1} = a^{\sigma_2\pi}$. Thus $\sigma_1^{-1} \in \mathcal{P}_a < \mathcal{H}$. Whence, $\pi \in \mathcal{H}$, which implies that $A = A^\pi$. Therefore, A is an imprimitive block and \mathcal{P} is imprimitive.

Conversely, let A be an imprimitive block of \mathcal{P} . By the transitivity of \mathcal{P} on Ω , we can assume that $a \in A$. Define

$$\mathcal{H} = \{\pi \in \mathcal{P} \mid A^\pi = A, \pi \in \mathcal{P}\}.$$

Then $\mathcal{H} \leq \mathcal{G}$. For $b, c \in A$, there is a $\pi \in \mathcal{G}$ such that $b^\pi = c$. Thus $c \in A \cap A^\pi$. Whence, $A = A^\pi$ and $\pi \in \mathcal{H}$ by definition. Therefore, \mathcal{H} is transitive on A . Consequently, $A = |\mathcal{H} : \mathcal{H}_a|$. Now if $\pi \in \mathcal{P}$, then $a = a^\pi \in A \cap A^\pi$. So $A = A^\pi$ and $\pi \in \mathcal{H}$. Thereafter, $\mathcal{P}_a < \mathcal{H}$ and $\mathcal{P}_a = \mathcal{H}_a$. Applying Theorem 2.1.1, we know that $|\Omega| = |\mathcal{P} : \mathcal{P}_a|$ and $|A| = |\mathcal{H} : \mathcal{H}_a| = |\mathcal{H} : \mathcal{P}_a|$. So $\mathcal{P}_a < \mathcal{H} < \mathcal{P}$ and \mathcal{P}_a is not maximal in \mathcal{P} . \square

Corollary 2.5.1 *Let \mathcal{P} be a transitive group action on Ω . If there is a proper subset $A \subset \Omega$, $|A| \geq 2$ such that*

$$a \in A, a^\pi \in A \Rightarrow A^\pi = A$$

for $\pi \in \mathcal{P}$, then \mathcal{P} is imprimitive.

Proof By Theorem 2.5.4, we only need to prove that $\mathcal{P}_a < \mathcal{P}_{\{A\}} < \mathcal{P}$, i.e., \mathcal{P}_a is not maximal of \mathcal{P} . In fact, $\mathcal{P}_a \leq \mathcal{P}_{\{A\}}$ is obvious by definition. Applying the transitivity of \mathcal{P} , for $\forall b \in A$ there is an element $\sigma \in \mathcal{P}$ such that $a^\sigma = b$. Clearly, $\sigma \in \mathcal{P}_{\{A\}}$, but $\sigma \notin \mathcal{P}_a$. Whence, $\mathcal{P}_a < \mathcal{P}_{\{A\}}$.

Now let $c \in \Omega \setminus A$. Applying the transitivity of \mathcal{P} again, there is an element $\tau \in \mathcal{P}$

such that $a^\tau = c$. Clearly, $\tau \in \mathcal{G}$ but $\tau \notin \mathcal{G}_{\{A\}}$. So we finally get that

$$\mathcal{P}_a < \mathcal{P}_{\{A\}} < \mathcal{P},$$

i.e., \mathcal{P}_a is not maximal in \mathcal{P} . □

Theorem 2.5.5 *Let \mathcal{P} be a nontrivial primitive group action on Ω . If $\mathcal{N} \triangleleft \mathcal{P}$, then \mathcal{N} is transitive on Ω .*

Proof Let $a \in \Omega$ and $A = \{a^\tau | \tau \in \mathcal{N}\}$. Notice that $(a^\sigma)^\pi = (a^\pi)^{\sigma^\pi}$ and $\sigma^\pi \in \mathcal{N}$ if $\pi \in \mathcal{P}$, $\sigma \in \mathcal{N}$. Thus A^π is an orbit containing a^π . Whence, $A = A^\pi$ or $a \cap A^\pi = \emptyset$, which implies that A is an imprimitive block. This is impossible because \mathcal{P} is primitive on Ω . Whence, $A = \Omega$, i.e., \mathcal{N} is transitive on Ω . □

Theorem 2.5.5 also implies the next result for imprimitive groups.

Corollary 2.5.2 *Let \mathcal{P} be a transitive group action on Ω with a non-transitive normal subgroup \mathcal{N} . Then \mathcal{P} is imprimitive.*

The following result relates primitive groups with simple groups.

Theorem 2.5.6 *Let \mathcal{P} be a nontrivial primitive group action on Ω . If there is an element $x \in \Omega$ such that \mathcal{P}_x is simple, then there is a subgroup $\mathcal{N} \triangleleft \mathcal{P}$ action regularly on Ω unless \mathcal{P} is itself simple.*

Proof If \mathcal{P} is not simple, then there is a proper normal subgroup $\mathcal{N} \triangleleft \mathcal{P}$. Consider $\mathcal{N} \cap \mathcal{P}_x$, which is a normal subgroup of \mathcal{P}_x . Notice that \mathcal{P}_x is simple. We know that $\mathcal{N} \cap \mathcal{P}_x = \mathcal{P}_x$ or $\{1_\mathcal{P}\}$.

Now if $\mathcal{N} \cap \mathcal{P}_x = \mathcal{P}_x$, then $\mathcal{P}_x \leq \mathcal{N}$. Applying Theorem 2.5.5, we know that \mathcal{N} is transitive on Ω . Whence, $\mathcal{N} < \mathcal{P}_x$ since $x^\zeta = x$ for $\forall \zeta \in \mathcal{P}_x$, i.e., \mathcal{P}_x is not transitive on Ω . By Theorem 2.5.4, there must be $\mathcal{N} = \mathcal{P}$, a contradiction. Whence, $\mathcal{N} \cap \mathcal{P}_x = \{1_\mathcal{P}\}$. Applying the transitivity of \mathcal{N} on Ω , we immediately get that $\mathcal{N}_y = \{1_\mathcal{P}\}$ for $\forall y \in \Omega$, i.e., \mathcal{N} acts regularly on Ω . □

2.5.3 Regular Normal Subgroup. Theorem 2.5.5 shows the importance of normal subgroups of primitive groups. In fact, we can determine all regular normal subgroups of multiply transitive groups. First, we prove the next result.

Theorem 2.5.7 *Let $(\mathcal{G}; \circ)$ be a nontrivial finite group and $\mathcal{P} = \text{Aut}\mathcal{G}$.*

- (1) If \mathcal{P} is transitive, then $(\mathcal{G}; \circ)$ is an elementary Abelian p -group for some prime p ;
- (2) If \mathcal{P} is 2-transitive, then either $p = 2$ or $|\mathcal{G}| = 3$;
- (3) If \mathcal{P} is 3-transitive, then $|\mathcal{G}| = 4$;
- (4) \mathcal{P} can not be 4-transitive.

Proof (1) Let p be a prime dividing $|\mathcal{G}|$. Then there exists an element x of order p by Corollary 2.4.1. By the transitivity we know that every element in $\mathcal{G} \setminus \{1_{\mathcal{G}}\}$ is the form x^{τ} , $\tau \in \mathcal{P}$ and hence of order p also. Thus \mathcal{G} is a finite p -group and its center $Z(\mathcal{G})$ is nontrivial by Theorem 2.4.6. By definition, $Z(\mathcal{G})$ is characteristic in $(\mathcal{G}; \circ)$ and thus is invariant in \mathcal{G} . Applying the transitivity of \mathcal{P} enables us to know that $Z(\mathcal{G}) = \mathcal{G}$. Whence, \mathcal{G} is an elementary Abelian p -groups.

(2) If $p > 2$, let $x \in \mathcal{G}$ with $x \neq 1_{\mathcal{G}}$. Thus $x \neq x^{-1}$. If there is also an element $y \in \mathcal{G}$, $y \neq 1_{\mathcal{G}}$, x, x^{-1} , then the 2-transitivity assures us of a $\tau \in \mathcal{P}$ such that $(x, x^{-1})^{\tau} = (x, y)$. Plainly, this fact implies that $y = x^{-1}$, a contradiction. Therefore, $\mathcal{G} = \{1_{\mathcal{G}}, x, x^{-1}\}$ and $|\mathcal{G}| = 3$.

(3) If \mathcal{P} is 3-transitive on $\mathcal{G} \setminus \{1_{\mathcal{G}}\}$, the later must has 3 elements at least, i.e., $|\mathcal{G}| \geq 4$. Applying (2) we know that \mathcal{G} is an elementary Abelian 2-group. Let $\mathcal{H} = \{1, x, y, x \circ y\}$ be a subgroup of order 4. If there is an element $z \in \mathcal{G} \setminus \mathcal{H}$, then $x \circ z, y \circ z$ and $x \circ y \circ z$ are distinct. So there must be an automorphism $\tau \in \mathcal{P}$ such that

$$x^{\tau} = x \circ z, y^{\tau} = y \circ z \text{ and } (x \circ y)^{\tau} = x \circ y \circ z$$

by the 3-transitivity of \mathcal{P} on \mathcal{G} . However, these relations imply that $z = 1_{\mathcal{G}}$, a contradiction. Whence, $\mathcal{H} = \mathcal{G}$.

(4) If \mathcal{P} were 4-transitive, it would be 3-transitive and $|\mathcal{G}| = 4$ by (3), which excludes the possibility of 4-transitivity. Whence, \mathcal{P} can not be 4-transitive. □

By Theorem 2.5.7, the regular normal subgroups of multiply transitive groups can be completely determined.

Theorem 2.5.8 *Let \mathcal{P} be a k -transitive group of degree n with $k \geq 2$ and \mathcal{N} a nontrivial regular normal subgroup of \mathcal{P} . Then,*

- (1) If $k = 2$, then $n = |\mathcal{N}| = p^m$ and \mathcal{N} is an elementary Abelian p -group for some prime p and integer m ;
- (2) If $k = 3$, then either $p = 2$ or $n = 3$;

- (3) If $k = 4$, then $n = 4$;
 (4) $k \geq 5$ is impossible.

Proof Clearly, $1 < k \leq n$. Let \mathcal{P} be a k -transitive group acting on Ω with $|\Omega| = n$ and $a \in \Omega$. By Theorem 2.2.3, we know that \mathcal{P}_a is $(k - 1)$ -transitive on $\Omega \setminus \{a\}$.

Consider the action of \mathcal{P}_a on $\mathcal{N} \setminus \{1_{\mathcal{P}}\}$ by conjugation. Now if $\pi \in \mathcal{N} \setminus \{1_{\mathcal{P}}\}$, by the regularity of \mathcal{N} we know that $a^\pi \neq a$. Thus there is a mapping Θ from $\mathcal{N} \setminus \{1_{\mathcal{P}}\}$ to $\Omega \setminus \{a\}$ determined by $\Theta : \pi \rightarrow a^\pi$. Applying the regularity of \mathcal{N} again, we know that Θ is injective. Besides, since \mathcal{N} is transitive by Theorem 2.5.5, we know that Θ is also surjective. Whence,

$$\Theta : \mathcal{N} \setminus \{1_{\mathcal{P}}\} \rightarrow \Omega \setminus \{a\}$$

is a bijection.

Now let $1_{\mathcal{P}} \neq \pi \in \mathcal{P}$ and $\sigma \in \mathcal{P}_a$. Then we have that $(a^\pi)^\sigma = a^{\pi^\sigma}$, or $(\Theta(\pi))^\sigma = \Theta(\pi^\sigma)$. Thereafter, the permutation representations of \mathcal{P}_a on $\mathcal{N} \setminus \{1_{\mathcal{P}}\}$ and $\Omega \setminus \{a\}$ are equivalent. Whence \mathcal{P}_a is $(k - 1)$ -transitive on $\mathcal{N} \setminus \{1_{\mathcal{P}}\}$. Notice that $\mathcal{P}_a \leq \text{Aut } \mathcal{N}$. We therefore know that $\text{Aut } \mathcal{N}$ is $(k - 1)$ -transitive on $\mathcal{N} \setminus \{1_{\mathcal{P}}\}$ also. By Theorem 2.5.7, we immediately get all these conclusions (1) – (4). \square

2.5.4 O’Nan-Scott Theorem. The main approach in classification of primitive groups is to study the subgroup generated by the minimal subgroups, i.e., the *socle* of a group defined following.

Definition 2.5.1 Let $(\mathcal{G}; \circ)$ be a group. A minimal normal subgroup of $(\mathcal{G}; \circ)$ is such a normal subgroup $(\mathcal{N}; \circ)$, $\mathcal{N} \neq \{1_{\mathcal{G}}\}$ which does not contain other properly nontrivial normal subgroup of \mathcal{G} .

Definition 2.5.2 Let $(\mathcal{G}; \circ)$ be a group with all minimal normal subgroups $\mathcal{N}_1, \mathcal{N}_2, \dots, \mathcal{N}_m$. The socle $\text{soc}(\mathcal{G})$ of $(\mathcal{G}; \circ)$ is determined by

$$\text{soc}(\mathcal{G}) = \langle \mathcal{N}_1, \mathcal{N}_2, \dots, \mathcal{N}_m \rangle.$$

Then we know the following results on socle of finite groups without proofs.

Theorem 2.5.9 Let $(\mathcal{G}; \circ)$ be a nontrivial finite group. Then

- (1) If K is a minimal normal subgroup and L a normal subgroup of $(\mathcal{G}; \circ)$, then either $K \leq L$ or $\langle K, L \rangle = K \times L$;

(2) There exist minimal normal subgroups K_1, K_2, \dots, K_m of $(\mathcal{G}; \circ)$ such that

$$\text{soc}(\mathcal{G}) = K_1 \times K_2 \times \dots \times K_m;$$

(3) Every minimal normal subgroup K of $(\mathcal{G}; \circ)$ is a direct product $K = T_1 \times T_2 \times \dots \times T_k$, where these T_i , $1 \leq i \leq k$ are simple normal subgroups of K which are conjugate under $(\mathcal{G}; \circ)$;

(4) If these subgroup K_i , $1 \leq i \leq m$ in (2) are all non-Abelian, then K_1, K_2, \dots, K_m are the only minimal normal subgroups of $(\mathcal{G}; \circ)$. Similarly, if these T_i , $1 \leq i \leq k$ in (3) are non-Abelian, then they are the only minimal normal subgroups of K .

Theorem 2.5.10 Let \mathcal{P} be a finite primitive group of S_Ω and K a minimal normal subgroup of \mathcal{P} . Then exactly one of the following holds:

(1) For some prime p and integer d , K is a regular elementary Abelian group of order p^d , and $\text{soc}(\mathcal{P}) = K = Z_{\mathcal{G}}(K)$, where $Z_{\mathcal{G}}(K)$ is the centralizer of K in \mathcal{P} ;

(2) K is a regular non-Abelian group, $Z_{\mathcal{G}}(K)$ is a minimal normal subgroup of \mathcal{P} which is permutation isomorphic to K , and $\text{soc}(\mathcal{P}) = K \times Z_{\mathcal{G}}(K)$;

(3) K is non-Abelian, $Z_{\mathcal{G}}(K) = \{1_{\mathcal{P}}\}$ and $\text{soc}(\mathcal{P}) = K$.

Particularly, for the socle of a primitive group, we get the following conclusion.

Corollary 2.5.3 Let \mathcal{P} be a finite primitive group of S_Ω with the socle H . Then

(1) H is a direct product of isomorphic simple groups;

(2) H is a minimal normal subgroup of $\mathcal{N}_{S_\Omega}(H)$. Moreover, if H is not regular, then it is the only minimal normal subgroup of $\mathcal{N}_{S_\Omega}(H)$.

Let Ω and Δ be two sets or groups. Denoted by $\text{Fun}(\Omega, \Delta)$ the set of all functions from Ω into Δ . For two groups \mathcal{K} , \mathcal{H} acting on a non-empty set Ω , the wreath product $\mathcal{K} \text{ wr}_\Omega \mathcal{H}$ of \mathcal{K} by \mathcal{H} with respect to this action is defined to be the semidirect product $\text{Fun}(\Omega, \mathcal{K}) \rtimes \mathcal{H}$, where \mathcal{H} acts on the group $\text{Fun}(\Omega, \mathcal{K})$ is determined by

$$f^\gamma(a) = f(a^{\gamma^{-1}}) \text{ for all } f \in \text{Fun}(\Omega, \mathcal{K}), a \in \Omega \text{ and } \gamma \in \mathcal{H}.$$

and the operation \cdot in $\text{Fun}(\Omega, \mathcal{K}) \times \mathcal{H}$ is defined to be

$$(f_1, g_1) \cdot (f_2, g_2) = (f_1 f_2^{g_1^{-1}}, g_1 g_2).$$

Usually, the group $B = \{(f, 1_{\mathcal{H}}) | f \in \text{Fun}(\Omega, \mathcal{K})\}$ is called the *base group* of the wreath product $\mathcal{K} \text{ wr}_\Omega \mathcal{H}$.

A permutation group \mathcal{P} acting on Ω with the socle H is said to be *diagonal type* if \mathcal{P} is a subgroup of the normalizer $\mathcal{N}_{S_\Omega}(H)$ such that \mathcal{P} contains the base group $H = T_1 \times T_2 \times \cdots \times T_m$. Then by Theorem 2.5.9 these groups T_1, T_2, \dots, T_m are the only minimal normal subgroups of H and $H \triangleleft \mathcal{P}$. So \mathcal{P} acts by conjugation on the set $\{T_1, T_2, \dots, T_m\}$. Then we know the next result characterizing those primitive groups of diagonal type without proof.

Theorem 2.5.11 *Let $\mathcal{P} \leq \mathcal{N}_{S_\Omega}(H)$ be a diagonal type group with the socle $H = T_1 \times T_2 \times \cdots \times T_m$. Then \mathcal{P} is primitive subgroup of S_Ω either if*

- (1) $m = 2$; or
- (2) $m \geq 3$ and the action of \mathcal{P} by conjugation on $\{T_1, T_2, \dots, T_m\}$ of the minimal normal subgroups of H is primitive.

Now we can present the *O’Nan-Scott theorem* following, which characterizes the structure of primitive groups.

Theorem 2.5.12(O’Nan-Scott Theorem) *Let \mathcal{P} be a finite primitive group of degree n and \mathcal{H} the socle of \mathcal{P} . Then either*

- (1) \mathcal{H} is a regular elementary Abelian p -group for some prime p , $n = p^m = |\mathcal{H}|$ and \mathcal{P} is isomorphic to a subgroup of the affine group $AGL_m(p)$; or
- (2) \mathcal{H} is isomorphic to a direct power T^m of a non-Abelian simple group T and one of the following holds:
 - (i) $m = 1$ and \mathcal{P} is isomorphic to a subgroup of $\text{Aut}T$;
 - (ii) $m \geq 2$ and \mathcal{P} is a group of diagonal type with $n = |T|$;
 - (iii) $m \geq 2$ and for some proper divisor d of m and some primitive group \mathcal{T} with a socle isomorphic to T^d , \mathcal{P} is isomorphic to a subgroup of the wreath product $\mathcal{T} \text{ wr } S_\Omega$, $|\Omega| = m/d$ with the product action, and $n = l^{m/d}$, where l is the degree of \mathcal{T} ;
 - (iv) $m \geq 6$, \mathcal{H} is regular and $n = |T|^m$.

A complete proof of the O’Nan-Scott theorem can be found in the reference [DiM1]. It should be noted that the O’Nan-Scott theorem is a useful result for research problems related with permutation groups. By Corollary 2.5.3, a finite primitive group \mathcal{P} has a socle $H \cong T^m$, a direct product of m copies of some simple group T . Applying this result enables one to divide a problem into the following five types in general:

1. Affine Type: H is an elementary Abelian p -group, $n = p^m$ and \mathcal{P} is a subgroup of $AGL_m(p)$ containing the translations.

2. Regular Non-Abelian Type: H and T are non-Abelian, $n = |T|^m$, $m \geq 6$ and the group \mathcal{P} can be constructed as a twisted wreath product.

3. Almost Simple Type: H is simple and $\mathcal{P} \leq \text{Aut}H$.

4. Diagonal Type: $H = T^m$ with $m \geq 2$, $n = |T|^{m-1}$ and \mathcal{P} is a subgroup of a wreath product with the diagonal action.

5. Product Type: $H = T^m$ with $m = rs$, $s > 1$. There is a primitive non-regular group \mathcal{T} with socle T^r and of type in Cases 3 or 4 such that \mathcal{P} is isomorphic to a subgroup of the wreath product $\mathcal{T} \text{ wr } S_\Delta$, $|\Delta| = s$ with the product action.

All these types are contributed to applications of O’Nan-Scott theorem, particularly for the classification of symmetric graphs in Chapter 3.

§2.6 LOCAL ACTION AND EXTENDED GROUPS

Let $(\tilde{\mathcal{G}}; \tilde{\mathcal{O}})$ be a multigroup with $\tilde{\mathcal{G}} = \bigcup_{i=1}^m \mathcal{G}_i$, $\tilde{\mathcal{O}} = \{\circ_i | 1 \leq i \leq m\}$ and $\tilde{\Omega} = \bigcup_{i=1}^m \Omega_i$ a set. An action (φ, ι) of $(\tilde{\mathcal{G}}; \tilde{\mathcal{O}})$ on $\tilde{\Omega}$ is defined to be a homomorphism

$$(\varphi, \iota) : (\tilde{\mathcal{G}}; \tilde{\mathcal{O}}) \rightarrow \bigcup_{i=1}^m S_{\Omega_i}$$

such that $\varphi|_{\Omega_i} : \mathcal{G}_i \rightarrow S_{\Omega_i}$ is a homomorphism, i.e., for $\forall x \in \Omega_i$, $\varphi(h) : x \rightarrow x^h$ with conditions following hold,

$$x^{h\circ_i g} = x^h \iota(\circ_i) x^g, \quad h, g \in \mathcal{H}_i$$

for any integer $1 \leq i \leq m$. We say $\varphi|_{\Omega_i}$ the *local action* of (φ, ι) on $\tilde{\Omega}$ for integers $1 \leq i \leq m$.

2.6.1 Local Action Group. If the multigroup $(\tilde{\mathcal{G}}; \tilde{\mathcal{O}})$ is in fact a permutation group \mathcal{P} with $\tilde{\Omega} = \bigcup_{i=1}^m \Omega_i$, we call such a \mathcal{P} to be a *local action group* on Ω_i for integers $1 \leq i \leq m$.

In this case, a *local action* of \mathcal{P} on $\tilde{\Omega}$ is determined by

$$\Omega_i^{\mathcal{P}} = \Omega_i \quad \text{and} \quad (\tilde{\Omega} \setminus \Omega_i)^{\mathcal{P}} = \tilde{\Omega} \setminus \Omega_i$$

for integers $1 \leq i \leq m$.

If the local action of \mathcal{P} on Ω_i is transitive or regular, then we say it is a *locally transitive group* or *locally regular group* on Ω_i for an integer $1 \leq i \leq m$. We know the following necessary condition for locally transitive or regular groups by Theorem 2.2.1 and Corollary 2.2.1.

Theorem 2.6.1 *Let \mathcal{P} be a group action on $\tilde{\Omega} = \bigcup_{i=1}^m \Omega_i$ and $\mathcal{H} \leq \mathcal{P}$. Then \mathcal{H} is locally transitive only if there is an integer k_0 , $1 \leq k_0 \leq m$ such that $|\Omega_{k_0}| \mid |\mathcal{H}|$. Furthermore, if it is locally regular, then there is an integer l_0 , $1 \leq l_0 \leq m$ such that $|\Omega_{l_0}| = |\mathcal{H}|$.*

Let \mathcal{P} be a group locally acting on $\tilde{\Omega}$, where $\tilde{\Omega} = \bigcup_{i=1}^m \Omega_i$. If there are integers $k, i, k \geq 2, 1 \leq i \leq m$ such that the action of \mathcal{P} on Ω_i is k -transitive or sharply k -transitive, we say it is a *locally k -transitive group* or *locally sharply k -transitive group* on $\tilde{\Omega}$. The following necessary condition for locally k -transitive or sharply groups is by Theorems 2.2.3–2.2.5.

Theorem 2.6.2 *Let \mathcal{P} be a group action on $\tilde{\Omega} = \bigcup_{i=1}^m \Omega_i$ and $\mathcal{H} \leq \mathcal{P}$. Then \mathcal{H} is locally k -transitive only if there is an integer i_0 , $1 \leq i_0 \leq m$ such that for $\forall a \in \Omega_{i_0}$, \mathcal{H}_a is $(k-1)$ -transitive acting on $\Omega \setminus \{a\}$. Particularly, $|\Omega_{i_0}|(|\Omega_{i_0}| - 1) \cdots (|\Omega_{i_0}| - k + 1) \mid |\mathcal{H}|$. Furthermore, if it is locally sharply k -transitive, then there is an integer j_0 , $1 \leq j_0 \leq m$ such that $|\Omega_{j_0}|(|\Omega_{j_0}| - 1) \cdots (|\Omega_{j_0}| - k + 1) = |\mathcal{H}|$.*

Theorems 2.6.1 and 2.6.2 enables us to know what kind subgroups maybe locally action groups.

Example 2.6.1 Let \mathcal{P} be a permutation group with

$$\begin{aligned} \mathcal{P} = \{ & 1_{\mathcal{P}}, (1, 2, 3, 4, 5), (1, 4, 2, 5, 3), (1, 5, 4, 3, 2) \\ & (2, 3, 5, 4), (1, 3, 2, 5), (1, 5, 4, 3), (1, 2, 4, 3), (1, 4, 5, 2) \\ & (2, 4, 5, 3), (1, 4, 3, 5), (1, 2, 5, 4), (1, 5, 2, 3), (1, 3, 4, 2) \\ & (2, 5)(3, 4), (1, 5)(2, 4), (1, 4)(2, 3), (1, 3)(4, 5), (1, 2)(3, 5)\} \end{aligned}$$

Then

$$\begin{aligned} \mathcal{H} &= \{1_{\mathcal{P}}, (1, 2, 3, 4, 5), (1, 4, 2, 5, 3), (1, 5, 4, 3, 2)\}, \\ \mathcal{T} &= \{1_{\mathcal{P}}, (1, 2, 3, 4), (1, 3)(2, 4), (1, 4, 3, 2)\} \end{aligned}$$

both are subgroups of \mathcal{P} . Notice that $|\mathcal{H}| = 5$, $|\mathcal{T}| = 4$. We know that \mathcal{H} and \mathcal{T} are transitive acting on $\Omega = \{1, 2, 3, 4, 5\}$ and $\Delta = \{1, 2, 3, 4\}$, respectively. But none of them is k -transitive for $k \geq 2$.

Corollary 2.6.1 Let \mathcal{P} be a group action on $\tilde{\Omega} = \bigcup_{i=1}^m \Omega_i$, $\mathcal{H} \leq \mathcal{P}$. For integers i , $1 \leq i \leq m$ and $k \geq 1$, if $|\Omega_i|(|\Omega_i| - 1)(|\Omega_i| - 2) \cdots (|\Omega_i| - k + 1)$ is not a divisor of $|\mathcal{H}|$, then $(\mathcal{H}; \circ)$ is not locally k -transitive on Ω_i .

For a local action group \mathcal{P} on $\tilde{\Omega}$ with $\tilde{\Omega} = \bigcup_{i=1}^m \Omega_i$, if there is an integer i , $1 \leq i \leq m$ such that the action of \mathcal{P} on Ω_i is primitive, we say it is a *locally primitive group* on $\tilde{\Omega}$. The following condition for locally primitive group is by Theorems 2.5.4.

Theorem 2.6.3 Let \mathcal{P} be a local action group on $\tilde{\Omega} = \bigcup_{i=1}^m \Omega_i$ with $\mathcal{H} < \mathcal{P}$. Then $(\mathcal{H}; \circ)$ is locally primitive if and only if there is an integer l , $1 \leq l \leq m$ such that \mathcal{H} action on Ω_l is transitive and \mathcal{H}_a is maximal for $\forall a \in \Omega_l$.

2.6.2 Action Extended Group. Conversely, let \mathcal{P} be a permutation group action on Ω , Δ a set with $\Delta \cap \Omega = \emptyset$. A permutation group $\tilde{\mathcal{P}}$ action on $\Omega \cup \Delta$ is an *action extended* of \mathcal{P} on Ω if $(\tilde{\mathcal{P}})_{\Delta} = \mathcal{P}$, and *k -transitive extended* or *primitive extended* if $\tilde{\mathcal{P}}$ action on $\Omega \cup \Delta$ is k -transitive for an integer $k \geq 1$ or primitive. Particularly, if $|\Delta| = 1$, such a action extended group is called *one-point extended* on \mathcal{P} .

The following result is simple.

Theorem 2.6.4 Let \mathcal{P} be a permutation group action on Ω , $\Delta \cap \Omega = \emptyset$, $k \geq 1$ an integer and $\tilde{\mathcal{P}}$ an extension of \mathcal{P} action on $\Delta \cup \Omega$. If

- (1) $\tilde{\mathcal{P}}$ is k -transitive on Δ ;
- (2) there are k elements $x_1, x_2, \dots, x_k \in \Delta$ such that for l elements $y_1, y_2, \dots, y_l \in \Omega$, where $1 \leq l \leq k$ there exists an element $\pi_l \in \tilde{\mathcal{P}}$ with

$$y_i^{\pi_l} = x_i \text{ for } 1 \leq i \leq l \text{ but } x_i^{\pi_l} = x_i \text{ if } l+1 \leq i \leq k,$$

hold, then $\tilde{\mathcal{P}}$ is k -transitive extended on $\Delta \cup \Omega$.

Proof Let x_i, y_i , $1 \leq i \leq k$ be $2k$ elements in $\Omega \cup \Delta$. Firstly, we prove that for any choice of $x_1, x_2, \dots, x_k \in \Omega \cup \Delta$, there always exists an element $\theta \in \tilde{\mathcal{P}}$ such that all $x_i^{\theta} \in \Delta$ for $1 \leq i \leq k$. If $x_1, x_2, \dots, x_k \in \Delta$, there are no words need to say. Not loss of generality, we assume that $x_1, x_2, \dots, x_s \in \Omega$ but $x_{s+1}, x_{s+2}, \dots, x_k \in \Delta$ for an integer $1 \leq s \leq k$. Then by the assumption (2), there is an element $\pi_s \in \tilde{\mathcal{P}}$ such that $x_i^{\pi_s} \in \Delta$ for $1 \leq i \leq s$ but $x_i^{\pi_s} = x_i$ for $s+1 \leq i \leq k$. Whence, $x_i^{\pi_s} \in \Delta$ for $1 \leq i \leq k$, i.e., $\theta = \pi_s$ is for our objective. Similarly, there also exists an element $\tau \in \tilde{\mathcal{P}}$ such that $y_i^{\tau} \in \Delta$ for $1 \leq i \leq k$.

Applying the assumption (1), there is an element $\pi \in \widetilde{\mathcal{P}}$ such that $(x_i^\theta)^\pi = y_i^\tau$ for integers $1 \leq i \leq k$. Consequently, we know that

$$x_i^{\theta\pi\tau^{-1}} = y_i \text{ for } 1 \leq i \leq k.$$

This completes the proof. \square

Particularly, if $k = 1$, we get the following conclusion for transitive extended by Theorem 2.6.4.

Corollary 2.6.2 *Let \mathcal{P} be a permutation group action on Ω , $\Delta \cap \Omega = \emptyset$ and $\widetilde{\mathcal{P}}$ an extension of \mathcal{P} action on $\Delta \cup \Omega$. If*

(1) $\widetilde{\mathcal{P}}$ is transitive on Δ ;

(2) there is one element $x \in \Delta$ such that for any element $y \in \Omega$, there exists an element $\pi \in \widetilde{\mathcal{P}}$ with $y^\pi = x$ hold,

then $\widetilde{\mathcal{P}}$ is transitive extended on $\Delta \cup \Omega$.

Furthermore, if $\widetilde{\mathcal{P}}$ is one-point extended of $\widetilde{\mathcal{P}}$, we get the following result.

Corollary 2.6.3 *Let $\widetilde{\mathcal{P}}$ be an one-point extension of \mathcal{P} action on Ω by $x \notin \Omega$. For $\forall y \in \Omega$, if there exists an element $\pi \in \widetilde{\mathcal{P}}$ such that $y^\pi = x$, then $\widetilde{\mathcal{P}}$ is transitive extended of \mathcal{P} .*

These conditions in Corollaries 2.6.2–2.6.3 is too strong. In fact, we improve conditions in them as in the following result.

Theorem 2.6.5 *Let \mathcal{P} be a permutation group action on Ω with orbits $\mathcal{B}_1, \mathcal{B}_2, \dots, \mathcal{B}_m$, $\Delta \cap \Omega = \emptyset$ and*

$$\widetilde{\mathcal{P}} = \langle \mathcal{P}; \mathcal{Q} \rangle,$$

with $\mathcal{Q} = \{(x, y_i), 1 \leq i \leq m; (x', z), x' \in \Delta, x' \neq x\}$, where $x \in \Delta$, $y_i \in \mathcal{B}_i$, $z = x$ or y_i for $1 \leq i \leq m$. Then $\widetilde{\mathcal{P}}$ is transitive extended. Furthermore, if \mathcal{P} is transitive on Ω or $\Delta = \{x\}$, i.e., $\widetilde{\mathcal{P}}$ is one-point extension of \mathcal{P} , then

$$\widetilde{\mathcal{P}} = \langle \mathcal{P}; (x, y), (x', z), x' \in \Delta, x' \neq x \rangle \text{ or } \langle \mathcal{P}; (x, y_i), 1 \leq i \leq m \rangle$$

with $y \in \Omega$, $z = x$ or y is transitive extended of \mathcal{P} on $\Omega \cup \Delta$ or $\Omega \cup \{x\}$.

Proof We only prove the first assertion since all others are then followed.

Firstly, for $\forall z_i \in \mathcal{B}_i, z_j \in \mathcal{B}_j$, let $z_i^{\sigma_1} = y_i$ and $z_j^{\sigma_2} = y_j, \sigma_i, \sigma_j \in \mathcal{P}$. Then $z_i^{\sigma_i(x,y_i)(x,y_j)\sigma_j} = z_j$. Now if $x_1, x_2 \in \Delta$, by definition $x_1^{(x_1,x)(x_2,x)} = x_2$, or $x_1^{(x_1,x)(x,y_i)(y_i,x_2)} = x_2$, or $x_1^{(x_1,y_i)(x_2,y_i)} = x_2$, or $x_1^{(x_1,y_i)(y_i,x)(x,y_j)(y_j,x_2)} = x_2$ if $(x_1, x), (x_2, x)$, or $(x_1, x), (x, y_i), (y_i, x_2)$, or $(x_1, y_i), (x_2, y_i)$, or $(x_1, y_i), (y_i, x), (x, y_j), (y_j, x_2) \in \widetilde{\mathcal{P}}$. Finally, if $x_i \in \Delta$ and $z_j \in \mathcal{B}_j$, let $x_i^{\sigma} = x$ and $z_j^{\zeta} = y_j$. Then $x_i^{\sigma(x,y_j)\zeta} = z_j$.

Therefore, $\widetilde{\mathcal{P}}$ is transitive extended on $\Omega \cup \Delta$. □

The k -transitive number $\varpi_k^{tran}(\mathcal{P}; \Delta)$ of a permutation group \mathcal{P} action on Ω by a set Δ with $\Delta \cap \Omega = \emptyset$ is defined to be the minimum number of involutions appeared in permutations presented by product of inventions added to \mathcal{P} such that $\widetilde{\mathcal{P}}$ is k -transitive extended of \mathcal{P} on $\Omega \cup \Delta$. Particularly, if $k = 1$, we abbreviate $\varpi_k^{tran}(\mathcal{P}; \Delta)$ to $\varpi^{tran}(\mathcal{P}; \Delta)$.

We know the number $\varpi(\mathcal{P}; \Delta)$ in the following result.

Theorem 2.6.6 *Let \mathcal{P} be a permutation group action on Ω with an orbital set $Orb(\Omega)$, $\Delta \cap \Omega = \emptyset$ and $\widetilde{\mathcal{P}}$ an extended action of \mathcal{P} on $\Delta \cup \Omega$. Then*

$$\varpi^{tran}(\mathcal{P}; \Delta) = |\Delta| + |Orb(\Omega)| - 1.$$

Furthermore, if \mathcal{P} is transitive or $\widetilde{\mathcal{P}}$ is one-point extension of \mathcal{P} , then

$$\varpi^{tran}(\mathcal{P}; \Delta) = |\Delta| \text{ or } |Orb(\Omega)|.$$

Proof Let $x \in \Delta \cup \Omega$ be a chosen element. denoted by $A[x]$ all elements determined by

$$A[x] = \{ y | x^\pi = y, \forall \pi \in \widetilde{\mathcal{P}} \}.$$

If $\widetilde{\mathcal{P}}$ is a transitive extended action of \mathcal{P} on $\Delta \cup \Omega$, there must be $A[x] = \Delta \cup \Omega$. Enumerating all inventions appeared in permutations π presented by product of inventions such that $x^\pi = y \in A[x]$, we know that

$$\varpi^{tran}(\mathcal{P}; \Delta) \geq |\Delta| + |Orb(\Omega)| - 1.$$

Applying Theorem 2.6.5, we get that

$$\varpi^{tran}(\mathcal{P}; \Delta) \leq |\Delta| + |Orb(\Omega)| - 1.$$

Whence,

$$\varpi^{tran}(\mathcal{P}; \Delta) = |\Delta| + |Orb(\Omega)| - 1.$$

Notice that $|Orb(\Omega)| = 1$ or $|\Delta| = 1$ if \mathcal{P} is transitive or $\widetilde{\mathcal{P}}$ is one-point extension of \mathcal{P} . We therefore find that

$$\varpi^{tran}(\mathcal{P}; \Delta) = |\Delta| \text{ or } |Orb(\Omega)|$$

if \mathcal{P} is transitive or $\widetilde{\mathcal{P}}$ is one-point extended. \square

Now we turn our attention to primitive extended groups. Applying Theorem 2.5.3, we have the following result.

Theorem 2.6.7 *Let \mathcal{P} be a permutation group action on Ω and Δ a nonempty set with $\Delta \cap \Omega = \emptyset$. Then there exist primitive extended permutation groups $\widetilde{\mathcal{P}}$ of \mathcal{P} action on $\Omega \cup \Delta$ if $|\Delta| \geq 2$ or $|\Delta| = 1$ but \mathcal{P} is transitive on Ω .*

Proof Let $\mathcal{B}_1, \mathcal{B}_2, \dots, \mathcal{B}_m$ be orbits of \mathcal{P} action on Ω . Define

$$\widetilde{\mathcal{P}} = \langle \mathcal{P}; (x, y_i), 1 \leq i \leq m; (x', x), x' \in \Delta, x' \neq x \rangle,$$

where $x \in \Delta, y_i \in \mathcal{B}_i$. Then $\widetilde{\mathcal{P}}$ is 2-transitive extended of \mathcal{P} by Theorem 2.6.4 if $|\Delta| \geq 2$. Notice that $\widetilde{\mathcal{P}}_x = \mathcal{P}$. If $\Delta = \{x\}$ and \mathcal{P} is transitive on Ω , we also know that $\widetilde{\mathcal{P}}$ is 2-transitive extended of \mathcal{P} by Theorem 2.2.3. Whence, we know that $\widetilde{\mathcal{P}}$ is primitive extended of \mathcal{P} on $\Omega \cup \Delta$ by Theorem 2.5.3 in each case. \square

2.6.3 Action MultiGroup. Let $\widetilde{\mathcal{P}}$ be a permutation multigroup action on $\widetilde{\Omega}$ with $\widetilde{\mathcal{P}} = \bigcup_{i=1}^m \mathcal{P}_i, \widetilde{\Omega} = \bigcup_{i=1}^m \Omega_i$ and for each integer $i, 1 \leq i \leq m$, the permutation group \mathcal{P}_i acts on Ω_i . Such a permutation multigroup $\widetilde{\mathcal{P}}$ is said to be *globally k -transitive* for an integer $k \geq 1$ if for any two k -tuples $x_1, x_2, \dots, x_k \in \Omega_i$ and $y_1, y_2, \dots, y_k \in \Omega_j$, where $1 \leq i, j \leq m$, there are permutations $\pi_1, \pi_2, \dots, \pi_n$ such that

$$x_1^{\pi_1 \pi_2 \dots \pi_n} = y_1, x_2^{\pi_1 \pi_2 \dots \pi_n} = y_2, \dots, x_k^{\pi_1 \pi_2 \dots \pi_n} = y_k.$$

For simplicity, we abbreviate the globally 1-transitive to that *globally transitive* of a permutation multigroup.

Remark 2.6.1: There are no meaning if we define the globally k -transitive on two k -tuples $x_1, x_2, \dots, x_k \in \widetilde{\Omega}, y_1, y_2, \dots, y_k \in \widetilde{\Omega}$ in a permutation multigroup $\widetilde{\mathcal{P}}$ because there are no definition for the actions x_l^π if $x_l \notin \Omega_i$ but $\pi \in \mathcal{P}_i, 1 \leq i \leq m$, where $1 \leq l \leq k$.

Theorem 2.6.8 *Let $\widetilde{\mathcal{P}}$ be a permutation multigroup action on $\widetilde{\Omega}$ with $\widetilde{\mathcal{P}} = \bigcup_{i=1}^m \mathcal{P}_i, \widetilde{\Omega} = \bigcup_{i=1}^m \Omega_i$, where each permutation group \mathcal{P}_i transitively acts on Ω_i for each integers $1 \leq i \leq m$.*

m. Then $\widetilde{\mathcal{P}}$ is globally transitive on $\widetilde{\Omega}$ if and only if for any integer i , $1 \leq i \leq m$, there exists an integer j , $1 \leq j \leq m$, $j \neq i$ such that

$$\Omega_i \cap \Omega_j \neq \emptyset.$$

Proof If $\widetilde{\mathcal{P}}$ is globally transitive action on $\widetilde{\Omega}$, by definition for $x \in \Omega_i$ and $y \notin \Omega_i$, $1 \leq i \leq m$, there are elements $\pi_1, \pi_2, \dots, \pi_n \in \widetilde{\mathcal{P}}$ such that

$$x^{\pi_1 \pi_2 \dots \pi_n} = y.$$

Not loss of generality, we assume $\pi_1, \pi_2, \dots, \pi_{l-1} \in \mathcal{P}_i$ but $\pi_l, \pi_{l+1}, \dots, \pi_n \notin \mathcal{P}_i$, i.e., l be the least integer such that $\pi_l \notin \mathcal{P}_i$. Let $\pi_l \in \mathcal{P}_j$. Notice that $\mathcal{P}_i, \mathcal{P}_j$ act on Ω_i and Ω_j , respectively. We get that $x^{\pi_1 \pi_2 \dots \pi_l} \in \Omega_i \cap \Omega_j$, i.e.,

$$\Omega_i \cap \Omega_j \neq \emptyset.$$

Conversely, if for any integer i , $1 \leq i \leq m$, there always exists an integer j , $1 \leq j \leq m$, $j \neq i$ such that

$$\Omega_i \cap \Omega_j \neq \emptyset,$$

let $x \in \Omega_i$ and $y \notin \Omega_i$. Then there exist integers l_1, l_2, \dots, l_s such that

$$\Omega_i \cap \Omega_{l_1} \neq \emptyset, \quad \Omega_{l_1} \cap \Omega_{l_2} \neq \emptyset, \quad \dots, \quad \Omega_{l_{s-1}} \cap \Omega_{l_s} \neq \emptyset.$$

Let $x, x_1 \in \Omega_i \cap \Omega_{l_1}$, $x_2 \in \Omega_{l_1} \cap \Omega_{l_2}$, \dots , $x_s \in \Omega_{l_{s-1}} \cap \Omega_{l_s}$, $y \in \Omega_{l_s}$ and $\pi_1 \in \mathcal{P}_i, \pi_2 \in \mathcal{P}_{l_1}, \dots, \pi_{s-1} \in \mathcal{P}_{l_{s-1}}, \pi_s \in \mathcal{P}_{l_s}$ such that $x^{\pi_1} = x_1, x_1^{\pi_2} = x_2, \dots, x_{s-1}^{\pi_{s-1}} = x_s, x_s^{\pi_s} = y$ by the transitivity of $\mathcal{P}_i, 1 \leq i \leq m$. Therefore, we find that

$$x^{\pi_1 \pi_2 \dots \pi_s} = y.$$

This completes the proof. □

The condition of transitivity on each permutation $\mathcal{P}_i, 1 \leq i \leq m$ in Theorem 2.6.8 is not necessary for the globally transitive of $\widetilde{\mathcal{P}}$ on $\widetilde{\Omega}$, such as those shown in the following example.

Example 2.6.2 Let $\widetilde{\mathcal{P}}$ be a permutation multigroup action on $\widetilde{\Omega}$ with

$$\widetilde{\mathcal{P}} = \mathcal{P}_1 \cup \mathcal{P}_2 \quad \text{and} \quad \widetilde{\Omega} = \{1, 2, 3, 4, 5, 6, 7, 8\} \cup \{1, 2, 5, 6, 9, 10, 11, 12\},$$

where $\mathcal{P}_1 = \langle (1, 2, 3, 4), (5, 6, 7, 8) \rangle$ and $\mathcal{P}_2 = \langle (1, 5, 9, 10), (2, 6, 11, 12) \rangle$, i.e.,

$$\begin{aligned} \mathcal{P}_1 = & \{1_{\mathcal{P}_1}, (13)(24), (1, 2, 3, 4), (1, 4, 3, 2), \\ & (5, 7)(6, 8), (5, 8, 7, 6), (5, 6, 7, 8), \\ & (13)(24)(5, 7)(6, 8), (13)(24)(5, 6, 7, 8), (13)(24)(5, 8, 7, 6) \\ & (1, 2, 3, 4)(5, 7)(6, 8), (1, 2, 3, 4)(5, 6, 7, 8), (1, 2, 3, 4)(5, 8, 7, 6) \\ & (1, 4, 3, 2)(5, 7)(6, 8), (1, 4, 3, 2)(5, 6, 7, 8), (1, 4, 3, 2)(5, 8, 7, 6)\} \end{aligned}$$

and

$$\begin{aligned} \mathcal{P}_2 = & \{1_{\mathcal{P}_2}, (1, 9)(5, 10), (1, 5, 9, 10), (1, 10, 9, 5) \\ & (2, 11)(6, 12), (2, 6, 11, 12), (2, 12, 11, 6) \\ & (1, 9)(5, 10)(2, 11)(6, 12), (1, 9)(5, 10)(2, 6, 11, 12), (1, 9)(5, 10)(2, 12, 11, 6) \\ & (1, 5, 9, 10)(2, 11)(6, 12), (1, 5, 9, 10)(2, 6, 11, 12), (1, 5, 9, 10)(2, 12, 11, 6) \\ & (1, 10, 9, 5)(2, 11)(6, 12), (1, 10, 9, 5)(2, 6, 11, 12), (1, 10, 9, 5)(2, 12, 11, 6)\}. \end{aligned}$$

Calculation shows that $\widetilde{\mathcal{P}}$ is transitive on $\widetilde{\Omega}$, i.e., for any element, for example $1 \in \widetilde{\Omega}$,

$$1^{\widetilde{\mathcal{P}}} = \{1, 2, 3, 4, 5, 6, 7, 8, 9, 10, 11, 12\}.$$

Generally, we know the following result on the globally transitive of permutation multigroup, a generalization of Theorem 2.6.8 motivated by Example 2.6.2.

Theorem 2.6.9 *Let $\widetilde{\mathcal{P}}$ be a permutation multigroup action on $\widetilde{\Omega}$ with $\widetilde{\mathcal{P}} = \bigcup_{i=1}^m \mathcal{P}_i$, $\widetilde{\Omega} = \bigcup_{i=1}^m \Omega_i$, where each permutation group \mathcal{P}_i acts on Ω_i with orbits \mathcal{B}_{ij} , $1 \leq j \leq |\text{Orb}(\Omega_i)|$ for integers $1 \leq i \leq m$. Then $\widetilde{\mathcal{P}}$ is globally transitive on $\widetilde{\Omega}$ if and only if for integer i, j , $1 \leq i \leq m$, $1 \leq j \leq |\text{Orb}(\Omega_i)|$, there exist integers k , $1 \leq k \leq m$, $1 \leq l \leq |\text{Orb}(\Omega_k)|$, $k \neq i$ such that*

$$\Omega_{ij} \cap \Omega_{kl} \neq \emptyset.$$

Proof Define a multiset

$$\widetilde{\Omega} = \bigcup_{i=1}^m \Omega_i = \bigcup_{i=1}^m \left(\bigcup_{j=1}^{|\text{Orb}(\Omega_i)|} \mathcal{B}_{ij} \right).$$

Then \mathcal{P}_i acts on each \mathcal{B}_{ij} is transitive by definition for $1 \leq i \leq m$, $1 \leq j \leq |\text{Orb}(\Omega_i)|$ and the result is followed by Theorem 2.6.8. \square

Counting elements in each Ω_i , $1 \leq i \leq m$, we immediately get the following consequence by Theorem 2.6.9.

Corollary 2.6.3 *Let $\widetilde{\mathcal{P}}$ be a permutation multigroup globally transitive action on $\widetilde{\Omega}$ with $\widetilde{\mathcal{P}} = \bigcup_{i=1}^m \mathcal{P}_i$, $\widetilde{\Omega} = \bigcup_{i=1}^m \Omega_i$, where each permutation group \mathcal{P}_i acts on Ω_i with orbits \mathcal{B}_{ij} , $1 \leq j \leq |\text{Orb}(\Omega_i)|$ for integers $1 \leq i \leq m$. Then for any integer i , $1 \leq i \leq m$,*

$$|\widetilde{\Omega} \setminus \Omega_i| \geq |\text{Orb}(\Omega_i)|,$$

particularly, if $m = 2$ then

$$|\Omega_1| \geq |\text{Orb}(\Omega_2)| \text{ and } |\Omega_2| \geq |\text{Orb}(\Omega_1)|.$$

A permutation multigroup $\widetilde{\mathcal{P}} = \bigcup_{i=1}^m \mathcal{P}_i$ action on $\widetilde{\Omega} = \bigcup_{i=1}^m \Omega_i$ is said to be *globally primitive* if there are no proper subsets $A \subset \widetilde{\Omega}$, $|A| \geq 2$ such that either $A = A^\pi$ or $A \cap A^\pi = \emptyset$ for $\forall \pi \in \widetilde{\mathcal{P}}$ provided A^π existing for $\forall a \in A$.

Theorem 2.6.10 *A permutation multigroup $\widetilde{\mathcal{P}} = \bigcup_{i=1}^m \mathcal{P}_i$ action on $\widetilde{\Omega} = \bigcup_{i=1}^m \Omega_i$ is globally primitive if and only if \mathcal{P}_i action on Ω_i is primitive for any integer $1 \leq i \leq m$.*

Proof If $\widetilde{\mathcal{P}}$ action on $\widetilde{\Omega}$ is globally primitive, by definition we know that there are no proper subsets $A \subset \Omega_i$, $|A| \geq 2$ such that either $A = A^\pi$ or $A \cap A^\pi = \emptyset$ for $\forall \pi \in \mathcal{P}_i$, where $1 \leq i \leq m$. Whence, each \mathcal{P}_i primitively acts on Ω_i .

Conversely, if each \mathcal{P}_i action on Ω_i is primitive for integers $1 \leq i \leq m$, then there are no proper subsets $A \subset \Omega_i$, $|A| \geq 2$ such that either $A = A^\pi$ or $A \cap A^\pi = \emptyset$ for $\forall \pi \in \mathcal{P}_i$ for $1 \leq i \leq m$ by definition. Now let $\pi \in \mathcal{P}_i$ for an integer i , $1 \leq i \leq m$. Notice that A^π is existing for $\forall A \subset \widetilde{\Omega}$ if and only if $A \subset \Omega_i$. Consequently, $\widetilde{\mathcal{P}}$ action on $\widetilde{\Omega}$ is globally primitive by definition. \square

Combining Theorems 2.6.10 with 2.5.4, we get the following consequence.

Corollary 2.6.4 *Let $\widetilde{\mathcal{P}} = \bigcup_{i=1}^m \mathcal{P}_i$ be a permutation multigroup action on $\widetilde{\Omega} = \bigcup_{i=1}^m \Omega_i$, where \mathcal{P}_i is transitive and $(\mathcal{P}_i)_a$ is maximal for $\forall a \in \Omega_i$, $1 \leq i \leq m$. Then $\widetilde{\mathcal{P}}$ is globally primitive action on $\widetilde{\Omega}$.*

§2.7 REMARKS

2.7.1 There are many monographs on action groups such as those of [Wie1] and [DiM1]. In fact, every book on group theory partially discusses action groups with applications.

These materials in Sections 2.1, 2.2 2.3 and 2.5 are mainly extracted from [Wan1], [Rob1] and [DiM1], particularly, the O’Nan-Scott theorem on primitive groups.

2.7.2 A central but difficult problem in group theory is to classify groups of order n for any integer $n \geq 1$. The Sylow’s theorem on p -groups enables one to see a glimmer on classifying p -groups. However, this problem is also difficult in general. Today, we can only find the classification of p -groups with small power (See [Xum1] and [Zha1] for details). In fact, these techniques used for classifying p -groups are nothing but the group actions, i.e., application of action groups.

2.7.3 These permutation multigroups in Section 2.6 is in fact action multigroups, a kind of Smarandache multi-spaces first discussed in [Mao21] and [Mao25]. These conceptions such as those of locally k -transitive, locally primitive, k -transitive extended, primitive extended, globally transitive and globally primitive are first presented in this book. Certainly, there are many open problems on permutation multigroups, for example, *for a permutation group \mathcal{P} action on Ω , is there always an extended primitive action of \mathcal{P} on $\Omega \cup \Delta$ for a set Δ , $\Delta \cap \Omega = \emptyset$? Can we characterize such permutation groups \mathcal{P} or such sets Δ ?*

2.7.4 Theorems 2.6.8 and 2.6.9 completely determine the globally transitive multigroups. However, we can also find a more simple characterization by graphs in Chapter 3, in where we clarify the property of globally transitive is nothing but the connectedness on graphs. In fact, these conditions in Theorems 2.6.8 and 2.6.9 are essentially enables one to find a spanning tree, a kind of most simple connected graph on $\tilde{\Omega}$.

CHAPTER 3.

Graph Groups

An immediate applying field of action groups is to that of graphs for them easily to handle by intuition. By definition, a graph group is a subgroup of the automorphism group of a graph viewed as a permutation group of its vertices. In fact, graphs has a nice mathematical structure on objectives. Usually, the investigation on such structures enables one to find new important results in mathematics. For example, the well-known *Higman-Sims group*, one of these 26 sporadic simple groups was found by that of graph groups in 1968. Topics covered in the first 4 sections including graphs with operations, graph properties with results, Smarandachely graph properties, graph groups, vertex-transitive graphs, edge-transitive graphs, arc-transitive graphs, semi-arc groups with semi-arc transitive graph, \dots , etc.. A graph is itself a Smarandache multi-space by definition, which naturally provide us a nice source for get multigroups. In Section 3.5, we show how to get mutligroups on graphs, also find new graph invariants by that of graph multigroups, which will be useful for research graphs and getting localized symmetric graphs.

§3.1 GRAPHS

3.1.1 Graph. A graph G is an ordered 3-tuple $(V, E; I)$, where V, E are finite sets, $V \neq \emptyset$ and $I : E \rightarrow V \times V$. Call V the *vertex set* and E the *edge set* of G , denoted by $V(G)$ and $E(G)$, respectively. An element $v \in V(G)$ is *incident* with an element $e \in E(G)$ if $I(e) = (v, x)$ or (x, v) for an $x \in V(G)$. Usually, if $(u, v) = (v, u)$, denoted by uv or $vu \in E(G)$ for $\forall (u, v) \in E(G)$, then G is called to be a graph without orientation and abbreviated to *graph* for simplicity. Otherwise, it is called to be a directed graph with an orientation $u \rightarrow v$ on each edge (u, v) .

The cardinal numbers of $|V(G)|$ and $|E(G)|$ are called its *order* and *size* of a graph G , denoted by $|G|$ and $\varepsilon(G)$, respectively.

Let G be a graph. We can represent a graph G by locating each vertex u in G by a point $p(u)$, $p(u) \neq p(v)$ if $u \neq v$ and an edge (u, v) by a curve connecting points $p(u)$ and $p(v)$ on a plane \mathbf{R}^2 , where $p : G \rightarrow P$ is a mapping from the $V(G)$ to \mathbf{R}^2 .

For example, a graph $G = (V, E; I)$ with $V = \{v_1, v_2, v_3, v_4\}$, $E = \{e_1, e_2, e_3, e_4, e_5, e_6, e_7, e_8, e_9, e_{10}\}$ and $I(e_i) = (v_i, v_i)$, $1 \leq i \leq 4$; $I(e_5) = (v_1, v_2) = (v_2, v_1)$, $I(e_8) = (v_3, v_4) = (v_4, v_3)$, $I(e_6) = I(e_7) = (v_2, v_3) = (v_3, v_2)$, $I(e_9) = I(e_{10}) = (v_1, v_4) = (v_4, v_1)$ can be drawn on a plane as shown in Fig.3.1.1.

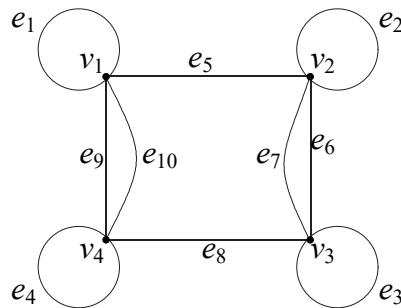

Fig. 3.1.1

Let $G = (V, E; I)$ be a graph. For $\forall e \in E$, if $I(e) = (u, u)$, $u \in V$, then e is called a *loop*. For example, edges $e_1 - e_4$ in Fig.3.1.1. For non-loop edges $e_1, e_2 \in E$, if $I(e_1) = I(e_2)$, then e_1, e_2 are called *multiple edges* of G . In Fig.3.1.1, edges e_6, e_7 and e_9, e_{10} are multiple edges. A graph is *simple* if it is loopless without multiple edges, i.e., $I(e) = (u, v)$ implies that $u \neq v$, and $I(e_1) \neq I(e_2)$ if $e_1 \neq e_2$ for $\forall e_1, e_2 \in E(G)$. In the case of simple graphs, an edge (u, v) is commonly abbreviated to uv .

A *walk* of a graph G is an alternating sequence of vertices and edges $u_1, e_1, u_2, e_2, \dots, e_n, u_n$ with $e_i = (u_i, u_{i+1})$ for $1 \leq i \leq n$. The number n is called the *length of the walk*. A walk is *closed* if $u_1 = u_{n+1}$, and *opened*, otherwise. For example, the sequence $v_1 e_1 v_1 e_5 v_2 e_6 v_3 e_3 v_3 e_7 v_2 e_2 v_2$ is a walk in Fig.1.3.1. A walk is a *trail* if all its edges are distinct and a *path* if all the vertices are distinct also. A closed path is usually called a *circuit* or *cycle*. For example, $v_1 v_2 v_3 v_4$ and $v_1 v_2 v_3 v_4 v_1$ are respective path and circuit in Fig.3.1.1.

A graph $G = (V, E; I)$ is *connected* if there is a path connecting any two vertices in this graph. In a graph, a maximal connected subgraph is called its a *component*.

Let G be a graph. For $\forall u \in V(G)$, the *neighborhood* $N_G(u)$ of the vertex u in G is defined by $N_G(u) = \{v | \forall (u, v) \in E(G)\}$. The cardinal number $|N_G(u)|$ is called the *valency of vertex u* in G and denoted by $\rho_G(u)$. A vertex v with $\rho_G(v) = 0$ is an *isolated vertex* and $\rho_G(v) = 1$ a *pendent vertex*. Now we arrange all vertices valency of G as a sequence $\rho_G(u), \rho_G(v), \dots, \rho_G(w)$ with $\rho_G(u) \geq \rho_G(v) \geq \dots \geq \rho_G(w)$, and denote $\Delta(G) = \rho_G(u)$, $\delta(G) = \rho_G(w)$ and call then the maximum or minimum valency of G , respectively. This sequence $\rho_G(u), \rho_G(v), \dots, \rho_G(w)$ is usually called the *valency sequence* of G . If $\Delta(G) = \delta(G) = r$, such a graph G is called a r -regular graph. For example, the valency sequence of graph in Fig.3.1.1 is $(5, 5, 5, 5)$, which is a 5-regular graph.

By enumerating edges in $E(G)$, the following equality is obvious.

$$\sum_{u \in V(G)} \rho_G(u) = 2|E(G)|.$$

A graph G with a vertex set $V(G) = \{v_1, v_2, \dots, v_p\}$ and an edge set $E(G) = \{e_1, e_2, \dots, e_q\}$ can be also described by those of matrixes. One such matrix is a $p \times q$ *adjacency matrix* $A(G) = [a_{ij}]_{p \times q}$, where $a_{ij} = |I^{-1}(v_i, v_j)|$. Thus, the adjacency matrix of a graph G is symmetric and is a 0, 1-matrix having 0 entries on its main diagonal if G is simple. For example, the matrix $A(G)$ of the graph in Fig.3.1.1 is

$$A(G) = \begin{bmatrix} 1 & 1 & 0 & 2 \\ 1 & 1 & 2 & 0 \\ 0 & 2 & 1 & 1 \\ 2 & 0 & 1 & 1 \end{bmatrix}$$

Let $G_1 = (V_1, E_1; I_1)$ and $G_2 = (V_2, E_2; I_2)$ be two graphs. They are *identical*, denoted by $G_1 = G_2$ if $V_1 = V_2, E_1 = E_2$ and $I_1 = I_2$. If there exists a 1 - 1 mapping $\phi : E_1 \rightarrow$

E_2 and $\phi : V_1 \rightarrow V_2$ such that $\phi I_1(e) = I_2\phi(e)$ for $\forall e \in E_1$ with the convention that $\phi(u, v) = (\phi(u), \phi(v))$, then we say that G_1 is *isomorphic* to G_2 , denoted by $G_1 \cong G_2$ and ϕ an *isomorphism* between G_1 and G_2 . For simple graphs H_1, H_2 , this definition can be simplified by $(u, v) \in I_1(E_1)$ if and only if $(\phi(u), \phi(v)) \in I_2(E_2)$ for $\forall u, v \in V_1$.

For example, let $G_1 = (V_1, E_1; I_1)$ and $G_2 = (V_2, E_2; I_2)$ be two graphs with

$$V_1 = \{v_1, v_2, v_3\}, \quad E_1 = \{e_1, e_2, e_3, e_4\},$$

$$I_1(e_1) = (v_1, v_2), I_1(e_2) = (v_2, v_3), I_1(e_3) = (v_3, v_1), I_1(e_4) = (v_1, v_1)$$

and

$$V_2 = \{u_1, u_2, u_3\}, \quad E_2 = \{f_1, f_2, f_3, f_4\},$$

$$I_2(f_1) = (u_1, u_2), I_2(f_2) = (u_2, u_3), I_2(f_3) = (u_3, u_1), I_2(f_4) = (u_2, u_2),$$

i.e., those graphs shown in Fig.3.1.2.

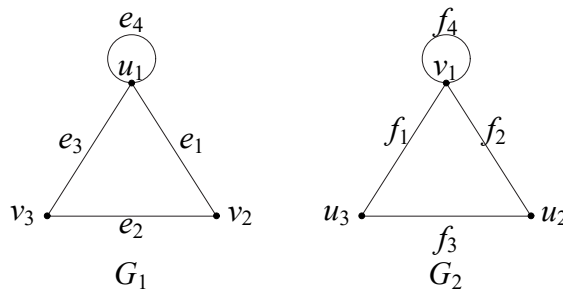

Fig. 3.1.2

Define a mapping $\phi : E_1 \cup V_1 \rightarrow E_2 \cup V_2$ by $\phi(e_1) = f_1, \phi(e_2) = f_2, \phi(e_3) = f_3, \phi(e_4) = f_4$ and $\phi(v_i) = u_i$ for $1 \leq i \leq 3$. It can be verified immediately that $\phi I_1(e) = I_2\phi(e)$ for $\forall e \in E_1$. Therefore, ϕ is an isomorphism between G_1 and G_2 , i.e., G_1 and G_2 are isomorphic.

A graph $H = (V_1, E_1; I_1)$ is a *subgraph* of a graph $G = (V, E; I)$ if $V_1 \subseteq V, E_1 \subseteq E$ and $I_1 : E_1 \rightarrow V_1 \times V_1$. We use $H < G$ to denote that H is a subgraph of G . For example, graphs G_1, G_2, G_3 are subgraphs of the graph G in Fig.3.1.3.

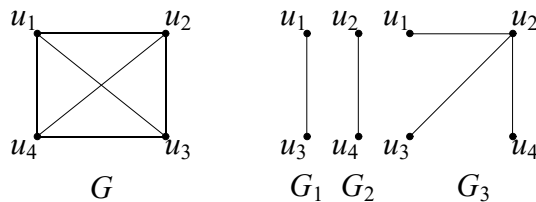

Fig. 3.1.3

For a nonempty subset U of the vertex set $V(G)$ of a graph G , the subgraph $\langle U \rangle$ of G induced by U is a graph having vertex set U and whose edge set consists of those edges of G incident with elements of U . A subgraph H of G is called *vertex-induced* if $H \cong \langle U \rangle$ for some subset U of $V(G)$. Similarly, for a nonempty subset F of $E(G)$, the subgraph $\langle F \rangle$ induced by F in G is a graph having edge set F and whose vertex set consists of vertices of G incident with at least one edge of F . A subgraph H of G is *edge-induced* if $H \cong \langle F \rangle$ for some subset F of $E(G)$. In Fig.3.1.3, subgraphs G_1 and G_2 are both vertex-induced subgraphs $\langle \{u_1, u_4\} \rangle$, $\langle \{u_2, u_3\} \rangle$ and edge-induced subgraphs $\langle \{(u_1, u_4)\} \rangle$, $\langle \{(u_2, u_3)\} \rangle$. For a subgraph H of G , if $|V(H)| = |V(G)|$, then H is called a *spanning subgraph* of G . In Fig.3.1.3, the subgraph G_3 is a spanning subgraph of the graph G .

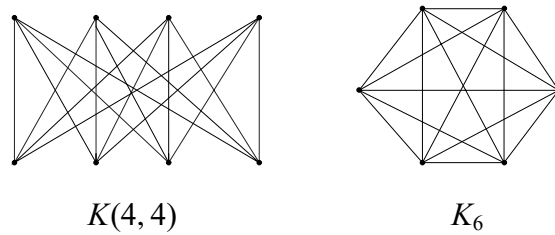

Fig.3.1.4

A graph G is n -partite for an integer $n \geq 1$, if it is possible to partition $V(G)$ into n subsets V_1, V_2, \dots, V_n such that every edge joins a vertex of V_i to a vertex of V_j , $j \neq i$, $1 \leq i, j \leq n$. A *complete n -partite graph* G is such an n -partite graph with edges $uv \in E(G)$ for $\forall u \in V_i$ and $v \in V_j$ for $1 \leq i, j \leq n$, denoted by $K(p_1, p_2, \dots, p_n)$ if $|V_i| = p_i$ for integers $1 \leq i \leq n$. Particularly, if $|V_i| = 1$ for integers $1 \leq i \leq n$, such a complete n -partite graph is called *complete graph* and denoted by K_n . In Fig.3.1.4, we can find the bipartite graph $K(4, 4)$ and the complete graph K_6 . Usually, a complete subgraph of a graph is called a *clique*, and its a k -regular vertex-spanning subgraph also called a *k -factor*.

3.1.2 Graph Operation. A union $G_1 \cup G_2$ of graphs G_1 with G_2 is defined by

$$V(G_1 \cup G_2) = V_1 \cup V_2, E(G_1 \cup G_2) = E_1 \cup E_2, I(E_1 \cup E_2) = I_1(E_1) \cup I_2(E_2).$$

A graph consists of k disjoint copies of a graph H , $k \geq 1$ is denoted by $G = kH$. As an example, we find that

$$K_6 = \bigcup_{i=1}^5 S_{1,i}$$

for graphs shown in Fig.3.1.5 following

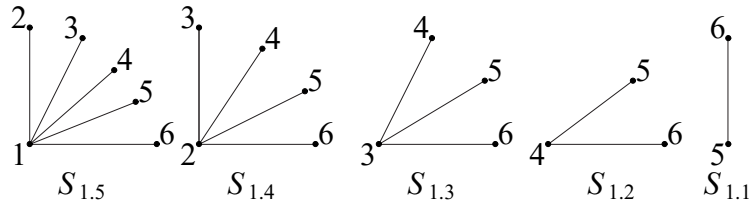

Fig. 3.1.5

and generally, $K_n = \bigcup_{i=1}^{n-1} S_{1,i}$. Notice that kG is a multigraph with edge multiple k for any integer $k, k \geq 2$ and a simple graph G .

A *complement* \overline{G} of a graph G is a graph with vertex set $V(G)$ such that vertices are adjacent in \overline{G} if and only if these are not adjacent in G . A *join* $G_1 + G_2$ of G_1 with G_2 is defined by

$$V(G_1 + G_2) = V(G_1) \cup V(G_2),$$

$$E(G_1 + G_2) = E(G_1) \cup E(G_2) \cup \{(u, v) | u \in V(G_1), v \in V(G_2)\}$$

and

$$I(G_1 + G_2) = I(G_1) \cup I(G_2) \cup \{I(u, v) = (u, v) | u \in V(G_1), v \in V(G_2)\}.$$

Applying the join operation, we know that $K(m, n) \cong \overline{K_m} + \overline{K_n}$. A *Cartesian product* $G_1 \times G_2$ of graphs G_1 with G_2 is defined by $V(G_1 \times G_2) = V(G_1) \times V(G_2)$ and two vertices (u_1, u_2) and (v_1, v_2) of $G_1 \times G_2$ are adjacent if and only if either $u_1 = v_1$ and $(u_2, v_2) \in E(G_2)$ or $u_2 = v_2$ and $(u_1, v_1) \in E(G_1)$. For example, $K_2 \times P_6$ is shown in Fig.3.1.6 following.

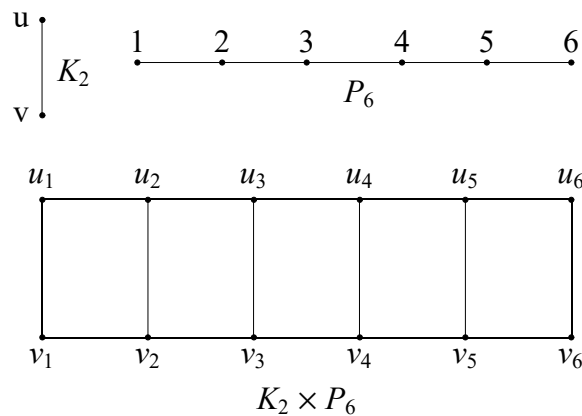

Fig.3.1.6

3.1.3 Graph Property. A graph property \mathcal{P} is in fact a graph family

$$\mathcal{P} = \{G_1, G_2, G_3, \dots, G_n, \dots\}$$

closed under isomorphism, i.e., $G^\varphi \in \mathcal{P}$ for any isomorphism on a graph $G \in \mathcal{P}$. We alphabetically list some graph properties and results without proofs following.

Colorable. A coloring of a graph G by colors in \mathcal{C} is a mapping $\varphi : \mathcal{C} \rightarrow V(G) \cup E(G)$ such that $\varphi(u) \neq \varphi(v)$ if u is adjacent or incident with v in G . Usually, a coloring $\varphi|_{V(G)} : \mathcal{C} \rightarrow V(G)$ is called a *vertex coloring* and $\varphi|_{E(G)} : \mathcal{C} \rightarrow E(G)$ an *edge coloring*. A graph G is *n-colorable* if there exists a color set \mathcal{C} for an integer $n \geq |\mathcal{C}|$. The minimum number n for which a graph G is vertex n -colorable, edge n -colorable is called the *vertex chromatic number* or *edge chromatic number* and denoted by $\chi(G)$ or $\chi_1(G)$, respectively. The following result is well-known for colorable of a graph.

Theorem 3.1.1 *Let G be a connected graph. Then*

- (1) $\chi(G) \leq \Delta(G) + 1$ and with the equality hold if and only if G is either an odd circuit or a complete graph; (Brooks theorem)
- (2) $\chi_1(G) = \Delta(G)$ or $\Delta(G) + 1$; (Vizing theorem)

Theorem 3.1.1(2) enables one to classify graphs into Class 1, Class 2 by $\chi_1(G) = \Delta(G)$ or $\chi_1(G) = \Delta(G) + 1$, respectively.

Connectivity. For an integer $k \geq 1$, a graph G is said to be *k-connected* if removing elements in $X \subset V(G) \cup E(G)$ with $|X| = k$ still remains a connected graph $G - X$. Usually, we call G to be *vertex k-connected* or *edge k-connected* if $X \subset V(G)$ or $X \subset E(G)$ and abbreviate vertex k -connected to *k-connected* in reference. The minimum cardinal number of $X \subset V(G)$ or $X \subset E(G)$ is defined to be the *connectivity* or *edge-connectivity* of G , denoted respectively by $\kappa(G)$, $\kappa_1(G)$. A fundamental result for characterizing connectivity of a graph is the Menger theorem following.

Theorem 3.1.2(Menger) *Let u and v be non-adjacent vertices in a graph G . Then the minimum number of vertices that separate u and v is equal to that the maximum number of internally disjoint $u - v$ paths in G .*

Then we can characterize k -connected or k -edge-connected graphs following.

Theorem 3.1.3 *Let G be a non-trivial graph. Then*

(1) G is k -connected if and only if for $\forall u, v \in V(G)$, $u \neq v$, there are at least k internally disjoint $u - v$ paths in G . (Whinety)

(2) G is k -edge-connected if and only if for $\forall u, v \in V(G)$, $u \neq v$, there are at least k edge-disjoint $u - v$ paths in G .

Covering. A subset $W \subset V(G) \cup E(G)$ is *independent* if any two element in W is non-adjacent or non-incident. A vertex and an edge in a graph are said to be *cover* each other if they are incident and a *cover* of G is such a subset $U \subset V(G) \cup E(G)$ such that any element in $V(G) \cup E(G) \setminus U$ is incident to an element in U . If $U \subset V(G)$ or $U \subset E(G)$, such an independent set is called *vertex independent* or *edge independent* and such a covering a *vertex cover* or *edge cover*. Usually, we denote the minimum cardinality of vertex cover, edge cover of a graph G by $\alpha(G)$ an $\alpha_1(G)$ and the maximum cardinality of vertex independent set, edge independent set by $\beta(G)$ and $\beta_1(G)$, respectively.

Theorem 3.1.4(Gallai) *Let G be a graph of order p without isolated vertices. Then*

$$\alpha(G) + \beta(G) = p \quad \text{and} \quad \alpha_1(G) + \beta_1(G) = p.$$

A *dominating set* D of a graph G is such a subset $D \subset V(G) \cup E(G)$ such that every element is adjacent to an element in D . If $D \subset V(G)$ or $D \subset E(G)$, such a dominating set D of G is called a *vertex* or *edge dominating set*. The minimum cardinality of vertex or edge dominating set is denoted by $\sigma(G)$ or $\sigma_1(G)$, called the *vertex* or *edge dominating number*, respectively. The following is obvious by definition.

Theorem 3.1.5 *Let G be a graph. Then*

$$\sigma(G) \leq \alpha(G) \quad \text{and} \quad \sigma_1(G) \leq \beta_1(G).$$

Decomposable. A *decomposition* of a graph G is subgraphs H_i ; $1 \leq i \leq m$ of G such that $H_i = \langle E_i \rangle$ for some subset $E_i \subset E(G)$ with $E_i \cap E_j = \emptyset$ for $j \neq i$, $1 \leq j \leq m$, usually denoted by

$$G = \bigoplus_{i=1}^m H_i.$$

If every H_i is a spanning subgraph of G , such a decomposition is called a *factorization* of G into factors H_i ; $1 \leq i \leq m$. Furthermore, if every H_i is k -regular, such a decomposition is called *k -factorable* and each H_i is a *k -factor* of G .

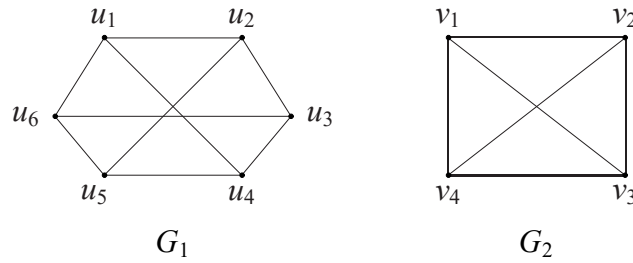

Fig.3.1.7

For example, we know that

$$G_1 = H_1 \oplus H_2, \text{ and } G_2 = F_1 \oplus F_2 \oplus F_3$$

for graphs G_1, G_2 in Fig.3.1.8, where $H_1 = \langle u_1u_4, u_2u_3, u_5u_6 \rangle$, $h_2 = \langle u_1u_6, u_2u_5, u_3u_4 \rangle$ and $F_1 = \langle v_1v_2, v_3v_4 \rangle$, $F_2 = \langle v_1v_4, v_2v_3 \rangle$, $F_3 = \langle v_1v_3, v_2v_4 \rangle$. Notice that every H_i or F_i is 1-regular. Such a spanning subgraph in a graph G is called a *perfect matching* of G .

Theorem 3.1.6(Tutte) *A non-trivial graph G has a perfect matching if and only if for every proper subset $S \subset V(G)$,*

$$\omega(G - S) \leq |S|,$$

where $\omega(H)$ denotes the number of odd components in a graph H .

Theorem 3.1.7(König) *Every k -regular bipartite graph with $k \geq 1$ is 1-factorable.*

Theorem 3.1.8(Petersen) *A non-trivial graph G is 2-factorable if and only if G is $2n$ -regular for some integer $n \geq 1$.*

Embeddable. A graph G is said to be embeddable into a topological space \mathcal{T} if there is a 1 – 1 continuous mapping $f : G \rightarrow \mathcal{T}$ with $f(p) \neq f(q)$ if $p, q \notin V(G)$. Particularly, if \mathcal{T} is a Euclidean plane \mathbf{R}^2 , we say that G is a *planar graph*. In a planar graph G , its *face* is defined to be that region F in which any simple curve can be continuously deformed in this region to a single point $p \in F$. For example, the graph in Fig.3.1.8 is a planar graph.

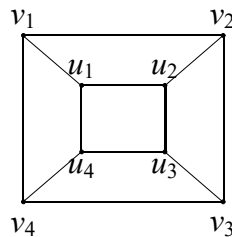

Fig.3.1.8

whose faces are $F_1 = u_1u_2v_3u_4u_1$, $F_2 = v_1v_2v_3v_4v_1$, $F_3 = u_1v_1v_2u_2u_1$, $F_4 = u_2v_2v_3u_3u_2$, $F_5 = u_3v_3v_4u_4u_3$ and $F_6 = u_4v_4v_1u_1u_4$. It should be noted that each boundary of a face in this planar graph is a circuit. Such an embedding graph is called a *strong embedded graph*.

Theorem 3.1.9(Euler) *Let G be a planar graph with p vertices, q edges and r faces. Then*

$$p - q + r = 2.$$

An *elementary subdivision* of a graph G is such a graph obtained from G by removing some edge $e = uv$ and adding a new vertex and two edges uw, vw . A *subdivision* of a graph G is a graph by a succession of elementary subdivision. Define a graph H *homeomorphic* from that of G if either $H \cong G$ or H is isomorphic to a subdivision of G . The following result characterizes planar graphs.

Theorem 3.1.10(Kuratowski) *A graph is planar if and only if it contains no subgraphs homeomorphic with K_5 or $K(3, 3)$.*

Theorem 3.1.11(The Four Color Theorem) *Every planar graph is 4-colorable.*

Travelable. A graph G is *eulerian* if there is a closed trail containing all edges and is *hamiltonian* if there is a circuit containing all vertices of G . For example, the graph in Fig.3.1.6 is with a hamiltonian circuit $C = v_1v_2v_3v_4u_4u_3u_2u_2v_1$, but it is not eulerian. We know a necessary and sufficient condition for eulerian graphs following.

Theorem 3.1.12(Euler) *A graph G is eulerian if and only if $\rho_G(v) \equiv 0 \pmod{2}$, $\forall v \in V(G)$.*

But for hamiltonian graphs, we only know some sufficient conditions. For example, the following results.

Theorem 3.1.13(Chvátal and Erdős) *Let G be a graph with at least 3 vertices. If $\kappa(G) \geq \beta(G)$, then G is hamiltonian.*

A *closure* $C(G)$ of a graph G is the graph obtained by recursively joining pairs of non-adjacent vertices whose valency sum is at least $|G|$. Then we know the next result.

Theorem 3.1.14(Bondy and Chátal) *A graph is hamiltonian if and only if its closure is hamiltonian.*

Theorem 3.1.15(Tutte) *Every 4-connected planar graph is hamiltonian.*

3.1.4 Smarandachely Graph Property. A graph property \mathcal{P} is *Smarandachely* if it behaves in at least two different ways on a graph, i.e., validated and invalidated, or only invalidated but in multiple distinct ways. Such a graph with at least one Smarandachely graph property is called a *Smarandachely graph*. Here, we only alphabetically list some Smarandachely graph properties and results with some open problems following.

Smarandachely Coloring. Let Λ be a subgraph of a graph G . A *Smarandachely Λ -coloring* of a graph G by colors in \mathcal{C} is a mapping $\varphi_\Lambda : \mathcal{C} \rightarrow V(G) \cup E(G)$ such that $\varphi(u) \neq \varphi(v)$ if u and v are elements of a subgraph isomorphic to Λ in G . Similarly, a Smarandachely Λ -coloring $\varphi_{\Lambda|V(G)} : \mathcal{C} \rightarrow V(G)$ or $\varphi_{\Lambda|E(G)} : \mathcal{C} \rightarrow E(G)$ is called a *vertex Smarandachely Λ -coloring* or an *edge Smarandachely Λ -coloring*. A graph G is *Smarandachely n Λ -colorable* if there exists a color set \mathcal{C} for an integer $n \geq |\mathcal{C}|$. The minimum number n for which a graph G is Smarandachely vertex n Λ -colorable, Smarandachely edge n Λ -colorable is called the *vertex Smarandachely chromatic Λ -number* or *edge Smarandachely chromatic Λ -number* and denoted by $\chi^\Lambda(G)$ or $\chi_1^\Lambda(G)$, respectively. Particularly, if $\Lambda = P_2$, i.e., an edge, then a vertex Smarandachely Λ -coloring or an edge Smarandachely Λ -coloring is nothing but the vertex coloring or edge coloring of a graph. This implies that $\chi^\Lambda(G) = \chi(G)$ and $\chi_1^\Lambda(G) = \chi_1(G)$ if $\Lambda = P_2$. But in general, the Smarandachely Λ -coloring of a graph G is different from that of its coloring. For example, $\chi^{P_2}(P_n) = \chi_1^{P_2} = 2$, $\chi^{P_k}(P_n) = k$, $\chi_1^{P_k}(P_n) = k - 1$ for any integer $1 \leq k \leq n$ and a Smarandachely P_3 -coloring on P_7 can be found in Fig.3.1.9 following.

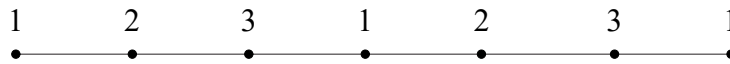

Fig.3.1.9

For the star $S_{1,n}$ and circuit C_n for integers $1 \leq k \leq n$, we can easily find that

$$\chi^{P_k}(S_{1,n}) = \begin{cases} 2 & \text{if } k = 2, \\ n + 1 & \text{if } k = 3, \\ 1 & \text{if } 4 \leq k \leq n, \end{cases}$$

$$\chi_1^{P_k}(S_{1,n}) = \begin{cases} 1 & \text{if } k = 2, \\ n & \text{if } k = 3, \\ 1 & \text{if } 4 \leq k \leq n \end{cases}$$

and

$$\begin{aligned}\chi^{P_k}(C_n) &= \chi_1^{P_k}(C_n) = \\ &= \min\{k + (i - 1) + s_i, 1 \leq i \leq n - k \mid n \equiv s_i \pmod{k + i - 1}, 0 \leq s_i < k + i - 1\}.\end{aligned}$$

The following result is known by definition.

Theorem 3.1.16 *Let H be a connected graph. Then*

- (1) $\chi^H(nH) = |V(H)|$ and $\chi_1^H(nH) = |E(H)|$, particularly, $\chi^G(G) = |V(G)|$ and $\chi_1^G(G) = |E(G)|$;
- (2) $\chi^H(G) = \chi_1^H(G) = 1$ if $H \not\prec G$.

Generally, we present the following problem.

Problem 3.1.1 *For a graph G , determine the numbers $\chi^\Lambda(G)$ and $\chi_1^\Lambda(G)$ for subgraphs $\Lambda \prec G$.*

Smarandachely Decomposition. Let \mathcal{P}_1 and \mathcal{P}_2 be graphical properties. A *Smarandachely $(\mathcal{P}_1, \mathcal{P}_2)$ -decomposition* of a graph G is a decomposition of G into subgraphs $G_1, G_2, \dots, G_l \in \mathcal{P}$ such that $G_i \in \mathcal{P}_1$ or $G_i \notin \mathcal{P}_2$ for integers $1 \leq i \leq l$.

If \mathcal{P}_1 or $\mathcal{P}_2 = \{\text{all graphs}\}$, a Smarandachely $(\mathcal{P}_1, \mathcal{P}_2)$ -decomposition of a graph G is said to be a *Smarandachely \mathcal{P} -decomposition*. Particularly, if $E(G_i) \cap E(G_j) \leq k$ and $\Delta(G_i) \leq d$ for integers $1 \leq i, j \leq l$, such a Smarandachely \mathcal{P} -decomposition is called a *Smarandache graphoidal (k, d) -cover* of a graph G .

Furthermore, if $d = \Delta(G)$ or $k = |G|$, i.e., a Smarandachely graphoidal $(k, \Delta(G))$ -cover with $\mathcal{P} = \{\text{path}\}$ or a Smarandachely graphoidal $(k, \Delta(G))$ -cover with $\mathcal{P} = \{\text{tree}\}$ is called a *Smarandachely path k -cover* or a *Smarandache graphoidal tree d -cover* of a graph G for integers $k, d \geq 1$. The minimum cardinalities of Smarandachely $(\mathcal{P}_1, \mathcal{P}_2)$ -decomposition and Smarandache graphoidal (k, d) -cover of a graph G are denoted by $\Pi_{\mathcal{P}_1, \mathcal{P}_2}(G)$, $\Pi_{\mathcal{P}}^{(k, d)}(G)$, respectively.

Problem 3.1.3 *For a graph G and properties $\mathcal{P}, \mathcal{P}_1, \mathcal{P}_2$, determine $\Pi_{\mathcal{P}_1, \mathcal{P}_2}(G)$ and $\Pi_{\mathcal{P}}^{(k, d)}(G)$.*

We only know partially results for Problem 3.1.3. For example,

$$\Pi_{\mathcal{P}}^{(1, \Delta(G))}(T) = \pi(T) = \frac{k}{2}$$

for a tree T with k vertices of odd degree and

$$\Pi_{\mathcal{P}}^{(1, \Delta(G))}(W_n) = \begin{cases} 6 & \text{if } n = 4, \\ \lfloor \frac{n}{2} \rfloor + 3 & \text{if } n \geq 5 \end{cases}$$

for a wheel $W_n = K_1 + C_{n-1}$ appeared in references [SNM1]-[SNM2].

Smarandachely Embeddable. Let \mathcal{T}_1 and \mathcal{T}_2 be two topological spaces. A graph G is said to be *Smarandachely $(\mathcal{T}_1, \mathcal{T}_2)$ -embeddable* into topological spaces \mathcal{T}_1 and \mathcal{T}_2 if there exists a decomposition $G = F \oplus H_1 \oplus H_2$, where F is a subgraph of G with a given property \mathcal{P} , H_1, H_2 are spanning subgraphs of G with two 1 – 1 continuous mappings $f : H_1 \rightarrow \mathcal{T}_1$ and $g : H_2 \rightarrow \mathcal{T}_2$ such that $f(p) \neq f(q)$ and $g(p) \neq g(q)$ if $p, q \notin V(G)$. Furthermore, if \mathcal{T}_1 or $\mathcal{T}_2 = \emptyset$, i.e., a Smarandachely (\mathcal{T}, \emptyset) -embeddable graph G is such a graph embeddable in \mathcal{T} if we remove a subgraph of G with a property \mathcal{P} . Whence, we know the following result for Smarandachely embeddable graphs by definition.

Theorem 3.1.17 *Let \mathcal{T} be topological space, G a graph and \mathcal{P} a graphical property. Then G is Smarandachely embeddable in \mathcal{T} if and only if there is a subgraph $H < G$ such that $G - H$ is embeddable in \mathcal{T} .*

Particularly, if \mathcal{T} is the Euclidean plane \mathbf{R}^2 and F a 1-factor, such a Smarandachely embeddable graph G is called to be a *Smarandachely planar graph*. For example, although the graph $K_{3,3}$ is not planar, but it is a Smarandachely planar graph shown in Fig.3.1.10, where $F = \{u_1v_1, u_2v_2, u_3v_3\}$.

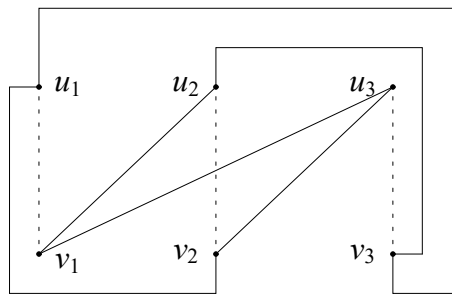

Fig.3.1.10

Problem 3.1.4 *Let \mathcal{T} be a topological space. Determine which graph G is Smarandachely \mathcal{T} -embeddable.*

The following result is an immediately consequence of Theorem 3.1.10.

Theorem 3.1.18 *A graph G is Smarandachely planar if and only if there exists a 1-factor $F < G$ such that there are no subgraphs homeomorphic to K_5 or $K_{3,3}$ in $G - F$.*

§3.2 GRAPH GROUPS

3.2.1 Graph Automorphism. Let G_1 and G_2 be two isomorphic graphs. If $G_1 = G_2 = G$, an isomorphism between G_1 and G_2 is called to be an *automorphism* of G . It should be noted that all automorphisms of a graph G form a group under the composition operation, i.e., $\phi\theta(x) = \phi(\theta(x))$, where $x \in E(G) \cup V(G)$. Such a graph is called the *automorphism group* of G and denoted by $\text{Aut}G$.

G	$\text{Aut}G$	order
P_n	Z_2	2
C_n	D_n	$2n$
K_n	S_n	$n!$
$K_{m,n}(m \neq n)$	$S_m \times S_n$	$m!n!$
$K_{n,n}$	$S_2[S_n]$	$2n!^2$

Table 3.2.1

It can be immediately verified that $\text{Aut}G \leq S_n$, where $n = |G|$. In Table 3.2.1, we present automorphism groups of some graphs. But in general, it is very hard to present the automorphism group $\text{Aut}G$ of a graph G .

3.2.2 Graph Group. Let $(\Gamma; \circ)$ be a group. Then $(\Gamma; \circ)$ is said to be a *graph group* if there is a graph G such that (Γ, \circ) is isomorphic to a subgroup of $\text{Aut}G$. Frucht proved that *for any finite group $(\Gamma; \circ)$ there are always exists a graph G such that $\Gamma \cong \text{Aut}G$* in 1938. Whence, the set of automorphism groups of graphs is equal to that of groups.

Let $S \subset \Gamma$ with $1_\Gamma \notin S$ and $S^{-1} = \{x^{-1} | x \in S\} = S$. A *Cayley graph* $G = \text{Cay}(\Gamma : S)$ of Γ on $S \subset \Gamma$ is defined by

$$V(G) = \Gamma;$$

$$E(G) = \{(g, h) | g^{-1} \circ h \in S\}.$$

Then we know the following result.

Theorem 3.2.1 *Let $(\Gamma; \circ)$ be a finite group, $S \subset \Gamma, S^{-1} = S$ and $1_\Gamma \notin S$. Then $\mathcal{L}_\Gamma \leq \text{Aut}X$, where $X = \text{Cay}(\Gamma : S)$.*

Proof For $\forall g \in \Gamma$, we prove that the left representation $\tau_g : x \rightarrow g^{-1} \circ x$ of g for $\forall x \in \Gamma$ is an automorphism of X . In fact, by

$$(g^{-1} \circ x)^{-1} \circ (g^{-1} \circ y) = x^{-1} \circ g \circ g^{-1} \circ y = x^{-1} \circ y,$$

we know that

$$\tau_g(x, y) = (\tau_g(x), \tau_g(y)),$$

i.e., $\tau_g \in \text{Aut}(\text{Cay}(G : S))$. Whence, we get that $\mathcal{L}_\Gamma \leq \text{Cay}(\Gamma : S)$. \square

A Cayley graph $\text{Cay}(\Gamma : S)$ is called to be *normal* if $\mathcal{L}_\Gamma \triangleleft \text{Aut}(\text{Cay}(G : S))$, which was introduced by Xu for the study of arc-transitive or half-transitive graphs in [Xum2]. The importance of this conception on Cayley graphs can be found in the following result.

Theorem 3.2.2 *A Cayley graph $\text{Cay}(\Gamma : S)$ of a finite group $(\Gamma; \circ)$ on $S \subset \Gamma$ is normal if and only if $\text{Aut}(\text{Cay}(\Gamma : S)) = \mathcal{L}_\Gamma \circ \text{Aut}(\Gamma, S)$, where $\text{Aut}(\Gamma, S) = \{\alpha \in \text{Aut}\Gamma \mid S^\alpha = S\}$.*

Proof Notice that the normalizer of \mathcal{L}_Γ in the symmetric group S_Γ is $\mathcal{L}_\Gamma \circ \text{Aut}\Gamma$. We get that

$$N_{\text{Aut}(\text{Cay}(\Gamma:S))}(\mathcal{L}_\Gamma) = \mathcal{L}_\Gamma \circ \text{Aut}\Gamma \cap \text{Aut}(\text{Cay}(\Gamma : S)) = \mathcal{L}_\Gamma \circ (\text{Aut}\Gamma \cap A_{1_\Gamma}).$$

That is $N_{\text{Aut}(\text{Cay}(\Gamma:S))}(\mathcal{L}_\Gamma) = \mathcal{L}_\Gamma \circ \text{Aut}(\Gamma, S)$. Whence, $\text{Cay}(\Gamma : S)$ is normal if and only if $\text{Aut}(\text{Cay}(\Gamma : S)) = \mathcal{L}_\Gamma \circ \text{Aut}(\Gamma, S)$. \square

The following open problem presented by Xu in [Xum2] is important for finding the automorphism group of a graph.

Problem 3.2.1 *Determine all normally Cayley graphs for a finite group $(\Gamma; \circ)$.*

Today, we have know a few results partially answer Problem 3.2.1. Here we only list some of them without proof. The first result shows that all finite groups have a normal representation except for two special families.

Theorem 3.2.3([WWX1]) *There is a normal Cayley graph for a finite group except for groups $Z_4 \times Z_2$ and $Q_8 \times Z_2^m$ for $m \geq 0$.*

For Abelian groups, we know the following result for the normality of Cayley graphs.

Theorem 3.2.4([YYHX]) *Let $X = \text{Cay}(\Gamma : S)$ be a connected Cayley graph of an Abelian group $(\Gamma; \circ)$ on S with the valency of X at most 4. Then X is normal except for graphs listed in Table 3.2.2 following.*

row	Γ	S	X
1	Z_4	$\Gamma \setminus \{1_\Gamma\}$	$2K_4$
2	$Z_4 \times Z_2 = \langle a \rangle \times \langle b \rangle$	$\{a, a^{-1}, b\}$	Q_3 (cube)
3	$Z_6 = \langle a \rangle$	$\{a, a^3, a^5\}$	$K_{3,3}$
4	$Z_2^3 = \langle u \rangle \times \langle v \rangle \times \langle w \rangle$	$\{w, wu, wv, wuv\}$	$K_{4,4}$
5	$Z_4 \times Z_2 = \langle a \rangle \times \langle b \rangle$	$\{a, a^2, a^3, b\}$	$\overline{Q_3}$ (complement cube)
6	$Z_4 \times Z_2 = \langle a \rangle \times \langle b \rangle$	$\{a, a^{-1}, a^2b, b\}$	$K_{4,4}$
7	$Z_4 \times Z_2^2 = \langle a \rangle \times \langle b \rangle \times \langle c \rangle$	$\{a, a^{-1}, a^3, b\}$	Q_4 (4-dimensional cube)
8	$Z_6 \times Z_2 = \langle a \rangle \times \langle b \rangle$	$\{a, a^{-1}, a^3, b\}$	$K_{3,3} \times K_2$
9	$Z_4 \times Z_4 = \langle a \rangle \times \langle b \rangle$	$\{a, a^{-1}, b, b^{-1}\}$	$C_4 \times C_4$
10	$Z_m \times Z_2 = \langle a \rangle \times \langle b \rangle, m \geq 3$	$\{a, ab, a^{-1}, a^{-1}b\}$	$C_m[2K_1]$
11	$Z_{4m} = \langle a \rangle, m \geq 2$	$\{a, a^{2m+1}, a^{-1}, a^{2m-1}\}$	$C_{2m}[2K_1]$
12	$Z_5 = \langle a \rangle$	$\Gamma \setminus \{1_\Gamma\}$	K_5
11	$Z_{10} = \langle a \rangle$	$\{a, a^3, a^7, a^9\}$	$K_{5,5} - 5K_2$

Table 3.2.2

3.2.3 Γ -Action. Let Γ be a group of a graph G . Generally, there are three cases of Γ action on G shown in the following.

Γ -Action on Vertex Set. In this case, Γ acts on the vertex set $V(G)$ with orbits V_1, V_2, \dots, V_m , where $m \leq |V(G)|$. For example, let C_n be a circuit with $V(C_n) = \{v_1, v_2, \dots, v_n\}$. We have known its automorphism group by Table 3.2.1 to be

$$D_n = \{\rho^i \tau^j | 0 \leq i \leq n-1, 0 \leq j \leq 1\}$$

with

$$\rho^n = 1_{D_n}, \quad \tau^2 = 1_{D_n}, \quad \tau^{-1} \rho \tau = \rho^{-1},$$

such as the presentation in Example 1.2.4. Now let

$$\Gamma_1 = \langle \rho \rangle \quad \text{and} \quad \Gamma_2 = \langle \tau \rangle.$$

Then we know that there are only one orbit of Γ_1 action on C_n , i.e., $\{v_1, v_2, \dots, v_n\}$. But there are $\left\lfloor \frac{n}{2} \right\rfloor$ orbits if $n \equiv 1(\text{mod}2)$ or $\left\lfloor \frac{n}{2} \right\rfloor + 1$ orbits $n \equiv 0(\text{mod}2)$. For example, let τ a reflection joining the vertex v_1 with its opposite vertex if $n \equiv 0(\text{mod}2)$ or midpoint of its opposite edge if $n \equiv 1(\text{mod}2)$. Then we know the orbits of Γ_2 action on $V(C_n)$ to be $V_1 = \{v_1\}, V_2 = \{v_{n/2}\}; V_i = \{v_i, v_{n-i}\}$ for $1 < i < \frac{n}{2}$ if $n \equiv 0(\text{mod}2)$ or $V_1 = \{v_1\}; V_i = \{v_i, v_{n-i}\}$ for $1 < i < \frac{n+1}{2}$ if $n \equiv 1(\text{mod}2)$.

A graph G is called to be Γ -transitive or Γ -semiregular for its a group Γ if Γ is transitive or semi-regular action on $V(G)$. Particularly, if $\Gamma = \text{Aut}G$, a Γ -transitive graph G is called a *transitive graph*. By definition, a Γ -transitive graph G for any subgroup $\forall \Gamma \leq \text{Aut}G$ must be a transitive graph. But the inverse is not always true. For example, Γ_1 is transitive action on C_n in the previous example. Consequently it is a transitive graph but Γ_2 is not transitive on $V(G)$.

A simple calculation shows that the order of a Γ -semiregular graph G is multiple of length of its orbits. Let $n \equiv 0(\text{mod}2)$. If we choose τ to be a reflection joining the midpoint v_1v_n with that midpoint of $v_{n/2}v_{n/2+1}$ in the previous example, then Γ_2 is Γ_2 -semiregular action on $V(G)$. In this case, there are $\frac{n}{2}$ orbits of length 2, i.e., $V_i = \{v_i, v_{n-i+1}\}$ for $1 \leq i \leq \frac{n}{2}$.

Γ -Action on Edge Set. The Γ -action on $E(G)$ is an action

$$\varphi(x, y) = (\varphi(x), \varphi(y)) \in E(G) \quad \text{for} \quad \forall (x, y) \in E(G)$$

induced by an automorphism $\varphi \in \Gamma$ with orbits E_1, E_2, \dots, E_l , where $l \leq |E(G)|$. Naturally, all orbits of Γ action on $E(G)$ form a partition of $E(G)$.

Consider the graph G_1 shown in Fig.3.1.5. In this case, it is easily find that $D_6 = \{\rho^i \tau^j | 0 \leq i \leq 5, 0 \leq j \leq 1\}$ with $\rho^6 = 1_{D_6}, \tau^2 = 1_{D_6}, \tau^{-1} \rho \tau = \rho^{-1}$ is its a graph group, where τ is a reflection joining the midpoint u_1v_6 with that midpoint of u_3u_4 . The orbits E_1, E_2 of D_6 action on $E(G_1)$ are listed in the following.

$$E_1 = \{u_1u_2, u_2u_3, u_3u_4, u_4u_5, u_5u_6, u_6u_1\}, \quad E_2 = \{u_1u_4, u_2u_5, u_3u_4\}.$$

A graph G is called to be *edge Γ -transitive* for its a group Γ if Γ is transitive on $E(G)$. Particularly, if $\Gamma = \text{Aut}G$, an edge Γ -transitive graph G is called an *edge-transitive graph*.

Certainly, an edge Γ -transitive graph G for any subgroup $\forall \Gamma \leq \text{Aut}G$ must be an edge-transitive graph. But the inverse is not always true. For example, the complete graph K_n for an integer $n \geq 3$ is an edge-transitive graph with $\text{Aut}K_n = S_n$. Let $\Gamma = \langle \sigma \rangle$, where $\sigma \in \text{Aut}K_n$ with $\sigma^n = 1_{S_n}$. Then K_n is not edge Γ -transitive since $|\Gamma| = n < \frac{n(n-1)}{2} = |E(K_n)|$. By Theorem 2.2.1, Γ can not be transitive on $E(K_n)$.

Γ -Action on Arc Set. Denoted by $X(G) = \{(u, v) | uv \in E(G)\}$ the arc set of a graph G . The Γ -action on $X(G)$ is an action on $X(G)$ induced by

$$\varphi(x, y) = (\varphi(x), \varphi(y)) \in X(G) \quad \text{for } \forall (x, y) \in X(G)$$

for an automorphism $\varphi \in \Gamma$. Similarly, a graph G is called to be *arc Γ -transitive* for its a graph group Γ if Γ is transitive on $X(G)$, and to be *arc-transitive* if $\text{Aut}G$ is transitive on $X(G)$. The following result is obvious by definition.

Theorem 3.2.5 *Any arc Γ -transitive graph G is an edge Γ -transitive graph. Conversely, an edge Γ -transitive graph G is arc Γ -transitive if and only if there are involutions $\theta \in \Gamma$ such that $(x, y)^\theta = (y, x)$ for $\forall (x, y) \in E(G)$.*

§3.3 SYMMETRIC GRAPHS

3.3.1 Vertex-Transitive Graph. There are many vertex-transitive graphs. For example, by Theorem 3.2.1 we know that all Cayley graphs is vertex-transitive.

Theorem 3.3.1 *Any Cayley graph $\text{Cay}(\Gamma : S)$ on $S \subset \Gamma$ is vertex-transitive.*

Denoted by $(Z_n; +)$ the *additive group* module n with $Z_n = \{0, 1, 2, \dots, n-1\}$. A *circulant graph* is a Cayley graph $\text{Cay}(Z_n : S)$ for $S \subset S_n$. Theorem 3.3.1 implies that Cayley graphs are a subclass of vertex-transitive graphs. But if the order $|V(G)|$ of a vertex-transitive graph G is prime, Turner showed each of them is a Cayley graph, i.e., the following result in 1967.

Theorem 3.3.2 *If G is a vertex-transitive graph of prime order p , then it is a circulant graph.*

Proof Let $V(G) = \{u_0, u_1, \dots, u_{p-1}\}$ and H the stabilizer of u_0 . Suppose that $\sigma_i \in \text{Aut}G$ is such an element that $\sigma_i(u_0) = u_i$. Applying Theorem 2.2.1, we get that $|\text{Aut}G| =$

$|H||u_0^{\text{Aut}G}| = p|H|$. Thus $p||\text{Aut}G|$. By Sylow's theorem, there is a subgroup $K = \{1, \theta, \dots, \theta^{p-1}\}$ of order p in $\text{Aut}G$. Relabeling the vertices u_0, u_1, \dots, u_{p-1} by v_0, v_1, \dots, v_{p-1} so that $\theta(v_i) = v_{i+1}$ and $\theta(v_{p-1}) = v_0$ for $0 \leq i \leq p-2$. Suppose $(v_0, v_1) \in E(G)$. Then by definition, $(v_i, v_{2i}) = (v_0, v_1)^{\theta^i}$, $(v_{2i}, v_{3i}) = (v_1, v_{2i})^{\theta^i}$, \dots , $(v_{(p-1)i}, v_0) = (v_{(p-2)i}, v_{(p-1)i})^{\theta^i} \in E(G)$. Thus $v_0v_1v_{2i} \dots v_{(p-1)i}$ forms a circuit in G . Now if we write v_i as i and define $S = \{i|(v_0, v_i) \in E(G)\}$, then G is nothing but the circulant graph $\text{Cay}(Z_p : S)$. \square

It should be noted that *not every every vertex-transitive graph is a Cayley graph*. For example, the Petersen graph shown in Fig.3.3.1 is vertex-transitive but it is not a Cayley graph (See [Yap1] for details).

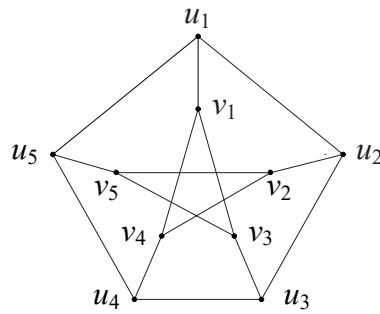

Fig.3.3.1

However, there is a constructing way shown in Theorem 3.3.4 following such that every vertex-transitive graph almost likes a Cayley graph, found by Sabidussi in 1964. For proving this result, we need the following result first.

Theorem 3.3.3 *Let \mathcal{H} be a subgroup of a finite group $(\Gamma; \circ)$ and S a subset of Γ with $S^{-1} = S$, $S \cap \mathcal{H} = \emptyset$. If G is a graph with vertex set $V(G) = \Gamma/\mathcal{H}$ and edge set $E(G) = \{(x \circ \mathcal{H}, y \circ \mathcal{H}) | x^{-1} \circ y \in \mathcal{H}S\mathcal{H}\}$, called the group-coset graph of Γ/\mathcal{H} respect to S and denoted by $G(\Gamma/\mathcal{H} : S)$, then G is vertex-transitive.*

Proof First, we claim the graph G is well-defined. This assertion need us to show that if $(x \circ \mathcal{H}, y \circ \mathcal{H}) \in E(G)$ and $x_1 \in x \circ \mathcal{H}$, $y_1 \in y \circ \mathcal{H}$, then there must be $(x_1 \circ \mathcal{H}, y_1 \circ \mathcal{H}) \in E(G)$. In fact, there are $h, g \in \mathcal{H}$ such that $x_1 = x \circ h$ and $y_1 = y \circ g$ by definition. Notice that

$$x^{-1} \circ y \in \mathcal{H}S\mathcal{H} \Rightarrow (x \circ h)^{-1} \circ (y \circ g) \in \mathcal{H}S\mathcal{H} \Rightarrow x_1^{-1} \circ y_1 \in \mathcal{H}S\mathcal{H}.$$

Whence, $(x \circ \mathcal{H}, y \circ \mathcal{H}) \in E(G)$ implies that $(x_1 \circ \mathcal{H}, y_1 \circ \mathcal{H}) \in E(G)$.

Now for each $g \in \Gamma$, define a permutation ϕ_g on $V(G) = \Gamma/\mathcal{H}$ by $\phi_g(x \circ \mathcal{H}) =$

$g \circ x \circ \mathcal{H}$ for $x \circ \mathcal{H} \in \Gamma/\mathcal{H}$. Then by

$$x^{-1} \circ y \in \mathcal{H}S\mathcal{H} \Rightarrow (g \circ x)^{-1} \circ (g \circ y) \in \mathcal{H}S\mathcal{H} \Rightarrow \phi_g^{-1}(x) \circ \phi_g(y) \in \mathcal{H}S\mathcal{H},$$

we find that $(x \circ \mathcal{H}, y \circ \mathcal{H}) \in E(G)$ implies that $(\phi_g(x) \circ \mathcal{H}, \phi_g(y) \circ \mathcal{H}) \in E(G)$. Therefore, ϕ_g is an automorphism of G .

Finally, for any $x \circ \mathcal{H}, y \circ \mathcal{H} \in V(G)$, let $g = y \circ x^{-1}$. Then $\phi_g(x \circ \mathcal{H}) = y \circ x^{-1} \circ (x \circ \mathcal{H}) = y \circ \mathcal{H}$. Whence, G is vertex-transitive. \square

Now we can prove the Sabidussi's representation theorem for finite groups following.

Theorem 3.3.4 *Let G be a vertex-transitive graph and $\mathcal{H} = (\text{Aut}G)_u$ the stabilizer of a vertex $u \in V(G)$ with the composition operation \circ . Then G is isomorphic with the group-coset graph $G(\text{Aut}G/\mathcal{H} : S)$, where S is the set of automorphisms σ of G such that $(u, \sigma(u)) \in E(G)$.*

Proof By definition, we easily find that $S^{-1} = S$ and $S \cap \mathcal{H} = \emptyset$. Define $\pi : \text{Aut}G/\mathcal{H} \rightarrow G$ by $\pi(x \circ \mathcal{H}) = x(u)$, where $x \circ \mathcal{H} \in \Gamma/\mathcal{H}$. We show that π is a mapping. In fact, let $x \circ \mathcal{H} = y \circ \mathcal{H}$. Then there is $h \in \mathcal{H}$ such that $y = x \circ h$. So

$$\pi(y \circ \mathcal{H}) = y(u) = (x \circ h)(u) = x(h(u)) = x(u) = \pi(x \circ \mathcal{H}).$$

Now we show that π is in fact a graph isomorphism following.

(1) π is 1-1. Otherwise, let $\pi(x \circ \mathcal{H}) = \pi(y \circ \mathcal{H})$. Then $x(u) = y(u) \Rightarrow y^{-1} \circ x(u) = u \Rightarrow y^{-1} \circ x \in \mathcal{H} \Rightarrow y \in x \circ \mathcal{H} \Rightarrow x \circ \mathcal{H} = y \circ \mathcal{H}$.

(2) π is onto. Let $v \in V(G)$. Notice that G is vertex-transitive. There exists $z \in \text{Aut}G$ such that $z(u) = v$, i.e., $\pi(z \circ \mathcal{H}) = z(u) = v$.

(3) π preserves adjacency in G . By definition, $(x \circ \mathcal{H}, y \circ \mathcal{H}) \in E(G(\text{Aut}G/\mathcal{H}, S)) \Leftrightarrow x^{-1} \circ y \in \mathcal{H}S\mathcal{H} \Leftrightarrow x^{-1} \circ y = h \circ z \circ g$ for some $h, g \in \mathcal{H}, z \in S \Leftrightarrow h^{-1} \circ x^{-1} \circ y \circ g^{-1} = z \Leftrightarrow (u, h^{-1} \circ x^{-1} \circ y \circ g^{-1}(u)) \in E(G) \Leftrightarrow (u, x^{-1} \circ y(u)) \in E(G) \Leftrightarrow (x(u), y(u)) \in E(G) \Leftrightarrow (\pi(x \circ \mathcal{H}), \pi(y \circ \mathcal{H})) \in E(G)$.

Combining (1)-(3), the proof is complete. \square

Theorem 3.3.4 enables one to know which vertex-transitive graph G is a Cayley graph. By Theorem 2.1.1(2), we know that any two stabilizers $(\text{Aut}G)_u, (\text{Aut}G)_v$ for $u, v \in V(G)$ are conjugate in $\text{Aut}G$. Consequently, $(\text{Aut}G)_u$ is normal if and only if $(\text{Aut}G)_u = \{1_{\text{Aut}G}\}$. By definition, the group-coset graph $G(\text{Aut}G/\mathcal{H} : S)$ in Theorem 3.3.4 is a

Cayley graph if and only if $\text{Aut}G/\mathcal{H}$ is a quotient group. But this just means that $\mathcal{H} \triangleleft \text{Aut}G$ by Theorem 1.3.2. Combining these facts, we get the necessary and sufficient condition for a vertex-transitive graph to be a Cayley graph by Theorem 3.3.4 following.

Theorem 3.3.5 *A vertex-transitive graph G is a Cayley graph if and only if the action of $\text{Aut}G$ on $V(G)$ is regular.*

Generally, let $(\Gamma; \circ)$ be a finite group. A graph G is called to be a *graphical regular representation* (GRR) of Γ if $\text{Aut}G \cong \Gamma$ and $\text{Aut}G$ acts regularly transitive on $V(G)$. Such a group Γ is called to have a GRR. We needed to answer the following problem.

Problem 3.3.1 *Determine each finite group Γ with a GRR.*

A simple case for Problem 3.3.1 is finite Abelian groups. We know the following result due to Chao and Sabidussi in 1964.

Theorem 3.3.6 *Let G be a graph with an Abelian automorphism group $\text{Aut}G$ acts transitively on $V(G)$. Then $\text{Aut}G$ acts regularly transitive on $V(G)$ and $\text{Aut}G$ is an elementary Abelian 2-group.*

Proof According to Theorem 2.2.2, we know that $\text{Aut}G$ acts regularly transitive on $V(G)$. Now since $\text{Aut}G$ acts regularly on $V(G)$, G is isomorphic to a Cayley graph $\text{Cay}(\text{Aut}G : S)$. Because $\text{Aut}G$ is Abelian, $\tau : g \rightarrow g^{-1}$ is an automorphism of $\text{Aut}G$ and fixes S setwise. It can be shown that this automorphism is an automorphism of $\text{Cay}(\text{Aut}G : S)$ fixing the identity element of $\text{Aut}G$. Whence, $g = \tau(g) = g^{-1}$ by the fact of regularity for every $g \in \text{Aut}G$. So $\text{Aut}G$ is an elementary 2-groups. \square

Theorem 3.3.6 claims that an Abelian group Γ has a GRR only if $\Gamma = Z_2^n$ for some integers $n \geq 1$. In fact, by the work of McAndrew in 1965, we know a complete answer for Problem 3.3.1 in this case following.

Theorem 3.3.7 *An Abelian group Γ has a GRR if and only if $\Gamma = Z_2^n$ for $n = 1$ or $n \geq 5$.*

A *generalized dicyclic group* $(\Gamma; \circ)$ is a non-Abelian group possessing a subgroup $(\mathcal{H}; \circ)$ of index 2 and an element γ of order 4 such that $\gamma^{-1} \circ h \circ \gamma = h^{-1}$ for $\forall h \in \mathcal{H}$. By following the work of Imrich, Nowitz, Watkins, Babai, etc., Hetzel and Godsil respectively answered Problem 3.3.1 for solvable groups and non-solvable groups. They get the following result (See [God1]-[God2] and [Cam1] for details) independently.

Theorem 3.3.8 *A finite group $(\Gamma; \circ)$ possesses no GRR if and only if it is an Abelian group of exponent greater than 2, a generalized dicyclic group, or one of 13 exceptional groups following:*

- (1) Z_2^2, Z_2^3, Z_2^4 ;
- (2) D_6, D_8, D_{10} ;
- (3) A_4 ;
- (4) $\langle a, b, c | a^2 = b^2 = c^2 = 1_\Gamma, a \circ b \circ c = b \circ c \circ a = c \circ a \circ b \rangle$;
- (5) $\langle a, b | a^8 = b^2 = 1_\Gamma, b \circ a \circ b = b^5 \rangle$;
- (6) $\langle a, b, c | a^3 = b^2 = c^3 = (a \circ b)^2 = (c \circ b)^2 = 1_\Gamma, a \circ c = c \circ a \rangle$;
- (7) $\langle a, b, c | a^3 = b^3 = c^3 = 1_\Gamma, a \circ c = c \circ a, b \circ c = c \circ b, c = a^{-1} \circ b^{-1} \circ a \circ b \rangle$;
- (8) $Q_8 \times Z_3, Q_8 \times Z_4$.

3.3.2 Edge-Transitive Graph. Certainly, the edge-transitive graphs are closely related with vertex-transitive graphs by definition. We can easily obtain the following result.

Theorem 3.3.9 *Let G be an edge-transitive graph without isolated vertices. Then*

- (1) G is vertex-transitive, or
- (2) G is bipartite with two vertex-orbits under the action $\text{Aut}G$ on $V(G)$ to be its vertex bipartition.

Proof Choose an edge $e = uv \in E(G)$. Denoted by V_1 and V_2 the orbits of u and v under the action of $\text{Aut}G$ on $V(G)$. Then we know that $V_1 \cup V_2 = V(G)$ by the edge-transitivity of G . Our discussion is divided into two cases following.

Case 1. If $V_1 \cap V_2 \neq \emptyset$, then G is vertex-transitive.

Let x and y be any two vertices of G . If $x, y \in V_1$ or $x, y \in V_2$, for example, $x, y \in V_1$, then there exist $\sigma, \zeta \in \text{Aut}G$ such that $\sigma(u) = x$ and $\zeta(u) = y$. Thus $\zeta\sigma^{-1}$ is such an automorphism with $\zeta\sigma^{-1}(x) = y$. If $x \in V_1$ and $y \in V_2$, let $w \in V_1 \cap V_2$. By assumption, there are $\phi, \varphi \in \text{Aut}G$ such that $\phi(x) = \varphi(y) = w$. Then we get that $\varphi^{-1}\phi(x) = y$, i.e., G is vertex-transitive.

Case 2. If $V_1 \cap V_2 = \emptyset$, then G is bipartite.

Let $x, y \in V_1$. If $xy \in E(G)$, then there are $\sigma \in \text{Aut}G$ such that $\sigma(uv) = xy$. But this implies that one of x, y in V_1 and another in V_2 , a contradiction. Similarly, if $x, y \in V_2$, then $xy \notin E(G)$. Whence, G is a bipartite graph. \square

We get the following consequences by this result.

Corollary 3.3.1 *Let G be a regular edge-transitive graph with an odd degree $d \geq 1$. If $|G| \equiv 1 \pmod{2}$, then G is vertex-transitive.*

Proof Notice that if G is bipartite, then $|V_1|d = |V_2|d = \varepsilon(G)$. Whence, $|G| = |V_1| + |V_2| \equiv 0 \pmod{2}$, a contradiction. \square

Corollary 3.3.2 *Let G be a regular edge-transitive graph of degree $d \geq |G|/2$. Then G is vertex-transitive.*

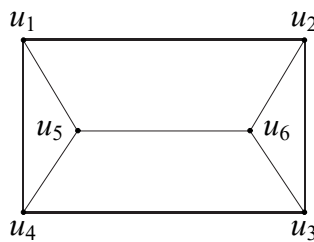

Fig.3.3.2

In fact, there are many edge-transitive but not vertex-transitive graphs, and vertex-transitive but not edge-transitive graphs. For example, the complete graph K_{n_1, n_2} with $n_1 \neq n_2$ is edge-transitive but not vertex-transitive, and the graph shown in Fig.3.3.2 is a vertex-transitive but not edge-transitive graph.

3.3.3 Arc-Transitive Graph. An s -arc of a graph G is a sequence of vertices v_0, v_1, \dots, v_s such that consecutive vertices are adjacent and $v_{i-1} \neq v_{i+1}$ for $0 < i < s$. For example, a circuit C_n is s -arc transitive for all $s \leq n$. A graph G is s -arc transitive if $\text{Aut}G$ is transitive on s -arcs. For $s \geq 1$, it is obvious that an s -arc transitive graph is also $(s-1)$ -arc transitive. A 0-arc transitive graph is just the vertex-transitive, and a 1-arc transitive graph is usually called to be *arc-transitive graph* or *symmetric graph*.

Tutte proved the following result for s -arc transitive cubic graphs in 1947 (See in [Yap1] for its proof).

Theorem 3.3.10 *Let G be a s -arc transitive cubic graph. Then $s \leq 5$.*

Examples of s -arc transitive cubic graphs for $s \leq 5$ can be found in [Big2] or [GoR1]. Now we turn our attention to symmetric graphs.

Let $Z_p = \{0, 1, \dots, p-1\}$ be the cyclic group of order p written additively. We know

that $\text{Aut}Z_p$ is isomorphic to Z_{p-1} . For a positive divisor r of $p-1$, let H_r denote the unique subgroup of $\text{Aut}Z_p$ of order r , $H_r \simeq Z_r$. Define a graph $G(p, r)$ of order p by

$$V(G(p, r)) = Z_p, \quad E(G(p, r)) = \{xy \mid x - y \in H_r\}.$$

A classification of symmetric graph with a prime order p was obtained by Chao. He proved the following result in 1971.

Theorem 3.3.11 *Let p be an odd prime. Then a graph G of order p is symmetric if and only if $G = pK_1$ or $G = G(p, r)$ for some even divisor r of $p-1$.*

In the reference [PWX1] and [WaX1], we can also find the classification of symmetric graphs of order a product of two distinct primes. For example, there are 12 classes of symmetric graphs of order $3p$, where $p > 3$ is a prime, including $3pK_1$, pK_3 , $3G(p, r)$ for an even divisor r of $p-1$, $G(3p, r)$ for a divisor of $p-1$, $G(p, r)[3K_1]$, K_{3p} and other 6 classes, where $G(3p, r)$ is defined by $V(G(3p, r)) = \{x_i \mid i \in Z_3, x \in Z_p\}$ and $E(G(3p, r)) = \{(x_i, y_{i+1}) \mid i \in Z_3, x, y \in Z_p \text{ and } y - x \in H_r\}$.

A graph G is *half-transitive* if G is vertex-transitive and edge-transitive, but not arc-transitive. Tutte found the following result.

Theorem 3.3.12 *If a graph G is vertex-transitive and edge-transitive with a odd valency, then G must be arc-transitive.*

Proof Let $uv \in E(G)$. Then we get two arcs (u, v) and (v, u) . Define $\Omega_1 = (u, v)^{\text{Aut}G} = \{(u, v)^g \mid g \in \text{Aut}G\}$ and $\Omega_2 = (v, u)^{\text{Aut}G} = \{(v, u)^g \mid g \in \text{Aut}G\}$. By the transitivity of $\text{Aut}G$ on $E(G)$, we know that $\Omega_1 \cup \Omega_2 = A(G)$, where $A(G)$ denote the arc set of G . If G is not arc-transitive, there must be $\Omega_1 \cap \Omega_2 = \emptyset$. Namely, there are no $g \in \text{Aut}G$ such that $(x, y)^g = (y, x)$ for $\forall (x, y) \in A(G)$. Now let $X_v = \{x \mid (v, x) \in \Omega_1\}$ and $Y_v = \{y \mid (y, v) \in \Omega_1\}$. Then $X_v \cap Y_v = \emptyset$. Whence, $N_G(v) = X_v \cup Y_v$. This fact enables us to know the valency of G is $k = |X_v| + |Y_v|$. By the transitivity of $\text{Aut}G$ on $V(G)$, we know that $|X_v| = |X_u|$ and $|Y_v| = |Y_u|$ for $\forall u \in V(G)$. So $|E(G)| = |X_v||V(G)| = |Y_v||V(G)|$. We get that $|X_v| = |Y_v|$, i.e., k is an even number, a contradiction. \square

By Theorem 3.3.12, a half-transitive graph must has even valency. In 1970, Bower constructed half-transitive graphs of valency k for each even number $k > 2$ and the minimum half-transitive graph is a 4-regular graph with 27 vertices found by Holt in 1981. In 1992, Xu proved this minimum half-transitive graph is unique (See [XHLL1] for details).

§3.4 GRAPH SEMI-ARC GROUPS

3.4.1 Semi-Arc Set. Let G be a graph, maybe with loops and multiple edges, $e = uv \in E(G)$. We divide e into two *semi-arcs* e_u^+, e_u^- (or e_u^+, e_v^+), and call such a vertex u to be the *root vertex* of e_u^+ . Here, we adopt a convention following:

Convention 3.4.1 Let G be a graph. Then for $e = uv \in E(G)$,

$$\begin{cases} e_u^- = e_v^+ & \text{if } u \neq v, \\ e_u^- \neq e_v^+ & \text{if } u = v. \end{cases}$$

Denote by $X_{\frac{1}{2}}(G)$ the set of all such semi-arcs of a graph G . We present a few examples for $X_{\frac{1}{2}}(G)$. Let $D_{0.3.0}, B_3, K_4$ be the dipole, bouquet and the complete graph shown in Fig.3.4.1.

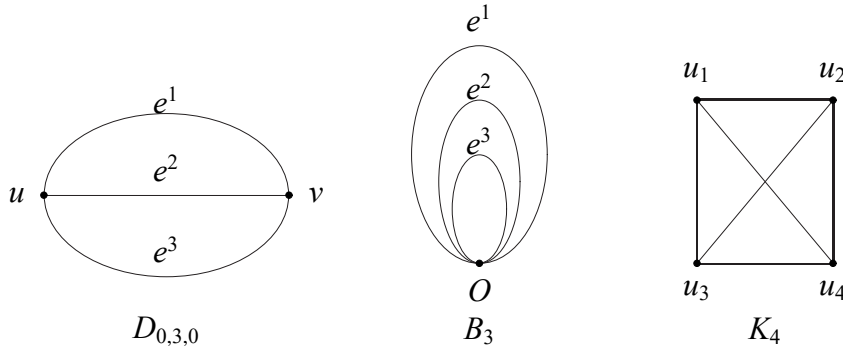

Fig.3.4.1

Then, we know their semi-arc sets as follows:

$$X_{\frac{1}{2}}(D_{0.3.0}) = \{e_u^{1+}, e_u^{2+}, e_u^{3+}, e_v^{1+}, e_v^{2+}, e_v^{3+}\},$$

$$X_{\frac{1}{2}}(B_3) = \{e_O^{1+}, e_O^{2+}, e_O^{3+}, e_O^{1-}, e_O^{2-}, e_O^{3-}\},$$

$$X_{\frac{1}{2}}(K_4) = \{u_1u_2^+, u_1u_2^-, u_1u_3^+, u_1u_3^-, u_1u_4^+, u_1u_4^-, u_2u_3^+, u_2u_3^-, u_2u_4^+, u_2u_4^-, u_3u_4^+, u_3u_4^-\}.$$

Notice that the Convention 3.4.1 and these examples show that we can represent all semi-arcs of a graph G by elements in $V(G) \cup E(G) \cup \{+, -\}$ in general, and all semi-arcs of G can be represent by elements in $V(G) \cup E(G) \cup \{+\}$ or by elements in $V(G) \cup \{+\}$ if and only if G is a graph without loops, or neither with loops or multiple edges, i.e., a simple graph G .

Two semi-arc e_u°, f_v^\bullet with $\circ, \bullet \in \{+, -\}$ are said *incident* if $u = v, e \neq f$ with $\circ = \bullet =$

$+$, or $e = f$, $u \neq v$ with $\circ = \bullet$, or $e = f$, $u = v$ with $\circ = +$, $\bullet = -$. For example, e_u^{2+} and e_v^{2+} in $D_{0.3.0}$, e_O^{2+} and e_O^{2-} in B_3 in Fig.3.4.1 both are incident.

3.4.2 Graph Semi-Arc Group. We have know the conception of automorphism of a graph in Section 3.1. Generally, an *automorphism* of a graph G on $V(G) \cup E(G)$ is an 1 – 1 mapping (ξ, η) on G such that

$$\xi : V(G) \rightarrow V(G), \quad \eta : E(G) \rightarrow E(G)$$

satisfying that for any incident elements e, f , $(\xi, \eta)(e)$ and $(\xi, \eta)(f)$ are also incident. Certainly, all such automorphisms of a graph G also form a group, denoted by $\text{Aut}G$.

We generalize this conception to that of the semi-arc set $X_{\frac{1}{2}}(G)$. The semi-arc automorphism of a graph was frst appeared in [Mao1], and then applied for the enumeration maps on surfaces underlying a graph Γ in [MaL3] and [MLW1], which is formally def ned following.

Def nition 3.4.1 *Let G be a graph. A 1 – 1 mapping ξ on $X_{\frac{1}{2}}(G)$ is called a semi-arc automorphism of the graph G if for $\forall e_u^\circ, f_v^\bullet \in X_{\frac{1}{2}}(G)$ with $\circ, \bullet \in \{+, -\}$, $\xi(e_u^\circ)$ and $\xi(f_v^\bullet)$ are incident if and only if e_u° and f_v^\bullet are incident.*

By Def nition 3.4.1, all semi-arc automorphisms of a graph form a group under the composition operation, denoted by $\text{Aut}_{\frac{1}{2}}G$, which is important for the enumeration of maps on surfaces underlying a graph and determining the conformal transformations on a Klein surface.

The Table 3.4.1 following lists semi-arc automorphism groups of a few well-known graphs.

G	$\text{Aut}_{\frac{1}{2}}G$	order
K_n	S_n	$n!$
$K_{m,n}(m \neq n)$	$S_m \times S_n$	$m!n!$
$K_{n,n}$	$S_2[S_n]$	$2n!^2$
B_n	$S_n[S_2]$	$2^n n!$
$D_{0.n.0}$	$S_2 \times S_n$	$2n!$
$D_{n.k.l}(k \neq l)$	$S_2[S_k] \times S_n \times S_2[S_l]$	$2^{k+l} n! k! l!$
$D_{n.k.k}$	$S_2 \times S_n \times (S_2[S_k])^2$	$2^{2k+1} n! k!^2$

Table 3.4.1

In this table, $D_{0,n,0}$ is a dipole graph with 2 vertices, n multiple edges and $D_{n,k,l}$ is a generalized dipole graph with 2 vertices, n multiple edges, and one vertex with k bouquets and another, l bouquets. This table also enables us to find some useful information for semi-arc automorphism groups. For example, $\text{Aut}_{\frac{1}{2}}K_n = \text{Aut}K_n = S_n$, $\text{Aut}_{\frac{1}{2}}B_n = S_n[S_2]$ but $\text{Aut}B_n = S_n$, i.e., $\text{Aut}_{\frac{1}{2}}B_n \neq \text{Aut}B_n$ for any integer $n \geq 1$.

Comparing semi-arc automorphism groups in Table 3, 4, 1 with that of Table 3.2.1, it is easily to find that the semi-arc automorphism group are the same as the automorphism group in the first two cases. Generally, we know a result related the semi-arc automorphism group with that of automorphism group of a graph, i.e., Theorem 3.4.1 following. For this objective, we introduce a few conceptions first.

For $\forall g \in \text{Aut}G$, there is an induced action $g|_{\frac{1}{2}}$ on $X_{\frac{1}{2}}(G)$, $g : X_{\frac{1}{2}}(G) \rightarrow X_{\frac{1}{2}}(G)$ determined by

$$\forall e_u \in X_{\frac{1}{2}}(G), g(e_u) = (g(e))_{g(u)}.$$

All induced action of the elements in $\text{Aut}G$ on $X_{\frac{1}{2}}(G)$ is denoted by $\text{Aut}G|_{\frac{1}{2}}$. Notice that $\text{Aut}G \cong \text{Aut}G|_{\frac{1}{2}}$. We get the following result.

Theorem 3.4.1 *Let G be a graph without loops. Then $\text{Aut}_{\frac{1}{2}}G = \text{Aut}G|_{\frac{1}{2}}$.*

Proof By the definition, we only need to prove that for $\forall \xi_{\frac{1}{2}} \in \text{Aut}_{\frac{1}{2}}G$, $\xi = \xi_{\frac{1}{2}}|_G \in \text{Aut}G$ and $\xi_{\frac{1}{2}} = \xi|_{\frac{1}{2}}$. In fact, Let $e_u^\circ, f_x^\bullet \in X_{\frac{1}{2}}(G)$ with $\circ, \bullet \in \{+, -\}$, where $e = uv \in E(G)$, $f = xy \in E(G)$. Now if

$$\xi_{\frac{1}{2}}(e_u^\circ) = f_x^\bullet,$$

by definition, we know that $\xi_{\frac{1}{2}}(e_v^\circ) = f_y^\bullet$. Whence, $\xi_{\frac{1}{2}}(e) = f$. That is, $\xi_{\frac{1}{2}}|_G \in \text{Aut}G$.

By assumption, there are no loops in G . Whence, we know that $\xi_{\frac{1}{2}}|_G = 1_{\text{Aut}G}$ if and only if $\xi_{\frac{1}{2}} = 1_{\text{Aut}_{\frac{1}{2}}G}$. So $\xi_{\frac{1}{2}}$ is induced by $\xi_{\frac{1}{2}}|_G$ on $X_{\frac{1}{2}}(G)$. Thus,

$$\text{Aut}_{\frac{1}{2}}G = \text{Aut}G|_{\frac{1}{2}}. \quad \square$$

We have know that $\text{Aut}_{\frac{1}{2}}B_n \neq \text{Aut}B_n$ for any integer $n \geq 1$. Combining this fact with Theorem 3.4.1, we know the following.

Theorem 3.4.2 *Let G be a graph. Then $\text{Aut}_{\frac{1}{2}}G = \text{Aut}G|_{\frac{1}{2}}$ if and only if G is a loopless graph.*

3.4.3 Semi-Arc Transitive Graph. A graph G is called to be *semi-arc transitive* if $\text{Aut}_{\frac{1}{2}}G$ is action transitively on $X_{\frac{1}{2}}(G)$. For example, each of K_n, B_{n-1} and $D_{0,n,0}$ for any

integer $n \geq 2$ is semi-arc transitive. We know the following result for semi-arc transitive graphs.

Theorem 3.4.3 *A graph G is semi-arc transitive if and only if it is arc-transitive.*

Proof A semi-arc transitive graph G is arc-transitive by the definition of its preserving incidence of semi-arcs.

Conversely, let G be an arc-transitive graph. Let e_u^+ and $f_v^+ \in X_{\frac{1}{2}}(G)$ with $e = (u, x)$ and $f = (v, y)$. By assumption, G is arc-transitive. Consequently, there is an automorphism $\zeta \in \text{Aut}G$ such that $\zeta(u, x) = (v, y)$. Then it is easily to know that $\zeta(e_u^+) = f_v^+$, i.e., G is semi-arc transitive. \square

§3.5 GRAPH MULTIGROUPS

3.5.1 Graph Multigroup. There is a natural way for getting multigroups on graphs. Let G be a graph, $H < G$ and $\sigma \in \text{Aut}G$. Consider the localized action $\sigma|_H$ of σ on H . In general, this action must not be an automorphism of H . For example, let G be the graph shown in Fig.3.5.1 and $H = \langle v_1, v_2, v_3 \rangle_G$.

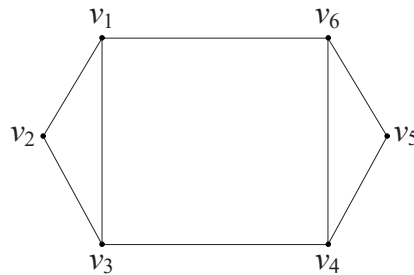

Fig.3.5.1

Let $\sigma_1 = (v_1, v_3)(v_4, v_6)(v_2)(v_5)$ and $\sigma_2 = (v_1, v_6)(v_2, v_5)(v_3, v_4)$. Then it is clear that $\sigma_1, \sigma_2 \in \text{Aut}G$ and

$$H^{\sigma_2} = \langle v_1, v_2, v_3 \rangle_G = H \quad \text{and} \quad H^{\sigma_1} = \langle v_4, v_5, v_6 \rangle_G \neq H.$$

Whence, σ_1 is an automorphism of H , but σ_2 is not. In fact, let $\forall \zeta \in (\text{Aut}G)_H$. Then $H^\zeta = H$, i.e., $\zeta|_H$ is an automorphism of H . Now define

$$\text{Aut}G_H = \langle \zeta|_H \mid \zeta \in (\text{Aut}G)_H \rangle.$$

Then $\text{Aut}G_H$ is an automorphism group of H .

An extended action $g|_G$ for an automorphism $g \in \text{Aut}H_i$ is the action of g on G by introducing new actions of g on $G \setminus V(H_i)$, $1 \leq i \leq m$. The previous discussion enables one to get the following result.

Theorem 3.5.1 *Let G be a graph and $G = \bigoplus_{i=1}^m H_i$ a decomposition of G . Then for any integer i , $1 \leq i \leq m$, there is a subgroup $\mathcal{P}_i \leq \text{Aut}H_i$ such that $\mathcal{P}_i|_G \leq \text{Aut}G$, i.e., $\widetilde{\mathcal{P}} = \bigcup_{i=1}^m \mathcal{P}_i$ is a multigroup.*

Proof Choose $\mathcal{P}_i = \text{Aut}G_{H_i}$ for any integer i , $1 \leq i \leq m$. Then the result follows. \square

For a given decomposition $G = \bigoplus_{i=1}^m H_i$ of a graph G , we can always get automorphism multigroups $\text{Aut}^{mul}G = \bigcup_{i=1}^m \mathcal{H}_i$, $\mathcal{H}_i \leq \text{Aut}H_i$ for integers $1 \leq i \leq m$, which must not be an automorphism group of G . For its dependence on the structure of $G = \bigoplus_{i=1}^m H_i$, such a multigroup $\text{Aut}^{mul}G$ is denoted by $\bigodot_{i=1}^m \mathcal{H}_i$ in this book. Generally, the automorphism multigroups of a graph G are not unique unless $G = K_1$. The maximal automorphism multigroup of a graph G is $\text{Aut}^{mul}G = \bigodot_{i=1}^m \text{Aut}H_i$ and the minimal is that of $\text{Aut}^{mul}G = \bigodot_{i=1}^m \{1_{\text{Aut}H_i}\}$. We first determine automorphism groups of G in these multigroups following.

Let G be a graph, $H < G$ and $\sigma \in \text{Aut}H$, $\tau \in \text{Aut}(G \setminus V(H))$. They are called to be *in coordinating* with each other if the mapping $g : G \rightarrow G$ determined by

$$g(v) = \begin{cases} \sigma(v), & \text{if } v \in V(H), \\ \tau(v), & \text{if } v \in G \setminus V(H) \end{cases}$$

is an automorphism of G for $\forall v \in V(G)$. If such a g exists, we say τ can be *extended* to G and denoted g by τ^G . Denoted by $\text{Aut}^G H = \{ \sigma^G \mid \sigma \in \text{Aut}H \}$. Then it is clear that $\text{Aut}G_H = \text{Aut}^G H|_H < \text{Aut}H$. We find the following result for the automorphism group of a graph.

Theorem 3.5.2 *Let G be a graph and $H < G$. Then the mapping $\phi_G : \text{Aut}G \rightarrow \text{Aut}H$ determined by $\phi_G(g) = g|_H$ is a homomorphism, i.e., $\text{Aut}G/\text{Ker}\phi_G \simeq \text{Aut}G_H$.*

Proof For any automorphism $g \in \text{Aut}G$, by Theorem 3.5.1, there is a localized action $g|_H$ such that $H^g = H$, $g = g|_H \in \text{Aut}G_H$, i.e., such a correspondence ϕ_G is a mapping. We are needed to prove the equality $\phi_G(ab) = \phi_G(a)\phi_G(b)$ holds for $\forall a, b \in \text{Aut}G$. In fact,

$$\phi_G(a)\phi_G(b) = a|_H^G b|_H^G = (ab)|_H^G = \phi_G(ab)$$

by the property of automorphism. Whence, ϕ_G is a homomorphism. Applying the homomorphism theorem of groups, we get $\text{Aut}G/\text{Ker}\phi_G \simeq \text{Ker}\phi_G$. Notice that $\text{Ker}\phi_G = \text{Aut}G_H$. We finally get that $\text{Aut}G/\text{Ker}\phi_G \simeq \text{Aut}G_H$. \square

If ϕ_G is onto or 1-1, then $\text{Ker}\phi_G = 1_{\text{Aut}G}$ or $\text{Aut}H$. We get the following consequence by Theorem 3.5.2.

Corollary 3.5.1 *Let G be a graph and $H < G$. If the homomorphism $\phi : \text{Aut}G \rightarrow \text{Aut}H$ is onto or 1-1, then $\text{Aut}G/\text{Ker}\phi \simeq \text{Aut}H$ or $\text{Aut}G \simeq \text{Aut}G_H$.*

For example, Let G be the graph shown in Fig.3.5.1 and $H = \langle v_1, v_3, v_4, v_6 \rangle_G$. Then $\sigma_1|_H = (v_1, v_3)(v_4, v_6)$ and $\sigma_2|_H = (v_1, v_6)(v_3, v_4)$, i.e., the homomorphism $\phi_G : \text{Aut}G \rightarrow \text{Aut}G_H$ is 1-1 and onto. Whence, we know that

$$\text{Aut}G \simeq \text{Aut}G_H = \langle \sigma_1|_H, \sigma_2|_H \rangle.$$

Although it is very difficult for determining the automorphism group of a graph G in general, it is easy for that of automorphism multigroups if the decomposition $G = \bigoplus_{i=1}^m H_i$ is chosen properly. The following result is easily obtained by definition.

Theorem 3.5.3 *For any connected graph G ,*

$$\text{Aut}_E G = \bigcirc_{(u,v) \in E(G)} S_{\{u,v\}}$$

is an automorphism multigroup of G , where $S_{\{u,v\}}$ is the symmetric group action on the vertices u and v .

Proof Certainly, any graph G has a decomposition $G = \bigoplus_{(u,v) \in E(G)} (u, v)$. Notice that the automorphism on each edge $(u, v) \in E(G)$ is that symmetric group $S_{\{u,v\}}$. Then the assertion is followed. \square

The automorphism multigroup $\text{Aut}_E G$ is a graphical property by Theorem 3.5.3. Furthermore, we know that $\text{Aut}_E G$ is a graph invariant on G by the following result.

Theorem 3.5.4 *Let G, H be two connected graphs. Then G is isomorphic to H if and only if $\text{Aut}_E G$ and $\text{Aut}_E H$ are permutation equivalent, i.e., there is an isomorphism $\zeta : \text{Aut}_E G \rightarrow \text{Aut}_E H$ and a 1-1 mapping $\iota : E(G) \rightarrow E(H)$ such that $\zeta(g)(\iota(e)) = \iota(g(e))$ for $\forall g \in \text{Aut}G$ and $e \in E(G)$.*

Proof If $G \simeq H$, we are easily getting an isomorphism $\sigma : V(G) \rightarrow V(H)$, which induces an isomorphism $\varsigma : \text{Aut}_E G \rightarrow \text{Aut}_E H$ and a 1 – 1 mapping $\iota : E(G) \rightarrow E(H)$ by $\sigma(u, v) = (\sigma(u), \sigma(v))$ for $\forall e = (u, v) \in E(G)$.

Now if there is an isomorphism $\varsigma : \text{Aut}_E G \rightarrow \text{Aut}_E H$ and a 1 – 1 mapping $\iota : E(G) \rightarrow E(H)$ such that $\varsigma(g)(\iota(e)) = \iota(g(e))$ for $\forall g \in \text{Aut}G$ and $e \in E(G)$, by definition

$$\text{Aut}_E G = \bigodot_{(u,v) \in E(G)} S_{\{u,v\}},$$

we know that

$$\varsigma : \bigodot_{(u,x) \in E(G) \text{ for } x \in V(G)} S_{\{u,x\}} \rightarrow \bigodot_{(v,y) \in E(H) \text{ for } y \in V(H)} S_{\{v,y\}},$$

where $\iota : (u, x) \in E(G) \rightarrow (v, y) \in E(H)$. Whence, ς and ι induce a 1 – 1 mapping

$$\sigma : \bigoplus_{(u,x) \in E(G) \text{ for } x \in V(G)} (u, x) \rightarrow \bigoplus_{(v,y) \in E(H) \text{ for } y \in V(H)} (v, y).$$

This fact implies that $\sigma : u \in V(G) \rightarrow v \in V(H)$ if we represent the vertices u, v respectively by those of $u \doteq \bigoplus_{(u,x) \in E(G) \text{ for } x \in V(G)} (u, x)$ and $v \doteq \bigoplus_{(v,y) \in E(H) \text{ for } y \in V(H)} (v, y)$ in graphs G and H , where the notation $a \doteq b$ means the definition of a by that of b . Essentially, such a mapping $\sigma : V(G) \rightarrow V(H)$ is an isomorphism between graphs G and H for easily checking that

$$\sigma(u, x) = (\sigma(u), \sigma(x))$$

for $\forall (u, x) \in E(G)$ by such representation of vertices in a graph. Thus $G \simeq H$. □

The decomposition $G = \bigoplus_{(u,v) \in E(G)} (u, v)$ is a K_2 -decomposition. A *clique decomposition* of a graph G is such a decomposition $G = \bigoplus_{i=1}^m K_{n_i}$, where K_{n_i} is a maximal complete subgraph in G for integers $1 \leq i \leq m$. We have know $\text{Aut}K_{n_i} = S_{n_i}$ from Table 3.2.1. Whence, we know the following result on automorphism multigroups of a graph.

Theorem 3.5.5 *Let $G = \bigoplus_{i=1}^m K_{n_i}$ be a clique decomposition of a graph G . Then $\text{Aut}^{mul} G = \bigodot_{i=1}^m \mathcal{H}_i$ is an automorphism multigroup of G , where $\mathcal{H}_i \leq S_{V(K_{n_i})}$.*

Proof Notice that $\text{Aut}K_{n_i} = S_{n_i}$. Whence, $\text{Aut}^{mul} G = \bigodot_{i=1}^m \mathcal{H}_i$ is an automorphism multigroup of G for each $\mathcal{H}_i \leq S_{V(K_{n_i})}$. □

Similar to that of Theorem 3.5.4, we also know that the maximal automorphism multigroup $\text{Aut}_{cl}G = \bigodot_{i=1}^m S_{V(K_{n_i})}$ is also a graph invariant following.

Theorem 3.5.6 *Let G, H be two connected graphs. Then G is isomorphic to H if and only if $\text{Aut}_{cl}G$ and $\text{Aut}_{cl}H$ are permutation equivalent.*

Proof This result is an immediately consequence of Theorem 3.5.4 by applying the fact $S_{V(K_n)} = \langle (v_1, v_2), (v_1, v_3), \dots, (v_1, v_n) \rangle$ if $V(K_n) = \{v_1, v_2, \dots, v_n\}$. \square

3.5.2 Multigroup Action Graph. Let $\widetilde{\mathcal{P}}$ be a multigroup action on a set $\widetilde{\Omega}$. For two elements $a, b \in \widetilde{\Omega}$, if there is an element $\sigma \in \widetilde{\mathcal{P}}$ such that $a^\sigma = b$, we can represent this relation by a directed edge (a, b) shown in Fig.3.5.2 following:

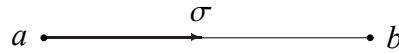

Fig.3.5.2

Applying this notion to all elements in $\widetilde{\Omega}$, we get the action graph. An *action graph* $G[\widetilde{\mathcal{P}}; \widetilde{\Omega}]$ of $\widetilde{\mathcal{P}}$ on $\widetilde{\Omega}$ is a directed graph defined by

$$V(G[\widetilde{\mathcal{P}}; \widetilde{\Omega}]) = \widetilde{\Omega},$$

$$E(G[\widetilde{\mathcal{P}}; \widetilde{\Omega}]) = \{ (a, b) \mid \forall a, b \in \widetilde{\Omega} \text{ and } \exists \sigma \in \widetilde{\mathcal{P}} \text{ such that } a^\sigma = b \}.$$

Since σ^{-1} always exists in a multigroup $\widetilde{\mathcal{P}}$, we also get that $b^{\sigma^{-1}} = a$. So edges between a and b in $G[\widetilde{\mathcal{P}}; \widetilde{\Omega}]$ must be the case shown in Fig.3.5.3.

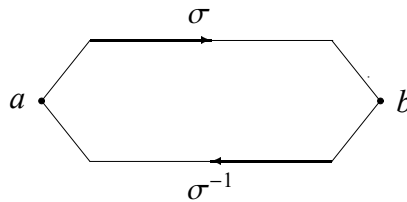

Fig.3.5.3

Such edges (a, b) and (b, a) are called *parallel edges*. For simplicity, we draw each parallel edges (a, b) and (b, a) by a non-directed edge ab in the graph $G[\widetilde{\mathcal{P}}; \widetilde{\Omega}]$, i.e.,

$$V(G[\widetilde{\mathcal{P}}; \widetilde{\Omega}]) = \widetilde{\Omega},$$

$$E(G[\widetilde{\mathcal{P}}; \widetilde{\Omega}]) = \{ ab \mid \forall a, b \in \widetilde{\Omega} \text{ and } \exists \sigma \in \widetilde{\mathcal{P}} \text{ such that } a^\sigma = b \}.$$

Example 3.5.1 Let $\mathcal{P} = \{(1), (1, 2)(3, 4), (1, 3)(2, 4), (1, 4)(2, 3)\}$ be a permutation group action on $\Omega = \{1, 2, 3, 4\}$. Then the action graph $G[\mathcal{P}; \Omega]$ is the complete graph K_4 with labels shown in Fig.3.5.4,

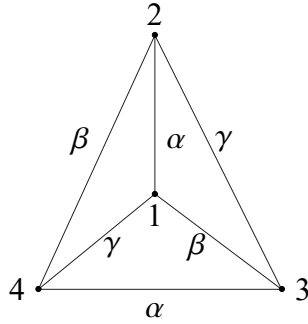

Fig.3.5.4

in where $\alpha = (1, 2)(3, 4)$, $\beta = (1, 3)(2, 4)$ and $\gamma = (1, 4)(2, 3)$.

Example 3.5.2 Let $\widetilde{\mathcal{P}}$ be a permutation multigroup action on $\widetilde{\Omega}$ with

$$\widetilde{\mathcal{P}} = \mathcal{P}_1 \cup \mathcal{P}_2 \text{ and } \widetilde{\Omega} = \{1, 2, 3, 4, 5, 6, 7, 8\} \cup \{1, 2, 5, 6, 9, 10, 11, 12\},$$

where $\mathcal{P}_1 = \langle (1, 2, 3, 4), (5, 6, 7, 8) \rangle$ and $\mathcal{P}_2 = \langle (1, 5, 9, 10), (2, 6, 11, 12) \rangle$. Then the action graph $G[\widetilde{\mathcal{P}}; \widetilde{\Omega}]$ of $\widetilde{\mathcal{P}}$ on $\widetilde{\Omega} = \{1, 2, 3, 4, 5, 6, 7, 8, 9, 10, 11, 12\}$ is shown in Fig.3.5.5, in where labels on edges are removed. It should be noted that this action graph is in fact a union graph of four complete graphs K_4 with intersection vertices.

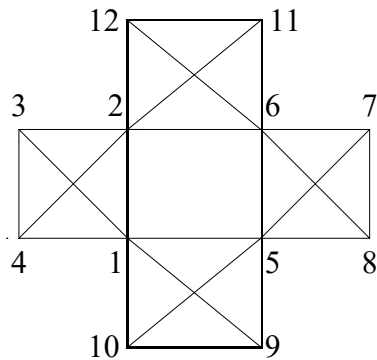

Fig.3.5.5

These Examples 3.5.1 and 3.5.2 enables us to find the following result on the action graphs of multigroups.

Theorem 3.5.7 Let $\widetilde{\mathcal{P}}$ be a multigroup action on a set $\widetilde{\Omega}$ with

$$\widetilde{\mathcal{P}} = \bigcup_{i=1}^m \mathcal{P}_i \text{ and } \widetilde{\Omega} = \bigcup_{i=1}^m \Omega_i,$$

where each permutation group \mathcal{P}_i acts on Ω_i with orbits $\Omega_{i1}, \Omega_{i2}, \dots, \Omega_{is_i}$ for each integer $i, 1 \leq i \leq m$. Then

$$G[\widetilde{\mathcal{P}}; \widetilde{\Omega}] = \bigcup_{i=1}^m \left(\bigoplus_{j=1}^{s_i} K_{|\Omega_{ij}|} \right)$$

with intersections $K_{|\Omega_{ij} \cap \Omega_{kl}|}$ only if for integers $1 \leq i \neq k \leq m, 1 \leq j \leq s_i, l \leq l \leq s_k$. Particularly, if $m = 1$, i.e., $\widetilde{\mathcal{P}}$ is just a permutation group, then its action graph $G[\widetilde{\mathcal{P}}; \widetilde{\Omega}]$ is a union of complete graphs without intersections.

Proof Notice that for each orbit Ω_{ij} of \mathcal{P}_i action on Ω_i , the subgraph of the action graph is the complete graph $K_{|\Omega_{ij}|}$ and $\Omega_{ij_1} \cap \Omega_{ij_2} = \emptyset$ if $j_1 \neq j_2$, i.e., $K_{|\Omega_{ij_1}|} \cap K_{|\Omega_{ij_2}|} = \emptyset$. This result follows by definition. \square

By Theorem 3.5.5, we are easily find the automorphism groups of the graph shown in Fig.3.5.5, particularly the maximal automorphism group following:

$$\text{Aut}_{cl}G[\widetilde{\mathcal{P}}; \widetilde{\Omega}] = S_{\{1,2,3,4\}} \odot S_{\{5,6,7,8\}} \odot S_{\{1,5,9,10\}} \odot S_{\{2,6,11,12\}}.$$

Generally, we get the following result.

Theorem 3.5.8 Let $\widetilde{\mathcal{P}}$ be a multigroup action on a set $\widetilde{\Omega}$ with $\widetilde{\mathcal{P}} = \bigcup_{i=1}^m \mathcal{P}_i$ and $\widetilde{\Omega} = \bigcup_{i=1}^m \Omega_i$, where each permutation group \mathcal{P}_i acts on Ω_i with orbits $\Omega_{i1}, \Omega_{i2}, \dots, \Omega_{is_i}$ for each integer $i, 1 \leq i \leq m$. Then the maximal automorphism group of $G[\widetilde{\mathcal{P}}; \widetilde{\Omega}]$ is

$$\text{Aut}_{cl}G[\widetilde{\mathcal{P}}; \widetilde{\Omega}] = \bigcup_{i=1}^m \left(\bigodot_{j=1}^{s_i} S_{\Omega_{ij}} \right).$$

Particularly, if $|\Omega_{ij} \cap \Omega_{kl}| = 1$ for $i \neq k, 1 \leq i, k \leq m, 1 \leq j \leq s_i, l \leq l \leq s_k$, then

$$\text{Aut}_{cl}G[\widetilde{\mathcal{P}}; \widetilde{\Omega}] = \bigodot_{i=1}^m \bigodot_{j=1}^{s_i} S_{\Omega_{ij}}.$$

Proof Notice that if $|\Omega_{ij} \cap \Omega_{kl}| = 1$ for $i \neq k, 1 \leq i, k \leq m, 1 \leq j \leq s_i, l \leq l \leq s_k$, then

$$G[\widetilde{\mathcal{P}}; \widetilde{\Omega}] = \bigoplus_{i=1}^m \bigoplus_{j=1}^{s_i} K_{|\Omega_{ij}|}.$$

This result follows from Theorems 3.5.5 and 3.5.7. \square

3.5.3 Globally Transitivity. Let $\widetilde{\mathcal{P}}$ be a permutation multigroup action on $\widetilde{\Omega}$. This permutation multigroup $\widetilde{\mathcal{P}}$ is said to be *globally k -transitive* for an integer $k \geq 1$ if for any two k -tuples $x_1, x_2, \dots, x_k \in \Omega_i$ and $y_1, y_2, \dots, y_k \in \Omega_j$, where $1 \leq i, j \leq m$, there are permutations $\pi_1, \pi_2, \dots, \pi_n \in \widetilde{\mathcal{P}}$ such that $x_1^{\pi_1 \pi_2 \dots \pi_n} = y_1, x_2^{\pi_1 \pi_2 \dots \pi_n} = y_2, \dots, x_k^{\pi_1 \pi_2 \dots \pi_n} = y_k$. We have obtained Theorems 2.6.8-2.6.10 for characterizing the globally transitivity of multigroups. In this subsection, we characterize it by the action graphs of multigroups. First, we know the following result on globally 1-transitivity, i.e., the globally transitivity of a multigroup.

Theorem 3.5.9 *Let $\widetilde{\mathcal{P}}$ be a multigroup action on a set $\widetilde{\Omega}$ with*

$$\widetilde{\mathcal{P}} = \bigcup_{i=1}^m \mathcal{P}_i \text{ and } \widetilde{\Omega} = \bigcup_{i=1}^m \Omega_i,$$

where each permutation group \mathcal{P}_i acts on Ω_i for integers $1 \leq i \leq m$. Then $\widetilde{\mathcal{P}}$ is globally transitive action on $\widetilde{\Omega}$ if and only if $G[\widetilde{\mathcal{P}}; \widetilde{\Omega}]$ is connected.

Proof Let $x, y \in \widetilde{\Omega}$. If $\widetilde{\mathcal{P}}$ is globally transitive action on $\widetilde{\Omega}$, then there are elements $\pi_1, \pi_2, \dots, \pi_n \in \widetilde{\mathcal{P}}$ such that $x^{\pi_1 \pi_2 \dots \pi_n} = y$ for an integer $n \geq 1$. Define $v_1 = x^{\pi_1}, v_2 = x^{\pi_1 \pi_2}, \dots, v_{n-1} = x^{\pi_1 \pi_2 \dots \pi_{n-1}}$. Notice that $v_1, v_2, \dots, v_{n-1} \in \widetilde{\Omega}$. By definition, we consequently find a walk (path) $xv_1v_2 \dots v_{n-1}y$ in the action graph $G[\widetilde{\mathcal{P}}; \widetilde{\Omega}]$ for any two vertices $x, y \in V(G[\widetilde{\mathcal{P}}; \widetilde{\Omega}])$, which implies that $G[\widetilde{\mathcal{P}}; \widetilde{\Omega}]$ is connected.

Conversely, if $G[\widetilde{\mathcal{P}}; \widetilde{\Omega}]$ is connected, for $\forall x, y \in V(G[\widetilde{\mathcal{P}}; \widetilde{\Omega}]) = \widetilde{\Omega}$, let $xu_1 \dots u_{n-1}y$ be a shortest path connected the vertices x and y in $G[\widetilde{\mathcal{P}}; \widetilde{\Omega}]$ for an integer $n \geq 1$. By definition, there are must be $\pi_1, \pi_2, \dots, \pi_n \in \widetilde{\mathcal{P}}$ such that $x^{\pi_1} = u_1, u_1^{\pi_2} = u_2, \dots, u_{n-1}^{\pi_n} = y$. Whence,

$$x^{\pi_1 \pi_2 \dots \pi_n} = y.$$

Thus $\widetilde{\mathcal{P}}$ is globally transitive action on $\widetilde{\Omega}$. □

For a multigroup action $\widetilde{\mathcal{P}}$ action on $\widetilde{\Omega}$ with

$$\widetilde{\mathcal{P}} = \bigcup_{i=1}^m \mathcal{P}_i \text{ and } \widetilde{\Omega} = \bigcup_{i=1}^m \Omega_i,$$

where each permutation group \mathcal{P}_i acts on Ω_i for integers $1 \leq i \leq m$, define

$$\Omega_i^k = \{ (x_1, x_2, \dots, x_k) \mid x_l \in \Omega_i \} \text{ and } \widetilde{\Omega}^k = \bigcup_{i=1}^m \Omega_i^k$$

for integers $k \geq 1$ and $1 \leq i \leq m$. Then we are easily proved that a permutation group \mathcal{P} action on Ω is k -transitive if and only if \mathcal{P} action on Ω^k is transitive for an integer $k \geq 1$. Combining this fact with that of Theorem 3.5.9, we get the following result on the globally k -transitivity of multigroups.

Theorem 3.5.10 Let $\widetilde{\mathcal{P}}$ be a multigroup action on a set $\widetilde{\Omega}$ with

$$\widetilde{\mathcal{P}} = \bigcup_{i=1}^m \mathcal{P}_i \quad \text{and} \quad \widetilde{\Omega} = \bigcup_{i=1}^m \Omega_i,$$

where each permutation group \mathcal{P}_i acts on Ω_i for integers $1 \leq i \leq m$. Then $\widetilde{\mathcal{P}}$ is globally k -transitive action on $\widetilde{\Omega}$ for an integer $k \geq 1$ if and only if $G[\widetilde{\mathcal{P}}; \widetilde{\Omega}^k]$ is connected.

Proof Replacing $\widetilde{\Omega}$ by $\widetilde{\Omega}^k$ in the proof of Theorem 3.5.9 and applying the fact that a permutation group \mathcal{P} action on Ω is k -transitive if and only if \mathcal{P} action on Ω^k is transitive for an integer $k \geq 1$, we get our conclusion. \square

Applying the action graph $G[\widetilde{\mathcal{P}}; \widetilde{\Omega}]$ and $G[\widetilde{\mathcal{P}}; \widetilde{\Omega}^k]$, we can also characterize the globally primitivity or other properties of permutation multigroups by graph structure. All of those are laid the reader as exercises.

§3.6 REMARKS

3.6.1 For catering to the need of computer science, graphs were out of games and turned into *graph theory* in last century. Today, it has become a fundamental tool for dealing with relations of events applied to more and more fields, such as those of algebra, topology, geometry, probability, computer science, chemistry, electrical network, theoretical physics, \dots and real-life problems. There are many excellent monographs for its theoretical results with applications, such as these references [ChL1], [Whi1] and [Yap1] for graphs with structures, [GrT1], [MoT1] and [Liu1] for graphs on surfaces.

3.6.2 The conception of *Smarandachely graph property* in Subsection 3.1.4 is presented by *Smarandache systems* or *Smarandache's notion*, i.e., such a mathematical system in which there is a rule that behaves in at least two different ways, i.e., validated and invalidated, or only invalidated but in multiple distinct ways (See [Mao2]-[Mao4], [Mao25] and [Sma1]-[Sma2] for details). In fact, there are two ways to look a graph with more

than one edges as a Smarandachely graph. One is by its graphical structure. Another is by graph invariants on it. All of those Smarandachely conceptions are new and open problems in this subsection are valuable for further research.

3.6.3 For surveying symmetries on graphs, automorphisms are needed, which is permutations on graphs. This is the closely related place of groups with that of graphs. In fact, finite graphs are a well objectives for applying groups, particularly for classifying symmetric graphs in recent two decades. To determining the automorphism groups $\text{Aut}G$ of a graph G is an important but more difficult problem, which enables one to enumerating maps on surfaces underlying G , or finite regular maps on surfaces (See following chapters in this book). Sections 3.2-3.3 present two ways already known. One is the GRR of finite group. Another is the normally Cayley graphs for finite groups. More results and examples can be found in references [Big2], [GoR1], [Xum2], [XHL1] and [Yap1] for further reading.

3.6.4 A *hypergraph* Λ is a triple (V, f, E) with disjoint V , E and $f : E \rightarrow \mathcal{P}(V)$, where each element in V is called the *vertex* and that in E is called the *edge* of Λ . If $f : E \rightarrow V \times V$, then a hypergraph Λ is nothing but just a graph G . Two elements $x \in V$, $e \in E$ of a hypergraph (V, f, E) are called to be *incident* if $x \in f(e)$. Two hypergraphs $\Lambda_1 = (V_1, f_1, E_1)$ and $\Lambda_2 = (V_2, f_2, E_2)$ are *isomorphic* if there exists bijections $p : E_1 \rightarrow E_2$, $q : V_1 \rightarrow V_2$ such that $q[f_1(e)] = f_2(p(e))$ holds for $\forall e \in E$. Particularly, if $\Lambda_1 = \Lambda_2$, i.e., isomorphism between a hypergraph Λ , such an isomorphism is called an *automorphism* of Λ . All automorphisms of a hypergraph Λ form a group, denoted by $\text{Aut}\Lambda$. For hypergraphs, we can also introduce conceptions such as those of vertex-transitive, edge-transitive, arc-transitive, semi-arc transitive and primitive by the action of $\text{Aut}\Lambda$ on Λ and get results for symmetric hypergraphs. As we known, there are nearly none such results found in publication.

3.6.5 The semi-arc automorphism of a graph is firstly introduced in [Mao1] and [Mao2] for enumerating maps on surfaces underlying a graph. Besides of these two references, further applications of this conception can be found in [Mao5], [MaL3], [MLW1] and [Liu4]. It should be noted that the semi-arc automorphism is called *semi-automorphism* of a graph in [Liu4]. In fact, the semi-arc automorphism group of a graph G is the induced action of $\text{Aut}G$ on semi-arcs of G if G is loopless. Thus is the essence of Theorems 3.4.1 and 3.4.2. But if G has loops, the situation is very different. So the semi-arc automorphism

group of a graph is valuable at least for enumerating maps on surface underlying a graph G with loops because we need the semi-arc automorphism group, not just the automorphism group of G in this case.

3.6.6 Considering the local symmetry of a graph, graphs can be seen as the sources of permutation multigroups. In fact, automorphism of a graph surveys its globally symmetry. But this can be only applied for that of fields understood by mankind. For the limitation of recognition, we can only know partially behaviors of World. So a globally symmetry in one's eyes is localized symmetry in the real-life World. That is the motivation of multigroups. Although to determine the automorphism of a graph is very difficult, it is easily to determine the automorphism multigroups in many cases. Theorems 3.5.3 and 3.5.5 are such typical examples. It should be noted that Theorems 3.5.4 and 3.5.6 show that the automorphism multigroups $\text{Aut}_E G$ and $\text{Aut}_{cl} G$ are new invariants on graphs. So we can survey localized symmetry of graphs or classify graphs by the action of $\text{Aut}_E G$ and $\text{Aut}_{cl} G$.

CHAPTER 4.

Surface Groups

The *surface group* is generated by loops on a surface with or without boundary. There are two disguises for a surface group in mathematics. One is the fundamental group in topology and another is the non-Euclidean crystallographic group, shortly NEC group in geometry. Both of them can be viewed as an action group on a planar region, enables one to know the structures of surfaces. Consequently, topics covered in this chapter consist of two parts also. Sections 4.1.-4.3 are an introduction to topological surfaces, including topological spaces, classification theorem of compact surfaces by that of polygonal presentations under elementary transformations, fundamental groups, Euler characteristic, \dots , etc.. These sections 4.4 and 4.5 consist a general introduction to the theory of Klein surfaces, including the antianalytic functions, planar Klein surfaces, NEC groups and automorphism groups of Klein surfaces, \dots , etc.. All of these are the preliminary for finding automorphism groups of maps on surfaces or Klein surfaces in the following chapters.

§4.1 SURFACES

4.1.1 Topological Space. Let \mathcal{T} be a set. A *topology* on a set \mathcal{T} is a collection \mathcal{C} of subsets of \mathcal{T} , called *open sets* satisfying properties following:

- (T1) $\emptyset \in \mathcal{C}$ and $\mathcal{T} \in \mathcal{C}$;
- (T2) if $U_1, U_2 \in \mathcal{C}$, then $U_1 \cap U_2 \in \mathcal{C}$;
- (T3) the union of any collection of open sets is open.

For example, let $\mathcal{T} = \{a, b, c\}$ and $\mathcal{C} = \{\emptyset, \{b\}, \{a, b\}, \{b, c\}, \mathcal{T}\}$. Then \mathcal{C} is a topology on \mathcal{T} . Usually, such a topology on a discrete set is called a *discrete topology*, otherwise, a *continuous topology*. A pair $(\mathcal{T}, \mathcal{C})$ consisting of a set \mathcal{T} and a topology \mathcal{C} on \mathcal{T} is called a *topological space* and each element in \mathcal{T} is called a *point* of \mathcal{T} . Usually, we also use \mathcal{T} to indicate a topological space if its topology is clear in the context. For example, the Euclidean space \mathbf{R}^n for an integer $n \geq 1$ is a topological space.

For a point u in a topological space \mathcal{T} , its an *open neighborhood* is an open set U such that $u \in U$ in \mathcal{T} and a *neighborhood* in \mathcal{T} is a set containing some of its open neighborhoods. Similarly, for a subset A of \mathcal{T} , a set U is an *open neighborhood* or *neighborhood* of A if U is open itself or a set containing some open neighborhoods of that set in \mathcal{T} . A *basis* in \mathcal{T} is a collection \mathcal{B} of subsets of \mathcal{T} such that $\mathcal{T} = \cup_{B \in \mathcal{B}} B$ and $B_1, B_2 \in \mathcal{B}, x \in B_1 \cap B_2$ implies that $\exists B_3 \in \mathcal{B}$ with $x \in B_3 \subset B_1 \cap B_2$ hold.

Let \mathcal{T} be a topological space and $I = [0, 1] \subset \mathbf{R}$. An *arc* a in \mathcal{T} is defined to be a continuous mapping $a : I \rightarrow \mathcal{T}$. We call $a(0), a(1)$ the initial point and end point of a , respectively. A topological space \mathcal{T} is *connected* if there are no open subspaces A and B such that $S = A \cup B$ with $A, B \neq \emptyset$ and called *arcwise-connected* if every two points u, v in \mathcal{T} can be joined by an arc a in \mathcal{T} , i.e., $a(0) = u$ and $a(1) = v$. An arc $a : I \rightarrow \mathcal{T}$ is a *loop* based at p if $a(0) = a(1) = p \in \mathcal{T}$. A —it degenerated loop $e_x : I \rightarrow x \in S$, i.e., mapping each element in I to a point x , usually called a *point loop*.

A topological space \mathcal{T} is called *Hausdorff* if each two distinct points have disjoint neighborhoods and *first countable* if for each $p \in \mathcal{T}$ there is a sequence $\{U_n\}$ of neighborhoods of p such that for any neighborhood U of p , there is an n such that $U_n \subset U$. The topology is called *second countable* if it has a countable basis.

Let $\{x_n\}$ be a point sequence in a topological space \mathcal{T} . If there is a point $x \in \mathcal{T}$ such that for every neighborhood U of u , there is an integer N such that $n \geq N$ implies $x_n \in U$, then $\{u_n\}$ is said *converges* to u or u is a *limit point* of $\{u_n\}$ in the topological space \mathcal{T} .

4.1.2 Continuous Mapping. For two topological spaces \mathcal{T}_1 and \mathcal{T}_2 and a point $u \in \mathcal{T}_1$, a mapping $\varphi : \mathcal{T}_1 \rightarrow \mathcal{T}_2$ is called *continuous at u* if for every neighborhood V of $\varphi(u)$, there is a neighborhood U of u such that $\varphi(U) \subset V$. Furthermore, if φ is continuous at each point u in \mathcal{T}_1 , then φ is called a *continuous mapping* on \mathcal{T}_1 .

For examples, the polynomial function $f : \mathbf{R} \rightarrow \mathbf{R}$ determined by $f(x) = a_n x^n + a_{n-1} x^{n-1} + \cdots + a_1 x + a_0$ and the linear mapping $L : \mathbf{R}^n \rightarrow \mathbf{R}^n$ for an integer $n \geq 1$ are continuous mapping. The following result presents properties of continuous mapping.

Theorem 4.1.1 *Let \mathcal{R} , \mathcal{S} and \mathcal{T} be topological spaces. Then*

- (1) *A constant mapping $c : \mathcal{R} \rightarrow \mathcal{S}$ is continuous;*
- (2) *The identity mapping $Id : \mathcal{R} \rightarrow \mathcal{R}$ is continuous;*
- (3) *If $f : \mathcal{R} \rightarrow \mathcal{S}$ is continuous, then so is the restriction $f|_U$ of f to an open subset U of \mathcal{R} ;*
- (4) *If $f : \mathcal{R} \rightarrow \mathcal{S}$ and $g : \mathcal{S} \rightarrow \mathcal{T}$ are continuous at $x \in \mathcal{R}$ and $f(x) \in \mathcal{S}$, then so is their composition mapping $gf : \mathcal{R} \rightarrow \mathcal{T}$ at x .*

Proof The results of (1)-(3) is clear by definition. For (4), notice that f and g are respective continuous at $x \in \mathcal{R}$ and $f(x) \in \mathcal{S}$. For any open neighborhood W of point $g(f(x)) \in \mathcal{T}$, $g^{-1}(W)$ is opened neighborhood of $f(x)$ in \mathcal{S} . Whence, $f^{-1}(g^{-1}(W))$ is an opened neighborhood of x in \mathcal{R} by definition. Therefore, $g(f)$ is continuous at x . \square

A refinement of Theorem 4.1.1(3) enables us to know the following criterion for continuity of a mapping.

Theorem 4.1.2 *Let \mathcal{R} and \mathcal{S} be topological spaces. Then a mapping $f : \mathcal{R} \rightarrow \mathcal{S}$ is continuous if and only if each point of \mathcal{R} has a neighborhood on which f is continuous.*

Proof By Theorem 4.1.1(3), we only need to prove the sufficiency of condition. Let $f : \mathcal{R} \rightarrow \mathcal{S}$ be continuous in a neighborhood of each point of \mathcal{R} and $U \subset \mathcal{S}$. We show that $f^{-1}(U)$ is open. In fact, any point $x \in f^{-1}(U)$ has a neighborhood $V(x)$ on which f is continuous by assumption. The continuity of $f|_{V(x)}$ implies that $(f|_{V(x)})^{-1}(U)$ is open in $V(x)$. Whence it is also open in \mathcal{R} . By definition, we are easily find that

$$(f|_{V(x)})^{-1}(U) = \{x \in \mathcal{R} | f(x) \in U\} = f^{-1}(U) \cap V(x),$$

in $f^{-1}(U)$ and contains x . Notice that $f^{-1}(U)$ is a union of all such open sets as x ranges over $f^{-1}(U)$. Thus $f^{-1}(U)$ is open followed by this fact. \square

For constructing continuous mapping on a union of topological spaces \mathcal{X} , the following result is a very useful tool, called the *Gluing Lemma*.

Theorem 4.1.3 *Assume that a topological space \mathcal{X} is a finite union of closed subsets: $\mathcal{X} = \bigcup_{i=1}^n X_i$. If for some topological space \mathcal{Y} , there are continuous maps $f_i : X_i \rightarrow \mathcal{Y}$ that agree on overlaps, i.e., $f_i|_{X_i \cap X_j} = f_j|_{X_i \cap X_j}$ for all i, j , then there exists a unique continuous $f : \mathcal{X} \rightarrow \mathcal{Y}$ with $f|_{X_i} = f_i$ for all i .*

Proof Obviously, the mapping f defined by

$$f(x) = f_i(x), \quad x \in X_i$$

is the unique well defined mapping from \mathcal{X} to \mathcal{Y} with restrictions $f|_{X_i} = f_i$ hold for all i . So we only need to establish the continuity of f on \mathcal{X} . In fact, if U is an open set in \mathcal{Y} , then

$$\begin{aligned} f^{-1}(U) &= \mathcal{X} \cap f^{-1}(U) = \left(\bigcup_{i=1}^n X_i \right) \cap f^{-1}(U) \\ &= \bigcup_{i=1}^n (X_i \cap f^{-1}(U)) = \bigcup_{i=1}^n (X_i \cap f_i^{-1}(U)) = \bigcup_{i=1}^n f_i^{-1}(U). \end{aligned}$$

By assumption, each f_i is continuous. We know that $f_i^{-1}(U)$ is open in X_i . Whence, $f^{-1}(U)$ is open in \mathcal{X} . Thus f is continuous on \mathcal{X} . \square

Let \mathcal{X} be a topological space. A collection $C \subset \mathcal{P}(\mathcal{X})$ is called to be a *cover* of \mathcal{X} if

$$\bigcup_{C \in C} C = \mathcal{X}.$$

If each set in C is open, then C is called an *opened cover* and if $|C|$ is finite, it is called a *finite cover* of \mathcal{X} . A topological space is *compact* if there exists a finite cover in its any opened cover and *locally compact* if it is Hausdorff with a compact neighborhood for its each point. As a consequence of Theorem 4.1.3, we can apply the gluing lemma to ascertain continuous mappings shown in the next.

Corollary 4.1.1 *Let \mathcal{X} and \mathcal{Y} be topological spaces and $\{A_1, A_2, \dots, A_n\}$ be a finite opened cover of a topological space \mathcal{X} . If a mapping $f : \mathcal{X} \rightarrow \mathcal{Y}$ is continuous constrained on each A_i , $1 \leq i \leq n$, then f is a continuous mapping.*

4.1.3 Homeomorphic Space. Let \mathcal{S} and \mathcal{T} be two topological spaces. They are *homeomorphic* if there is a 1 – 1 continuous mapping $\varphi : \mathcal{S} \rightarrow \mathcal{T}$ such that the inverse

mapping $\varphi^{-1} : \mathcal{T} \rightarrow \mathcal{S}$ is also continuous. Such a mapping φ is called a *homeomorphic* or *topological* mapping. A few examples of homeomorphic spaces can be found in the following.

Example 4.1.1 Each of the following topological space pairs are homeomorphic.

(1) A Euclidean space \mathbf{R}^n and an opened unit n -ball $B^n = \{ (x_1, x_2, \dots, x_n) \mid x_1^2 + x_2^2 + \dots + x_n^2 < 1 \}$;

(2) A Euclidean plane \mathbf{R}^{n+1} and a unit sphere $S^n = \{ (x_1, x_2, \dots, x_{n+1}) \mid x_1^2 + x_2^2 + \dots + x_{n+1}^2 = 1 \}$ with one point $p = (0, 0, \dots, 0, 1)$ on it removed.

In fact, define a mapping f from B^n to \mathbf{R}^n for (1) by

$$f(x_1, x_2, \dots, x_n) = \frac{(x_1, x_2, \dots, x_n)}{1 - \sqrt{x_1^2 + x_2^2 + \dots + x_n^2}}$$

for $\forall (x_1, x_2, \dots, x_n) \in B^n$. Then its inverse is

$$f^{-1}(x_1, x_2, \dots, x_n) = \frac{(x_1, x_2, \dots, x_n)}{1 + \sqrt{x_1^2 + x_2^2 + \dots + x_n^2}}$$

for $\forall (x_1, x_2, \dots, x_n) \in \mathbf{R}^n$. Clearly, both f and f^{-1} are continuous. So B^n is homeomorphic to \mathbf{R}^n . For (2), define a mapping f from $S^n - p$ to \mathbf{R}^{n+1} by

$$f(x_1, x_2, \dots, x_{n+1}) = \frac{1}{1 - x_{n+1}}(x_1, x_2, \dots, x_n).$$

Its inverse $f^{-1} : \mathbf{R}^{n+1} \rightarrow S^n - p$ is determined by

$$f^{-1}(x_1, x_2, \dots, x_{n+1}) = (t(x)x_1, \dots, t(x)x_n, 1 - t(x)),$$

where

$$t(x) = \frac{2}{1 + x_1^2 + x_2^2 + \dots + x_{n+1}^2}.$$

Notice that both f and f^{-1} are continuous. Thus $S^n - p$ is homeomorphic to \mathbf{R}^{n+1} .

4.1.4 Surface. For an integer $n \geq 1$, an n -dimensional topological manifold is a second countable Hausdorff space such that each point has an open neighborhood homeomorphic to an open n -dimensional ball $B^n = \{(x_1, x_2, \dots, x_n) \mid x_1^2 + x_2^2 + \dots + x_n^2 < 1\}$ in \mathbf{R}^n . We assume all manifolds is connected considered in this book. A 2-manifold is usually called *surface* in literature. Several examples of surfaces are shown in the following.

Example 4.1.1 These 2-manifolds shown in the Fig.4.1.1 are surfaces with boundary.

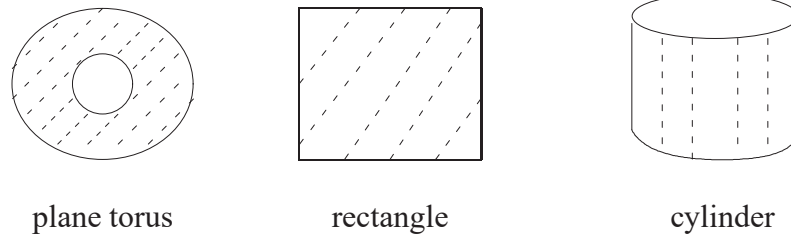

Fig.4.1.1

Example 4.1.2 These 2-manifolds shown in the Fig.4.1.2 are surfaces without boundary.

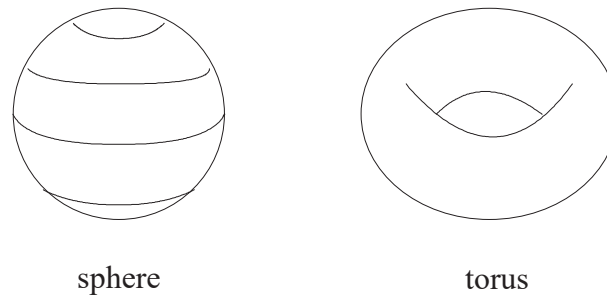

Fig.4.1.2

By definition, we can always distinguish the right-side and left-side when one object moves along an arc on a surface S . Now let \mathbf{N} be a unit normal vector of the surface S . Consider the result of a normal vector moves along a loop L on surfaces in Fig.4.1.1 and Fig.4.1.2. We find the direction of \mathbf{N} is unchanged as it come back at the original point u . For example, it moves on the sphere and torus shown in the Fig.4.1.3 following.

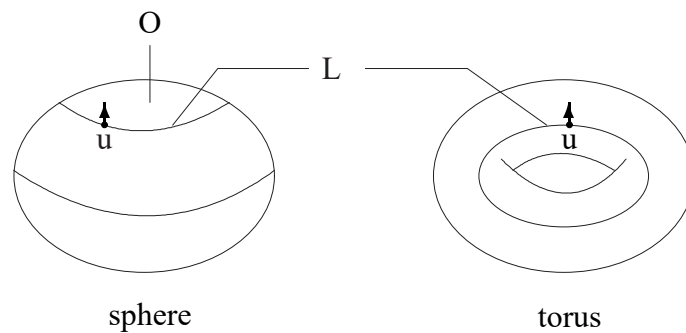

Fig.4.1.3

Such loops L in Fig.4.1.3 are called *orientation-preserving*. However, there are also loops L in surfaces which are not orientation-preserving. In such case, we get the opposite direction of \mathbf{N} as it come back at the original point v . Such a loop is called *orientation-reversing*. For example, the process (1)-(3) for getting the famous Möbius strip shown in Fig.4.1.4, in where the loop L is an orientation-reversing loop.

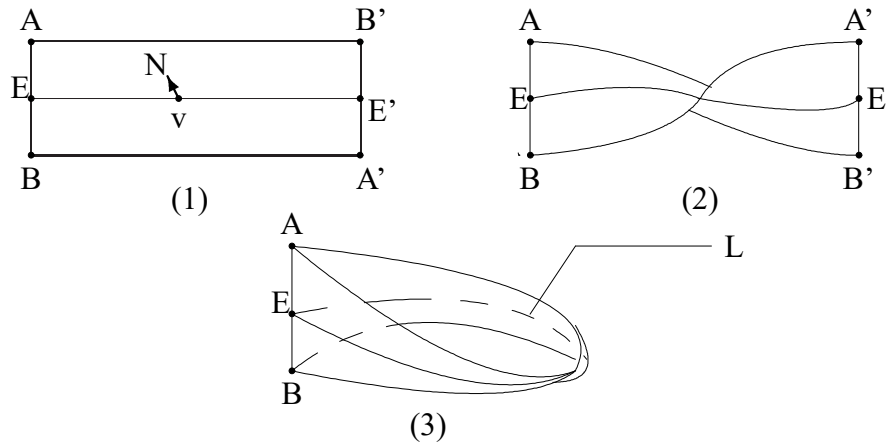

Fig.4.1.4

A surface S is defined to be *orientable* if every loop on S is orientation-preserving. Otherwise, *non-orientable* if there at least one orientation-reversing loop on S . Whence, the surfaces in Examples 4.1.1-4.1.2 are orientable and the Möbius strip are non-orientable. It should be noted that the boundary of a Möbius strip is a closed arc formed by AB' and $A'B$. Gluing the boundary of a Möbius strip by a 2-dimensional ball B^2 , we get a non-orientable surface without boundary, which is usually called *crosscap* in literature.

4.1.5 Quotient Space. A natural way for constructing surfaces is by the quotient space from a surface. For introducing such spaces, let \mathcal{X}, \mathcal{Y} be a topological spaces and $\pi : \mathcal{X} \rightarrow \mathcal{Y}$ be a surjective and continuous mapping. A subset $U \subset \mathcal{Y}$ is defined to be open if and only if $\pi^{-1}(U)$ is open in \mathcal{X} . Such a topology on \mathcal{Y} is called the *quotient topology* induced by π , and π is called a quotient mapping. It can be shown easily that the quotient topology is indeed a topology on \mathcal{Y} .

Let \sim be an equivalent relation on \mathcal{X} . Denoted by $[q]$ the equivalence class for each $q \in \mathcal{X}$ and let \mathcal{X}/\sim be the set of equivalence classes. Now let $\pi : \mathcal{X} \rightarrow \mathcal{X}/\sim$ be the natural mapping sending each element q to the equivalence class $[q]$. Then \mathcal{X}/\sim together with the quotient topology determined by π is called the *quotient space* and π

the *projection*. For example, the Möbius strip constructed in Fig.4.1.4 is in fact a quotient space \mathcal{X} / \sim , where \mathcal{X} is the rectangle $AEBA'E'B'$, and

$$\pi(x) = \begin{cases} x' & \text{if } |xA'| = |x'A'|, x \in AB, y \in A'B', \\ x & \text{if } x \in \mathcal{X} \setminus (AB \cup A'B'). \end{cases}$$

Applying quotient spaces, we can also construct surfaces without boundary. For example, a *projective plane* is defined to be the quotient space of the 2-sphere by identifying every pair of diametrically opposite points, i.e., $\mathcal{X} = \{(x_1, x_2, x_3) | x_1^2 + x_2^2 + x_3^2 = 1\}$ with $\pi(-x_1, -x_2, -x_3) = (x_1, x_2, x_3)$.

Now let \mathcal{X} be a rectangle $ABA'B'$ shown in Fig.4.1.5. Then different identification of points on AB with $A'B'$ and AA' with BB' yields different surfaces without boundary shown in Fig.4.1.5,

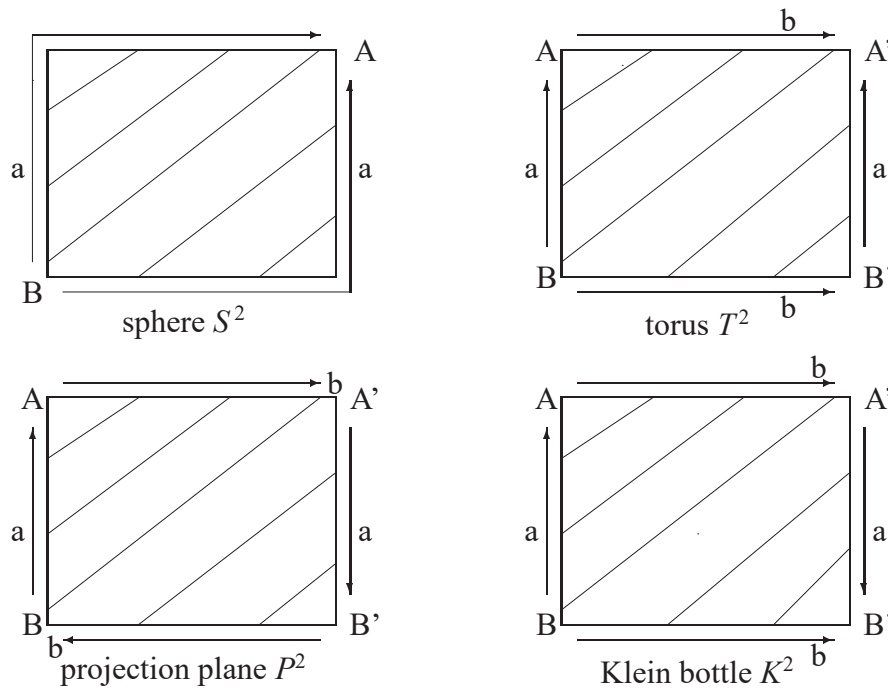

Fig.4.1.5

where the projection π is determined by

$$\pi(x) = \begin{cases} x' & \text{if } |xA'| = |x'A'|, x \in AB'B, y \in A'AB, \\ x & \text{if } x \in \mathcal{X} \setminus (AB \cup A'B' \cup AA' \cup BB') \end{cases}$$

in the sphere,

$$\pi(x) = \begin{cases} x' & \text{if } |xA'| = |x'B'|, x \in AA', x' \in BB', \\ x'' & \text{if } |xA| = |x'A'|, x \in AB, x' \in A'B', \\ x & \text{if } x \in \mathcal{X} \setminus (AB \cup A'B' \cup AA' \cup BB') \end{cases}$$

in the torus,

$$\pi(x) = \begin{cases} x' & \text{if } |xB| = |x'A'|, x \in BAA', x' \in A'B'B, \\ x & \text{if } x \in \mathcal{X} \setminus (AB \cup A'B' \cup AA' \cup BB') \end{cases}$$

in the projection plane and

$$\pi(x) = \begin{cases} x' & \text{if } |xA'| = |x'B'|, x \in AA', x' \in BB', \\ x'' & \text{if } |xA| = |x''B'|, x \in AB, x' \in A'B', \\ x & \text{if } x \in \mathcal{X} \setminus (AB \cup A'B' \cup AA' \cup BB') \end{cases}$$

in the Klein bottle, respectively.

§4.2 CLASSIFICATION THEOREM

4.2.1 Connected Sum. Let S_1, S_2 be disjoint surfaces. A *connected sum* of S_1 and S_2 , denoted by $S_1 \# S_2$ is formed by cutting a circular hole on each surface and then gluing the two surfaces along the boundary of holes.

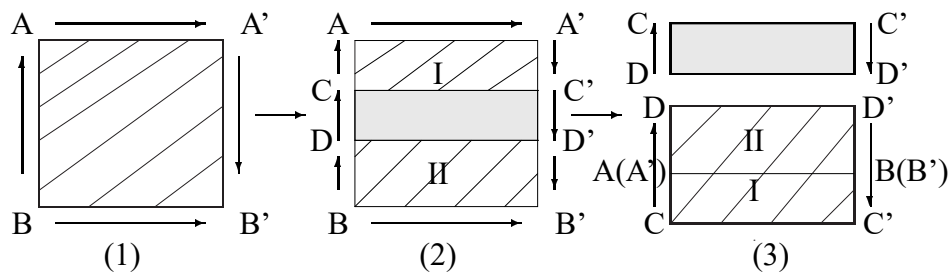

Fig.4.2.1

For example, we show that a Klein bottle constructed in Fig.4.1.5 is in fact the connected sum of two Möbius strips in Fig.4.2.1, in where, (1) is the Klein bottle in Fig.4.1.5. It should be noted that the rectangles $CDC'D'$ and $DACC'B'D'$ are two Möbius strips after we cut $ABA'B'$ along CC', DD' and then glue along $AB, A'B'$ in (3).

For a precise definition of connected sum, let $D_1 \subset S_1$ and $D_2 \subset S_2$ be closed 2-dimensional discs, i.e., homeomorphic to $\overline{B}^2 = \{(x_1, x_2) | x_1^2 + x_2^2 \leq 1\}$ with boundary ∂D_1 , ∂D_2 homeomorphic to $S^1 = \{(x_1, x_2) | x_1^2 + x_2^2 = 1\}$. Notice that each ∂D_i homeomorphic to S^1 for $i = 1, 2$. Let $h_1 : \partial D_1 \rightarrow S^1$ and $h_2 : \partial D_2 \rightarrow S^1$ be such homeomorphisms. Then $h_2^{-1}h_1 : \partial D_1 \rightarrow \partial D_2$, i.e., there always exists a homeomorphism $\partial D_1 \rightarrow \partial D_2$. Chosen a homeomorphism $h : \partial D_1 \rightarrow \partial D_2$, then $S_1 \# S_2$ is defined to be the quotient space $(S_1 \cup S_2)/h$. By definition, $S_1 \# S_2$ is clearly a surface and does not depend on the choice of D_1, D_2 and h .

Example 4.2.1 The following connected sums of orientable or non-orientable surfaces are orientable or non-orientable surfaces.

(1) A connected sum $\underbrace{T^2 \# T^2 \# \cdots \# T^2}_n$ of n toruses is orientable. Particularly, $T^2 \# T^2$ is called the double torus.

(2) A connected sum $\underbrace{P^2 \# P^2 \# \cdots \# P^2}_k$ of k projection planes is non-orientable. Particularly, $K^2 = P^2 \# P^2$ as we shown in Fig.4.2.1.

4.2.2 Polygonal Presentation. A *triangulation* of a surface S consisting of a finite family of closed subsets $\{T_1, T_2, \dots, T_n\}$ that covers S with $T_i \cap T_j = \emptyset$, a vertex v or an entire edge e in common, and a family of homeomorphisms $\phi_i : T'_i \rightarrow T_i$, where each T'_i is a triangle in the plane \mathbf{R}^2 , i.e., a compact subset bounded by 3 distinct straight lines. The images of vertices and edges of the triangle T'_i under ϕ_i are called also the *vertices* and *edges*, respectively. For example, a triangulation of the Möbius strip can be found in Fig.4.2.2.

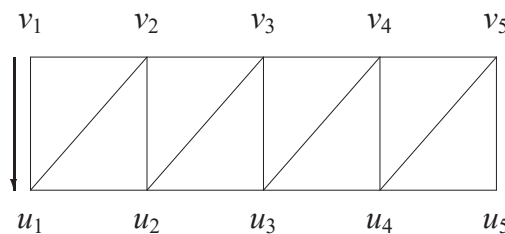

Fig.4.2.2

In fact, there are many non-isomorphic triangulation for a surface, which is the central problem of enumerative theory of maps (See [Liu2]-[Liu4] for details). T.Radó proved the following result in 1925.

Theorem 4.2.1(Radó) *Any compact surface S admits a triangulation.*

The proof of this theorem is not difficult but very tedious. We will not present it here. The reader can refer references, such as those of [AhS1] and [Lee1] for details. The following result is fundamental for classifying surfaces without boundary.

Theorem 4.2.2 *Let S be a compact surface with a triangulation \mathcal{T} . Then S is homeomorphic to a quotient surface by identifying edge pairs of triangles in \mathcal{T} .*

Proof Let $\mathcal{T} = \{T_i; 1 \leq i \leq n\}$ be a triangulation of S . Our proof is divided into two assertions following:

(A1) *Let v be a vertex of \mathcal{T} . Then there is an arrangement of triangles with v as a vertex in cyclic order $T_1^v, T_2^v, \dots, T_{\rho(v)}^v$ such that T_i and T_{i+1} have an edge in common for integers $1 \leq i \leq \rho(v) \pmod{\rho(v)}$.*

Define an *equivalence* on two triangles T_i^v, T_j^v by that of T_i^v and T_j^v have exactly an edge in common in \mathcal{T} . It is clear that this relation is indeed an equivalent relation on \mathcal{T} . Denote by $[\mathcal{T}]$ all such equivalent classes in \mathcal{T} . Then if $|\mathcal{T}| = 1$, we get the assertion (A1). Otherwise, $|\mathcal{T}| \geq 2$, we can choose $[T_s^v], [T_l^v] \in [\mathcal{T}]$ such that $[T_s^v] \cap [T_l^v] = \{v\}$ in \mathcal{T} . Whence, there is a neighborhood W_v of v small enough such that $W_v - v$ is disconnected. But by the definition of surface, there is a neighborhood W^v of v homeomorphic to an open sphere B^2 in S . Consequently, $W^v - v$ is connected for any neighborhood W_v of v small enough, a contradiction.

(A2) *Each edge is an edge of exactly two triangles.*

First, each edge is an edge of two triangles at least in \mathcal{T} , i.e., there are no vertices x on an edge of T_i for an integer, $i, 1 \leq i \leq n$ with a neighborhood W_x homeomorphic to an open ball B^2 . Otherwise, a loop L encircled x in $T_i - W_x$ can not be continuously contracted to the point in T_i . But it is clear that any loop in $T_i - W_x$ for neighborhoods W_x of x small enough can be continuously contracted to a point in $T_i - W_x$ for any point x on an edge of T_x , a contradiction.

Second, each edge is exactly an edge of two triangles. Notice that we can continuously subdivide a triangulation such that triangles T with a common edge e are contained in an ϵ -neighborhood of a point in T . Not loss of generality, we assume \mathcal{T} is such a triangulation of S . By applying Jordan curve theorem, i.e., *the moving of any closed curve C on S^2 reminds two connected components W_1, W_2 with $W_1 \cap W_2 = C$* , we know that each edge

is exactly an edge of two triangles in \mathcal{T} . In fact, let $ee_{11}e_{21}, ee_{12}e_{22}, \dots, ee_{s1}e_{s1}$ be triangles contained in an ϵ -neighborhood W with a common edge e , where $e, e_{1i}, e_{2i}, 1 \leq i \leq s$ are edges of these triangles. Then $W - ee_{11}e_{21}$ has two connected components by Jordan curve theorem. One of them is the interior of triangle $ee_{11}e_{21}$ and another is $W - T_e$, where T_e is the triangle with boundary $ee_{11}e_{21}$. So there must be $s = 2$.

Combining assertions (A1)-(A2), we consequently get the result. \square

According to Theorem 4.2.2, we know that a compact surface can be presented by identifying edges of triangles, where each edge is exactly an edge of two triangles. Generally, let \mathcal{A} be a set. A *word* is defined to be an ordered k -tuple of elements $a \in \mathcal{A}$ with the form a or a^{-1} . A *polygonal presentation*, denoted by

$$\mathcal{W} = \langle \mathcal{A} \mid W_1, W_2, \dots, W_k \rangle$$

is a finite set \mathcal{A} together with finitely many words W_1, W_2, \dots, W_k in \mathcal{A} such that each element of \mathcal{A} appears in at least one words. A polygonal presentation $\langle \mathcal{A} \mid W_1, W_2, \dots, W_k \rangle$ is called a *surface presentation* if each element $a \in \mathcal{A}$ occurs exactly twice in W_1, W_2, \dots, W_k with the form a or a^{-1} . We call elements $a \in \mathcal{A}$ to be *edges*, $W_i, 1 \leq i \leq k$ to be *faces* of \mathcal{S} and vertices appeared in each face *vertices* if each words is represented by a polygon on the plane \mathbf{R}^2 . It can be known that a surface is orientable if and only if the two occurrences of each element $a \in \mathcal{A}$ are with different power, otherwise, non-orientable.

For example, let S be the torus T^2 with short side a and length side b in Fig.4.1.5. Then we get its polygonal presentation $T^2 = \langle a, b \mid aba^{-1}b^{-1} \rangle$. Generally, Theorem 4.2.2 enables one knowing that the existence of polygonal presentation for compact surfaces S , at least by triangles, i.e., each words W is length of 3 in \mathcal{A} .

4.2.3 Elementary Equivalence. Let \mathcal{A} be a set of English alphabets, the minuscules $a, b, c, \dots \in \mathcal{A}$ but the Greek alphabets $\alpha, \beta, \gamma, \dots \notin \mathcal{A}$, $\mathcal{S} = \langle \mathcal{A} \mid W_1, W_2, \dots, W_k \rangle$ be a surface presentation and let the capital letters A, B, \dots be sections of successive elements in order and A^{-1}, B^{-1}, \dots in reversing order in words W . For two words W_1, W_2 in \mathcal{S} , the notation W_1W_2 denotes the word formed by concatenating W_1 with W_2 in order. We adopt the convention that $(a^{-1})^{-1} = a$ in this book.

Define operations El.1–El.6, called *elementary transformations* on \mathcal{S} following:

El.1(Relabeling): *Changing all occurrences of a by $\alpha \notin \mathcal{A}$, interchanging all oc-*

currences of two elements a and b , or interchanging all occurrences a and a^{-1} , i.e.,

$$\begin{aligned} \langle \mathcal{A} | aAbB, W_2, \dots, W_k \rangle &\leftrightarrow \langle \mathcal{A} | bAaB, W_2, \dots, W_k \rangle, \\ \langle \mathcal{A} | aAa^{-1}B, W_2, \dots, W_k \rangle &\leftrightarrow \langle \mathcal{A} | a^{-1}Aa, W_2, \dots, W_k \rangle \text{ or} \\ \langle \mathcal{A} | aA, a^{-1}B, \dots, W_k \rangle &\leftrightarrow \langle \mathcal{A} | a^{-1}A, aB, \dots, W_k \rangle. \end{aligned}$$

El.2(Subdividing or Consolidating) *Replacing every occurrence of a by $\alpha\beta$ and a^{-1} by $\beta^{-1}\alpha^{-1}$, or vice versa, i.e.,*

$$\begin{aligned} \langle \mathcal{A} | aAa^{-1}B, W_2, \dots, W_k \rangle &\leftrightarrow \langle \mathcal{A} | \alpha\beta A \beta^{-1} \alpha^{-1} B, W_2, \dots, W_k \rangle \\ \langle \mathcal{A} | aA, a^{-1}B, \dots, W_k \rangle &\leftrightarrow \langle \mathcal{A} | \alpha\beta A, \beta^{-1} \alpha^{-1} B, \dots, W_k \rangle. \end{aligned}$$

El.3(Reflecting) *Reversing the order of a word $W = a_1 a_2 \dots a_m$, i.e.,*

$$\langle \mathcal{A} | a_1, a_2 \dots a_m, W_2, \dots, W_k \rangle \leftrightarrow \langle \mathcal{A} | a_m^{-1} \dots a_2^{-1} a_1^{-1}, W_2, \dots, W_k \rangle.$$

El.4(Rotating) *Changing the order of a word $W = a_1 a_2 \dots a_m$ by rotating, i.e.,*

$$\langle \mathcal{A} | a_1, a_2 \dots a_m, W_2, \dots, W_k \rangle \leftrightarrow \langle \mathcal{A} | a_m a_1 \dots a_{m-1}, W_2, \dots, W_k \rangle.$$

El.5(Cutting or Pasting) *If the length of W_1, W_2 are both not less than 2, then*

$$\langle \mathcal{A} | W_1 W_2, \dots, W_k \rangle \leftrightarrow \langle \mathcal{A} | W_1 \gamma, \gamma^{-1} W_2, \dots, W_k \rangle.$$

El.6(Folding or Unfolding) *If the length of W_1 is at least 3, then*

$$\langle \mathcal{A} | W_1 \delta \delta^{-1}, W_2, \dots, W_k \rangle \leftrightarrow \langle \mathcal{A} | W_1, W_2, \dots, W_k \rangle.$$

Let \mathcal{S}_1 and \mathcal{S}_2 be two surface presentations. If \mathcal{S}_1 can be converted to that of \mathcal{S}_2 by a series of elementary transformations $\pi_1, \pi_2, \dots, \pi_m$ in $El.1 - El.6$, we say \mathcal{S}_1 and \mathcal{S}_2 to be *elementary equivalent* and denote by $\mathcal{S}_1 \sim_{El} \mathcal{S}_2$. It is obvious that the elementary equivalence is indeed an equivalent relation on surface presentations. The following result is fundamental for applying surface presentations to that of classifying compact surfaces.

Theorem 4.2.3 *Let S_1 and S_2 be compact surfaces with respective presentations $\mathcal{S}_1, \mathcal{S}_2$. If $\mathcal{S}_1 \sim_{El} \mathcal{S}_2$, then S_1 is homeomorphic to S_2 .*

Proof By the definition of elementary transformation, it is clear that each pairs of cutting and pasting, folding and unfolding, subdividing and consolidating are inverses of each other. Whence, we are only need to prove our result for one of such pairs.

Cutting. Let P_1 and P_2 be convex polygons labeled by $W_1\gamma$ and $\gamma^{-1}W_2$, respectively and P be a convex polygon labeled by W_1W_2 . Not loss of generality, we assume these are the only words in their respective presentations. Let $\pi : P_1 \cup P_2 / \sim \rightarrow S_1$ and $\pi' : P / \sim \rightarrow S_2$ be the quotient mappings. The line segment going from the terminal vertex of W_1 in P to its initial vertex lies in P by convexity, labeled this line segment by γ . Such as those shown in Fig.4.2.3 following.

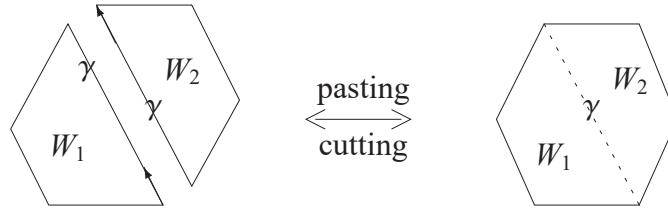

Fig.4.2.3

Applying the gluing lemma, there is a continuous mapping $f : P_1 \cup P_2 \rightarrow P$ that takes each edge of P_1 or P_2 to the edge in P with a corresponding label, and whose restriction to P_1 or P_2 is a homeomorphism, i.e., f is a quotient mapping. Because f identifying two edges labeled by γ and γ^{-1} but nothing else, the quotient mapping $\pi \circ f$ and π' makes the same identifications. So their quotient spaces are homeomorphic.

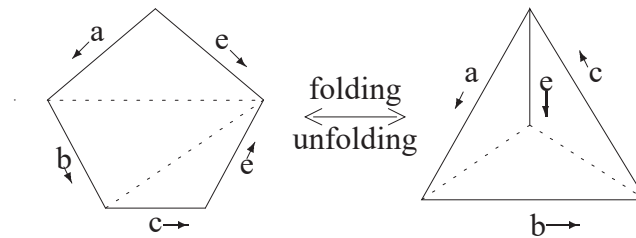

Fig.4.2.4

If $k \geq 3$, extending f by declaring it to be the identity on the respective polygons and processed as above, we also get the result.

Folding. Similarly, we can ignore the additional words W_2, \dots, W_k . If the length of W_1 is 2, subdivide it and then perform the folding transformation and then consolidate. So we can assume the length of W_1 is not less than 3. First, let $W_1 = abc$ and P, P' be convex polygons with edge labels $abcee^{-1}$ and abc , respectively. Let $\pi : P \rightarrow S_1$ and $\pi' : P' \rightarrow S_2$ be the quotient mappings. Now adding edges in P, P' , turns them into

polyhedra, such as those shown in Fig.4.2.4. There is a continuous mapping $f : P \rightarrow P'$ that takes each edge of P to that the edge of P' with the same label. Then $\pi' \circ f$ and π are quotient mappings that make the same identifications.

If the length ≥ 4 of W_1 , we can write $W_1 = Abc$ for some section A of length at least 2. Cutting along a we obtain

$$\langle \mathcal{A}, b, c, e|Abcee^{-1} \rangle \sim_{El} \langle \mathcal{A}, a, b, c, e|Aa^{-1}, abcee^{-1} \rangle$$

and processed as before to get the result.

Subdividing. Similarly, let P_1, P_2 be distinct polygons with sections a or a^{-1} and P'_1, P'_2 with sections replacing a by $\alpha\beta$ and a^{-1} by $\beta^{-1}\alpha^{-1}$ in P_1 and P_2 . Such as those shown in Fig.4.2.5.

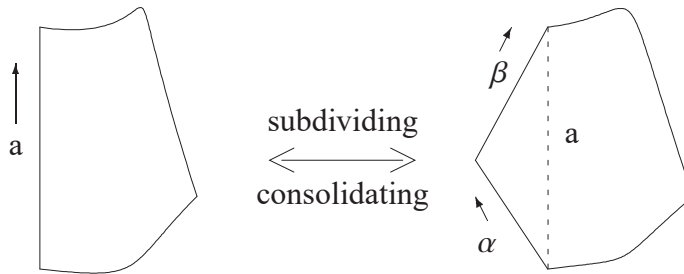

Fig.4.2.5

Certainly, there is a continuous mapping $f : P_1 \cup P_2 \rightarrow P'_1 \cup P'_2$ that takes each edge of P_1, P_2 to that the edge of P'_1, P'_2 with the same label, and the edge with label a to the edge with label $\alpha\beta$ in $P'_1 \cup P'_2$. Then $\pi' \circ f : P_1 \cup P_2 / \sim \rightarrow S_1$ and $\pi : P'_1 \cup P'_2 / \sim \rightarrow S_2$ are quotient mappings that make the same identifications.

If a or a^{-1} appears twice in a polygon P , the proof is similar. Thus S_1 is homeomorphic to S_2 in each case. □

4.2.4 Classification Theorem. Let S be a compact surface with a presentation $\mathcal{S} = \langle \mathcal{A} | W_1, W_2, \dots, W_k \rangle$ and let A, B, \dots be sections of successive elements in a word W in \mathcal{S} . Theorems 4.2.1–4.2.3 enables one to classify compact surfaces as follows.

Theorem 4.2.4 Any connected compact surface S is either homeomorphic to a sphere, or to a connected sum of tori, or to a connected sum of projective planes, i.e., its surface presentation \mathcal{S} is elementary equivalent to one of the standard surface presentations following:

- (1) The sphere $S^2 = \langle a|aa^{-1} \rangle$;
 (2) The connected sum of p tori

$$\underbrace{T^2 \# T^2 \# \cdots \# T^2}_p = \left\langle a_i, b_i, 1 \leq i \leq p \mid \prod_{i=1}^p a_i b_i a_i^{-1} b_i^{-1} \right\rangle;$$

- (3) The connected sum of q projective planes

$$\underbrace{P^2 \# P^2 \cdots \# P^2}_q = \left\langle a_i, 1 \leq i \leq q \mid \prod_{i=1}^q a_i \right\rangle.$$

Proof Let $\mathcal{S} = \langle \mathcal{A} | W_1, W_2, \dots, W_k \rangle$. For establishing this theorem, we first prove several claims on elementary equivalent presentations of surfaces following.

Claim 1. *There is a word W in \mathcal{A} such that*

$$\mathcal{S} = \langle \mathcal{A} | W_1, W_2, \dots, W_k \rangle \sim_{El} \langle \mathcal{A} | W \rangle.$$

If $k \geq 2$, we can concatenate W_1, W_2, \dots, W_k by elementary transformations *El.1 – El.6*. In fact, by definition, there is an element a only appears once in W_1 . Thus $W_1 = Aa$ and a does not appears in A . Not loss of generality, let a or a^{-1} appears in W_2 , i.e., $W_2 = Ba$ or $W_2 = a^{-1}B$. Applying *El.1 – El.6*, we know that

$$\begin{aligned} \mathcal{S} &= \langle \mathcal{A} | Aa, Ba, W_3, \dots, W_k \rangle \\ &\sim_{El} \langle \mathcal{A} | Aa, a^{-1}B^{-1}, W_3, \dots, W_k \rangle \sim_{El} \langle \mathcal{A} | AB^{-1}, W_3, \dots, W_k \rangle. \end{aligned}$$

$$\mathcal{S} = \langle \mathcal{A} | Aa, a^{-1}B, W_3, \dots, W_k \rangle \sim_{El} \langle \mathcal{A} | AB, W_3, \dots, W_k \rangle.$$

Furthermore, by induction on k we know that \mathcal{S} is elementary equivalent to a surface just with one word W if $k \geq 2$. Thus

$$\mathcal{S} = \langle \mathcal{A} | W_1, W_2, \dots, W_k \rangle \sim_{El} \langle \mathcal{A} | W \rangle.$$

Claim 2. $\langle \mathcal{A} | AaBbCa^{-1}Db^{-1}E \rangle \sim_{El} \langle \mathcal{A} | ADCBEaba^{-1}b^{-1} \rangle$.

In fact, by *El.1 – El.6*, we know that

$$\begin{aligned} &\langle \mathcal{A} | AaBbCa^{-1}Db^{-1}E \rangle \sim_{El} \langle \mathcal{A} \cup \{\delta\} | Db^{-1}EAa\delta, \delta^{-1}BbCa^{-1} \rangle \\ &\sim_{El} \langle \mathcal{A} \cup \{\delta\} \setminus \{b\} | EAa\delta DCa^{-1}\delta^{-1}B \rangle \sim_{El} \langle \mathcal{A} \cup \{\delta\} | Aa\delta b, b^{-1}DCa^{-1}\delta^{-1}BE \rangle \\ &\sim_{El} \langle \mathcal{A} | bAaBEb^{-1}DCa^{-1} \rangle \sim_{El} \langle \mathcal{A} \cup \{\delta\} | AaBE\delta, \delta^{-1}b^{-1}DCa^{-1}b \rangle \\ &\sim_{El} \langle \mathcal{A} \cup \{\delta\} \setminus \{a\} | BE\delta Ab\delta^{-1}b^{-1}DC \rangle \sim_{El} \langle \mathcal{A} \cup \{\delta\} | Aba, a^{-1}\delta^{-1}b^{-1}DCBE\delta \rangle \\ &\sim_{El} \langle \mathcal{A} \cup \{\delta\} \setminus \{b\} | ADCBE\delta a\delta^{-1}a^{-1} \rangle \sim_{El} \langle \mathcal{A} | ADCBEaba^{-1}b^{-1} \rangle. \end{aligned}$$

Claim 3. $\langle \mathcal{A} \mid AcBcC \rangle \sim_{El} \langle \mathcal{A} \mid AB^{-1}Ccc \rangle$.

By *El.1 – El.6*, we find that

$$\begin{aligned} & \langle \mathcal{A} \mid AaBaC \rangle \sim_{El} \langle \mathcal{A} \cup \{\delta\} \mid Aa\delta, \delta^{-1}BaC \rangle \\ & \sim_{El} \langle \mathcal{A} \cup \{\delta\} \mid \delta Aa, a^{-1}B^{-1}\delta C^{-1} \rangle \sim_{El} \langle \mathcal{A} \cup \{\delta\} \setminus \{a\} \mid \delta AB^{-1}\delta C^{-1} \rangle \\ & \sim_{El} \langle \mathcal{A} \cup \{\delta\} \mid AB^{-1}\delta a, a^{-1}C^{-1}\delta \rangle \sim_{El} \langle \mathcal{A} \cup \{\delta\} \mid aAB^{-1}\delta, \delta^{-1}Ca \rangle \\ & \sim_{El} \langle \mathcal{A} \mid AB^{-1}Caa \rangle. \end{aligned}$$

Claim 4. $\langle \mathcal{A} \mid Accaba^{-1}b^{-1} \rangle \sim_{El} \langle \mathcal{A} \mid Accaabb \rangle$.

Applying *El.1 – El.6* and Claim 3, we get that

$$\begin{aligned} & \langle \mathcal{A} \mid Accaba^{-1}b^{-1} \rangle \sim_{El} \langle \mathcal{A} \cup \{\delta\} \mid a^{-1}b^{-1}Ac\delta, \delta^{-1}cab \rangle \\ & \sim_{El} \langle \mathcal{A} \cup \{\delta\} \mid \delta a^{-1}b^{-1}Ac, c^{-1}\delta b^{-1}a^{-1} \rangle \sim_{El} \langle \mathcal{A} \cup \{\delta\} \setminus \{c\} \mid \delta a^{-1}b^{-1}A\delta b^{-1}a^{-1} \rangle \\ & \sim_{El} \langle \mathcal{A} \cup \{\delta\} \setminus \{c\} \mid A\delta b^{-1}a^{-1}\delta a^{-1}b^{-1} \rangle. \end{aligned}$$

Applying Claim 3, we therefore have

$$\begin{aligned} & \langle \mathcal{A} \mid Accaba^{-1}b^{-1} \rangle \sim_{El} \langle \mathcal{A} \cup \{\delta\} \setminus \{c\} \mid A\delta a\delta^{-1}ab^{-1}b^{-1} \rangle \\ & \sim_{El} \langle \mathcal{A} \cup \{\delta\} \setminus \{c\} \mid A\delta\delta b^{-1}b^{-1}aa \rangle \sim_{El} \langle \mathcal{A} \mid Accaabb \rangle. \end{aligned}$$

Now we can prove the classification for connected compact surfaces. If $|\mathcal{A}| = 1$, let $\mathcal{A} = \{a\}$, then we get

$$\mathcal{S} = \langle a \mid aa^{-1} \rangle \quad \text{or} \quad \langle a \mid aa \rangle,$$

i.e., the sphere or the projective plane. If $|\mathcal{A}| \geq 2$, by Claim 1 we are only needed to prove the classification for compact surfaces with one word, i.e., $\mathcal{S} = \langle a \mid W \rangle$. Our proof is divided into two cases following.

Case 1. *There are no elements $a \in \mathcal{A}$ such that $W = AaBaC$.*

In this case, there are sections A, B, C, D, E of W such that $W = AaBbCa^{-1}Db^{-1}E$ or $W = AaBbCb^{-1}Da^{-1}E$. If there are no elements a, b such that $W = AaBbCa^{-1}Db^{-1}E$, then W must be the form of $\cdots cG(a_1H_1b_1b_1^{-1}H_1^{-1}a_1^{-1}) \cdots (a_lH_l b_l b_l^{-1}H_l^{-1}a_l^{-1})G^{-1}d^{-1} \cdots$. By the elementary transformation *El.5*, we finally get that $\mathcal{S} \sim_{El} \langle \mathcal{A} \mid aa^{-1} \rangle$, the sphere. Not loss of generality, we will assume that this case never appears in our discussion, i.e., for $\forall a \in \mathcal{A}$, there are always exists $b \in \mathcal{A}$ such that $W = AaBbCa^{-1}Db^{-1}E$. In this case, by

Claim 2 we know that $\mathcal{S} \sim_{El} \langle \mathcal{A} \mid ADCBEaba^{-1}b^{-1} \rangle$. Notice that elements in $ADCBE$ also satisfy the condition of Case 1. So we can applying Claim 2 repeatedly and finally get that

$$\mathcal{S} \sim_{El} \left\langle \mathcal{A} \mid \prod_{i=1}^p a_i b_i a_i b_i^{-1} \right\rangle$$

for an integer $p \geq 1$.

Case 2. *There are elements $a \in \mathcal{A}$ such that $W = AaBaC$.*

In this case, by Claim 3 we know that $\mathcal{S} \sim_{El} \langle \mathcal{A} \mid AB^{-1}Caa \rangle$. Applying Claim 3 to $AB^{-1}C$ repeatedly, we finally get that

$$\mathcal{S} \sim_{El} \left\langle \mathcal{A} \mid H \prod_{i=1}^s a_i a_i \right\rangle$$

for an integer $s \geq 1$ such that there are no elements $b \in H$ such that $H = DbCbE$. Thus each element $x \in \mathcal{A} \setminus \{a_i; 1 \leq i \leq s\}$ appears x at one time and x^{-1} at another. Similar to the discussion of Case 1, we know that

$$\mathcal{S} \sim_{El} \left\langle \mathcal{A} \mid H \prod_{i=1}^s a_i a_i \right\rangle \sim_{El} \left\langle \mathcal{A} \mid \prod_{i=1}^s a_i a_i \prod_{j=1}^t x_j y_j x_j^{-1} y_j^{-1} \right\rangle$$

for some integers s, t by applying Claim 2. Applying Claim 4 also, we finally get that

$$\mathcal{S} \sim_{El} \left\langle \mathcal{A} \mid H \prod_{i=1}^s a_i a_i \right\rangle \sim_{El} \left\langle \mathcal{A} \mid \prod_{i=1}^q a_i a_i \right\rangle,$$

for an integer $q = s + 2t$. This completes the proof. \square

Notice that each step in the proof of Theorem 4.2.4 does not change the orientability of a surface S with a presentation \mathcal{S} . We get the following conclusion.

Corollary 4.2.1 *A surface S is orientable if and only if it is elementary equivalent to the sphere S^2 or the connected sum $\underbrace{T^2 \# T^2 \# \cdots \# T^2}_p$ of p tori.*

4.2.5 Euler Characteristic. Let $\mathcal{S} = \langle \mathcal{A} \mid W_1, W_2, \dots, W_k \rangle$ be a surface presentation and $\pi : \langle \mathcal{A} \mid W_1, W_2, \dots, W_k \rangle \rightarrow \mathcal{S}$ a projection by identifying a with a^{-1} for $\forall a \in \mathcal{A}$. The *Euler characteristic* of \mathcal{S} is defined by

$$\chi(\mathcal{S}) = |V(\mathcal{S})| - |E(\mathcal{S})| + |F(\mathcal{S})|,$$

where $V(\mathcal{S}), E(\mathcal{S})$ and $F(\mathcal{S})$ are respective the set of vertex set, edge set and face set of the surface \mathcal{S} . We are easily knowing that $|E(\mathcal{S})| = |\mathcal{A}|, |F(\mathcal{F})| = k$ and $|V(\mathcal{S})|$ the number of orbits of vertices in polygons W_1, W_2, \dots, W_k under π . The Euler characteristic of a surface is topological invariant. Furthermore, it is unchange by elementary transformations.

Theorem 4.2.5 *If $\mathcal{S}_1 \sim_{El} \mathcal{S}_2$, then $\chi(\mathcal{S}_1) = \chi(\mathcal{S}_2)$, i.e., the Euler characteristic is an invariant under elementary transformations.*

Proof Let $\langle \mathcal{A} | W_1, W_2, \dots, W_k \rangle$ be a presentation of a surface \mathcal{S} . We only need to prove each elementary $El.1 - El.6$ on \mathcal{S} does not change the value $\chi(\mathcal{S})$. Notice the elementary transformations $El.1$ (Relabeling), $El.3$ (Reflecting) and $El.4$ (Rotating) leave the numbers of vertices, edges and faces unchanged. Consequently, $\chi(\mathcal{S})$ is invariant under $El.1, El.3 - El.4$. We only need to check the result for elementary transformations $El.2$ (Subdividing or Consolidating), $El.5$ (Cutting or Pasting) and $El.6$ (Folding or Unfolding). In fact, $El.2$ (Subdividing or Consolidating) increase or decrease both the number of edges and the number of vertices by 1, leaves the number of faces unchanged, $El.5$ (Cutting or Pasting) increases or decreases both the number of edges and the number of faces by 1, leaves the number of vertices unchanged and $El.6$ (Folding or Unfolding) increases or decreases the number of edges and the number of vertices, leaves the number of faces unchanged. Whence, $\chi(\mathcal{S})$ is invariant under these elementary transformations $El.1 - El.6$. This completes the proof. \square

Applying Theorems 4.2.4 and 4.2.5, we get the Euler characteristic of connected compact surfaces following.

Theorem 4.2.6 *Let S be a connected compact surface with a presentation \mathcal{S} . Then*

$$\chi(\mathcal{S}) = \begin{cases} 2, & \text{if } \mathcal{S} \sim_{El} S^2, \\ 2 - 2p, & \text{if } \mathcal{S} \sim_{El} \underbrace{T^2 \# T^2 \# \dots \# T^2}_p, \\ 2 - q, & \text{if } \mathcal{S} \sim_{El} \underbrace{P^2 \# P^2 \# \dots \# P^2}_q. \end{cases}$$

Proof Notice that the numbers of vertices, edges and faces of a surface S are respective $|V(\mathcal{S})| = 2, |E(\mathcal{S})| = 1, |F(\mathcal{S})| = 1$ if $\mathcal{S} = \langle a|aa^{-1} \rangle$ (See Fig.4.1.5 for details), $|V(\mathcal{S})| = 1, |E(\mathcal{S})| = 2p, |F(\mathcal{S})| = 1$ if $\mathcal{S} = \left\langle a_i, b_i, 1 \leq i \leq p \mid \prod_{i=1}^p a_i b_i a_i^{-1} b_i^{-1} \right\rangle$ and $|V(\mathcal{S})| = 1, |E(\mathcal{S})| = q, |F(\mathcal{S})| = 1$ if $\mathcal{S} = \left\langle a_i, 1 \leq i \leq q \mid \prod_{i=1}^q a_i \right\rangle$. By definition, we know

that

$$\chi(S) = \begin{cases} 2, & \text{if } S \sim_{El} S^2, \\ 2 - 2p, & \text{if } S \sim_{El} \underbrace{T^2 \# T^2 \# \dots \# T^2}_p, \\ 2 - q, & \text{if } S \sim_{El} \underbrace{P^2 \# P^2 \# \dots \# P^2}_q \end{cases}$$

by Theorem 4.2.5. Applying Theorems 4.2.4, the conclusion is followed. \square

The numbers p and q is usually defined to be the *genus* of the surface S , denoted by $g(S)$. Theorem 4.2.6 implies that $g(S) = 0, p$ or q if S is elementary equivalent to the sphere, the connected sum of p tori or the connected sum of q projective plane.

§4.3 FUNDAMENTAL GROUPS

4.3.1 Homotopic Mapping. Let $\mathcal{T}_1, \mathcal{T}_2$ be two topological spaces and let $\varphi_1, \varphi_2 : \mathcal{T}_1 \rightarrow \mathcal{T}_2$ be two continuous mappings. If there exists a continuous mapping $H : \mathcal{T}_1 \times I \rightarrow \mathcal{T}_2$ such that

$$H(x, 0) = \varphi_1(x) \quad \text{and} \quad H(x, 1) = \varphi_2(x)$$

for $\forall x \in \mathcal{T}_1$, then φ_1 and φ_2 are called *homotopic*, denoted by $\varphi_1 \simeq \varphi_2$. Furthermore, if there is a subset $A \subset \mathcal{T}$ such that

$$H(a, t) = \varphi_1(a) = \varphi_2(a), \quad a \in A, t \in I,$$

then φ_1 and φ_2 are called *homotopic relative to A*. Clearly, φ_1 is homotopic to φ_2 if $A = \emptyset$.

Theorem 4.3.1 For two topological spaces \mathcal{T}, \mathcal{J} , the homotopic \simeq on the set of all continuous mappings from \mathcal{T} to \mathcal{J} is an equivalent relation, i.e, all homotopic mappings to a mapping f is an equivalent class, denoted by $[f]$.

Proof Let f, g, h be continuous mappings from \mathcal{T} to \mathcal{J} , $f \simeq g$ and $g \simeq h$ with homotopic mappings H_1 and H_2 . Then we know that

- (1) $f \simeq f$ if choose $H : I \times I \rightarrow \mathcal{T}$ by $H(t, s) = f(t)$ for $\forall s \in I$.
- (2) $g \simeq f$ if choose $H(t, s) = H_1(t, 1 - s)$ for $\forall s, t \in I$ which is obviously continuous.
- (3) Define $H(t, s) = H_2H_1(t, s)$ for $\forall s, t \in I$ by

$$H(t, s) = H_2H_1(t, s) = \begin{cases} H_1(x, 2t), & \text{if } 0 \leq t \leq \frac{1}{2}, \\ H_2(x, 2t - 1), & \text{if } \frac{1}{2} \leq t \leq 1. \end{cases}$$

Notice that $H_1(x, 2t) = H_1(x, 1) = g(x) = H_2(x, 2t - 1)$ if $t = \frac{1}{2}$. Applying Theorem 4.1.3, we know the continuousness of H_1H_2 . Whence, $f \simeq h$. \square

Theorem 4.3.2 *If $f_1, f_2 : \mathcal{T} \rightarrow \mathcal{J}$ and $g_1, g_2 : \mathcal{J} \rightarrow \mathcal{L}$ are continuous mappings with $f_1 \simeq f_2$ and $g_1 \simeq g_2$, then $f_1 \circ g_1 \simeq f_2 \circ g_2$.*

Proof Assume $F : f_1 \simeq f_2$ and $G : g_1 \simeq g_2$ are homotopies. Define a new homotopy $H : \mathcal{T} \times I \rightarrow \mathcal{L}$ by $H(x, t) = G(F(x, t), t)$. Then $H(x, 0) = G(f_1(x), 0) = g_1(f_1(x))$ for $t = 0$ and $H(x, 1) = G(f_2(x), 1) = g_2(f_2(x))$ for $t = 1$. Thus H is a homotopy from $g_1 \circ f_1$ to $g_2 \circ f_2$. \square

We present two examples for homotopies of topological spaces.

Example 4.3.1 Let $f, g : \mathbf{R} \rightarrow \mathbf{R}^2$ determined by

$$f(x) = (x, x^2), \quad g(x) = (x, x)$$

and $H(x, t) = (x, x^2 - tx^2 + tx)$. Then $H : \mathbf{R} \times I \rightarrow \mathbf{R}^2$ is continuous with $H(x, 0) = f(x)$ and $H(x, 1) = g(x)$. Whence, $H : f \simeq g$.

Example 4.3.2 Let $f, g : \mathcal{T} \rightarrow \mathbf{R}^2$ be continuous mappings from a topological space \mathcal{T} to \mathbf{R}^2 . Define a mapping $H : \mathcal{T} \times I \rightarrow \mathbf{R}^2$ by

$$H(x, t) = (1 - t)f(x) + tg(x), \quad x \in \mathcal{T}.$$

Clearly, H is continuous with $H(x, 0) = f(x)$ and $H(x, 1) = g(x)$. Therefore, $H : f \simeq g$. Such a homotopy H is called a *straight-line homotopy* between f and g .

4.3.2 Fundamental Group. Particularly, let $a, b : I \rightarrow \mathcal{T}$ be two arcs with $a(0) = b(0)$ and $a(1) = b(1)$ in a topological space \mathcal{T} . In this case, $a \simeq b$ implies that there exists a continuous mapping

$$H : I \times I \rightarrow \mathcal{T}$$

such that $H(t, 0) = a(t)$, $H(t, 1) = b(t)$ for $\forall t \in I$ by definition.

Now let a and b be two arcs in a topological space \mathcal{T} with $a(1) = b(0)$. A *product arc* $a \cdot b$ of a with b is defined by

$$a \cdot b(t) = \begin{cases} a(2t), & \text{if } 0 \leq t \leq \frac{1}{2}, \\ b(2t - 1), & \text{if } \frac{1}{2} \leq t \leq 1 \end{cases}$$

and an inverse mapping of a by $\bar{a} = a(1 - t)$.

Notice that $a \cdot b : I \rightarrow \mathcal{T}$ and $\bar{a} : I \rightarrow \mathcal{T}$ are continuous by Corollary 4.1.1. Whence, they are indeed arcs by definition, called the *product arc* of a with b and the *inverse arc* of a . Sometimes it is needed to distinguish the orientation of an arc. We say the arc a *orientation-preserving* and its inverse \bar{a} *orientation-reversing*.

Let a, b be arcs in a topological space \mathcal{T} . Properties on product of arcs following are hold obviously by definition.

- (P1) $\overline{\bar{a}} = a$;
- (P2) $\bar{b} \cdot \bar{a} = \overline{a \cdot b}$ providing ab existing;
- (P3) $\bar{e}_x = e_x$, where $x = e(0) = e(1)$.

Theorem 4.3.3 *Let a, b, c and d be arcs in a topological space S . Then*

- (1) $\bar{a} \simeq \bar{b}$ if $a \simeq b$;
- (2) $a \cdot b \simeq c \cdot d$ if $a \simeq b, c \simeq d$ with $a \cdot c$ an arc.

proof Let H_1 be a homotopic mapping from a to b . Define a continuous mapping $H' : I \times I \rightarrow S$ by $H'(t, s) = H_1(1 - t, s)$ for $\forall t, s \in I$. Then we find that $H'(t, 0) = \bar{a}(t)$ and $H'(t, 1) = \bar{b}(t)$. Whence, we get that $\bar{a} \simeq \bar{b}$, i.e., the assertion (1).

For (2), let H_2 be a homotopic mapping from c to d . Define a mapping $H : I \times I \rightarrow S$ by

$$H(t, s) = \begin{cases} H_1(2t, s), & \text{if } 0 \leq t \leq \frac{1}{2}, \\ H_2(2t - 1, s), & \text{if } \frac{1}{2} \leq t \leq 1. \end{cases}$$

Notice that $a(1) = c(0)$ and $H_1(1, s) = a(1) = c(0) = H_2(0, s)$. Applying Corollary 4.1.1, we know that H is continuous. Therefore, $a \cdot b \simeq c \cdot d$. \square

For a topological space \mathcal{T} , $x_0 \in \mathcal{T}$, let $\pi_1(\mathcal{T}, x_0)$ be a set consisting of equivalent classes of loops based at x_0 . Define an operation \circ in $\pi_1(\mathcal{T}, x_0)$ by

$$[a] \circ [b] = [a \cdot b] \text{ and } [a]^{-1} = [a^{-1}].$$

Then we know that $\pi_1(\mathcal{T}, x_0)$ is a group shown in the following result.

Theorem 4.3.4 $\pi_1(\mathcal{T}, x_0)$ is a group.

Proof We check each condition of a group for $\pi_1(\mathcal{T}, x_0)$. First, it is closed under the operation \circ since $[a] \circ [b] = [a \cdot b]$ is an equivalent class of loop $a \cdot b$ based at x_0 for $\forall [a], [b] \in \pi_1(\mathcal{T}, x_0)$.

Now let $a, b, c : I \rightarrow \mathcal{T}$ be three loops based at x_0 . By definition we know that

$$(a \cdot b) \cdot c(t) = \begin{cases} a(4t), & \text{if } 0 \leq t \leq \frac{1}{4}, \\ b(4t - 1), & \text{if } \frac{1}{4} \leq t \leq \frac{1}{2}, \\ c(2t - 1), & \text{if } \frac{1}{2} \leq t \leq 1. \end{cases}$$

and

$$a \cdot (b \cdot c)(t) = \begin{cases} a(2t), & \text{if } 0 \leq t \leq \frac{1}{2}, \\ b(4t - 2), & \text{if } \frac{1}{2} \leq t \leq \frac{3}{4}, \\ c(4t - 3), & \text{if } \frac{3}{4} \leq t \leq 1. \end{cases}$$

Define a function $H : I \times I \rightarrow \mathcal{T}$ by

$$H(t, s) = \begin{cases} a\left(\frac{4t}{1+s}\right), & \text{if } 0 \leq t \leq \frac{s+1}{4}, \\ b\left(4t - 1 - s\right), & \text{if } \frac{s+1}{4} \leq t \leq \frac{s+2}{4}, \\ c\left(1 - \frac{4(1-t)}{2-s}\right), & \text{if } \frac{s+2}{4} \leq t \leq 1. \end{cases}$$

Then H is continuous by applying Corollary 4.1.1, $H(t, 0) = ((a \cdot b) \cdot c)(t)$ and $H(t, 1) = (a \cdot (b \cdot c))(t)$. Thereafter, we know that $([a] \circ [b]) \circ [c] = [a] \circ ([b] \circ [c])$.

Now let $e_{x_0} : I \rightarrow x_0 \in \mathcal{T}$ be the point loop at x_0 . Then it is easily to check that

$$a \cdot \bar{a} \simeq e_{x_0}, \quad \bar{a} \cdot a \simeq e_{x_0}$$

and

$$e_{x_0} \cdot a \simeq a, \quad a \cdot e_{x_0} \simeq a.$$

We conclude that $\pi_1(\mathcal{T}, x_0)$ is a group with a unit $[e_{x_0}]$ and an inverse element $[a^{-1}]$ for any $[a] \in \pi_1(\mathcal{T}, x_0)$ by definition. \square

Let \mathcal{T} be a topological space, $x_0, x_1 \in \mathcal{T}$ and \mathfrak{f} an arc from x_0 to x_1 . For $\forall [a] \in \pi_1(\mathcal{T}, x_0)$, we know that $\mathfrak{f} \circ [a] \circ \mathfrak{f}^{-1} \in \pi_1(\mathcal{T}, x_1)$ (see Fig.4.31.1 below). Whence, the mapping $\mathfrak{f}_\# = \mathfrak{f} \circ [a] \circ \mathfrak{f}^{-1} : \pi_1(\mathcal{T}, x_0) \rightarrow \pi_1(\mathcal{T}, x_1)$.

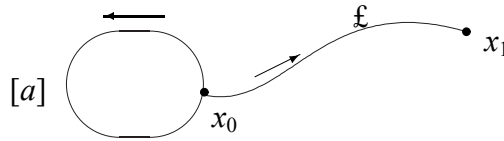

Fig.4.3.1

Then we know the following result.

Theorem 4.3.5 *Let \mathcal{T} be a topological space. If $x_0, x_1 \in \mathcal{T}$ and \mathfrak{f} is an arc from x_0 to x_1 in \mathcal{T} , then $\pi_1(\mathcal{T}, x_0) \simeq \pi_1(\mathcal{T}, x_1)$.*

Proof We have known that $\mathfrak{f}_\# : \pi_1(\mathcal{T}, x_0) \rightarrow \pi_1(\mathcal{T}, x_1)$. For $[a], [b] \in \pi_1(\mathcal{T}, x_0)$, $[a] \neq [b]$, we find that

$$\mathfrak{f}_\#([a]) = \mathfrak{f} \circ [a] \circ \mathfrak{f}^{-1} \neq \mathfrak{f} \circ [b] \circ \mathfrak{f}^{-1} = \mathfrak{f}_\#([b]),$$

i.e., $\mathfrak{f}_\#$ is a 1 – 1 mapping. Choose $[c] \in \pi_1(\mathcal{T}, x_0)$. Then

$$\begin{aligned} \mathfrak{f}_\#([a]) \circ \mathfrak{f}_\#([c]) &= \mathfrak{f} \circ [a] \circ \mathfrak{f}^{-1} \circ \mathfrak{f} \circ [c] \circ \mathfrak{f}^{-1} = \mathfrak{f} \circ [a] \circ \mathbf{e}_{x_1} \circ [c] \circ \mathfrak{f}^{-1} \\ &= \mathfrak{f} \circ [a] \circ [c] \circ \mathfrak{f}^{-1} = \mathfrak{f}_\#([a] \circ [c]). \end{aligned}$$

Therefore, $\mathfrak{f}_\#$ is a homomorphism.

Similarly, $\mathfrak{f}_\#^{-1} = \mathfrak{f}^{-1} \circ [a] \circ \mathfrak{f}$ is also a homomorphism from $\pi_1(\mathcal{T}, x_1)$ to $\pi_1(\mathcal{T}, x_0)$ and $\mathfrak{f}_\#^{-1} \circ \mathfrak{f}_\# = [\mathbf{e}_{x_1}]$, $\mathfrak{f}_\# \circ \mathfrak{f}_\#^{-1} = [\mathbf{e}_{x_0}]$ are the identity mappings between $\pi_1(\mathcal{T}, x_0)$ and $\pi_1(\mathcal{T}, x_1)$. Hence, $\mathfrak{f}_\#$ is an isomorphism from $\pi_1(\mathcal{T}, x_0)$ to $\pi_1(\mathcal{T}, x_1)$. \square

Theorem 4.3.5 implies the fundamental group of a arcwise-connected space \mathcal{T} is independent on the choice of base point x_0 . Whence, we can denote the fundamental group of \mathcal{T} by $\pi_1(\mathcal{T})$. If $\pi_1(\mathcal{T}) = \{[e_{x_0}]\}$, then \mathcal{T} is called to be a *simply connected space*. For example, the Euclidean space \mathbf{R}^n , n -ball B^n are simply connected spaces for $n \geq 2$. We determine the fundamental groups of graphs embedded in topological spaces in the following.

Theorem 4.3.6 *Let G be an embedded graph on a topological space S and T a spanning tree in G . Then $\pi_1(G) = \langle T + e \mid e \in E(G \setminus T) \rangle$.*

Proof We prove this assertion by induction on the number of $n = |E(T)|$. If $n = 0$, G is a bouquet, then each edge e is a loop itself. A closed walk on G is a combination of edges e in $E(G)$, i.e., $\pi_1(G) = \langle e \mid e \in E(G) \rangle$ in this case.

Assume the assertion is true for $n = k$, i.e., $\pi_1(G) = \langle T + e \mid e \in E(G \setminus T) \rangle$. Consider the case of $n = k + 1$. For any edge $\widehat{e} \in E(T)$, we consider the embedded graph G/\widehat{e} , which means continuously to contract \widehat{e} to a point v in S . A closed walk on G passes or not through \widehat{e} in G is homotopic to a walk passes or not through v in G/\widehat{e} for $\kappa(T) = 1$. Therefore, we conclude that $\pi_1(G) = \langle T + e \mid e \in E(G \setminus T) \rangle$ by the induction assumption. \square

4.3.3 Seifert-Van Kampen Theorem. For a subset A of B , an *inclusion mapping* $i : A \rightarrow B$ is defined by $i(a) = a$ for $\forall a \in A$. A subset A of a topological space X is called a *deformation retract* of X if there exists a continuous mapping $r : X \rightarrow A$ and a homotopy $f : X \times I \rightarrow X$ such that

$$f(x, 0) = x, \quad f(x, 1) = r(x), \quad \forall x \in X \quad \text{and} \quad f(a, t) = a, \quad \forall a \in A \quad \text{and} \quad t \in I.$$

we have the following result.

Theorem 4.3.7 *If A is a deformation retract of X , then the inclusion mapping $i : A \rightarrow X$ induces an isomorphism of $\pi_1(A, a)$ onto $\pi_1(X, a)$ for any $a \in A$.*

Proof Let $i_* : \pi_1(A, a) \rightarrow \pi_1(X, a)$ and $r_* : \pi_1(X, a) \rightarrow \pi_1(A, a)$ be induced homomorphisms by i and r . We conclude that r_*i_* is the identity mapping of $\pi_1(A, a)$. Notice that ir is homotopic to the identity mapping $X \rightarrow X$ relative to $\{a\}$. We know that i_*r_* is the identity mapping of $\pi_1(X, a)$. Thus $i_* : \pi_1(A, a) \rightarrow \pi_1(X, a)$ is an isomorphism. \square

Generally, to determine the fundamental group $\pi_1(\mathcal{T})$ of a topological space \mathcal{T} is not easy, particularly for finding its presentation. For this objective, a useful tool is the Seifert-Van Kampen theorem. Its modern form is presented by homomorphisms following.

Theorem 4.3.8(Seifert and Van-Kampen) *Let $X = U \cup V$ with U, V open subsets and let $X, U, V, U \cap V$ be non-empty arcwise-connected with $x_0 \in U \cap V$ and H a group. If there are homomorphisms*

$$\phi_1 : \pi_1(U, x_0) \rightarrow H \quad \text{and} \quad \phi_2 : \pi_1(V, x_0) \rightarrow H$$

and

$$\begin{array}{ccccc}
 & & i_1 & \rightarrow & \pi_1(U, x_0) & \xrightarrow{\phi_1} & & & \\
 & & \lrcorner & & \downarrow j_1 & & \lrcorner & & \\
 \pi_1(U \cap V, x_0) & \longrightarrow & \pi_1(X, x_0) & \xrightarrow{\Phi} & H & & & & \\
 & & \lrcorner & & \uparrow j_2 & & \lrcorner & & \\
 & & i_2 & \rightarrow & \pi_1(V, x_0) & \xrightarrow{\phi_2} & & &
 \end{array}$$

with $\phi_1 \cdot i_1 = \phi_2 \cdot i_2$, where $i_1 : \pi_1(U \cap V, x_0) \rightarrow \pi_1(U, x_0)$, $i_2 : \pi_1(U \cap V, x_0) \rightarrow \pi_1(V, x_0)$, $j_1 : \pi_1(U, x_0) \rightarrow \pi_1(X, x_0)$ and $j_2 : \pi_1(V, x_0) \rightarrow \pi_1(X, x_0)$ are homomorphisms induced by

inclusion mappings, then there exists a unique homomorphism $\Phi : \pi_1(X, x_0) \rightarrow H$ such that $\Phi \cdot j_1 = \phi_1$ and $\Phi \cdot j_2 = \phi_2$.

The classical form of the Seifert-Van Kampen theorem is by the following.

Theorem 4.3.9(Seifert and Van-Kampen theorem, Classical Version) *Let $X = U \cup V$ with U, V open subsets and let $X, U, V, U \cap V$ be non-empty arcwise-connected with $x_0 \in U \cap V$, inclusion mappings i_1, j_1, i_2, j_2 as the same in Theorem 4.3.7. If*

$$j : \pi_1(U, x_0) * \pi_1(V, x_0) \rightarrow \pi_1(X, x_0)$$

is an extension homomorphism of j_1 and j_2 , then j is an epimorphism with kernel $\text{Ker } j$ generated by $i_1^{-1}(g)i_2(g)$, $g \in \pi_1(U \cap V, x_0)$, i.e.,

$$\pi_1(X, x_0) \simeq \frac{\pi_1(U, x_0) * \pi_1(V, x_0)}{[i_1^{-1}(g) \cdot i_2(g) \mid g \in \pi_1(U \cap V, x_0)]},$$

where $[A]$ denotes the minimal normal subgroup of a group \mathcal{G} included $A \subset \mathcal{G}$.

A complete proof of the Seifert-Van Kampen theorem can be found in references, such as those of [Lee1] [Mas1] or [Mun1]. By this result, we immediately get the following conclusions.

Corollary 4.3.1 *Let X_1, X_2 be two open sets of a topological space X with $X = X_1 \cup X_2$, X_2 simply connected and X, X_1 and $X_0 = X_1 \cap X_2$ non-empty arcwise-connected, then for $\forall x_0 \in X_0$,*

$$\pi_1(X, x_0) \simeq \frac{\pi_1(X_1, x_0)}{[(i_1)_\pi([a]) \mid [a] \in \pi_1(X_0, x_0)]}.$$

Corollary 4.3.2 *Let X_1, X_2 be two open sets of a topological space X with $X = X_1 \cup X_2$. If there X, X_1, X_2 are non-empty arcwise-connected and $X_0 = X_1 \cap X_2$ simply connected, then for $\forall x_0 \in X_0$,*

$$\pi_1(X, x_0) \simeq \pi_1(X_1, x_0)\pi_1(X_2, x_0).$$

Corollary 4.3.2 can be applied to find the fundamental group of an embedded graph, particularly, a bouquet $B_n = \bigcup_{i=1}^n L_i$ consisting of n loops L_i , $1 \leq i \leq n$ again following, which is the same as in Theorem 4.3.6.

Let x_0 be the common point in B_n . For $n = 2$, let $U = B_2 - \{x_1\}$, $V = B_2 - \{x_2\}$, where $x_1 \in L_1$ and $x_2 \in L_2$. Then $U \cap V$ is simply connected. Applying Corollary 3.1.2, we get that

$$\pi_1(B_2, x_0) \simeq \pi_1(U, x_0)\pi_1(V, x_0) \simeq \langle L_1 \rangle \langle L_2 \rangle = \langle L_1, L_2 \rangle.$$

Generally, let $x_i \in L_i$, $W_i = L_i - \{x_i\}$ for $1 \leq i \leq n$ and

$$U = L_1 \bigcup W_2 \bigcup \cdots \bigcup W_n \text{ and } V = W_1 \bigcup L_2 \bigcup \cdots \bigcup L_n.$$

Then $U \cap V = S_{1,n}$, an arcwise-connected star. Whence,

$$\pi_1(B_n, O) = \pi_1(U, O) * \pi_1(V, O) \simeq \langle L_1 \rangle * \pi_1(B_{n-1}, O).$$

By induction induction, we finally find the fundamental group

$$\pi_1(B_n, O) = \langle L_i, 1 \leq i \leq n \rangle.$$

4.3.4 Fundamental Group of Surface. Applying the Seifert-Van Kampen theorem and the classification theorem of connected compact surfaces, we can easily get the fundamental groups following, usually called the *surface groups* in literature.

Theorem 4.3.10 *The fundamental groups $\pi_1(S)$ of compact surfaces S are respective*

$$\pi_1(S) = \begin{cases} \langle 1 \rangle, \text{ the trivial group} & \text{if } S \sim_{El} S^2; \\ \left\langle a_1, b_1, \dots, a_p, b_p \mid \prod_{i=1}^p a_i b_i a_i^{-1} b_i^{-1} = 1 \right\rangle & \text{if } S \sim_{El} \underbrace{T^2 \# T^2 \# \cdots \# T^2}_p; \\ \left\langle c_1, c_2, \dots, c_q \mid \prod_{i=1}^q c_i^2 = 1 \right\rangle & \text{if } S \sim_{El} \underbrace{P^2 \# P^2 \# \cdots \# P^2}_q, \end{cases}$$

Proof If $S \sim_{El} S^2$, then it is clearly that $\pi_1(S)$ is trivial. Whence, we consider S is elementary equivalent to the connected sum of p tori or q projective planes following.

Case 1. $S \sim_{El} \underbrace{T^2 \# T^2 \# \cdots \# T^2}_p$.

Let $\mathcal{S} = \left\langle a_1, b_1, \dots, a_p, b_p \mid \prod_{i=1}^p a_i b_i a_i^{-1} b_i^{-1} \right\rangle$ be the surface representation of S . By Theorem 4.2.2, we can represent \mathcal{S} by a $4p$ -gon on the plane with sides identified in pairs such as those shown in Fig.4.3.2(a). By the identification, these edges $a_1, b_1, a_2, b_2, \dots, a_p, b_p$ become circuits, and any two of them intersect only in the base point x_0 . Now let $U = \mathcal{S} \setminus \{y\}$, the complement of the center y and let V be the image of the interior of the $4p$ -gon under the identification. Then U, V both are arcwise-connected. Furthermore, the union of circuits $a_1, b_1, a_2, b_2, \dots, a_p, b_p$ is a deformation retract of U , and V is simply connected. Therefore,

$$\pi_1(V, x_1) = \langle 1 \mid \emptyset \rangle, \quad \pi_1(U, x_0) = \langle \alpha_1, \beta_1, \alpha_2, \beta_2, \dots, \alpha_p, \beta_p \mid \emptyset \rangle,$$

where $\alpha_1, \beta_1, \alpha_2, \beta_2, \dots, \alpha_p, \beta_p$ are circuits represented by $a_1, b_1, a_2, b_2, \dots, a_p, b_p$, respectively.

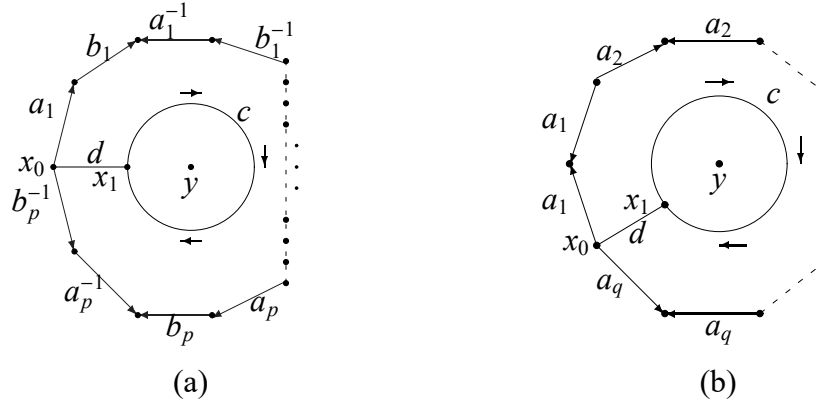

Fig.4.3.2

Notice that $U \cap V$ has the homotopy type of circuit. Whence, $\pi_1(U \cap V, x_1)$ is an infinite cyclic group generated γ , the equivalent class of a loop c around the point y once with

$$\phi_1(\gamma) = \prod_{i=1}^p \alpha'_i \beta'_i (\alpha'_i)^{-1} (\beta'_i)^{-1},$$

where $\alpha'_i = d^{-1} \alpha_i d, \beta'_i = d^{-1} \beta_i d$ for integers $1 \leq i \leq p$.

Applying Corollary 4.3.1, we immediately get that

$$\begin{aligned} \pi_1(S) &= \left\langle \alpha'_1, \beta'_1, \dots, \alpha'_p, \beta'_p \mid \prod_{i=1}^p \alpha'_i \beta'_i (\alpha'_i)^{-1} (\beta'_i)^{-1} = 1 \right\rangle \\ &\simeq \left\langle a_1, b_1, \dots, a_p, b_p \mid \prod_{i=1}^p a_i b_i a_i^{-1} b_i^{-1} = 1 \right\rangle. \end{aligned}$$

Case 2. $S \sim_{El} \underbrace{P^2 \# P^2 \# \dots \# P^2}_p$.

The proof is similar to that of Case 1. In this case, S is presented by identifying in pairs sides of a $2q$ -gon with sides $a_1, a_1, a_2, a_2, \dots, a_q, a_q$, such as those shown in Fig.4.3.2(b). Similarly choose U, V as them in Case 1. Then the union of circuits a_1, a_2, \dots, a_q is a deformation retract of U , and V is simply connected. Therefore,

$$\pi_1(V, x_1) = \langle 1 \mid \emptyset \rangle, \quad \pi_1(U, x_0) = \langle \alpha_1, \alpha_2, \dots, \alpha_q \mid \emptyset \rangle,$$

where $\alpha_1, \alpha_2, \dots, \alpha_q$ are circuits represented by a_1, a_2, \dots, a_q , respectively and $\pi_1(U \cap V, x_1)$ is an infinite cyclic group generated γ , the equivalent class of a loop c around the

point y once with

$$\phi_1(\gamma) = \prod_{i=1}^q (\alpha'_i)^2,$$

where $\alpha'_i = d^{-1}\alpha_i d$ for integers $1 \leq i \leq q$. Whence,

$$\begin{aligned} \pi_1(S) &= \left\langle \alpha_1, \alpha_2, \dots, \alpha_q \mid \prod_{i=1}^q (\alpha_i)^2 = 1 \right\rangle \\ &\simeq \left\langle c_1, c_2, \dots, c_q \mid \prod_{i=1}^q c_i^2 = 1 \right\rangle \end{aligned}$$

by applying Corollary 4.3.1. □

Corollary 4.3.3 *The fundamental groups of the torus T^2 and projective plane P^2 are $\pi_1(T^2) = \langle a, b \mid ab = ba \rangle$ and $\pi_1(P^2) = \langle a \mid a^2 = 1 \rangle$, respectively.*

§4.4 NEC GROUPS

We show how to construct a polygon used in last section on a Klein surface, i.e., fundamental region of a non-Euclidean crystallographic group, abbreviated to NEC group in this section. Thus will be used in next chapter.

4.4.1 Dianalytic Function. Let \mathbb{C} be the complex plane, $A \subset \mathbb{C}$ a open subset and $f : A \rightarrow \mathbb{C}$ a mapping. As usual, we write $z = x + iy \in \mathbb{C}$, $x, y \in \mathbb{R}$, $i = \sqrt{-1}$, $\bar{z} = x - iy$ and $f(z) = u(x, y) + iv(x, y)$ for certain functions $u, v : A \rightarrow \mathbb{R}$ of C^2 . Then by definition, we know that

$$\begin{aligned} \frac{\partial f}{\partial z} &= \frac{\partial u}{\partial z} + i \frac{\partial v}{\partial z} = \frac{\partial u}{\partial x} \frac{\partial x}{\partial z} + i \frac{\partial u}{\partial y} \frac{\partial y}{\partial z} + i \left(\frac{\partial v}{\partial x} \frac{\partial x}{\partial z} + i \frac{\partial v}{\partial y} \frac{\partial y}{\partial z} \right), \\ \frac{\partial f}{\partial \bar{z}} &= \frac{\partial u}{\partial \bar{z}} + i \frac{\partial v}{\partial \bar{z}} = \frac{\partial u}{\partial x} \frac{\partial x}{\partial \bar{z}} + i \frac{\partial u}{\partial y} \frac{\partial y}{\partial \bar{z}} + i \left(\frac{\partial v}{\partial x} \frac{\partial x}{\partial \bar{z}} + i \frac{\partial v}{\partial y} \frac{\partial y}{\partial \bar{z}} \right). \end{aligned}$$

Notice that $x = \frac{z + \bar{z}}{2}$ and $y = \frac{i(\bar{z} - z)}{2}$, we know that

$$\frac{\partial x}{\partial z} = \frac{\partial x}{\partial \bar{z}} = \frac{1}{2}, \quad \frac{\partial y}{\partial z} = -\frac{1}{2}i \quad \text{and} \quad \frac{\partial y}{\partial \bar{z}} = \frac{1}{2}i.$$

Whence,

$$\frac{\partial f}{\partial z} = \frac{1}{2} \left(\frac{\partial u}{\partial x} - i \frac{\partial u}{\partial y} + i \frac{\partial v}{\partial x} + \frac{\partial v}{\partial y} \right) \quad \text{and} \quad \frac{\partial f}{\partial \bar{z}} = \frac{1}{2} \left(\frac{\partial u}{\partial x} + i \frac{\partial u}{\partial y} + i \frac{\partial v}{\partial x} - \frac{\partial v}{\partial y} \right).$$

Particularly, let $\bar{f} : A \rightarrow \mathbb{C}$ be determined by $\bar{f} : z = x + iy \rightarrow \overline{f(z)} = u(x, y) - iv(x, y)$. Then we get the fundamental equalities following:

$$\frac{\partial \bar{f}}{\partial \bar{z}} = \overline{\left(\frac{\partial f}{\partial z} \right)}, \quad \frac{\partial \bar{f}}{\partial z} = \overline{\left(\frac{\partial f}{\partial \bar{z}} \right)}. \quad (4-1)$$

Let $\mathbb{C}^+ = \{ z \mid \text{Im}z \geq 0 \}$. A mapping $f : A \rightarrow \mathbb{C}$ (or \mathbb{C}^+) is called to be *analytic* on A if $\frac{\partial f}{\partial \bar{z}} = 0$ (*Cauchy-Riemann equation*) and *antianalytic* on A if $\frac{\partial f}{\partial z} = 0$. A mapping $f : A \rightarrow \mathbb{C}$ (or \mathbb{C}^+) is *dianalytic* if its restriction to every connected component of A is analytic or antianalytic. The following properties of dianalytic mappings is clearly by formulae (4-1) and definition.

(P1) *A mapping $f : A \rightarrow \mathbb{C}$ (or \mathbb{C}^+) is analytic if and only if \bar{f} is antianalytic;*

(P2) *If a mapping $f : A \rightarrow \mathbb{C}$ (or \mathbb{C}^+) is both analytic and antianalytic, then f is constant;*

(P3) *If $f : A \rightarrow B \subset \mathbb{C}$ (or \mathbb{C}^+) and $g : B \rightarrow \mathbb{C}$ (or \mathbb{C}^+) are both analytic or antianalytic, then the composition $g \circ f : A \rightarrow \mathbb{C}$ (or \mathbb{C}^+) is analytic. Otherwise, $g \circ f$ is antianalytic.*

Example 4.4.1 Let $a, b, c, d \in \mathbb{R}$, $c \neq 0$ and $A = \mathbb{C} \setminus \{-d/c\}$. Clearly, the mapping $f : A \rightarrow \mathbb{C}$ determined by $f(z) = \frac{az + b}{cz + d}$ for $\forall z \in A$ is analytic. Whence, the mapping $\bar{f} : A \rightarrow \mathbb{C}$ determined by $\bar{f}(z) = \frac{a\bar{z} + b}{c\bar{z} + d}$ for $\forall z \in A$ is antianalytic by (P1).

Let $f(z) = u(x, y) + iv(x, y)$. Calculation shows that

$$\det \begin{pmatrix} \frac{\partial u}{\partial x} & \frac{\partial u}{\partial y} \\ \frac{\partial v}{\partial x} & \frac{\partial v}{\partial y} \end{pmatrix} = \epsilon \left[\left(\frac{\partial u}{\partial x} \right)^2 + \left(\frac{\partial v}{\partial y} \right)^2 \right],$$

where $\epsilon = 1$ if f is analytic and -1 if f is antianalytic. This fact implies that an analytic function preserves orientation but that an antianalytic one reverses the orientation.

4.4.2 Klein Surface. A *Klein surface* is a topological surface S together with a family $\Sigma = \{ (U_i, \phi_i) \mid i \in \Lambda \}$ such that

- (1) $\{ U_i \mid i \in \Lambda \}$ is an open cover of S ;
- (2) $\phi_i : U_i \rightarrow A_i$ is a homeomorphism onto an open subset A_i of \mathbb{C} or \mathbb{C}^+ ;
- (3) the *transition functions* of Σ defined in the following are dianalytic:

$$\phi_{ij} = \phi_i \phi_j^{-1} : \phi_j(U_i \cap U_j) \rightarrow \phi_i(U_i \cap U_j), \quad i, j \in \Lambda.$$

Usually, the family Σ is called to be an *atlas* and each (U_i, ϕ_i) a *chart* on S , which is *positive* if $\phi_i(U_i) \subset \mathbb{C}^+$. The *boundary* of S is determined by

$$\partial S = \{x \in S \mid \text{there exists } i \in I, x \in U_i, \phi_i(x) \in \mathbb{R} \text{ and } \phi_i(U_i) \subseteq \mathbb{C}^+\}.$$

Particularly, if each transition function ϕ_{ij} is analytic, such a Klein surface is called a *Riemann surface* in literature. Denote respectively by $k(S)$, $g(S)$ and $\chi(S)$ the number of connected components of ∂S , the genus and the Euler characteristic of S , where if $\partial S \neq \emptyset$, we define its genus $g(S)$ to be the genus of the compact surface obtained by attaching a 2-dimensional disc \overline{B}^2 to each boundary component of S . Then by applying Theorem 4.2.6, we know the following result.

Theorem 4.4.1 *Let S be a Klein surface. Then*

$$\chi(S) = \begin{cases} 2 - 2g(S) - k(S) & \text{if } S \text{ is orientable,} \\ 2 - g(S) - k(S) & \text{if } S \text{ is non-orientable.} \end{cases}$$

Proof Let \tilde{S} be a surface without boundary, i.e., $\partial \tilde{S} = \emptyset$ with a definite triangulation. We remove the interior of one triangle T to form a new surface S' . Clearly, $V(S') = V(S)$, $E(S') = E(S)$ and $F(S') = F(S) \setminus \{T\}$. Whence, $\chi(S') = \chi(S) - 1$. Continuous this process, we finally get that $\chi(S') = \chi(S) - k$ if we remove k triangles on \tilde{S} . Then we know the result by Theorem 4.2.6. □

Some important examples of Klein surfaces are shown in the following.

Example 4.4.2 Let $H = \{z \in \mathbb{C} \mid \text{Im}z > 0\}$ and $D = \{z \in \mathbb{C} \mid |z| < 1\}$ be respectively the upper half plane and the unit disc in \mathbb{C} shown in Fig.4.4.1 following.

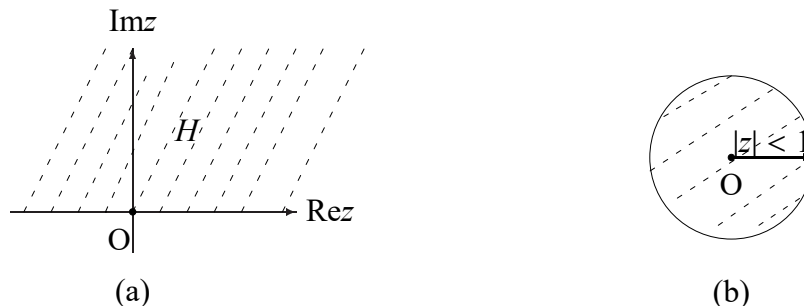

Fig.4.4.1

Choose atlas $\{(U = H, \phi = 1_H)\}$ and $\{(U = D, \phi = 1_D)\}$ on H and D , respectively. Then

we know that both of them are Klein surfaces without boundary. Such Klein surfaces will be always denoted by H and D in this book.

Example 4.4.3 The surface \mathbb{C}^+ with a structure induced by the analytic atlas $\{(\mathbb{C}, 1_{\mathbb{C}})\}$ is a Klein surface with boundary $\partial\mathbb{C}^+ = \mathbb{R}$.

Example 4.4.4 Let $\overline{\mathbb{C}} = \mathbb{C} \cup \{\infty\}$ and $\Delta = \mathbb{C}^+ \cup \{\infty\}$. Then they are compact Klein surfaces with atlas

$$\Sigma_1 = \{(U_1 = \mathbb{C}, \phi_1 = 1_{\mathbb{C}}), (U_2 = \overline{\mathbb{C}} \setminus \{0\}, \phi_2 = z^{-1})\},$$

$$\Sigma_2 = \{(U_1 = \mathbb{C}^+, \phi_1 = 1_{\mathbb{C}^+}), (U_2 = \Delta \setminus \{0\}, \phi_2 = \bar{z}^{-1})\},$$

respectively. Clearly, $\partial\overline{\mathbb{C}} = \emptyset$ and $\partial\Delta = \mathbb{R} \cup \{\infty\}$.

4.4.3 Morphism of Klein Surface. Let A be a subset of \mathbb{C}^+ , define $\overline{A} = \{z \in \mathbb{C} \mid \bar{z} \in A\}$. A *folding mapping* is the continuous mapping $\Phi : \mathbb{C} \rightarrow \mathbb{C}^+$ determined by $\Phi(x + iy) = x + i|y|$. Clearly, Φ is an open mapping and $\Phi^{-1}(A) = A \cup \overline{A}$. Particularly, $\Phi^{-1}(\mathbb{R}) = \mathbb{R}$.

Let S and S' be Klein surfaces. A *morphism* $f : S \rightarrow S'$ from S to S' is a continuous mapping such that

$$(1) f(\partial S) \subseteq \partial S';$$

(2) for $\forall s \in S$, there exist charts (U, ϕ) and (V, ψ) at points s and $f(s)$, respectively and an analytic function $F : \phi(U) \rightarrow \mathbb{C}$ such that the following diagram

$$\begin{array}{ccc} U & \xrightarrow{f} & V \\ \downarrow \phi & & \downarrow \psi \\ \phi(U) & \xrightarrow{F} \mathbb{C} \xrightarrow{\Phi} & \mathbb{C}^+ \end{array} \quad (4-2)$$

commutes. It should be noted that in the case of Riemann surfaces, we only deal with orientation-preserving morphisms, in which the diagram (4-2) is replaced by the diagram (4-3) following.

$$\begin{array}{ccc} U & \xrightarrow{f} & V \\ \downarrow \phi & & \downarrow \psi \\ \phi(U) & \xrightarrow{F} & \psi(V) \end{array} \quad (4-3)$$

Let S and S' be Klein surfaces and $f : S \rightarrow S'$ a morphism. If f is a homeomorphism, then S and S' are called to be *isomorphic*. Such a morphism f is *isomorphism* between S and S' . Particularly, if $S = S'$, such a f is called *automorphism* of a Klein surface S . Similarly, all automorphisms of S form a group with respect to the composition of automorphisms, denoted by $\text{Aut}S$. We present an example of automorphisms between Klein surfaces following.

Example 4.4.5 Let H and D be Klein surfaces constructed in Example 4.4.2 and a mapping by $\rho(z) = (z + i)/(iz + 1)$. Then $\rho : D \rightarrow H$ is well-def ned because if $z = x + iy \in D$, so there must be $x^2 + y^2 < 1$ and consequently

$$\rho(z) = \frac{2x + i(1 - x^2 - y^2)}{x^2 + (1 - y)^2} \in H.$$

Furthermore, it is analytic, particularly continuous by definition. For $s \in D$, we choose $(U = D, 1_D)$ and $(V = H, 1_H)$ to be charts at $s \in D$ and $\rho(s) \in H$, respectively. Then $\Phi\rho = \rho$ for $\rho(D) \subset H \subset \mathbb{C}^+$ and the following diagram is commute.

$$\begin{array}{ccc} U & \xrightarrow{\rho} & V \\ \downarrow 1_U & & \downarrow 1_V \\ \phi(U) & \xrightarrow{F = \rho} \mathbb{C} & \xrightarrow{\Phi} \mathbb{C}^+ \end{array}$$

Whence, ρ is a morphism between from Klein surfaces D to H . Now if $g : H \rightarrow \mathbb{C}$ is def ned by $g(z) = \frac{z - i}{1 - iz}$, then $g \circ \rho = 1_H$. Because ρ is onto, $\text{Im}g \subset D$ and $\rho g = 1_H$, we know that ρ is an isomorphism of Klein surfaces.

4.4.4 Planar Klein Surface. Let $H = \{ z \in \mathbb{C} \mid \text{Im}z > 0 \}$ be a planar Klein surface def ned in Example 4.4.2 and let $\text{PGL}(n, \mathbb{C})$ be the subgroup of $\text{GL}(n, \mathbb{R})$ determined by all $A \in \text{GL}(n, \mathbb{R})$ with $\text{Det}A \neq 0$. Now for $A = \begin{pmatrix} a & b \\ c & d \end{pmatrix} \in \text{PGL}(2, \mathbb{R})$ with real entries, we associate a mapping $f_A : H \rightarrow H$ determined by

$$f_A(z) = \begin{cases} \frac{az + b}{c\bar{z} + d} & \text{if } \text{Det}A > 0, \\ \frac{a\bar{z} + b}{c\bar{z} + d} & \text{if } \text{Det}A < 0. \end{cases}$$

Clearly, $f_A \in \text{Aut}H$ and $f_A = f_{cA}$ for any non-zero $c \in \mathbb{R}$. Hence, the mapping $A \rightarrow f_A$ embeds $\text{PGL}(2, \mathbb{R})$ in $\text{Aut}H$. We prove this mapping is also surjective. In fact, let $f \in$

$\text{Aut}H$ and let $\rho : D \rightarrow H$ be the isomorphism determined in Example 4.4.5. Notice that f is analytic, and so the same holds true for $g = \rho^{-1} \circ f \circ \rho$. Applying the maximum principle of analytic function, $g(z) = \frac{z - \alpha}{1 - \bar{\alpha}z}$ for some $\alpha \in D$, $\mu \in \mathbb{C}$ with $|\mu| = 1$. Hence,

$$f(z) = \frac{az + b}{cz + d} \quad \text{for some } a, b, c, d \in \mathbb{C}.$$

Because $f(H) = H$, we know that $f(\mathbb{R} \setminus \{-d/c\}) \subset \mathbb{R}$ by continuity, and it is easy to see that we can choose real numbers a, b, c, d . Notice that $f(i) \in H$ implies that $\text{Det}A = ad - bc > 0$.

If f reverses the orientation, let $h : H \rightarrow H$ be a mapping determined by $h(z) = \overline{-f(z)}$. Notice that h is an automorphism of H , i.e., $h \in \text{Aut}H$ and it preserves the orientation. We know that

$$f(z) = \frac{a\bar{z} + b}{c\bar{z} + d} \quad \text{for some } a, b, c, d \in \mathbb{R} \quad \text{with } \text{Det}A = ad - bc < 0.$$

Whence, we get the following result for the automorphism group of H .

Theorem 4.4.2 *Let $H = \{z \in \mathbb{C} \mid \text{Im}z > 0\}$. Then*

- (1) $\text{Aut}H = \text{PGL}(2, \mathbb{R})$;
- (2) $\text{Aut}H$ is a topological group, i.e., $\text{Aut}H$ is both a topological space and a group with a continuous mapping $\forall f \circ g^{-1}$ for $f, g \in \text{Aut}H$.

4.4.5 NEC Group. A subgroup Γ of $\text{Aut}H$ is said to be *discrete* if it is discrete as a topological subspace of $\text{Aut}H$. Such a discrete group Γ is called to be a *non-Euclidean crystallographic group* (shortly NEC group) if the quotient space H/Γ is compact.

Notice that there exist just two matrixes $A, B \in \text{GL}(2, \mathbb{R})$ such that f_A, f_B for any $f \in \text{Aut}H$ with $|\text{Det}A| = |\text{Det}B| = 1$, i.e., $B = -A$, $\text{Det}A = -\text{Det}A$ and $\text{Tr}B = -\text{Tr}A$. Define $\text{Det}f = \text{Det}A$ and $\text{Tr}f = \text{Tr}A$, respectively. Then we classify $f \in \text{Aut}H$ into 3 classes with conditions following:

Hyperbolic. $\text{Det}f = 1$ and $|\text{Tr}f| > 2$.

Elliptic. $\text{Det}f = 1$ and $|\text{Tr}f| < 2$.

Parabolic. $\text{Det}f = 1$ and $|\text{Tr}f| = 2$.

Furthermore, f is called a *glide reflection* if $\text{Det}f = -1$, $|\text{Tr}f| \neq 0$ or a *reflection* if $\text{Det}f = -1$, $|\text{Tr}f| = 0$. Denote by Aut^+H the subgroup of $\text{Aut}H$ formed by all orientation preserving elements in $\text{Aut}H$. Then it is clear that $[\text{Aut}H : \text{Aut}^+H] = 2$. Call

an NEC group Γ to be *Fuchsian* if $\Gamma \leq \text{Aut}^+H$. Otherwise, a *proper* NEC group. For any NEC group Γ , the subgroup $\Gamma^+ = \Gamma \cap \text{Aut}^+H$ is always a Fuchsian group, called the *canonical Fuchsian subgroup*.

Calculation shows the following result is hold.

Theorem 4.4.3 *Extend each $f_A \in \text{Aut}H$ to \tilde{f} on $\mathbb{C} \cup \{\infty\}$ in the natural way for $A = \begin{pmatrix} a & b \\ c & d \end{pmatrix} \in \text{PGL}(2, \mathbb{R})$ by*

$$\tilde{f}_A(z) = \begin{cases} -d/c & \text{if } z = \infty, \\ \infty & \text{if } z = -d/c, \\ \frac{az+b}{cz+d} & \text{if } \text{Det}f_A = 1, z \neq \infty, -d/c, \\ \frac{a\bar{z}+b}{\bar{c}z+d} & \text{if } \text{Det}f_A = -1, z \neq \infty, -d/c. \end{cases}$$

Let $f \in \text{Aut}H$ and $\text{Fix}f = \{z \in \mathbb{C} \cup \{\infty\} | \tilde{f}(z) = z\}$. Then

$$\text{Fix}f = \begin{cases} \text{two points on } \mathbb{R} \cup \{\infty\} & \text{if } f \text{ is hyperbolic or glide reflection,} \\ \text{one point on } \mathbb{R} \cup \{\infty\} & \text{if } f \text{ is parabolic,} \\ \text{two non-real conjugate points} & \text{if } f \text{ is elliptic,} \\ \text{a circle or a line perpendicular to } \mathbb{R} & \text{if } f \text{ is a reflection.} \end{cases}$$

Let Γ be an NEC group. A *fundamental region* for Γ is a closed subset F of H satisfying conditions following:

- (1) If $z \in H$, then there exists $g \in \Gamma$ such that $g(z) \in F$;
- (2) If $z \in H$ and $f, g \in \Gamma$ verify $f(z), g(z) \in \text{Int}F$, then $f = g$;
- (3) The non-Euclidean area of $F \setminus \text{Int}F$ is zero, i.e.,

$$\mu(F \setminus \text{Int}F) = \int \int_{F \setminus \text{Int}F} \frac{dx dy}{y^2} = 0.$$

The existence of fundamental region for an NEC group can be seen by the following construction for the *Dirichlet region* with center p .

Construction 4.4.1 Let Γ be an NEC group. We construct its fundamental region in the following. First, we show that there exists a point $p \in H$ such that $g(p) \neq p$ for $1_\Gamma \neq g \in \Gamma$. In fact, we can assume the existence of an upper half Euclidean line l perpendicular to \mathbb{R} such that $l \neq \text{Fix}(\gamma)$ for every $\gamma \in \Gamma$. Otherwise, we can get a sequence $\{x_n | n \in \mathbb{N}\}$

convergent to a point $a \in H$, lying on a Euclidean line parallel to \mathbb{R} , and the upper half Euclidean line l_n perpendicular to \mathbb{R} and passing through x_n verifies $l_n = \text{Fix}(\gamma_n)$ for some $\gamma_n \in \Gamma$. Consequently, $\gamma_n \neq \gamma_m$ if $n \neq m$ and $\lim\{\gamma_n(a)\} = \lim\{\gamma_n(x_n)\} = \lim\{x_n\} = a$, contradicts to the continuity of the mapping $o : \text{Aut}H \times H \rightarrow H$ determined by $o(f, x) = f(x)$ for $f \in \text{Aut}H, x \in H$.

Choose a sequence $\{y_n | n \in \mathbb{N}\}$ of points H lying on l convergent to some point $b \in H$. By assumption, there exists a sequence of pairwise distinct transformations $\{g_n | n \in \mathbb{N}\} \subset \Gamma$ such that $g_n(y_n) = y_n$ for every $n \in \mathbb{N}$, which leads to a contradiction as before.

Now it is easy to check that

$$F = F_p = \{z \in H | d(z, p) \leq d(g(z), p) \text{ for each } g \in \Gamma\}$$

is a fundamental region of Γ , where $d(u, v)$ is the non-Euclidean distance between u and v , i.e.,

$$d(u, v) = \int_{C_{u,v}} \frac{(dx^2 + dy^2)^{1/2}}{y},$$

$C_{u,v}$ being the geodesic joining u and v , i.e., a circle or a line orthogonal to \mathbb{R} . Then F_p verifies conditions (1)-(3):

(1) Let z be a point in H . Since Γ is discrete, the orbit O_z of z under Γ is closed. Thus there exists $w \in O_z$ such that $d(w, p) \leq d(w', p)$ for each $w' \in O_z$. If $w = g(z)$, $g \in \Gamma$, then it is clear that $g(z) = w \in F_p$.

(2) Obviously that

$$\text{Int}F_p = \{z \in H | d(z, p) < d(g(z), p), \text{ for each } g \in \Gamma \setminus \{1_H\}\}.$$

Then $z \in H, f, g \in \Gamma$ and $f(z), g(z) \in \text{Int}F_p$ imply that for $f \neq g$,

$$d(f(z), p) < d(gf^{-1}(f(z), p)) = d(g(z), p), \quad d(g(z), p) < d(fg^{-1}(g(z), p)) = d(f(z), p),$$

a contradiction. Thus, $f = g$.

(3) This follows easily from the fact that the boundary of F_p is a convex polygon with a finite number of sides in the non-Euclidean metric.

Usually, a fundamental region F of an NEC group verifying conditions following is called *regular*:

(1) F is a bounded convex polygon with a finite number of sides in the non-Euclidean metric;

(2) F is homeomorphic to a closed disc;

(3) $F \setminus \text{Int}F$ is a closed Jordan curve and there are finite vertices on $F \setminus \text{Int}F$ which divide it into the following classes e of Jordan arcs:

(3.1) $e = F \cap gF$, where $g \in \Gamma$ is a reflection;

(3.2) $e = F \cap gF$, where $g \in \Gamma, g^2 \neq 1_H$;

(3.3) e for which there exists an elliptic transformation $g \in \Gamma, g^2 = 1_\Gamma$ such that $e \cup ge = F \cap gF$;

(4) If F, gF do not have an edge in common for a $g \in \Gamma$, then $F \cap gF$ has just one point.

Then we know the following conclusion.

Theorem 4.4.4 *For any NEC group Γ , there exist regular fundamental regions, such as F_p for example.*

Construction 4.4.2 Let F be a regular fundamental region of an NEC group Γ . For a given $g \in \Gamma$, gF is said to be a *face*. Clearly, the mapping $\Gamma \rightarrow \{\text{faces}\}$ determined by $g \rightarrow gF$ is a bijection and $H = \bigcup_{g \in \Gamma} gF$. In fact, $\{gF | g \in \Gamma\}$ is a tessellation of H .

(1) Given a side e of F , let g_e be the unique transformation for which $g_e F$ meets F in the edge e , i.e., $e = F \cap g_e F$. then $\{g_e | e \in \text{sides of } F\}$ is a set of generators of Γ . In fact, for $\forall g \in \Gamma$ there exists a sequence of elements $g_1 = 1_H, g_2, \dots, g_{n+1}$ in Γ such that $g_i F$ meet $g_{i+1} F$ one to another in a side, say $g_i(e_i)$, where e_i is a side of F . Clearly, $g_i(g_{e_i} f) = g_{i+1} F$ and so $g_{i+1} = g_i g_{e_i}$ for $1 \leq i \leq n$. Consequently, $g = g_{e_1} g_{e_2} \dots g_{e_n}$ for some sides e_1, e_2, \dots, e_n of F .

(2) First, we label sides of type (3.1). Afterward, if we label e a side of type (3.2) or (3.3), the side ge is labeled e' if $g \in \Gamma^+$, and e^* if $g \in \Gamma \setminus \Gamma^+$. We write down the labels of the sides in counter-clockwise order and say (e, e') , (e, e^*) pair sides. In this way, we obtain the surface symbols, which enables one to determine the presentation of Γ and the topological structure H/Γ , such as those claimed in Theorem 4.2.2.

(3) Let a and \widehat{a} be pair sides and let $g \in \Gamma$ be an element such that $g^{-1}(a) = \widehat{a}$. For a hyperbolic arc f joining two vertices of F and splitting F into two regions A and B containing a and \widehat{a} , respectively, $A \cup gB$ is a new fundamental region of Γ which has a new pair sides b and \widehat{b} with $\widehat{b} = g^{-1}(b)$ instead of a and \widehat{a} and suitably relabeled other sides. Repeating this procedure in suitable way one can arrive to a fundamental region with the

following side labelings

$$\xi_1 \xi'_1 \cdots \xi_r \xi'_r \varepsilon \varepsilon_1 \gamma_{10} \cdots \gamma_{1s_1} \varepsilon'_1 \cdots \varepsilon_k \gamma_{k0} \cdots \gamma_{ks_k} \varepsilon'_k \alpha_1 \beta_1 \alpha'_1 \beta'_1 \cdots \alpha_p \beta_p \alpha'_p \beta'_p \quad (4-4)$$

$$\xi_1 \xi'_1 \cdots \xi_r \xi'_r \varepsilon \varepsilon_1 \gamma_{10} \cdots \gamma_{1s_1} \varepsilon'_1 \cdots \varepsilon_k \gamma_{k0} \cdots \gamma_{ks_k} \varepsilon'_k \delta_1 \delta'_1 \cdots \delta_q \delta'_q \quad (4-5)$$

according to H/Γ orientable or not.

(4) Identify points on pair side, we get that H/Γ is a sphere with k disc removed and p handles or q crosscaps added if (4-3) or (4-4) holds.

(5) For getting the defining relations for Γ , consider the faces meeting at each vertex of F . Notice that Γ is discrete. The number of these faces is finite. Choose one of vertices of Γ and let $l = L_0, L_1, \dots, L_n, L_{n+1} = L$ be the corresponding chain faces. Obviously, there exist g_1, \dots, g_n of elements of Γ such that

$$L_1 = g_1 L, L_2 = g_2 g_1 L, \dots, L = L_{n+1} = g_n \cdots g_1 L.$$

Whence, every vertex induces a relation

$$g_n g_{n-1} \cdots g_2 g_1 = 1_H.$$

It turns out that these relations of this type and $g_e^2 = 1_H$ coming from such sides of F fixed by a unique nontrivial element $g_e \in \Gamma$ form all defining relations of Γ .

(6) As we get a surface symbol (4-4) or (4-5) and using procedures described in (1) and (5), we find the presentation of Γ following:

Generators:

$$\begin{aligned} x_i, & \quad 1 \leq i \leq r; \\ e_i, & \quad 1 \leq i \leq k; \\ c_{ij}, & \quad 1 \leq i \leq k, 1 \leq j \leq s_i; \\ a_i, b_i, & \quad 1 \leq i \leq p \text{ in the case (4-4);} \\ d_i, & \quad 1 \leq i \leq q \text{ in the case (4-5).} \end{aligned}$$

Relations:

$$\begin{aligned} x_i^{m-i} &= 1_\Gamma, \quad 1 \leq i \leq r; \\ e_i^{-1} c_{i0} e_i c_{is_i} &= 1_\Gamma, \quad 1 \leq i \leq k; \\ c_{i,j-1}^2 = c_{ij}^2 &= (c_{i,j-1} c_{ij})^{n_{ij}} = 1; \\ x_1 \cdots x_r e_1 \cdots e_k [a_1, b_1] \cdots [a_p, b_p] &= 1 \text{ in case (4-4);} \\ x_1 \cdots x_r e_1 \cdots e_k d_1^2 \cdots d_q^2 &= 1 \text{ in case (4-5),} \end{aligned}$$

where a, b, c, d, e, x correspond to these transformations induced by edges $\alpha, \beta, \gamma, \delta, \varepsilon, \xi$, $[a_i, b_i] = a_i b_i a_i^{-1} b_i^{-1}$ and m_i, n_j are numbers of faces meeting F at common vertices for sides (ξ_i, ξ'_i) and $(\gamma_{i,j-1}, \gamma_{ij})$, respectively.

For an NEC group Γ with the previous presentation, we define the *signature* $\sigma(\Gamma)$ of Γ by

$$\sigma(\Gamma) = (g; \pm; [m_1, \dots, m_r]; \{(n_{11}, \dots, n_{1s_1}), \dots, (n_{k1}, \dots, n_{ks_k})\}),$$

and its *hyperbolic area* $\mu(\Gamma)$ by

$$\mu(\Gamma) = \left[\alpha g + k - 2 + \sum_{i=1}^r \left(1 - \frac{1}{m_i}\right) + \frac{1}{2} \sum_{i=1}^k \sum_{j=1}^{s_i} \left(1 - \frac{1}{n_{ij}}\right) \right],$$

where $g = p$, the sign $+$ and $\alpha = 2$ in (4-4) or $g = q$, the sign $-$ and $\alpha = 1$ in (4-5), i.e., orientable in the first and non-orientable otherwise. It has been shown that $\mu(\Gamma)$ is just the hyperbolic area of the fundamental of Γ and independent on its choice.

Usually, if $r = 0, s_i = 0$ or $k = 0$, we denote these $[m_1, \dots, m_r], (n_{i1}, \dots, n_{is_i})$ by $[-], (-)$ or $\{-\}$, respectively. For example,

$$\sigma(\Gamma) = (g; \pm; [-]; \underbrace{\{(-), \dots, (-)\}}_k)$$

if $r = 0$ and $s_i = 0$. Such an NEC group is called to be a *surface group*. Particularly, if $k = 0$, i.e., these fundamental groups in Theorem 4.3.10, the signature is $\sigma(\Gamma) = (g; \pm; [-]; (-))$. Clearly, the area of a surface group Γ is $\mu(\Gamma) = 2\pi(\alpha g + k - 2)$.

Theorem 4.4.5(Hurwitz-Riemann formula) *Let Γ be a NEC subgroup of a NEC group Γ' . Then*

$$\frac{\mu(\Gamma)}{\mu(\Gamma')} = [\Gamma' : \Gamma].$$

Proof Notice that Γ is a discrete as a subgroup of Γ' . By definition, H/Γ' and H/Γ are compact, so Γ' and Γ have compact fundamental regions F' and F . Let $h_1, \dots, h_k \in \Gamma'$ be the coset representatives of Γ , where $k = [\Gamma' : \Gamma]$. Then It is easily to know that $F = h_1(F') \cup \dots \cup h_k(F')$. Consequently,

$$\mu(\Gamma) = \text{area}(F) = \sum_{i=1}^k \text{area}(h_i(F')) = k \times \text{area}(F') = k \times \mu(\Gamma').$$

Thus,

$$\frac{\mu(\Gamma)}{\mu(\Gamma')} = [\Gamma' : \Gamma]. \quad \square$$

§4.5 AUTOMORPHISMS OF KLEIN SURFACES

4.5.1 Morphism Property. We prove the automorphism group of a Klein surface is finite in this section. For this objective, we need to characterize morphisms of Klein surfaces in the first.

Theorem 4.5.1 *Let $f : S \rightarrow S'$ be a non-constant morphism and (U, ϕ) , (V, ψ) two charts in S and S' with $f(U) \subset V$, $\psi(V) \subset \mathbb{C}^+$. Then there exists a unique analytic mapping $F : \phi(U) \rightarrow \mathbb{C}$ such that the following diagram*

$$\begin{array}{ccc}
 U & \xrightarrow{f} & V \\
 \downarrow \phi & & \downarrow \psi \\
 \phi(U) & \xrightarrow{F} \mathbb{C} \xrightarrow{\Phi} & \psi(V)
 \end{array}$$

commutes.

Proof First, if there are two non-constant analytic mappings $F, F' : \phi(U) \rightarrow \mathbb{C}$ such that $\Phi F = \Phi F'$, then $F = F'$ or $F = \overline{F'}$. Let $Y \subset F^{-1}(\mathbb{C} \setminus \mathbb{R})$ be a nonempty connected set. Choose $M_1 = \{x \in Y | F(x) = F'(x)\}$ and $M_2 = \{x \in Y | F(x) = \overline{F'(x)}\}$. Then M_1 and M_2 are closed and disjoint with $Y = M_1 \cup M_2$, which enables one to get $M_1 = Y$ or $M_2 = Y$. If $M_2 = Y$, F must be both analytic and antianalytic on Y . Thus $F|_Y$ is constant, and so F is constant by the properties of analytic functions, a contradiction. Whence, $F = F'$.

Now suppose that we can cover U by $\{U_j | j \in J\}$ such that there are analytic mappings $F_j : \phi(U_j) \rightarrow \mathbb{C}$ with the following diagram

$$\begin{array}{ccc}
 U & \xrightarrow{f} & V \\
 \downarrow \phi & & \downarrow \psi \\
 \phi(U) & \xrightarrow{F_j} \mathbb{C} \xrightarrow{\Phi} & \psi(V)
 \end{array}$$

commutes. Then these mappings F_j glue together will produce a function F that we are looking for. So we only need to find such mappings F_j .

By definition, for $x \in U$ and $y = f(x) \in V$, there exist charts (U^x, ϕ_x) and (V^y, ψ_y) and an analytic mapping F_x with $U^x \subset U$, $V^y \subset V$ such that the following diagram commutes:

$$\begin{array}{ccc}
 U^x & \xrightarrow{f} & V^y \\
 \downarrow \phi_x & & \downarrow \psi_y \\
 \phi_x(U^x) & \xrightarrow{F_x} & \mathbb{C} \xrightarrow{\Phi} \psi_y(V^y)
 \end{array}$$

We construct a mapping F_x^* such that the following diagram also commutes:

$$\begin{array}{ccc}
 U^x & \xrightarrow{f} & V^y \\
 \downarrow \phi_x & & \downarrow \psi_y \\
 \phi_x(U^x) & \xrightarrow{F_x^*} & \mathbb{C} \xrightarrow{\Phi} \psi_y(V^y)
 \end{array}$$

In fact, for any given $u \in \phi(U^x)$, we know that $F_x \phi_x \phi^{-1}(u) \in \Phi^{-1}(\text{Im} \psi_y) = \psi_y(V^y) \cup \overline{\psi_y(V^y)}$. Consider $(\psi \psi_y^{-1})^\wedge : \psi_y(V^y) \cup \overline{\psi_y(V^y)} \rightarrow \mathbb{C}$. Then according with $\phi_x \phi^{-1}$ and $\psi \psi_y^{-1}$ were analytic or antianalytic, we take F_x^* or $\overline{F_x^*}$ to be $(\psi \psi_y^{-1})^\wedge F_x \phi_x \phi^{-1}$. Then we get such F_j as one wish. □

A fundamental result concerning the behavior of morphisms under composition is shown in the following.

Theorem 4.5.2 *Let S, S' and S'' be Klein surfaces and $f : S \rightarrow S', g : S' \rightarrow S''$ continuous mappings such that $f(\partial S) \subset \partial S', g(\partial S') \subset \partial S''$. Consider the following assertions:*

- (1) f is a morphism;
- (2) g is a morphism;
- (3) $g \circ f$ is a morphism.

Then (1) and (2) imply (3). Furthermore, if f is surjective, (1) and (3) imply (2), and if f is open, (2) and (3) imply (1).

The proof of Theorem 4.5.2 is not difficult. Consequently, we lay it to the reader as an exercise.

Corollary 4.5.1 *Let S and S' be topological surfaces and $f : S \rightarrow S'$ a continuous mapping. Then*

(1) If S' is a Klein surface, then there is at most one structure of Klein surface on S such that f is a morphism.

(2) If f is surjective and S is a Klein surface, then there exists at most one structure of Klein surface on S' such that f is a morphism.

4.5.2 Double Covering of Klein Surface. Let S be a Klein surface with atlas $\Sigma = \{(u_i, \phi_i) | i \in I\}$. Suppose S is not a Riemann surface and define

$$U'_i = U_i \times \{i\} \times \{1\} \quad \text{and} \quad U''_i = U_i \times \{i\} \times \{-1\},$$

where i runs over I . We identify some points in

$$X = \left(\bigcup_{i \in I} U'_i \right) \cup \left(\bigcup_{i \in I} U''_i \right).$$

(1) For $i \in I$ and $D_i = \partial S \cap U_i$, identify $D_i \times \{i\} \times \{1\}$ with $D_i \times \{i\} \times \{-1\}$.

(2) For $(j, k) \in I \times I$ such that U_j meets U_k , let W be a connected component in $U_j \cap U_k$. Identify $W \times \{j\} \times \{\delta\}$ with $W \times \{k\} \times \{\delta\}$ for $\delta = \pm 1$ if $\phi_j \phi_k^{-1} : \phi_k(W) \rightarrow \mathbb{C}$ is analytic, and $W \times \{j\} \times \{\delta\}$ with $W \times \{k\} \times \{-\delta\}$ for $\delta = \pm 1$ if $\phi_j \phi_k^{-1} : \phi_k(W) \rightarrow \mathbb{C}$ is antianalytic.

Put $S_C = X / \{\text{identifications above}\}$. For each $i \in I$, let $\phi'_i : U'_i \rightarrow \mathbb{C}$ determined by $\phi'_i(x, i, 1) = \phi_i(x)$ and $\phi''_i : U''_i \rightarrow \mathbb{C}$ determined by $\phi'_i(x, i, -1) = \overline{\phi_i(x)}$. Obviously, if $p : X \rightarrow S_C$ denotes the canonical projection and $\tilde{U}_i = p(U'_i \cup U''_i)$, the family $\{\tilde{U}_i | i \in I\}$ is an open cover of S_C . Furthermore, each mapping $\tilde{\phi}_i : \tilde{U}_i \rightarrow \mathbb{C}$ defined by $\tilde{\phi}_i(u) = \phi'_i(u)$ if $u \in U'_i$ or $\tilde{\phi}_i(u) = \phi''_i(u)$ if $u \in U''_i$ is a homeomorphism onto its image. Thus $\Sigma_C = \{(\tilde{U}_i, \tilde{\phi}_i) | i \in I\}$ is an analytic atlas on S_C . Clearly, $\partial S_C = \emptyset$. Whence, S_C is a Riemann surface by construction.

We claim that there exists a morphism $f : S_C \rightarrow S$ and an antianalytic mapping $\sigma : S_C \rightarrow S_C$ such that $f\sigma = f$ and $\sigma^2 = 1_{S_C}$. In fact, it suffices to determine $f : S_C \rightarrow S$ by $f : u = p(v, i, \delta) \rightarrow v$ for $v \in U_i$ and $\delta = \pm 1$. It should be noted that each fiber of f has one or two points and we define

$$\sigma : S_C \rightarrow S_C : u \rightarrow \begin{cases} u & \text{if } |f^{-1}(f(u))| = 1, \\ f^{-1}(f(u)) & \text{if } |f^{-1}(f(u))| = 2. \end{cases}$$

Such a triple (S_C, f, σ) is called the *double cover* of S .

We know the following result due to Alling-Greenleaf ([BEGG]):

Theorem 4.5.3 *Let g be a morphism from a Riemann surface S onto a Klein surface S' with the double cover (S'_C, f', σ) . Then there exists a unique morphism $g' : S \rightarrow S'_C$ such that $f'g' = g$.*

4.5.3 Discontinuous Action. Let S be a Klein surface and $G \leq \text{Aut}S$. We say G acts discontinuously on S if each point $x \in S$ possesses a neighborhood U such that G_U is finite. Furthermore, G is said to be acts properly discontinuously on S if it acts discontinuously on S satisfying conditions following:

- (1) For $\forall x, y \in S$ with $x \notin y^G$, there are open neighborhoods U and V at points x and y such that there are no $f \in G$ with $U \cap f(V) \neq \emptyset$;
- (2) For $x \in S$, $1_S \neq f \in G_x$ and the mapping $\phi_x f \phi_x^{-1}$ is analytic restricted suitably, x is isolated in $\text{Fix}(f)$.

For the existence of properly discontinuously groups, we know the following result as an example.

Theorem 4.5.4 *Every discrete subgroup Γ of $\text{Aut}H$ acts properly discontinuously on H .*

Proof First, the stabilizer Γ of each $x \in H$ is finite. Otherwise, let $\{f_n | n \in \mathbb{Z}^+\} \subset \Gamma_x$ such that $f_n \neq f_m$ if $n \neq m$ and so $\lim_{n \rightarrow \infty} \{f_n(x) | n \in \mathbb{Z}^+\} = x$. But then Γ must be not discrete.

Now let N be the set of natural numbers m such that H contains the Euclidean ball B_m with center x and radius $1/m$. Let $\Gamma_m = \Gamma_{B_m}$. Then there must be

$$\Gamma_x = \bigcap_{n \in \mathbb{Z}^+} \Gamma_m.$$

In fact, if $f \notin \Gamma_x$, take open disjoint neighborhoods U and V of x and $f(x)$. If m is bigger enough, $B_m \subset U$, $f(B_m) \subset V$. Thus there must be $f \notin \Gamma_m$. On the other hand, if $f \in \Gamma_x$, then there is an integer m_0 such that for any integer $m \geq n_0$, $B_m = f(B_m)$. This establishes the previous equality.

(1) Γ acts discontinuously on H . Assume that each Γ_m is infinite. Then the finiteness of Γ_x and the above equality imply that

$$\Gamma_{m_1} \supsetneq \Gamma_{m_2} \supsetneq \dots$$

for some sequence $\{m_k | k \in \mathbb{Z}^+\} \subset \mathbb{Z}^+$. Choose $f_k \in \Gamma_{m_k} \setminus \Gamma_{m_{k+1}}$. Clearly, $f_k \neq f_l$ if $k \neq l$. However, if we take $x \in B_{m_k} \cap f_k(B_{m_k})$ and $y \in B_{m_k}$ with $x_k = f(y_k)$, then

$$\lim_{k \rightarrow \infty} \{x_k | k \in \mathbb{Z}^+\} = x = \lim_{k \rightarrow \infty} \{y_k | k \in \mathbb{Z}^+\}.$$

So $\lim_{k \rightarrow \infty} \{f(x_k) | k \in \mathbb{Z}^+\} = x$, which contradicts the discreteness of Γ .

(2) For $x, y \in H$, $x \notin y^{\text{Aut}H}$, there are neighborhoods U of x and V of y such that there are no $f \in G$ with $U \cap f(V) \neq \emptyset$. In fact, let P be the set of numbers $m \in \mathbb{Z}^+$ such that the balls B_m and B'_m of radius $1/m$ with centers x and y , respectively, are contained in H . We prove that there are no $f \in \Gamma$ with $B_m \cap f(B'_m) \neq \emptyset$ for all $m \in P$. Denoted by $D_m = \{f \in \Gamma | B_m \cap f(B'_m) \neq \emptyset\}$. Clearly, $\bigcap_{m \in P} D_m = \emptyset$. Otherwise, for some $f \in \Gamma$ there are points $x_m \in B_m$ and $y_m \in B'_m$ with $f(y_m) = x_m$, $m \in P$, which implies $f(y) = x$, i.e., $x \in y^{\text{Aut}H}$, a contradiction. So we have

$$D_{m_1} \supsetneq D_{m_2} \supsetneq \dots$$

for some sequence $\{m_k | k \in \mathbb{Z}^+\} \subset P$. Choose $f_k \in D_{m_k} \setminus D_{m_{k+1}}$. then we know that $\lim_{k \rightarrow \infty} \{f_k(y) | k \in \mathbb{Z}^+\} = x$, $f_k \neq f_l$ if $k \neq l$, contradicts the discontinuousness of Γ .

(3) Given $1_H \neq f \in \Gamma$, f has the form

$$f(z) = \frac{az + b}{cz + d}, \quad (b, c, d - a) \neq (0, 0, 0).$$

Thus $\text{Fix}(f) \setminus \{x\}$ is finite, i.e., x is isolated in $\text{Fix}(f)$. □

The importance of these properly discontinuously groups on Klein surfaces is implied in the next result.

Theorem 4.5.5 *Let G be a subgroup of $\text{Aut}S$ which acts properly discontinuously on the Klein surface S . Then $S' = S/G$ admits a unique structure of Klein surface such that $\pi : S \rightarrow S'$ is a morphism.*

A complete proof of Theorem 4.5.5 can be found in [BEGG1]. Applying Theorems 4.5.4 and 4.5.5 to the planar Klein surface H , we know the following conclusion.

Theorem 4.5.6 *For a discrete subgroup Γ of $\text{Aut}H$, the quotient H/Γ admits a unique structure of Klein surface such that the canonical projection $H \rightarrow H/\Gamma$ is a morphism of Klein surfaces. Particularly, this holds true if Γ is an NEC group.*

Generally, we also know the following result with proof in [BEGG1], which enables one to find Klein surfaces on topological surfaces with genus ≥ 3 .

Theorem 4.5.7 *If S is a Klein surface and $2g(S) + k(S) \geq 3$ if S is orientable, or $g(S) + k(S) \geq 3$ otherwise. Then there exists a surface NEC group Γ such that S and H/Γ are isomorphic Klein surfaces and $S_C = H/\Gamma^+$, where Γ^+ is a subgroup formed by*

orientation preserving elements in Γ . In fact, $|\Gamma : \Gamma^+| = 2$. Furthermore, if $\pi' : H \rightarrow H/\Gamma$ be the canonical projection, i.e, $\Gamma = \langle f \in \text{Aut}H | \pi' f = \pi' \rangle$.

According to this theorem, we can construct Klein surfaces on compact surfaces S unless S is the sphere, torus, projective plane or Klein bottle.

4.5.4 Automorphism of Klein Surface. Let S and S' be compact Klein surfaces. Denote by $\text{Isom}(S', S)$ all isomorphisms from S' to S . If they satisfy these conditions in Theorem 4.5.6, then they can be represented by H/Γ' , H/Γ for some NEC group Γ' and Γ . Let $\pi : H \rightarrow H/\Gamma$ and $\pi' : H \rightarrow H/\Gamma'$ be the canonical projections and

$$A(\Gamma', \Gamma) = \{g \in \text{Aut}H | \pi'(x) = \pi'(y) \text{ if and only if } \pi g(x) = \pi g(y)\}.$$

Then we know the following result.

Theorem 4.5.8 *Let $g \in \text{Aut}H$. The following statements are equivalent:*

- (1) $g \in A(\Gamma', \Gamma)$;
- (2) *there is a unique $\widehat{g} \in \text{Isom}(H/\Gamma', H/\Gamma)$ with the following commutative diagram:*

$$\begin{array}{ccc} H & \xrightarrow{g} & H \\ \downarrow \pi' & & \downarrow \pi \\ S' & \xrightarrow{\widehat{g}} & S \end{array}$$

- (3) $\Gamma' = g^{-1}\Gamma g$.

Proof (1) \Rightarrow (2). For $x' = \pi'(x) \in S'$, define $\widehat{g}(x') = \widehat{g}\pi'(x) = \pi g(x)$. Applying Theorem 4.5.2, we know that \widehat{g} is a homeomorphism on H by the definition of $A(\Gamma, \Gamma')$.

- (2) \Rightarrow (3). Applying Theorem 4.5.7, if $f \in \Gamma'$ and $h = gfg^{-1}$, then

$$\pi h = \pi g f g^{-1} = \widehat{g} \pi' f g^{-1} = \widehat{g} \pi' g^{-1} = \pi g g^{-1} = \pi,$$

i.e., $h \in \Gamma$ and so $\Gamma' \subset g^{-1}\Gamma g$. Conversely, if $h \in g^{-1}\Gamma g$, then $ghg^{-1} \in \Gamma$, i.e., $\pi ghg^{-1} = \pi$. So $\widehat{g}\pi' h = \widehat{g}\pi'$. Notice that \widehat{g} is bijective. We know $\pi' h = \pi'$, i.e., $h \in \Gamma$.

(3) \Rightarrow (1). Let $x, y \in H$ with $\pi'(x) = \pi'(y)$ and $y = f(x)$ for some $f \in \Gamma' = g^{-1}\Gamma g$. Now $h = gfg^{-1} \in \Gamma$. Notice that $hg = gf$ and $\pi h = \pi$. We find that

$$\pi(g(y)) = \pi(g(f(x))) = \pi(h(g(x))) = \pi(g(x)).$$

The converse is similarly proved. □

Theorem 4.5.9 *Let $S = H/\Gamma$ and $S' = H/\Gamma'$. Then*

- (1) *S and S' are isomorphic if and only if Γ and Γ' are conjugate in $\text{Aut}H$.*
- (2) *$\text{Aut}S \simeq N_{\text{Aut}H}(\Gamma)/\Gamma$, where $N_{\text{Aut}H}(\Gamma)$ is the normalizer of Γ in $\text{Aut}H$.*

Proof Obviously, S and S' are isomorphic if and only if $A(\Gamma, \Gamma') \neq \emptyset$. By Theorem 4.5.8, we get the assertion (1).

For (2), we prove first that the mapping $A(\Gamma, \Gamma') \rightarrow \text{Isom}(S', S)$ is surjective. In fact, if S and S' are Riemann surfaces, let $\phi \in \text{Isom}(S', S)$ and (H, π) and (H', π') be the universal coverings of S and S' , respectively. Then by the Monodromy theorem and Theorem 4.5.2, there exists $g \in \text{Aut}H$ such that the following diagram is commutative.

$$\begin{array}{ccc} H & \xrightarrow{g} & H \\ \downarrow \pi' & & \downarrow \pi \\ S' & \xrightarrow{\phi} & S \end{array}$$

It is clear that $g \in A(\Gamma, \Gamma')$. So $\phi = \widehat{g}$ by Theorem 4.5.8.

Generally, let $f : S_C \rightarrow S$ and $f' : S'_C \rightarrow S'$ be the double coverings with the corresponding antianalytic involutions $\sigma : S_C \rightarrow S_C$ and $\sigma' : S'_C \rightarrow S'_C$. By Theorem 4.5.3, there exists $\psi \in \text{Isom}(S'_C, S_C)$ such that the following diagram

$$\begin{array}{ccc} S'_C & \xrightarrow{\psi} & S_C \\ \downarrow f' & & \downarrow f \\ S' & \xrightarrow{\phi} & S \end{array}$$

is commutative. Let $p : H \rightarrow S_C$ and $p' : H \rightarrow S'_C$ be the canonical projections. As we shown for Riemann surfaces, there exists $g \in \text{Aut}H$ such that the following diagram

$$\begin{array}{ccc} H & \xrightarrow{g} & H \\ \downarrow p' & & \downarrow p \\ S'_C & \xrightarrow{\psi} & S_C \end{array}$$

is commutative. Now up to the identifications of S with H/Γ and S' with H/Γ' , the mappings $\pi' = f'p' : H \rightarrow S'$ and $\pi = fp : H \rightarrow S$ are the canonical projections, which enables us to obtain a commutative diagram following.

$$\begin{array}{ccc}
 H & \xrightarrow{\mathcal{G}} & H \\
 \downarrow \pi' & & \downarrow \pi \\
 S' & \xrightarrow{\phi} & S
 \end{array}$$

Applying Theorem 4.5.8 again, we know that $g \in A(\Gamma, \Gamma')$ and $\phi = \widehat{g}$. Now let $S = S'$. It follows that $A(\Gamma, \Gamma') = N_{\text{Aut}H}(\Gamma)$. Thus

$$\mu : N_{\text{Aut}H}(\Gamma) \rightarrow \text{Aut}(S) \quad \text{determined by} \quad \mu(g) = \widehat{g}$$

is a surjective mapping. We prove it is also an epimorphism. In fact, let $g_1, g_2 \in A(\Gamma, \Gamma')$ with $\widehat{g}_1, \widehat{g}_2$ such that $\pi g_1 = \widehat{g}_1 \pi$ and $\pi g_2 = \widehat{g}_2 \pi$. Then $\pi(g_1 g_2) = \widehat{g}_1 \pi g_2 = (\widehat{g}_1 \widehat{g}_2) \pi$. But $g_1 g_2 \in \Gamma$, we know that $\pi(g_1 g_2) = \widehat{g_1 g_2} \pi$. Whence, $\widehat{g}_1 \widehat{g}_2 = \widehat{g_1 g_2}$ by Theorem 4.5.8. Thus μ is an epimorphism. Finally, we check that $\text{Ker} \mu = \Gamma$. Clearly, if $g \in \Gamma$, we have $\pi g = \pi$, i.e.,

$$\begin{array}{ccc}
 H & \xrightarrow{\mathcal{G}} & H \\
 \downarrow \pi & & \downarrow \pi \\
 S & \xrightarrow{1_S} & S
 \end{array}$$

By Theorem 4.5.8, we get $\widehat{g} = 1_S$. So $g \in \text{Ker} \mu$. Conversely, $\widehat{g} = 1_S$ implies that $\pi g = \pi$. Thus $g \in \Gamma$. This completes the proof. \square

Theorem 4.5.10 *Let $f, g \in \text{Aut}^+ H \setminus \{1_H\}$. If $fg = gf$, then $\text{Fix}(f) = \text{Fix}(g)$.*

Proof Not loss of generality, we assume that $1 \leq |\text{Fix}(f)| \leq |\text{Fix}(g)| \leq 2$. By $fg = gf$, we conclude that $g(\text{Fix}(f)) = \text{Fix}(f)$ and $f(\text{Fix}(g)) = \text{Fix}(g)$.

Now if $\text{Fix}(f) = \{x_0\}$, then $g(x_0) = x_0$, and if $g(y) = y$ we know $f(y) = y$, i.e., $y = x_0$. Thus $\text{Fix}(f) = \text{Fix}(g)$ in this case.

If $\text{Fix}(f) = \{x_0, y_0\}$, then $\{g(x_0), g(y_0)\} = \{x_0, y_0\}$. Whence, either $\text{Fix}(f) = \text{Fix}(g)$ or $\text{Fix}(f) \neq \text{Fix}(g)$ with $g(x_0) = y_0, g(y_0) = x_0$. In the second case, choose $z_0 \in \text{Fix}(g) \setminus \text{Fix}(f)$. Notice that x_0, y_0 and z_0 are distinct fixed points of g^2 . We know that $g^2 = 1_H$. Let $A \in GL(2, \mathbb{R})$ with $\text{Det} A = 1$ such that $g = f_A$. Then by $g^2 = 1_H$, we get that $A^2 = \pm I$ and so the minimal polynomial of $A \neq \pm I$ is $x^2 + 1$. Consequently, $g(z) = -1/z$ and $\text{Fix}(g) = \{\pm i\}$. Since $f(H) = H$ and $f(\text{Fix}(g)) = \text{Fix}(g)$, we get $f(i) = i$, and so $f(-i) = -i$. Thus $\text{Fix}(f) = \text{Fix}(g)$. \square

The following result shows that $N_{\text{Aut}H}(\Gamma)$ is also an NEC group.

Theorem 4.5.11 *Let Γ be an NEC group. Then $N_{\text{Aut}H}(\Gamma)$ in $\text{Aut}H$ is also an NEC group.*

Proof Notice $\pi : H \rightarrow H/\Gamma$. We immediately find the compactness of $H/N_{\text{Aut}H}(\Gamma)$ from H under π . Because $\text{Aut}H$ is a topological group, we only need to check that the identity $\{1_H\}$ is an open subset in $N_{\text{Aut}H}(\Gamma)$.

We claim that there exist $1_H \neq h_1, h_2 \in \Gamma^+$ such that $\text{Fix}(h_1) \neq \text{Fix}(h_2)$. In fact, let $h_1 \in \Gamma^+$ defined by $h_1(z) = r_0 z$ for some $r_0 \in \mathbb{R}$. Then $\text{Fix}(h_1) = \{0, \infty\}$. If there are another $h \in \Gamma^+$, $h \neq h_1$ such that $\text{Fix}(h) = \{0, \infty\}$, then

$$\Gamma^+ \subset A = \{f : H \rightarrow H \mid f(z) = rz, r \in \mathbb{R}^+, z \in \mathbb{C}\}.$$

Since H/Γ^+ is compact, the same holds for $H/A \approx (0, 1)$, a contradiction.

Now let $C_{\text{Aut}H}(h_1, h_2) = \{h \in \text{Aut}H \mid hh_i = h_i h, i = 1, 2\}$. We prove that $C_{\text{Aut}H}(h_1, h_2)$ is trivial. Applying Theorem 4.5.10, if there are $1_H \neq h \in C_{\text{Aut}H}(h_1, h_2) \cap \text{Aut}^+H$, then $\text{Fix}(h_1) = \text{Fix}(h) = \text{Fix}(h_2)$, a contradiction. On the other hand, if there are $h \in C_{\text{Aut}H}(h_1, h_2) \setminus \text{Aut}^+H$, then $h^2 = 1_H$, and so $h(z) = -\bar{z}$. Now $hh_i = h_i h$ implies that $h_i(z) = -1/z$ for $i = 1, 2$, also a contradiction. Thus the mapping $\zeta_i : N_{\text{Aut}H}(\Gamma) \rightarrow \Gamma$ by $g \rightarrow gh_i g^{-1}$ are well-defined and continuous with $\zeta_i(1_H) = h_i$.

Since Γ is discrete, we can find open neighborhoods V_1, V_2 of 1_H in $N_{\text{Aut}H}(\Gamma)$ such that $\zeta_i(V_i) \subset \{h_i\}$, i.e., $gh_i g^{-1} = h_i, i = 1, 2$ for each $g \in V = V_1 \cap V_2$. In other words, $V \subset C_{\text{Aut}H}(h_1, h_2) = \{1_H\}$. Thus $\{1_H\} = V$ is open in $N_{\text{Aut}H}(\Gamma)$. \square

A group of automorphism of a Klein surface S is a subgroup of $\text{Aut}S$. We get the following consequence by Theorem 4.5.11.

Corollary 4.5.2 *A group $G \leq \text{Aut}S$ with $S = H/\Gamma$ if and only if $G \simeq \Gamma'/\Gamma$ for some NEC group Γ' with $\Gamma \triangleleft \Gamma'$.*

Proof Applying Theorem 4.5.11, G is a subgroup of $N_{\text{Aut}H}(\Gamma)/\Gamma$. So there is a subgroup Γ' of $N_{\text{Aut}H}(\Gamma)$ containing Γ such that H/Γ' is compact. Notice Γ' is also discrete. Whence, Γ' is a NEC group. \square

Now we prove the main result of this section.

Theorem 4.5.12 *Let S be a compact Klein surface with conditions in Theorem 4.5.7 hold. Then $\text{Aut}S$ is finite.*

Proof Let $S = H/\Gamma$. By Theorem 4.5.10, $N_{\text{Aut}H}(\Gamma)$ is an NEC group. Applying Theorem 4.4.5, we know $\text{Aut}S$ is finite by that of the group index $[N_{\text{Aut}H}(\Gamma) : \Gamma]$. \square

§4.6 REMARKS

4.6.1 Topology, including both the *point topology* and the *algebraic topology* has become one of the fundamentals of modern mathematics, particularly for geometrical spaces. Among them, the simplest is the surfaces fascinating mathematicians in algebra, geometry, mathematical analysis, combinatorics, \dots , and mechanics. There are many excellent graduated textbooks on topology, in which the reader can find more interested materials, for examples, [Mas1]-[Mas2] and [Mun1].

4.6.2 Similar to Theorem 4.2.4 on compact surface without boundary, we can classify compact surface with boundary and prove the following result.

Theorem 4.6.1 *Let S be a connected compact surface with $k \geq 1$ boundaries. Then its surface presentation is elementary equivalent to one of the following:*

(1) *Sphere with $k \geq 1$ holes*

$$aa^{-1}c_1B_1c_1^{-1}c_2B_2c_2^{-1}\cdots c_kB_kc_k^{-1};$$

(2) *Connected sum of p tori with $k \geq 1$ holes*

$$a_1b_1a_1^{-1}b_1^{-1}a_2b_2a_2^{-1}b_2^{-1}\cdots a_p b_p a_p^{-1} b_p^{-1} c_1 B_1 c_1^{-1} c_2 B_2 c_2^{-1} \cdots c_k B_k c_k^{-1};$$

(3) *Connected sum of q projection planes with $k \geq 1$ holes*

$$a_1 a_2 \cdots a_q c_1 B_1 c_1^{-1} c_2 B_2 c_2^{-1} \cdots c_k B_k c_k^{-1}.$$

4.6.3 The conception of fundamental group was introduced by H.Poincaré in 1895. Similarly, replacing equivalent loops of dimensional 1 based at x_0 by equivalent loops of dimensional d , we can extend this conception for characterize those higher dimensional topological spaces with resemble structure of surface.

4.6.4 The conception of Klein surface was introduced by Alling and Greenleaf in 1971 concerned with real algebraic curves, correspondence with that of *Riemann surface* concerned with complex algebraic curves (See [All1] for details). The materials in Sections 4.5.4 and 4.5.5 are mainly extracted from the reference [BEGG1]. Certainly, all Riemann surfaces are orientable. Their surface group is usually called the *Fuchsian group* constructed similarly to that of Construction 4.4.2. It should be noted that each surface

in Construction 4.4.2 for an NEC group maybe with boundary. This construction also establishes the relation of surfaces with that of NEC groups, enables one to research automorphisms of Kleins surface by that of combinatorial maps.

CHAPTER 5.

Map Groups

A *map group* is a subgroup of an automorphism group of map, which is also a kind of geometrical group, i.e., a subgroup of triangle groups. There are two ways for such groups in literature. One is by combinatorial techniques. Another is the classical by that of algebraic techniques. Both of them have their self-advantages and covered in this chapter. The materials in Sections 5.1–5.2 are an elementary introduction to combinatorial maps. By the discussion of Chapter 4, we explain how to embed a graph and how to characterize an embedding of graph on surface in Section 5.1, particularly these techniques related to algebraic maps, such as those of rotation system, band decomposition of surface, traveling ruler and orientability algorithm in Section 5.1. This way naturally introduce the reader to understand the correspondence between embeddings and maps, and the essence of notations α, β and \mathcal{P} , or flags in an algebraic map $(\mathcal{X}_\alpha, \mathcal{P})$. The automorphisms of map with properties are discussed in Section 5.3, characterized by behavior of maps or the semi-arc automorphism of its underlying graph. The materials in Sections 5.4–5.5 centre on regular maps, both by combinatorial and algebraic techniques, which are closely related combinatorics with geometry and algebra. By explaining how to get a regular tessellation of a plane, a geometrical way for constructing regular maps by triangle group is introduced in Section 5.5. After generalizing the conception of surface to multisurface \tilde{S} in section 5.5, we also show how to construct maps \tilde{M} on multisurfaces \tilde{S} such that the projection of \tilde{M} on each surface of \tilde{S} is a regular map.

§5.1 GRAPHS ON SURFACES

5.1.1 Cell Embedding. Let G be a connected graph with vertex set $V(G)$ and edge set $E(G)$ and S a surface. An *2-cell embedding* of G on S is geometrical defined to be a continuous 1 – 1 mapping $\tau : G \rightarrow S$ such that each component in $S - \tau(G)$ homeomorphic to an open 2-disk. Certainly, the image $\tau(G)$ is contained in the 1-skeleton of a triangulation of the surface S . Usually, components in $S - \tau(G)$ are called faces. For example, we have shown an embedding of K_4 on the sphere and Klein bottle in Fig.5.1.1(a) and Fig.5.1.1(b) respectively.

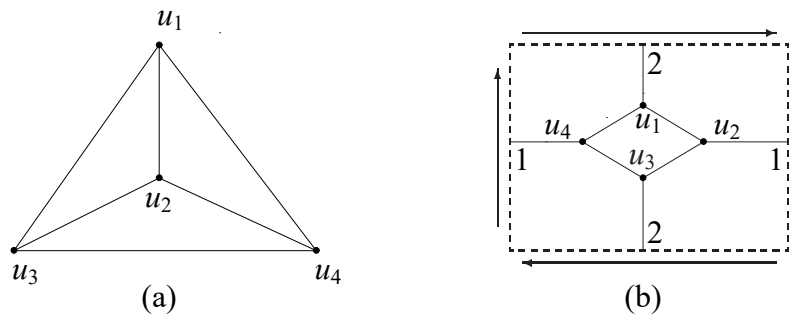

Fig.5.1.1

For $v \in V(G)$, denote by $N_G^e(v) = \{e_1, e_2, \dots, e_{\rho(v)}\}$ all the edges incident with the vertex v . A permutation on $e_1, e_2, \dots, e_{\rho(v)}$ is said a *pure rotation*. All pure rotations incident with v is denoted by $\varrho(v)$. A *pure rotation system* of the graph G is defined to be

$$\rho(G) = \{\varrho(v) | v \in V(G)\}.$$

For example, the pure rotation systems for embeddings of K_4 on the sphere and Klein bottle are respective

$$\begin{aligned} \rho(K_4) &= \{(u_1u_4, u_1u_3, u_1u_2), (u_2u_1, u_2u_3, u_2u_4), (u_3u_1, u_3u_4, u_3u_2), (u_4u_1, u_4u_2, u_4u_3)\}, \\ \rho(K_4) &= \{(u_1u_2, u_1u_3, u_1u_4), (u_2u_1, u_2u_3, u_2u_4), (u_3u_2, u_3u_4, u_3u_1), (u_4u_1, u_4u_2, u_4u_3)\} \end{aligned}$$

and intuitively, we can get a pure rotation system for each embedding of K_4 on a locally orientable surface S .

In fact, there is a relation between these pure rotation systems of a graph G and its embeddings on orientable surfaces S , called the *rotation embedding scheme*, observed and used by Dyck in 1888, Heffter in 1891 and then formalized by Edmonds in 1960 following.

Theorem 5.1.1 *Every embedding of a graph G on an orientable surface S induces a unique pure rotation system $\rho(G)$. Conversely, Every pure rotation system $\rho(G)$ of a graph G induces a unique embedding of G on an orientable surface S .*

Proof If there is a 2-cell embedding of G on an orientable surface S , by the definition of surface, there is a neighborhood D_u on S for $u \in V(G)$ which homeomorphic to a dimensional 2 disc $\varphi : D_u \rightarrow \{(x_1, x_2) \in \mathbb{R}^2 | x_1^2 + x_2^2 < 1\}$ such that each edge incident with u possesses segment not in D_u . Denoted by $\partial D_u = \{(x_1, x_2) \in \mathbb{R}^2 | x_1^2 + x_2^2 = 1\}$ and let the counterclockwise order of intersection points of edges $uv, v \in N_G(u)$ with that of ∂D_u be $p_{v_1}, p_{v_2}, \dots, p_{v_{\rho(u)}}$. Define a pure rotation of u by $\varrho(u) = (uv_1, uv_2, \dots, uv_{\rho(u)})$. Then we get a pure rotation system $\rho(G) = \{\varrho(u), u \in V(G)\}$.

Conversely, assume that we are given a pure rotation system $\rho(G)$. We show that this determines a 2-cell embedding of G on a surface. Let D denote the digraph obtained by replacing each edge $uv \in G$ with (u, v) and (v, u) . Define a mapping $\pi : E(D) \rightarrow E(D)$ by $\pi(u, v) = \varrho(v)(v, u)$, which is $1 - 1$, i.e., a permutation on $E(D)$. Whence π can be expressed as a product of disjoint cycles. Each cycle is an orbit of π action on $D(E0)$. Thus the orbits partition the set $E(D)$. Assume

$$F : (u, v)(v, w) \cdots (z, u)$$

is such a orbit under the action of π , simply written as

$$F : (u, v, w, \dots, z, u).$$

Notice this implies a *traveling ruler*, i.e., beginning at u and proceed along (u, v) to v , the next arc we encounter after (u, v) in a counterclockwise direction about v is $\rho(v)(v, u)$. Continuing this process we finally arrive at the arc (z, u) , return to u and get the boundary of a 2-cell.

Let F_1, F_2, \dots, F_l be all 2-cells obtained by the traveling ruler on $E(D)$. Applying Theorem 4.2.2, we know it is a polygonal representation of an orientable surface S by identifying arc pairs (u, v) with (v, u) in $E(D)$. □

According to this theorem, we get the number of embeddings of a graph on orientable surfaces following.

Corollary 5.1.1 *The number of embeddings of a connected graph G on orientable surfaces is $\prod_{v \in V(G)} (\rho(v) - 1)!$.*

5.1.2 Rotation System. For a 2-cell embedding of a graph G on a surface S , its embedded vertex and face can be viewed as 0 and 2-disks, and its embedded edge can be viewed as a 1-band defined as a topological space B with a homeomorphism $h : I \times I \rightarrow B$, where $I = [0, 1]$, the unit interval. The arcs $h(I \times \{i\})$ for $i = 0, 1$ are called the *ends* of B , and the arcs $h(\{i\} \times I)$ for $i = 0, 1$ are called the *sides* of B . A 0-band or 2-band is just a homeomorphism of the unit disk. A *band decomposition* of the surface S is defined to be a collection \mathcal{B} of 0-bands, 1-bands and 2-bands with conditions following hold:

- (1) The different bands intersect only along arcs in their boundary;
- (2) The union of all the bands is S , i.e., $\bigcup_{B \in \mathcal{B}} B = S$;
- (3) The ends of each 1-band are contained in a 0-band;
- (4) The sides of each 1-band are contained in a 2-band;
- (5) The 0-bands are pairwise disjoint, and the 2-bands are pairwise disjoint.

For example, a band decomposition of the torus is shown in Fig.5.1.2, which is an embedding of the bouquet B_2 on T^2 .

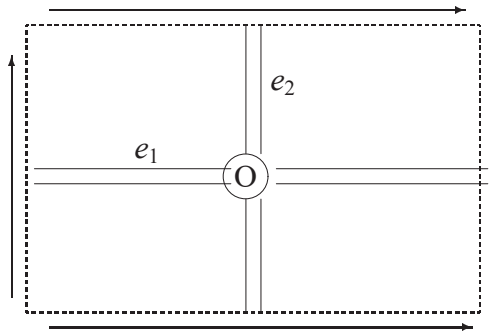

Fig.5.1.2

A band decomposition is called *locally orientable* if each 0-band is assigned an orientation. Then a 1-band is called *orientation-preserving* if the direction induced on its ends by adjoining 0-bands are the same as those induced by one of the two possible orientations of the 1-band. Otherwise, the 1-band is called *orientation-reversing*, such as those shown in Fig.5.1.3 following.



Fig.5.1.3

An edge e in a graph G embedded on a surface S associated with a locally orientable band decomposition is said to be *type 0* if its corresponding 1-band is orientation-preserving, and *type 2*, otherwise. A walk in this associated graph is *type 1* if it has an odd number of type 1 edges and *type 0*, otherwise.

For such a graph G associated with a locally orientable band decomposition, we define a *rotation system* $\rho^L(v)$ of $v \in V(G)$ to be a pair $(\mathcal{J}(v), \lambda)$, where $\mathcal{J}(v)$ is a pure rotation system and $\lambda : E(G) \rightarrow \mathbb{Z}_2$ is determined by $\lambda(e) = 0$ or $\lambda(e) = 1$ if e is *type 0* or *type 1* edge, respectively. For simplicity, we denote the pairs $(e, 0)$ and $(e, 1)$ by e and e^1 , respectively. The rotation system $\rho^L(G)$ of G is defined by

$$\rho^L(G) = \{(\mathcal{J}(v), \lambda) \mid \mathcal{J}(v) \in \rho(G), \lambda : E(G) \rightarrow \mathbb{Z}_2\}.$$

For example, the rotation system of the complete graph K_4 on the Klein bottle shown in Fig.5.1.1(b) is

$$\rho^L(K_4) = \{(u_1u_2, u_1u_3^1, u_1u_4), (u_2u_1, u_2u_3, u_2u_4), (u_3u_2, u_3u_4, u_3u_1^1), (u_4u_1, u_4u_2, u_4u_3)\}.$$

It should be noted that the traveling ruler in the proof of Theorem 5.1.1 can be generalized for finding 2-cells, i.e., faces in both of a graph embedded on an orientable or non-orientable surface following.

Generalized Traveling Ruler. Not loss of generality, assume that there are no 2-valent vertices in G .

(1) Choose an initial vertex v_0 of G , a first edge e_1 incident with v_0 and v_1 be the other end of e_1 .

(2) The second edge e_2 in the boundary walk is the edge after (respective, before) e_1 at v_1 if e_1 is type 0 (respective, type 1). If the edge e_1 is a loop, then e_2 is the edge after (respective, before) the other occurrence of e_1 at v_1 .

(3) In general, if the walk traced so far ends with edge e_i at vertex v_i , then the next edge e_{i+1} is the edge after (respective, before) e_i at vertex v_i if the walk is type 0 (respective, type 1).

(4) The boundary walk is finished at edge e_n if the next two edges in the walk would be e_1 and e_2 again.

For example, calculation shows that the faces of K_4 embedded on the Klein bottle shown in fig.5.1.1(b) is

$$F_1 = (u_1, u_2, u_3, u_4, u_1), \quad F_2 = (u_1, u_3, u_4, u_2, u_3, u_1, u_4, u_2, u_1).$$

The general scheme for embedding graphs on locally orientable surfaces was used extensively by Ringel in the 1950s and then formally proved by Stahl in 1978 following ([Sta1]-[Sta2]).

Theorem 5.1.2 *Every rotation system on a graph G defines a unique locally orientable 2-cell embedding of $G \rightarrow S$. Conversely, every 2-cell embedding of a graph $G \rightarrow S$ defines a rotation system for G .*

Proof The proof is the same as that of Theorem 5.1.1 by replacing the traveling ruler with that of the generalized traveling ruler. \square

For any embedding of a graph G on a surface S with a band decomposition \mathcal{B} , we can always find a spanning tree T of G such that every edge on this tree is type 0 by the following algorithm.

Orientability Algorithm. Let T be a spanning tree of G .

- (1) Choose a root vertex u for T and an orientation for the 0-band of u_0 .
- (2) For each vertex u_1 adjacent to u_0 in T , choose the orientation for the 0-band of u_1 so that the edge of T from u_0 to u_1 is type 0.
- (3) If u_i and u_{i+1} for an integer are adjacent in T and the orientation at u_i has been already determined but that of u_{i+1} has not been determined yet, choose an orientation at u_{i+1} such that the type of the edge from u_i to u_{i+1} is type 0.
- (4) Continuous the process on T until every 0-band has an orientation.

Combining the orientability algorithm with that of Theorem 5.1.2, we get the number of embeddings of a graph on locally orientable surfaces following.

Corollary 5.1.2 *Let G be a connected graph. Then the number of embeddings of G on locally orientable surfaces is*

$$2^{\beta(G)} \prod_{v \in V(G)} (\rho(v) - 1)!$$

and the number of embeddings of G on the non-orientable surfaces is

$$(2^{\beta(\Gamma)} - 1) \prod_{v \in V(\Gamma)} (\rho(v) - 1)!,$$

where $\beta(G) = |E(G)| - |V(G)| + 1$ is the Betti number of G .

5.1.3 Equivalent Embedding. Two embeddings $(\mathcal{J}_1, \lambda_1), (\mathcal{J}_2, \lambda_2)$ of a graph G on a locally orientable surface S are called to be *equivalent* if there exists an orientation-

preserving homeomorphism τ of the surface S such that $\tau : \mathcal{J}_1 \rightarrow \mathcal{J}_2$, and $\tau\lambda = \lambda\tau$. If $(\mathcal{J}_1, \lambda_1) = (\mathcal{J}_2, \lambda_2) = (\mathcal{J}, \lambda)$, then such an orientation-preserving homeomorphism mapping $(\mathcal{J}_1, \lambda_1)$ to $(\mathcal{J}_2, \lambda_2)$ is called an automorphism of the embedding (\mathcal{J}, λ) . Clearly, all automorphisms of an embedding (\mathcal{J}, λ) form a group under the composition operation of mappings, denoted by $\text{Aut}(\mathcal{J}, \lambda)$.

For example, the two embeddings of K_4 shown in Fig.5.1.4(a) and (b) are equivalent,

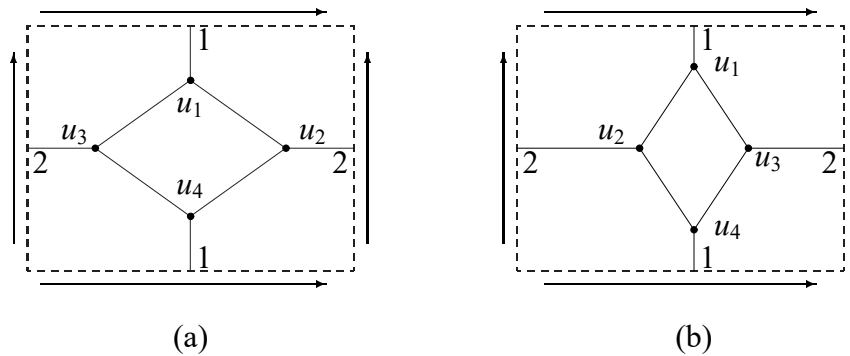

Fig.5.1.4

where the orientation-preserving homeomorphism h is determined by

$$h(u_1) = u_1, h(u_2) = u_3, h(u_3) = u_2 \text{ and } h(u_4) = u_4.$$

The following result is immediately gotten by definition.

Theorem 5.1.3 *Let (\mathcal{J}, λ) be an embedding of a connected graph G on a locally orientable surface S . Then*

$$\text{Aut}(\mathcal{J}, \lambda) \leq \text{Aut}G.$$

5.1.4 Euler-Poincaré Characteristic. Applying Theorems 4.2.5-4.2.6, we get the Euler-Poincaré characteristic of an embedded graph G on a surface S following.

Theorem 5.1.4 *Let G be a graph embedded on a surface S . Then*

$$v(G) - \varepsilon(G) + \phi(G) = \chi(S),$$

where, $v(G)$, $\varepsilon(G)$ and $\phi(G)$ are the order, size and the number of faces of the embedded

graph G on S , and $\chi(S)$ is the Euler-Poincaré characteristic of S determined by

$$\chi(S) = \begin{cases} 2 & \text{if } S \sim_{El} S^2, \\ 2 - 2p & \text{if } S \sim_{El} \underbrace{T^2 \# T^2 \# \dots \# T^2}_p, \\ 2 - q & \text{if } S \sim_{El} \underbrace{P^2 \# P^2 \# \dots \# P^2}_q. \end{cases}$$

§5.2 COMBINATORIAL MAPS

5.2.1 Combinatorial Map. The embedding characteristic of a graph G on surfaces S , particularly, Theorems 5.1.1-5.1.2 and the generalized traveling ruler present embryonic maps. In fact, a map is nothing but a graph cellularly embedded on a surface. That is why one can enumerates maps by means of embedded graphs on surfaces. In 1973, Tutte found an algebraic representation for the embedding of graphs on locally orientable surfaces (see [Tut1]-[Tut2] for details), which completely transfers 2-cell partitions of surfaces to permutations in algebra.

Let G be an embedded graph on a surface S with a band decomposition \mathcal{B} and $e \in E(G)$. Then the band B_e of e is a topological space B with a homeomorphism $h : I \times I \rightarrow B$ and sides $h(\{i\} \times I)$ for $i = 0, 1$. For characterizing its embedding behavior, i.e., initial and end vertices, left and right sides of 1-band B_e , a natural idea is to introduce quadricells for e , such as those shown in Fig.5.2.1 following,

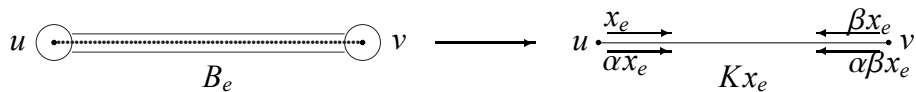

Fig.5.2.1

where we denote one quarter beginning at the vertex u of B_e by x_e and its reflective quarters on the symmetric axis e , on the perpendicular mid-line of e and on the central point of e by $\alpha x_e, \beta x_e$ and $\alpha\beta x_e$, respectively.

Let $K = \{1, \alpha, \beta, \alpha\beta\}$. Then K is a 4-element group under the composition operation by definition with

$$\alpha^2 = 1, \quad \beta^2 = 1, \quad \alpha\beta = \beta\alpha,$$

called the *Klein group*. The action of K on an edge $e \in E(G)$ is defined to be

$$Ke = \{x_e, \alpha x_e, \beta x_e, \alpha \beta x_e\},$$

called the *quadicells* of e . Notice that Theorems 5.1.1-5.1.2 and the generalize traveling ruler claim the embedded graph G on surface S is correspondent with

$$\rho^L(G) = \{(\mathcal{J}(v), \lambda) \mid \mathcal{J}(v) \in \rho(G), \lambda : E(G) \rightarrow \mathbb{Z}_2\}.$$

Whence, if we turn 1-bands to quadicells for $e \in E(G)$, the rotation system $\varrho(u)$ at a vertex u becomes to two cyclic permutations $(x_{e_1}, x_{e_2}, \dots, x_{e_{\rho(u)}})$, $(\alpha x_{e_1}, \alpha x_{e_{\rho(u)}}, \dots, \alpha x_{e_2})$ if $N_G(u) = \{e_1, e_2, \dots, e_{\rho(u)}\}$. By definition, $Kx_{e_1} \cap Kx_{e_2} = \emptyset$ if $e_1 \neq e_2$. We therefore get a set

$$\mathcal{X}_{\alpha, \beta} = \bigcup_{e \in E(G)} Kx_e = \bigoplus_{e \in E(G)} \{x_e, \alpha x_e, \beta x_e, \alpha \beta x_e\}.$$

Define a permutation

$$\mathcal{P} = \prod_{u \in V(G)} (x_{e_1}, x_{e_2}, \dots, x_{e_{\rho(u)}})(\alpha x_{e_1}, \alpha x_{e_{\rho(u)}}, \dots, \alpha x_{e_2}) = \prod_{u \in V(G)} C_v \cdot (\alpha C_v^{-1} \alpha^{-1}),$$

called the *basic permutation* on $\mathcal{X}_{\alpha, \beta}$, i.e., $\mathcal{P}^k x \neq \alpha x$ for any integer $k \geq 1$, $x \in \mathcal{X}_{\alpha, \beta}$, where $C_v = (x_{e_1}, x_{e_2}, \dots, x_{e_{\rho(u)}})$. This permutation also make one understanding the embedding of G on surface S if we view a vertex $u \in V(G)$ as the conjugate cycles $C \cdot (\alpha C^{-1} \alpha^{-1}) = (x_{e_1}, x_{e_2}, \dots, x_{e_{\rho(u)}})(\alpha x_{e_1}, \alpha x_{e_{\rho(u)}}, \dots, \alpha x_{e_2})$ and an edge e as the quadicell Kx_e . We have two claims following.

Claim 1. $\alpha \mathcal{P} \alpha^{-1} = \mathcal{P}^{-1}$.

Let $\mathcal{P} = \prod_{u \in V(G)} (x_{e_1}, x_{e_2}, \dots, x_{e_{\rho(u)}})(\alpha x_{e_1}, \alpha x_{e_{\rho(u)}}, \dots, \alpha x_{e_2})$. Calculation shows that

$$\begin{aligned} \alpha \mathcal{P} \alpha^{-1} &= \alpha \left(\prod_{u \in V(G)} (x_{e_1}, x_{e_2}, \dots, x_{e_{\rho(u)}})(\alpha x_{e_1}, \alpha x_{e_{\rho(u)}}, \dots, \alpha x_{e_2}) \right) \alpha^{-1} \\ &= \prod_{u \in V(G)} \left(\alpha (x_{e_1}, x_{e_2}, \dots, x_{e_{\rho(u)}}) \alpha^{-1} \right) \cdot \left(\alpha (\alpha x_{e_1}, \alpha x_{e_{\rho(u)}}, \dots, \alpha x_{e_2}) \alpha^{-1} \right) \\ &= \prod_{u \in V(G)} (\alpha x_{e_1}, \alpha x_{e_2}, \dots, \alpha x_{e_{\rho(u)}})(x_{e_1}, x_{e_{\rho(u)}}, \dots, x_{e_2}) = \mathcal{P}^{-1}. \end{aligned}$$

Claim 2. The group $\langle \alpha, \beta, \mathcal{P} \rangle$ is transitive on $\mathcal{X}_{\alpha, \beta}$.

For $\forall x, y \in \mathcal{X}_{\alpha, \beta}$, assume they are the quadicells of edges e^1 and e^2 . By the connectedness of G , we know that there is a path $P = e^1 e^2 \dots e^s$ connected e^1 and e^s in G for

an integer $s \geq 0$. Notice that edges e' with e^1 and e'' with e^s are adjacent. Not loss of generality, let $\mathcal{P}^{k_1}x = x_{e^1}$ and $\mathcal{P}^{k_2}x_{e^s} = y$. Then we know that

$$(\alpha\beta)^s x_{e^1} = x_{e^s}, \text{ or } \alpha x_{e^s}, \text{ or } \beta x_{e^s} \text{ or } \alpha\beta x_{e^s}.$$

Whence, we must have that

$$\begin{aligned} \mathcal{P}^{k_2}(\alpha\beta)^s \mathcal{P}^{k_1}x &= y, \quad \text{or } \mathcal{P}^{k_2}\alpha(\alpha\beta)^s \mathcal{P}^{k_1}x = y, \quad \text{or} \\ \mathcal{P}^{k_2}\beta(\alpha\beta)^s \mathcal{P}^{k_1}x &= y, \quad \text{or } \mathcal{P}^{k_2}\alpha(\alpha\beta)^{s+1} \mathcal{P}^{k_1}x = y. \end{aligned}$$

Notice that $\mathcal{P}^{k_2}(\alpha\beta)^s \mathcal{P}^{k_1}$, $\mathcal{P}^{k_2}\alpha(\alpha\beta)^s \mathcal{P}^{k_1}$, $\mathcal{P}^{k_2}\beta(\alpha\beta)^s \mathcal{P}^{k_1}$ and $\mathcal{P}^{k_2}\alpha(\alpha\beta)^{s+1} \mathcal{P}^{k_1}$ are elements in the group $\langle \alpha, \beta, \mathcal{P} \rangle$. Thus $\langle \alpha, \beta, \mathcal{P} \rangle$ is transitive on $\mathcal{X}_{\alpha, \beta}$.

Claims 1 and 2 enable one to define a map M algebraically following.

Definition 5.2.1 *Let X be finite set, $K = \{1, \alpha, \beta, \alpha\beta\}$ the Klein group and*

$$\mathcal{X}_{\alpha, \beta} = \bigoplus_{x \in X} \{x, \alpha x, \beta x, \alpha\beta x\}.$$

Then a map M is defined to be a pair $(\mathcal{X}_{\alpha, \beta}, \mathcal{P})$, where \mathcal{P} is a basic permutation action on $\mathcal{X}_{\alpha, \beta}$ such that the following axioms hold:

Axiom 1. $\alpha\mathcal{P} = \mathcal{P}^{-1}\alpha$;

Axiom 2. *The group $\Psi_J = \langle \alpha, \beta, \mathcal{P} \rangle$ with $J = \{\alpha, \beta, \mathcal{P}\}$ is transitive on $\mathcal{X}_{\alpha, \beta}$.*

Notice that Axiom 2 enables one to decompose \mathcal{P} to a production of conjugate cycles C_v and $\alpha C_v^{-1} \alpha^{-1}$ correspondent to the vertices of the M , i.e.,

$$\mathcal{P} = \prod_{v \in V(M)} C_v \cdot \alpha C_v^{-1} \alpha^{-1}.$$

We present an example for maps correspondent to embedded graphs following.

Example 5.2.1 *The embedded graph K_4 on the tours T^2 shown in Fig.5.2.2 following can be algebraic represented by a map $(\mathcal{X}_{\alpha, \beta}, \mathcal{P})$ with $\mathcal{X}_{\alpha, \beta} = \{x, y, z, u, v, w, \alpha x, \alpha y, \alpha z, \alpha u, \alpha v, \alpha w, \beta x, \beta y, \beta z, \beta u, \beta v, \beta w, \alpha\beta x, \alpha\beta y, \alpha\beta z, \alpha\beta u, \alpha\beta v, \alpha\beta w\}$ and*

$$\begin{aligned} \mathcal{P} &= (x, y, z)(\alpha\beta x, u, w)(\alpha\beta z, \alpha\beta u, v)(\alpha\beta y, \alpha\beta v, \alpha\beta w) \\ &\times (\alpha x, \alpha z, \alpha y)(\beta x, \alpha w, \alpha u)(\beta z, \alpha v, \beta u)(\beta y, \beta w, \beta v). \end{aligned}$$

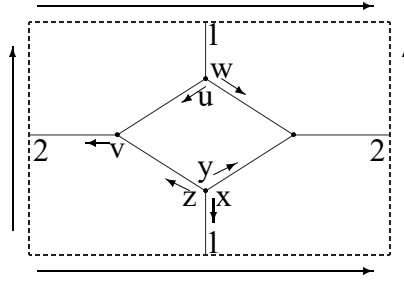

Fig 5.2.2

Its four vertices are

$$\begin{aligned} u_1 &= \{(x, y, z), (\alpha x, \alpha z, \alpha y)\}, & u_2 &= \{(\alpha\beta x, u, w), (\beta x, \alpha w, \alpha u)\}, \\ u_3 &= \{(\alpha\beta z, \alpha\beta u, v), (\beta z, \alpha v, \beta u)\}, & u_4 &= \{(\alpha\beta y, \alpha\beta v, \alpha\beta w), (\beta y, \beta w, \beta v)\}. \end{aligned}$$

and its six edges are $\{e, \alpha e, \beta e, \alpha\beta e\}$, where, $e \in \{x, y, z, u, v, w\}$.

5.2.2 Dual Map. Let $M = (\mathcal{X}_{\alpha,\beta}, \mathcal{P})$ be a map. Notice that

$$\alpha\mathcal{P}\alpha^{-1} = \mathcal{P}^{-1} \Rightarrow \beta(\mathcal{P}\alpha\beta)\beta^{-1} = (\mathcal{P}\alpha\beta)^{-1}$$

and $\Psi_J = \langle \alpha, \beta, \mathcal{P} \rangle$ is transitive on $\mathcal{X}_{\alpha,\beta}$ also. We know that $M^* = (\mathcal{X}_{\beta,\alpha}, \mathcal{P}\alpha\beta)$ is also a map by definition, called the *dual map* of M . Now the generalized traveling ruler becomes

Traveling Ruler on Map. For $\forall x \in \mathcal{X}_{\alpha,\beta}$, the successor of x is the element y after $\alpha\beta x$ in \mathcal{P} , thus each face of M is a pair of conjugate cycles in the decomposition

$$\mathcal{P}\alpha\beta = \prod_{f \in V(M^*)} C^* \cdot (\beta C^{-*} \beta^{-1}),$$

i.e., a vertex of its dual map M^* . The length of a face f of M is called the *valency* of f .

Example 5.2.2 The faces of K_4 embedded on torus shown in Fig.5.2.2 are respective

$$\begin{aligned} f_1 &= (x, u, v, \alpha\beta w, \alpha\beta x, y, \alpha\beta v, \alpha\beta z)(\beta x, \alpha z, \alpha v, \beta y, \alpha x, \alpha w, \beta v, \beta u), \\ f_2 &= (\alpha y, \beta w, \alpha u, \beta z)(\alpha\beta y, z, \alpha\beta u, w). \end{aligned}$$

By the definitions of map M with its dual M^* , we immediately get the following results according to Theorems 5.1.1-5.1.2.

Theorem 5.2.1 Every map $M = (\mathcal{X}_{\alpha,\beta}, \mathcal{P})$ defines a unique locally orientable 2-cell embedding of $G \rightarrow S$ with

$$V(G) = \{ \{ C \cdot \alpha C^{-1} \alpha^{-1} \mid C \in \mathcal{C} \} \}, \quad E(G) = \{ Kx \mid x \in X \}$$

and the face set $F(G)$ determined by cycle pairs $\{F, \beta F \beta^{-1}\}$ in the decomposition of $\mathcal{P} \alpha \beta$. Conversely, every 2-cell embedding of a graph $G \rightarrow S$ defines a map $M = (\mathcal{X}_{\alpha, \beta}, \mathcal{P})$ determined by

$$\mathcal{X}_{\alpha, \beta} = \bigcup_{e \in E(G)} Kx_e = \bigoplus_{e \in E(G)} \{x_e, \alpha x_e, \beta x_e, \alpha \beta x_e\}$$

and

$$\mathcal{P} = \prod_{u \in V(G)} (x_{e_1}, x_{e_2}, \dots, x_{e_{\rho(u)}})(\alpha x_{e_1}, \alpha x_{e_{\rho(u)}}, \dots, \alpha x_{e_2}),$$

if $N_G(u) = \{e_1, e_2, \dots, e_{\rho(u)}\}$.

By Theorem 5.2.1, the embedded graph G (the map M) correspondent to the map M (the embedded graph G) is called the *underlying graph of M (map underlying G)*, denoted by $G(M)$ and $M(G)$, respectively.

Theorem 5.2.2 *Let $M = (\mathcal{X}_{\alpha, \beta}, \mathcal{P})$ be a map. Then its Euler-Poincaré characteristic is*

$$\chi(M) = \nu(M) - \varepsilon(M) + \phi(M),$$

where $\nu(M)$, $\varepsilon(M)$, $\phi(M)$ are the number of vertices, edges and faces of the map M , respectively.

Example 5.2.2 The Euler-Poincaré characteristic $\chi(M)$ of the map shown in Fig.5.2.2 is

$$\chi(M) = \nu(M) - \varepsilon(M) + \phi(M) = 4 - 6 + 2 = 0.$$

5.2.3 Orientability. For defining a map $(\mathcal{X}_{\alpha, \beta}, \mathcal{P})$ is orientable or not, we first prove the following result.

Theorem 5.2.3 *Let $M = (\mathcal{X}_{\alpha, \beta}, \mathcal{P})$ be a map. Then the number of orbits of the group $\Psi_L = \langle \alpha \beta, \mathcal{P} \rangle$ action on $\mathcal{X}_{\alpha, \beta}$ with $L = \{\alpha \beta, \mathcal{P}\}$ is at most 2.*

Proof Notice that $|\Psi_J : \Psi_L| = 2$, i.e., $\langle \alpha, \beta, \mathcal{P} \rangle = \langle \alpha \beta, \mathcal{P} \rangle \cup \alpha \langle \alpha \beta, \mathcal{P} \rangle$. For $x, y \in \mathcal{X}$, if there are no elements $h \in \Psi_L$ such that $x^h = y$, by Axiom 2 there must be an element $\theta \in \Psi_J$ with $x^\theta = y$. Clearly, $\theta \in \alpha \Psi_L$. Let $\theta = \alpha h$. Then $\alpha x^h = y$ and $\beta x = y$, i.e., $x, \alpha \beta x$ in one orbit and $\alpha x, \beta x$ in another. This fact enables us to know the number of orbits of Ψ_L action on $\mathcal{X}_{\alpha, \beta}$ is 2. \square

If a map $M = (\mathcal{X}_{\alpha, \beta}, \mathcal{P})$ is on an orientable surface, i.e., each 1-band is type 0, then any $x \in \mathcal{X}_{\alpha, \beta}$ can be not transited to αx by the generalized traveling ruler on its edges,

i.e., the number of orbits of Ψ_L action on $\mathcal{X}_{\alpha,\beta}$ is 2. This fact enables us to introduce the orientability of map following.

Definition 5.2.2 A map $M = (\mathcal{X}_{\alpha,\beta}, \mathcal{P})$ is non-orientable if it satisfies Axiom 3 following, otherwise, orientable.

Axiom 3. The group $\Psi_L = \langle \alpha\beta, \mathcal{P} \rangle$ is transitive on $\mathcal{X}_{\alpha,\beta}$.

Definition 5.2.3 Let M be a map on a surface S . Then the genus $g(S)$ is called the genus of M , i.e.,

$$g(M) = \begin{cases} 0 & \text{if } S \sim_{EI} S^2, \\ p & \text{if } S \sim_{EI} \underbrace{T^2 \# T^2 \# \dots \# T^2}_p, \\ q & \text{if } S \sim_{EI} \underbrace{P^2 \# P^2 \# \dots \# P^2}_q. \end{cases}$$

It can be shown that the number of orbits of the group Ψ_L action on $\mathcal{X}_{\alpha,\beta} = \{x, y, z, u, v, w, \alpha x, \alpha y, \alpha z, \alpha u, \alpha v, \alpha w, \beta x, \beta y, \beta z, \beta u, \beta v, \beta w, \alpha\beta x, \alpha\beta y, \alpha\beta z, \alpha\beta u, \alpha\beta v, \alpha\beta w\}$ in Fig.5.2.2 is 2. Whence, it is an orientable map and the genus $g(M)$ satisfies

$$2 - 2g(M) = \nu(M) - \varepsilon(M) + \phi(M) = 4 - 6 + 2 = -2.$$

Thus $g(M) = 1$, i.e., M is on the torus T^2 , being the same with its geometrical meaning.

5.2.4 Standard Map. A map M is *standard* if it only possesses one vertex and one face. We show that all the standard surfaces in Chapter 4 is standard maps. From Theorem 4.2.4 we have known the standard surface presentations as follows:

- (1) The sphere $S^2 = \langle a|aa^{-1} \rangle$;
- (2) The connected sum of p tori

$$\underbrace{T^2 \# T^2 \# \dots \# T^2}_p = \left\langle a_i, b_i, 1 \leq i \leq p \mid \prod_{i=1}^p a_i b_i a_i^{-1} b_i^{-1} \right\rangle;$$

- (3) The connected sum of q projective planes

$$\underbrace{P^2 \# P^2 \dots \# P^2}_q = \left\langle a_i, 1 \leq i \leq q \mid \prod_{i=1}^q a_i \right\rangle.$$

All of these surface presentations is in fact maps, i.e.,

- (1') The sphere $O_0 = (\mathcal{X}_{\alpha,\beta}, \mathcal{P})$ with $\mathcal{X}_{\alpha,\beta}(O_0) = \{a, \alpha a, \beta a, \alpha\beta a\}$ and $\mathcal{P}(O_0) = (a, \alpha\beta a)(\alpha a, \beta)$;

(2') The connected sum of p tori $O_p = (\mathcal{X}_{\alpha,\beta}, \mathcal{P})$ with

$$\begin{aligned}\mathcal{X}_{\alpha,\beta}(O_p) &= \left(\bigcup_{i=1}^p \{a_i, \alpha a_i, \beta a_i, \alpha \beta a_i\} \right) \cup \left(\bigcup_{i=1}^p \{b_i, \alpha b_i, \beta b_i, \alpha \beta b_i\} \right), \\ \mathcal{P}(O_p) &= (a_1, b_1, \alpha \beta a_1, \alpha \beta b_1, a_2, b_2, \alpha \beta a_2, \alpha \beta b_2, \dots, a_p, b_p, \alpha \beta a_p, \alpha \beta b_p) \\ &\quad (\alpha a_1, \beta b_p, \beta a_p, \alpha b_p, \alpha a_p, \dots, \beta b_2, \beta a_2, \alpha b_2, \alpha a_2, \beta b_1, \beta a_1, \alpha b_1).\end{aligned}$$

(3') The connected sum of q projective planes $N_q = (\mathcal{X}_{\alpha,\beta}, \mathcal{P})$ with

$$\begin{aligned}\mathcal{X}_{\alpha,\beta}(N_q) &= \bigcup_{i=1}^q \{a_i, \alpha a_i, \beta a_i, \alpha \beta a_i\}, \\ \mathcal{P}(N_q) &= (a_1, \beta a_1, a_2, \beta a_2, \dots, a_p, \beta a_p)(\alpha a_1, \alpha \beta a_p, \alpha a_p, \dots, \alpha \beta a_2, \alpha a_2, \alpha \beta a_1).\end{aligned}$$

Then we know the following result.

Theorem 5.2.4 *These maps O_0 , O_p and N_q are standard maps. Furthermore,*

- (1) *The map O_p is orientable with genus $g(O_p) = p$ for integers $p \geq 0$;*
- (2) *The map N_q is non-orientable with genus $g(N_q) = q$ for integers $q \geq 1$.*

Proof Clearly, $\nu(O_p) = 1$ and $\nu(N_q) = 1$ by definition. Calculation shows that

$$\begin{aligned}\mathcal{P}(O_0)\alpha\beta &= (a, \alpha\beta a)(\alpha a, \beta a); \\ \mathcal{P}(O_p)\alpha\beta &= (a_1, \alpha\beta b_1, \alpha\beta a_1, b_1, a_2, \alpha\beta b_2, \alpha\beta a_2, b_2, \dots, a_p, \alpha\beta b_p, \alpha\beta a_p, b_p) \\ &\quad (\beta a_1, \beta b_p, \alpha a_p, \alpha b_p, \beta a_p, \dots, \beta b_2, \alpha a_2, \alpha b_2, \beta a_2, \beta b_1, \alpha a_1, \alpha b_1); \\ \mathcal{P}(N_q)\alpha\beta &= (a_1, \alpha a_1, a_2, \alpha a_2, \dots, a_q, \alpha a_q)(\beta a_1, \alpha \beta a_q, \beta a_q, \dots, \alpha \beta a_2, \beta a_2, \alpha \beta a_1).\end{aligned}$$

Therefore, there only one face in O_p and N_q . Consequently, they are standard maps for integers $p \geq 0$ and $q \geq 1$.

Obviously, the number of orbits of Ψ_L action on $\mathcal{X}_{\alpha,\beta}(O_p)$ is 2, but that on $\mathcal{X}_{\alpha,\beta}(O_p)$ is 1. Whence, O_p is orientable for integers $p \geq 0$ and N_q is non-orientable for integers $q \geq 1$. Calculation shows that the Euler-Poincaré characteristics of O_p and N_q are respective

$$\chi(O_p) = 1 - 2p + 1 \quad \text{and} \quad \chi(N_q) = 1 - q + 2.$$

Whence, $g(O_p) = p$ and $g(N_q) = q$. □

By the view of map, the standard surface presentation in Theorem 4.2.4 is nothing but the dual maps $(\mathcal{X}_{\alpha,\beta}, \mathcal{P})$ of bouquets B_{2p} , B_q on $\underbrace{T^2 \# T^2 \# \dots \# T^2}_p$ or $\underbrace{P^2 \# P^2 \# \dots \# P^2}_q$

with

$$\begin{aligned} \mathcal{P}(B_{2p}) &= (a_1, \alpha\beta b_1, \alpha\beta a_1, b_1, a_2, \alpha\beta b_2, \alpha\beta a_2, b_2, \dots, a_p, \alpha\beta b_p, \alpha\beta a_p, b_p) \\ &\quad (\beta a_1, \beta b_p, \alpha a_p, \alpha b_p, \beta a_p, \dots, \beta b_2, \alpha a_2, \alpha b_2, \beta a_2, \beta b_1, \alpha a_1, \alpha b_1); \\ \mathcal{P}(B_q) &= (a_1, \alpha a_1, a_2, \alpha a_2, \dots, a_q, \alpha a_q)(\beta a_1, \alpha\beta a_q, \beta a_q, \dots, \alpha\beta a_2, \beta a_2, \alpha\beta a_1). \end{aligned}$$

For example, we have shown this dual relation in Fig.5.2.3 for $p = 1$ and $q = 2$ following.

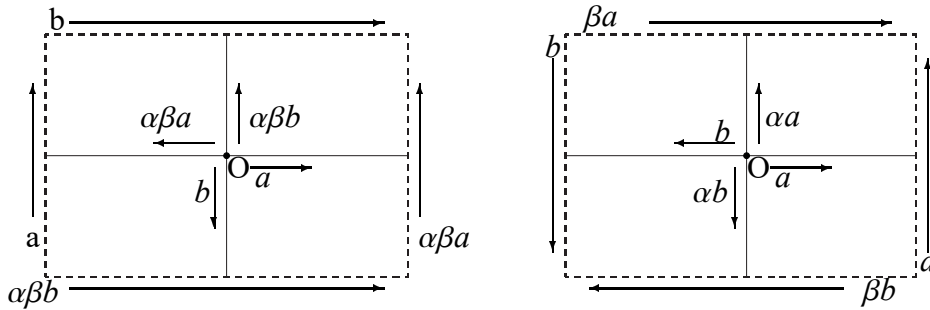

Fig.5.2.3

In fact, the embedded graph B_2 on torus and Klein bottle are maps $(\mathcal{X}_{\alpha,\beta}, \mathcal{P})$, where $\mathcal{X}_{\alpha,\beta}(B_2) = \{a, \alpha a, \beta a, \alpha\beta a, b, \alpha b, \beta b, \alpha\beta b\}$, $\mathcal{P} = (a, \alpha\beta b, \alpha\beta a, b)(\alpha a, \alpha b, \beta a, \beta b)$, $\mathcal{P}\alpha\beta = (a, b, \alpha\beta a, \alpha\beta b)(\alpha a, \beta b, \beta a, \alpha b)$ on the torus, and $\mathcal{P} = (a, \alpha a, b, \alpha b)(\beta a, \alpha\beta b, \beta b, \alpha\beta a)$, $\mathcal{P}\alpha\beta = (a, \beta a, b, \beta b)(\alpha a, \alpha\beta b, \alpha b, \alpha\beta a)$ on the Klein bottle, respectively.

§5.3 MAP GROUPS

5.3.1 Isomorphism of Maps. Let $M_1 = (\mathcal{X}_{\alpha,\beta}^1, \mathcal{P}_1)$ and $M_2 = (\mathcal{X}_{\alpha,\beta}^2, \mathcal{P}_2)$ be maps. If there exists a bijection

$$\xi : \mathcal{X}_{\alpha,\beta}^1 \rightarrow \mathcal{X}_{\alpha,\beta}^2$$

such that for $\forall x \in \mathcal{X}_{\alpha,\beta}^1$,

$$\xi\alpha(x) = \alpha\xi(x), \xi\beta(x) = \beta\xi(x) \quad \text{and} \quad \xi\mathcal{P}_1(x) = \mathcal{P}_2\xi(x).$$

Such a bijection ξ is called an *isomorphism* from maps M_1 to M_2 .

Clearly, $\xi^{-1}\alpha(y) = \alpha\xi^{-1}(y)$, $\xi^{-1}\beta(y) = \beta\xi^{-1}(y)$ and $\xi^{-1}\mathcal{P}(y) = \mathcal{P}\xi^{-1}(y)$ for $y \in \mathcal{X}_{\alpha,\beta}^2$. Thus the bijection $\xi^{-1} : \mathcal{X}_{\alpha,\beta}^2 \rightarrow \mathcal{X}_{\alpha,\beta}^1$ is an isomorphism from maps M_2 to M_1 .

Whence, we can just say such M_1 and M_2 are isomorphic without distinguishing that the isomorphism ξ is from M_1 to M_2 or from M_2 to M_1 if necessary.

Theorem 5.3.1 *Let M_1 and M_2 be isomorphic maps. Then*

- (1) M_1 is orientable if and only if M_2 is orientable;
- (2) $\nu(M_1) = \nu(M_2)$, $\varepsilon(M_1) = \varepsilon(M_2)$ and $\phi(M_1) = \phi(M_2)$, particularly, the Euler-Poincaré characteristics $\chi(M_1) = \chi(M_2)$.

Proof Let $M_1 = (\mathcal{X}_{\alpha,\beta}^1, \mathcal{P}_1)$, $M_2 = (\mathcal{X}_{\alpha,\beta}^2, \mathcal{P}_2)$, $\tau : \mathcal{X}_{\alpha,\beta}^1 \rightarrow \mathcal{X}_{\alpha,\beta}^2$ an isomorphism from M_1 to M_2 and $x_1, x_2 \in \mathcal{X}_{\alpha,\beta}^1$ such that there exists a $\sigma \in \Psi_L^1 = \langle \alpha\beta, \mathcal{P}_1 \rangle$ with $\sigma(x_1) = x_2$. Then There must be $\tau\sigma\tau^{-1}(\tau(x_1)) = \tau(x_2)$, i.e., $\tau\Psi_L^1\tau^{-1} = \langle \alpha\beta, \mathcal{P}_2 \rangle = \Psi_L^2$. Whence, Ψ_L^1 is not transitive on $\mathcal{X}_{\alpha,\beta}^1$ if and only if Ψ_L^2 is not transitive on $\mathcal{X}_{\alpha,\beta}^2$. That is the conclusion (1).

For (2), let x_1 be an element in the conjugate pair $C \cdot (\alpha C^{-1} \alpha^{-1})$ of \mathcal{P}_1 and y_1 an element in $C' \cdot (\alpha C'^{-1} \alpha^{-1})$ of \mathcal{P}_2 . It is easily know that $\tau(C \cdot (\alpha C^{-1} \alpha^{-1})) = C' \cdot (\alpha C'^{-1} \alpha^{-1})$ and $\tau(\{x_1, \alpha x_1, \beta x_1, \alpha\beta x_1\}) = \{y_1, \alpha y_1, \beta y_1, \alpha\beta y_1\}$, i.e., $\tau : Kx_1 \rightarrow Ky_1$. Whence, τ is an bijection between $V(M_1)$ and $V(M_2)$, $E(M_1)$ and $E(M_2)$. Thus $\nu(M_1) = \nu(M_2)$ and $\varepsilon(M_1) = \varepsilon(M_2)$.

By definition, we know that $\tau(\mathcal{P}_1\alpha\beta) = (\mathcal{P}_2\alpha\beta)\tau$. So similarly we know that τ is also a bijection between the vertices, i.e., faces of M_1 and M_2 . Consequently, we get that $\phi(M_1) = \phi(M_2)$. \square

For $\forall x \in \mathcal{X}_{\alpha,\beta}$, let v_x , e_x and f_x be the vertex, edge and face containing the quadricell x in a map $M = (\mathcal{X}_{\alpha,\beta}, \mathcal{P})$. The triple (v_x, e_x, f_x) is called a *fag incident with that of x* in M . Denoted by $\mathcal{F}(M)$ all fags in a map M . Then we get the following result by the proof of Theorem 5.3.1.

Corollary 5.3.1 *Let M_1 and M_2 be isomorphic maps. Then there is a bijection between fag sets $\mathcal{F}(M_1)$ and $\mathcal{F}(M_2)$.*

Theorem 5.3.2 *A map $M_1 = (\mathcal{X}_{\alpha,\beta}^1, \mathcal{P}_1)$ is isomorphic to $M_2 = (\mathcal{X}_{\alpha,\beta}^2, \mathcal{P}_2)$ if and only if the dual map $M_1^* = (\mathcal{X}_{\beta,\alpha}^1, \mathcal{P}_1\alpha\beta)$ is isomorphic to that of $M_2^* = (\mathcal{X}_{\beta,\alpha}^2, \mathcal{P}_2\alpha\beta)$.*

Proof Let $\tau : \mathcal{X}_{\alpha,\beta}^1 \rightarrow \mathcal{X}_{\alpha,\beta}^2$ be an isomorphism from M_1 to M_2 . Then $\tau\alpha = \alpha\tau$, $\tau\beta = \beta\tau$ and $\tau\mathcal{P}_1 = \mathcal{P}_2\tau$. Consequently, $\tau(\mathcal{P}_1\alpha\beta) = \mathcal{P}_2\tau(\alpha\beta) = (\mathcal{P}_2\alpha\beta)\tau$. Notice that $\mathcal{X}_{\alpha,\beta}^1 = \mathcal{X}_{\beta,\alpha}^1$ and $\mathcal{X}_{\alpha,\beta}^2 = \mathcal{X}_{\beta,\alpha}^2$. We therefore know that τ is an isomorphism between M_1^* and M_2^* . \square

Applying isomorphisms between maps, an alternative approach for determining equivalent embeddings and maps on locally orientable surfaces underlying a graph can be defined as follows:

For a given map M underlying a graph G , it is obvious that $\text{Aut}M|_G \leq \text{Aut}_{\frac{1}{2}}G$. Whence, we can extend the action of $\forall g \in \text{Aut}_{\frac{1}{2}}G$ on $V(G)$ to that of $g|_{\frac{1}{2}}$ on $\mathcal{X}_{\alpha,\beta}$ with $X = E(G)$ by defining that for $\forall x \in \mathcal{X}_{\alpha,\beta}$, if $x^g = y$, then

$$x^{g|_{\frac{1}{2}}} = y, (\alpha x)^{g|_{\frac{1}{2}}} = \alpha y, (\beta x)^{g|_{\frac{1}{2}}} = \beta y \text{ and } (\alpha\beta x)^{g|_{\frac{1}{2}}} = \alpha\beta y.$$

Then we can characterize equivalent embeddings and isomorphic maps following.

Theorem 5.3.3 *Let $M_1 = (\mathcal{X}_{\alpha,\beta}, \mathcal{P}_1)$ and $M_2 = (\mathcal{X}_{\alpha,\beta}, \mathcal{P}_2)$ be maps underlying a graph G . Then*

- (1) M_1 and M_2 are equivalent if and only if there is an element $\zeta \in \text{Aut}_{\frac{1}{2}}G$ such that $\mathcal{P}_1^\zeta = \mathcal{P}_2$.
- (2) M_1 and M_2 are isomorphic if and only if there is an element $\zeta \in \text{Aut}_{\frac{1}{2}}G$ such that $\mathcal{P}_1^\zeta = \mathcal{P}_2$ or $\mathcal{P}_1^\zeta = \mathcal{P}_2^{-1}$.

Proof Let κ be an equivalence between embeddings M_1 and M_2 . Then by definition, κ must be an isomorphism between maps M_1 and M_2 induced by an automorphism $\iota \in \text{Aut}G$. Notice that

$$\text{Aut}G \cong \text{Aut}G|_{\frac{1}{2}} \leq \text{Aut}_{\frac{1}{2}}G.$$

We know that $\iota \in \text{Aut}_{\frac{1}{2}}G$.

Now if there is a $\zeta \in \text{Aut}_{\frac{1}{2}}G$ such that $\mathcal{P}_1^\zeta = \mathcal{P}_2$, then $\forall e_x \in X_{\frac{1}{2}}(G)$, $\zeta(e_x) = \zeta(e)_{\zeta(x)}$. Assume that $e = (x, y) \in E(G)$, then by convention, we know that if $e_x = e \in \mathcal{X}_{\alpha,\beta}$, there must be $e_y = \beta e$. Now by the definition of automorphism on the semi-arc set $X_{\frac{1}{2}}(G)$, if $\zeta(e_x) = f_u$, where $f = (u, v)$, then there must be $\zeta(e_y) = f_v$. Notice that $X_{\frac{1}{2}}(G) = \mathcal{X}_\beta$. We therefore know that $\zeta(e_y) = \zeta(\beta e) = \beta f = f_v$. Now extend the action of ζ on $X_{\frac{1}{2}}(G)$ to $\mathcal{X}_{\alpha,\beta}$ by $\zeta(\alpha e) = \alpha\zeta(e)$. We get that $\forall e \in \mathcal{X}_{\alpha,\beta}$,

$$\alpha\zeta(e) = \zeta(\alpha e), \beta\zeta(e) = \zeta(\beta e) \text{ and } \mathcal{P}_1^\zeta(e) = \mathcal{P}_2(e).$$

So the extend action of ζ on $\mathcal{X}_{\alpha,\beta}$ is an isomorphism between the map M_1 and M_2 , which preserve the orientation on M_1 and M_2 . Whence, ζ is an equivalence between the map M_1 and M_2 . That is the assertion (1).

For the assertion (2), if there is an element $\zeta \in \text{Aut}_{\frac{1}{2}}G$ such that $\mathcal{P}_1^\zeta = \mathcal{P}_2$, then the map M_1 is isomorphic to M_2 . If $\mathcal{P}_1^\zeta = \mathcal{P}_2^{-1}$, then there must be $\mathcal{P}_1^{\zeta\alpha} = \mathcal{P}_2$. So M_1 is also isomorphic to M_2 . This is the sufficiency of (2).

Let ξ be an isomorphism between maps M_1 and M_2 . Then for $\forall x \in \mathcal{X}_{\alpha,\beta}$,

$$\alpha\xi(x) = \xi\alpha(x), \beta\xi(x) = \xi\beta(x) \text{ and } \mathcal{P}_1^\xi(x) = \mathcal{P}_2(x).$$

By convention, the condition

$$\beta\xi(x) = \xi\beta(x) \text{ and } \mathcal{P}_1^\xi(x) = \mathcal{P}_2(x)$$

is just the condition of an automorphism ξ or $\alpha\xi$ on $X_{\frac{1}{2}}(G)$. Whence, the assertion (2) is also true. □

5.3.2 Automorphism of Map. If $M_1 = M_2 = M$, such an isomorphism between M_1 and M_2 is called an *automorphism* of M , which surveys symmetries on a map.

Example 5.3.1 Let $M = (\mathcal{X}_{\alpha,\beta}, \mathcal{P})$ be a map with

$$\mathcal{X}_{\alpha,\beta}(B_2) = \{a, \alpha a, \beta a, \alpha\beta a, b, \alpha b, \beta b, \alpha\beta b\}$$

and

$$\mathcal{P} = (a, \alpha\beta b, \alpha\beta a, b)(\alpha a, \alpha b, \beta a, \beta b),$$

i.e., the bouquet B_2 on the torus shown in Fig.5.3.1 following.

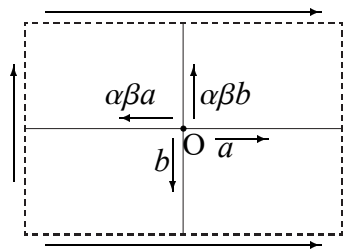

Fig.5.3.1

We determine its automorphisms following. Define

$$\begin{aligned} \tau_1 &= \begin{pmatrix} a & \alpha a & \beta a & \alpha\beta a & b & \alpha b & \beta b & \alpha\beta b \\ \alpha a & a & \alpha\beta a & \beta a & \beta b & \alpha\beta b & b & \alpha b \end{pmatrix} \\ &= (a, \alpha a)(\beta a, \alpha\beta a)(b, \beta b)(\alpha b, \alpha\beta b), \end{aligned}$$

$$\begin{aligned}
 \tau_2 &= \begin{pmatrix} a & \alpha a & \beta a & \alpha \beta a & b & \alpha b & \beta b & \alpha \beta b \\ \beta a & \alpha \beta a & a & \alpha a & \alpha b & b & \alpha \beta b & \beta b \end{pmatrix} \\
 &= (a, \beta a)(\alpha a, \alpha \beta a)(b, \alpha b)(\beta b, \alpha \beta b), \\
 \tau_3 &= \begin{pmatrix} a & \alpha a & \beta a & \alpha \beta a & b & \alpha b & \beta b & \alpha \beta b \\ \alpha \beta a & \beta a & \alpha a & a & \alpha \beta b & \beta b & \alpha b & b \end{pmatrix} \\
 &= (a, \alpha \beta a)(\alpha a, \beta a)(b, \alpha \beta b)(\alpha b, \beta b), \\
 \tau_4 &= \begin{pmatrix} a & \alpha a & \beta a & \alpha \beta a & b & \alpha b & \beta b & \alpha \beta b \\ b & \alpha b & \beta b & \alpha \beta b & \alpha \beta a & \beta a & \alpha a & a \end{pmatrix} \\
 &= (a, b, \alpha \beta a, \alpha \beta b)(\alpha a, \alpha b, \beta a, \beta b), \\
 \tau_5 &= \begin{pmatrix} a & \alpha a & \beta a & \alpha \beta a & b & \alpha b & \beta b & \alpha \beta b \\ \alpha b & b & \alpha \beta b & \beta b & \alpha a & a & \alpha \beta a & \beta a \end{pmatrix} \\
 &= (a, \alpha b)(\alpha a, b)(\beta a, \alpha \beta b)(\alpha \beta a, \beta b), \\
 \tau_6 &= \begin{pmatrix} a & \alpha a & \beta a & \alpha \beta a & b & \alpha b & \beta b & \alpha \beta b \\ \beta b & \alpha \beta b & b & \alpha b & \beta a & \alpha \beta a & a & \alpha a \end{pmatrix} \\
 &= (a, \beta b)(\alpha a, \alpha \beta b)(\beta a, b)(\alpha \beta a, \alpha b), \\
 \tau_7 &= \begin{pmatrix} a & \alpha a & \beta a & \alpha \beta a & b & \alpha b & \beta b & \alpha \beta b \\ \alpha \beta b & \beta b & \alpha b & b & a & \alpha a & \beta a & \alpha \beta a \end{pmatrix} \\
 &= (a, \alpha \beta b, \alpha \beta a, b)(\alpha a, \beta b, \beta a, \alpha b).
 \end{aligned}$$

We are easily to verify that these permutations $1_{\mathcal{X}_{\alpha, \beta}}, \tau_i, 1 \leq i \leq 7$ are automorphisms of the map M shown in Fig.5.3.1.

Theorem 5.3.4 *All automorphisms of a map $M = (\mathcal{X}_{\alpha, \beta}, \mathcal{P})$ form a group.*

Proof Let τ, τ_1 and τ_2 be automorphisms of M . Then we know that $\tau\alpha = \alpha\tau, \tau\beta = \beta\tau, \tau\mathcal{P} = \mathcal{P}\tau$ and $\tau_1\alpha = \alpha\tau_1, \tau_1\beta = \beta\tau_1, \tau_1\mathcal{P} = \mathcal{P}\tau_1$. Clearly, $1_{\mathcal{X}_{\alpha, \beta}}$ is an automorphism of M and $\tau^{-1}\alpha = \alpha\tau^{-1}, \tau^{-1}\beta = \beta\tau^{-1}, \tau^{-1}\mathcal{P} = \mathcal{P}\tau^{-1}$, i.e., τ^{-1} is an automorphism of M . Furthermore, it is easily to know that

$$(\tau\tau_1)\alpha = \alpha(\tau\tau_1), (\tau\tau_1)\beta = \beta(\tau\tau_1) \text{ and } (\tau\tau_1)\mathcal{P} = \mathcal{P}(\tau\tau_1),$$

i.e., $\tau\tau_1$ is also an automorphism of M with

$$x^{(\tau\tau_1)\tau_2} = x^{\tau(\tau_1\tau_2)}$$

for $\forall x \in \mathcal{X}_{\alpha, \beta}$, i.e., $(\tau\tau_1)\tau_2 = \tau(\tau_1\tau_2)$. So all automorphisms form a group by definition. \square

Such a group formed by all automorphisms of a map M is called the *automorphism group* of M , denoted by $\text{Aut}M$ and any subgroup Γ of automorphism groups of maps is called a *map group*.

Theorem 5.3.5 *Any map group Γ is fixed-free.*

Proof Let $M = (\mathcal{X}_{\alpha,\beta}, \mathcal{P})$ be a map, $x \in \mathcal{X}_{\alpha,\beta}$ and $\Gamma \leq \text{Aut}M$. If $x^\sigma = x$, we prove that

$$\sigma = 1_{\mathcal{X}_{\alpha,\beta}}.$$

In fact, for $\forall y \in \mathcal{X}_{\alpha,\beta}$, by definition $\Psi_J = \langle \alpha, \beta, \mathcal{P} \rangle$ is transitive on $\mathcal{X}_{\alpha,\beta}$, there exists an element $h \in \Psi_J$ such that $x^h = y$. Hence,

$$y^\sigma = x^{\sigma h} = x^{h\sigma} = x^h = y,$$

i.e., σ fixes all elements in $\mathcal{X}_{\alpha,\beta}$. □

For a group $(\Gamma; \circ)$, denoted by $Z_\Gamma(H) = \{ g \in \Gamma \mid g \circ h \circ g^{-1} = h, \forall h \in H \}$ the centralizer of H in $(\Gamma; \circ)$ for $H \leq \Gamma$. Then we are easily to get the following result for automorphism group of map.

Theorem 5.3.6 *Let $M = (\mathcal{X}_{\alpha,\beta}, \mathcal{P})$ be a map. Then $\text{Aut}M = Z_{S_{\mathcal{X}_{\alpha,\beta}}}(\langle \alpha, \beta, \mathcal{P} \rangle)$, where $S_{\mathcal{X}_{\alpha,\beta}}$ is the symmetric group on $\mathcal{X}_{\alpha,\beta}$.*

Proof Let $\forall \tau \in \text{Aut}M$ be an automorphism. Then we know that $\tau\alpha = \alpha\tau$, $\tau\beta = \beta\tau$ and $\tau\mathcal{P} = \mathcal{P}\tau$ by definition. Whence, $\tau \in Z_{S_{\mathcal{X}_{\alpha,\beta}}}(\langle \alpha, \beta, \mathcal{P} \rangle)$. Conversely, for $\sigma \in Z_{S_{\mathcal{X}_{\alpha,\beta}}}(\langle \alpha, \beta, \mathcal{P} \rangle)$, It is clear that $\sigma\alpha = \alpha\sigma$, $\sigma\beta = \beta\sigma$ and $\sigma\mathcal{P} = \mathcal{P}\sigma$ by definition. □

A characterizing for automorphism group of map can be found in the following.

Theorem 5.3.7 *Let $M = (\mathcal{X}_{\alpha,\beta}, \mathcal{P})$ be a map with $A = \text{Aut}M$ and $v \in V(M)$. Then the stabilizer A_v is isomorphic to a subgroup $H \leq \langle \overline{C}_v \rangle$ generated by $\overline{C}_v = C_v \cdot \alpha C_v^{-1} \alpha^{-1}$, i.e., a product of conjugate pair of cycles in \mathcal{P} .*

Proof By Theorem 2.1.1, if $g \in A_v$, we know that $g\overline{C}_v g^{-1} = \overline{C}_{g(v)} = \overline{C}_v$. That is $g\overline{C}_v = \overline{C}_v g$. Whence, if w is a quadricell in \overline{C}_v , then $g(w)$ is also so. Denote the constraint action of an automorphism $g \in A_v$ on elements in \overline{C}_v by \overline{g} . Notice that \overline{C}_v is a product of conjugate pairs of cycles in \mathcal{P} . There must be an integer i such that $\overline{g}(w) = \overline{C}_v^i$. Choose $x = \overline{C}_v^j(w)$ be a quadricell in \overline{C}_v . Then

$$\overline{g}(x) = \overline{g}\overline{C}_v^i(w) = \overline{C}_v^{i+j}(w) = \overline{C}_v^i(x).$$

Whence, $\bar{g} = \bar{C}_v^i$. Define a homomorphism $\theta : A_v \rightarrow \langle \bar{C}_v \rangle$ by $\theta(a) = \bar{g}$ for $\forall g \in A_v$. Then it is also a monomorphism by Theorem 5.3.5. Thus A_v is isomorphic to a subgroup $H \leq \langle \bar{C}_v \rangle$. \square

Applying isomorphisms between maps, similar to that of Theorem 5.3.3 we can also characterize automorphisms of a map by extended actions of semi-arc automorphisms of its underlying graph following.

Theorem 5.3.8 *Let $M = (\mathcal{X}_{\alpha,\beta}, \mathcal{P})$ be a map underlying graph G , $g \in \text{Aut}_{\frac{1}{2}}G$. Then the extend action $g^{\frac{1}{2}}$ of g on $\mathcal{X}_{\alpha,\beta}$ with $X = E(G)$ is an automorphism of map M if and only if $\forall v \in V(M)$, $g^{\frac{1}{2}}$ preserves the cyclic order of v .*

Proof Let $g^{\frac{1}{2}} \in \text{Aut}M$ be extended by $g \in \text{Aut}_{\frac{1}{2}}G$ with $u^g = v$ for $u, v \in V(M)$. Let

$$\begin{aligned} u &= (x_1, x_2, \dots, x_{\rho(u)})(\alpha x_{\rho(u)}, \dots, \alpha x_2, \alpha x_1), \\ v &= (y_1, y_2, \dots, y_{\rho(v)})(\alpha y_{\rho(v)}, \dots, \alpha y_2, \alpha y_1). \end{aligned}$$

Then there must be

$$\begin{aligned} (x_1, x_2, \dots, x_{\rho(u)})^{g^{\frac{1}{2}}} &= (y_1, y_2, \dots, y_{\rho(v)}) \quad \text{or} \\ (x_1, x_2, \dots, x_{\rho(u)})^{g^{\frac{1}{2}}} &= (\alpha y_{\rho(v)}, \dots, \alpha y_2, \alpha y_1). \end{aligned}$$

Without loss of generality, we assume that $(x_1, x_2, \dots, x_{\rho(u)})^{g^{\frac{1}{2}}} = (y_1, y_2, \dots, y_{\rho(v)})$. Thus,

$$(g^{\frac{1}{2}}(x_1), g^{\frac{1}{2}}(x_2), \dots, g^{\frac{1}{2}}(x_{\rho(u)})) = (y_1, y_2, \dots, y_{\rho(v)}).$$

Whence, $g^{\frac{1}{2}}$ preserves the cyclic order of vertices in the map M .

Conversely, if the extend action $g^{\frac{1}{2}}$ of $g \in \text{Aut}_{\frac{1}{2}}G$ on $\mathcal{X}_{\alpha,\beta}$ preserves the cyclic order of each vertex in M , i.e., $\forall u \in V(G)$, $\exists v \in V(G)$ such that $u^{g^{\frac{1}{2}}} = v$. Let

$$\mathcal{P} = \prod_{u \in V(M)} u.$$

Then

$$\mathcal{P}^{g^{\frac{1}{2}}} = \prod_{u \in V(M)} u^{g^{\frac{1}{2}}} = \prod_{v \in V(M)} v = \mathcal{P}.$$

Whence, the extend action $g^{\frac{1}{2}}$ is an automorphism of map M . \square

Combining Corollary 5.3.1 and Theorem 5.3.5 enables us to get the following result.

Theorem 5.3.9 Let $M = (\mathcal{X}_{\alpha,\beta}, \beta)$ be a map with v_i of vertices and ϕ_i faces of valency i , $i \geq 1$. Then

$$|\text{Aut}M| \mid (2iv_i, 2j\phi_j; i \geq 1, j \geq 1),$$

where $(2iv_i, 2j\phi_j; i \geq 1, j \geq 1)$ denotes the greatest common divisor of $2iv_i, 2j\phi_j$ for an integer pair $i, j \geq 1$.

Proof Let Λ_i and Δ_j respectively be the sets of quadricells incident with a vertex of valency i or incident with a face of valency j for integers $i, j \geq 1$. Consider the action of $\text{Aut}M$ on Λ_i and Δ_j . By Corollary 5.3.1, such an action is closed in Λ_i or Δ_j . Then applying Theorem 2.1.1(3), we know that

$$|\text{Aut}M| = |(\text{Aut}M)_x| |x^{\text{Aut}M}| = |x^{\text{Aut}M}|$$

for $\forall x \in \Lambda_i$ for $|(\text{Aut}M)_x| = 1$ by Theorem 5.3.5. Therefore, the length of each orbit of $\text{Aut}M$ action on Λ_i or Δ_j is the same $|\text{Aut}M|$. Notice that $|\Lambda_i| = 2iv_i$ and $|\Delta_j| = 2j\phi_j$. We get that

$$|\text{Aut}M| \mid |\Lambda_i| = 2iv_i \quad \text{and} \quad |\text{Aut}M| \mid |\Delta_j| = 2j\phi_j$$

for any integer pairs $i, j \geq 1$. Thus

$$|\text{Aut}M| \mid (2iv_i, 2j\phi_j; i \geq 1, j \geq 1). \quad \square$$

Corollary 5.3.2 Let $M = (\mathcal{X}_{\alpha,\beta}, \mathcal{P})$ be a map with vertex valency k and face valency l . Then $|\text{Aut}M| \mid (2k|M|, 2l|M^*|)$, where M^* is the dual of M . Particularly, $|\text{Aut}O_p| \mid 2p$ and $|\text{Aut}O_p| \mid 2p$ for standard maps O_p and N_q .

By Theorem 5.3.9, we can get automorphism groups $\text{Aut}M$ of map M in sometimes.

Example 5.3.2 Let $M = (\mathcal{X}_{\alpha,\beta}, \mathcal{P})$ be the map shown in Fig.5.2.2, i.e., K_4 on torus with one face length 4 and another 8. By Theorem 5.3.9, there must be $|\text{Aut}M| \mid (4 \times 3, 8, 4) = 4$, i.e., $|\text{Aut}M| \leq 4$. Define

$$\begin{aligned} \sigma_1 = & (x, \alpha x)(\beta x, \alpha \beta x)(y, \alpha z)(\alpha y, z)(\beta z, \alpha \beta z)(\alpha \beta z, \beta y) \\ & (v, \beta v)(\alpha v, \alpha \beta v)(u, \alpha w)(\alpha u, w)(\beta u, \alpha \beta w)(\alpha \beta u, \beta w) \end{aligned}$$

and

$$\begin{aligned} \sigma_2 = & (x, \beta x)(\alpha x, \alpha \beta x)(y, \alpha w)(\alpha y, w)(\beta y, \alpha \beta w)(\alpha \beta y, \beta w) \\ & (v, \alpha v)(\beta v, \alpha \beta v)(z, \alpha u)(\alpha z, u)(\beta z, \alpha \beta u)(\alpha \beta z, \beta u). \end{aligned}$$

It can be verified that σ_1 and σ_2 both are automorphisms of M and $\sigma_1^2 = 1_{\mathcal{X}_{\alpha,\beta}}$ and $\sigma_2^2 = 1_{\mathcal{X}_{\alpha,\beta}}$. So $\text{Aut}M = \langle \sigma_1, \sigma_2 \rangle$.

Example 5.3.3 We have constructed automorphisms $1_{\mathcal{X}_{\alpha,\beta}}$ and τ_i , $1 \leq i \leq 7$ for the map shown in Fig.5.3.1 in Example 5.3.1. Consequently, we get that

$$\text{Aut}M = \{1_{\mathcal{X}_{\alpha,\beta}}, \tau_1, \tau_2, \tau_3, \tau_4, \tau_5, \tau_6, \tau_7\}$$

by Corollary 5.3.2.

Notice that

$$2 \sum_{i \geq 1} iv_i = 2 \sum_{i \geq 1} i\phi_i = |\mathcal{X}_{\alpha,\beta}|$$

for a map $M = (\mathcal{X}_{\alpha,\beta}, \mathcal{P})$. Therefore, we get the following conclusion.

Corollary 5.3.3 For any map $M = (\mathcal{X}_{\alpha,\beta}, \mathcal{P})$, $|\text{Aut}M| \mid |\mathcal{X}_{\alpha,\beta}| = 4\varepsilon(M)$.

Proof Applying Theorem 5.3.9, we know that

$$|\text{Aut}M| \mid \sum_{i \geq 1} 2iv_i \quad \text{and} \quad |\text{Aut}M| \mid \sum_{i \geq 1} 2i\phi_i.$$

Because of

$$2 \sum_{i \geq 1} iv_i = 2 \sum_{i \geq 1} i\phi_i = |\mathcal{X}_{\alpha,\beta}|,$$

we immediately get that $|\text{Aut}M| \mid |\mathcal{X}_{\alpha,\beta}| = 4\varepsilon(M)$. □

Now we determine automorphisms of standard maps on surfaces.

Theorem 5.3.10 Let $O_p = (\mathcal{X}_{\alpha,\beta}(O_p), \mathcal{P}(O_p))$ be an orientable standard map with

$$\begin{aligned} \mathcal{X}_{\alpha,\beta}(O_p) &= \left(\bigcup_{i=1}^p \{a_i, \alpha a_i, \beta a_i, \alpha \beta a_i\} \right) \cup \left(\bigcup_{i=1}^p \{b_i, \alpha b_i, \beta b_i, \alpha \beta b_i\} \right), \\ \mathcal{P}(O_p) &= (a_1, b_1, \alpha \beta a_1, \alpha \beta b_1, a_2, b_2, \alpha \beta a_2, \alpha \beta b_2, \dots, a_p, b_p, \alpha \beta a_p, \alpha \beta b_p) \\ &\quad (\alpha a_1, \beta b_p, \beta a_p, \alpha b_p, \alpha a_p, \dots, \beta b_2, \beta a_2, \alpha b_2, \alpha a_2, \beta b_1, \beta a_1, \alpha b_1). \end{aligned}$$

and let $N_q = (\mathcal{X}_{\alpha,\beta}, \mathcal{P})$ be a non-orientable map with

$$\begin{aligned} \mathcal{X}_{\alpha,\beta}(N_q) &= \bigcup_{i=1}^p \{a_i, \alpha a_i, \beta a_i, \alpha \beta a_i\}, \\ \mathcal{P}(N_q) &= (a_1, \beta a_1, a_2, \beta a_2, \dots, a_p, \beta a_p)(\alpha a_1, \alpha \beta a_p, \alpha a_p, \dots, \alpha \beta a_2, \alpha a_2, \alpha \beta a_1). \end{aligned}$$

Define

$$\begin{aligned}\tau_s &= \mathcal{P}^{4s}(O_p), \quad 0 \leq s \leq p-1, \\ \sigma &= \prod_{i=1}^p (a_i, \alpha a_i)(b_i, \beta b_i)(\alpha \beta a_i, \beta a_i)(\alpha \beta b_i, \alpha b_i), \\ \theta &= \prod_{i=1}^p (a_i, \alpha \beta b_i)(\alpha a_i, \beta b_i), \quad \zeta = \prod_{i=1}^p (a_i, \alpha \beta a_i)(b_i, \alpha \beta b_i)\end{aligned}$$

and

$$\eta_l = \mathcal{P}^{2l}(N_q), \quad 0 \leq l \leq q-1; \quad \vartheta = \prod_{i=1}^q (a_i, \alpha \beta a_i)(\alpha a_i, \beta a_i).$$

Then

$$\text{Aut}O_p = \langle \theta, \sigma, \zeta, \tau_s, 1 \leq s \leq p-1 \rangle \quad \text{and} \quad \text{Aut}N_q \geq \langle \vartheta, \eta_l, 1 \leq l \leq q-1 \rangle.$$

Proof It is easily to verify that $x\alpha = \alpha x$, $x\beta = \beta x$, $x\mathcal{P}(O_p) = \mathcal{P}(O_p)x$ if $x \in \{\theta, \sigma, \zeta, \tau_s, 1 \leq s \leq p-1\}$ and $y\alpha = \alpha y$, $y\beta = \beta y$, $y\mathcal{P}(N_q) = \mathcal{P}(N_q)y$ if $y \in \{\vartheta, \eta_l, 1 \leq l \leq q-1\}$. Thus $\text{Aut}O_p \geq \langle \theta, \sigma, \zeta, \tau_s, 1 \leq s \leq p-1 \rangle$ and $\text{Aut}N_q \geq \langle \vartheta, \eta_l, 1 \leq l \leq q-1 \rangle$. Notice that $|\langle \theta, \sigma, \zeta, \tau_s, 1 \leq s \leq p-1 \rangle| = 8p = |\mathcal{X}_{\alpha, \beta}(O_p)|$. Applying Corollary 5.3.3, $\text{Aut}O_p = \langle \theta, \sigma, \zeta, \tau_s, 1 \leq s \leq p-1 \rangle$ is followed. \square

5.3.3 Combinatorial Model of Klein Surface. For a complex algebraic curve, a very important problem is to determine its birational automorphisms. For curve C of genus $g \geq 2$, Schwarz proved that $\text{Aut}(C)$ is finite in 1879 and then Hurwitz proved $|\text{Aut}(C)| \leq 84(g-1)$, seeing [FaK1] for details. As observed by Riemann, the groups of birational automorphisms of complex algebraic curves are the same as the automorphism groups of compact Riemann surfaces which can be combinatorially dealt with the approach of maps on surfaces. Jones and Singerman proved the following result in [JoS1].

Theorem 5.3.11 *If M is an orientable map of genus p , then $\text{Aut}M$ is isomorphic to a group of conformal transformations of a Riemann surface.*

Notice that the automorphism group of Klein surface possesses the same representation as that of Riemann surface by Theorem 4.5.7. This enables us to get a result likely for Klein surfaces following.

Theorem 5.3.12 *If M is a locally orientable map on a Klein surface S , then $\text{Aut}M$ is isomorphic to a group of conformal transformations of a Klein surface, particularly, $\text{Aut}M \leq \text{Aut}S$.*

Proof According to Theorem 4.5.7, there exists a NEC group Γ such that $\text{Aut}S \simeq N_\Omega(\Gamma)/\Gamma$, where $\Omega = \text{Aut}H = PGL(2, \mathbb{R})$ being the automorphism group of the upper half plane H . Because M is embeddable on Klein surface S , so there is a fundamental region F , a polygon in H such that $\{gF|g \in \Gamma\}$ is a tessellation of H , i.e., S is homeomorphic to H/Γ . By Constructions 4.4.1-4.4.2, we therefore know that $\text{Aut}M \leq N_\Omega(\Gamma)/\Gamma$, i.e., $\text{Aut}M$ is a subgroup of conformal transformation of Klein surface S . \square

§5.4 REGULAR MAPS

5.4.1 Regular Map. A regular map $M = (\mathcal{X}_{\alpha,\beta}, \mathcal{P})$ is such a map that its automorphism group $\text{Aut}M$ is transitive on $\mathcal{X}_{\alpha,\beta}$, i.e., $|\text{Aut}M| = 4\varepsilon(M)$. For example, the map discussed in Example 5.3.2 is such a regular map, but that map in Example 5.3.1 is not.

If M is regular, then $\text{Aut}M$ is transitive on vertices, edges and faces of M by Corollary 5.3.1. This fact enables us to get the following result.

Theorem 5.4.1 *Let M be a regular map with vertex valency $k \geq 3$ and face valency $l \geq 3$, called a type (k, l) regular maps. Then $k\nu(M) = l\phi(M) = 2\varepsilon(M)$ and*

$$g(M) = \begin{cases} 1 + \left(\frac{(k-2)(l-2) - 4}{4l} \right) \nu(M), & \text{if } M \text{ is orientable;} \\ 2 + \left(\frac{(k-2)(l-2) - 4}{2l} \right) \nu(M), & \text{if } M \text{ is non-orientable.} \end{cases}$$

Proof Let $\nu_k = \nu(M)$, $\phi_l = \phi(M)$ and $\nu_i = \phi_j = 0$ if $i \neq k$, $j \neq l$ in the equalities

$$2 \sum_{i \geq 1} i\nu_i = 2 \sum_{i \geq 1} i\phi_i = |\mathcal{X}_{\alpha,\beta}| = 4\varepsilon(M),$$

we immediately get that $k\nu(M) = l\phi(M) = 2\varepsilon(M)$.

Substitute $\varepsilon(M) = \frac{k}{2}\nu(M)$ and $\phi(M) = \frac{k}{l}\nu(M)$ in the Euler-Poincaré genus formulae

$$g(M) = \begin{cases} \frac{2 + \varepsilon(M) - \nu(M) - \phi(M)}{2}, & \text{if } M \text{ is orientable} \\ 2 + \varepsilon(M) - \nu(M) - \phi(M), & \text{if } M \text{ is non-orientable.} \end{cases}$$

We get that

$$g(M) = \begin{cases} 1 + \left(\frac{(k-2)(l-2) - 4}{4l} \right) \nu(M), & \text{if } M \text{ is orientable;} \\ 2 + \left(\frac{(k-2)(l-2) - 4}{2l} \right) \nu(M), & \text{if } M \text{ is non-orientable.} \end{cases} \quad \square$$

This theorem enables us to find type (k, l) regular maps on orientable or non-orientable surfaces with small genus following.

Corollary 5.4.1 *A map M is regular of $g(M) = 0$ if and only if $G(M) = C_l$, $l \geq 1$ or the 1-skeleton of the five Platonic solids.*

Proof If $k = 2$ then $v(M) = \varepsilon(M) = l$ and $\phi(M) = 2$. Whence, M is a map underlying a circuit C_l on the sphere. Indeed, such a map M is regular by the fact $\text{Aut}M = \langle \rho, \alpha \rangle$, where ρ is the rotation about the center of C_l through angles $2\pi/l$ from a chosen vertex $u_0 \in V(C_l)$ with $\rho^l = 1_{\mathcal{X}_{\alpha, \beta}}$.

Let $k \geq 3$. Then by Theorem 5.4.1, we get that

$$1 + \left(\frac{(k-2)(l-2) - 4}{4l} \right) v(M) = 0, \quad \text{i.e., } (k-2)(l-2) < 4$$

by Theorem 5.4.1, i.e., $(k, l) = (3, 3), (3, 4), (3, 5), (4, 3), (5, 3)$, which are just the Platonic solids shown in Fig.5.4.1 following. \square

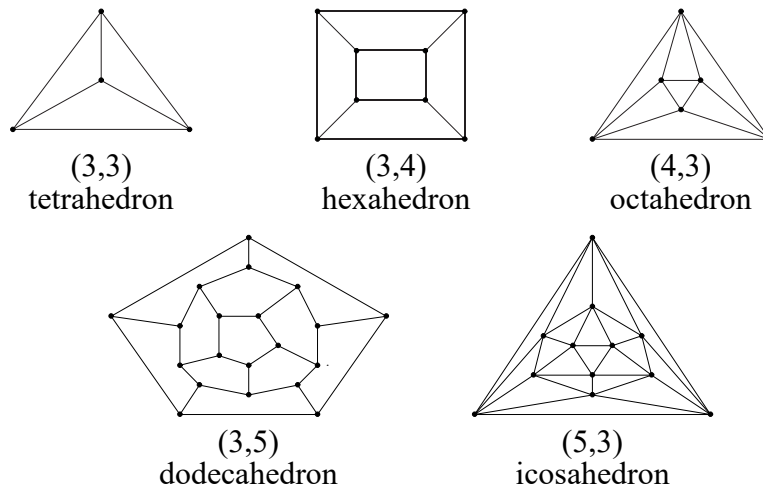

Fig.5.4.1

Corollary 5.4.2 *There are infinite regular maps M of torus T^2 .*

Proof In this case, we get $(k-2)(l-2) = 4$ by Theorem 5.4.1. Whence, $(k, l) = (3, 6), (4, 4), (6, 3)$. Indeed, there exist regular maps on torus for such integer pairs. For regular map on torus with $(3, 6)$ or $(4, 4)$, see (a) or (b) in Fig.5.4.2. It should be noted that the regular map on torus with $(6, 3)$ is just the dual that of $(3, 6)$ and we can construct such regular maps of order $6s$ or $4s$ for integer $s \geq 1$. So there are infinite many such

regular maps on torus. □

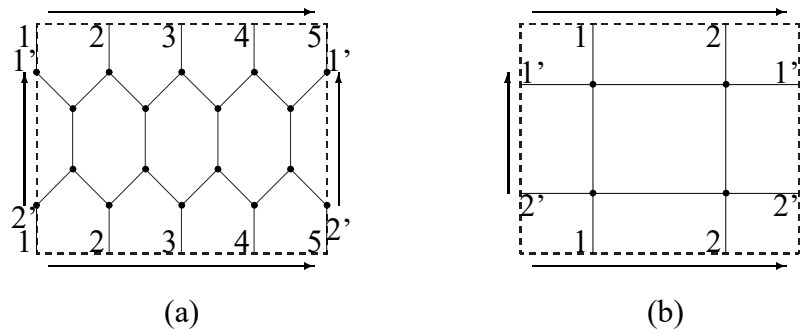

Fig.5.4.2

Corollary 5.4.3 *There are finite regular maps on projective plane P^2 with vertex valency ≥ 3 and face valency ≥ 3 .*

Proof Similarly, we know that $(k - 2)(l - 2) < 4$ by Theorem 5.4.1, i.e., the possible types of M are $(3, 3)$, $(3, 4)$, $(4, 3)$, $(5, 3)$, $(5, 3)$ and it can be verified easily that there are no $(3, 3)$ regular maps on P^2 . Calculation shows that

(k, l)	$\nu(M)$	$\varepsilon(M)$	$G(M)$ Existing?	M Existing?
$(3, 3)$	2	3	Yes	No
$(3, 4)$	4	6	Yes	Yes
$(4, 3)$	3	6	Yes	Yes
$(3, 5)$	10	15	Yes	Yes
$(5, 3)$	6	15	Yes	Yes

Therefore, regular maps on projective plane P^2 with vertex valency ≥ 3 and face valency ≥ 3 is finite. The regular maps of types $((3, 5))$ and $(3, 4)$ are shown in Fig.5.4.3. □

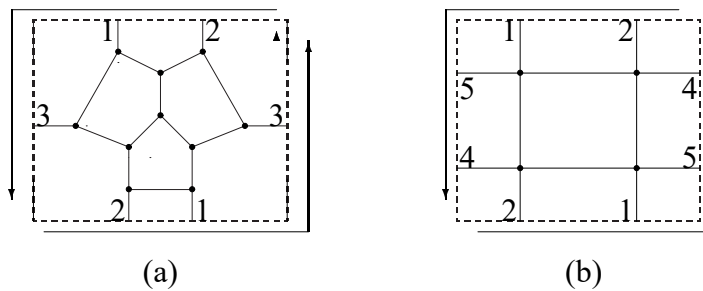

Fig.5.4.3

The following result approves the existence of regular maps on every orientable surface.

Theorem 5.4.2 *For any integer $p \geq 0$, there are regular maps on every orientable surface of genus p .*

Proof Applying Theorem 5.3.10, the standard map O_p is regular on the orientable surface of genus p . Combining the result in Corollary 5.4.1, we get the conclusion. \square

Notice that Theorem 4.5.2 has claimed that the automorphism group of a Klein surface is finite. In fact, by Theorem 5.4.1, we can also determine the upper bound of $|\text{Aut}M|$ for regular maps M on a surface of genus $g \geq 2$.

Theorem 5.4.3 *Let M be a regular map on a surface S of genus $g \geq 2$ with vertex valency $k \geq 3$ and face valency $l \geq 3$. Then*

$$|\text{Aut}M| \leq \begin{cases} 168(g-1), & \text{if } S \text{ is orientable,} \\ 84(g-1), & \text{if } S \text{ is non-orientable.} \end{cases}$$

and with the equality holds if and only if $(k, l) = (3, 7)$ or $(7, 3)$.

Proof By definition, a map $M = (\mathcal{X}_{\alpha, \beta}, \mathcal{P})$ on S is regular if and only if $|\text{Aut}M| = |\mathcal{X}_{\alpha, \beta}| = 4\varepsilon(M)$. Substitute $\nu(M) = \frac{2}{k}\varepsilon(M)$ in Theorem 5.4.1, we get that

$$|\text{Aut}M| = \begin{cases} \left(\frac{8kl}{(k-2)(l-2)-4} \right) (g-1), & \text{if } S \text{ is orientable,} \\ \left(\frac{4kl}{(k-2)(l-2)-4} \right) (g-1), & \text{if } S \text{ is non-orientable.} \end{cases}$$

Clearly, the maximum value of $\frac{kl}{(k-2)(l-2)-4}$ is 21 occurring precisely at $(k, l) = (3, 7)$ or $(7, 3)$. Therefore,

$$|\text{Aut}M| \leq \begin{cases} 168(g-1), & \text{if } S \text{ is orientable,} \\ 84(g-1), & \text{if } S \text{ is non-orientable.} \end{cases}$$

and with the equality holds if and only if $(k, l) = (3, 7)$ or $(7, 3)$. \square

5.4.2 Map NEC-Group. We have known that $\Psi_J = \langle \alpha, \beta, \mathcal{P} \rangle$ acts transitively on $\mathcal{X}_{\alpha, \beta}$, i.e., $x^{\Psi_J} = \mathcal{X}_{\alpha, \beta}$. Furthermore, if M is regular, then its vertex valency and face valency both are constant, say n and m . Usually, such a regular map M is called with type (n, m) . Then we get the presentation of Ψ_J for M following

$$\Psi_J = \left\langle \alpha, \beta, \mathcal{P} \mid \alpha^2 = \beta^2 = \mathcal{P}^n = (\mathcal{P}\alpha\beta)^m = 1_{\mathcal{X}_{\alpha, \beta}} \right\rangle.$$

We regard relations of the form $\mathcal{P}^\infty = 1_{\mathcal{X}_{\alpha,\beta}}$ or $(\mathcal{P}\alpha\beta)^\infty = 1_{\mathcal{X}_{\alpha,\beta}}$ as vacuous. The free group $\tilde{\Psi}$ generated by $\alpha, \beta, \mathcal{P}$, i.e., $\tilde{\Psi} = \langle \alpha, \beta, \mathcal{P} \rangle$ is called the *universal map* of M , a tessellation of planar Klein surface H . It should be note that Ψ_J is isomorphic to the NEC group generated by facial boundaries of M . Whence, $M \simeq H/x^{\Psi_J} = x^{\tilde{\Psi}}/x^{\Psi_J} \simeq \tilde{\Psi}/\Psi_J$, where x is a chosen point in H . Applying Theorem 4.5.9, we get the following result.

Theorem 5.4.4 *Let $M = (\mathcal{X}_{\alpha,\beta})$ be a regular map on a Klein surface S . Then $\text{Aut}M \simeq N_{\tilde{\Psi}}(\Psi_J)/\Psi_J$, where $N_{\tilde{\Psi}}(\Psi_J)$ is the normalizer of Ψ_J in $\tilde{\Psi}$.*

This result will be applied for constructing regular maps on surfaces in Section 5.5.

5.4.3 Cayley Map. Let $(\Gamma; \circ)$ be a finite group generated by S . A *Cayley map* of Γ to S with $1_\Gamma \notin S$ and $S^{-1} = S$, denoted by $\text{Cay}^M(\Gamma : S, r)$ is a map $(\mathcal{X}_{\alpha,\beta}(\Gamma : S), \mathcal{P}(\Gamma : S))$, where

$$\begin{aligned} \mathcal{X}_{\alpha,\beta}(\Gamma : S, r) &= \{ g_h, \alpha g_h, \beta g_h, \alpha\beta g_h \mid g \in \Gamma, h \in S \text{ and } g^{-1} \circ h \in S \}, \\ \mathcal{P}(\Gamma : S, r) &= \prod_{g \in \Gamma, h \in S} (g_h, g_{r(h)}, g_{r^2(h)}, \dots)(\alpha g_h, \alpha g_{r^{-1}(h)}, \alpha g_{r^{-2}(h)}, \dots) \end{aligned}$$

with $\tau\alpha g_h = \alpha\tau g_h$, $\tau\beta g_h = \beta\tau g_h$ for $\tau \in \Gamma$, where $r : S \rightarrow S$ is a cyclic permutation. Clearly, the underlying graph of a Cayley map $\text{Cay}^M(\Gamma : S, r)$ is $\text{Cay}(\Gamma : S)$.

Example 5.4.1 Let $(\Gamma; \circ)$ be the Klein group $\Gamma = \{1, \alpha, \beta, \alpha\beta\}$, $S = \{\alpha, \beta, \alpha\beta\}$ and $r = (\alpha, \beta, \alpha\beta)$. Then the Cayley map $\text{Cay}^M(\Gamma : S, r)$ is K_4 on the plane shown in Fig.5.4.4.

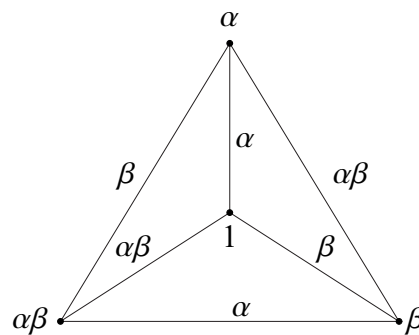

Fig.5.4.4

Theorem 5.4.5 *Any Cayley map $\text{Cay}^M(\Gamma : S, r)$ is vertex-transitive. In fact, there is a regular subgroup of $\text{AutCay}^M(\Gamma : S, r)$ isomorphic to Γ .*

Proof Consider the action of left multiplication L_Γ on vertices of $\text{Cay}^M(\Gamma : S, r)$,

i.e., $L_\sigma : h \rightarrow g \circ h$ for $g, h \in \Gamma$. We have known it is transitive on vertices of Cayley graph $\text{Cay}(\Gamma : S)$ by Theorem 3.2.1. It only remains to show that such a permutation L_g is a map automorphism of $\text{Cay}^M(\Gamma : S, r)$. In fact, for $g_h \in \mathcal{X}_{\alpha,\beta}(\Gamma : S, r)$ we know $L_\sigma \alpha g_h = \sigma \alpha g_h = \alpha \sigma g_h = \alpha L_\sigma g_h$ i.e., $L_\sigma \alpha = \alpha L_\sigma$ by definition. Similarly, $L_\sigma \beta = \beta L_\sigma$.

Notice that if $g^{-1} \circ h \in S$, then $(\sigma \circ g)^{-1} \circ (\sigma \circ h) = g^{-1} \circ h \in S$, i.e., $(L_\sigma(g))_{L_\sigma(h)} \in \mathcal{X}_{\alpha,\beta}(\Gamma : S, r)$. Calculation shows that

$$\begin{aligned} & L_\sigma \mathcal{P}(\Gamma : S, r) L_\sigma^{-1} \\ &= L_\sigma \prod_{g \in \Gamma, g^{-1} \circ h \in S} (g_h, g_{r(h)}, g_{r^2(h)}, \dots)(\alpha g_h, \alpha g_{r^{-1}(h)}, \alpha g_{r^{-2}(h)}, \dots) L_\sigma^{-1} \\ &= \prod_{g \in \Gamma, g^{-1} \circ h \in S} (L_\sigma(g)_{L_\sigma(h)}, L_\sigma(g)_{L_\sigma(r(h))}, \dots)(\alpha L_\sigma(g)_{L_\sigma(h)}, \alpha L_\sigma(g)_{L_\sigma(r^{-1}(h))}, \dots) \\ &= \prod_{g \in \Gamma, g^{-1} \circ h \in S} (\sigma g_{\sigma h}, \sigma g_{\sigma r(h)}, \sigma g_{\sigma r^2(h)}, \dots)(\alpha \sigma g_{\sigma h}, \alpha \sigma g_{\sigma r^{-1}(h)}, \alpha \sigma g_{\sigma r^{-2}(h)}, \dots) \\ &= \prod_{s \in \Gamma, s^{-1} \circ t \in S} (s_t, s_{r(t)}, s_{r^2(t)}, \dots)(\alpha s_t, \alpha s_{r^{-1}(t)}, \alpha s_{r^{-2}(t)}, \dots) = \mathcal{P}(\Gamma : S), \end{aligned}$$

i.e., L_g is an automorphism of $\text{Cay}^M(\Gamma : S, r)$. We have known that $L_\Gamma \simeq \Gamma$ by Theorem 1.2.14. □

Although every Cayley map is vertex-transitive, there are non-regular Cayley maps on surfaces. For example, let $(\Gamma; \circ)$ be an Abelian group with $\Gamma = \{1_\Gamma, a, b, c\}$, $S = \{a, b, c\}$, $a^2 = b^2 = c^2 = 1_\Gamma$, $a \circ b = b \circ a = c$, $a \circ c = c \circ a = b$, $b \circ c = c \circ b = a$ and $r = (a, b, c)$. Then the Cayley map $\text{Cay}^M(\Gamma : S, r)$ is K_4 on the projective plane shown in Fig.5.4.5, which is not regular.

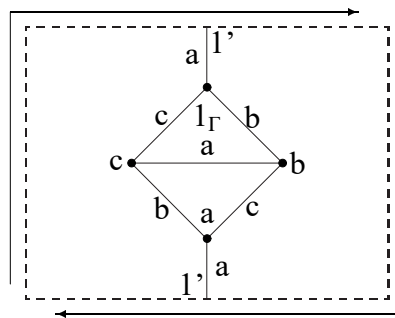

Fig.5.4.5

Now we find regular maps in Cayley maps of finite groups. First, we need to prove the following result.

Theorem 5.4.6 *Let $\text{Cay}^M(\Gamma : S, r)$ be a Cayley map and let ζ be an automorphism of group $(\Gamma; \circ)$ such that $\zeta|_S = r^l$ for an integer l , $1 \leq l \leq |S|$, then $\zeta \in (\text{AutCay}^M(\Gamma : S, r))_{1_\Gamma}$.*

Proof Notice that ζ is an automorphism of group $(\Gamma; \circ)$. There must be $\zeta(1_\Gamma) = 1_\Gamma$. Let $g_h \in \mathcal{X}_{\alpha, \beta}(\Gamma : S, r)$. Then $g^{-1} \circ h \in S$. Because of $\zeta(g^{-1} \circ h) = \zeta^{-1}(g) \circ \zeta(h) \in S$, we know that $(\zeta(g), \zeta(h)) \in E(\text{Cay}^M(\Gamma : S, r))$ and $\zeta(g)_{\zeta(h)} \in \mathcal{X}_{\alpha, \beta}(\Gamma : S, r)$. We only need to show that $\zeta \in \text{AutCay}^M(\Gamma : S, r)$. By definition, we know that $\zeta\alpha = \alpha\zeta$ and $\zeta\beta = \beta\zeta$. We verify $\zeta\mathcal{P}(\Gamma : S, r)\zeta^{-1} = \mathcal{P}(\Gamma : S, r)$. Calculation shows that

$$\begin{aligned} & \zeta\mathcal{P}(\Gamma : S, r)\zeta^{-1} \\ &= \zeta \prod_{g \in \Gamma, g^{-1} \circ h \in S} (g_h, g_{r(h), g_{r^2(h)}, \dots})(\alpha g_h, \alpha g_{r^{-1}(h)}, \alpha g_{r^{-2}(h)}, \dots)\zeta^{-1} \\ &= \prod_{g \in \Gamma, g^{-1} \circ h \in S} (\zeta(g)_{\zeta(h)}, \zeta(g)_{\zeta(r(h))}, \dots)(\alpha \zeta(g)_{\zeta(h)}, \alpha \zeta(g)_{\zeta(r^{-1}(h))}, \dots) \\ &= \prod_{g \in \Gamma, g^{-1} \circ h \in S} (\zeta(g)_{\zeta(h)}, \zeta(g)_{r(\zeta(h))}, \dots)(\alpha \zeta(g)_{\zeta(h)}, \alpha \zeta(g)_{r^{-1}(\zeta(h))}, \dots) \\ &= \prod_{s \in \Gamma, g^{-1} \circ h \in S} (s_t, s_{r(t), s_{r^2(t)}, \dots})(\alpha s_t, \alpha s_{r^{-1}(t)}, \alpha s_{r^{-2}(t)}, \dots) = \mathcal{P}(\Gamma : S)(\Gamma : S, r). \end{aligned}$$

Therefore ζ is an automorphism of map $\text{Cay}^M(\Gamma : S, r)$, i.e., $\zeta \in (\text{AutCay}^M(\Gamma : S, r))_{1_\Gamma}$. \square

The following result enables one to get regular maps in Cayley maps.

Theorem 5.4.7 *Let $\text{Cay}^M(\Gamma : S, r)$ be a Cayley map with $\tau \in \text{Aut}\Gamma$ such that $\tau|_S = r$. Then $\text{Cay}^M(\Gamma : S, r)$ is an orientable regular map.*

Proof According to Theorem 5.4.6, we know that $\tau \in (\text{Aut}M)_{1_\Gamma}$. By Theorem 5.3.7, $|(\text{AutCay}^M(\Gamma : S, r))_{1_\Gamma}|$ divides $|S|$. But $\tau|_S = r$, a $|S|$ -cycle, so that $|(\text{AutCay}^M(\Gamma : S, r))_{1_\Gamma}| = |S|$. Clearly, $(\text{AutCay}^M(\Gamma : S, r))_{1_\Gamma}$ is generated by τ . Applying Theorem 5.4.5, $(\text{AutCay}^M(\Gamma : S, r))$ is transitive on $\Gamma = V(\text{Cay}^M(\Gamma : S, r))$. Whence,

$$|\text{AutCay}^M(\Gamma : S, r)| = |\Gamma| |(\text{AutCay}^M(\Gamma : S, r))_{1_\Gamma}| = |\Gamma| |S| = \frac{|\mathcal{X}_{\alpha, \beta}(\Gamma : S, r)|}{2}.$$

Therefore, $\text{AutCay}^M(\Gamma : S, r) \times \langle \alpha \rangle$ is transitive on $\mathcal{X}_{\alpha, \beta}(\Gamma : S, r)$. \square

5.4.4 Complete Map. A complete map M is such a map underlying a complete graph K_n for an integer $n \geq 3$. We find regular maps in complete maps in this subsection. The following result is an immediately conclusion of Theorem 5.3.5.

Theorem 5.4.8 *There are no automorphisms σ in a complete map $M = (\mathcal{X}_{\alpha, \beta}, \mathcal{P})$ fixing more than one vertex unless $\sigma = 1_{\mathcal{X}_{\alpha, \beta}}$.*

Proof If $\sigma(u) = v$, $\sigma(v) = u$ for two vertices $u, v \in V(M)$, let $uv = \{x, \alpha x, \beta x, \alpha\beta x\}$, then there must be $\sigma(x) = x$ because of $uv \in V(M)$. Applying Theorem 5.3.5, we get the conclusion. \square

A *Frobenius group* Γ is defined to be a transitive group action on a set Ω such that only 1_Γ has more than one fixed points in Ω . By Theorem 5.4.8, thus the automorphism group $\text{Aut}M$ of a complete vertex-transitive map M is necessarily Frobenius. For finding complete regular map, we need a characterization due to Frobenius in 1902 following.

Theorem 5.4.9 *Let Γ be a Frobenius group action on Ω with N^* the set of fixed-free elements of Γ and $N = N^* \cup \{1_\Gamma\}$. Then there are must be*

- (1) $|N| = |\Omega|$;
- (2) N is a regular normal subgroup of Γ .

Theorem 5.4.10 *Let Γ be a sharply 2-transitive group action on Ω . Then $|\Omega|$ is a prime power.*

A complete proof of Theorems 5.4.9 and 5.4.10 can be found in [Rob1] by applying the character theory on linear representations of groups. But if the condition that Γ_x is Abelian for a point $x \in \Omega$ is added, Theorem 5.4.9 can be proved without characters of groups. See [BiW1] for details.

Theorem 5.4.11 *Let M be a complete map. Then $\text{Aut}M$ acts transitively on the vertices of M if and only if M is a Cayley map.*

Proof The sufficiency is implied in Theorem 5.4.5. For the necessity, applying Theorem 5.4.8 we know that $\text{Aut}M$ is a Frobenius group. Now by Theorem 5.3.7, $(\text{Aut}M)_x$ is isomorphic to a subgroup generated by $\overline{C}_v = C_v \cdot \alpha C_v^{-1} \alpha^{-1}$, i.e., a product of conjugate pair of cycles in \mathcal{P} . Whence, we get a regular normal subgroup N of $\text{Aut}M$ by Theorem 5.4.9. Let $\Gamma = \mathbb{Z}_n$ and define a bijection $\sigma : V(\text{Cay}^M(\mathbb{Z}_n, \mathbb{Z}_n \setminus \{1\}, r)) \rightarrow N$ by $\sigma(i) = a_i$, where a_i is the unique element transforming point 0 to i in N . Calculation shows that $r : N \setminus \{1\} \rightarrow N \setminus \{1\}$ is given by $r(a_i) = a_{\mathcal{P}(\mathbb{Z}_n, \mathbb{Z}_n \setminus \{1\}, r)}(i)$ for $i \neq 0$. Thus we get a Cayley map $\text{Cay}^M(\mathbb{Z}_n, \mathbb{Z}_n \setminus \{1\}, r)$. It can be verified that the bijection σ is an automorphism between maps M and $\text{Cay}^M(\mathbb{Z}_n, \mathbb{Z}_n \setminus \{1\}, r)$. \square

Now we summarize all properties of $\text{Aut}M$ in the following obtained in previous on regular map M underlying K_n :

- (1) $\text{Aut}M$ is a Frobenius group of order $n(n - 1)$;
- (2) $\text{Aut}M$ has a regular normal subgroup isomorphic to \mathbb{Z}_p^m for a prime p and an integer $m \geq 1$, i.e., $n = p^m$;
- (3) $\text{Aut}M$ is transitive on vertices, edges and faces of M , and regular on $\mathcal{X}_{\alpha,\beta}$;
- (4) For $\forall v \in V(M)$, $(\text{Aut}M)_v \simeq \mathbb{Z}_{n-1}$.

We prove the main result on complete regular maps of this subsection following.

Theorem 5.4.12 *A complete map M underlying K_n is regular on an orientable surface if and only if n is a prime power.*

Proof If M is regular on an orientable surface, then $|\text{Aut}M| = 4\varepsilon(K_n) = 2n(n - 1)$. Whence, $|\text{Aut}M / \langle \alpha \rangle| = n(n - 1)$, i.e., $\text{Aut}M / \langle \alpha \rangle$ acts on $\alpha \mathcal{X}_{\alpha,\beta}$ is Frobenius. Applying Theorem 5.4.10, we know that n is a prime power.

Conversely, if $n = p^m$, let $\Gamma = \mathbb{Z}_p^m$, i.e., the additive group in $GF(n)$, where p is a prime and n a positive integer and let $t \in \Gamma$ generate this multiplicative group. Take $\Gamma^* = \Gamma - \{0\}$, where 0 is the identity of \mathbb{Z}_p^m and $r : \Gamma^* \rightarrow \Gamma^*$ determined by $r(x) = tx$ for $x \in \Gamma^*$. By definition, we know that r is cyclic permutation on Δ^* . We extend r from Γ^* to Γ by defining $r(0) = 0$. Notice that $r(x + y) = rx + ry$ for $x, y \in \Gamma$. Such an extended r is an automorphism of group Γ . Applying Theorem 5.4.7, we know that $\text{Cay}^M(\Gamma : \Gamma^*, r) \simeq M$ is a regular map on orientable surface. □

§5.5 CONSTRUCTING REGULAR MAPS BY GROUPS

5.5.1 Regular Tessellation. Let \mathbf{R}^2 be a Euclidean plane and $p, q \geq 3$ be integers. We know that the angle of a regular p -gon is $(1 - 2/p)\pi$. If q such p -gons fit together around a common point $u \in \mathbf{R}^2$, then the angle of p -gons must be $2\pi/q$. Thus

$$\left(1 - \frac{2}{p}\right)\pi = \frac{2\pi}{q}, \quad \text{i.e., } (p - 2)(q - 2) = 4.$$

We so get three *planar regular tessellations* of type (p, q) on a Euclidean plane following:

$$(4, 4), (3, 6), (6, 3).$$

For example, a tessellation of type $(4, 4)$ on \mathbf{R}^2 is shown in Fig.5.5.1.

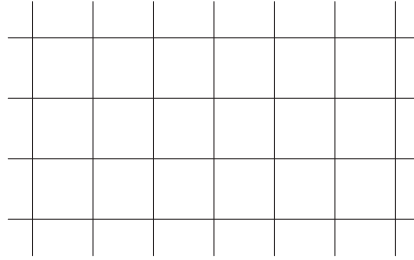

Fig.5.5.1

Now let S^2 be a sphere. Consider regular p -gons on S^2 . The angle of a spherical p -gon is greater than $(1 - 2/p)\pi$, and gradually increases this value to π if the circum-radius increases from 0 to $\pi/2$. Consequently, if

$$(p - 2)(q - 2) < 4,$$

we can adjust the size of the polygon so that the angle is exactly $2\pi/q$, i.e., q such p -gons will fit together around a common point $v \in S^2$. This fact enables one to get *spherical tessellations* of type (p, q) following:

$$(2, q), (q, 2), (3, 3), (3, 4), (4, 3), (3, 5), (5, 3).$$

The type of $(2, q)$ is formed by q lines joining the two antipodal points and the type $(q, 2)$ is formed by two q -gons, each covering a hemisphere. All of these rest types of spherical tessellations are the blown up of these five Platonic solids shown in Fig.5.4.1.

Finally, let H^2 be a hyperbolic plane. Consider the regular p -gons on H^2 . Then the angle of such a p -gon is less than $(1 - 2/p)\pi$, and gradually decreases this value to zero if the circum-radius increases from 0 to ∞ . Now if

$$(p - 2)(q - 2) > 4,$$

we can adjust the size of the polygon so that the angle is exactly $2\pi/q$. Thus q such p -gons will fit together around a common point $w \in H^2$. This enables one to construct a *hyperbolic tessellation* of type (p, q) , which is an infinite collection of regular p -gons filling the hyperbolic plane H^2 .

Consider a tessellation of type (p, q) drawn in thick lines and pick a point in the interior of each face and call it the center of the face. In each face, join the center by dashed and thin line segments with every point covered by q -gons and the midpoint of

every edge, respectively. This structure of tessellation is called the *barycentric subdivision* of tessellation. Each of the triangle formed by a thick, a thin and a dashed sides is called a *fag*, such as those shown in Fig.5.5.2. Denote all fags of a tessellation by \mathcal{F} .

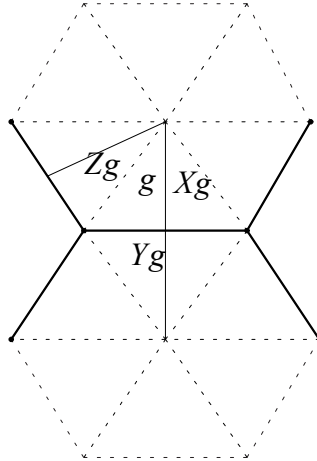

Fig.5.5.2

A tessellation of type (p, q) is symmetrical by reflection in certain lines, which may be a successive reflections of three types: $X : g \rightarrow Xg$, $Y : g \rightarrow Yg$ and $Z : g \rightarrow Zg$, where for each fag g , the fag Wg is such the unique fag different from g that shares with g the thin, the thick or the dashed sides depending on $W = X, Y$ or Z . Obviously,

$$X^2 = Y^2 = Z^2 = (XY)^2 = (YZ)^p = (ZX)^q = 1 \text{ and } XY = YX.$$

Furthermore, the group $\langle X, Y, Z \rangle$ is transitive permutation group on \mathcal{F} .

A tessellation of type (p, q) on surface S is naturally a map $M = (\mathcal{X}_{\alpha, \beta}, \mathcal{P})$ on S with $\mathcal{X}_{\alpha, \beta} = \mathcal{F}$. The behaviors of X, Y and YZ are more likely to those of β, α and \mathcal{P} on M . But essentially, $X \neq \beta, Y \neq \alpha$ and $YZ \neq \mathcal{P}$ because X, Y and YZ act on a given g , not on all g in \mathcal{F} . Such X, Y or YZ can be only seen as the localization of β, α or \mathcal{P} on a quadricell g of map M .

5.5.2 Regular Map on Finite Group. Let $(\Gamma; \circ)$ be a finite group with presentation

$$\Gamma = \langle x, y, z \mid x^2 = y^2 = z^2 = (x \circ y)^2 = (y \circ z)^p = (z \circ x)^q = \dots = 1_\Gamma \rangle,$$

where we assume that all exponents are true orders of the elements and dots indicate a possible presence of other relations in this subsection. Then a regular map $M = M(\Gamma; x, y, z)$ of type (p, q) on group $(\Gamma; \circ)$ is constructed as follows.

Construction 5.5.1 Let $g \in \Gamma$. Consider a topological triangle, i.e., a fag labeled by g with its thin, thick and dashed sides labeled by generators x , y and z , respectively. Such as those shown in Fig.5.5.3.

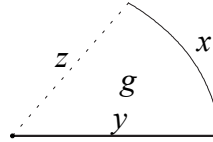

Fig.5.5.3

For simplicity, we will identify such fags with their group element labels. Then for each $g \in \Gamma$ and $w \in \{x, y, z\}$, we identify the sides labeled w in the fag g and $g \circ w$ in such a way that points on the thick, thin or dashed sides meet are identified as well. For example, such an identification for $g = x$, y or z is shown in Fig.5.5.4.

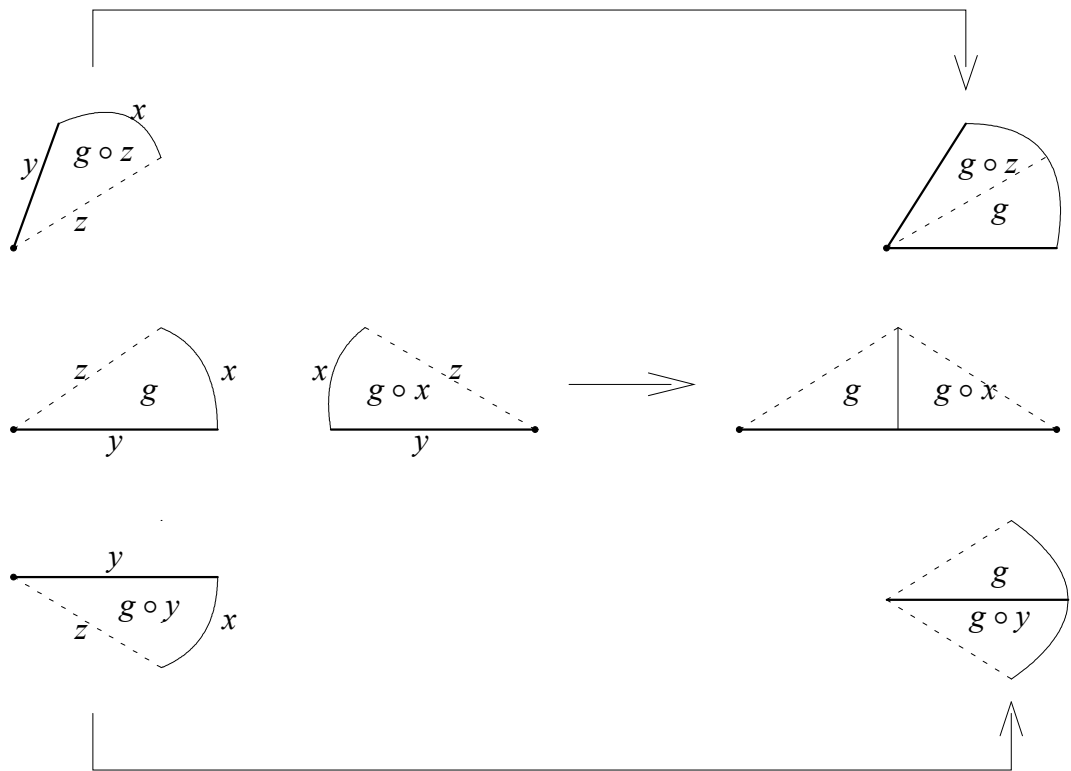

Fig.5.5.4

This way we get a connected surface S without boundary by Theorem 4.2.2. The cellular decomposition of S induced by the union of all thick segments forms a regular map $M = M(\Gamma; x, y, z)$ of type (p, q) . Such thick segments of S consist of the underlying graph

$G(M)$ with vertices, edges and faces identified with the left cosets of subgroups generated by $\langle x, y \rangle$, $\langle y, z \rangle$ and $\langle z, x \rangle$ in the group $(\Gamma; \circ)$, respectively. We therefore get the following result by this construction.

Theorem 5.5.1 *Let $(\Gamma; \circ)$ be a finite group with a presentation*

$$\Gamma = \langle x, y, z \mid x^2 = y^2 = z^2 = (x \circ y)^2 = (y \circ z)^p = (z \circ x)^q = \cdots = 1_\Gamma \rangle.$$

Then there always exists a regular map $M(\Gamma; x, y, z)$ of type (p, q) on $(\Gamma; \circ)$.

Consider the actions of left and right multiplication of Γ on fags of M . By Construction 5.5.1, we have known that the right multiplication by generators x , y and z on a fag $g \in \Gamma$ gives the permutations X , Y and Z defined in Fig.5.5.2. For the left multiplication of Γ on fags of M , we have an important result following.

Theorem 5.5.2 *Let $M = M(\Gamma; x, y, z)$ be a regular map of type (p, q) on a finite group $(\Gamma; \circ)$, where $\Gamma = \langle x, y, z \mid x^2 = y^2 = z^2 = (x \circ y)^2 = (y \circ z)^p = (z \circ x)^q = \cdots = 1_\Gamma \rangle$. Then*

$$\text{Aut}M = L_\Gamma \simeq (\Gamma; \circ).$$

Proof Notice that if two fags F and F' are related by a homeomorphism h on S , i.e., $h : F \rightarrow F'$, then $h : F \circ g \rightarrow F' \circ g$. Therefore, the left multiplication preserves the cell structure of M on S and induces an automorphism of M . Whence, $L_\Gamma \leq \text{Aut}M$. Now $\mathcal{X}_{\alpha,\beta}(M) = \mathcal{F}(M) = \Gamma$. By Corollary 5.3.3, there is $|\text{Aut}M| \leq |\mathcal{X}_{\alpha,\beta}(M)| = |\Gamma|$. Consequently, there must be $\text{Aut}M = L_\Gamma$. By Theorem 1.2.15, $L_\Gamma \simeq (\Gamma; \circ)$. This completes the proof. \square

There is a simple criterion for distinguishing isomorphic maps $M(\Gamma_1; x_1, y_1, z_1)$ and $M(\Gamma_2; x_2, y_2, z_2)$ following.

Theorem 5.5.3 *Two regular maps $M(\Gamma_1; x_1, y_1, z_1)$ and $M(\Gamma_2; x_2, y_2, z_2)$ are isomorphic if and only if there is a group isomorphism $\phi : \Gamma_1 \rightarrow \Gamma_2$ such that $\phi(x_1) = x_2$, $\phi(y_1) = y_2$ and $\phi(z_1) = z_2$.*

Proof If there is a group isomorphism $\phi : \Gamma_1 \rightarrow \Gamma_2$ such that $\phi(x_1) = x_2$, $\phi(y_1) = y_2$ and $\phi(z_1) = z_2$, we extend this isomorphism ϕ from fags $\mathcal{F}(M(\Gamma_1; x_1, y_1, z_1))$ to $\mathcal{F}(M(\Gamma_2; x_2, y_2, z_2))$ by

$$\phi(u_1^{\epsilon_1} u_2^{\epsilon_2} \cdots u_s^{\epsilon_s}) = \phi(u_1^{\epsilon_1}) \phi(u_2^{\epsilon_2}) \cdots \phi(u_s^{\epsilon_s})$$

for $u_i \in \{x_1, y_1, z_1\}$, $\epsilon_i \in \{+, -\}$ and integers $s \geq 1$. Then ϕ is an isomorphism between $M(\Gamma_1; x_1, y_1, z_1)$ and $M(\Gamma_2; x_2, y_2, z_2)$ because it preserves the incidence of fags.

Conversely, if ϕ is an isomorphism from $M(\Gamma_1; x_1, y_1, z_1)$ to $M(\Gamma_2; x_2, y_2, z_2)$, then it preserves the incidence of vertices, edges and faces. Whence it induces an isomorphism from fags $\mathcal{F}(M(\Gamma_1; x_1, y_1, z_1))$ to $\mathcal{F}(M(\Gamma_2; x_2, y_2, z_2))$, i.e., a group isomorphism $\phi : \Gamma_1 \rightarrow \Gamma_2$, which preserve the incidence of vertices, edges and faces if and only if $\phi(x_1) = x_2$, $\phi(y_1) = y_2$ and $\phi(z_1) = z_2$ by Construction 5.5.1. \square

Similarly, it can be shown that a regular map $M(\Gamma, x', y', z')$ is a dual of $M(\Gamma, x, y, z)$ if and only if $\Gamma' = \Gamma$ and $x' = y$, $y' = x$. By this way, regular maps of small genus are included in the next result.

Theorem 5.5.4 *Let $M = M(\Gamma, x, y, z)$ be a regular map on a finite group Γ .*

(A) *If M is on the sphere S^2 , then*

(1) $\Gamma = \langle x, y, z \mid x^2 = y^2 = z^2 = (xy)^2 = (yz)^n = (zx)^2 = 1_\Gamma \rangle \simeq D_n \times Z_2$ and M is an embedded n -dipoles with dual C_n on S^2 ;

(2) $\Gamma = \langle x, y, z \mid x^2 = y^2 = z^2 = (xy)^2 = (yz)^3 = (zx)^3 = 1_\Gamma \rangle \simeq S_4$ and M is the tetrahedron, which is self-dual on S^2 ;

(3) $\Gamma = \langle x, y, z \mid x^2 = y^2 = z^2 = (xy)^2 = (yz)^4 = (zx)^3 = 1_\Gamma \rangle \simeq S_4 \times Z_2$ and M is the octahedron with dual cube on S^2 ;

(4) $\Gamma = \langle x, y, z \mid x^2 = y^2 = z^2 = (xy)^2 = (yz)^5 = (zx)^2 = 1_\Gamma \rangle \simeq A_5 \times Z_2$ and M is the icosahedron with dual dodecahedron on S^2 .

(B) *If M is on the projective plane P^2 , let $r = yz$ and $s = zx$, then*

(1) $\Gamma = \langle x, y, z \mid x^2 = y^2 = z^2 = (xy)^2 = (yz)^{2n} = (zx)^3 = zsr^n = 1_\Gamma \rangle \simeq D_{2n}$ and M is the embedded bouquet B_{2n} with dual C_{2n} on P^2 ;

(2) $\Gamma = \langle x, y, z \mid x^2 = y^2 = z^2 = (xy)^2 = (yz)^4 = (zx)^3 = zrs^{-1}r^2s = 1_\Gamma \rangle \simeq S_4$ and M is the embedded $K_3^{(2)}$ with dual K_4 on P^2 , where $K_3^{(2)}$ is the graph K_3 with double edges;

(3) $\Gamma = \langle x, y, z \mid x^2 = y^2 = z^2 = (xy)^2 = (yz)^5 = (zx)^3 = zr^2sr^{-1}sr^{-2}s = 1_\Gamma \rangle \simeq A_5$ and M is the embedded K_6 on P^2 .

(C) *If M is on the torus T^2 , let b, c be integers, then $\Gamma = \langle r, s \mid r^4 = s^4 = (rs)^2 = (rs^{-1})^b(r^{-1}s)^c = 1_\Gamma \rangle$ or $\langle r, s \mid r^6 = s^3 = (rs)^2 = (rs^{-1}r)^b(s^{-1}r^2)^c = 1_\Gamma \rangle$ if $bc(b-c) \neq 0$ and $\Gamma = \langle r, s \mid r^4 = s^4 = (rs^{-1})^b(r^{-1}s)^c = 1_\Gamma \rangle$ or $\langle r, s \mid r^6 = s^3 = (rs^{-1}r)^b(s^{-1}r^2)^c = 1_\Gamma \rangle$ if $bc(b-c) = 0$.*

A complete proof of Theorem 5.5.4 can be found in the reference [CoM1]. With the

help of parallel program, orientable regular maps of genus 2 to 15, and non-orientable regular maps of genus 4 to 30 are determined in [CoD1]. Particularly, the regular maps on a double-torus or a non-orientable surface of genus 4 are known in the following.

Theorem 5.5.5 $M = M(\Gamma, x, y, z)$ be a regular map on a finite group Γ , $r = yz$, $s = zx$ and $t = xr$.

(A) If M is orientable of genus 2, then $\Gamma = \langle r, s \mid r^3 = s^8 = (rs^{-3})^2 = 1_\Gamma \rangle$, or $\langle r, s \mid r^4 = s^6 = (rs^{-1})^2 = 1_\Gamma \rangle$, or $\langle r, s \mid r^4 = s^8 = (rs^{-1})^2 = rs^3r^{-1}s^{-1} = 1_\Gamma \rangle$, or $\langle r, s \mid r^5 = s^{10} = s^2r^{-3} = 1_\Gamma \rangle$, or $\langle r, s \mid r^6 = s^6 = r^2s^{-4} = 1_\Gamma \rangle$, or $\langle r, s \mid r^8 = s^8 = rs^{-3} = 1_\Gamma \rangle$.

(B) If M is non-orientable of genus 4, then $\Gamma = \langle r, s, t \mid r^4 = s^6 = t^2 = ts^{-1}rs^{-1}r^{-2} = 1_\Gamma \rangle$, or $\langle r, s, t \mid r^4 = s^6 = t^2 = (rs^{-2})^2 = s^2rs^{-1}r^{-2}t = 1_\Gamma \rangle$.

We have known that there are regular maps on every orientable surface by Theorem 5.4.2, and there are no regular maps M on non-orientable surfaces of genus 2, 3, 18, 24, 27, 39 and 48 in literature. Whether or not there are infinite non-orientable surfaces which do not support regular maps is a problem for a long time. However, a general result appeared in 2004 ([DNS1]), which completely classifies regular maps on non-orientable surface of genus $p+2$ for an odd prime $p \neq 3, 7$ and 13. For presenting this general result, let $\nu(p)$ be the number of pairs of coprime integers (j, l) such that $j > l > 3$, both j and l are odd and $(j-1)(l-1) = p+1$ for a prime p .

Theorem 5.5.6 Let p be an odd prime, $p \neq 3, 7, 13$ and let N_{p+2} be a non-orientable surface of genus $p+2$. Then

- (1) If $p \equiv 1 \pmod{12}$, then there are no regular maps on N_{p+2} ;
- (2) If $p \equiv 5 \pmod{12}$, then, up to isomorphism and duality, there is exactly one regular map on N_{p+2} ;
- (3) If $p \equiv -5 \pmod{12}$, then, up to isomorphism and duality, there are $\nu(p)$ regular maps on N_{p+2} ;
- (4) If $p \equiv -1 \pmod{12}$, then, up to isomorphism and duality, N_{p+2} supports exactly $\nu(p) + 1$ regular maps.

5.5.3 Regular Map on Finite Multigroup. Let P_1, P_2, \dots, P_n be a family of topological polygons with even sides for an integer $n \geq 1$. Denoted by ∂P_i the boundary of P_i ,

$1 \leq i \leq n$. Define a projection $\pi : \bigcup_{i=1}^n P_i \rightarrow (\bigcup_{i=1}^n P_i) / \sim$ by

$$\begin{cases} \pi(x_1) \neq \pi(x_2) \neq \dots \neq \pi(x_n) & \text{if } x_i \in P_i \setminus \partial P_i, 1 \leq i \leq n, \\ \pi(y_1) = \pi(y_2) = \dots = \pi(y_n) & \text{if } y_i \in \partial P_i, 1 \leq i \leq n, \end{cases}$$

i.e., π is an identification on boundaries of P_1, P_2, \dots, P_n . Such an identification space $(\bigcup_{i=1}^n P_i) / \sim$ is called an m -multipolygon by n polygons and denoted by \tilde{P} . The cross section of \tilde{P} is shown in Fig.5.5.5(a). Sometimes, a multipolygon maybe homeomorphic to a surface. For example, the sphere S^2 is in fact a topological multipolygon of 2 polygons shown in Fig.4.1.2.

It should be noted that the boundary of an m -multipolygon \tilde{P} is the same as any of its m -polygon. So we can also get the polygonal presentation of an m -multipolygon such as we have done in Section 4.2. Similarly, an orientable or non-orientable *multisurface* \tilde{S} is defined on \tilde{P} by identifying side pairs of \tilde{P} . Certainly, $\tilde{S} = \bigcup_{i=1}^n P_i / \sim = \bigcup_{i=1}^n S_i$, where $S_i = P_i / \sim$ is a surface for integers $1 \leq i \leq n$. The inclusion mapping $\pi_i : \tilde{S} \rightarrow S_i$ determined by $\pi_i(x) = x$ for $x \in S_i$ is called the *natural projection of \tilde{S} on S_i* .

By definition, $\partial\tilde{P} / \sim$ is a closed curve on \tilde{S} , called the *base line*, denoted by $L_{\mathcal{B}}$ and a multisurface \tilde{S} possesses the hierarchical structure, i.e., $\tilde{S} \setminus L_{\mathcal{B}}$ is disconnected union of $P_i \setminus \partial P_i, 1 \leq i \leq n$. Such as those shown in Fig.5.5.5(b) for longitudinal and cross section of a multitorus.

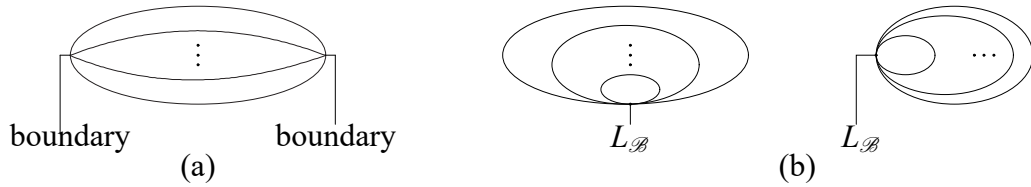

Fig.5.5.5

Similarly considering maps on surface S , we can find such a decomposition of \tilde{S} with each components homeomorphic to a open disk of dimensional 2, i.e., a map \tilde{M} on \tilde{S} . So a problem for maps on multisurfaces is presented in the following.

Problem 5.5.1 Determine maps \tilde{M} on $\tilde{S} = \bigcup_{i=1}^n S_i$ such that $\pi_i(\tilde{M})$ is a transitive map, furthermore a regular map on S_i for any integer $i, 1 \leq i \leq n$.

If \tilde{S} is orientable, the answer is affirmed by Theorem 5.4.2 by applying to standard

map O_p on S_i for an integer $1 \leq i \leq n$. We construct more such maps on finite multigroups following.

Cayley Map on Multigroup. Let $(\widetilde{\mathcal{G}}; \widetilde{O})$ be a multigroup with $\widetilde{\mathcal{G}} = \bigcup_{i=1}^n \mathcal{G}_i$, $\widetilde{O} = \{\circ_i, 1 \leq i \leq n\}$ such that $(\mathcal{G}_i; \circ_i)$ is a finite group generated by $A_i = A_i^{-1}$, $1_{\mathcal{G}_i} \notin A_i$ for integers $1 \leq i \leq n$. Furthermore, we assume each $A_i = A$ is minimal for integers $1 \leq i \leq n$. Whence A is an independent vertex set in Cayley graphs $\text{Cay}(\mathcal{G}_i : A)$. Such A is always existed if we choose the group $(\mathcal{G}_i; \circ_i) = (\mathcal{G}; \circ)$ for integers $1 \leq i \leq n$.

Let $r : S \rightarrow S$ be a cyclic permutation on A . For an integer i , $1 \leq i \leq n$, we construct a Cayley map $\text{Cay}^M(\mathcal{G}_i : A, r)$. Not loss of generality, assume that the genus of $\text{Cay}^M(\mathcal{G}_i : A, r)$ is g for $1 \leq i \leq n$. Particularly, $s = n$ if $(\mathcal{G}_i; \circ_i) = (\mathcal{G}; \circ)$ for integers $1 \leq i \leq n$. Now let \widetilde{S} be a multisurface consisting of s surfaces S_1, S_2, \dots, S_s of genus g . We place each element of A on the base line $L_{\mathcal{B}}$ of \widetilde{S} . Then the map

$$\text{Cay}^M(\widetilde{\mathcal{G}} : A, r) = \bigcup_{j=1}^s \text{Cay}^M(\mathcal{G}_j : A, r)$$

is such a map that $\pi_{i_j} : \text{Cay}^M(\widetilde{\mathcal{G}} : A, r) \rightarrow \text{Cay}^M(\mathcal{G}_j : A, r)$. We therefore get the following result.

Theorem 5.5.7 *For any integers $g \geq 0$, $n \geq 1$, if there is a Cayley map $\text{Cay}^M(\Gamma : A, r)$ of genus g , then there is a map \widetilde{M} on multisurface $\widetilde{S} = \bigcup_{i=1}^n S_i$ consisting of n surfaces of genus g such that $\pi_i(\widetilde{M})$ is a Cayley map, i.e., a transitive map, particularly, there is a map \widetilde{M} on \widetilde{S} such that $\pi_i(\widetilde{M}) = \text{Cay}^M(\Gamma : A, r)$ for integers $1 \leq i \leq n$.*

Regular Map on Triangle Multigroup. Let $\widetilde{\Gamma} = \bigcup_{i=1}^n (\Gamma_i; \circ_i)$ be a multigroup, where $(\Gamma_i; \circ_i)$ is a finite triangle group with $\Gamma_i = \langle x_i, y, z_i | x_i^2 = y^2 = z_i^2 = (x_i \circ_i y_i)^2 = (y_i \circ_i z_i)^{p_i} = (z_i \circ_i x_i)^{q_i} = \dots = 1_{\Gamma} \rangle$ for integers $1 \leq i \leq n$. Then there is a regular map $M(\Gamma_i; x_i, y, z_i)$ correspondent to $(\Gamma_i; \circ_i)$ by Construction 5.5.1.

Not loss of generality, assume that the genus of $M(\Gamma_i; x_i, y, z_i)$ is p for integers $1 \leq j \leq k$. Particularly, $s = n$ if $M(\Gamma_i; x_i, y, z_i) = M(\Gamma; x, y, z)$ for integers $1 \leq i \leq n$. Now let \widetilde{S} be a multisurface consisting of s surfaces S_1, S_2, \dots, S_s of genus p . Choose a flag g in $M(\Gamma_i; x_i, y, z_i)$ with thick sides of g and $g \circ_i x$ identifying with a segment PQ on the base line $L_{\mathcal{B}}$ of \widetilde{S} for integers $1 \leq j \leq s$. Then the map \widetilde{M} on \widetilde{S} defined by

$$\tilde{M} = \bigcup_{j=1}^s M(\Gamma_{i_j}; x_{i_j}, y, z_{i_j})$$

is such a map that $\pi_{i_j} : \tilde{M} \rightarrow M(\Gamma_{i_j}; x_{i_j}, y, z_{i_j})$, a regular map on S_{i_j} . This fact enables one to get the following result.

Theorem 5.5.8 *For any integers $g \geq 0$, $n \geq 1$ and $p, q \geq 3$, if there is a regular map $M(\Gamma; x, y, z)$ of genus g correspondent to a triangle group $\Gamma = \langle x, y, z \mid x^2 = y^2 = z^2 = (x \circ y)^2 = (y \circ z)^p = (z \circ x)^q = 1_\Gamma \rangle$, then there is a map \tilde{M} on multisurface $\tilde{S} = \bigcup_{i=1}^n S_i$ consisting of n surfaces of genus g such that $\pi_i(\tilde{M})$ is a regular map $M(\Gamma_i; x_i, y, z_i)$, particularly, there is a map \tilde{M} on \tilde{S} such that $\pi_i(\tilde{M}) = M(\Gamma; x, y, z)$ for integers $1 \leq i \leq n$.*

§5.6 REMARKS

5.6.1 A topological map M is essentially a decomposition of a surface S with components homeomorphic to 2-disk, which can be also characterized by the embedding of graph $G[M]$ on S . Many mathematicians had contributed to the foundation of map theory, such as those of Tutte in [Tut1], Jones and Singerman in [JoS1], Vince in [Vin1]-[Vn2] and Bryant and Singerman in [BrS1] characterizing a map by quadricells or flags. They are essentially equivalent. There are many excellent books on these topics today. For example, [GrT1] and [Whi1] on embedding and topological maps, [MoT1] on the topological behavior of embeddings and [Liu2]-[Liu4] on algebraic maps with enumerative theory.

5.6.2 Although it is difficult to determine the automorphism group of a graph in general, it is easy to find the automorphism group of a map. By Theorem 5.3.6, the automorphism group of map $M = (\mathcal{X}_{\alpha, \beta}, \mathcal{P})$ is the centralizer of the group $\langle \alpha, \beta, \mathcal{P} \rangle$ in the symmetric group $S_{\mathcal{X}_{\alpha, \beta}}$. In fact, there is an efficient algorithm for getting an automorphism group of map with complexity not bigger than $O(\varepsilon^2(M))$. See [Liu1], [Liu3]-[Liu4] for details. Besides, a few mathematicians also characterized automorphism group of map by that of its underlying graph. This enables one to know that the automorphism group of map is an extended action subgroup of the semi-arc automorphism group of its underlying graph. See also [Mao2] and [MLW1] for details.

5.6.3 The research of regular maps, beginning for searching stellated polyhedra of symmetrical beauty, is more early than that of general map, which appeared firstly in the work of Kepler in 1619. The well-known such polyhedra are the five Platonic polyhedra. There are two equivalent definitions for regular map by let the automorphism group of map M transitive on its quadricells or flags. Both of them makes the largest possible on automorphisms of a map, i.e., transitive and fixed-free. This enables one knowing that the automorphism group of a map is transitive on its vertices, edges and faces, and also its upper bound of regular maps of genus ≥ 2 . For many years, one construct regular maps by that of symmetric graphs, such as those of Cayley graphs, complete graphs, cubic graph and Paley graph on surfaces. The materials in references [Big1]-[Big2], [BiW1] and [JaJ1] are typical such examples.

Such as those discussions in the well-know book [CoM1] on discrete group with geometry. A more efficient way for constructing regular map is by that of the triangle group $\Gamma = \langle x, y, z \mid x^2 = y^2 = z^2 = (xy)^2 = (yz)^p = (zx)^q = 1_\Gamma \rangle$. In fact, by the barycentric subdivision of map on surface, a regular map M is unique correspondent to a triangle group Γ and vice vera. This correspondence turns the question of finding regular maps to that of classifying or constructing such triangle groups and enables one to classify regular maps of small genus. For example, the classification of regular maps on \mathcal{N}_{p+2} for an odd prime p in [DNS1] is by this way, and the classification of regular maps for orientable genus from 2 to 15, non-orientable from 4 to 30 in [CoD1] is also by this way with the help of parallel program.

5.6.4 A multisurface \tilde{S} is introduced for characterizing hierarchical structures of topological space. Besides this structure, its base line $L_{\mathcal{B}}$ is common and the same as that of standard surface O_p or N_q . We have shown that there is a map \tilde{M} on \tilde{S} such that its projection on any surface of \tilde{S} is a regular map by applying Cayley maps on finite groups, and by regular maps on finite triangle group. Besides for regular map, we can also consider embedding question on multisurface \tilde{S} . Since all genus of surface in a multisurface \tilde{S} is the same, we define the genus $g(\tilde{S})$ of \tilde{S} to be the genus of its surface.

Let G be a connected graph. Define its orientable or non-orientable genus $\tilde{\gamma}_m^O(G)$, $\tilde{\gamma}_m^N(G)$ on multisurface \tilde{S} consisting of m surfaces S by

$$\tilde{\gamma}_m^O(G) = \min\{g(\tilde{S}) \mid G \text{ is 2-cell embeddable on orientable multisurface } \tilde{S}\},$$

$$\tilde{\gamma}_m^N(G) = \min\{g(\tilde{S}) \mid G \text{ is 2-cell embeddable on non-orientable multisurface } \tilde{S}\}.$$

Then we are easily knowing that $\tilde{\gamma}_1^O(G) = \gamma(G)$ and $\tilde{\gamma}_1^N(G) = \tilde{\gamma}(G)$ by definition. The problems for embedded graphs following are particularly interesting for researchers.

Problem 5.6.1 *Let $n, m \geq 1$ be integers. Determine $\tilde{\gamma}_m^O(G)$ and $\tilde{\gamma}_m^N(G)$ for a connected graph G , particularly, the complete graph K_n and the complete bipartite graph $K_{n,m}$.*

Problem 5.6.2 *Let G be a connected graph. Characterize the embedding behavior of G on multisurface \tilde{S} , particularly, those embeddings whose every facial walk is a circuit, i.e, a strong embedding of G on \tilde{S} .*

The enumeration of non-isomorphic objects is an important problem in combinatorics, particular for maps on surface. See [Liu2] and [Liu4] for details. Similar problems for multisurface are as follows.

Problem 5.6.3 *Let \tilde{S} be a multisurface. Enumerate embeddings or maps on \tilde{S} by parameters, such as those of order, size, valency of rooted vertex or rooted face, \dots .*

Problem 5.6.4 *Enumerate embeddings on multisurfaces for a connected graph G .*

For a connected graph G , its orientable, non-orientable genus polynomial $g_m[G](x)$, $\tilde{g}_m[G](x)$ is defined to be

$$g_m[G](x) = \sum_{i \geq 0} g_{mi}^O(G)x^i \quad \text{and} \quad \tilde{g}_m[G](x) = \sum_{i \geq 0} g_{mi}^N(G)x^i,$$

where $g_{mi}^O(G)$, $g_{mi}^N(G)$ are the numbers of G on orientable or non-orientable multisurface \tilde{S} consisting of m surfaces of genus i .

Problem 5.6.5 *Let $m \geq 1$ be an integer. Determine $g_m[G](x)$ and $\tilde{g}_m[G](x)$ for a connected graph G , particularly, for the complete or complete bipartite graph, the cube, the ladder, the bouquet, \dots .*

CHAPTER 6.

Lifting Map Groups

The voltage assignment technique on graphs or maps is in fact a construction of regular coverings of graphs or maps, i.e., covering spaces in lower dimensional cases. For such covering spaces, an interesting problem is that finding conditions on the assignment so that an automorphism of graph or map is also an automorphism of the lifted graph or map, and then apply this technique to finding regular maps or solving problems on Klein surfaces. For these objectives, we introduce topological covering spaces, covering mappings first, and then voltage graphs and maps in Section 6.1. The lifting map group is discussed in the following section. These conditions such as those of locally invariant, A_J -uniform and A_J -compatible, and furthermore, a condition for a finite group to be that of a map by voltage assignment can be found in Section 6.2, which enables one finding a formulae related the Euler-Poincaré characteristic with parameters on maps or its quotient maps. These formulae enables us to discussing the minimum or maximum order of automorphisms of a map, i.e., conformal transformations realizable by maps M on Riemann or Klein surfaces in Section 6.5. Section 6.4 presents a combinatorial generalization of the famous Hurwitz theorem on orientation-preserving automorphism groups of Riemann surfaces, which enables us to get the upper or lower bounds of automorphism groups of Klein surfaces. All these discussions support a conjecture in forewords of Chapter 5 in [Mao2], i.e., CC conjecture discussed in the last chapter of this book.

§6.1 VOLTAGE MAPS

6.1.1 Covering Space. Let S be a topological space. A *covering space* \tilde{S} of S consisting of a space \tilde{S} with a continuous mapping $p : \tilde{S} \rightarrow S$ such that any point $x \in S$ possesses an arcwise connected neighborhood U_x , and any arcwise connected component of $p^{-1}(U_x)$ is mapped topologically onto U_x by p . Such an opened neighborhoods U_x is called an *elementary neighborhood* and p a *projection* from \tilde{S} to S .

Def nition 6.1.1 Let S, T be topological spaces, $x_0 \in S, y_0 \in T$ and $f : (T, y_0) \rightarrow (S, x_0)$ a continuous mapping. If (\tilde{S}, p) is a covering space of S , $\tilde{x}_0 \in \tilde{S}$, $x_0 = p(\tilde{x}_0)$ and there exists a mapping $f^l : (T, y_0) \rightarrow (\tilde{S}, \tilde{x}_0)$ such that $f = f^l \circ p$, then f^l is a *lifting* of f , particularly, if f is an arc, f^l is called a *lifting arc*.

The following result asserts the lifting of an arc is uniquely dependent on the initial point.

Theorem 6.1.1 Let (\tilde{S}, p) be a covering space of S , $\tilde{x}_0 \in \tilde{S}$ and $p(\tilde{x}_0) = x_0$. Then there exists a unique lifting arc $f^l : I \rightarrow \tilde{S}$ with initial point \tilde{x}_0 for each arc $f : I \rightarrow S$ with initial point x_0 .

A complete proof of Theorem 6.1.1 can be found in references [Mas1] or [Mun1], which applied the property of Lebesgue number on metric space.

Theorem 6.1.2 Let (\tilde{S}, p) be a covering space of S , $\tilde{x}_0 \in \tilde{S}$ and $p(\tilde{x}_0) = x_0$. Then

- (1) the induced homomorphism $p_* : \pi(\tilde{S}, \tilde{x}_0) \rightarrow \pi(S, x_0)$ is a monomorphism;
- (2) for $\tilde{x} \in p^{-1}(x_0)$, the subgroups $p_*\pi(\tilde{S}, \tilde{x}_0)$ are exactly a conjugacy class of subgroups of $\pi(S, x_0)$.

Proof Applying Theorem 6.1.1, for $\tilde{x}_0 \in \tilde{S}$ and $p(\tilde{x}_0) = x_0$, there is a unique mapping on loops from \tilde{S} with base point \tilde{x}_0 to S with base point x_0 . Now let $L_i : I \rightarrow \tilde{S}$, $i = 1, 2$ be two arcs with the same initial point \tilde{x}_0 in \tilde{S} . We prove that if $pL_1 \simeq pL_2$, then $L_1 \simeq L_2$.

Notice that $pL_1 \simeq pL_2$ implies the existence of a continuous mapping $H : I \times I \rightarrow S$ such that $H(s, 0) = pL_1(s)$ and $H(s, 1) = pL_2(s)$. Similar to the proof of Theorem 3.10, we can find numbers $0 = s_0 < s_1 < \dots < s_m = 1$ and $0 = t_0 < t_1 < \dots < t_n = 1$ such that each rectangle $[s_{i-1}, s_i] \times [t_{j-1}, t_j]$ is mapped into an elementary neighborhood in S by H .

Now we construct a mapping $G : I \times I \rightarrow \tilde{S}$ with $pG = H, G(0, 0) = \tilde{x}_0$ hold by the following procedure.

First, we can choose G to be a lifting of H over $[0, s_1] \times [0, t_1]$ since H maps this rectangle into an elementary neighborhood of $p(\tilde{x}_0)$. Then we extend the definition of G successively over the rectangles $[s_{i-1}, s_i] \times [0, t_1]$ for $i = 2, 3, \dots, m$ by taking care that it is agree on the common edge of two successive rectangles, which enables us to get G over the strip $I \times [0, t_1]$. Similarly, we can extend it over these rectangles $I \times [t_1, t_2], [t_2, t_3], \dots$, etc.. Consequently, we get a lifting H^l of H , i.e., $L_1 \simeq L_2$ by this construction.

Particularly, if L_1 and L_2 were two loops, we get the induced monomorphism homomorphism $p_* : \pi(\tilde{S}, \tilde{x}_0) \rightarrow \pi(S, x_0)$. This is the assertion of (1).

For (2), suppose \tilde{x}_1 and \tilde{x}_2 are two points of \tilde{S} such that $p(\tilde{x}_1) = p(\tilde{x}_2) = x_0$. Choose a class L of arcs in \tilde{S} from \tilde{x}_1 to \tilde{x}_2 . Similar to the proof of Theorem 3.1.7, we know that $\mathcal{L} = L[a]L^{-1}$, $[a] \in \pi(\tilde{S}, \tilde{x}_1)$ defines an isomorphism $\mathcal{L} : \pi(\tilde{S}, \tilde{x}_1) \rightarrow \pi(\tilde{S}, \tilde{x}_2)$. Whence, $p_*(\pi(\tilde{S}, \tilde{x}_1)) = p_*(L)\pi(\tilde{S}, \tilde{x}_2)p_*(L^{-1})$. Notice that $p_*(L)$ is a loop with a base point x_0 . We know that $p_*(L) \in \pi(S, x_0)$, i.e., $p_*\pi(\tilde{S}, \tilde{x}_0)$ are exactly a conjugacy class of subgroups of $\pi(S, x_0)$. \square

Theorem 6.1.3 *If (\tilde{S}, p) is a covering space of S , then the sets $p^{-1}(x)$ have the same cardinal number for all $x \in S$.*

Proof For any points x_1 and $x_2 \in S$, choosing an arc f in S with initial point x_1 and terminal point x_2 . Applying f , we can define a mapping $\Psi : p^{-1}(x_1) \rightarrow p^{-1}(x_2)$ by the following procedure.

For $\forall y_1 \in p^{-1}(x_1)$, we lift f to an arc f^l in \tilde{S} with initial point y_1 such that $pf^l = f$. Denoted by y_2 the terminal point of f^l . Define $\Psi(y_1) = y_2$.

By applying the inverse arc f^{-1} , we can define $\Psi^{-1}(y_2) = y_1$ in an analogous way. Therefore, Ψ is a 1 – 1 mapping from $p^{-1}(x_1)$ to $p^{-1}(x_2)$. \square

Usually, this cardinal number of the sets $p^{-1}(x)$ for $x \in S$ is called the *number of sheets* of the covering space (\tilde{S}, p) on S . If $|p^{-1}(x)| = n$ for $x \in S$, we also say it an *n-sheeted covering*.

6.1.2 Covering Mapping. Let $\tilde{M} = (\tilde{\mathcal{X}}_{\alpha,\beta}, \tilde{\mathcal{P}})$ and $M = (\mathcal{X}_{\alpha,\beta}, \mathcal{P})$ be two maps. The map \tilde{M} is called to be covered by map M if there is a mapping $\pi : \tilde{\mathcal{X}}_{\alpha,\beta} \rightarrow \mathcal{X}_{\alpha,\beta}$ such that $\forall x \in \tilde{\mathcal{X}}_{\alpha,\beta}$,

$$\alpha\pi(x) = \pi\alpha(x), \beta\pi(x) = \pi\beta(x) \text{ and } \pi\tilde{\mathcal{P}}(x) = \mathcal{P}\pi(x).$$

Such a mapping π is called a *covering mapping*. For $\forall x \in \mathcal{X}_{\alpha,\beta}$, define the *quadrice cell set*

$\pi^{-1}(x)$ by

$$\pi^{-1}(x) = \{\tilde{x} | \tilde{x} \in (\tilde{\mathcal{X}}_{\alpha,\beta} \text{ and } \pi(\tilde{x}) = x\}.$$

Then we know the following result.

Theorem 6.1.4 *Let $\pi : \tilde{\mathcal{X}}_{\alpha,\beta} \rightarrow \mathcal{X}_{\alpha,\beta}$ be a covering mapping. Then for any two quadricells $x_1, x_2 \in \mathcal{X}_{\alpha,\beta}$,*

- (1) $|\pi^{-1}(x_1)| = |\pi^{-1}(x_2)|$.
- (2) *If $x_1 \neq x_2$, then $\pi^{-1}(x_1) \cap \pi^{-1}(x_2) = \emptyset$.*

Proof (1) By the definition of a map, for $x_1, x_2 \in \mathcal{X}_{\alpha,\beta}$, there exists an element $\sigma \in \Psi_J = \langle \alpha, \beta, \mathcal{P} \rangle$ such that $x_2 = \sigma(x_1)$.

Since π is an covering mapping from \tilde{M} to M , it is commutative with α, β and \mathcal{P} . Whence, π is also commutative with σ . Therefore,

$$\pi^{-1}(x_2) = \pi^{-1}(\sigma(x_1)) = \sigma(\pi^{-1}(x_1)).$$

Notice that $\sigma \in \Psi_J$ is an 1 – 1 mapping on $\mathcal{X}_{\alpha,\beta}$. Hence, $|\pi^{-1}(x_1)| = |\pi^{-1}(x_2)|$.

(2) If $x_1 \neq x_2$ and there exists an element $y \in \pi^{-1}(x_1) \cap \pi^{-1}(x_2)$, then there must be $x_1 = \pi(y) = x_2$. Contradicts the assumption. \square

Then we know the following result.

Theorem 6.1.5 *Let $\pi : \tilde{\mathcal{X}}_{\alpha,\beta} \rightarrow \mathcal{X}_{\alpha,\beta}$ be a covering mapping. Then π is an isomorphism if and only if π is a 1 – 1 mapping.*

Proof If π is an isomorphism between the maps $\tilde{M} = (\tilde{\mathcal{X}}_{\alpha,\beta}, \tilde{\mathcal{P}})$ and $M = (\mathcal{X}_{\alpha,\beta}, \mathcal{P})$, then it must be an 1 – 1 mapping by the definition, and vice via. \square

A covering mapping π from \tilde{M} to M naturally induces a mapping π^* by the condition following:

$$\forall x \in \mathcal{X}_{\alpha,\beta}, g \in \text{Aut}\tilde{M}, \pi^* : g \rightarrow \pi g \pi^{-1}(x).$$

Whence, we have the following result.

Theorem 6.1.6 *If $\pi : \tilde{\mathcal{X}}_{\alpha,\beta} \rightarrow \mathcal{X}_{\alpha,\beta}$ is a covering mapping, then the induced mapping π^* is a homomorphism from $\text{Aut}\tilde{M}$ to $\text{Aut}M$.*

Proof First, we prove that for $\forall g \in \text{Aut}\tilde{M}$ and $x \in \mathcal{X}_{\alpha,\beta}$, $\pi^*(g) \in \text{Aut}M$. Notice that for $\forall g \in \text{Aut}\tilde{M}$ and $x \in \mathcal{X}_{\alpha,\beta}$,

$$\pi g \pi^{-1}(x) = \pi(g \pi^{-1}(x)) \in \mathcal{X}_{\alpha,\beta}$$

and $\forall x_1, x_2 \in \mathcal{X}_{\alpha, \beta}$, if $x_1 \neq x_2$, then $\pi g \pi^{-1}(x_1) \neq \pi g \pi^{-1}(x_2)$. Otherwise, let

$$\pi g \pi^{-1}(x_1) = \pi g \pi^{-1}(x_2) = x_0 \in \mathcal{X}_{\alpha, \beta}.$$

Then we must have that $x_1 = \pi g^{-1} \pi^{-1}(x_0) = x_2$, which contradicts to the assumption.

By definition, for $x \in \mathcal{X}_{\alpha, \beta}$ we have that

$$\pi^* \alpha(x) = \pi g \pi^{-1} \alpha(x) = \pi g \alpha \pi^{-1}(x) = \pi \alpha g \pi^{-1}(x) = \alpha \pi g \pi^{-1}(x) = \alpha \pi^*(x),$$

$$\pi^* \beta(x) = \pi g \pi^{-1} \beta(x) = \pi g \beta \pi^{-1}(x) = \pi \beta g \pi^{-1}(x) = \beta \pi g \pi^{-1}(x) = \beta \pi^*(x).$$

Now $\pi(\widetilde{\mathcal{P}}) = \mathcal{P}$. We therefore get that

$$\pi^* \mathcal{P}(x) = \pi g \pi^{-1} \mathcal{P}(x) = \pi g \widetilde{\mathcal{P}} \pi^{-1}(x) = \pi \widetilde{\mathcal{P}} g \pi^{-1}(x) = \mathcal{P} \pi g \pi^{-1}(x) = \mathcal{P} \pi^*(x).$$

Consequently, $\pi g \pi^{-1} \in \text{Aut}M$, i.e., $\pi^* : \text{Aut}\widetilde{M} \rightarrow \text{Aut}M$.

Now we prove that π^* is a homomorphism from $\text{Aut}\widetilde{M}$ to $\text{Aut}M$. In fact, for $\forall g_1, g_2 \in \text{Aut}\widetilde{M}$, we have that

$$\pi^*(g_1 g_2) = \pi(g_1 g_2) \pi^{-1} = (\pi g_1 \pi^{-1})(\pi g_2 \pi^{-1}) = \pi^*(g_1) \pi^*(g_2).$$

Whence, $\pi^* : \text{Aut}\widetilde{M} \rightarrow \text{Aut}M$ is a homomorphism. □

6.1.3 Voltage Map with Lifting. Let G be a connected graph and $(\Gamma; \circ)$ a group. For each edge $e \in E(G)$, $e = uv$, an *orientation* on e is such an orientation on e from u to v , denoted by $e = (u, v)$, called the *plus orientation* and its *minus orientation*, from v to u , denoted by $e^{-1} = (v, u)$. For a given graph G with plus and minus orientation on edges, a *voltage assignment* on G is a mapping σ from the plus-edges of G into a group Γ satisfying $\sigma(e^{-1}) = \sigma^{-1}(e)$, $e \in E(G)$. These elements $\sigma(e)$, $e \in E(G)$ are called voltages, and (G, σ) a *voltage graph* over the group $(\Gamma; \circ)$.

For a voltage graph (G, σ) , its lifting $G^\sigma = (V(G^\sigma), E(G^\sigma); I(G^\sigma))$ is defined by

$$V(G^\sigma) = V(G) \times \Gamma, (u, a) \in V(G) \times \Gamma \text{ abbreviated to } u_a;$$

$$E(G^\sigma) = \{(u_a, v_{aob}) | e^+ = (u, v) \in E(G), \sigma(e^+) = b\}$$

and

$$I(G^\sigma) = \{(u_a, v_{aob}) | I(e) = (u_a, v_{aob}) \text{ if } e = (u, v) \in E(G^\sigma)\}.$$

This is a $|\Gamma|$ -sheet covering of the graph G . For example, let $G = K_3$ and $\Gamma = Z_2$. Then the voltage graph (K_3, σ) with $\sigma : K_3 \rightarrow Z_2$ and its lifting are shown in Fig.6.1.1.

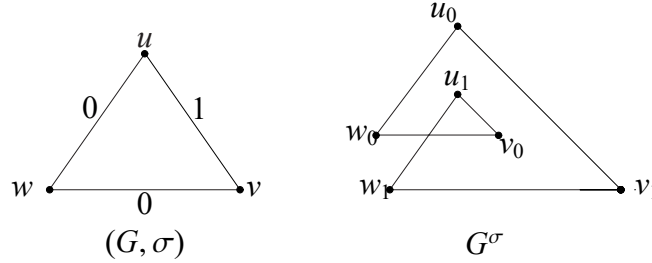

Fig.6.1.1

We can find easily that there is a unique lifting path in Γ^l with an initial point \tilde{x} for each path with an initial point x in Γ , and for $\forall x \in \Gamma$, $|p^{-1}(x)| = 2$.

For finding a homomorphism between Klein surfaces, voltage maps are extensively used, which is introduced by Gustin in 1963 and extensively used by Youngs in 1960s for proving the Heawood map coloring theorem and generalized by Gross in 1974 ([GrT1]). By applying voltage graphs, the 2-factorable graphs are enumerated in [MaT2] also.

Now we present a formally algebraic definition for voltage maps, not using geometrical intuition following.

Definition 6.1.2 Let $M = (\mathcal{X}_{\alpha,\beta}, \mathcal{P})$ be a map and $(\Gamma; \circ)$ a finite group. A pair (M, ϑ) is a voltage map with group $(\Gamma; \circ)$ if $\vartheta : \mathcal{X}_{\alpha,\beta} \rightarrow \Gamma$, satisfying conditions following:

- (1) For $\forall x \in \mathcal{X}_{\alpha,\beta}$, $\vartheta(\alpha x) = \vartheta(x)$, $\vartheta(\alpha\beta x) = \vartheta(\beta x) = \vartheta^{-1}(x)$;
- (2) For $\forall F = (x, y, \dots, z)(\beta z, \dots, \beta y, \beta x) \in F(M)$, the face set of M , $\vartheta(F) = \vartheta(x)\vartheta(y) \cdots \vartheta(z)$ and $\langle \vartheta(F) | F \in \mathcal{F}(u), u \in V(M) \rangle = \Gamma$, where $\mathcal{F}(u)$ denotes all the faces incident with vertex u .

For a voltage map (M, ϑ) , define

$$\mathcal{X}_{\alpha^\vartheta, \beta^\vartheta} = \mathcal{X}_{\alpha,\beta} \times \Gamma,$$

$$\mathcal{P}^\vartheta = \prod_{(x,y,\dots,z)(\alpha z, \dots, \alpha y, \alpha x) \in V(M)} \prod_{g \in \Gamma} (x_g, y_g, \dots, z_g)(\alpha z_g, \dots, \alpha y_g, \alpha x_g)$$

and

$$\alpha^\vartheta = \prod_{x \in \mathcal{X}_{\alpha,\beta}, g \in \Gamma} (x_g, \alpha x_g), \quad \beta^\vartheta = \prod_{x \in \mathcal{X}_{\alpha,\beta}, g \in \Gamma} (x_g, \beta x_{g\vartheta(x)}),$$

where u_g denotes the element $(u, g) \in \mathcal{X}_{\alpha,\beta} \times \Gamma$.

Then it can be shown immediately that $M^\vartheta = (\mathcal{X}_{\alpha^\vartheta, \beta^\vartheta}, \mathcal{P}^\vartheta)$ also satisfies the conditions of map, and with the same orientation as map M . Whence, we define the lifting map of a voltage map in the following definition.

Definition 6.1.3 *Let (M, ϑ) be a voltage map with group $(\Gamma; \circ)$. Then the map $M^\vartheta = (\mathcal{X}_{\alpha^\vartheta, \beta^\vartheta}, \mathcal{P}^\vartheta)$ is defined to be the lifting map of (M, ϑ) .*

There is a natural projection $\pi : M^\vartheta \rightarrow M$ from the lifted map M^ϑ to M by $\pi(x_g) = x$ for $\forall g \in \Gamma$ and $x \in \mathcal{X}_{\alpha, \beta}(M)$, which means that M^ϑ is a $|\Gamma|$ -cover M . Denote by

$$\pi^{-1}(x) = \{ x_g \in \mathcal{X}_{\alpha, \beta}(M^\vartheta) \mid g \in \Gamma \},$$

called the *fiber* over $x \in \mathcal{X}_{\alpha, \beta}(M)$. For a vertex $v = (C)(\alpha C \alpha^{-1}) \in V(M)$, let $\{C\}$ denote the set of quadricells in cycle C . Then the following result is obvious by definition.

Theorem 6.1.7 *The numbers of vertices and edges in a lifting map M^ϑ of voltage map (M, ϑ) with group $(\Gamma; \circ)$ are respectively*

$$v(M^\vartheta) = v(M)|\Gamma| \text{ and } \varepsilon(M^\vartheta) = \varepsilon(M)|\Gamma|.$$

Theorem 6.1.8 *Let $F = (C^*)(\alpha C^* \alpha^{-1})$ be a face in the map M . Then there are $|\Gamma|/o(F)$ faces in the lifting map M^ϑ with group $(\Gamma; \circ)$ of length $|F|o(F)$ lifted from the face F , where $o(F)$ denotes the order of $\prod_{x \in \{C\}} \vartheta(x)$ in group $(\Gamma; \circ)$.*

Proof Let $F = (u, v \cdots, w)(\beta w, \cdots, \beta v, \beta u)$ be a face in the map M and k is the length of F . Then, for $\forall g \in \Gamma$ the conjugate cycles

$$\begin{aligned} (C^*)^\vartheta &= (u_g, v_{g\vartheta(u)}, \cdots, u_{g\vartheta(F)}, v_{g\vartheta(F)\vartheta(u)}, \cdots, w_{g\vartheta(F)^2}, \cdots, w_{g\vartheta^{o(F)-1}(F)}) \\ &\quad \beta(u_g, v_{g\vartheta(u)}, \cdots, u_{g\vartheta(F)}, v_{g\vartheta(F)\vartheta(u)}, \cdots, w_{g\vartheta(F)^2}, \cdots, w_{g\vartheta^{o(F)-1}(F)})^{-1} \beta^{-1}. \end{aligned}$$

is a face in M^ϑ with length $ko(F)$ by definition. Therefore, there are $|\Gamma|/o(F)$ faces in the lifting map M^ϑ . \square

We therefore get the Euler-Poincaré characteristic of a lifted map following.

Theorem 6.1.9 *The Euler-Poincaré characteristic $\chi(M^\vartheta)$ of the lifting map M^ϑ of a voltage map (M, ϑ) with group $(\Gamma; \circ)$ is*

$$\chi(M^\vartheta) = |\Gamma|(\chi(M) + \sum_{m \in O(F(M))} (-1 + \frac{1}{m})),$$

where $O(F(M))$ denotes the set of faces in M of order $o(F)$.

Proof According to the Theorems 6.1.7 and 6.1.8, the lifting map M^θ has $|\Gamma|v(M)$ vertices, $|\Gamma|\varepsilon(M)$ edges and $|G| \sum_{m \in O(F(M))} \frac{1}{m}$ faces. Therefore, we know that

$$\begin{aligned}
 \chi(M^\theta) &= v(M^\theta) - \varepsilon(M^\theta) + \phi(M^\theta) \\
 &= |\Gamma|v(M) - |\Gamma|\varepsilon(M) + |\Gamma| \sum_{m \in O(F(M))} \frac{1}{m} \\
 &= |G|(\chi(M) - \phi(M) + \sum_{m \in O(F(M))} \frac{1}{m}) \\
 &= |G|(\chi(M) + \sum_{m \in O(F(M))} (-1 + \frac{1}{m})). \quad \square
 \end{aligned}$$

§6.2 GROUP BEING THAT OF A MAP

6.2.1 Lifting Map Automorphism. Let (M, σ) be a voltage map with $\sigma : \mathcal{X}_{\alpha,\beta} \rightarrow \Gamma$, $u \in V(M)$ and $W = x_1x_2 \cdots x_k$ a walk encoded by the corresponding sequence of quadricells x_i , $i = 1, 2, \dots, k$ in M , i.e., the quadricell after x_i is $\mathcal{P}\alpha\beta x_i$ by the traveling ruler on M . Define the *net voltage* on W to be the product

$$\sigma(W) = \sigma(x_1) \circ \sigma(x_2) \circ \cdots \circ \sigma(x_k)$$

and the local voltage group $\Gamma(u)$ by

$$\Gamma(u) = \{ \sigma(W) \mid W \text{ is a closed walk based at a quadricell } u \}.$$

By Definition 6.1.2, we know that $\Gamma(u) = \Gamma$ for $\forall u \in \mathcal{X}_{\alpha,\beta}(M)$. For $x \in \mathcal{X}_{\alpha,\beta}$, denote by $\Pi(M, x)$ the set of all such closed walks based at x . Then $\Pi(M, x) = \pi_1(M, x)$, the fundamental group of M based at x .

Let $\sigma_1, \sigma_2 : \mathcal{X}_{\alpha,\beta} \rightarrow \Gamma$ be two voltage assignments on a map $M = (\mathcal{X}_{\alpha,\beta}, \mathcal{P})$ and id_M an identity transformation on $\mathcal{X}_{\alpha,\beta}$, i.e., both of M^{σ_1} and M^{σ_2} are $|\Gamma|$ -covers of M with natural projections $\pi_1 : M^{\sigma_1} \rightarrow M$ and $\pi_2 : M^{\sigma_2} \rightarrow M$ on M . Then we know

$$\mathcal{X}_{\alpha,\beta}(M^{\sigma_1}) = \mathcal{X}_{\alpha,\beta}(M^{\sigma_2}) = \{ x_g \mid x \in \mathcal{X}_{\alpha,\beta}(M), g \in \Gamma \}$$

by definition. Then σ_1, σ_2 are said to be *equivalent* if there exists an isomorphism $\tau : M^{\sigma_1} \rightarrow M^{\sigma_2}$ that makes the following diagram

$$\begin{array}{ccc}
 M^{\sigma_1} & \xrightarrow{\tau} & M^{\sigma_2} \\
 \pi_1 \downarrow & & \downarrow \pi_2 \\
 M & \xrightarrow{id_M} & M
 \end{array}$$

commutate. The following result is fundamental.

Theorem 6.2.1 *Let $\sigma_1, \sigma_2 : \mathcal{X}_{\alpha,\beta} \rightarrow \Gamma$ be two voltage assignments on a map $M = (\mathcal{X}_{\alpha,\beta}, \mathcal{P})$, $u \in \mathcal{X}_{\alpha,\beta}(M)$. Then σ_1, σ_2 are equivalent if and only if there exists an automorphism τ of group Γ such that*

$$\tau\sigma_1(W) = \sigma_2(W)$$

for every closed walk W in M based at u .

Proof Choose a closed walk W in map M based at u . If σ_1 and σ_2 are equivalent, then there exists an automorphism $\tau : M^{\sigma_1} \rightarrow M^{\sigma_2}$ such that $\tau(W^{\sigma_1}) = W^{\sigma_2}$. Define $\tau^* : \Gamma \rightarrow \Gamma$ by $\tau^* : \tau\sigma_1(W) \rightarrow \sigma_2(W)$. Let W' be another closed walk in M based at u . Notice that WW' is also a closed walk based at u in M . We find that

$$\tau\sigma_1(WW') = \tau\sigma_1(W)\tau\sigma_1(W') = \sigma_2(W)\sigma_2(W'),$$

i.e., $\tau^*(\sigma_1(W)\sigma_1(W')) = \tau^*(\sigma_1(W))\tau^*(\sigma_1(W'))$. Thus τ^* is an automorphism of Γ . By definition, we are easily get that $\tau^*\sigma_1(W) = \sigma_2(W)$.

Conversely, if there exists an automorphism $\tau' \in \text{Aut}\Gamma$ such that $\tau'\sigma_1(W) = \sigma_2(W)$ for every closed walk W in M based at u , let $\tau : \mathcal{X}_{\alpha,\beta}(M^{\sigma_1}) \rightarrow \mathcal{X}_{\alpha,\beta}(M^{\sigma_1})$ be determined by $\tau : W^{\tau'\sigma_1} \rightarrow W^{\sigma_2}$, i.e., $\tau'\sigma_1 W(\tau'\sigma_1)^{-1} = \sigma_2 W\sigma_2^{-1}$. Then it is easily to know that

$$\begin{aligned}
 \tau(\mathcal{P}\alpha\beta)^{\sigma_1} \tau^{-1} &= (\tau'\sigma_1) \left(\prod_{(x,\dots,z)(\alpha z,\dots,\alpha x) \in V(M), g \in \Gamma} (x_g, \dots, z_g)(\alpha z_g, \dots, \alpha x_g) \right) (\tau'\sigma_1)^{-1} \\
 &= \prod_{(x,y,\dots,z)(\alpha z,\dots,\alpha y,\alpha x) \in V(M), g \in \Gamma} \tau'\sigma_1(x_g, y_g, \dots, z_g)(\alpha z_g, \dots, \alpha y_g, \alpha x_g) (\tau'\sigma_1)^{-1} \\
 &= \prod_{(x,\dots,z)(\alpha z,\dots,\alpha x) \in V(M), g \in \Gamma} \sigma_2(x_g, y_g, \dots, z_g)(\alpha z_g, \dots, \alpha y_g, \alpha x_g) \sigma_2^{-1} \\
 &= (\mathcal{P}\alpha\beta)^{\sigma_2}
 \end{aligned}$$

i.e.,

$$\mathcal{P}^{\sigma_1}\tau = \tau\mathcal{P}^{\sigma_2}$$

and

$$\alpha^{\sigma_1}\tau = \tau\alpha^{\sigma_2}, \quad \beta^{\sigma_1}\tau = \tau\beta^{\sigma_2}.$$

Thus τ is an isomorphism from M^{σ_1} to M^{σ_2} by definition. Whence, we know that σ_1 and σ_2 are equivalent. \square

Such an isomorphism τ from M^{σ_1} to M^{σ_2} induced by an automorphism τ' of M is called a lifted isomorphism of τ' . Particularly, if $\sigma_1 = \sigma_2 = \sigma$, a lifted isomorphism from M^{σ_1} to M^{σ_2} is called a *lifted automorphism* of τ' . Theorem 6.2.1 enables one to get the following result.

Theorem 6.2.2 *An automorphism ϕ of voltage map M with assignment $\sigma \rightarrow \Gamma$ is a lifted automorphism of map M^σ if and only if every closed walk W with net voltage $\sigma(W) = 1_\Gamma$ implies that $\sigma(\phi(W)) = 1_\Gamma$ in (M, σ) .*

Furthermore, let $M = (\mathcal{X}_{\alpha,\beta}, \mathcal{P})$ be a map, $(\Gamma; \circ)$ a finite group and $\mathcal{A} \leq \text{Aut}M$, a map group. We say that a voltage assignment $\sigma : \mathcal{X}_{\alpha,\beta} \rightarrow \Gamma$ is *locally \mathcal{A} -invariant* at a quadricell u if, for $\forall \tau \in \mathcal{A}$ and every walk $W \in \Pi(M, u)$, we have

$$\sigma(W) = 1_\Gamma \Rightarrow \sigma(\tau(W)) = 1_\Gamma.$$

Particularly, a voltage assignment is *locally τ -invariant* for $\tau \in \text{Aut}M$ if it is locally invariant respect to the group $\langle \tau \rangle$ generated by τ . Then Theorem 6.2.2 implies the following conclusion.

Corollary 6.2.1 *Let $M = (\mathcal{X}_{\alpha,\beta}, \mathcal{P})$ be a map with a voltage assignment $\sigma : \mathcal{X}_{\alpha,\beta} \rightarrow \Gamma$, $\pi : M^\sigma \rightarrow M$ and $\mathcal{A} \leq \text{Aut}M$. Then $\mathcal{A} \leq \text{Aut}M^\sigma$ if and only if σ is locally \mathcal{A} -invariant.*

Notice that a map $M = (\mathcal{X}_{\alpha,\beta}, \mathcal{P})$ is regular if $|\text{Aut}M| = |\mathcal{X}_{\alpha,\beta}|$. We know the following result by Corollary 6.2.1.

Corollary 6.2.2 *Let M be a regular map with a locally $\text{Aut}M$ -invariant voltage assignment $\sigma : \mathcal{X}_{\alpha,\beta} \rightarrow \Gamma$. Then M^σ is also regular.*

Proof Notice that the action $\tilde{g} : u_h \rightarrow u_{goh}$ naturally induced an automorphism on fiber $\pi^{-1}(u)$ of M^σ for $\forall u \in \mathcal{X}_{\alpha,\beta}$ and $g \in \Gamma$. Now all automorphisms of M are lifted to M^σ . Whence, $|\text{Aut}M^\sigma| = |\Gamma||\text{Aut}M| = 4|\Gamma|\varepsilon(M) = |\mathcal{X}_{\alpha,\beta}(M^\sigma)|$. Thus M^σ is a regular map. \square

6.2.2 Map Exponent Group. Let $M = (\mathcal{X}_{\alpha,\beta}, \mathcal{P})$ be a map. An integer k is an *exponent* of M if the map $M^k = (\mathcal{X}_{\alpha,\beta}, \mathcal{P}^k)$ is isomorphic to M , i.e., there exists a permutation τ on $\mathcal{X}_{\alpha,\beta}$ such that $\tau\alpha = \alpha\tau$, $\tau\beta = \beta\tau$ and $\tau\mathcal{P}^k = \mathcal{P}\tau$. Such a permutation $\tau \in \text{Aut}_{\frac{1}{2}}G[M]$ is called an isomorphism associated with exponent k .

If k is an exponent of M , then \mathcal{P}^k is also a basic permutation on $\mathcal{X}_{\alpha,\beta}$ with Axioms 1 – 2 hold. So $\text{gcd}(k, \rho_M(v)) = 1$ for $v \in V(M)$. Consequently, k must be a coprime with the order $o(\mathcal{P})$ of \mathcal{P} , the least common multiple of valencies of vertices in M .

Obviously, 1 is an exponent of M . On the other hand, the integer -1 is an exponent if M is isomorphic to its mirror $(\mathcal{X}_{\alpha,\beta}, \mathcal{P}^{-1})$. Now let $l \equiv k(\text{mod } o(\mathcal{P}))$ and k an exponent of M . Then $\mathcal{P}^l = \mathcal{P}^k$. Thus l is also an exponent of M . Let k, l be two exponents associated with isomorphisms τ, θ , respectively. Then

$$\mathcal{P}^{kl}\theta\tau = (\mathcal{P}^k)^l\theta\tau = \theta\mathcal{P}^l\tau = \theta\tau\mathcal{P},$$

i.e., kl is also an exponent of M associated with isomorphism $\theta\tau \in \text{Aut}_{\frac{1}{2}}G[M]$. We therefore find the following result.

Theorem 6.2.3 *Let M be a map. Then all residue classes of exponents $\text{mod}(o(\mathcal{P}))$ of M form a group, and all isomorphisms associated with exponents of M form a subgroup of $\text{Aut}_{\frac{1}{2}}G[M]$, denoted by $\text{Ex}(M)$ and $\text{Exo}(M)$, respectively.*

Now let $(\Gamma; \circ)$ be a finite group and let $\iota : \Gamma \rightarrow \text{Ex}(M)$, $\Psi : \text{Exo}(M) \rightarrow \text{Ex}(M)$ be homomorphisms with $\text{Ker}\Psi = \text{Aut}M = A$. Denote by $A_J = \Psi^{-1}(J)$, where $J = \iota(\Gamma)$. Then the *derived map* $M^{\sigma,\iota}$ is a map $(\mathcal{X}_{\alpha^{\sigma,\iota}, \beta^{\sigma,\iota}}, \mathcal{P}^{\sigma,\iota})$ with

$$\mathcal{X}_{\alpha^{\sigma,\iota}, \beta^{\sigma,\iota}} = \mathcal{X}_{\alpha,\beta} \times \Gamma$$

and

$$\mathcal{P}^{\sigma,\iota} = \prod_{(x,y,\dots,z)(\alpha z, \dots, \alpha y, \alpha x) \in V(M), g \in \Gamma} ((x_g, y_g, \dots, z_g)(\alpha z_g, \dots, \alpha y_g, \alpha x_g))^{\iota(g)},$$

$$\alpha^{\sigma,\iota} = \prod_{x \in \mathcal{X}_{\alpha,\beta}, g \in \Gamma} (x_g, \alpha x_g), \quad \beta^{\sigma,\iota} = \prod_{x \in \mathcal{X}_{\alpha,\beta}, g \in \Gamma} (x_g, \beta x_{g\theta(x)}).$$

A voltage assignment $\sigma : \mathcal{X}_{\alpha,\beta}(M) \rightarrow \Gamma$ is called A_J -uniform if for every u -based closed walk W on M with $\sigma(W) = 1_\Gamma$ and every isomorphism $\tau \in A_J$, one has $\sigma(\tau(W)) = 1_\Gamma$. Similarly, an exponent homomorphism τ of M is A_J -compatible with σ if for every u -based walk W and every $\tau \in A_J$, one always has $\iota\sigma(W) = \iota\sigma(\tau(W))$. Then we have the following result.

Theorem 6.2.4 *Let M be an orientable regular map, $\sigma : \mathcal{X}_{\alpha,\beta}(M) \rightarrow \Gamma$ a voltage assignment and $\iota : \Gamma \rightarrow \text{Ex}(M)$ with $\iota(\Gamma) = J$. Then $M^{\sigma,\iota}$ is an orientable regular map if σ is A_J -uniform and τ is A_J -compatible with σ .*

A complete proof of theorem 6.2.4 was established in [NeS2]. Certainly, the reader can find more results on constructing regular maps by graphs in [NeS1]-[NeS2].

6.2.3 Group being That of a Lifted Map. A permutation group Γ action on Ω is called *fixed-free* if $\Gamma_x = 1_\Gamma$ for $\forall x \in \Omega$. We have the following result on fixed-free permutation group.

Lemma 6.2.1 *Any automorphism group Γ of a map $M = (\mathcal{X}_{\alpha,\beta}, \mathcal{P})$ is fixed-free on $\mathcal{X}_{\alpha,\beta}$.*

Proof Notice that $\Gamma \leq \text{Aut}M$, we get that $\Gamma_x \leq (\text{Aut}M)_x$ for $\forall x \in \mathcal{X}_{\alpha,\beta}$. We have known that $(\text{Aut}M)_x = 1_\Gamma$. Whence, there must be that $\Gamma_x = 1_\Gamma$, i.e., Γ is fixed-free. \square

Notice that the automorphism group of a lifted map has a obvious subgroup determined by the following lemma.

Lemma 6.2.2 *Let M^ϑ be a lifted map of a voltage assignment $\vartheta : \mathcal{X}_{\alpha,\beta} \rightarrow \Gamma$. Then Γ is isomorphic to a fixed-free subgroup of $\text{Aut}M^\vartheta$ on $V(M^\vartheta)$.*

Proof For $\forall g \in \Gamma$, we prove that the induced action $g^* : \mathcal{X}_{\alpha^\vartheta,\beta^\vartheta} \rightarrow \mathcal{X}_{\alpha^\vartheta,\beta^\vartheta}$ by $g^* : x_h \rightarrow x_{gh}$ is an automorphism of map M^ϑ .

In fact, g^* is a mapping on $\mathcal{X}_{\alpha^\vartheta,\beta^\vartheta}$ and for $\forall x_u \in \mathcal{X}_{\alpha^\vartheta,\beta^\vartheta}$, we know that $g^* : x_{g^{-1}u} \rightarrow x_u$.

Now if for $x_h, y_f \in \mathcal{X}_{\alpha^\vartheta,\beta^\vartheta}$, $x_h \neq y_f$, we have that $g^*(x_h) = g^*(y_f)$. Thus $x_{gh} = y_{gf}$ by the definition. So we must have $x = y$ and $gh = gf$, i.e., $h = f$. Whence, $x_h = y_f$, contradicts to the assumption. Therefore, g^* is 1-1 on $\mathcal{X}_{\alpha^\vartheta,\beta^\vartheta}$.

We prove that for $x_u \in \mathcal{X}_{\alpha^\vartheta,\beta^\vartheta}$, g^* is commutative with $\alpha^\vartheta, \beta^\vartheta$ and \mathcal{P}^ϑ . Notice that

$$g^* \alpha^\vartheta x_u = g^*(\alpha x)_u = (\alpha x)_{gu} = \alpha x_{gu} = \alpha g^*(x_u);$$

$$g^* \beta^\vartheta(x_u) = g^*(\beta x)_{u\vartheta(x)} = (\beta x)_{gu\vartheta(x)} = \beta x_{gu\vartheta(x)} = \beta^\vartheta(x_{gu}) = \beta^\vartheta g^*(x_u)$$

and

$$\begin{aligned} & g^* \mathcal{P}^\vartheta(x_u) \\ &= g^* \prod_{(x,y,\dots,z)(\alpha z,\dots,\alpha y,\alpha x) \in V(M)} \prod_{u \in G} (x_u, y_u, \dots, z_u)(\alpha z_u, \dots, \alpha y_u, \alpha x_u)(x_u) \\ &= g^* y_u = y_{gu} \end{aligned}$$

$$\begin{aligned}
 &= \prod_{(x,y,\dots,z)(\alpha z,\dots,\alpha y,\alpha x) \in V(M)} \prod_{gu \in G} (x_{gu}, y_{gu}, \dots, z_{gu})(\alpha z_{gu}, \dots, \alpha y_{gu}, \alpha x_{gu})(x_{gu}) \\
 &= \mathcal{P}^\theta(x_{gu}) = \mathcal{P}^\theta g^*(x_u).
 \end{aligned}$$

Therefore, g^* is an automorphism of the lifted map M^θ .

To see that g^* is fixed-free on $V(M)$, choose $\forall u = (x_h, y_h, \dots, z_h)(\alpha z_h, \dots, \alpha y_h, \alpha x_h) \in V(M), h \in \Gamma$. If $g^*(u) = u$, i.e.,

$$(x_{gh}, y_{gh}, \dots, z_{gh})(\alpha z_{gh}, \dots, \alpha y_{gh}, \alpha x_{gh}) = (x_h, y_h, \dots, z_h)(\alpha z_h, \dots, \alpha y_h, \alpha x_h),$$

assume that $x_{gh} = w_h$, where $w_h \in \{x_h, y_h, \dots, z_h, \alpha x_h, \alpha y_h, \dots, \alpha z_h\}$. By definition, there must be that $x = w$ and $gh = h$. Therefore, $g = 1_\Gamma$, i.e., $\forall g \in \Gamma, g^*$ is fixed-free on $V(M)$. Define $\tau : g^* \rightarrow g$. Then τ is an isomorphism between the action of elements in Γ on $\mathcal{X}_{\alpha^\theta, \beta^\theta}$ and the group Γ itself. \square

According to Lemma 6.2.1, for a given map M and a group $\Gamma \leq \text{Aut}M$, we define a quotient map $M/\Gamma = (\mathcal{X}_{\alpha, \beta}/\Gamma, \mathcal{P}/\Gamma)$ as follows.

$$\mathcal{X}_{\alpha, \beta}/\Gamma = \{x^\Gamma | x \in \mathcal{X}_{\alpha, \beta}\},$$

where x^Γ denotes the orbit of Γ action on x in $\mathcal{X}_{\alpha, \beta}$ and

$$\mathcal{P}/\Gamma = \prod_{(x,y,\dots,z)(\alpha z,\dots,\alpha y,\alpha x) \in V(M)} (x^\Gamma, y^\Gamma, \dots)(\dots, \alpha y^\Gamma, \alpha x^\Gamma)$$

since Γ action on $\mathcal{X}_{\alpha, \beta}$ is fixed-free.

Such a map M may be not a regular covering of its quotient M/Γ . We have the following result characterizing fixed-free automorphism groups of map on $V(M)$.

Theorem 6.2.5 *An finite group $(\Gamma; \circ)$ is a fixed-free automorphism group of map $M = (\mathcal{X}_{\alpha, \beta}, \mathcal{P})$ on $V(M)$ if and only if there is a map $(M/\Gamma, \Gamma)$ with a voltage assignment $\vartheta : \mathcal{X}_{\alpha, \beta}/\Gamma \rightarrow \Gamma$ such that $M \cong (M/\Gamma)^\vartheta$.*

Proof The necessity of the condition is already proved in the Lemma 2.2.2. We only need to prove its sufficiency.

Denote by $\pi : M \rightarrow M/\Gamma$ the quotient mapping from M to M/Γ . For each element of $\pi^{-1}(x^\Gamma)$, we give it a label. Choose $x \in \pi^{-1}(x^\Gamma)$. Assign its label $l : x \rightarrow x_{1_\Gamma}$, i.e., $l(x) = x_{1_\Gamma}$. Since the group Γ acting on $\mathcal{X}_{\alpha, \beta}$ is fixed-free, if $u \in \pi^{-1}(x^\Gamma)$ and $u = g(x), g \in \Gamma$, we label u with $l(u) = x_g$. Whence, each element in $\pi^{-1}(x^\Gamma)$ is labeled by a unique element in Γ .

Now we assign voltages on the quotient map $M/\Gamma = (\mathcal{X}_{\alpha,\beta}/\Gamma, \mathcal{P}/\Gamma)$. If $\beta x = y, y \in \pi^{-1}(y^\Gamma)$ and the label of y is $l(y) = y_h^*, h \in \Gamma$, where, $l(y^*) = \mathbf{1}_\Gamma$, then we assign a voltage h on x^Γ , i.e., $\vartheta(x^\Gamma) = h$. We should prove this kind of voltage assignment is well-done, which means that we must prove that for $\forall v \in \pi^{-1}(x^\Gamma)$ with $l(v) = j, j \in \Gamma$, the label of βv is $l(\beta v) = jh$. In fact, by the previous labeling technique, we know that the label of βv is

$$l(\beta v) = l(\beta gx) = l(g\beta x) = l(gy) = l(ghy^*) = gh.$$

Denote by M^l the labeled map M on each element in $\mathcal{X}_{\alpha,\beta}$. Whence, $M^l \cong M$. By the previous voltage assignment, we also know that M^l is a lifting of the quotient map M/Γ with the voltage assignment $\vartheta : \mathcal{X}_{\alpha,\beta}/\Gamma \rightarrow \Gamma$. Therefore,

$$M \cong (M/\Gamma)^\vartheta.$$

This completes the proof. □

According to the Theorem 6.2.5, we get the following result for a group to be a map group.

Theorem 6.2.6 *If a group $\Gamma \leq \text{Aut}M$ is fixed-free on $V(M)$, then*

$$|\Gamma|(\chi(M/\Gamma) + \sum_{m \in \mathcal{O}(F(M/\Gamma))} (-1 + \frac{1}{m})) = \chi(M).$$

Proof By the Theorem 6.2.5, we know that there is a voltage assignment ϑ on the quotient map M/Γ such that

$$M \cong (M/\Gamma)^\vartheta.$$

Applying Theorem 6.1.9, we know the Euler characteristic of map M is

$$\chi(M) = |\Gamma|(\chi(M/\Gamma) + \sum_{m \in \mathcal{O}(F(M/\Gamma))} (-1 + \frac{1}{m})). \quad \square$$

Theorem 6.2.6 has some applications for determining the automorphism group of a map such as those of results following.

Corollary 6.2.3 *If M is an orientable map of genus p , $\Gamma \leq \text{Aut}M$ is fixed-free on $V(M)$ and the genus of the quotient map M/Γ is γ , then*

$$|\Gamma| = \frac{2p - 2}{2\gamma - 2 + \sum_{m \in \mathcal{O}(F(M/\Gamma))} (1 - \frac{1}{m})}.$$

Particularly, if M/Γ is planar, then

$$|\Gamma| = \frac{2p - 2}{-2 + \sum_{m \in \mathcal{O}(F(M/\Gamma))} (1 - \frac{1}{m})}.$$

Corollary 6.2.4 *If M is a non-orientable map of genus q , $\Gamma \leq \text{Aut}M$ is fixed-free on $V(M)$ and the genus of the quotient map M/Γ is δ , then*

$$|\Gamma| = \frac{q - 2}{\delta - 2 + \sum_{m \in \mathcal{O}(F(M/\Gamma))} (1 - \frac{1}{m})}.$$

Particularly, if M/Γ is projective planar, then

$$|\Gamma| = \frac{q - 2}{-1 + \sum_{m \in \mathcal{O}(F(M/\Gamma))} (1 - \frac{1}{m})}.$$

By applying Theorem 6.2.5, we can also find the Euler characteristic of the quotient map, which enables us to get the following result for a group being that of map.

Theorem 6.2.7 *If a group $\Gamma \leq \text{Aut}M$, then*

$$\chi(M) + \sum_{g \in \Gamma, g \neq 1_\Gamma} (|\Phi_v(g)| + |\Phi_f(g)|) = |\Gamma|\chi(M/\Gamma),$$

where, $\Phi_v(g) = \{v | v \in V(M), v^g = v\}$, $\Phi_f(g) = \{f | f \in F(M), f^g = f\}$, and if Γ is fixed-free on $V(M)$, then

$$\chi(M) + \sum_{g \in \Gamma, g \neq 1_\Gamma} |\Phi_f(g)| = |\Gamma|\chi(M/\Gamma).$$

Proof By the definition of quotient map, we know that

$$\phi_v(M/\Gamma) = orb_v(\Gamma) = \frac{1}{|\Gamma|} \sum_{g \in \Gamma} |\Phi_v(g)|$$

and

$$\phi_f(M/\Gamma) = orb_f(\Gamma) = \frac{1}{|\Gamma|} \sum_{g \in \Gamma} |\Phi_f(g)|,$$

by applying the Burnside lemma. Since Γ is fixed-free on $\mathcal{X}_{\alpha,\beta}$ by Lemma 6.1.4, we also know that

$$\varepsilon(M/\Gamma) = \frac{\varepsilon(M)}{|\Gamma|}.$$

Applying the Euler-Poincaré formula for the quotient map M/Γ , we get that

$$\frac{\sum_{g \in \Gamma} |\Phi_v(g)|}{|\Gamma|} - \frac{\varepsilon(M)}{|\Gamma|} + \frac{\sum_{g \in \Gamma} |\Phi_f(g)|}{|\Gamma|} = \chi(M/\Gamma).$$

Whence,

$$\sum_{g \in \Gamma} |\Phi_v(g)| - \varepsilon(M) + \sum_{g \in \Gamma} |\Phi_f(g)| = |\Gamma| \chi(M/\Gamma).$$

Notice that $\nu(M) = |\Phi_v(1_\Gamma)|$, $\phi(M) = |\Phi_f(1_\Gamma)|$ and $\nu(M) - \varepsilon(M) + \phi(M) = \chi(M)$. We find that

$$\chi(M) + \sum_{g \in \Gamma, g \neq 1_\Gamma} (|\Phi_v(g)| + |\Phi_f(g)|) = |\Gamma| \chi(M/\Gamma).$$

Furthermore, if Γ is fixed-free on $V(M)$, by Theorem 6.2.5 there is a voltage assignment ϑ on the quotient map M/Γ such that $M \cong (M/G)^\vartheta$. According to Theorem 6.1.7, there must be

$$\nu(M/\Gamma) = \frac{\nu(M)}{|\Gamma|}.$$

Whence, $\sum_{g \in \Gamma} |\Phi_v(g)| = \nu(M)$ and $\sum_{g \in \Gamma, g \neq 1_\Gamma} (|\Phi_v(g)|) = 0$. Therefore, we get that

$$\chi(M) + \sum_{g \in \Gamma, g \neq 1_\Gamma} |\Phi_f(g)| = |\Gamma| \chi(M/\Gamma). \quad \square$$

Consider the action properties of group Γ on $F(M)$, we immediately get some interesting results following.

Corollary 6.2.5 *If $\Gamma \leq \text{Aut}M$ is fixed-free on $V(M)$ and transitive on $F(M)$, for example, M is regular and $\Gamma = \text{Aut}M$, then M/Γ is an one face map and*

$$\chi(M) = |\Gamma|(\chi(M/\Gamma) - 1) + \phi(M).$$

Corollary 6.2.6 *For an one face map M , if $\Gamma \leq \text{Aut}M$ is fixed-free on $V(M)$, then*

$$\chi(M) - 1 = |\Gamma|(\chi(M/\Gamma) - 1),$$

and $|\Gamma|$. Particularly, $|\text{Aut}M|$ is an integer factor of $\chi(M) - 1$.

Remark 6.2.1 For a one face planar map, i.e., the plane tree, the only fixed-free automorphism group on its vertices is the trivial group by the Corollary 6.2.6.

§6.3 MEASURES ON MAPS

On the classical geometry, a central question is to determine the measures on objects, such as those of the distance, angle, area, volume, curvature, . . . For maps being that of a combinatorial model of Klein surfaces, we also wish to introduce various measures on maps and then enlarge its application to more branches of mathematics.

6.3.1 Angle on Map. For a map $M = (\mathcal{X}_{\alpha,\beta}, \mathcal{P})$, $x \in \mathcal{X}_{\alpha,\beta}$, the permutation pair $\{(x, \mathcal{P}x), (\alpha x, \mathcal{P}^{-1}\alpha x)\}$ is called an *angle* of M incident with x introduced by Tutte in [Tut1]. We prove that any automorphism of a map is a conformal mapping and affirm the Theorem 5.3.12 in Chapter 5 again in this section.

We define the *angle transformation* Θ of a map $M = (\mathcal{X}_{\alpha,\beta}, \mathcal{P})$ by

$$\Theta = \prod_{x \in \mathcal{X}_{\alpha,\beta}} (x, \mathcal{P}x).$$

Then we have

Theorem 6.3.1 *Any automorphism of map $M = (\mathcal{X}_{\alpha,\beta}, \mathcal{P})$ is conformal.*

Proof By the definition, for $\forall g \in \text{Aut}M$ we know that

$$\alpha g = g\alpha, \beta g = g\beta \text{ and } \mathcal{P}g = g\mathcal{P}.$$

Therefore, for $\forall x \in \mathcal{X}_{\alpha,\beta}$,

$$\Theta g(x) = (g(x), \mathcal{P}g(x))$$

and

$$g\Theta(x) = g(x, \mathcal{P}x) = (g(x), \mathcal{P}g(x)).$$

Whence, we get that for $\forall x \in \mathcal{X}_{\alpha,\beta}$, $\Theta g(x) = g\Theta(x)$. So $\Theta g = g\Theta$, i.e., $g\Theta g^{-1} = \Theta$.

Since for $\forall x \in \mathcal{X}_{\alpha,\beta}$, $g\Theta g^{-1}(x) = (g(x), \mathcal{P}g(x))$ and $\Theta(x) = (x, \mathcal{P}(x))$, we get that

$$(g(x), \mathcal{P}g(x)) = (x, \mathcal{P}(x)).$$

Thus g is a conformal mapping. □

6.3.2 Non-Euclid Area on Map. For a voltage map (M, σ) with a assignment $\sigma : \mathcal{X}_{\alpha,\beta}(M) \rightarrow \Gamma$, its *non-Euclid area* $\mu(M, \Gamma)$ is defined by

$$\mu(M, \Gamma) = 2\pi(-\chi(M) + \sum_{m \in O(F(M))} (-1 + \frac{1}{m})).$$

Particularly, since any map M can be viewed as a voltage map $(M, 1_\Gamma)$, we get the non-Euclid area of a map M

$$\mu(M) = \mu(M, 1_\Gamma) = -2\pi\chi(M).$$

Notice that the area of a map is only dependent on the genus of the surface. We know the following result.

Theorem 6.3.2 *Two maps on one surface S have the same non-Euclid area.*

By the non-Euclid area, we find the *Riemann-Hurwitz formula* for map in the following.

Theorem 6.3.3 *If $\Gamma \leq \text{Aut}M$ is fixed-free on $V(M)$, then*

$$|\Gamma| = \frac{\mu(M)}{\mu(M/\Gamma, \vartheta)},$$

where ϑ is constructed in the proof of the Theorem 6.2.5.

Proof According to the Theorem 6.2.6, we know that

$$\begin{aligned} |\Gamma| &= \frac{-\chi(M)}{-\chi(M) + \sum_{m \in O(F(M))} (-1 + \frac{1}{m})} \\ &= \frac{-2\pi\chi(M)}{2\pi(-\chi(M) + \sum_{m \in O(F(M))} (-1 + \frac{1}{m}))} = \frac{\mu(M)}{\mu(M/\Gamma, \vartheta)}. \quad \square \end{aligned}$$

As an interesting result, we can obtain the same result for the non-Euclid area of a triangle as in the classical differential geometry following, seeing [Car1] for details.

Theorem 6.3.4 *The non-Euclid area $\mu(\Delta)$ of a triangle Δ on surface S with internal angles η, θ, σ is*

$$\mu(\Delta) = \eta + \theta + \sigma - \pi.$$

Proof According to the Theorems 4.2.1 and 6.2.5, we can assume that there exists a triangulation M with internal angles η, θ, σ on S , and with an equal non-Euclid area on each triangular disk. Then

$$\begin{aligned} \phi(M)\mu(\Delta) &= \mu(M) = -2\pi\chi(M) \\ &= -2\pi(\nu(M) - \varepsilon(M) + \phi(M)). \end{aligned}$$

Since M is a triangulation, we know that $2\varepsilon(M) = 3\phi(M)$. Notice that the sum of all the angles in the triangles on the surface S is $2\pi\nu(M)$. We get that

$$\begin{aligned} \phi(M)\mu(\Delta) &= -2\pi(\nu(M) - \varepsilon(M) + \phi(M)) = (2\nu(M) - \phi(M))\pi \\ &= \sum_{i=1}^{\phi(M)} [(\eta + \theta + \sigma) - \pi] = \phi(M)(\eta + \theta + \sigma - \pi). \end{aligned}$$

Whence, $\mu(\Delta) = \eta + \theta + \sigma - \pi$. □

§6.4 A COMBINATORIAL REFINEMENT OF HURIWITZ THEOREM

6.4.1 Combinatorially Huriwitz Theorem. In 1893, Hurwitz obtained a famous result on orientation-preserving automorphism groups $\text{Aut}^+ S$ of Riemann surfaces S ([BEGG1], [FaK1] and [GrT1]) following:

For a Riemann surface S of genus $g(S) \geq 2$, $\text{Aut}^+ S \leq 84(g(S) - 1)$.

We have established the combinatorial model for Klein surfaces, especially, the Riemann surfaces by maps. Then *what is its combinatorial counterpart? What can we know the bound for the automorphisms group of map?*

For a given graph Γ , a graphical property P is defined to be a family of its subgraphs, such as, regular subgraphs, circuits, trees, stars, wheels, \dots . Let $M = (\mathcal{X}_{\alpha,\beta}, \mathcal{P})$ be a map. Call a subset A of $\mathcal{X}_{\alpha,\beta}$ has the graphical property P if its underlying graph of possesses property P . Denote by $\mathcal{A}(P, M)$ the set of all the A subset with property P in the map M .

For refining the Huriwitz theorem, we get a general combinatorial result in the following.

Theorem 6.4.1 *Let $M = (\mathcal{X}_{\alpha,\beta}, \mathcal{P})$ be a map. Then for $\forall H \leq \text{Aut}M$,*

$$[|v^H| | v \in V(M)] \mid |H|$$

and

$$|H| \mid |A| |\mathcal{A}(P, M)|,$$

where, $[a, b, \dots]$ denotes the least common multiple of a, b, \dots .

Proof According to Theorem 2.1.1(3), for $\forall v \in V(M)$, $|H| = |H_v| |v^H|$. So $|v^H| \mid |H|$. Whence,

$$[|v^H| | v \in V(M)] \mid |H|.$$

We have know that the action of H on $\mathcal{X}_{\alpha,\beta}$ is fixed-free by Theorem 5.3.5, i.e., $\forall x \in \mathcal{X}_{\alpha,\beta}$, there must be $|H_x| = 1$. We consider the action of the automorphism group H on $\mathcal{A}(P, M)$.

Notice that if $A \in \mathcal{A}(P, M)$, then for $\forall g \in H$, $A^g \in \mathcal{A}(P, M)$, i.e., $A^H \subseteq \mathcal{A}(P, M)$. Thus the action of H on $\mathcal{A}(P, M)$ is closed. Whence, we can classify the elements in $\mathcal{A}(P, M)$ by H . For $\forall x, y \in \mathcal{A}(P, M)$, define $x \sim y$ if and only if there is an element $g, g \in H$ such that $x^g = y$.

Since $|H_x| = 1$, i.e., $|x^H| = |H|$, each orbit of H action on $\mathcal{X}_{\alpha,\beta}$ has a same length $|H|$. By the previous discussion, the action of H on $\mathcal{A}(P, M)$ is closed. Therefore, the length of each orbit of H action on $\mathcal{A}(P, M)$ is $|H|$. Notice that there are $|A||\mathcal{A}(P, M)|$ quadricells in $\mathcal{A}(P, M)$. We get that

$$|H| \mid |A||\mathcal{A}(P, M)|.$$

This completes the proof. □

Choose the property P to be tours with each edge appearing at most 2 in the map M . Then we get the following results by the Theorem 6.4.1.

Corollary 6.4.1 *Let $\mathcal{T}r_2$ be the set of tours with each edge appearing 2 times. Then for $H \leq \text{Aut}M$,*

$$|H| \mid (l|\mathcal{T}r_2|, l = |T| = \frac{|T|}{2} \geq 1, T \in \mathcal{T}r_2,).$$

Let $\mathcal{T}r_1$ be the set of tours without repeat edges. Then

$$|H| \mid (2l|\mathcal{T}r_1|, l = |T| = \frac{|T|}{2} \geq 1, T \in \mathcal{T}r_1,).$$

Particularly, denote by $\phi(i, j)$ the number of faces in M with facial length i and singular edges j , then

$$|H| \mid ((2i - j)\phi(i, j), i, j \geq 1),$$

where, (a, b, \dots) denotes the greatest common divisor of a, b, \dots .

Corollary 6.4.2 *Let \mathcal{T} be the set of trees in the map M . Then for $H \leq \text{Aut}M$,*

$$|H| \mid (2lt_l, l \geq 1),$$

where t_l denotes the number of trees with l edges.

Corollary 6.4.3 *Let v_i be the number of vertices with valence i . Then for $H \leq \text{Aut}M$,*

$$|H| \mid (2iv_i, i \geq 1).$$

6.4.2 Application to Klein Surface. Theorem 6.4.1 is a combinatorial refinement of the Hurwitz theorem. Applying it, we can get the automorphism group of map as follows.

Theorem 6.4.2 *Let M be an orientable map of genus $g(M) \geq 2$ and $\Gamma^+ \leq \text{Aut}^+ M$, $\Gamma \leq \text{Aut} M$. Then*

$$|\Gamma^+| \leq 84(g(M) - 1) \quad \text{and} \quad |\Gamma| \leq 168(g(M) - 1).$$

Proof Define the average vertex valence $\overline{\nu(M)}$ and the average face valence $\overline{\phi(M)}$ of a map M by

$$\begin{aligned} \overline{\nu(M)} &= \frac{1}{\nu(M)} \sum_{i \geq 1} i \nu_i, \\ \overline{\phi(M)} &= \frac{1}{\phi(M)} \sum_{j \geq 1} j \phi_j, \end{aligned}$$

where, $\nu(M), \phi(M), \nu_i$ and ϕ_j denote the number of vertices, faces, vertices of valence i and faces of valence j , respectively. Then we know that $\overline{\nu(M)}\nu(M) = \overline{\phi(M)}\phi(M) = 2\varepsilon(M)$. Whence, $\nu(M) = \frac{2\varepsilon(M)}{\overline{\nu(M)}}$ and $\phi(M) = \frac{2\varepsilon(M)}{\overline{\phi(M)}}$. According to the Euler formula, we have that

$$\nu(M) - \varepsilon(M) + \phi(M) = 2 - 2g(M),$$

where, $\varepsilon(M), g(M)$ denote the number of edges and genus of the map M . We get that

$$\varepsilon(M) = \frac{2(g(M) - 1)}{\left(1 - \frac{2}{\overline{\nu(M)}} - \frac{2}{\overline{\phi(M)}}\right)}.$$

Choose the integers $k = \lceil \overline{\nu(M)} \rceil$ and $l = \lceil \overline{\phi(M)} \rceil$. We find that

$$\varepsilon(M) \leq \frac{2(g(M) - 1)}{\left(1 - \frac{2}{k} - \frac{2}{l}\right)}.$$

Because of $1 - \frac{2}{k} - \frac{2}{l} > 0$, So $k \geq 3, l > \frac{2k}{k-2}$. Calculation shows that the minimum value of $1 - \frac{2}{k} - \frac{2}{l}$ is $\frac{1}{21}$ and attains the minimum value if and only if $(k, l) = (3, 7)$ or $(7, 3)$. Therefore,

$$\varepsilon(M \leq 42(g(M) - 1)).$$

According to the Theorem 6.4.1 and its corollaries, we know that $|\Gamma| \leq 4\varepsilon(M)$ and if Γ^+ is orientation-preserving, then $|\Gamma^+| \leq 2\varepsilon(M)$. Whence,

$$|\Gamma| \leq 168(g(M) - 1)$$

and

$$|\Gamma^+| \leq 84(g(M) - 1),$$

with equality hold if and only if $\Gamma = \Gamma^+ = \text{Aut}M$, $(k, l) = (3, 7)$ or $(7, 3)$. \square

For the automorphism of Riemann surface, we have

Corollary 6.4.4 *For any Riemann surface \mathcal{S} of genus $g \geq 2$,*

$$4g(\mathcal{S}) + 2 \leq |\text{Aut}^+\mathcal{S}| \leq 84(g(\mathcal{S}) - 1)$$

and

$$8g(\mathcal{S}) + 4 \leq |\text{Aut}\mathcal{S}| \leq 168(g(\mathcal{S}) - 1).$$

Proof By the Theorems 5.3.11 and 6.4.2, we know the upper bound for $|\text{Aut}\mathcal{S}|$ and $|\text{Aut}^+\mathcal{S}|$. Now we prove the lower bound. We construct a regular map $M_k = (\mathcal{X}_k, \mathcal{P}_k)$ on a Riemann surface of genus $g \geq 2$ as follows, where $k = 2g + 1$.

$$\mathcal{X}_k = \{x_1, x_2, \dots, x_k, \alpha x_1, \alpha x_2, \dots, \alpha x_k, \beta x_1, \beta x_2, \dots, \beta x_k, \alpha\beta x_1, \alpha\beta x_2, \dots, \alpha\beta x_k\}$$

$$\mathcal{P}_k = (x_1, x_2, \dots, x_k, \alpha\beta x_1, \alpha\beta x_2, \dots, \alpha\beta x_k)(\beta x_k, \dots, \beta x_2, \beta x_1, \alpha x_k, \dots, \alpha x_2, \alpha x_1).$$

It can be shown that M_k is a regular map, and its orientation-preserving automorphism group $\text{Aut}^+M_k = \langle \mathcal{P}_k \rangle$. Calculation shows that if $k \equiv 0 \pmod{2}$, M_k has 2 faces, and if $k \equiv 1$, M_k is an one face map. Therefore, By Theorem 5.3.11, we get that

$$|\text{Aut}^+\mathcal{S}| \geq 2\varepsilon(M_k) \geq 4g + 2,$$

and

$$|\text{Aut}\mathcal{S}| \geq 4\varepsilon(M_k) \geq 8g + 4. \quad \square$$

For the non-orientable case, we can also get the bound for the automorphism group of a map.

Theorem 6.4.3 *Let M be a non-orientable map of genus $g'(M) \geq 3$. Then for $\Gamma^+ \leq \text{Aut}^+M$,*

$$|\Gamma^+| \leq 42(g'(M) - 2)$$

and for $\Gamma \leq \text{Aut}M$,

$$|\Gamma| \leq 84(g'(M) - 2),$$

with the equality hold if and only if M is a regular map with vertex valence 3 and face valence 7 or vice via.

Proof Similar to the proof of the Theorem 6.4.2, we can also get that

$$\varepsilon(M \leq 21(g'(M) - 2))$$

and with equality hold if and only if $\Gamma = \text{Aut}M$ and M is a regular map with vertex valence 3, face valence 7 or vice via. According to the Corollary 6.4.3, we get that

$$|\Gamma| \leq 4\varepsilon(M)$$

and

$$|\Gamma^+| \leq 2\varepsilon(M).$$

Whence, for $\Gamma^+ \leq \text{Aut}^+ M$,

$$|\Gamma^+| \leq 42(g'(M) - 2)$$

and for $\Gamma \leq \text{Aut}M$,

$$|\Gamma| \leq 84(g'(M) - 2)$$

with the equality hold if and only if M is a regular map with vertex valence 3 and face valence 7 or vice via. \square

Similar to Hurwitz theorem for that of Riemann surfaces, we can also get the upper bound of Klein surfaces underlying a non-orientable surface.

Corollary 6.4.5 For a Klein surface \mathcal{K} underlying a non-orientable surface of genus $q \geq 3$,

$$|\text{Aut}^+ \mathcal{K}| \leq 42(q - 2)$$

and

$$|\text{Aut} \mathcal{K}| \leq 84(q - 2).$$

§6.5 THE ORDER OF AUTOMORPHISM OF KLEIN SURFACE

6.5.1 The Minimum Genus of a Fixed-Free Automorphism. Harvey [Har1] in 1966, Singerman [Sin1] in 1971 and Bujalance [Buj1] in 1983 considered the order of an automorphism of a Riemann surface of genus $p \geq 2$ and a compact non-orientable Klein

surface without boundary of genus $g \geq 3$. Their approach is by using the Fuchsian groups or *NEC* groups for Klein surfaces. Their approach is by applying the Riemann-Hurwitz equation, i.e., Theorem 4.4.5. Here we restate it in the following:

Let Γ be an *NEC* graph and Γ' a subgroup of Γ with finite index. Then

$$\frac{\mu(\Gamma')}{\mu(\Gamma)} = [\Gamma : \Gamma'],$$

where, $\mu(\Gamma)$ is the non-Euclid area of group Γ defined by

$$\mu(G) = 2\pi[\eta g + k - 2 + \sum_{i=1}^r (1 - 1/m_i) + 1/2 \sum_{i=1}^k \sum_{j=1}^{s_i} (1 - 1/n_{ij})]$$

if the signature of the group Γ is

$$\sigma = (g; \pm; [m_1, \dots, m_r]; \{(n_{11}, \dots, n_{1s_1}), \dots, (n_{k1}, \dots, n_{ks})\}),$$

where, $\eta = 2$ if $\text{sign}(\sigma) = +$ and $\eta = 1$ otherwise.

Notice that we have introduced the conception of non-Euclid area for the voltage maps and have gotten the Riemann-Hurwitz equation in Theorem 6.2.6 for a group action fixed-free on vertices of map. Similarly, we can find the minimum genus of a fixed-free automorphism of a map on its vertex set by the voltage assignment technique on one of its quotient map and get the maximum order of an automorphism of map.

Lemma 6.5.1 Let $N = \prod_{i=1}^k p_i^{r_i}$, $p_1 < p_2 < \dots < p_k$ be the arithmetic decomposition of an integer N and $m_i \geq 1, m_i | N$ for $i = 1, 2, \dots, k$. Then for any integer $s \geq 1$,

$$\sum_{i=1}^s (1 - \frac{1}{m_i}) \geq 2(1 - \frac{1}{p_1}) \lfloor \frac{s}{2} \rfloor.$$

Proof If $s \equiv 0 \pmod{2}$, it is obvious that

$$\sum_{i=1}^s (1 - \frac{1}{m_i}) \geq \sum_{i=1}^s (1 - \frac{1}{p_1}) \geq (1 - \frac{1}{p_1})s.$$

Assume that $s \equiv 1 \pmod{2}$ and there are $m_{i_j} \neq p_1, j = 1, 2, \dots, l$. If the assertion is not true, we must have that

$$(1 - \frac{1}{p_1})(l-1) > \sum_{j=1}^l (1 - \frac{1}{m_{i_j}}) \geq (1 - \frac{1}{p_2})l.$$

Whence,

$$(1 - \frac{1}{p_1})l > (1 - \frac{1}{p_2})l + 1 - \frac{1}{p_1} > (1 - \frac{1}{p_1})l,$$

a contradiction. Therefore, we get that

$$\sum_{i=1}^s (1 - \frac{1}{m_i}) \geq 2(1 - \frac{1}{p_1}) \lfloor \frac{s}{2} \rfloor. \quad \square$$

Lemma 6.5.2 For a map $M = (\mathcal{X}_{\alpha,\beta}, \mathcal{P})$ with $\phi(M)$ faces and $N = \prod_{i=1}^k p_i^{r_i}, p_1 < p_2 < \dots < p_k$, the arithmetic decomposition of an integer N , there exists a voltage assignment $\vartheta : \mathcal{X}_{\alpha,\beta} \rightarrow Z_N$ such that for $\forall F \in F(M)$, $o(F) = p_1$ if $\phi(M) \equiv 0(mod 2)$ or there exists a face $F_0 \in F(M)$ such that $o(F) = p_1$ for $\forall F \in F(M) \setminus \{F_0\}$, but $o(F_0) = 1$.

Proof Assume that f_1, f_2, \dots, f_n are the n faces of the map M , where $n = \phi(M)$. By the definition of voltage assignment, if $x, \beta x$ or $x, \alpha \beta x$ appear on one face $f_i, 1 \leq i \leq n$ altogether, then they contribute to $\vartheta(f_i)$ only with $\vartheta(x)\vartheta^{-1}(x) = 1_{Z_N}$. Whence, not loss of generality, we only need to consider the voltage x_{ij} on the common boundary among the faces f_i and f_j for $1 \leq i, j \leq n$. Then the voltage assignment on the n faces are

$$\begin{aligned} \vartheta(f_1) &= x_{12}x_{13} \cdots x_{1n}, \\ \vartheta(f_2) &= x_{21}x_{23} \cdots x_{2n}, \\ &\dots\dots\dots \\ \vartheta(f_n) &= x_{n1}x_{n2} \cdots x_{n(n-1)}. \end{aligned}$$

We wish to find an assignment on M which can enables us to get as many faces as possible with the voltage of order p_1 . Not loss of generality, we choose $\vartheta^{p_1}(f_1) = 1_{Z_N}$ in the first. To make $\vartheta^{p_1}(f_2) = 1_{Z_N}$, choose $x_{23} = x_{13}^{-1}, \dots, x_{2n} = x_{1n}^{-1}$. If we have gotten $\vartheta^{p_1}(f_i) = 1_{Z_N}$ and $i < n$ if $n \equiv 0(mod 2)$ or $i < n - 1$ if $n \equiv 1(mod 2)$, we can choose that

$$x_{(i+1)(i+2)} = x_{i(i+2)}^{-1}, x_{(i+1)(i+3)} = x_{i(i+3)}^{-1}, \dots, x_{(i+1)n} = x_{in}^{-1},$$

which also make $\vartheta^{p_1}(f_{i+1}) = 1_{Z_N}$.

Now if $n \equiv 0(mod 2)$, this voltage assignment makes each face $f_i, 1 \leq i \leq n$ satisfying that $\vartheta^{p_1}(f_i) = 1_{Z_N}$. But if $n \equiv 1(mod 2)$, it only makes $\vartheta^{p_1}(f_i) = 1_{Z_N}$ for $1 \leq i \leq n - 1$, but $\vartheta(f_n) = 1_{Z_N}$. This completes the proof. □

Now we can find a result on the minimum genus of a fixed-free automorphism of map by Lemmas 6.5.1-6.5.2 following.

Theorem 6.5.1 *Let $M = (\mathcal{X}_{\alpha,\beta}, \mathcal{P})$ be a map and $N = p_1^{r_1} \cdots p_k^{r_k}, p_1 < p_2 < \cdots < p_k$ the arithmetic decomposition of integer N . Then for any voltage assignment $\vartheta : \mathcal{X}_{\alpha,\beta} \rightarrow Z_N$,*

(1) *If M is orientable, the minimum genus g_{min} of the lifted map M^ϑ which admits a fixed-free automorphism on $V(M^\vartheta)$ of order N is*

$$g_{min} = 1 + N\{g(M) - 1 + (1 - \sum_{m \in O(F(M))} \frac{1}{p_1}) \lfloor \frac{\phi(M)}{2} \rfloor\}.$$

(2) *If M is non-orientable, the minimum genus g'_{min} of the lifted map M^ϑ which admits a fixed-free automorphism on $V(M^\vartheta)$ of order N is*

$$g'_{min} = 2 + N\{g(M) - 2 + 2(1 - \frac{1}{p_1}) \lfloor \frac{\phi(M)}{2} \rfloor\}.$$

Proof (1) According to Theorem 6.2.5, we know that

$$2 - 2g(M^\vartheta) = N\{2 - 2g(M) + \sum_{m \in O(F(M))} (-1 + \frac{1}{m})\}.$$

Whence,

$$2g(M^\vartheta) = 2 + N\{2g(M) - 2 + \sum_{m \in O(F(M))} (1 - \frac{1}{m})\}.$$

Applying Lemmas 6.5.1 and 6.5.2, we get that

$$g_{min} = 1 + N\{g(M) - 1 + (1 - \frac{1}{p_1}) \lfloor \frac{\phi(M)}{2} \rfloor\}$$

(2) Similarly, by Theorem 6.2.1, we know that

$$2 - g(M^\vartheta) = N\{2 - g(M) + \sum_{m \in O(F(M))} (-1 + \frac{1}{m})\}.$$

Whence,

$$g(M^\vartheta) = 2 + N\{g(M) - 2 + \sum_{m \in O(F(M))} (1 - \frac{1}{m})\}.$$

Applying Lemmas 6.5.1 and 6.5.2, we get that

$$g'_{min} = 2 + N\{g(M) - 2 + 2(1 - \frac{1}{p_1}) \lfloor \frac{\phi(M)}{2} \rfloor\}. \quad \square$$

6.5.2 The Maximum Order of Automorphisms of a Map. For the maximum order of automorphisms of a map, we have the following result.

Theorem 6.5.2 *The maximum order N_{max} of automorphisms g of an orientable map M with genus ≥ 2 is*

$$N_{max} \leq 2g(M) + 1$$

and the maximum order N'_{max} of automorphisms g of a non-orientable map with genus ≥ 3 is

$$N'_{max} \leq g(M) + 1,$$

where $g(M)$ denotes the genus of map M .

Proof According to Theorem 6.2.3, denote by $\Gamma = \langle g \rangle$, we get that

$$\chi(M) + \sum_{g \in \Gamma, g \neq 1_\Gamma} (|\Phi_v(g)| + |\Phi_f(g)|) = |\Gamma| \chi(M/\Gamma),$$

where, $\Phi_f(g) = \{F | F \in F(M), F^g = F\}$ and $\Phi_v(g) = \{v | v \in V(M), v^g = v\}$. Notice that a vertex of M is a pair of conjugacy cycles in \mathcal{P} , and a face of M is a pair of conjugacy cycles in $\mathcal{P}\alpha\beta$. If $g \neq 1_\Gamma$, direct calculation shows that $\Phi_f(g) = \Phi_f(g^2)$ and $\Phi_v(g) = \Phi_v(g^2)$. Whence,

$$\sum_{g \in \Gamma, g \neq 1_\Gamma} |\Phi_v(g)| = (|\Gamma| - 1) |\Phi_v(g)|$$

and

$$\sum_{g \in \Gamma, g \neq 1_\Gamma} |\Phi_f(g)| = (|\Gamma| - 1) |\Phi_f(g)|.$$

Therefore, we get that

$$\chi(M) + (|\Gamma| - 1) |\Phi_v(g)| + (|\Gamma| - 1) |\Phi_f(g)| = |\Gamma| \chi(M/\Gamma).$$

Whence,

$$\chi(M) - (|\Phi_v(g)| + |\Phi_f(g)|) = |\Gamma| (\chi(M/\Gamma) - (|\Phi_v(g)| + |\Phi_f(g)|)).$$

If $\chi(M/G) - (|\Phi_v(g)| + |\Phi_f(g)|) = 0$, i.e., $\chi(M/\Gamma) = |\Phi_v(g)| + |\Phi_f(g)| \geq 0$, then we get that $g(M) \leq 1$ if M is orientable or $g(M) \leq 2$ if M is non-orientable. Contradicts to the assumption. Therefore, $\chi(M/\Gamma) - (|\Phi_v(g)| + |\Phi_f(g)|) \neq 0$. Whence, we get that

$$|\Gamma| = \frac{\chi(M) - (|\Phi_v(g)| + |\Phi_f(g)|)}{\chi(M/\Gamma) - (|\Phi_v(g)| + |\Phi_f(g)|)} = H(v, f; g).$$

Notice that $|\Gamma|, \chi(M) - (|\Phi_v(g)| + |\Phi_f(g)|)$ and $\chi(M/\Gamma) - (|\Phi_v(g)| + |\Phi_f(g)|)$ are integers. We know that the function $H(v, f; g)$ takes its maximum value at $\chi(M/\Gamma) - (|\Phi_v(g)| + |\Phi_f(g)|) = -1$ since $\chi(M) \leq -1$. But in this case, we get that

$$|\Gamma| = |\Phi_v(g)| + |\Phi_f(g)| - \chi(M) = 1 + \chi(M/\Gamma) - \chi(M).$$

We divide our discussion into two cases.

Case 1. M is orientable.

Since $\chi(M/\Gamma) + 1 = (|\Phi_v(g)| + |\Phi_f(g)|) \geq 0$, we know that $\chi(M/\Gamma) \geq -1$. Whence, $\chi(M/\Gamma) = 0$ or 2 . We get that

$$|\Gamma| = 1 + \chi(M/\Gamma) - \chi(M) \leq 3 - \chi(M) = 2g(M) + 1.$$

That is, $N_{max} \leq 2g(M) + 1$.

Case 2. M is non-orientable.

In this case, since $\chi(M/\Gamma) \geq -1$, we know that $\chi(M/\Gamma) = -1, 0, 1$ or 2 . Whence, we get that

$$|\Gamma| = 1 + \chi(M/\Gamma) - \chi(M) \leq 3 - \chi(M) = g(M) + 1.$$

This completes the proof. □

According to this theorem, we get the following result for the order of an automorphism of a Klein surface without boundary by the Theorem 5.3.12, which is even more better than the results already known.

Corollary 6.5.1 *The maximum order of conformal transformations realizable by maps M on a Riemann surface of genus ≥ 2 is $2g(M) + 1$ and the maximum order of conformal transformations realizable by maps M on a non-orientable Klein surface of genus ≥ 3 without boundary is $g(M) + 1$.*

The maximum order of an automorphism of map can be also determined by its underlying graph as follows.

Theorem 6.5.3 *Let M be a map underlying graph G and let $o_{max}(M, g), o_{max}(G, g)$ be the maximum orders of orientation-preserving automorphisms in $\text{Aut}M$ and in $\text{Aut}_{\frac{1}{2}}G$. Then*

$$o_{max}(M, g) \leq o_{max}(G, g),$$

and the equality holds for at least one such map M underlying graph G .

The proof of the Theorem 6.5.3 will be delayed to the next chapter after we proved Theorem 7.1.1. By this result, we find some interesting conclusions following.

Corollary 6.5.2 *The maximum order of orientation-preserving automorphisms of a complete map $\mathcal{K}_n, n \geq 3$ is at most n .*

Corollary 6.5.3 *The maximum order of orientation-preserving automorphisms of a plane tree \mathcal{T} is at most $|\mathcal{T}| - 1$ and attains the upper bound only if the underlying tree is a star.*

§6.6 REMARKS

6.6.1 The lifted graph of a voltage graph (G, σ) with $\sigma : X_{\frac{1}{2}}(G) \rightarrow \Gamma$ is in fact a regular covering of 1-complex G constructing dependent on a group $(\Gamma; \circ)$. This technique was extensively applied to coloring problem, particularly, its dual, i.e., current graph for determining the genus of complete graph K_n on surface. The reference [GrT1] is an excellent book systematically dealing with voltage graphs. One can also find the combinatorial counterparts of a few important results, such as those of the *Riemann-Hurwitz equation* and *Alexander's theorem* on branch points in Riemann geometry in this book. Certainly, the references [Liu1] and [Whi1] also partially discuss voltage graphs. A similar consideration for non-regular covering space presents the following problem:

Problem 6.6.1 *Apply the voltage assignment technique for constructing non-regular covering of graphs or maps.*

6.6.2 The technique of voltage graphs and voltage maps is essentially a discrete realization of regular covering spaces with dimensional 1 or 2. Many results on covering spaces can be found the combinatorial counterparts in voltage graphs or maps. For example,

Theorem 6.1.1 asserts that if $\pi : \widetilde{S} \rightarrow S$ is a covering projection, then for any arc f in S with initial point x_0 there exists a unique lifting arc f^l with initial point \widetilde{x}_0 in \widetilde{S} . In voltage graphs, we know its combinatorial counterpart following.

Theorem 6.6.1 *Let W be a walk with initial vertex $u \in V(G)$ in a voltage graph (G, σ) with assignment $\sigma : X_{\frac{1}{2}}(G) \rightarrow \Gamma$ and $g \in \Gamma$. then there is a unique lifting of W that starts at u_g in G^σ .*

Certainly, there are many such results by finding the combinatorial counterparts, for example in voltage graphs or maps for results known in topology or geometry. The book [MoT1] can be seen as a discrete deal with surface geometry, i.e., combinatorics on surface geometry. These results in Sections 4 and 5 are also such kind results. Generally, a combinatorial speculation for mathematical science will finally arrived at the *CC conjecture* for developing mathematics discussed in the final chapter of this book.

6.6.3 For a map (M, σ) with voltage assignment $\sigma : \mathcal{X}_{\alpha, \beta}(M) \rightarrow \Gamma$, it is easily to know that the group $(\Gamma; \circ)$ is a map group of M^σ action closed in each fiber $\pi^{-1}(x)$ for $x \in \mathcal{X}_{\alpha, \beta}(M)$, i.e., $\Gamma \leq \text{Aut}M^\sigma$. In this way, one can get regular maps in lifted maps. Such a role of voltage maps is known in Theorem 6.2.2, which enables one to get regular maps by voltage assignments. Similarly, the exponent group $\text{Ex}(M)$ of map and the construction of derived map $M^{\sigma'}$ also enables one to find more regular maps. The reader is referred to [Ned1] and [NeS1] for its techniques.

6.6.4 Theorem 6.2.5 is an important result related the quotient map with that of voltage assignment, which enables one to find relations between voltage group, Euler-Poincaré characteristic and fixed point sets. Theorems 6.2.6 and 6.2.7 are such results. This theorem is in fact a generalization of a result on voltage graph following, obtained by Gross and Tucker in 1974.

Theorem 6.6.2 *Let \mathcal{A} be a group acting freely on a graph \widetilde{G} and let G be the resulting quotient graph. Then there is an assignment σ of voltages in \mathcal{A} to the quotient graph G and a labeling of the vertices of \widetilde{G} by the elements of $V(G) \times \mathcal{A}$ such that $\widetilde{G} = G^\sigma$ and that the given action of \mathcal{A} on \widetilde{G} is the natural left action of \mathcal{A} on G^σ .*

6.6.5 For applying ideas of maps to metric mathematics, various metrics on maps are need to introduce besides angles and non-Euclid area discussed in Section 3. For example, the length and arc length, the circumference, the volume and the curvature, \dots , which

needs one to speculate the classical mathematics by combinatorics, i.e., combinatorially reconstruct such a mathematical science.

6.6.6 We have know that maps can be viewed as a combinatorial model of Klein surfaces in Chapter 5. Usually, a problem is difficult in Klein surface but it is easy for its counterpart in combinatorics, such as those in Corollary 6.5.1. Further applying this need us to solve the following problem.

Problem 6.6.2 *Determine these behaviors of Klein surfaces S , such as automorphisms that can not be realizable by maps M on S .*

As we known, there are few results on Problem 6.6.1 in publication. But it is fundamental for applying combinatorial technique to metric mathematics.

CHAPTER 7.

Map Automorphisms Underlying a Graph

A complete classification of non-equivalent embeddings of graph G on surfaces or maps $M = (\mathcal{X}_{\alpha,\beta}, \mathcal{P})$ underlying G requires to find permutation presentations of automorphisms of G on $\mathcal{X}_{\alpha,\beta}$. For this objective, an alternate approach is to consider the induced action of semi-arc automorphisms of graph $G(M)$ on quadricells $\mathcal{X}_{\alpha,\beta}$. In fact, the automorphism group $\text{Aut}M$ is nothing but consisting of all such automorphisms $g|_{\mathcal{X}_{\alpha,\beta}}$ that $\mathcal{P}^{g|_{\mathcal{X}_{\alpha,\beta}}} = \mathcal{P}$. Topics covered in this chapter include a necessary and sufficient characteristic for a subgroup of G being that of map and permutation presentations for automorphisms of maps underlying a complete graph, a semi-regular graph or a bouquet. Certainly, these presentations of complete maps or semi-regular maps can be also applied to maps underlying wheels $K_1 + C_n$ or GRR graphs of a finite group $(\Gamma; \circ)$. All of these permutation presentations are typical examples for characterizing the behavior of map groups, and can be also applied for the enumeration of non-isomorphic maps in Chapter 8.

§7.1 A CONDITION FOR GRAPH GROUP BEING THAT OF MAP

7.1.1 Orientation-Preserving or Reversing. Let $G = (V, E)$ be a connected graph. Its automorphism is denoted by $\text{Aut}G$. Choose the base set of maps underlying G to be $X = E$. Then its quadricells $\mathcal{X}_{\alpha,\beta}$ is defined by

$$\mathcal{X}_{\alpha,\beta} = \bigcup_{x \in X} \{x, \alpha x, \beta x, \beta\alpha\beta x\},$$

where, $K = \{1, \alpha, \beta, \alpha\beta\}$ is the Klein 4-elements group. For $\forall g \in \text{Aut}G$, an *induced action* $g|_{\mathcal{X}_{\alpha,\beta}}$ of g on $\mathcal{X}_{\alpha,\beta}$ is defined as follows:

For $\forall x \in \mathcal{X}_{\alpha,\beta}$, if $x^g = y$, then define $(\alpha x)^g = \alpha y$, $(\beta x)^g = \beta y$ and $(\alpha\beta x)^g = \alpha\beta y$.

Let $M = (\mathcal{X}_{\alpha,\beta}, \mathcal{P})$ be a map. According to the Theorem 5.3.8, for an automorphism $g \in \text{Aut}M$, let $g|_{V(M)} : u \rightarrow v$, $u, v \in V(M)$. If $u^g = v$, then g is called an *orientation-preserving automorphism* and if $u^g = v^{-1}$, such a g is called an *orientation-reversing automorphism*. For any $g \in \text{Aut}M$, it is obvious that $g|_G$ is orientation-preserving or orientation-reversing, and the product of two orientation-preserving or orientation-reversing automorphisms is orientation-preserving, but the product of an orientation-preserving with an orientation-reversing automorphism is orientation-reversing.

For a subgroup $\Gamma \leq \text{Aut}M$, define $\Gamma^+ \leq \Gamma$ being the orientation-preserving subgroup of H . Then it is clear that the index of Γ^+ in Γ is 2. Let v be a vertex with $v = (x_1, x_2, \dots, x_{\rho(v)})(\alpha x_{\rho(v)}, \dots, \alpha x_2, \alpha x_1)$. Denote by $\langle v \rangle$ the cyclic group generated by v . Then we get a property following for automorphisms of a map.

Lemma 7.1.1 *Let $\Gamma \leq \text{Aut}M$ be an automorphism group of map M . Then $\forall v \in V(M)$,*

- (1) *If $\forall g \in \Gamma$, g is orientation-preserving, then $\Gamma_v \leq \langle v \rangle$ is a cyclic group;*
- (2) $\Gamma_v \leq \langle v \rangle \times \langle \alpha \rangle$.

Proof (i) Let $M = (\mathcal{X}_{\alpha,\beta}, \mathcal{P})$. For any $\forall g \in G$, since g is orientation-preserving, we know that $v^h = v$ for $\forall v \in V(M)$, $h \in \Gamma_v$. Assume

$$v = (x_1, x_2, \dots, x_{\rho(v)})(\alpha x_{\rho(v)}, \alpha x_{\rho(v)-1}, \dots, \alpha x_1).$$

Then

$$[(x_1, x_2, \dots, x_{\rho(v)})(\alpha x_{\rho(v)}, \dots, \alpha x_2, \alpha x_1)]^h = (x_1, x_2, \dots, x_{\rho(v)})(\alpha x_{\rho(v)}, \dots, \alpha x_2, \alpha x_1).$$

Therefore, if $h(x_1) = x_{k+1}$, $1 \leq k \leq \rho(v)$, then

$$h = [(x_1, x_2, \dots, x_{\rho(v)})(\alpha x_{\rho(v)}, \alpha x_{\rho(v)-1}, \dots, \alpha x_1)]^k = v^k.$$

Now if $h(x_1) = \alpha x_{\rho(v)-k+1}$, $1 \leq k \leq \rho(v)$, then

$$h = [(x_1, x_2, \dots, x_{\rho(v)})(\alpha x_{\rho(v)}, \alpha x_{\rho(v)-1}, \dots, \alpha x_1)]^k \alpha = v^k \alpha.$$

But if $h = v^k \alpha$, we know that $v^h = v^\alpha = v^{-1}$, i.e., h is not orientation-preserving. Whence, $h = v^k$, $1 \leq k \leq \rho(v)$, i.e., every element in Γ_v is a power of v . Let ξ be the least power of elements in Γ_v . Then $\Gamma_v = \langle v^\xi \rangle \leq \langle v \rangle$ is a cyclic group generated by v^ξ .

(2) For $\forall g \in G_v$, $v^g = v$, i.e.,

$$[(x_1, x_2, \dots, x_\rho)(\alpha x_\rho, \alpha x_{\rho-1}, \dots, \alpha x_1)]^g = (x_1, x_2, \dots, x_\rho)(\alpha x_\rho, \alpha x_{\rho-1}, \dots, \alpha x_1).$$

Similar to the proof of (1), we know that there exists an integer s , $1 \leq s \leq \rho$ such that $g = v^s$ or $g = v^s \alpha$. Consequently, $g \in \langle v \rangle$ or $g \in \langle v \rangle \alpha$, i.e.,

$$\Gamma_v \leq \langle v \rangle \times \langle \alpha \rangle. \quad \square$$

Lemma 7.1.2 *Let G be a connected graph. If $\Gamma \leq \text{Aut}G$, and $\forall v \in V(G)$, $\Gamma_v \leq \langle v \rangle \times \langle \alpha \rangle$, then the action of Γ on $\mathcal{X}_{\alpha, \beta}$ is fixed-free.*

Proof Choose a quadricell $x \in \mathcal{X}_{\alpha, \beta}$. We prove that $\Gamma_x = \{1_{\mathcal{X}_{\alpha, \beta}}\}$. In fact, if $g \in \Gamma_x$, then $x^g = x$. Particularly, the incident vertex u is stable under the action of g , i.e., $u^g = u$. Let

$$u = (x, y_1, \dots, y_{\rho(u)-1})(\alpha x, \alpha y_{\rho(u)-1}, \dots, \alpha y_1),$$

then because of $\Gamma_u \leq \langle u \rangle \times \langle \alpha \rangle$, we get that

$$x^g = x, y_1^g = y_1, \dots, y_{\rho(u)-1}^g = y_{\rho(u)-1}$$

and

$$(\alpha x)^g = \alpha x, (\alpha y_1)^g = \alpha y_1, \dots, (\alpha y_{\rho(u)-1})^g = \alpha y_{\rho(u)-1},$$

thus for any quadricell e_u incident with the vertex u , $e_u^g = e_u$. According to the definition of induced action $\text{Aut}G$ on $\mathcal{X}_{\alpha, \beta}$, we know that

$$(\beta x)^g = \beta x, (\beta y_1)^g = \beta y_1, \dots, (\beta y_{\rho(u)-1})^g = \beta y_{\rho(u)-1}$$

and

$$(\alpha\beta x)^g = \alpha\beta x, (\alpha\beta y_1)^g = \alpha\beta y_1, \dots, (\alpha\beta y_{\rho(u)-1})^g = \alpha\beta y_{\rho(u)-1}.$$

Whence, for any quadricell $y \in \mathcal{X}_{\alpha,\beta}$, if the incident vertex of y is w , then by the connectedness of graph G , there is a path $P(u, w) = uv_1v_2 \cdots v_s w$ connecting the vertices u and w in G . Not loss of generality, we assume that βy_k is incident with the vertex v_1 . Since $(\beta y_k)^g = \beta y_k$ and $\Gamma_{v_1} \leq \langle v_1 \rangle \times \langle \alpha \rangle$, we know that for any quadricell e_{v_1} incident with the vertex v_1 , $e_{v_1}^g = e_{v_1}$.

Similarly, if a quadricell e_{v_i} incident with the vertex v_i is stable under the action of g , i.e., $(e_{v_i})^g = e_{v_i}$, then we can prove that any quadricell $e_{v_{i+1}}$ incident with the vertex v_{i+1} is stable under the action of g . This process can be well done until we arrive the vertex w . Therefore, we know that any quadricell e_w incident with the vertex w is stable under the action of g . Particularly, we get that $y^g = y$.

Therefore, $g = 1_\Gamma$. Whence, $\Gamma_x = \{1_\Gamma\}$. □

7.1.2 Group of a Graph Being That of Map. Now we obtain a necessary and sufficient condition for a subgroup of a graph being that an automorphism group of map underlying this graph.

Theorem 7.1.1 *Let G be a connected graph. If $\Gamma \leq \text{Aut}G$, then Γ is an automorphism group of map underlying graph G if and only if for $\forall v \in V(G)$, the stabilizer $\Gamma_v \leq \langle v \rangle \times \langle \alpha \rangle$.*

Proof According to Lemma 7.1.1(ii), the condition of Theorem 7.1.1 is necessary. Now we prove its sufficiency.

By Lemma 7.1.2, we know that the action of Γ on $\mathcal{X}_{\alpha,\beta}$ is fixed-free, i.e., for $\forall x \in \mathcal{X}_{\alpha,\beta}$, $|\Gamma_x| = 1$. Whence, the length of orbit of x under the action of Γ is $|x^\Gamma| = |\Gamma_x||x^\Gamma| = |\Gamma|$, i.e., for $\forall x \in \mathcal{X}_{\alpha,\beta}$, the length of orbit of x under the action of Γ is $|\Gamma|$.

Assume that there are s orbits O_1, O_2, \dots, O_s in $V(\Gamma)$ under the action of Γ , where,

$$\begin{aligned} O_1 &= \{u_1, u_2, \dots, u_k\}, \\ O_2 &= \{v_1, v_2, \dots, v_l\}, \\ &\dots\dots\dots, \\ O_s &= \{w_1, w_2, \dots, w_t\}. \end{aligned}$$

We construct a conjugatcy permutation pair for every vertex in the graph G such that their product \mathcal{P} is stable under the action of Γ .

Notice that for $\forall u \in V(G)$, because of $|\Gamma| = |\Gamma_u||u^\Gamma|$, we know that $[k, l, \dots, t] \mid |\Gamma|$.

First, we determine the conjugatcy permutation pairs for each vertex in the orbit O_1 . Choose any vertex $u_1 \in O_1$. Assume that the stabilizer Γ_{u_1} is $\{1, \mathcal{X}_{\alpha\beta}, g_1, g_2g_1, \dots, \prod_{i=1}^{m-1} g_{m-i}\}$, where, $m = |\Gamma_{u_1}|$ and the quadricells incident with vertex u_1 is $\widetilde{N}(u_1)$ in the graph G . We arrange the elements in $\widetilde{N}(u_1)$ as follows.

Choose a quadricell $u_1^a \in \widetilde{N}(u_1)$. We apply Γ_{u_1} action on u_1^a and αu_1^a , respectively. Then we get a quadricell set $A_1 = \{u_1^a, g_1(u_1^a), \dots, \prod_{i=1}^{m-1} g_{m-i}(u_1^a)\}$ and $\alpha A_1 = \{\alpha u_1^a, \alpha g_1(u_1^a), \dots, \alpha \prod_{i=1}^{m-1} g_{m-i}(u_1^a)\}$. By the definition of a graph automorphism action on its quadricells, we know that $A_1 \cap \alpha A_1 = \emptyset$. Arrange the elements in A_1 as $\overrightarrow{A_1} = u_1^a, g_1(u_1^a), \dots, \prod_{i=1}^{m-1} g_{m-i}(u_1^a)$.

If $\widetilde{N}(u_1) \setminus A_1 \cup \alpha A_1 = \emptyset$, then the arrangement of elements in $\widetilde{N}(u_1)$ is $\overrightarrow{A_1}$. If $\widetilde{N}(u_1) \setminus A_1 \cup \alpha A_1 \neq \emptyset$, choose a quadricell $u_1^b \in \widetilde{N}(u_1) \setminus A_1 \cup \alpha A_1$. Similarly, applying the group Γ_{u_1} acts on u_1^b , we get that $A_2 = \{u_1^b, g_1(u_1^b), \dots, \prod_{i=1}^{m-1} g_{m-i}(u_1^b)\}$ and $\alpha A_2 = \{\alpha u_1^b, \alpha g_1(u_1^b), \dots, \alpha \prod_{i=1}^{m-1} g_{m-i}(u_1^b)\}$. Arrange the elements in $A_1 \cup A_2$ as

$$\overrightarrow{A_1 \cup A_2} = u_1^a, g_1(u_1^a), \dots, \prod_{i=1}^{m-1} g_{m-i}(u_1^a); u_1^b, g_1(u_1^b), \dots, \prod_{i=1}^{m-1} g_{m-i}(u_1^b).$$

If $\widetilde{N}(u_1) \setminus (A_1 \cup A_2 \cup \alpha A_1 \cup \alpha A_2) = \emptyset$, then the arrangement of elements in $A_1 \cup A_2$ is $\overrightarrow{A_1 \cup A_2}$. Otherwise, $\widetilde{N}(u_1) \setminus (A_1 \cup A_2 \cup \alpha A_1 \cup \alpha A_2) \neq \emptyset$. We can choose another quadricell $u_1^c \in \widetilde{N}(u_1) \setminus (A_1 \cup A_2 \cup \alpha A_1 \cup \alpha A_2)$. Generally, If we have gotten the quadricell sets $A_1, A_2, \dots, A_r, 1 \leq r \leq 2k$, and the arrangement of element in them is $\overrightarrow{A_1 \cup A_2 \cup \dots \cup A_r}$, if $\widetilde{N}(u_1) \setminus (A_1 \cup A_2 \cup \dots \cup A_r \cup \alpha A_1 \cup \alpha A_2 \cup \dots \cup \alpha A_r) \neq \emptyset$, we can choose an element $u_1^d \in \widetilde{N}(u_1) \setminus (A_1 \cup A_2 \cup \dots \cup A_r \cup \alpha A_1 \cup \alpha A_2 \cup \dots \cup \alpha A_r)$ and define the quadricell set

$$A_{r+1} = \{u_1^d, g_1(u_1^d), \dots, \prod_{i=1}^{m-1} g_{m-i}(u_1^d)\}$$

$$\alpha A_{r+1} = \{\alpha u_1^d, \alpha g_1(u_1^d), \dots, \alpha \prod_{i=1}^{m-1} g_{m-i}(u_1^d)\}$$

and the arrangement of elements in A_{r+1} is

$$\overrightarrow{A_{r+1}} = u_1^d, g_1(u_1^d), \dots, \prod_{i=1}^{m-1} g_{m-i}(u_1^d).$$

Now define the arrangement of elements in $\bigcup_{j=1}^{r+1} A_j$ to be

$$\overrightarrow{\bigcup_{j=1}^{r+1} A_j} = \overrightarrow{\bigcup_{i=1}^r A_i; \overrightarrow{A_{r+1}}}.$$

Whence,

$$\widetilde{N}(u_1) = \left(\bigcup_{j=1}^k A_j\right) \bigcup \left(\alpha \bigcup_{j=1}^k A_j\right)$$

and A_k is obtained by the action of the stabilizer Γ_{u_1} on u_1^e . At the same time, the arrangement of elements in the subset $\bigcup_{j=1}^k A_j$ of $\widetilde{N}(u_1)$ to be $\overrightarrow{\bigcup_{j=1}^k A_j}$.

We define the conjugacy permutation pair of the vertex u_1 to be

$$\varrho_{u_1} = (C)(\alpha C^{-1} \alpha),$$

where,

$$C = (u_1^a, u_1^b, \dots, u_1^e; g_1(u_1^a), g_1(u_1^b), \dots, g_1(u_1^e), \dots, \prod_{i=1}^{m-1} (u_1^a), \prod_{i=1}^{m-1} (u_1^b), \dots, \prod_{i=1}^{m-1} (u_1^e)).$$

For any vertex $u_i \in O_1, 1 \leq i \leq k$, assume that $h(u_1) = u_i$, where $h \in G$, we define the conjugacy permutation pair ϱ_{u_i} of the vertex u_i to be

$$\varrho_{u_i} = \varrho_{u_1}^h = (C^h)(\alpha C^{-1} \alpha^{-1}).$$

Since O_1 is an orbit of the action G on $V(\Gamma)$, then we get that

$$\left(\prod_{i=1}^k \varrho_{u_i}\right)^\Gamma = \prod_{i=1}^k \varrho_{u_i}.$$

Similarly, we can define the conjugacy permutation pairs $\varrho_{v_1}, \varrho_{v_2}, \dots, \varrho_{v_l}, \dots, \varrho_{w_1}, \varrho_{w_2}, \dots, \varrho_{w_t}$ of vertices in the orbits O_2, \dots, O_s . We also have that

$$\left(\prod_{i=1}^l \varrho_{v_i}\right)^\Gamma = \prod_{i=1}^l \varrho_{v_i}.$$

.....

$$\left(\prod_{i=1}^t \varrho_{w_i}\right)^\Gamma = \prod_{i=1}^t \varrho_{w_i}.$$

Now define the permutation

$$\mathcal{P} = \left(\prod_{i=1}^k \mathcal{O}_{u_i} \right) \times \left(\prod_{i=1}^l \mathcal{O}_{v_i} \right) \times \cdots \times \left(\prod_{i=1}^t \mathcal{O}_{w_i} \right).$$

Since all $\mathcal{O}_1, \mathcal{O}_2, \dots, \mathcal{O}_s$ are the orbits of $V(G)$ under the action of Γ , we get that

$$\begin{aligned} \mathcal{P}^\Gamma &= \left(\prod_{i=1}^k \mathcal{O}_{u_i} \right)^\Gamma \times \left(\prod_{i=1}^l \mathcal{O}_{v_i} \right)^\Gamma \times \cdots \times \left(\prod_{i=1}^t \mathcal{O}_{w_i} \right)^\Gamma \\ &= \left(\prod_{i=1}^k \mathcal{O}_{u_i} \right) \times \left(\prod_{i=1}^l \mathcal{O}_{v_i} \right) \times \cdots \times \left(\prod_{i=1}^t \mathcal{O}_{w_i} \right) = \mathcal{P}. \end{aligned}$$

Whence, if let map $M = (\mathcal{X}_{\alpha,\beta}, \mathcal{P})$, then Γ is an automorphism of M . \square

For the orientation-preserving automorphisms, we know the following result.

Theorem 7.1.2 *Let G be a connected graph. If $\Gamma \leq \text{Aut}G$, then Γ is an orientation-preserving automorphism group of map underlying graph G if and only if for $\forall v \in V(G)$, the stabilizer $\Gamma_v \leq \langle v \rangle$ is a cyclic group.*

Proof According to Lemma 7.1.1(i), we know the necessary. Notice that the approach of construction the conjugacy permutation pair in the proof of Theorem 7.1.1 can be also applied in the orientation-preserving case. We know that Γ is also an orientation-preserving automorphism group of map M . \square

Corollary 7.1.1 *For any positive integer n , there exists a vertex transitive map M underlying a circulant such that Z_n is an orientation-preserving automorphism group of M .*

By Theorem 7.1.2, we can prove the Theorem 6.5.3 now.

The Proof of Theorem 6.5.3

Since every subgroup of a cyclic group is also a cyclic group, we know that any cyclic orientation-preserving automorphism group of the graph G is an orientation-preserving automorphism group of a map underlying Γ by Theorem 7.1.2. Whence, we get that

$$o_{\max}(M, g) \leq o_{\max}(G, g). \quad \square$$

Note 7.1.1 Gardiner et al. proved in [GNSS1] that if add an additional condition in Theorem 7.1.1, i.e, Γ is transitive on the vertices in G , then there is a regular map underlying the graph G .

§7.2 AUTOMORPHISMS OF A COMPLETE GRAPH ON SURFACES

7.2.1 Complete Map. A map is called a *complete map* if its underlying graph is a complete graph. For a connected graph G , the notations $\mathcal{E}^O(G)$, $\mathcal{E}^N(G)$ and $\mathcal{E}^L(G)$ denote the embeddings of Γ on the orientable surfaces, non-orientable surfaces and locally surfaces, respectively. For $\forall e = (u, v) \in E(G)$, its quadricell $Ke = \{e, \alpha e, \beta e, \alpha\beta e\}$ can be represented by $Ke = \{u^{v+}, u^{v-}, v^{u+}, v^{u-}\}$.

Let K_n be a complete graph of order n . Label its vertices by integers $1, 2, \dots, n$. Then its edge set is $\{ij | 1 \leq i, j \leq n, i \neq j\}$ and

$$\begin{aligned} \mathcal{X}_{\alpha, \beta}(K_n) &= \{i^{j+} : 1 \leq i, j \leq n, i \neq j\} \cup \{i^{j-} : 1 \leq i, j \leq n, i \neq j\}, \\ \alpha &= \prod_{1 \leq i, j \leq n, i \neq j} (i^{j+}, i^{j-}), \\ \beta &= \prod_{1 \leq i, j \leq n, i \neq j} (i^{j+}, i^{j+})(i^{j-}, i^{j-}). \end{aligned}$$

We determine all automorphisms of complete maps of order n and find presentations for them in this section.

First, we need some useful lemmas for an automorphism of map induced by an automorphism of its underlying graph.

Lemma 7.2.1 *Let G be a connected graph and $g \in \text{Aut}G$. If there is a map $M \in \mathcal{E}^L(G)$ such that the induced action $g^* \in \text{Aut}M$, then for $\forall (u, v), (x, y) \in E(G)$,*

$$[l^g(u), l^g(v)] = [l^g(x), l^g(y)] = \text{constant},$$

where, $l^g(w)$ denotes the length of the cycle containing the vertex w in the cycle decomposition of g .

Proof According to the Lemma 6.2.1, we know that the length of a quadricell u^{v+} or u^{v-} under the action g^* is $[l^g(u), l^g(v)]$. Since g^* is an automorphism of map, therefore, g^* is semi-regular. Whence, we get that

$$[l^g(u), l^g(v)] = [l^g(x), l^g(y)] = \text{constant}. \quad \square$$

Now we consider conditions for an induced automorphism of map by that of graph to be an orientation-reversing automorphism of map.

Lemma 7.2.2 *If $\xi\alpha$ is an automorphism of map, then $\xi\alpha = \alpha\xi$.*

Proof Since $\xi\alpha$ is an automorphism of map, we know that

$$(\xi\alpha)\alpha = \alpha(\xi\alpha).$$

That is, $\xi\alpha = \alpha\xi$. □

Lemma 7.2.3 *If ξ is an automorphism of map $M = (\mathcal{X}_{\alpha,\beta}, \mathcal{P})$, then $\xi\alpha$ is semi-regular on $\mathcal{X}_{\alpha,\beta}$ with order $o(\xi)$ if $o(\xi) \equiv 0 \pmod{2}$ and $2o(\xi)$ if $o(\xi) \equiv 1 \pmod{2}$.*

Proof Since ξ is an automorphism of map by Lemma 7.2.2, we know that the cyclic decomposition of ξ can be represented by

$$\xi = \prod_k (x_1, x_2, \dots, x_k)(\alpha x_1, \alpha x_2, \dots, \alpha x_k),$$

where, \prod_k denotes the product of disjoint cycles with length $k = o(\xi)$.

Therefore, if $k \equiv 0 \pmod{2}$, then

$$\xi\alpha = \prod_k (x_1, \alpha x_2, x_3, \dots, \alpha x_k)$$

and if $k \equiv 1 \pmod{2}$, then

$$\xi\alpha = \prod_{2k} (x_1, \alpha x_2, x_3, \dots, x_k, \alpha x_1, x_2, \alpha x_3, \dots, \alpha x_k).$$

Whence, ξ is semi-regular acting on $\mathcal{X}_{\alpha,\beta}$. □

Now we can prove the following result for orientation-reversing automorphisms of maps.

Lemma 7.2.4 *For a connected graph G , let \mathcal{K} be all automorphisms in $\text{Aut}G$ whose extending action on $\mathcal{X}_{\alpha,\beta}$, $X = E(G)$ are automorphisms of maps underlying graph G . Then for $\forall \xi \in \mathcal{K}$, $o(\xi^*) \geq 2$, $\xi^*\alpha \in \mathcal{K}$ if and only if $o(\xi^*) \equiv 0 \pmod{2}$.*

Proof Notice that by Lemma 7.2.3, if ξ^* is an automorphism of map underlying graph G , then $\xi^*\alpha$ is semi-regular acting on $\mathcal{X}_{\alpha,\beta}$.

Assume ξ^* is an automorphism of map $M = (\mathcal{X}_{\alpha,\beta}, \mathcal{P})$. Without loss of generality, we assume that

$$\mathcal{P} = C_1 C_2 \cdots C_k,$$

where, $C_i = (x_{i1}, x_{i2}, \dots, x_{ij_i})$ is a cycle in the decomposition of $\xi|_{V(G)}$ and $x_{it} = \{(e^{i1}, e^{i2}, \dots, e^{it_i})(\alpha e^{i1}, \alpha e^{it_i}, \dots, \alpha e^{i2})\}$ and.

$$\xi|_{E(G)} = (e_{11}, e_{12}, \dots, e_{s_1})(e_{21}, e_{22}, \dots, e_{2s_2}) \cdots (e_{l1}, e_{l2}, \dots, e_{ls_l}).$$

and

$$\xi^* = C(\alpha C^{-1} \alpha),$$

where, $C = (e_{11}, e_{12}, \dots, e_{s_1})(e_{21}, e_{22}, \dots, e_{2s_2}) \dots (e_{l1}, e_{l2}, \dots, e_{ls_l})$. Now since ξ^* is an automorphism of map, we get that $s_1 = s_2 = \dots = s_l = o(\xi^*) = s$.

If $o(\xi^*) \equiv 0 \pmod{2}$, define a map $M^* = (\mathcal{X}_{\alpha, \beta}, \mathcal{P}^*)$ with

$$\mathcal{P}^* = C_1^* C_2^* \dots C_k^*,$$

where, $C_i^* = (x_{i1}^*, x_{i2}^*, \dots, x_{ij_i}^*)$, $x_{it}^* = \{(e_{i1}^*, e_{i2}^*, \dots, e_{it_i}^*)(\alpha e_{i1}^*, \alpha e_{it_i}^*, \dots, e_{i2}^*)\}$ and $e_{ij}^* = e_{pq}$. Take $e_{ij}^* = e_{pq}$ if $q \equiv 1 \pmod{2}$ and $e_{ij}^* = \alpha e_{pq}$ if $q \equiv 0 \pmod{2}$. Then we get that $M^{\xi^*} = M$.

Now if $o(\xi^*) \equiv 1 \pmod{2}$, by Lemma 7.2.3, $o(\xi^* \alpha) = 2o(\xi^*)$. Therefore, any chosen quadricells $(e^{i1}, e^{i2}, \dots, e^{iti})$ adjacent to the vertex x_{i1} for $i = 1, 2, \dots, n$, where, $n = |G|$, the resultant map M is unstable under the action of $\xi \alpha$. Whence, $\xi \alpha$ is not an automorphism of map underlying graph G . □

7.2.2 Automorphisms of Complete Map. We determine all automorphisms of complete maps of order n by applying the previous results. Recall that the automorphism group of K_n is the symmetry group of degree n , that is, $\text{Aut}K_n = S_{V(K_n)}$.

Theorem 7.2.1 *All orientation-preserving automorphisms of non-orientable complete maps of order $n \geq 4$ are extended actions of elements in*

$$\mathcal{E}_{[s^{\frac{n}{3}}]}, \quad \mathcal{E}_{[1, s^{\frac{n-1}{3}}]},$$

and all orientation-reversing automorphisms of non-orientable complete maps of order $n \geq 4$ are extended actions of elements in

$$\alpha \mathcal{E}_{[(2s)^{\frac{n}{2s}}]}, \quad \alpha \mathcal{E}_{[(2s)^{\frac{4}{2s}}]}, \quad \alpha \mathcal{E}_{[1, 1, 2]},$$

where, \mathcal{E}_θ denotes the conjugacy class containing element θ in the symmetry group of degree n .

Proof First, we prove that an induced permutation ξ^* on a complete map of order n by an element $\xi \in S_{V(K_n)}$ is a cyclic order-preserving automorphism of non-orientable map, if and only if

$$\xi \in \mathcal{E}_{s^{\frac{n}{3}}} \cup \mathcal{E}_{[1, s^{\frac{n-1}{3}}]}.$$

Assume the cycle index of ξ is $[1^{k_1}, 2^{k_2}, \dots, n^{k_n}]$. If there exist two integers $k_i, k_j \neq 0$ and $i, j \geq 2, i \neq j$, then in the cyclic decomposition of ξ , there are two cycles

$$(u_1, u_2, \dots, u_i) \quad \text{and} \quad (v_1, v_2, \dots, v_j).$$

Since

$$[l^\xi(u_1), l^\xi(u_2)] = i \quad \text{and} \quad [l^\xi(v_1), l^\xi(v_2)] = j$$

and $i \neq j$, we know that ξ^* is not an automorphism of embedding by Theorem 5.3.8. Whence, the cycle index of ξ must be the form of $[1^k, s^l]$.

Now if $k \geq 2$, let $(u), (v)$ be two cycles of length 1 in the cycle decomposition of ξ . By Theorem 5.3.8, we know that

$$[l^\xi(u), l^\xi(v)] = 1.$$

If there is a cycle (w, \dots) in the cyclic decomposition of ξ whose length greater or equal to 2, we get that

$$[l^\xi(u), l^\xi(w)] = [1, l^\xi(w)] = l^\xi(w).$$

According to Lemma 7.2.1, we get that $l^\xi(w) = 1$, a contradiction. Therefore, the cycle index of ξ must be the forms of $[s^l]$ or $[1, s^l]$. Whence, $sl = n$ or $sl + 1 = n$. Calculation shows that $l = \frac{n}{s}$ or $l = \frac{n-1}{s}$. That is, the cycle index of ξ is one of the following three types $[1^n]$, $[1, s^{\frac{n-1}{s}}]$ and $[s^{\frac{n}{s}}]$ for some integer $s \geq 1$.

Now we only need to prove that for each element ξ in $\mathcal{E}_{[1, s^{\frac{n-1}{s}}]}$ and $\mathcal{E}_{[s^{\frac{n}{s}}]}$, there exists a non-orientable complete map M of order n with the induced permutation ξ^* being its cyclic order-preserving automorphism of surface. The discussion are divided into two cases.

Case 1. $\xi \in \mathcal{E}_{[s^{\frac{n}{s}}]}$

Assume the cycle decomposition of ξ being $\xi = (a, b, \dots, c) \cdots (x, y, \dots, z) \cdots (u, v, \dots, w)$, where the length of each cycle is k and $1 \leq a, b, \dots, c, x, y, \dots, z, u, v, \dots, w \leq n$. In this case, we construct a non-orientable complete map $M_1 = (X_{\alpha, \beta}^1, \mathcal{P}_1)$ by defining

$$\mathcal{X}_{\alpha, \beta}^1 = \{i^{j^+} : 1 \leq i, j \leq n, i(j)\} \cup \{i^{j^-} : 1 \leq i, j \leq n, i \neq j\},$$

$$\mathcal{P}_1 = \prod_{x \in \{a, b, \dots, c, \dots, x, y, \dots, z, u, v, \dots, w\}} (C(x))(\alpha C(x)^{-1} \alpha),$$

where

$$C(x) = (x^{a^+}, \dots, x^{x^*}, \dots, x^{u^+}, x^{b^+}, x^{v^+}, \dots, \dots, x^{v^+}, x^{c^+}, \dots, x^{z^+}, \dots, x^{w^+}),$$

x^{x^*} denotes an empty position and

$$\alpha C(x)^{-1} \alpha = (x^{a^-}, x^{w^-}, \dots, x^{z^-}, \dots, x^{c^-}, x^{v^-}, \dots, x^{b^-}, x^{u^-}, \dots, x^{v^-}, \dots).$$

It is clear that $M_1^{\xi^*} = M_1$. Therefore, ξ^* is an cyclic order-preserving automorphism of map M_1 .

Case 2. $\xi \in \mathcal{E}_{[1, s \frac{n-1}{s}]}$

We assume the cyclic decomposition of ξ being that

$$\xi = (a, b, \dots, c) \dots (x, y, \dots, z) \dots (u, v, \dots, w)(t),$$

where, the length of each cycle is k beside the final cycle, and $1 \leq a, b \dots c, x, y \dots, z, u, v, \dots, w, t \leq n$. In this case, we construct a non-orientable complete map $M_2 = (\mathcal{X}_{\alpha, \beta}^2, \mathcal{P}_2)$ by defining

$$\mathcal{X}_{\alpha, \beta}^2 = \{i^{j^+} : 1 \leq i, j \leq n, i \neq j\} \cup \{i^{j^-} : 1 \leq i, j \leq n, i \neq j\},$$

$$\mathcal{P}_2 = (A)(\alpha A^{-1}) \prod_{x \in \{a, b, \dots, c, \dots, x, y, \dots, z, u, v, \dots, w\}} (C(x))(\alpha C(x)^{-1} \alpha),$$

where

$$A = (t^{a^+}, t^{x^+}, \dots, t^{u^+}, t^{b^+}, t^{v^+}, \dots, t^{v^+}, \dots, t^{c^+}, t^{z^+}, \dots, t^{w^+}),$$

$$\alpha A^{-1} \alpha = (t^{a^-}, t^{w^-}, \dots, t^{z^-}, t^{c^-}, t^{v^-}, \dots, t^{v^-}, \dots, t^{b^-}, t^{u^-}, \dots, t^{x^-}),$$

$$C(x) = (x^{a^+}, \dots, x^{x^*}, \dots, x^{u^+}, x^{b^+}, \dots, x^{v^+}, \dots, x^{v^+}, \dots, x^{c^+}, \dots, x^{z^+}, \dots, x^{w^+})$$

and

$$\alpha C(x)^{-1} \alpha = (x^{a^-}, x^{w^-}, \dots, x^{z^-}, \dots, x^{c^-}, \dots, x^{v^-}, \dots, x^{v^-}, \dots, x^{b^-}, x^{u^-}, \dots).$$

It is also clear that $M_2^{\xi^*} = M_2$. Therefore, ξ^* is an automorphism of a map M_2 .

Now we consider the case of orientation-reversing automorphisms of complete maps. According to Lemma 7.2.4, we know that an element $\xi \alpha$, where $\xi \in S_{V(K_n)}$ is an orientation-reversing automorphism of complete map only if,

$$\xi \in \mathcal{E}_{[k \frac{n_1}{k}, (2k) \frac{n-n_1}{2k}]}$$

Our discussion is divided into two parts.

Case 3. $n_1 = n$.

Without loss of generality, we can assume the cycle decomposition of ξ has the following form in this case.

$$\xi = (1, 2, \dots, k)(k+1, k+2, \dots, 2k) \cdots (n-k+1, n-k+2, \dots, n).$$

Subcase 3.1 $k \equiv 1(\text{mod}2)$ and $k > 1$.

According to Lemma 7.2.4, we know that $\xi^* \alpha$ is not an automorphism of map since $o(\xi^*) = k \equiv 1(\text{mod}2)$.

Subcase 3.2 $k \equiv 0(\text{mod}2)$.

Construct a non-orientable map $M_3 = (\mathcal{X}_{\alpha, \beta}^3, \mathcal{P}_3)$, where $X^3 = E(K_n)$ by

$$\mathcal{P}_3 = \prod_{i \in \{1, 2, \dots, n\}} (C(i))(\alpha C(i)^{-1} \alpha),$$

where if $i \equiv 1(\text{mod}2)$, then

$$C(i) = (i^{1+}, i^{k+1+}, \dots, i^{n-k+1+}, i^{2+}, \dots, i^{n-k+2+}, \dots, i^{i^*}, \dots, i^{k+}, i^{2k+}, \dots, i^{n+}),$$

$$\alpha C(i)^{-1} \alpha = (i^{1-}, i^{n-}, \dots, i^{2k-}, i^{k-}, \dots, i^{k+1-})$$

and if $i \equiv 0(\text{mod}2)$, then

$$C(i) = (i^{1-}, i^{k+1-}, \dots, i^{n-k+1-}, i^{2-}, \dots, i^{n-k+2-}, \dots, i^{i^*}, \dots, i^{k-}, i^{2k-}, \dots, i^{n-}),$$

$$\alpha C(i)^{-1} \alpha = (i^{1+}, i^{n+}, \dots, i^{2k+}, i^{k+}, \dots, i^{k+1+}),$$

where, i^{i^*} denotes the empty position, for example, $(2^1, 2^{2^*}, 2^3, 2^4, 2^5) = (2^1, 2^3, 2^4, 2^5)$. It is clear that $\mathcal{P}_3^{\xi \alpha} = \mathcal{P}_3$, that is, $\xi \alpha$ is an automorphism of map M_3 .

Case 4. $n_1 \neq n$.

Without loss of generality, we can assume that

$$\begin{aligned} \xi &= (1, 2, \dots, k)(k+1, k+2, \dots, n_1) \cdots (n_1-k+1, n_1-k+2, \dots, n_1) \\ &\times (n_1+1, n_1+2, \dots, n_1+2k)(n_1+2k+1, \dots, n_1+4k) \cdots (n-2k+1, \dots, n) \end{aligned}$$

Subcase 4.1 $k \equiv 0(\text{mod}2)$.

Consider the orbits of 1^{2+} and $n_1 + 2k + 1^{1+}$ under the action of $\langle \xi\alpha \rangle$, we get that

$$|orb((1^{2+})^{\langle \xi\alpha \rangle})| = k$$

and

$$|orb(((n_1 + 2k + 1)^{1+})^{\langle \xi\alpha \rangle})| = 2k.$$

Contradicts to Lemma 7.2.1.

Subcase 4.2 $k \equiv 1 \pmod{2}$.

In this case, if $k \neq 1$, then $k \geq 3$. Similar to the discussion of Subcase 3.1, we know that $\xi\alpha$ is not an automorphism of complete map. Whence, $k = 1$ and

$$\xi \in \mathcal{E}_{[1^{n_1}, 2^{n_2}]}$$

Without loss of generality, assume that

$$\xi = (1)(2) \cdots (n_1)(n_1 + 1, n_1 + 2)(n_1 + 3, n_1 + 4) \cdots (n_1 + n_2 - 1, n_1 + n_2).$$

If $n_2 \geq 2$, and there exists a map $M = (\mathcal{X}_{\alpha, \beta}, \mathcal{P})$, assume a vertex v_1 in M being

$$v_1 = (1^{l_{12}^+}, 1^{l_{13}^+}, \dots, 1^{l_{1n}^+})(1^{l_{12}^-}, 1^{l_{1n}^-}, \dots, 1^{l_{13}^-})$$

where, $l_{1i} \in \{+2, -2, +3, -3, \dots, +n, -n\}$ and $l_{1i} \neq l_{1j}$ if $i \neq j$. Then we get that

$$(v_1)^{\xi\alpha} = (1^{l_{12}^-}, 1^{l_{13}^-}, \dots, 1^{l_{1n}^-})(1^{l_{12}^+}, 1^{l_{1n}^+}, \dots, 1^{l_{13}^+}) \neq v_1.$$

Whence, $\xi\alpha$ is not an automorphism of map M , a contradiction. Therefore, $n_2 = 1$. Similarly, we can also get that $n_1 = 2$. Whence, $\xi = (1)(2)(34)$ and $n = 4$. We construct a stable non-orientable map M_4 under the action of $\xi\alpha$ by defining

$$M_4 = (\mathcal{X}_{\alpha, \beta}^4, \mathcal{P}_4),$$

where,

$$\begin{aligned} \mathcal{P}_4 &= (1^{2+}, 1^{3+}, 1^{4+})(2^{1+}, 2^{3+}, 2^{4+})(3^{1+}, 3^{2+}, 3^{4+})(4^{1+}, 4^{2+}, 4^{3+}) \\ &\times (1^{2-}, 1^{4-}, 1^{3-})(2^{1-}, 2^{4-}, 2^{3-})(3^{1-}, 3^{4-}, 3^{2-})(4^{1-}, 4^{3-}, 4^{2-}). \end{aligned}$$

Therefore, all orientation-preserving automorphisms of non-orientable complete maps are extended actions of elements in

$$\mathcal{E}_{[s^{\frac{n}{s}}]}, \quad \mathcal{E}_{[1, s^{\frac{n-1}{s}}]}$$

and all orientation-reversing automorphisms of non-orientable complete maps are extended actions of elements in

$$\alpha\mathcal{E}_{[(2s)\frac{n}{2s}]}, \quad \alpha\mathcal{E}_{[(2s)\frac{4}{2s}]}, \quad \alpha\mathcal{E}_{[1,1,2]}.$$

This completes the proof. \square

According to the Rotation Embedding Scheme for orientable embedding of a graph, presented by Heffter firstly in 1891 and formalized by Edmonds in [Edm1], an orientable complete map is just the case of eliminating the sign + and - in our representation for complete maps. Whence, we get the following result for automorphism of orientable complete maps.

Theorem 7.2.2 *All orientation-preserving automorphisms of orientable complete maps of order $n \geq 4$ are extended actions of elements in*

$$\mathcal{E}_{[s\frac{n}{s}]}, \quad \mathcal{E}_{[1,s\frac{n-1}{s}]}$$

and all orientation-reversing automorphisms of orientable complete maps of order $n \geq 4$ are extended actions of elements in

$$\alpha\mathcal{E}_{[(2s)\frac{n}{2s}]}, \quad \alpha\mathcal{E}_{[(2s)\frac{4}{2s}]}, \quad \alpha\mathcal{E}_{[1,1,2]},$$

where, \mathcal{E}_θ denotes the conjugacy class containing θ in $S_{V(K_n)}$.

Proof The proof is similar to that of Theorem 7.2.1. For completion, we only need to construct orientable maps $M_i^O, i = 1, 2, 3, 4$ to replace non-orientable maps $M_i, i = 1, 2, 3, 4$ in the proof of Theorem 7.2.1. In fact, for orientation-preserving cases, we only need to take M_1^O, M_2^O to be the resultant maps eliminating the sign + and - in M_1, M_2 constructed in the proof of Theorem 7.2.1. For the orientation-reversing cases, we take $M_3^O = (E(K_n)_{\alpha,\beta}, \mathcal{P}_3^O)$ with

$$\mathcal{P}_3 = \prod_{i \in \{1, 2, \dots, n\}} (C(i)),$$

where, if $i \equiv 1(\text{mod}2)$, then

$$C(i) = (i^1, i^{k+1}, \dots, i^{n-k+1}, i^2, \dots, i^{n-k+2}, \dots, i^{i^*}, \dots, i^k, i^{2k}, \dots, i^n),$$

and if $i \equiv 0(\text{mod}2)$, then

$$C(i) = (i^1, i^{k+1}, \dots, i^{n-k+1}, i^2, \dots, i^{n-k+2}, \dots, i^{i^*}, \dots, i^k, i^{2k}, \dots, i^n)^{-1},$$

where i^{i^*} denotes the empty position and $M_4^O = (E(K_4)_{\alpha,\beta}, \mathcal{P}_4)$ with

$$\mathcal{P}_4 = (1^2, 1^3, 1^4)(2^1, 2^3, 2^4)(3^1, 3^4, 3^2)(4^1, 4^2, 4^3).$$

It can be shown that $(M_i^O)^{\xi^{*\alpha}} = M_i^O$ for $i = 1, 2, 3$ and 4. □

§7.3 MAP-AUTOMORPHISM GRAPHS

7.3.1 Semi-Regular Graph. A graph is called to be a *semi-regular graph* if it is simple and its automorphism group action on its ordered pair of adjacent vertices is fixed-free, which is considered in [Mao1] and [MLT1] for enumerating its non-equivalent embeddings on surfaces. A map underlying a semi-regular graph is called to be a *semi-regular map*. We determine all automorphisms of maps underlying a semi-regular graph in this section.

Comparing with the Theorem 7.1.2, we get a necessary and sufficient condition for an automorphism of a graph being that of a map.

Theorem 7.3.1 *For a connected graph G , an automorphism $\xi \in \text{Aut}G$ is an orientation-preserving automorphism of non-orientable map underlying graph G if and only if ξ is semi-regular acting on its ordered pairs of adjacent vertices.*

Proof According to Theorem 5.3.5, if $\xi \in \text{Aut}G$ is an orientation-preserving automorphism of map M underlying graph G , then ξ is semi-regular acting on its ordered pairs of adjacent vertices.

Now assume that $\xi \in \text{Aut}G$ is semi-regular action on its ordered pairs of adjacent vertices. Denote by $\xi|_{V(G)}$, $\xi|_{E(G)_\beta}$ the action of ξ on $V(G)$ and on its ordered pairs of adjacent vertices, respectively. By conditions in this theorem, we can assume that

$$\xi|_{V(G)} = (a, b, \dots, c) \cdots (g, h, \dots, k) \cdots (x, y, \dots, z)$$

and

$$\xi|_{E(G)_\beta} = C_1 \cdots C_i \cdots C_m,$$

where, let $s_a = |\{a, b, \dots, c\}|, \dots, s_g = |\{g, h, \dots, k\}|, \dots, s_x = |\{x, y, \dots, z\}|$, then $s_a|C(a)| = \dots = s_g|C(g)| = \dots = s_x|C(x)|$, and $C(g)$ denotes the cycle containing g in $\xi|_{V(G)}$ and

$$C_1 = (a^1, b^1, \dots, c^1, a^2, b^2, \dots, c^2, \dots, a^{s_a}, b^{s_a}, \dots, c^{s_a}),$$

$$\begin{aligned}
& \dots\dots\dots, \\
C_i &= (g^1, h^1, \dots, k^1, g^2, k^2, \dots, k^2, \dots, g^{s_g}, h^{s_g}, \dots, k^{s_g}), \\
& \dots\dots\dots, \\
C_m &= (x^1, y^1, \dots, z^1, \dots, x^2, y^2, \dots, z^2, \dots, x^{s_x}, y^{s_x}, \dots, z^{s_x}).
\end{aligned}$$

Now for $\forall \xi, \xi \in \text{Aut}G$, we construct a stable map $M = (\mathcal{X}_{\alpha, \beta}, \mathcal{P})$ under the action of ξ as follows.

$$X = E(\Gamma)$$

and

$$\mathcal{P} = \prod_{g \in T_\xi^V} \prod_{x \in C(g)} (C_x)(\alpha C_x^{-1}).$$

Assume that $u = \xi^f(g)$, and

$$N_G(g) = \{g^{\bar{z}^1}, g^{\bar{z}^2}, \dots, g^{\bar{z}^l}\}.$$

Obviously, all degrees of vertices in $C(g)$ are same. Notices that $\xi|_{N_G(g)}$ is circular acting on $N_G(g)$ by Theorem 7.1.2. Whence, it is semi-regular acting on $N_G(g)$. Without loss of generality, we assume that

$$\xi|_{N_G(g)} = (g^{\bar{z}^1}, g^{\bar{z}^2}, \dots, g^{\bar{z}^s})(g^{\bar{z}^{s+1}}, g^{\bar{z}^{s+2}}, \dots, g^{\bar{z}^{2s}}) \dots (g^{\bar{z}^{(k-1)s+1}}, g^{\bar{z}^{(k-1)s+2}}, \dots, g^{\bar{z}^{ks}}),$$

where, $l = ks$. Choose

$$C_g = (g^{\bar{z}^{1+}}, g^{\bar{z}^{s+1+}}, \dots, g^{\bar{z}^{(k-1)s+1+}}, g^{\bar{z}^{2+}}, g^{\bar{z}^{s+2+}}, \dots, g^{\bar{z}^{s+}}, g^{\bar{z}^{2s}}, \dots, g^{\bar{z}^{ks+}}).$$

Then,

$$C_x = (x^{\bar{z}^{1+}}, x^{\bar{z}^{s+1+}}, \dots, x^{\bar{z}^{(k-1)s+1+}}, x^{\bar{z}^{2+}}, x^{\bar{z}^{s+2+}}, \dots, x^{\bar{z}^{s+}}, x^{\bar{z}^{2s}}, \dots, x^{\bar{z}^{ks+}}),$$

where,

$$x^{\bar{z}^{i+}} = \xi^f(g^{\bar{z}^{i+}}),$$

for $i = 1, 2, \dots, ks$. and

$$\alpha C_x^{-1} = (\alpha x^{\bar{z}^{1+}}, \alpha x^{\bar{z}^{s+1+}}, \dots, \alpha x^{\bar{z}^{(k-1)s+1+}}, \alpha x^{\bar{z}^{s+}}, \alpha x^{\bar{z}^{2s}}, \dots, \alpha x^{\bar{z}^{ks+}}).$$

Immediately, we get that $M^\xi = \xi M \xi^{-1} = M$ by this construction. Whence, ξ is an orientation-preserving automorphism of map M . \square

By the rotation embedding scheme, eliminating α on each quadricell in Tutte's representation of embeddings induces an orientable embedding underlying the same graph. Since an automorphism of embedding is commutative with α and β , we get the following result for the orientable-preserving automorphisms of orientable maps underlying a semi-regular graph.

Theorem 7.3.2 *If G is a connected semi-regular graph, then for $\forall \xi \in \text{Aut}G$, ξ is an orientation-preserving automorphism of orientable map underlying graph G .*

According to Theorems 7.3.1 and 7.3.2, if G is semi-regular, i.e., each automorphism acting on the ordered pairs of adjacent vertices in G is fixed-free, then every automorphism of graph G is an orientation-preserving automorphism of orientable map and non-orientable map underlying graph G . We restated this result in the following.

Theorem 7.3.3 *If G is a connected semi-regular graph, then for $\forall \xi \in \text{Aut}G$, ξ is an orientation-preserving automorphism of orientable map and non-orientable map underlying graph G .*

Notice that if ς^* is an orientation-reversing automorphism of map, then $\varsigma^*\alpha$ is an orientation-preserving automorphism of the same map. By Lemma 7.2.4, if τ is an automorphism of map underlying a graph G , then $\tau\alpha$ is an automorphism of map underlying this graph if and only if $o(\tau) \equiv 0(\text{mod}2)$. Whence, we have the following result for automorphisms of maps underlying a semi-regular graph

Theorem 7.3.4 *Let G be a semi-regular graph. Then all the automorphisms of orientable maps underlying graph Γ are*

$$g|_{\mathcal{X}_{\alpha\beta}} \text{ and } \alpha h|_{\mathcal{X}_{\alpha\beta}}, g, h \in \text{Aut}G \text{ with } o(h) \equiv 0(\text{mod}2).$$

and all the automorphisms of non-orientable maps underlying graph G are also

$$g|_{\mathcal{X}_{\alpha\beta}} \text{ and } \alpha h|_{\mathcal{X}_{\alpha\beta}}, g, h \in \text{Aut}\Gamma \text{ with } o(h) \equiv 0(\text{mod}2).$$

Theorem 7.3.4 will be used in Chapter 8 for the enumeration of maps on surfaces underlying a semi-regular graph.

An circulant transitive graph of prime order is Cayley graph $\text{Cay}(Z_p : S)$, B.Alspach completely determined its automorphism group as follows([Als1]):

If $S = \emptyset$, or $S = Z_p^*$, then $\text{Aut}(\text{Cay}(Z_p : S)) = \Sigma_p$, the symmetric group of degree p , otherwise,

$$\text{Aut}(\text{Cay}(Z_p : S)) = \{T_{a,b} | a \in H, b \in Z_p^*\},$$

where $T_{a,b}$ is the permutation on Z_p which maps x to $ax + b$ and H is the largest even order subgroup of Z_p^* such that S is a union of cosets of H .

We get a corollary from Theorem 7.3.4 for circulants of prime order.

Corollary 7.3.1 *Every automorphism of a circulant graph G , not be a complete graph, with prime order is an orientation-preserving automorphism of map underlying graph G on orientable surfaces.*

Proof According to Theorem 7.3.4, we only need proving that each automorphism $\theta = ax + b$ of the circulant graph $\text{Cay}(Z_p : S)$, $\text{Cay}(Z_p : S) \neq K^n$ is semi-regular acting on its order pairs of adjacent vertices, where p is a prime number. Now for an arc $g^{sg} = (g, sg) \in A(\text{Cay}(Z_p : S))$, where $A(G)$ denotes the arc set of the graph Γ , we have that

$$\begin{aligned} (g^{sg})^\theta &= (ag + b)^{asg+b}; \\ (g^{sg})^{\theta^2} &= (a(ag + b) + b)^{a(asg+b)+b} = (a^2g + ab + b)^{a^2sg+ab+b}; \\ &\dots\dots\dots; \\ (g^{sg})^{\theta^{o(a)}} &= (a^{o(a)}g + a^{o(a)-1}b + a^{o(a)-2}b + \dots + b)^{a^{o(a)}sg+a^{o(a)-1}b+a^{o(a)-2}b+\dots+b} \\ &= (a^{o(a)}g + \frac{a^{o(a)}b - 1}{a - 1})^{a^{o(a)}sg+\frac{a^{o(a)}b-1}{a-1}} = g^{sg}, \end{aligned}$$

where $o(a)$ denotes the order of a . Therefore, θ is semi-regular acting on the order pairs of adjacent vertices of the graph $\text{Cay}(Z_p : S)$. □

For symmetric circulant of prime order, not being a complete graph, Chao proved that the automorphism group is regular acting on its order pairs of adjacent vertices([Cha1]). Whence, we get the following result.

Corollary 7.3.2 *Every automorphism of a symmetric circulant graph G of prime order p , $G \neq K_p$, is an orientation-preserving automorphism of map on orientable surface underlying graph G .*

Now let s be an even divisor of $q - 1$ and r a divisor of $p - 1$. Choose $H(p, r) = \langle a \rangle$, $t \in Z_p^*$ be such that $t^{\frac{s}{2}} \in -H(p, r)$ and u the least common multiple of r and the order of t in Z_p^* . The graph $G(pq; r, s, u)$ is defined as follows:

$$V(G(pq; r, s, u)) = Z_q \times Z_p = \{(i, x) | i \in Z_q, x \in Z_p\}.$$

$$E(G(pq; r, s, u)) = \{((i, x), (j, y)) | \exists l \in Z^+ \text{ such that } j - i = a^l, y - x \in t^l H(p, r)\}.$$

It is proved that the automorphism group of $G(pq; r, s, u)$ is regular acting on the ordered pairs of adjacent pairs in [PWX1]. By Theorem 7.3.4, we get the following result.

Corollary 7.3.3 *Every automorphism of graph $G(pq; r, s, u)$ is an orientation-preserving automorphism of map on orientable surface underlying graph $G(pq; r, s, u)$.*

7.3.2 Map-Automorphism Graph. A graph G is a *map-automorphism graph* if all automorphisms of G is that of maps underlying graph G . Whence, every semi-regular graph is a map-automorphism graph. According to Theorems 7.1.1-7.1.2, we know the following result.

Theorem 7.3.5 *A graph G is a map-automorphism graph if and only if for $\forall v \in V(G)$, the stabilizer $(\text{Aut}G)_v \leq \langle v \rangle \times \langle \alpha \rangle$.*

Proof By definition, G is a map-automorphism graph if all automorphisms of G are automorphisms of maps underlying G , i.e., $\text{Aut}G$ is an automorphism group of map. According to Theorems 7.1.1 and 7.1.2, we know that this happens if and only if for $\forall v \in V(G)$, the stabilizer $(\text{Aut}G)_v \leq \langle v \rangle \times \langle \alpha \rangle$. \square

We therefore get the following result again.

Theorem 7.3.6 *Every semi-regular graph G is a map-automorphism graph.*

Proof In fact, we know that $(\text{Aut}G)_v = 1_{V(G)} \leq \langle v \rangle \times \langle \alpha \rangle$ for a semi-regular graph G . By Theorem 7.3.5, G is a map-automorphism graph. \square

Further application of Theorem 7.3.6 enables us to get the following result for vertex transitive graphs.

Theorem 7.3.7 *A Cayley graph $X = \text{Cay}(\Gamma : S)$ is a map-automorphism graph if and only if $(\text{Aut}X)_{1_\Gamma} \leq (S)$, where (S) denotes a cyclic permutation on S . Furthermore, there is a regular map underlying $\text{Cay}(\Gamma : S)$ if $(\text{Aut}X)_{1_\Gamma} \leq (S)$.*

Proof Notice that a Cayley graph $\text{Cay}(\Gamma : S)$ is transitive by Theorem 3.2.1. For $\forall g, h \in V(\text{Cay}(\Gamma : S))$, such a transitive automorphism is $\tau = g^{-1} \circ h : g \rightarrow h$. We therefore know that $(\text{Aut}X)_g \simeq (\text{Aut}X)_h$ for $g, h \in V(\text{Cay}(\Gamma : S))$. Whence, X is a map-automorphism graph if and only if $(\text{Aut}X)_{1_\Gamma} \leq (S)$ by Theorem 7.3.6. In this case, there is

a regular map underlying $\text{Cay}(\Gamma : S)$ was verified by Gardiner et al. in [GNSS1], seeing Note 7.1.1. □

Particularly, we get the following conclusion for map-automorphism graphs.

Corollary 7.3.4 *A GRR graph of a finite group $(\Gamma; \circ)$ is a map-automorphism graph.*

Corollary 7.3.5 *A Cayley map $\text{Cay}^M(\Gamma : S, r)$ is regular if and only if there is an automorphism $\tau \in \text{Aut}\Gamma$ such that $\tau|_S = r$.*

Proof This is an immediately conclusion of Theorems 5.4.7 and 7.3.7. □

A few map-automorphism graphs can be found in Table 7.3.1 following.

G	$\text{Aut}G$	Map-automorphism Graph?
P_n	Z_2	Yes
C_n	D_n	Yes
$P_n \times P_2$	$Z_2 \times Z_2$	Yes
$C_n \times P_2$	$D_n \times Z_2$	Yes

Table 7.3.1

§7.4 AUTOMORPHISMS OF ONE FACE MAPS

7.4.1 One-Face Map. A *one face map* is such a map just with one face, which means that the underlying graph of one face maps is the bouquets. Therefore, for determining the automorphisms of one face maps, we only need to determine the automorphisms of bouquets B_n on surfaces. There is a well-know result for automorphisms of a map and its dual in topological graph theory, i.e., the automorphism group of map is the same as its dual.

A map underlying graph B_n for an integer $n \geq 1$ has the form $\mathcal{B}_n = (\mathcal{X}_{\alpha,\beta}, \mathcal{P}_n)$ with $X = E(B_n) = \{e_1, e_2, \dots, e_n\}$ and

$$\mathcal{P}_n = (x_1, x_2, \dots, x_{2n})(\alpha x_1, \alpha x_{2n}, \dots, x_2),$$

where, $x_i \in X, \beta X$ or $\alpha\beta X$ and satisfying Axioms 1 and 2 in Section 5.2 of Chapter 5. For a given bouquet B_n with n edges, its semi-arc automorphism group is

$$\text{Aut}_{\frac{1}{2}} B_n = S_n[S_2].$$

From group theory, we know that each element in $S_n[S_2]$ can be represented by $(g; h_1, h_2, \dots, h_n)$ with $g \in S_n$ and $h_i \in S_2 = \{1, \alpha\beta\}$ for $i = 1, 2, \dots, n$. The action of $(g; h_1, h_2, \dots, h_n)$ on a map \mathcal{B}_n underlying graph B_n by the following rule:

$$\text{If } x \in \{e_i, \alpha e_i, \beta e_i, \alpha\beta e_i\}, \text{ then } (g; h_1, h_2, \dots, h_n)(x) = g(h_i(x)).$$

For example, if $h_1 = \alpha\beta$, then, $(g; h_1, h_2, \dots, h_n)(e_1) = \alpha\beta g(e_1)$, $(g; h_1, h_2, \dots, h_n)(\alpha e_1) = \beta g(e_1)$, $(g; h_1, h_2, \dots, h_n)(\beta e_1) = \alpha g(e_1)$ and $(g; h_1, h_2, \dots, h_n)(\alpha\beta e_1) = g(e_1)$.

The following result for automorphisms of a map underlying graph B_n is obvious.

Lemma 7.4.1 *Let $(g; h_1, h_2, \dots, h_n)$ be an automorphism of map \mathcal{B}_n underlying a graph B_n . Then*

$$(g; h_1, h_2, \dots, h_n) = (x_1, x_2, \dots, x_{2n})^k$$

and if $(g; h_1, h_2, \dots, h_n)\alpha$ is an automorphism of map \mathcal{B}_n , then

$$(g; h_1, h_2, \dots, h_n)\alpha = (x_1, x_2, \dots, x_{2n})^k$$

for some integer k , $1 \leq k \leq n$, where $x_i \in \{e_1, e_2, \dots, e_n\}$, $i = 1, 2, \dots, 2n$ and $x_i \neq x_j$ if $i \neq j$.

7.4.2 Automorphisms of One-Face Map. Analyzing the structure of elements in group $S_n[S_2]$, we get the automorphisms of maps underlying graph B_n by Theorems 7.3.1 and 7.3.2 as follows.

Theorem 7.4.1 *Let B_n be a bouquet with n edges e_i for $i = 1, 2, \dots, n$. Then the automorphisms $(g; h_1, h_2, \dots, h_n)$ of orientable maps underlying B_n for $n \geq 1$ are respectively*

$$(O1) \quad g \in \mathcal{E}_{[k^{\frac{n}{k}}]}, \quad h_i = 1, i = 1, 2, \dots, n;$$

$$(O2) \quad g \in \mathcal{E}_{[k^{\frac{n}{k}}]} \text{ and if } g = \prod_{i=1}^{n/k} (i_1, i_2, \dots, i_k), \text{ where } i_j \in \{1, 2, \dots, n\}, n/k \equiv 0(\text{mod}2),$$

then $h_{i_1} = (1, \alpha\beta)$, $i = 1, 2, \dots, \frac{n}{k}$ and $h_{i_j} = 1$ for $j \geq 2$;

$$(O3) \quad g \in \mathcal{E}_{[k^{2s}, (2k)^{\frac{n-2ks}{2k}}]} \text{ and if } g = \prod_{i=1}^{2s} (i_1, i_2, \dots, i_k) \prod_{j=1}^{(n-2ks)/2k} (e_{j_1}, e_{j_2}, \dots, e_{j_{2k}}), \text{ where } i_j, e_{j_t} \in \{1, 2, \dots, n\}, \text{ then } h_{i_1} = (1, \alpha\beta), i = 1, 2, \dots, s, h_{i_l} = 1 \text{ for } l \geq 2 \text{ and } h_{j_t} = 1 \text{ for } t = 1, 2, \dots, 2k,$$

and the automorphisms $(g; h_1, h_2, \dots, h_n)$ of non-orientable maps underlying B_n for $n \geq 1$ are respectively

$$(N1) \quad g \in \mathcal{E}_{[k^{\frac{n}{k}}]}, \quad h_i = 1, i = 1, 2, \dots, n;$$

(N2) $g \in \mathcal{E}_{[k^{\frac{n}{k}}]}$ and if $g = \prod_{i=1}^{n/k} (i_1, i_2, \dots, i_k)$, where $i_j \in \{1, 2, \dots, n\}$, $n/k \equiv 0 \pmod{2}$, then $h_{i_1} = (1, \alpha\beta), (1, \beta)$ with at least one $h_{i_{0_1}} = (1, \beta)$ for $i = 1, 2, \dots, \frac{n}{k}$ and $h_{i_j} = 1$ for $j \geq 2$;

(N3) $g \in \mathcal{E}_{[k^{2s}, (2k)^{\frac{n-2ks}{2k}}]}$ and if $g = \prod_{i=1}^{2s} (i_1, i_2, \dots, i_k) \prod_{j=1}^{(n-2ks)/2k} (e_{j_1}, e_{j_2}, \dots, e_{j_{2k}})$, where $i_j, e_{j_t} \in \{1, 2, \dots, n\}$, then $h_{i_1} = (1, \alpha\beta), (1, \beta)$ with at least one $h_{i_{0_1}} = (1, \beta)$ for $i = 1, 2, \dots, s$ and $h_{i_l} = 1$ for $l \geq 2$ and $h_{j_t} = 1$, $t = 1, 2, \dots, 2k$, where \mathcal{E}_θ denotes the conjugacy class in symmetry group $S_{V(\mathcal{B}_n)}$ containing the element θ .

Proof By the structure of group $S_n[S_2]$, it is clear that the elements in the cases (1), (2) and (3) are all semi-regular. We only need to construct an orientable or non-orientable map $\mathcal{B}_n = (\mathcal{X}_{\alpha, \beta}, \mathcal{P}_n)$ underlying B_n stable under the action of elements in each case.

(1) $g = \prod_{i=1}^{n/k} (i_1, i_2, \dots, i_k)$ and $h_i = 1, i = 1, 2, \dots, n$, where $i_j \in \{1, 2, \dots, n\}$.

Choose

$$\mathcal{X}_{\alpha, \beta}^1 = \bigcup_{i=1}^{n/k} K\{i_1, i_2, \dots, i_k\},$$

where $K = \{1, \alpha, \beta, \alpha\beta\}$ and

$$\mathcal{P}_n^1 = C_1(\alpha C_1^{-1} \alpha^{-1})$$

with

$$C_1 = \left(1_1, 2_1, \dots, \left(\frac{n}{k}\right)_1, \alpha\beta 1_1, \alpha\beta 2_1, \dots, \alpha\beta \left(\frac{n}{k}\right)_1, 1_2, 2_2, \dots, \left(\frac{n}{k}\right)_2, \right. \\ \left. \alpha\beta 1_2, \alpha\beta 2_2, \dots, \alpha\beta \left(\frac{n}{k}\right)_2, \dots, 1_k, 2_k, \dots, \left(\frac{n}{k}\right)_k, \alpha\beta 1_k, \alpha\beta 1_k, \dots, \alpha\beta \left(\frac{n}{k}\right)_k \right).$$

Then the map $\mathcal{B}_n^1 = (\mathcal{X}_{\alpha, \beta}^1, \mathcal{P}_n^1)$ is an orientable map underlying graph B_n and stable under the action of $(g; h_1, h_2, \dots, h_n)$.

For the non-orientable case, we chose

$$C_1 = \left(1_1, 2_1, \dots, \left(\frac{n}{k}\right)_1, \beta 1_1, \beta 2_1, \dots, \beta \left(\frac{n}{k}\right)_1, 1_2, 2_2, \dots, \left(\frac{n}{k}\right)_2, \right. \\ \left. \beta 1_2, \beta 2_2, \dots, \beta \left(\frac{n}{k}\right)_2, \dots, 1_k, 2_k, \dots, \left(\frac{n}{k}\right)_k, \beta 1_k, \beta 1_k, \dots, \beta \left(\frac{n}{k}\right)_k \right).$$

Then the map $\mathcal{B}_n^1 = (\mathcal{X}_{\alpha, \beta}^1, \mathcal{P}_n^1)$ is a non-orientable map underlying graph B_n and stable under the action of $(g; h_1, h_2, \dots, h_n)$.

(2) $g = \prod_{i=1}^{n/k} (i_1, i_2, \dots, i_k)$, $h_i = (1, \beta)$ or $(1, \alpha\beta)$, $i = 1, 2, \dots, n$, $\frac{n}{k} \equiv 0 \pmod{2}$, where $i_j \in \{1, 2, \dots, n\}$.

If $h_{i_1} = (1, \alpha\beta)$ for $i = 1, 2, \dots, \frac{n}{k}$ and $h_{i_t} = 1$ for $t \geq 2$, then

$$(g; h_1, h_2, \dots, h_n) = \prod_{i=1}^{n/k} (i_1, \alpha\beta i_2, \dots, \alpha\beta i_k, \alpha\beta i_1, i_2, \dots, i_k).$$

Similar to the case of (1), let $\mathcal{X}_{\alpha\beta}^2 = \mathcal{X}_{\alpha\beta}^1$ and

$$\mathcal{P}_n^2 = C_2(\alpha C_2^{-1} \alpha^{-1})$$

with

$$C_2 = \left(1_1, 2_1, \dots, \left(\frac{n}{k}\right)_1, \alpha\beta 1_2, \alpha\beta 2_2, \dots, \alpha\beta \left(\frac{n}{k}\right)_2, \alpha\beta 1_k, \alpha\beta 2_k, \dots, \alpha\beta \left(\frac{n}{k}\right)_k, \alpha\beta 1_1, \alpha\beta 2_1, \dots, \alpha\beta \left(\frac{n}{k}\right)_1, 1_2, 2_2, \dots, \left(\frac{n}{k}\right)_2, \dots, 1_k, 2_k, \dots, \left(\frac{n}{k}\right)_k \right).$$

Then the map $\mathcal{B}_n^2 = (\mathcal{X}_{\alpha\beta}^2, \mathcal{P}_n^2)$ is an orientable map underlying graph B_n and stable under the action of $(g; h_1, h_2, \dots, h_n)$. For the non-orientable case, the construction is similar. Now it only need to replace each element $\alpha\beta i_j$ by that of βi_j in the construction of the orientable case if $h_{i_j} = (1, \beta)$.

(3) $g = \prod_{i=1}^{2s} (i_1, i_2, \dots, i_k) \prod_{j=1}^{(n-2ks)/2k} (e_{j_1}, e_{j_2}, \dots, e_{j_{2k}})$ and $h_{i_1} = (1, \alpha\beta)$, $i = 1, 2, \dots, s$, $h_{i_l} = 1$ for $l \geq 2$ and $h_{j_t} = 1$ for $t = 1, 2, \dots, 2k$.

In this case, we know that

$$(g; h_1, h_2, \dots, h_n) = \prod_{i=1}^s (i_1, \alpha\beta i_2, \dots, \alpha\beta i_k, \alpha\beta i_1, i_2, \dots, i_k) \prod_{j=1}^{(n-2ks)/2k} (e_{j_1}, e_{j_2}, \dots, e_{j_{2k}}).$$

Denote by p the number $(n - 2ks)/2k$. We construct an orientable map $\mathcal{B}_n^3 = (\mathcal{X}_{\alpha\beta}^3, \mathcal{P}_n^3)$ underlying B_n stable under the action of $(g; h_1, h_2, \dots, h_n)$ as follows.

Take

$$\mathcal{X}_{\alpha\beta}^3 = \mathcal{X}_{\alpha\beta}^1 \quad \text{and} \quad \mathcal{P}_n^3 = C_3(\alpha C_3^{-1} \alpha^{-1})$$

with

$$C_3 = \left(1_1, 2_1, \dots, s_1, e_{1_1}, e_{2_1}, \dots, e_{p_1}, \alpha\beta 1_2, \alpha\beta 2_2, \dots, \alpha\beta s_2, e_{1_2}, e_{2_2}, \dots, e_{p_2}, \dots, \alpha\beta 1_k, \alpha\beta 2_k, \dots, \alpha\beta s_k, e_{1_k}, e_{2_k}, \dots, e_{p_k}, \alpha\beta 1_1, \alpha\beta 2_1, \dots, \alpha\beta s_1, e_{1_{k+1}}, e_{2_{k+1}}, \dots, e_{p_{k+1}}, 1_2, 2_2, \dots, s_2, e_{1_{k+2}}, e_{2_{k+2}}, \dots, e_{p_{k+2}}, \dots, 1_k, 2_k, \dots, s_k, e_{1_{2k}}, e_{2_{2k}}, \dots, e_{p_{2k}} \right).$$

Then the map $\mathcal{B}_n^3 = (\mathcal{X}_{\alpha\beta}^3, \mathcal{P}_n^3)$ is an orientable map underlying graph B_n and stable under the action of $(g; h_1, h_2, \dots, h_n)$.

Similarly, replacing each element $\alpha\beta i_j$ by βi_j in the construction of the orientable case if $h_{i_j} = (1, \beta)$, a non-orientable map underlying graph B_n and stable under the action of $(g; h_1, h_2, \dots, h_n)$ can be also constructed. This completes the proof. \square

We will apply Theorem 7.4.1 for the enumeration of one face maps on surfaces in Chapter 8.

§7.5 REMARKS

7.5.1 An automorphism of map M is an automorphism of graph underlying that of M . But the conversely is not always true. Any map automorphism is fixed-free, i.e., semi-regular, particularly, an automorphism of regular map is regular. This fact enables one to characterize those automorphisms of maps underlying a graph. Certainly, there is an naturally induced action $g|_{\mathcal{X}_{\alpha\beta}}$ for an automorphism $g \in \text{Aut}G$ of graph G on quadricells in maps underlying G , i.e.,

$$(\alpha x)^g = \alpha y, (\beta x)^g = \beta y, (\alpha\beta x)^g = \alpha\beta y$$

if $x^g = y$ for $\forall x \in \mathcal{X}_{\alpha\beta}(M(G))$. Consider the action of $\text{Aut}G$ on $\mathcal{X}_{\alpha\beta}(M(G))$. Then we get the following result by definition.

Theorem 7.5.1 *An automorphism g of G is a map automorphism if and only if there is a map $M(G)$ stabilized under the action of $g|_{\mathcal{X}_{\alpha\beta}}$.*

Theorems 7.1.1 and 7.1.2 enables one to characterize such map automorphisms in another way, i.e., the following.

Theorem 7.5.2 *An automorphism $g \in \text{Aut}G$ of graph G is an automorphism of map underlying G if and only if $\langle g \rangle_v \leq \langle v \rangle \times \langle \alpha \rangle$ for $\forall v \in V(G)$.*

7.5.2 We get these permutation presentations for automorphisms of maps underlying a complete graph, a semi-regular graph and a bouquet, which enables us to calculate the stabilizer $\Phi(g)$ of g on maps underlying such a graph in Chapter 8. A general problem is the following.

Problem 7.5.1 *Find a permutation presentation for map automorphisms induced by such automorphisms of a graph G on quadricells $\mathcal{X}_{\alpha,\beta}$ with base set $X = E(G)$, particularly, find such presentations for complete bipartite graphs, cubes, generalized Petersen graphs or regular graphs in general.*

7.5.3 We had introduced graph multigroup for characterizing the local symmetry of a graph, i.e., let G be a connected graph, $H \leq G$ a connected subgraph and $\tau \in \text{Aut}G$. Similarly, consider the induced action of τ on $\mathcal{X}_{\alpha,\beta}$ with base set $X = E(H)$. Then the following problem is needed to answer.

Problem 7.5.2 *Characterize automorphisms of maps underlying H induced by automorphisms of graph G , or verse via, characterize automorphisms of maps underlying G induced by automorphisms of graph H by introducing the action of $\text{Aut}H$ on $G \setminus H$ with a stabilizer H .*

CHAPTER 8.

Enumerating Maps on Surfaces

There are two kind of maps usually considered for enumeration in literature. One is the rooted map, i.e., a quadricell on map marked beforehand. Such a map is symmetry-freed, i.e., its automorphism group is trivial. Another is the map without roots marked. The enumeration of maps on surfaces underlying a graph can be carried out by the following programming:

STEP 1. Determine all automorphisms g of maps underlying graph G ;

STEP 2. Calculate the the fixing set $\Phi_1(g)$ or $\Psi_2(g)$ for each automorphism $g \in \text{Aut}_{\frac{1}{2}} G$;

STEP 3. Enumerate the maps on surfaces underlying graph G by Burnside lemma.

This approach is independent on the orientability of maps. So it enables one to enumerate orientable or non-orientable maps on surfaces both. The roots distribution and a formula for rooted maps underlying a graph are included in the first two sections. Then a general enumeration scheme for maps underlying a graph is introduced in Section 3. By applying this scheme, the enumeration formulae for maps underlying a complete graph, a semi-regular graph or a bouquet are obtained by applying automorphisms of maps determined in last chapter in Sections 8.3-8.6, respectively.

§8.1 ROOTS DISTRIBUTION ON EMBEDDINGS

8.1.1 Roots on Embedding. A root of an embedding $M = (\mathcal{X}_{\alpha,\beta}, \mathcal{P})$ of graph G is an element in $X_{\alpha,\beta}$. A root r is called an i -root if it is incident with a vertex of valency i . Two i -roots r_1, r_2 are *transitive* if there exists $\tau \in \text{Aut}M$ such that $\tau(r_1) = r_2$. An *enumerator* $v(D, x)$ and the *root polynomials* $r(M, x), r(\mathcal{M}(D), x)$ of M are defined by

$$v(D, x) = \sum_{i \geq 1} i v_i x^i;$$

$$r(M, x) = \sum_{i \geq 1} r(M, i) x^i,$$

where $r(M, i)$ denotes the number of non-transitive i -roots in M and

$$r(\mathcal{M}(D), x) = \sum_{M \in \mathcal{M}(D)} r(M, x).$$

Theorem 8.1.1 *For any embedding M (orientable or non-orientable),*

$$r(M, i) = \frac{2i v_i}{|\text{Aut}M|},$$

where v_i denotes the number of vertices with valency i in M .

Proof Let U be all i -roots on M . Since $U^{\text{Aut}M} = U$, $\text{Aut}M$ is also a permutation group acting on U , and $r(M, i)$ is the number of orbits in U under the action of $\text{Aut}M$. It is clear that $|U| = 2i v_i$. For $\forall r \in U$, $(\text{Aut}M)_r$ is the trivial group by Theorem 5.3.5. According to Theorem 2.1.1(3), $|\text{Aut}M| = |(\text{Aut}M)_r| |r^{\text{Aut}M}|$, we get that $|r^{\text{Aut}M}| = |\text{Aut}M|$. Thus the length of each orbit in U under this action has $|\text{Aut}M|$ elements. Whence,

$$r(M, i) = \frac{|U|}{|\text{Aut}M|} = \frac{2i v_i}{|\text{Aut}M|}. \quad \square$$

Applying Theorem 8.1.1, we get a relation between $v(D, x)$ and $r(M, x)$ following.

Theorem 8.1.2 *For an embedding M (orientable or non-orientable) with valency sequence D ,*

$$r(M, x) = \frac{2v(D, x)}{|\text{Aut}M|}.$$

Proof By Theorem 8.1.1, we know that $r(M, i) = \frac{2i v_i}{|\text{Aut}M|}$, where v_i denotes the number of vertices of valency i in M . So we have

$$r(M, x) = \sum_{i \geq 1} r(M, i) x^i$$

$$= \sum_{i \geq 1} \frac{2iv_i}{|\text{AutM}|} = \frac{2v(D, x)}{|\text{AutM}|} \quad \square$$

Let $r(M)$ denotes the number of non-transitive roots on an embedding M . As a by-product, we get $r(M)$ by Theorem 8.1.2 following.

Corollary 8.1.1 *For a given embedding M ,*

$$r(M) = \frac{4\varepsilon(M)}{|\text{AutM}|},$$

where $\varepsilon(M)$ denotes the number of edges of M .

Proof According to Theorem 8.1.2, we know that

$$r(M) = r(M, 1) = \frac{2v(D, 1)}{|\text{AutM}|} = \frac{1}{|\text{AutM}|} \sum_{i \geq 1} 2iv_i.$$

Notice $\sum_{i \geq 1} iv_i = 2\varepsilon(M)$. We get that

$$r(M) = \frac{4\varepsilon(M)}{|\text{AutM}|}. \quad \square$$

8.1.2 Root Distribution. Let G be a connected simple graph and $D = \{d_1, d_2, \dots, d_v\}$ its valency sequence. For $\forall g \in \text{Aut}G$, there is an extended action $g|_{\mathcal{X}_{\alpha, \beta}}$ acting on $\mathcal{X}_{\alpha, \beta}$ with $X = E(G)$. Define the *orientable embedding index* $\theta^O(G)$ of G and the *orientable embedding index* $\theta^O(D)$ of D respectively by

$$\theta^O(G) = \sum_{M \in \mathcal{M}(G)} \frac{1}{|\text{AutM}|},$$

$$\theta^O(D) = \sum_{G \in \mathcal{G}(D)} \sum_{M \in \mathcal{M}(G)} \frac{1}{|\text{AutM}|},$$

where $\mathcal{G}(D)$ denotes the family of graphs with valency sequence D . Then we have the following results.

Theorem 8.1.3 *For any connected simple graph G and a valency sequence D ,*

$$\theta^O(G) = \frac{\prod_{d \in D(G)} (d-1)!}{2|\text{AutG}|} \quad \text{and} \quad \theta^O(D) = \frac{\prod_{d \in D(G)} (d-1)!}{2|\Delta(D)|},$$

where

$$|\Delta(D)|^{-1} = \sum_{G \in \mathcal{G}(D)} \frac{1}{|\text{AutG}|}.$$

Proof Let W be the set of all embeddings of graph G on orientable surfaces. Since there is a bijection between the rotation scheme set $\varrho(G)$ of G and W , it is clear that $|W| = |\varrho(G)| = \prod_{d \in D(G)} (d-1)!$. Notice that every element $\xi \in \text{Aut}G$ naturally induces an $g|\mathcal{X}_{\alpha\beta}$ action on W . Since for an embedding M , $\xi \in \text{Aut}M$ if and only if $\xi \in (\text{Aut}G \times \langle \alpha \rangle)_M$, so $\text{Aut}M = (\text{Aut}G \times \langle \alpha \rangle)_M$. By $|\text{Aut}G \times \langle \alpha \rangle| = |(\text{Aut}G \times \langle \alpha \rangle)_M| |M^{\text{Aut}G \times \langle \alpha \rangle}|$, we get that

$$|M^{\text{Aut}G \times \langle \alpha \rangle}| = \frac{|\text{Aut}G \times \langle \alpha \rangle|}{|\text{Aut}M|}.$$

Therefore, we have that

$$\begin{aligned} \theta^O(G) &= \sum_{M \in \mathcal{M}(G)} \frac{1}{|\text{Aut}M|} \\ &= \frac{1}{|\text{Aut}G \times \langle \alpha \rangle|} \sum_{M \in \mathcal{M}(G)} \frac{|\text{Aut}G \times \langle \alpha \rangle|}{|\text{Aut}M|} \\ &= \frac{1}{|\text{Aut}G|} \sum_{M \in \mathcal{M}(G)} |M^{\text{Aut}G \times \langle \alpha \rangle}| \\ &= \frac{|W|}{2|\text{Aut}G|} = \frac{\prod_{d \in D(G)} (d-1)!}{2|\text{Aut}G|} \end{aligned}$$

and

$$\begin{aligned} \theta^O(D) &= \sum_{G \in \mathcal{G}(D)} \frac{\prod_{d \in D(G)} (d-1)!}{2|\text{Aut}G|} \\ &= \frac{1}{2} \prod_{d \in D(G)} (d-1)! \left(\sum_{G \in \mathcal{G}(D)} \frac{1}{|\text{Aut}G|} \right) \\ &= \frac{\prod_{d \in D(G)} (d-1)!}{2|\Delta(D)|}. \end{aligned} \quad \square$$

Now we prove the main result of this subsection.

Theorem 8.1.4 For a given valency sequence $D = \{d_1, d_2, \dots, d_v\}$,

$$r(\mathcal{M}(D), x) = \frac{v(D, x) \prod_{d \in D(G)} (d-1)!}{|\Delta(D)|}.$$

where,

$$|\Delta(D)|^{-1} = \sum_{G \in \mathcal{G}(D)} \frac{1}{|\text{Aut}G|}.$$

Proof By the definition of $r(\mathcal{M}(D), x)$, we know that

$$\begin{aligned} r(\mathcal{M}(D), x) &= \sum_{M \in \mathcal{M}(D)} r(M, x) \\ &= \sum_{G \in \mathcal{G}(D)} \sum_{M \in \mathcal{M}(G)} r(M, x). \end{aligned}$$

According to Theorem 8.1.3, we know that

$$r(\mathcal{M}(D), x) = \sum_{G \in \mathcal{G}(D)} \sum_{M \in \mathcal{M}(G)} \frac{2v(D, x)}{|\text{Aut}M|} = 2v(D, x)\theta(D).$$

Whence,

$$\theta(D) = \frac{\prod_{d \in D(G)} (d-1)!}{2|\Delta(D)|}.$$

Therefore, we finally get that

$$r(\mathcal{M}(D), x) = \frac{v(D, x) \prod_{d \in D(G)} (d-1)!}{|\Delta(D)|}. \quad \square$$

Corollary 8.1.2 For a connected simple graph G , let $D(G) = \{d_1, d_2, \dots, d_v\}$ be its valency sequence. Then

$$r(\mathcal{M}(G), x) = \frac{v(D, x) \prod_{d \in D(G)} (d-1)!}{|\text{Aut}G|}.$$

Corollary 8.1.4 The number of all non-transitive i -roots in embeddings underlying a connected simple graph G is

$$\frac{iv_i \prod_{d \in D(G)} (d-1)!}{|\text{Aut}G|},$$

where v_i denotes the number of vertices of valency i in G .

Corollary 8.1.5 The number $r(\mathcal{M}(G))$ of non-transitive roots in embeddings of simple graph G on orientable surfaces is

$$r(\mathcal{M}(G)) = \frac{2\varepsilon(G) \prod_{d \in D(G)} (d-1)!}{|\text{Aut}G|}.$$

Proof According to Theorem 8.1.2 and Corollary 8.1.2, we know that

$$\begin{aligned} r(\mathcal{M}(G)) &= r(\mathcal{M}(G), 1) \\ &= \frac{\prod_{d \in D(G)} (d-1)!v(D, 1)}{|\text{Aut}G|}. \end{aligned}$$

Notice that $\nu(D, 1) = \sum_{i \geq 1} i\nu_i = 2\varepsilon(M)$. So we find that

$$r(\mathcal{M}(G)) = \frac{2\varepsilon(G) \prod_{d \in D(G)} (d-1)!}{|\text{Aut}G|}. \quad \square$$

Theorem 8.1.4 enables one to enumerate roots on embeddings underlying a vertex-transitive graphs, a symmetric graph, \dots , etc. For example, we can apply Corollary 8.1.5 to count the roots on embeddings underlying a complete graph K_n . In this case, $\text{Aut}K_n = S_{V(K_n)}$, so $|\text{Aut}K_n| = n!$. Therefore,

$$r(\mathcal{M}(K^n)) = \frac{n(n-1)((n-2)!)^n}{n!} = ((n-2)!)^{n-1}.$$

let $n = 4$. Calculation shows that there are eight non-transitive roots on embeddings underlying K^4 , shown in the Fig.8.1.1, in which each arrow represents a root.

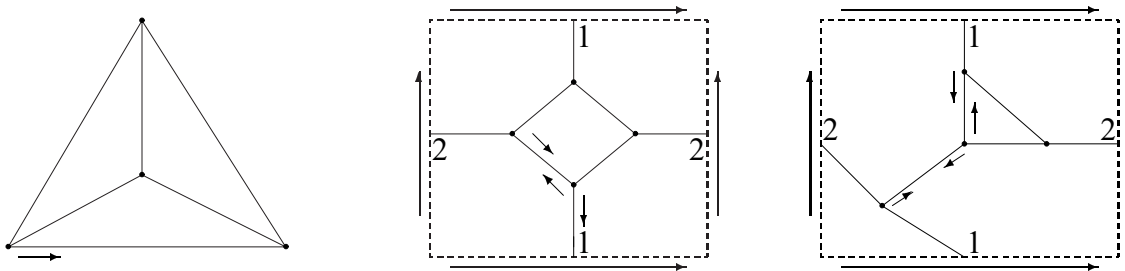

Fig.8.1.1

8.1.3 Rooted Map. A rooted map M^r is such a map $M = (\mathcal{X}, \mathcal{P})$ with one quadricell $r \in \mathcal{X}_{\alpha,\beta}$ is marked beforehand, which is introduced by Tutte for the enumeration of planar maps. Two rooted maps $M_1^{r_1}$ and $M_2^{r_2}$ are said to be *isomorphic* if there is an isomorphism $\theta : M_1 \rightarrow M_2$ between M_1 and M_2 such that $\theta(r_1) = r_2$, particularly, if $M_1 = M_2 = M$, two rooted maps M^{r_1} and M^{r_2} are isomorphic if and only if there is an automorphism $\tau \in \text{Aut}M$ such that $\tau(r_1) = r_2$. All automorphisms of a rooted map M^r form a group, denoted by $\text{Aut}M^r$. By Theorem 5.3.5, we know the following result.

Theorem 8.1.5 $\text{Aut}M^r$ is a trivial group.

The importance of the idea introduced a root on map is that it turns any map to a non-symmetry map. The following result enables one to enumerate rooted maps by that of roots on maps.

Theorem 8.1.6 For a map $M = (\mathcal{X}_{\alpha,\beta}, \mathcal{P})$, the number of non-isomorphic rooted maps is equal to that of non-transitive roots on map M .

Proof Let r_1 and r_2 be two non-transitive roots on M . Then M^{r_1} and M^{r_2} are non-isomorphic by definition. Conversely, if M^{r_1} and M^{r_2} are non-isomorphic, there are no automorphisms $\tau \in \text{Aut}M$ such that $\tau(r_1) = r_2$, i.e., r_1 and r_2 are non-transitive. \square

Theorem 8.1.6 turns the enumeration of rooted maps by that of roots on maps.

Theorem 8.1.7 The number $r^O(G)$ of rooted maps on orientable surfaces underlying a connected graph G is

$$r^O(G) = \frac{2\varepsilon(G) \prod_{v \in V(G)} (\rho(v) - 1)!}{|\text{Aut}_{\frac{1}{2}}G|},$$

where $\rho(v)$ denotes the valency of vertex v .

Proof Denotes the set of all non-isomorphic orientable maps with underlying graph G by $M^O(G)$. According to Corollary 8.1.1 and Theorem 8.1.6, we know that

$$r^O(G) = \sum_{M \in M^O(G)} \frac{4\varepsilon(M)}{|\text{Aut}M|}.$$

Notice that every element $\xi \in \text{Aut}G_{\frac{1}{2}} \times \langle \alpha \rangle$ natural induces an action on $\mathcal{E}^O(G)$. By Theorem 5.3.3, $\forall M \in \mathcal{M}(G)$, $\tau \in \text{Aut}M$ if and only if, $\tau \in (\text{Aut}G_{\frac{1}{2}} \times \langle \alpha \rangle)_M$. Whence, $\text{Aut}M = (\text{Aut}G_{\frac{1}{2}} \times \langle \alpha \rangle)_M$. According to Theorem 2.1.1(3), $|\text{Aut}G_{\frac{1}{2}} \times \langle \alpha \rangle| = |(\text{Aut}G_{\frac{1}{2}} \times \langle \alpha \rangle)_M| |M^{\text{Aut}G_{\frac{1}{2}} \times \langle \alpha \rangle}|$. We therefore get that

$$|M^{\text{Aut}G_{\frac{1}{2}} \times \langle \alpha \rangle}| = \frac{2|\text{Aut}G|}{|\text{Aut}M|}.$$

Whence,

$$\begin{aligned} r^O(G) &= 4\varepsilon(G) \sum_{M \in M^O(G)} \frac{1}{|\text{Aut}M|} \\ &= \frac{4\varepsilon(G)}{|\text{Aut}G_{\frac{1}{2}} \times \langle \alpha \rangle|} \sum_{M \in M^O(G)} \frac{|\text{Aut}G_{\frac{1}{2}} \times \langle \alpha \rangle|}{|\text{Aut}M|} \\ &= \frac{4\varepsilon(G)}{|\text{Aut}G_{\frac{1}{2}} \times \langle \alpha \rangle|} \sum_{M \in M^O(G)} |M^{\text{Aut}G_{\frac{1}{2}} \times \langle \alpha \rangle}| \\ &= \frac{4\varepsilon(G)|\mathcal{E}^O(G)|}{2|\text{Aut}G_{\frac{1}{2}}|} = \frac{2\varepsilon(G) \prod_{v \in V(G)} (\rho(v) - 1)!}{|\text{Aut}_{\frac{1}{2}}G|} \quad \square \end{aligned}$$

By Theorems 3.4.1 and 8.1.7, we get a corollary for the number of rooted orientable maps underlying a simple graph, which is the same as Corollary 8.1.5 following.

Corollary 8.1.6 *The number $r^O(G)$ of rooted maps on orientable surfaces underlying a connected simple graph G is*

$$r^O(G) = \frac{2\varepsilon(G) \prod_{v \in V(G)} (\rho(v) - 1)!}{|\text{Aut}G|}.$$

For rooted maps on locally orientable surfaces underlying a connected graph G , we know the following result.

Theorem 8.1.8 *The number $r^L(G)$ of rooted maps on surfaces underlying a connected graph G is*

$$r^L(G) = \frac{2^{\beta(G)+1} \varepsilon(G) \prod_{v \in V(G)} (\rho(v) - 1)!}{|\text{Aut}_{\frac{1}{2}}G|}.$$

Proof The proof is similar to that of Theorem 8.1.7. In fact, by Corollaries 5.1.2, 8.1.1 and Theorem 8.1.6, let $\mathcal{M}^L(G)$ be the set of all non-isomorphic maps underlying graph G . Then

$$\begin{aligned} r^L(G) &= \sum_{M \in \mathcal{M}^L(G)} \frac{4\varepsilon(M)}{|\text{Aut}M|} = 4\varepsilon(G) \sum_{M \in \mathcal{M}^L(G)} \frac{1}{|\text{Aut}M|} \\ &= \frac{4\varepsilon(G)}{|\text{Aut}G_{\frac{1}{2}} \times \langle \alpha \rangle|} \sum_{M \in \mathcal{M}^L(G)} \frac{|\text{Aut}G_{\frac{1}{2}} \times \langle \alpha \rangle|}{|\text{Aut}M|} \\ &= \frac{4\varepsilon(G)}{|\text{Aut}G_{\frac{1}{2}} \times \langle \alpha \rangle|} \sum_{M \in \mathcal{M}^L(G)} |M^{\text{Aut}G_{\frac{1}{2}} \times \langle \alpha \rangle}| \\ &= \frac{4\varepsilon(G)|\mathcal{E}^L(G)|}{2|\text{Aut}G_{\frac{1}{2}}|} = \frac{2^{\beta(G)+1} \varepsilon(G) \prod_{v \in V(G)} (\rho(v) - 1)!}{|\text{Aut}_{\frac{1}{2}}G|}. \end{aligned}$$

This completes the proof. □

Since $r^L(G) = r^O(G) + r^N(G)$, we also get the number $r^N(G)$ of rooted maps on non-orientable surfaces underlying a connected graph G following.

Theorem 8.1.9 *The number $r^N(G)$ of rooted maps on non-orientable surfaces underlying a connected graph G is*

$$r^N(G) = \frac{(2^{\beta(G)+1} - 2)\varepsilon(G) \prod_{v \in V(G)} (\rho(v) - 1)!}{|\text{Aut}_{\frac{1}{2}}G|}.$$

According to Theorems 8.1.8 and 8.1.9, we get the following table for the numbers of rooted maps on surfaces underlying a few well-known graphs.

G	$r^O(G)$	$r^N(G)$
P_n	$n - 1$	0
C_n	1	1
K_n	$(n - 2)!^{n-1}$	$(2^{\frac{(n-1)(n-2)}{2}} - 1)(n - 2)!^{n-1}$
$K_{m,n}(m \neq n)$	$2(m - 1)!^{n-1}(n - 1)!^{m-1}$	$(2^{mn-m-n+2} - 2)(m - 1)!^{n-1}(n - 1)!^{m-1}$
$K_{n,n}$	$(n - 1)!^{2n-2}$	$(2^{n^2-2n+2} - 1)(n - 1)!^{2n-2}$
B_n	$\frac{(2n)!}{2^n n!}$	$(2^{n+1} - 1)\frac{(2n)!}{2^n n!}$
Dp_n	$(n - 1)!$	$(2^n - 1)(n - 1)!$
$Dp_n^{k,l}(k \neq l)$	$\frac{(n+k+l)(n+2k-1)!(n+2l-1)!}{2^{k+l-1}n!k!l!}$	$\frac{(2^{n+k+l}-1)(n+k+l)(n+2k-1)!(n+2l-1)!}{2^{k+l-1}n!k!l!}$
$Dp_n^{k,k}$	$\frac{(n+2k)(n+2k-1)!^2}{2^{2k}n!k!^2}$	$\frac{(2^{n+2k}-1)(n+2k)(n+2k-1)!^2}{2^{2k}n!k!^2}$

Table 8.1.1

§8.2 ROOTED MAP ON GENUS UNDERLYING A GRAPH

8.2.1 Rooted Map Polynomial. For a graph G with maximum valency ≥ 3 , assume that $r_i(G), \tilde{r}_i(G), i \geq 0$ are respectively the numbers of rooted maps underlying graph G on orientable surface of genus $\gamma(G) + i - 1$ or on non-orientable surface of genus $\tilde{\gamma}(G) + i - 1$, where $\gamma(G)$ and $\tilde{\gamma}(G)$ denote the minimum orientable genus and the minimum non-orientable genus of G , respectively. The *rooted orientable map polynomial* $r[G](x)$, *rooted non-orientable map polynomial* $\tilde{r}[G](x)$ and *rooted total map polynomial* $R[G](x)$ on genus are defined by

$$r[G](x) = \sum_{i \geq 0} r_i(G)x^i,$$

$$\tilde{r}[G](x) = \sum_{i \geq 0} \tilde{r}_i(G)x^i$$

and

$$R[G](x) = \sum_{i \geq 0} r_i(G)x^i + \sum_{i \geq 1} \tilde{r}_i(G)x^{-i}.$$

We have known that the total number of orientable embeddings of G is $\prod_{d \in D(G)} (d - 1)!$ and non-orientable embeddings is $(2^{\beta(G)} - 1) \prod_{d \in D(G)} (d - 1)!$ by Corollary 5.1.2, where $D(G)$

is its valency sequence. Similarly, let $g_i(G)$ and $\tilde{g}_i(G)$, $i \geq 0$ respectively be the number of embeddings of G on the orientable surface with genus $\gamma(G) + i - 1$ and on the non-orientable surface with genus $\tilde{\gamma}(G) + i - 1$. The *orientable genus polynomial* $g[G](x)$, *non-orientable genus polynomial* $\tilde{g}[G](x)$ and *total genus polynomial* $\mathcal{G}[G](x)$ of graph G are defined respectively by

$$g[G](x) = \sum_{i \geq 0} g_i(G)x^i,$$

$$\tilde{g}[G](x) = \sum_{i \geq 0} \tilde{g}_i(G)x^i$$

and

$$\mathcal{G}[G](x) = \sum_{i \geq 0} g_i(G)x^i + \sum_{i \geq 1} \tilde{g}_i(G)x^{-i}.$$

All these polynomials $r[G](x)$, $\bar{r}[G](x)$, $R[G](x)$ and $g[G](x)$, $\tilde{g}[G](x)$, $\mathcal{G}[G](x)$ are finite by properties of G on surfaces, for example, Theorem 5.1.2.

We establish relations between $r[G](x)$ and $g[G](x)$, $\bar{r}[G](x)$ and $\tilde{g}[G](x)$, $R[G](x)$ and $\mathcal{G}[G](x)$ in the following result.

Theorem 8.2.1 *For a connected graph G ,*

$$|\text{Aut}_{\frac{1}{2}}G| r[G](x) = 2\varepsilon(G) g[G](x),$$

$$|\text{Aut}_{\frac{1}{2}}G| \bar{r}[G](x) = 2\varepsilon(G) \tilde{g}[G](x)$$

and

$$|\text{Aut}_{\frac{1}{2}}G| R[G](x) = 2\varepsilon(G) \mathcal{G}(x).$$

Proof For an integer k , denotes by $\mathcal{M}_k(G, S)$ all the non-isomorphic maps on an orientable surface S with genus $\gamma(G) + k - 1$. According to the Corollary 8.1.1, we know that

$$r_k(G) = \sum_{M \in \mathcal{M}_k(G, S)} \frac{4\varepsilon(M)}{|\text{Aut}M|}$$

$$= \frac{4\varepsilon(G)}{|\text{Aut}_{\frac{1}{2}}G \times \langle \alpha \rangle|} \sum_{M \in \mathcal{M}_k(G, S)} \frac{|\text{Aut}_{\frac{1}{2}}G \times \langle \alpha \rangle|}{|\text{Aut}M|}.$$

Since $|\text{Aut}_{\frac{1}{2}}G \times \langle \alpha \rangle| = |(\text{Aut}_{\frac{1}{2}}G \times \langle \alpha \rangle)_M| |M^{\text{Aut}_{\frac{1}{2}}G \times \langle \alpha \rangle}|$ and $|(\text{Aut}_{\frac{1}{2}}G \times \langle \alpha \rangle)_M| = |\text{Aut}M|$, we know that

$$r_k(G) = \frac{4\varepsilon(G)}{|\text{Aut}_{\frac{1}{2}}G \times \langle \alpha \rangle|} \sum_{M \in \mathcal{M}_k(G, S)} |M^{\text{Aut}_{\frac{1}{2}}G \times \langle \alpha \rangle}| = \frac{2\varepsilon(G)g_k(G)}{|\text{Aut}_{\frac{1}{2}}G|}.$$

Consequently,

$$\begin{aligned}
 |\text{Aut}_{\frac{1}{2}}G| r[G](x) &= |\text{Aut}_{\frac{1}{2}}G| \sum_{i \geq 0} r_i(G)x^i \\
 &= \sum_{i \geq 0} |\text{Aut}_{\frac{1}{2}}G| r_i(G)x^i \\
 &= \sum_{i \geq 0} 2\varepsilon(G)g_i(G)x^i = 2\varepsilon(G) g[G](x).
 \end{aligned}$$

Similarly, let $\widetilde{\mathcal{M}}_k(G, \widetilde{S})$ be all non-isomorphic maps on a non-orientable surface \widetilde{S} with genus $\widetilde{\gamma}(G) + k - 1$. Similar to the orientable case, we get that

$$\begin{aligned}
 \widetilde{r}_k(G) &= \frac{4\varepsilon(G)}{|\text{Aut}_{\frac{1}{2}}G \times \langle \alpha \rangle|} \sum_{M \in \widetilde{\mathcal{M}}_k(G, \widetilde{S})} \frac{|\text{Aut}_{\frac{1}{2}}G \times \langle \alpha \rangle|}{|\text{Aut}M|} \\
 &= \frac{4\varepsilon(G)}{|\text{Aut}_{\frac{1}{2}}G \times \langle \alpha \rangle|} \sum_{M \in \widetilde{\mathcal{M}}_k(G, \widetilde{S})} |M^{\text{Aut}_{\frac{1}{2}}G \times \langle \alpha \rangle}| \\
 &= \frac{2\varepsilon(G)\widetilde{g}_k(G)}{|\text{Aut}_{\frac{1}{2}}G|}.
 \end{aligned}$$

Whence,

$$\begin{aligned}
 |\text{Aut}_{\frac{1}{2}}G| \widetilde{r}[G](x) &= \sum_{i \geq 0} |\text{Aut}_{\frac{1}{2}}G| \widetilde{r}_i(G)x^i \\
 &= \sum_{i \geq 0} 2\varepsilon(G)\widetilde{g}_i(G)x^i = 2\varepsilon(G) \widetilde{g}[G](x).
 \end{aligned}$$

Notice that

$$R[G](x) = \sum_{i \geq 0} r_i(G)x^i + \sum_{i \geq 1} \widetilde{r}_i(G)x^{-i}$$

and

$$\mathcal{G}[G](x) = \sum_{i \geq 0} g_i(G)x^i + \sum_{i \geq 1} \widetilde{g}_i(G)x^{-i}.$$

We also get that

$$r_k(G) = \frac{2\varepsilon(G)g_k(G)}{|\text{Aut}_{\frac{1}{2}}G|} \quad \text{and} \quad \widetilde{r}_k(G) = \frac{2\varepsilon(G)\widetilde{g}_k(G)}{|\text{Aut}_{\frac{1}{2}}G|}$$

for integers $k \geq 0$. Therefore, we get that

$$\begin{aligned}
 |\text{Aut}_{\frac{1}{2}}G| R[G](x) &= |\text{Aut}_{\frac{1}{2}}G| \left(\sum_{i \geq 0} r_i(G)x^i + \sum_{i \geq 1} \widetilde{r}_i(G)x^{-i} \right) \\
 &= \sum_{i \geq 0} |\text{Aut}_{\frac{1}{2}}G| r_i(G)x^i + \sum_{i \geq 1} |\text{Aut}_{\frac{1}{2}}G| \widetilde{r}_i(G)x^{-i} \\
 &= \sum_{i \geq 0} 2\varepsilon(G)g_i(G)x^i + \sum_{i \geq 0} 2\varepsilon(G)\widetilde{g}_i(G)x^{-i} = 2\varepsilon(G) \mathcal{G}[G](x).
 \end{aligned}$$

This completes the proof. □

Corollary 8.2.1 *Let G be a graph and $s \geq 0$ an integer. If $r_s(G)$ and $g_s(G)$ are the numbers of rooted maps and embeddings on a locally orientable surface of genus s underlying graph G , respectively. Then*

$$r_s(G) = \frac{2\varepsilon(G)g_s(G)}{|\text{Aut}_{\frac{1}{2}}G|}.$$

8.2.2 Rooted Map Sequence. Corollary 8.2.1 can be used to find the implicit relations among $r[G](x)$, $\tilde{r}[G](x)$ or $R[G](x)$ if the implicit relations among $g[G](x)$, $\tilde{g}[G](x)$ or $G[G](x)$ are known, and vice via.

Denote the variable vector (x_1, x_2, \dots) by \mathbf{x} ,

$$\mathbf{r}(G) = (\dots, \tilde{r}_2(G), \tilde{r}_1(G), r_0(G), r_1(G), r_2(G), \dots),$$

$$\mathbf{g}(G) = (\dots, \tilde{g}_2(G), \tilde{g}_1(G), g_0(G), g_1(G), g_2(G), \dots).$$

We call $\mathbf{r}(G)$ and $\mathbf{g}(G)$ the *rooted map sequence* and the *embedding sequence* of graph G , respectively.

Define a function $F(\mathbf{x}, \mathbf{y})$ to be *y-linear* if it can be represented as the following form

$$F(\mathbf{x}, \mathbf{y}) = f(x_1, x_2, \dots) + h(x_1, x_2, \dots) \sum_{i \in I} y_i + l(x_1, x_2, \dots) \sum_{\Lambda \in O} \Lambda(\mathbf{y}),$$

where I denotes a subset of index and O a set of linear operators. Notice that $f(x_1, x_2, \dots) = F(\mathbf{x}, \mathbf{0})$, where $\mathbf{0} = (0, 0, \dots)$. We get the following general result.

Theorem 8.2.2 *Let \mathcal{G} be a graph family and $\mathcal{H} \subseteq \mathcal{G}$. If their embedding sequences $\mathbf{g}(G)$, $G \in \mathcal{H}$ satisfy the equation*

$$F_{\mathcal{H}}(\mathbf{x}, \mathbf{g}(G)) = 0, \tag{4.1}$$

then the rooted map sequences $\mathbf{r}(G)$, $G \in \mathcal{H}$ satisfy the equation

$$F_{\mathcal{H}}\left(\mathbf{x}, \frac{|\text{Aut}_{\frac{1}{2}}G|}{2\varepsilon(G)}\mathbf{r}(G)\right) = 0,$$

and vice via, if the rooted map sequences $\mathbf{r}(G)$, $G \in \mathcal{H}$ satisfy the equation

$$F_{\mathcal{H}}(\mathbf{x}, \mathbf{r}(G)) = 0, \tag{4.2}$$

then the embedding sequences $\mathfrak{g}(G)$, $G \in \mathcal{H}$ satisfy the equation

$$F_{\mathcal{H}}(\mathbf{x}, \frac{2\varepsilon(G)}{|\text{Aut}_{\frac{1}{2}}G|} \mathfrak{g}(G)) = 0.$$

Furthermore, assume the function $F(\mathbf{x}, \mathbf{y})$ is y -linear and $\frac{2\varepsilon(G)}{|\text{Aut}_{\frac{1}{2}}G|}$, $G \in \mathcal{H}$ is a constant. If the embedding sequences $\mathfrak{g}(G)$, $G \in \mathcal{H}$ satisfy equation (4.1), then

$$F_{\mathcal{H}}^{\circ}(\mathbf{x}, \mathfrak{r}(G)) = 0,$$

where $F_{\mathcal{H}}^{\circ}(\mathbf{x}, \mathbf{y}) = F(\mathbf{x}, \mathbf{y}) + (\frac{2\varepsilon(G)}{|\text{Aut}_{\frac{1}{2}}G|} - 1)F(\mathbf{x}, \mathbf{0})$ and vice via, if the rooted map sequences $\mathfrak{g}(G)$, $G \in \mathcal{H}$ satisfy equation (4.2), then

$$F_{\mathcal{H}}^{\star}(\mathbf{x}, \mathfrak{g}(G)) = 0.$$

where $F_{\mathcal{H}}^{\star} = F(\mathbf{x}, \mathbf{y}) + (\frac{|\text{Aut}_{\frac{1}{2}}G|}{2\varepsilon(G)} - 1)F(\mathbf{x}, \mathbf{0})$.

Proof According to the Corollary 8.2.1, for any integer $s \geq 0$ and $G \in \mathcal{H}$, we know that

$$r_s(G) = \frac{2\varepsilon(G)}{|\text{Aut}_{\frac{1}{2}}G|} g_s(G)$$

and

$$g_s(G) = \frac{|\text{Aut}_{\frac{1}{2}}G|}{2\varepsilon(G)} r_s(G).$$

Therefore, if the embedding sequences $\mathfrak{g}(G)$, $G \in \mathcal{H}$ satisfy equation (4.1), then

$$F_{\mathcal{H}}(\mathbf{x}, \frac{|\text{Aut}_{\frac{1}{2}}G|}{2\varepsilon(G)} \mathfrak{r}(G)) = 0,$$

and vice via, if the rooted map sequences $\mathfrak{r}(G)$, $G \in \mathcal{H}$ satisfy equation (4.2), then

$$F_{\mathcal{H}}(\mathbf{x}, \frac{2\varepsilon(G)}{|\text{Aut}_{\frac{1}{2}}G|} \mathfrak{g}(G)) = 0.$$

Now assume that $F_{\mathcal{H}}(\mathbf{x}, \mathbf{y})$ is a y -linear function with a form

$$F_{\mathcal{H}}(\mathbf{x}, \mathbf{y}) = f(x_1, x_2, \dots) + h(x_1, x_2, \dots) \sum_{i \in I} y_i + l(x_1, x_2, \dots) \sum_{\Lambda \in \mathcal{O}} \Lambda(\mathbf{y}),$$

where \mathcal{O} is a set of linear operators. If $F_{\mathcal{H}}(\mathbf{x}, \mathfrak{g}(G)) = 0$, that is

$$f(x_1, x_2, \dots) + h(x_1, x_2, \dots) \sum_{i \in I, G \in \mathcal{H}} g_i(G) + l(x_1, x_2, \dots) \sum_{\Lambda \in \mathcal{O}, G \in \mathcal{H}} \Lambda(\mathfrak{g}(G)) = 0,$$

we get that

$$\begin{aligned} f(x_1, x_2, \dots) &+ h(x_1, x_2, \dots) \sum_{i \in I, G \in \mathcal{H}} \frac{|\text{Aut}_{\frac{1}{2}} G|}{2\varepsilon(G)} r_i(G) \\ &+ l(x_1, x_2, \dots) \sum_{\Lambda \in \mathcal{O}, G \in \mathcal{H}} \Lambda \left(\frac{|\text{Aut}_{\frac{1}{2}} G|}{2\varepsilon(G)} \mathfrak{r}(G) \right) = 0. \end{aligned}$$

Since $\Lambda \in \mathcal{O}$ is a linear operator and $\frac{2\varepsilon(G)}{|\text{Aut}_{\frac{1}{2}} G|}$, $G \in \mathcal{H}$ is a constant, we also have

$$\begin{aligned} f(x_1, x_2, \dots) &+ \frac{|\text{Aut}_{\frac{1}{2}} G|}{2\varepsilon(G)} h(x_1, x_2, \dots) \sum_{i \in I, G \in \mathcal{H}} r_i(G) \\ &+ \frac{|\text{Aut}_{\frac{1}{2}} G|}{2\varepsilon(G)} l(x_1, x_2, \dots) \sum_{\Lambda \in \mathcal{O}, G \in \mathcal{H}} \Lambda(\mathfrak{r}(G)) = 0, \end{aligned}$$

that is,

$$\frac{2\varepsilon(G)}{|\text{Aut}_{\frac{1}{2}} G|} f(x_1, x_2, \dots) + h(x_1, x_2, \dots) \sum_{i \in I, G \in \mathcal{H}} r_i(G) + l(x_1, x_2, \dots) \sum_{\Lambda \in \mathcal{O}, G \in \mathcal{H}} \Lambda(\mathfrak{r}(G)) = 0.$$

Consequently, we get that

$$F_{\mathcal{H}}^{\diamond}(\mathbf{x}, \mathfrak{r}(G)) = 0.$$

Similarly, if

$$F_{\mathcal{H}}(\mathbf{x}, \mathfrak{r}(G)) = 0,$$

we can also get that

$$F_{\mathcal{H}}^{\star}(\mathbf{x}, \mathfrak{g}(G)) = 0.$$

This completes the proof. □

Corollary 8.2.2 *Let \mathcal{G} be a graph family and $\mathcal{H} \subseteq \mathcal{G}$. If the embedding sequences $\mathfrak{g}(G)$ of graph $G \in \mathcal{G}$ satisfy a recursive relation*

$$\sum_{i \in J, G \in \mathcal{H}} a(i, G) \mathfrak{g}_i(G) = 0,$$

where J is the set of index, then the rooted map sequences $\mathfrak{r}(G)$ satisfy a recursive relation

$$\sum_{i \in J, G \in \mathcal{H}} \frac{a(i, G) |\text{Aut}_{\frac{1}{2}} G|}{2\varepsilon(G)} r_i(G) = 0,$$

and vice via.

A typical example of Corollary 8.2.2 is the graph family bouquets B_n , $n \geq 1$. Notice that the following recursive relation for the number $g_m(n)$ of embeddings of a bouquet B_n on an orientable surface with genus m for $n \geq 2$ was found in [GrF2].

$$\begin{aligned}(n+1)g_m(n) &= 4(2n-1)(2n-3)(n-1)^2(n-2)g_{m-1}(n-2) \\ &+ 4(2n-1)(n-1)g_m(n-1)\end{aligned}$$

with boundary conditions

$$\begin{aligned}g_m(n) &= 0 \text{ if } m \leq 0 \text{ or } n \leq 0; \\ g_0(0) &= g_0(1) = 1 \text{ and } g_m(0) = g_m(1) = 0 \text{ for } m \geq 0; \\ g_0(2) &= 4, g_1(2) = 2, g_m(2) = 0 \text{ for } m \geq 1.\end{aligned}$$

Since $|\text{Aut}_{\frac{1}{2}} B_n| = 2^n n!$, we get a recursive relation for the number $r_m(n)$ of rooted maps on an orientable surface of genus m underlying graph B_n by Corollary 8.2.2 following.

$$\begin{aligned}(n^2-1)(n-2)r_m(n) &= (2n-1)(2n-3)(n-1)^2(n-2)r_{m-1}(n-2) \\ &+ 2(2n-1)(n-1)(n-2)r_m(n-1)\end{aligned}$$

with the boundary conditions $r_m(n) = 0$ if $m \leq 0$ or $n \leq 0$;

$$\begin{aligned}r_0(0) &= r_0(1) = 1 \text{ and } r_m(0) = r_m(1) = 0 \text{ for } m \geq 0; \\ r_0(2) &= 2, r_1(2) = 1, g_m(2) = 0 \text{ for } m \geq 1.\end{aligned}$$

Corollary 8.2.3 *Let \mathcal{G} be a graph family and $\mathcal{H} \subseteq \mathcal{G}$. If the embedding sequences $g(G)$, $G \in \mathcal{G}$ satisfy an operator equation*

$$\sum_{\Lambda \in \mathcal{O}, G \in \mathcal{H}} \Lambda(g(G)) = 0,$$

where \mathcal{O} denotes a set of linear operators, then the rooted map sequences $r(G)$, $G \in \mathcal{H}$ satisfy an operator equation

$$\sum_{\Lambda \in \mathcal{O}, G \in \mathcal{H}} \Lambda\left(\frac{|\text{Aut}_{\frac{1}{2}} G|}{2\varepsilon(G)} r(G)\right) = 0$$

and vice via.

Let $\theta = (\theta_1, \theta_2, \dots, \theta_k) \vdash 2n$, i.e., $\sum_{j=1}^k \theta_j = 2n$ with positive integers θ_j . Kwak and Shim introduced three linear operators Γ, Θ and Δ to find the total genus polynomial of bouquets B_n , $n \geq 1$ in [KwS1] defined as follows.

Denotes by z_θ and $z_\theta^{-1} = 1/z_\theta$ the multivariate monomials $\prod_{i=1}^k z_{\theta_i}$ and $1/\prod_{i=1}^k z_{\theta_i}$, where $\theta = (\theta_1, \theta_2, \dots, \theta_k) \vdash 2n$. Then the linear operators Γ, Θ and Δ are defined respectively by

$$\Gamma(z_\theta^{\pm 1}) = \sum_{j=1}^k \sum_{l=0}^{\theta_j} \theta_j! \left(\frac{z_{1+l} z_{\theta_{j+1-l}}}{z_{\theta_j}} \right) z_\theta^{\pm 1},$$

$$\Theta(z_\theta^{\pm 1}) = \sum_{j=1}^k (\theta_j^2 + \theta_j) \left(\frac{z_{\theta_j+2} z_\theta}{z_{\theta_j}} \right)^{-1}$$

and

$$\Delta(z_\theta^{\pm 1}) = \sum_{1 \leq i < j \leq k} 2\theta_i \theta_j \left[\left\{ \left(\frac{z_{\theta_j+\theta_i+2}}{z_{\theta_j} z_{\theta_i}} \right) z_\theta \right\}^{\pm 1} + \left\{ \left(\frac{z_{\theta_j+\theta_i+2}}{z_{\theta_j} z_{\theta_i}} \right) z_\theta \right\}^{-1} \right].$$

Denote by $\hat{i}[B_n](z_j)$ the sum of all monomial z_θ or $1/z_\theta$ taken over all embeddings of B_n into an orientable or non-orientable surface, that is

$$\hat{i}[B_n](z_j) = \sum_{\theta \vdash 2n} i_\theta(B_n) z_\theta + \sum_{\theta \vdash 2n} \tilde{i}_\theta(B_n) z_\theta^{-1},$$

where, $i_\theta(B_n)$ and $\tilde{i}_\theta(B_n)$ denote the number of embeddings of B_n into orientable and non-orientable surface of region type θ . They found that

$$\hat{i}[B_{n+1}](z_j) = (\Gamma + \Theta + \Delta) \hat{i}[B_n](z_j) = (\Gamma + \Theta + \Delta)^n \left(\frac{1}{z_2} + z_1^2 \right).$$

and

$$\mathcal{G}[B_{n+1}](x) = (\Gamma + \Theta + \Delta)^n \left(\frac{1}{z_2} + z_1^2 \right) \Big|_{z_j=x \text{ for } j \geq 1 \text{ and } (C^*)},$$

where, (C^*) denotes the condition

(C^*) : replacing the power $1 + n - 2i$ of x by i if $i \geq 0$ and $-(1 + n + i)$ by $-i$ if $i \leq 0$.

Notice that

$$\frac{|\text{Aut}_{\frac{1}{2}} B_n|}{2\varepsilon(B_n)} = \frac{2^n n!}{2n} = 2^{n-1} (n-1)!$$

and Γ, Θ, Δ are linear. By Corollary 8.2.3 we know that

$$\begin{aligned} R[B_{n+1}](x) &= \frac{(\Gamma + \Theta + \Delta) \hat{i}[B_n](z_j)}{2^n n!} \Big|_{z_j=x \text{ for } j \geq 1 \text{ and } (C^*)} \\ &= \frac{(\Gamma + \Theta + \Delta)^n \left(\frac{1}{z_2} + z_1^2 \right)}{\prod_{k=1}^n 2^k k!} \Big|_{z_j=x \text{ for } j \geq 1 \text{ and } (C^*)}. \end{aligned}$$

Calculation shows that

$$\begin{aligned} R[B_1](x) &= x + \frac{1}{x}; \\ R[B_2](x) &= 2 + x + \frac{5}{x} + \frac{4}{x^2}; \\ R[B_3](x) &= \frac{41}{x^3} + \frac{42}{x^2} + \frac{22}{x} + 5 + 10x \end{aligned}$$

and

$$R[B_4](x) = \frac{488}{x^4} + \frac{690}{x^3} + \frac{304}{x^2} + \frac{93}{x} + 14 + 70x + 21x^2.$$

§8.3 A SCHEME FOR ENUMERATING MAPS UNDERLYING A GRAPH

For a given graph G , denoted by $\mathcal{E}^O(G)$, $\mathcal{E}^N(G)$ and $\mathcal{E}^L(G)$ the sets of embeddings of G on orientable surfaces, non-orientable surfaces and on locally orientable surfaces, respectively. For determining the number of non-equivalent embeddings of a graph on surfaces and maps underlying a graph, another form of the Theorem 5.3.3 by group action is needed, which is restated as follows.

Theorem 8.3.1 *Let $M_1 = (\mathcal{X}_{\alpha,\beta}, \mathcal{P}_1)$ and $M_2 = (\mathcal{X}_{\alpha,\beta}, \mathcal{P}_2)$ be two maps underlying graph G , then*

- (1) M_1, M_2 are equivalent if and only if M_1, M_2 are in one orbit of $\text{Aut}_{\frac{1}{2}}G$ action on $X_{\frac{1}{2}}(G)$;
- (2) M_1, M_2 are isomorphic if and only if M_1, M_2 are in one orbit of $\text{Aut}_{\frac{1}{2}}G \times \langle \alpha \rangle$ action on $\mathcal{X}_{\alpha,\beta}$.

Now we can established a scheme for enumerating the number of non-isomorphic maps and non-equivalent embeddings of a graph on surfaces by applying the well-known *Burnside Lemma*, i.e., Theorem 2.1.3 in the following.

Theorem 8.3.2 *For a graph G , let $\mathcal{E} \subset \mathcal{E}^L(G)$, then the numbers $n(\mathcal{E}, G)$ and $\eta(\mathcal{E}, G)$ of non-isomorphic maps and non-equivalent embeddings in \mathcal{E} are respective*

$$\begin{aligned} n(\mathcal{E}, G) &= \frac{1}{2|\text{Aut}_{\frac{1}{2}}G|} \sum_{g \in \text{Aut}_{\frac{1}{2}}G} |\Phi_1(g)|, \\ \eta(\mathcal{E}, G) &= \frac{1}{|\text{Aut}_{\frac{1}{2}}G|} \sum_{g \in \text{Aut}_{\frac{1}{2}}G} |\Phi_2(g)|, \end{aligned}$$

where, $\Phi_1(g) = \{\mathcal{P} | \mathcal{P} \in \mathcal{E} \text{ and } \mathcal{P}^g = \mathcal{P} \text{ or } \mathcal{P}^{g\alpha} = \mathcal{P}\}$, $\Phi_2(g) = \{\mathcal{P} | \mathcal{P} \in \mathcal{E} \text{ and } \mathcal{P}^g = \mathcal{P}\}$.

Proof Define the group $\mathcal{H} = \text{Aut}_{\frac{1}{2}}G \times \langle \alpha \rangle$. Then by the Burnside Lemma and the Theorem 8.3.1, we get that

$$n(\mathcal{E}, G) = \frac{1}{|\mathcal{H}|} \sum_{g \in \mathcal{H}} |\Phi_1(g)|,$$

where, $\Phi_1(g) = \{\mathcal{P} | \mathcal{P} \in \mathcal{E} \text{ and } \mathcal{P}^g = \mathcal{P}\}$. Now $|\mathcal{H}| = 2|\text{Aut}_{\frac{1}{2}}G|$. Notice that if $\mathcal{P}^g = \mathcal{P}$, then $\mathcal{P}^{g\alpha} \neq \mathcal{P}$, and if $\mathcal{P}^{g\alpha} = \mathcal{P}$, then $\mathcal{P}^g \neq \mathcal{P}$. Whence, $\Phi_1(g) \cap \Phi_1(g\alpha) = \emptyset$. We have that

$$n(\mathcal{E}, G) = \frac{1}{2|\text{Aut}_{\frac{1}{2}}G|} \sum_{g \in \text{Aut}_{\frac{1}{2}}G} |\Phi_1(g)|,$$

where $\Phi_1(g) = \{\mathcal{P} | \mathcal{P} \in \mathcal{E} \text{ and } \mathcal{P}^g = \mathcal{P} \text{ or } \mathcal{P}^{g\alpha} = \mathcal{P}\}$.

Similarly,

$$\eta(\mathcal{E}, G) = \frac{1}{|\text{Aut}_{\frac{1}{2}}G|} \sum_{g \in \text{Aut}_{\frac{1}{2}}G} |\Phi_2(g)|,$$

where, $\Phi_2(g) = \{\mathcal{P} | \mathcal{P} \in \mathcal{E} \text{ and } \mathcal{P}^g = \mathcal{P}\}$. □

From Theorem 8.3.2, we get results following.

Corollary 8.3.1 *The numbers $n^O(G)$, $n^N(G)$ and $n^L(G)$ of non-isomorphic orientable maps, non-orientable maps and locally orientable maps underlying a graph G are respectively*

$$n^O(G) = \frac{1}{2|\text{Aut}_{\frac{1}{2}}G|} \sum_{g \in \text{Aut}_{\frac{1}{2}}G} |\Phi_1^O(g)|; \tag{8.3.1}$$

$$n^N(G) = \frac{1}{2|\text{Aut}_{\frac{1}{2}}G|} \sum_{g \in \text{Aut}_{\frac{1}{2}}G} |\Phi_1^N(g)|; \tag{8.3.2}$$

$$n^L(G) = \frac{1}{2|\text{Aut}_{\frac{1}{2}}G|} \sum_{g \in \text{Aut}_{\frac{1}{2}}G} |\Phi_1^L(g)|, \tag{8.3.3}$$

where, $\Phi_1^O(g) = \{\mathcal{P} | \mathcal{P} \in \mathcal{E}^O(G) \text{ and } \mathcal{P}^g = \mathcal{P} \text{ or } \mathcal{P}^{g\alpha} = \mathcal{P}\}$, $\Phi_1^N(g) = \{\mathcal{P} | \mathcal{P} \in \mathcal{E}^N(G) \text{ and } \mathcal{P}^g = \mathcal{P} \text{ or } \mathcal{P}^{g\alpha} = \mathcal{P}\}$, $\Phi_1^L(g) = \{\mathcal{P} | \mathcal{P} \in \mathcal{E}^L(G) \text{ and } \mathcal{P}^g = \mathcal{P} \text{ or } \mathcal{P}^{g\alpha} = \mathcal{P}\}$.

Corollary 8.3.2 *The numbers $\eta^O(G)$, $\eta^N(G)$ and $\eta^L(G)$ of non-equivalent embeddings of graph G on orientable, non-orientable and locally orientable surfaces are respectively*

$$\eta^O(G) = \frac{1}{|\text{Aut}_{\frac{1}{2}}G|} \sum_{g \in \text{Aut}_{\frac{1}{2}}G} |\Phi_2^O(g)|; \quad (8.3.4)$$

$$\eta^N(G) = \frac{1}{|\text{Aut}_{\frac{1}{2}}G|} \sum_{g \in \text{Aut}_{\frac{1}{2}}G} |\Phi_2^N(g)|; \quad (8.3.5)$$

$$\eta^L(G) = \frac{1}{|\text{Aut}_{\frac{1}{2}}G|} \sum_{g \in \text{Aut}_{\frac{1}{2}}G} |\Phi_2^L(g)|, \quad (8.3.6)$$

where, $\Phi_2^O(g) = \{\mathcal{P} | \mathcal{P} \in \mathcal{E}^O(G) \text{ and } \mathcal{P}^g = \mathcal{P}\}$, $\Phi_2^N(g) = \{\mathcal{P} | \mathcal{P} \in \mathcal{E}^N(G) \text{ and } \mathcal{P}^g = \mathcal{P}\}$, $\Phi_2^L(g) = \{\mathcal{P} | \mathcal{P} \in \mathcal{E}^L(G) \text{ and } \mathcal{P}^g = \mathcal{P}\}$.

For a simple graph G , since $\text{Aut}_{\frac{1}{2}}G = \text{Aut}G$ by Theorem 3.4.1, the formula (8.3.4) is just the scheme used for counting the non-equivalent embeddings of a complete graph, a complete bipartite graph in references [MRW1], [Mul1]. For an *asymmetric graph* G , that is, $\text{Aut}_{\frac{1}{2}}G = \text{id}_{X_{\frac{1}{2}}(G)}$, we get the numbers of non-isomorphic maps and non-equivalent embeddings underlying graph G by the Corollaries 8.3.1 and 8.3.2 following.

Theorem 8.3.3 *The numbers $n^O(G)$, $n^N(G)$ and $n^L(G)$ of non-isomorphic maps on orientable, non-orientable surfaces or locally orientable surfaces underlying an asymmetric graph G are respectively*

$$n^O(G) = \frac{\prod_{v \in V(G)} (\rho(v) - 1)!}{2},$$

$$n^L(G) = 2^{\beta(G)-1} \prod_{v \in V(G)} (\rho(v) - 1)!$$

and

$$n^N(G) = (2^{\beta(G)-1} - \frac{1}{2}) \prod_{v \in V(G)} (\rho(v) - 1)!,$$

where, $\beta(G)$ is the Betti number of graph G .

The numbers $\eta^O(G)$, $\eta^N(G)$ and $\eta^L(G)$ of non-equivalent embeddings underlying an asymmetric graph G are respectively

$$\eta^O(G) = \prod_{v \in V(G)} (\rho(v) - 1)!,$$

$$\eta^L(G) = 2^{\beta(G)} \prod_{v \in V(G)} (\rho(v) - 1)!$$

and

$$\eta^N(G) = (2^{\beta(G)} - 1) \prod_{v \in V(G)} (\rho(v) - 1)!$$

All these formulae are useful for enumerating non-isomorphic maps underlying a complete graph, semi-regular graph or a bouquet on surfaces in sections following.

§8.4 THE ENUMERATION OF COMPLETE MAPS ON SURFACES

We first consider a permutation with its stabilizer. A permutation with the following form $(x_1, x_2, \dots, x_n)(\alpha x_n, \alpha x_2, \dots, \alpha x_1)$ is called a *permutation pair*. The following result is obvious.

Lemma 8.4.1 *Let g be a permutation on set $\Omega = \{x_1, x_2, \dots, x_n\}$ such that $g\alpha = \alpha g$. If*

$$g(x_1, x_2, \dots, x_n)(\alpha x_n, \alpha x_{n-1}, \dots, \alpha x_1)g^{-1} = (x_1, x_2, \dots, x_n)(\alpha x_n, \alpha x_{n-1}, \dots, \alpha x_1),$$

then

$$g = (x_1, x_2, \dots, x_n)^k$$

and if

$$g\alpha(x_1, x_2, \dots, x_n)(\alpha x_n, \alpha x_{n-1}, \dots, \alpha x_1)(g\alpha)^{-1} = (x_1, x_2, \dots, x_n)(\alpha x_n, \alpha x_{n-1}, \dots, \alpha x_1),$$

then

$$g\alpha = (\alpha x_n, \alpha x_{n-1}, \dots, \alpha x_1)^k$$

for some integer $k, 1 \leq k \leq n$.

Lemma 8.4.2 *For each permutation $g, g \in \mathcal{E}_{[k^{\frac{n}{k}}]}$ satisfying $g\alpha = \alpha g$ on set $\Omega = \{x_1, x_2, \dots, x_n\}$, the number of stable permutation pairs in Ω under the action of g or $g\alpha$ is*

$$\frac{2\phi(k)(n-1)!}{|\mathcal{E}_{[k^{\frac{n}{k}}]}|},$$

where $\phi(k)$ denotes the Euler function.

Proof Denote the number of stable pair permutations under the action of g or $g\alpha$ by $n(g)$ and C the set of pair permutations. Define the set $A = \{(g, C) | g \in \mathcal{E}_{[k^{\frac{n}{k}}]}, C \in$

C and $C^g = C$ or $C^{g\alpha} = C$. Clearly, for $\forall g_1, g_2 \in \mathcal{E}_{[k \frac{n}{k}]}$, we have $n(g_1) = n(g_2)$. Whence, we get that

$$|A| = |\mathcal{E}_{[k \frac{n}{k}]}|n(g). \tag{8.4.1}$$

On the other hand, by the Lemma 8.4.1, for any permutation pair $C = (x_1, x_2, \dots, x_n)$ $(\alpha x_n, \alpha x_{n-1}, \dots, \alpha x_1)$, since C is stable under the action of g , there must be $g = (x_1, x_2, \dots, x_n)^l$ or $g\alpha = (\alpha x_n, \alpha x_{n-1}, \dots, \alpha x_1)^l$, where $l = s \frac{n}{k}$, $1 \leq s \leq k$ and $(s, k) = 1$. Therefore, there are $2\phi(k)$ permutations in $\mathcal{E}_{[k \frac{n}{k}]}$ acting on it stable. Whence, we also have

$$|A| = 2\phi(k)|C|. \tag{8.4.2}$$

Combining (8.4.1) with (4.2), we get that

$$n(g) = \frac{2\phi(k)|C|}{|\mathcal{E}_{[k \frac{n}{k}]}|} = \frac{2\phi(k)(n-1)!}{|\mathcal{E}_{[k \frac{n}{k}]}|}. \quad \square$$

Now we can enumerate the unrooted complete maps on surfaces.

Theorem 8.4.1 *The number $n^L(K_n)$ of complete maps of order $n \geq 5$ on surfaces is*

$$n^L(K_n) = \frac{1}{2} \left(\sum_{k|n} + \sum_{k|n, k \equiv 0(mod 2)} \right) \frac{2^{\alpha(n,k)}(n-2)!^{\frac{n}{k}}}{k^{\frac{n}{k}}(\frac{n}{k})!} + \sum_{k|(n-1), k \neq 1} \frac{\phi(k)2^{\beta(n,k)}(n-2)!^{\frac{n-1}{k}}}{n-1},$$

where,

$$\alpha(n, k) = \begin{cases} \frac{n(n-3)}{2k}, & \text{if } k \equiv 1(mod 2); \\ \frac{n(n-2)}{2k}, & \text{if } k \equiv 0(mod 2), \end{cases}$$

and

$$\beta(n, k) = \begin{cases} \frac{(n-1)(n-2)}{2k}, & \text{if } k \equiv 1(mod 2); \\ \frac{(n-1)(n-3)}{2k}, & \text{if } k \equiv 0(mod 2). \end{cases}$$

and $n^L(K_4) = 11$.

Proof According to formula (8.3.3) in Corollary 8.3.1 and Theorem 7.2.1 for $n \geq 5$, we know that

$$\begin{aligned} n^L(K_n) &= \frac{1}{2|\text{Aut}K_n|} \times \left(\sum_{g_1 \in \mathcal{E}_{[k \frac{n}{k}]}} |\Phi(g_1)| + \sum_{g_2 \in \mathcal{E}_{[(2s) \frac{n}{2s}]}} |\Phi(g_2\alpha)| + \sum_{h \in \mathcal{E}_{[1, k \frac{n-1}{k}]}} |\Phi(h)| \right) \\ &= \frac{1}{2n!} \times \left(\sum_{k|n} |\mathcal{E}_{[k \frac{n}{k}]}| |\Phi(g_1)| + \sum_{l|n, l \equiv 0(mod 2)} |\mathcal{E}_{[l \frac{n}{l}]}| |\Phi(g_2\alpha)| + \sum_{l|(n-1)} |\mathcal{E}_{[1, l \frac{n-1}{l}]}| |\Phi(h)| \right), \end{aligned}$$

where, $g_1 \in \mathcal{E}_{[k \frac{n}{k}]}$, $g_2 \in \mathcal{E}_{[l \frac{n}{l}]}$ and $h \in \mathcal{E}_{[1, k \frac{n-1}{k}]}$ are three chosen elements.

Without loss of generality, we assume that an element $g, g \in \mathcal{E}_{[k \frac{n}{k}]}$ has the following cycle decomposition.

$$g = (1, 2, \dots, k)(k + 1, k + 2, \dots, 2k) \cdots \left(\left(\frac{n}{k} - 1 \right) k + 1, \left(\frac{n}{k} - 1 \right) k + 2, \dots, n \right)$$

and

$$\mathcal{P} = \prod_1 \times \prod_2,$$

where

$$\prod_1 = (1^{i_{21}}, 1^{i_{31}}, \dots, 1^{i_{n1}})(2^{i_{12}}, 2^{i_{32}}, \dots, 2^{i_{n2}}) \cdots (n^{i_{1n}}, n^{i_{2n}}, \dots, n^{i_{(n-1)n}}),$$

and

$$\prod_2 = \alpha \left(\prod_1^{-1} \right) \alpha^{-1},$$

being a complete map which is stable under the action of g , where $s_{ij} \in \{k+, k - |k = 1, 2, \dots, n\}$.

Notice that the quadricells adjacent to the vertex 1 can make $2^{n-2}(n - 2)!$ different pair permutations and for each chosen pair permutation, the pair permutations adjacent to the vertices $2, 3, \dots, k$ are uniquely determined since \mathcal{P} is stable under the action of g .

Similarly, for each pair permutation adjacent to the vertex $k + 1, 2k + 1, \dots, \left(\frac{n}{k} - 1 \right) k + 1$, the pair permutations adjacent to $k + 2, k + 3, \dots, 2k$, and $2k + 2, 2k + 3, \dots, 3k, \dots$, and $\left(\frac{n}{k} - 1 \right) k + 2, \left(\frac{n}{k} - 1 \right) k + 3, \dots, n$ are also uniquely determined because \mathcal{P} is stable under the action of g .

Now for an orientable embedding M_1 of K_n , all the induced embeddings by exchanging two sides of some edges and retaining the others unchanged in M_1 are the same as M_1 by the definition of maps. Whence, the number of different stable embeddings under the action of g gotten by exchanging x and αx in M_1 for $x \in U, U \subset \mathcal{X}_\beta$, where $\mathcal{X}_\beta = \bigcup_{x \in E(K_n)} \{x, \beta x\}$, is $2^{g(\varepsilon) - \frac{n}{k}}$, where $g(\varepsilon)$ is the number of orbits of $E(K_n)$ under the action of g and we subtract $\frac{n}{k}$ because we can chosen $1^{2+}, k + 1^{1+}, 2k + 1^{1+}, \dots, n - k + 1^{1+}$ first in our enumeration.

Notice that the length of each orbit under the action of g is k for $\forall x \in E(K_n)$ if k is odd and is $\frac{k}{2}$ for $x = i^{1+\frac{k}{2}}, i = 1, k + 1, \dots, n - k + 1$, or k for all other edges if k is even. Therefore, we get that

$$g(\varepsilon) = \begin{cases} \frac{\varepsilon(K_n)}{k}, & \text{if } k \equiv 1(\text{mod}2); \\ \frac{\varepsilon(K_n) - \frac{n}{2}}{k}, & \text{if } k \equiv 0(\text{mod}2). \end{cases}$$

Whence, we have that

$$\alpha(n, k) = g(\varepsilon) - \frac{n}{k} = \begin{cases} \frac{n(n-3)}{2k}, & \text{if } k \equiv 1(\text{mod}2); \\ \frac{n(n-2)}{2k}, & \text{if } k \equiv 0(\text{mod}2), \end{cases}$$

and

$$|\Phi(g)| = 2^{\alpha(n,k)}(n-2)!^{\frac{n}{k}}, \quad (8.4.3)$$

Similarly, if $k \equiv 0(\text{mod}2)$, we get also that

$$|\Phi(g\alpha)| = 2^{\alpha(n,k)}(n-2)!^{\frac{n}{k}} \quad (8.4.4)$$

for an chosen element $g, g \in \mathcal{E}_{[k\frac{n}{k}]}$.

Now for $\forall h \in \mathcal{E}_{[1, k\frac{n-1}{k}]}$, without loss of generality, we assume that $h = (1, 2, \dots, k)(k+1, k+2, \dots, 2k) \dots \left(\left(\frac{n-1}{k} - 1 \right)k + 1, \left(\frac{n-1}{k} - 1 \right)k + 2, \dots, (n-1) \right)(n)$. Then the above statement is also true for the complete graph K_{n-1} with the vertices $1, 2, \dots, n-1$. Notice that the quadricells $n^{1+}, n^{2+}, \dots, n^{n-1+}$ can be chosen first in our enumeration and they are not belong to the graph K_{n-1} . According to the Lemma 8.4.2, we get that

$$|\Phi(h)| = 2^{\beta(n,k)}(n-2)!^{\frac{n-1}{k}} \times \frac{2\phi(k)(n-2)!}{|\mathcal{E}_{[1, k\frac{n-1}{k}]}|}, \quad (8.4.5)$$

Where

$$\beta(n, k) = h(\varepsilon) = \begin{cases} \frac{\varepsilon(K_{n-1})}{k} - \frac{n-1}{k} = \frac{(n-1)(n-4)}{2k}, & \text{if } k \equiv 1(\text{mod}2); \\ \frac{\varepsilon(K_{n-1})}{k} - \frac{n-1}{k} = \frac{(n-1)(n-3)}{2k}, & \text{if } k \equiv 0(\text{mod}2). \end{cases}$$

Combining (8.4.3) – (8.4.5), we get that

$$\begin{aligned} n^L(K_n) &= \frac{1}{2n!} \times \left(\sum_{k|n} |\mathcal{E}_{[k\frac{n}{k}]}| |\Phi(g_0)| + \sum_{l|n, l \equiv 0(\text{mod}2)} |\mathcal{E}_{[l\frac{n}{l}]}| |\Phi(g_1\alpha)| \right) \\ &\quad + \sum_{l|(n-1)} |\mathcal{E}_{[1, l\frac{n-1}{l}]}| |\Phi(h)| \end{aligned}$$

$$\begin{aligned}
 &= \frac{1}{2n!} \times \left(\sum_{k|n} \frac{n! 2^{\alpha(n,k)} (n-2)!^{\frac{n}{k}}}{k^{\frac{n}{k}} \left(\frac{n}{k}\right)!} + \sum_{k|n, k \equiv 0 \pmod{2}} \frac{n! 2^{\alpha(n,k)} (n-2)!^{\frac{n}{k}}}{k^{\frac{n}{k}} \left(\frac{n}{k}\right)!} \right) \\
 &\quad + \sum_{k|(n-1), k \neq 1} \frac{n!}{k^{\frac{n-1}{k}} \left(\frac{n-1}{k}\right)!} \times \frac{2\phi(k)(n-2)! 2^{\beta(n,k)} (n-2)!^{\frac{n-1}{k}}}{\frac{(n-1)!}{k^{\frac{n-1}{k}} \left(\frac{n-1}{k}\right)!}} \\
 &= \frac{1}{2} \left(\sum_{k|n} + \sum_{k|n, k \equiv 0 \pmod{2}} \right) \frac{2^{\alpha(n,k)} (n-2)!^{\frac{n}{k}}}{k^{\frac{n}{k}} \left(\frac{n}{k}\right)!} + \sum_{k|(n-1), k \neq 1} \frac{\phi(k) 2^{\beta(n,k)} (n-2)!^{\frac{n-1}{k}}}{n-1}.
 \end{aligned}$$

For $n = 4$, similar calculation shows that $n^L(K_4) = 11$ by consider the fixing set of permutations in $\mathcal{E}_{[s^{\frac{4}{s}}]}$, $\mathcal{E}_{[1, s^{\frac{3}{s}}]}$, $\mathcal{E}_{[(2s)^{\frac{4}{2s}}]}$, $\alpha\mathcal{E}_{[(2s)^{\frac{4}{2s}}]}$ and $\alpha\mathcal{E}_{[1, 1, 2]}$. \square

For the orientable case, we get the number $n^O(K_n)$ of orientable complete maps of order n as follows.

Theorem 8.4.2 *The number $n^O(K_n)$ of complete maps of order $n \geq 5$ on orientable surfaces is*

$$n^O(K_n) = \frac{1}{2} \left(\sum_{k|n} + \sum_{k|n, k \equiv 0 \pmod{2}} \right) \frac{(n-2)!^{\frac{n}{k}}}{k^{\frac{n}{k}} \left(\frac{n}{k}\right)!} + \sum_{k|(n-1), k \neq 1} \frac{\phi(k)(n-2)!^{\frac{n-1}{k}}}{n-1}.$$

and $n(K_4) = 3$.

Proof According to the algebraic representation of map, a map $M = (\mathcal{X}_{\alpha, \beta}, \mathcal{P})$ is orientable if and only if for $\forall x \in \mathcal{X}_{\alpha, \beta}$, x and $\alpha\beta x$ are in a same orbit of $\mathcal{X}_{\alpha, \beta}$ under the action of the group $\Psi_I = \langle \alpha\beta, \mathcal{P} \rangle$. Now applying (8.3.1) in Corollary 8.3.1 and Theorem 7.2.1, similar to the proof of Theorem 8.4.1, we get the number $n^O(K_n)$ for $n \geq 5$ to be

$$n^O(K_n) = \frac{1}{2} \left(\sum_{k|n} + \sum_{k|n, k \equiv 0 \pmod{2}} \right) \frac{(n-2)!^{\frac{n}{k}}}{k^{\frac{n}{k}} \left(\frac{n}{k}\right)!} + \sum_{k|(n-1), k \neq 1} \frac{\phi(k)(n-2)!^{\frac{n-1}{k}}}{n-1}.$$

and for the complete graph K_4 , calculation shows that $n(K_4) = 3$. \square

Notice that $n^O(K_n) + n^N(K_n) = n^L(K_n)$. Therefore, we get also the number $n^N(K_n)$ of complete maps of order n on non-orientable surfaces by Theorems 8.4.1 and 8.4.2 following.

Theorem 8.4.3 *The number $n^N(K_n)$ of complete maps of order $n, n \geq 5$ on non-orientable surfaces is*

$$\begin{aligned}
 n^N(K_n) &= \frac{1}{2} \left(\sum_{k|n} + \sum_{k|n, k \equiv 0 \pmod{2}} \right) \frac{(2^{\alpha(n,k)} - 1)(n-2)!^{\frac{n}{k}}}{k^{\frac{n}{k}} \left(\frac{n}{k}\right)!} \\
 &\quad + \sum_{k|(n-1), k \neq 1} \frac{\phi(k)(2^{\beta(n,k)} - 1)(n-2)!^{\frac{n-1}{k}}}{n-1},
 \end{aligned}$$

and $n^N(K_4) = 8$. Where, $\alpha(n, k)$ and $\beta(n, k)$ are the same as in Theorem 8.4.1.

For $n = 5$, calculation shows that $n^L(K_5) = 1080$ and $n^O(K_5) = 45$ by Theorems 8.4.1 and 8.4.2. For $n = 4$, there are 3 orientable complete maps and 8 non-orientable complete maps shown in the Fig.8.4.1.

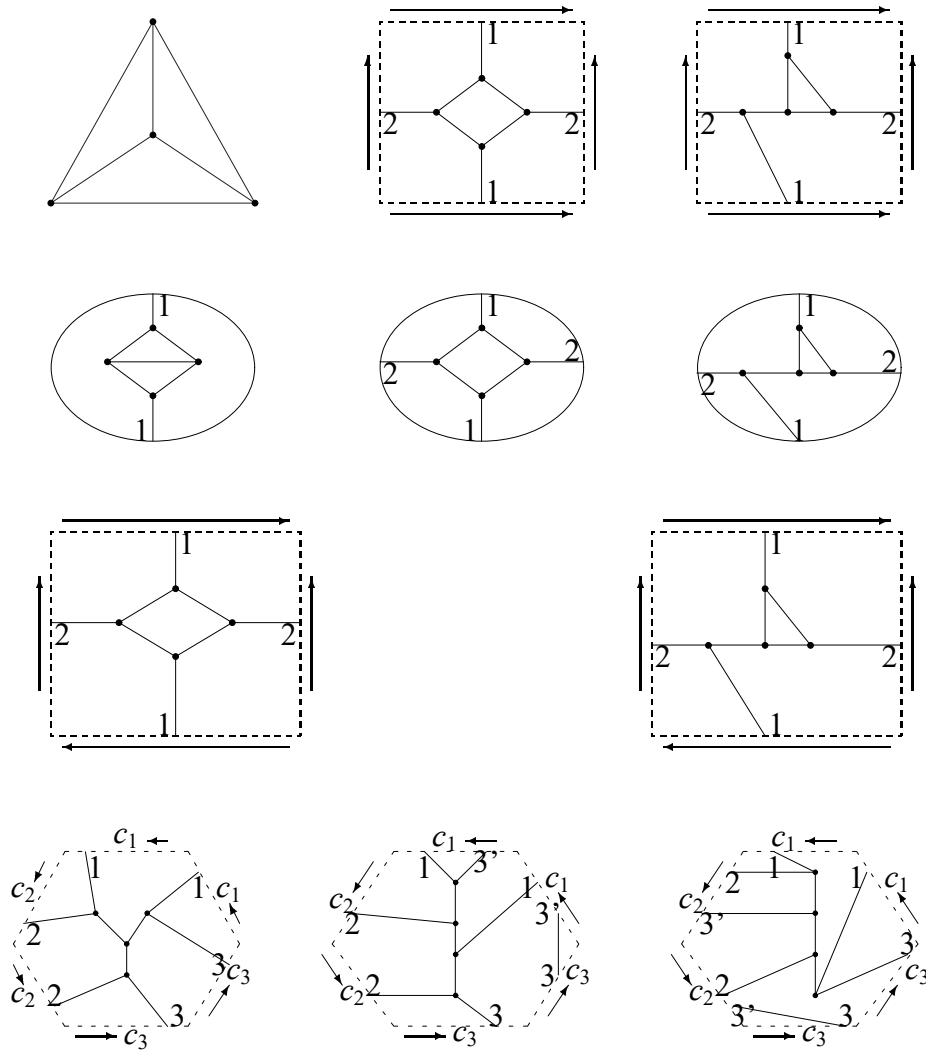

Fig.8.4.1

Now consider the action of orientation-preserving automorphisms of complete maps, determined in Theorem 7.2.1 on all orientable embeddings of a complete graph of order n . Similar to the proof of the Theorem 8.4.2, we can get the number of non-equivalent embeddings of a complete graph of order n , which has been found in [Mao1] and it is the same gotten by Mull et al. in [MRW1].

§8.5 THE ENUMERATION OF MAPS UNDERLYING A SEMI-REGULAR GRAPH

8.5.1 Crosscap Map Group. For a given map $M = (\mathcal{X}_{\alpha,\beta}, \mathcal{P})$, its *crosscap map group* is defined to be

$$\mathcal{T} := \langle \tau | \forall x \in \mathcal{X}, \tau = (x, \alpha x) \rangle,$$

where, $X = E(G)$. Consider the action of \mathcal{T} on M . For $\forall \theta \in \mathcal{T}$, we define

$$M^\theta := (\mathcal{X}_{\alpha,\beta}, \theta \mathcal{P} \theta^{-1});$$

$$M^{\mathcal{T}} := \{M^\theta | \forall \theta \in \mathcal{T}\}.$$

Then we have the following lemmas.

Lemma 8.5.1 *Let G be a connected graph. Then for $\forall M \in \mathcal{E}^{\mathcal{T}}(G)$, there exists an element $\tau, \tau \in \mathcal{T}$ and an embedding $M_0, M_0 \in \mathcal{E}^0(G)$ such that*

$$M = M_0^\tau .$$

Lemma 8.5.2 *For a connected graph G ,*

$$\mathcal{E}^{\mathcal{T}}(G) = \{M^\tau | M \in \mathcal{E}^0(G), \tau \in \mathcal{T}\}.$$

We need to classify maps in $\mathcal{E}^{\mathcal{T}}(G)$. The following lemma is fundamental for this objective.

Lemma 8.5.3 *For maps $M, M_1 \in \mathcal{E}^0(G)$, if there exist $g \in \text{Aut}G$ and $\tau \in \mathcal{T}$ such that $(M^g)^\tau = M_1$, then there must be M_1 isomorphic to M and $\tau \in \mathcal{T}_{M_1}$, and moreover, if $M_1 = M$, then $g \in \text{Aut}M$.*

Proof We only need to prove that if $M^g = M_1^\tau, g \in \text{Aut}G$ and $\tau \in \mathcal{T}$, then $\tau \in \mathcal{T}_{M_1}$. Assume that $M = (\mathcal{X}_{\alpha,\beta}, \mathcal{P})$, $M_1 = (\mathcal{X}_{\alpha,\beta}, \mathcal{P}_1)$, $\mathcal{P} = C\alpha C^{-1}, \mathcal{P}_1 = C_1\alpha C_1^{-1}$ and $\tau = \tau_S$, where $S \subset \{C_1\}$. For $\forall x \in \{C\}$, a direct calculation shows that

$$\begin{aligned} \mathcal{P}^g &= \cdots (x, g(y_1), g(y_2), \cdots, g(y_i))(ax, ag(y_i), \cdots, ag(y_1)) \cdots; \\ \mathcal{P}_1^\tau &= \cdots (\tau x, \tau z_1, \tau z_2, \cdots, \tau z_s)(\alpha \tau x, \alpha \tau z_s, \cdots, \alpha \tau z_1) \cdots, \end{aligned} \tag{8.5.1}$$

where

$$\begin{aligned} \mathcal{P} &= \cdots (x, x_1, x_2, \cdots, x_s)(y, y_1, y_2, \cdots, y_i) \cdots; \\ \mathcal{P}_1 &= \cdots (x, z_1, z_2, \cdots, z_s)(\alpha x, \alpha z_s, \cdots, \alpha z_1) \end{aligned}$$

and $g(y) = x, z_i \in v_x, i \in \{1, 2, \dots, s\}$

Since $g \in \text{Aut}G$, we know that

$$\begin{aligned} \{y, y_1, \dots, y_t\}^g &= \{x, x_1, \dots, x_s\} \\ &= \{x, z_1, \dots, z_s\} \end{aligned} \quad (8.5.2)$$

and $t = s$. Now we consider two cases.

Case 1. $x \notin S$.

In this case, we get that $\mathcal{P}_1^\tau = \dots(x, \tau z_1, \tau z_2, \dots, \tau z_s)(\alpha x, \alpha \tau z_s, \dots, \alpha \tau z_1) \dots$, from (8.5.2). Since $\mathcal{P}^g = \mathcal{P}_1^{\tau s}$, we get that $g(y_1) = \tau z_1, g(y_2) = \tau z_2, \dots, g(y_s) = \tau z_s$. According to (8.5.2), we know that $g(y_1) = z_1, g(y_2) = z_2, \dots, g(y_s) = z_s$. Therefore, $z_1 \notin S, z_2 \notin S, \dots, z_s \notin S$, that is $\{v_x\} \not\subset S$.

Case 2. $x \in S$.

In this case, we have that $\mathcal{P}_1^\tau = \dots(\alpha x, \tau z_1, \tau z_2, \dots, \tau z_s)(x, \alpha \tau z_s, \dots, \alpha \tau z_1) \dots$. Because of $\mathcal{P}^g = \mathcal{P}_1^{\tau s}$, we get that $g(y_1) = \alpha \tau z_s, g(y_2) = \alpha \tau z_{s-1}, \dots, g(y_s) = \alpha \tau z_1$. According to (8.5.2) again, we find that $g(y_1) = z_s, g(y_2) = z_{s-1}, \dots, g(y_s) = z_1$. Whence, $z_1 \in S, z_2 \in S, \dots, z_s \in S$, that is $\{v_x\} \subset S$.

Combining the discussion of Cases 1 and 2, we know that there exists a vertex subset $V_1 \subset V(G)$ such that $V_1 = S$. Whence $\tau \in \mathcal{T}_{M_1}$. Since $M^g = M_1^\tau = M_1$, we get that M_1 is isomorphic to M .

Now if $M_1 = M$, we also get that $M^g = M$. Therefore, $g \in \text{Aut}M$ \square

We get the following result by Lemmas 8.5.1 - 8.3.1.

Theorem 8.5.1 *Let G be a connected graph. Then*

(1) *For $\forall M_1^{\tau s} \in M_1^\tau, M_2^{\tau r} \in M_2^\tau$, where $M_1, M_2 \in \mathcal{E}^O(G)$, if $M_1^{\tau s}$ is isomorphic to $M_2^{\tau r}$, then M_1 is also isomorphic to M_2 .*

(2) *For a given $M \in \mathcal{E}^O(G)$, $\forall M^{\tau s}, M^{\tau r} \in M^\tau$, there exists an isomorphism g such that $g : M^{\tau s} \rightarrow M^{\tau r}$ if and only if $g \in \text{Aut}M$ and $\tau_r \in \tau_{g^{-1}(S)} \cdot \mathcal{T}_M$.*

Proof (1) Assume g is an isomorphism between $M_1^{\tau s}$ and $M_2^{\tau r}$, thus $(M_1^{\tau s})^g = M_2^{\tau r}$. Since

$$\begin{aligned} g^{-1} \tau_s g &= g^{-1} \left(\prod_{x \in S} (x, \alpha x) \right) g = \prod_{x \in S} (g^{-1} x, \alpha g^{-1} x) \\ &= \prod_{x \in g^{-1}(S)} (x, \alpha x) = \tau_{g^{-1}(S)}, \end{aligned}$$

we get that $\tau_S g = g \tau_{g^{-1}(S)}$. Whence,

$$(M_1^g)^{\tau_{g^{-1}(S)} \tau_R^{-1}} = M_2.$$

According to Lemma 8.5.3, M_1 is isomorphic to M_2 .

(2) Notice that there must be $g \in \text{Aut}G$. Since $(M^{\tau_S})^g = M^{\tau_R}$, we find that

$$(M^g)^{\tau_{g^{-1}(S)} \tau_R^{-1}} = M.$$

According to Lemma 8.5.3 again, we get that

$$g \in \text{Aut}M \text{ and } \tau_R \in \tau_{g^{-1}(S)} \mathcal{T}_M.$$

On the other hand, if there exist $\tau \in \mathcal{T}$ and $g \in \text{Aut}M$ such that $\tau_R = \tau_{g^{-1}(S)} \cdot \tau$, then

$$(M^{\tau_S})^g = (M^g)^{\tau_{g^{-1}(S)}} = M^{\tau_{g^{-1}(S)}} = M^{\tau_R}.$$

Therefore, g is an isomorphism between M^{τ_S} and M^{τ_R} . □

8.5.2 Enumerating Semi-Regular Map. We enumerate maps underlying a semi-regular graph on orientable or non-orientable surfaces.

Lemma 8.5.4 *Let $G = (V, E)$ be a semi-regular graph. Then for $\xi \in \text{Aut}G$*

$$|\Phi^O(\xi)| = \prod_{x \in T_\xi^V} \left(\frac{d(x)}{o(\xi|_{N_G(x)})} - 1 \right)!$$

and

$$|\Phi^L(\xi)| = 2^{|T_\xi^E| - |T_\xi^V|} \prod_{x \in T_\xi^V} \left(\frac{d(x)}{o(\xi|_{N_G(x)})} - 1 \right)!,$$

where, T_ξ^V, T_ξ^E are the representations of orbits of ξ acting on $V(G)$ and $E(G)$, respectively and $\xi|_{N_G(x)}$ the restriction of ξ to $N_G(x)$.

Proof According to Theorem 8.5.1, we know that

$$\mathcal{E}^T(G) = \{ \mathcal{P}^\tau | \mathcal{P} \in \mathcal{E}^O(G), \tau \in \mathcal{T} \}$$

Notice that if $M^\xi = M$, then $M^{\tau\xi} = M^\tau$. Now since $\text{Aut}G$ is semi-regular acting on $E(G)$, we can assume that

$$\xi|_{V(G)} = (a, b, \dots, c) \cdots (d, e, \dots, f) \cdots (x, y, \dots, z)$$

and

$$\xi|_{E(G)} = (e_{11}, e_{12}, \dots, e_{1l_1}) \cdots (e_{i1}, e_{i2}, \dots, e_{il_i}) \cdots (e_{s1}, e_{s2}, \dots, e_{sl_s}).$$

For a stable orientable embedding $M_0 = (E(G)_{\alpha,\beta}, \mathcal{P}_0)$ under the action of ξ , it is clear that

$$|\Phi(M_0^T, \xi)| = 2^{orb(\xi|_{E(G)}) - orb(\xi|_{V(G)})},$$

where $orb(\xi|_{E(G)})$ and $orb(\xi|_{V(G)})$ are the number of orbits of $E(G)$, $V(G)$ under the action of ξ and we subtract $orb(\xi|_{V(G)})$ because one of quadricells in vertices a, \dots, d, \dots, x can be chosen first in our enumeration. Now since $orb(\xi|_{E(G)}) = |T_\xi^E|$ and $orb(\xi|_{V(G)}) = |T_\xi^V|$, we get that

$$|\Phi(M_0^T, \xi)| = 2^{|T_\xi^E| - |T_\xi^V|}.$$

Notice that if the rotation of the quadricells adjacent to the vertex a has been given, then the rotations adjacent to the vertices b, \dots, c are uniquely determined if the correspondence embedding is stable under the action of ξ . Similarly, if a rotation of the quadricells adjacent to the vertices a, \dots, d, \dots, x have been given, then the map $M = (E(G)_{\alpha,\beta}, \mathcal{P})$ is uniquely determined if M is stable under the action of ξ . Since $\xi|_{N_G(x)}$ is semi-regular, for $\forall x \in V(G)$ we can assume that

$$\xi|_{N_G(x)} = (x^{z^1}, x^{z^2}, \dots, x^{z^s})(x^{z^{s+1}}, x^{z^{s+2}}, \dots, x^{z^{2s}}) \cdots (x^{z^{(k-1)s+1}}, x^{z^{(k-1)s+2}}, \dots, x^{z^{ks}}).$$

Consequently, we get that

$$|\Phi^O(\xi)| = \prod_{x \in T_\xi^V} \left(\frac{d(x)}{o(\xi|_{N_G(x)})} - 1 \right)!. \quad \square$$

According to the Corollary 8.3.1, we get enumeration results following.

Theorem 8.5.2 *Let G be a semi-regular graph. Then the numbers of maps underlying the graph G on orientable or non-orientable surfaces are respectively*

$$n^O(G) = \frac{1}{|\text{Aut}G|} \left(\sum_{\xi \in \text{Aut}G} \lambda(\xi) \prod_{x \in T_\xi^V} \left(\frac{d(x)}{o(\xi|_{N_G(x)})} - 1 \right) ! \right)$$

and

$$n^N(G) = \frac{1}{|\text{Aut}G|} \times \sum_{\xi \in \text{Aut}G} (2^{|T_\xi^E| - |T_\xi^V|} - 1) \lambda(\xi) \prod_{x \in T_\xi^V} \left(\frac{d(x)}{o(\xi|_{N_G(x)})} - 1 \right) !,$$

where $\lambda(\xi) = 1$ if $o(\xi) \equiv 0 \pmod{2}$ and $\frac{1}{2}$, otherwise.

Proof By the Corollary 8.3.1, we know that

$$n^O(G) = \frac{1}{2|\text{Aut}_{\frac{1}{2}}G|} \sum_{g \in \text{Aut}_{\frac{1}{2}}G} |\Phi_1^O(g)|$$

and

$$n^L(G) = \frac{1}{2|\text{Aut}_{\frac{1}{2}}G|} \sum_{g \in \text{Aut}_{\frac{1}{2}}G} |\Phi_1^T(g)|.$$

According to the Theorem 7.3.4, all automorphisms of orientable maps underlying graph G are respectively

$$g|^{X_{\alpha,\beta}} \text{ and } \alpha h|^{X_{\alpha,\beta}}, g, h \in \text{Aut}G \text{ with } o(h) \equiv 0(\text{mod}2).$$

and all the automorphisms of non-orientable maps underlying graph G are also

$$g|^{X_{\alpha,\beta}} \text{ and } \alpha h|^{X_{\alpha,\beta}}, g, h \in \text{Aut}G \text{ with } o(h) \equiv 0(\text{mod}2).$$

Whence, we get the number of orientable maps by the Lemma 8.5.4 as follows.

$$\begin{aligned} n^O(G) &= \frac{1}{2|\text{Aut}G|} \sum_{g \in \text{Aut}G} |\Phi_1^O(g)| \\ &= \frac{1}{2|\text{Aut}G|} \left\{ \left(\sum_{\xi \in \text{Aut}G} \prod_{x \in T_\xi^V} \left(\frac{d(x)}{o(\xi|_{N_G(x)})} - 1 \right)! \right) \right. \\ &\quad \left. + \sum_{\varsigma \in \text{Aut}G, o(\varsigma) \equiv 0(\text{mod}2)} \prod_{x \in T_\varsigma^V} \left(\frac{d(x)}{o(\varsigma|_{N_G(x)})} - 1 \right)! \right\} \\ &= \frac{1}{|\text{Aut}G|} \left(\sum_{\xi \in \text{Aut}G} \lambda(\xi) \prod_{x \in T_\xi^V} \left(\frac{d(x)}{o(\xi|_{N_G(x)})} - 1 \right)! \right). \end{aligned}$$

Similarly, we enumerate maps underlying graph G on locally orientable surface by (8.3.3) in Corollary 8.3.1 following.

$$\begin{aligned} n^L(G) &= \frac{1}{2|\text{Aut}G|} \sum_{g \in \text{Aut}G} |\Phi_1^T(g)| \\ &= \frac{1}{2|\text{Aut}G|} \left(\sum_{\xi \in \text{Aut}G} \prod_{x \in T_\xi^V} \left(\frac{d(x)}{o(\xi|_{N_G(x)})} - 1 \right)! \right. \\ &\quad \left. + \sum_{\varsigma \in \text{Aut}G, o(\varsigma) \equiv 0(\text{mod}2)} 2^{|T_\varsigma^E| - |T_\varsigma^V|} \prod_{x \in T_\varsigma^V} \left(\frac{d(x)}{o(\varsigma|_{N_G(x)})} - 1 \right)! \right) \\ &= \frac{1}{|\text{Aut}G|} \sum_{\xi \in \text{Aut}G} \lambda(\xi) 2^{|T_\xi^E| - |T_\xi^V|} \prod_{x \in T_\xi^V} \left(\frac{d(x)}{o(\xi|_{N_G(x)})} - 1 \right)!. \end{aligned}$$

Notice that $n^O(G) + n^N(G) = n^L(G)$. We get the number of maps on non-orientable surfaces underlying graph G to be

$$\begin{aligned} n^N(G) &= n^L(G) - n^O(G) \\ &= \frac{1}{|\text{Aut}G|} \times \sum_{\xi \in \text{Aut}G} (2^{|T_\xi^E| - |T_\xi^V|} - 1) \lambda(\xi) \prod_{x \in T_\xi^V} \left(\frac{d(x)}{o(\xi|_{N_G(x)})} - 1 \right)! \end{aligned}$$

This completes the proof. □

Furthermore, if G is k -regular, we get a simple result for the numbers of maps on orientable or non-orientable surfaces following.

Corollary 8.5.1 *Let G be a k -regular semi-regular graph. Then the numbers of maps on orientable or non-orientable surfaces underlying graph G are respectively*

$$n^O(G) = \frac{1}{|\text{Aut}G|} \times \sum_{g \in \text{Aut}G} \lambda(g) (k-1)!^{|T_g^V|}$$

and

$$n^N(G) = \frac{1}{|\text{Aut}G|} \times \sum_{g \in \text{Aut}G} \lambda(g) (2^{|T_g^E| - |T_g^V|} - 1) (k-1)!^{|T_g^V|},$$

where, $\lambda(\xi) = 1$ if $o(\xi) \equiv 0 \pmod{2}$ and $\frac{1}{2}$, otherwise.

Proof Notice that for $\forall \xi \in \text{Aut}G$, ξ is semi-regular acting on ordered pairs of adjacent vertices of G . Therefore, ξ is an orientation-preserving automorphism of map with underlying graph of G .

Assume that

$$\xi_{V(G)} = (a^1, a^2, \dots, a^s)(b^1, b^2, \dots, b^s) \cdots (c^1, c^2, \dots, c^s).$$

It can be directly checked that for $\forall e \in E(G)$,

$$|e^{<\xi>}| = s \text{ or } \frac{s}{2}.$$

The later is true only if s is an even number. Therefore, we have that

$$\forall x \in V(G), o(\xi|_{N_G(x)}) = 1.$$

Whence, we get $n^O(G)$ and $n^N(G)$ by Theorem 8.5.2. □

Similarly, if $G = \text{Cay}(Z_p : S)$ for a prime p , we can also get closed formulas for the number of maps underlying graph Γ .

Corollary 8.5.2 *Let $G = \text{Cay}(Z_p : S)$ be a connected graph of prime order p with $(p - 1, |S|) = 2$. Then*

$$n^O(G, \mathcal{M}) = \frac{(|S| - 1)!^p + 2p(|S| - 1)!^{\frac{p+1}{2}} + (p - 1)(|S| - 1)!}{4p}$$

and

$$\begin{aligned} n^N(G, \mathcal{M}) &= \frac{(2^{\frac{p|S|}{2}-p} - 1)(|S| - 1)!^p + 2(2^{\frac{p|S|-2p-2}{4}} - 1)p(|S| - 1)!^{\frac{p+1}{2}}}{2p} \\ &+ \frac{(2^{\frac{|S|-2}{2}} - 1)(p - 1)(|S| - 1)!}{4p}. \end{aligned}$$

Proof We calculate $|T_g^V|, |T_g^E|$ now. Since p is a prime number, there are $p-1$ elements of degree p , p elements of degree 2 and one element of degree 1. Therefore, we know that

$$|T_g^V| = \begin{cases} 1, & \text{if } o(g) = p \\ \frac{p+1}{2}, & \text{if } o(g) = 2 \\ p, & \text{if } o(g) = 1 \end{cases}$$

and

$$|T_g^E| = \begin{cases} \frac{|S|}{2}, & \text{if } o(g) = p \\ \frac{p|S|}{4}, & \text{if } o(g) = 2 \\ \frac{p|S|}{2}, & \text{if } o(g) = 1 \end{cases}$$

Notice that $\text{Aut}G = D_p$ and there are p elements order 2, one order 1 and $p - 1$ order p . Whence, we have

$$n^O(G, \mathcal{M}) = \frac{(|S| - 1)!^p + 2p(|S| - 1)!^{\frac{p+1}{2}} + (p - 1)(|S| - 1)!}{4p}$$

and

$$\begin{aligned} n^N(G, \mathcal{M}) &= \frac{(2^{\frac{p|S|}{2}-p} - 1)(|S| - 1)!^p + 2(2^{\frac{p|S|-2p-2}{4}} - 1)p(|S| - 1)!^{\frac{p+1}{2}}}{2p} \\ &+ \frac{(2^{\frac{|S|-2}{2}} - 1)(p - 1)(|S| - 1)!}{4p}. \end{aligned}$$

By Corollary 8.5.1. □

§8.6 THE ENUMERATION OF A BOUQUET ON SURFACES

8.6.1 Cycle Index of Group. Let $(\Gamma; \circ)$ be a group. Its *cycle index of a group*, denoted by $Z(\Gamma; s_1, s_2, \dots, s_n)$ is defined by

$$Z(\Gamma; s_1, s_2, \dots, s_n) = \frac{1}{|\Gamma|} \sum_{g \in \Gamma} s_1^{\lambda_1(g)} s_2^{\lambda_2(g)} \dots s_n^{\lambda_n(g)},$$

where, $\lambda_i(g)$ is the number of i -cycles in the cycle decomposition of g . For the symmetric group S_n , its cycle index is known to be

$$Z(S_n; s_1, s_2, \dots, s_n) = \sum_{\lambda_1 + 2\lambda_2 + \dots + k\lambda_k = n} \frac{s_1^{\lambda_1} s_2^{\lambda_2} \dots s_k^{\lambda_k}}{1^{\lambda_1} \lambda_1! 2^{\lambda_2} \lambda_2! \dots k^{\lambda_k} \lambda_k!}.$$

For example, we have that $Z(S_2) = \frac{s_1^2 + s_2}{2}$. By a result of Polya (See [GrW1] for details), we know that the cycle index of $S_n[S_2]$ is

$$Z(S_n[S_2]; s_1, s_2, \dots, s_{2n}) = \frac{1}{2^n n!} \sum_{\lambda_1 + 2\lambda_2 + \dots + k\lambda_k = n} \frac{\left(\frac{s_1^2 + s_2}{2}\right)^{\lambda_1} \left(\frac{s_2^2 + s_4}{2}\right)^{\lambda_2} \dots \left(\frac{s_k^2 + s_{2k}}{2}\right)^{\lambda_k}}{1^{\lambda_1} \lambda_1! 2^{\lambda_2} \lambda_2! \dots k^{\lambda_k} \lambda_k!}$$

8.6.2 Enumerating One-Vertex Map. For any integer $k, k|2n$, let \mathcal{J}_k be the conjugacy class in $S_n[S_2]$ with each cycle in the decomposition of a permutation in \mathcal{J}_k being k -cycle. According to Corollary 8.3.1, we need to determine the numbers $|\Phi^O(\xi)|$ and $|\Phi^L(\xi)|$ for each automorphism of map underlying B_n .

Lemma 8.6.1 Let $\xi = \prod_{i=1}^{2n/k} (C(i))(\alpha C(i)\alpha^{-1}) \in \mathcal{J}_k$ be a cycle decomposition of ξ , where $C(i) = (x_{i1}, x_{i2}, \dots, x_{ik})$ is a k -cycle. Then

(1) If $k \neq 2n$, then

$$|\Phi^O(\xi)| = k^{\frac{2n}{k}} \left(\frac{2n}{k} - 1\right)!$$

and if $k = 2n$, then $|\Phi^O(\xi)| = \phi(2n)$.

(2) If $k \geq 3$ and $k \neq 2n$, then

$$|\Phi^L(\xi)| = (2k)^{\frac{2n}{k}-1} \left(\frac{2n}{k} - 1\right)!$$

and

$$|\Phi^L(\xi)| = 2^n (2n - 1)!$$

if $\xi = (x_1)(x_2) \dots (x_n)(\alpha x_1)(\alpha x_2) \dots (\alpha x_n)(\beta x_1)(\beta x_2) \dots (\beta x_n)(\alpha \beta x_1)(\alpha \beta x_2) \dots (\alpha \beta x_n)$, and

$$|\Phi^L(\xi)| = 1$$

if $\xi = (x_1, \alpha\beta x_1)(x_2, \alpha\beta x_2) \cdots (x_n, \alpha\beta x_n)(\alpha x_1, \beta x_1)(\alpha x_2, \beta x_2) \cdots (\alpha x_n, \beta x_n)$, and

$$|\Phi^L(\xi)| = \frac{n!}{(n-2s)!s!}$$

if $\xi = \zeta; \varepsilon_1, \varepsilon_2, \dots, \varepsilon_n$ and $\zeta \in \mathcal{E}_{[1^{n-2s}, 2^s]}$ for some integer s , $\varepsilon_i = (1, \alpha\beta)$ for $1 \leq i \leq s$ and $\varepsilon_j = 1$ for $s+1 \leq j \leq n$, where $\mathcal{E}_{[1^{n-2s}, 2^s]}$ denotes the conjugate class with the type $[1^{n-2s}, 2^s]$ in the symmetry group S_n , and

$$|\Phi^L(\xi)| = \phi(2n)$$

if $\xi = \theta; \varepsilon_1, \varepsilon_2, \dots, \varepsilon_n$ and $\theta \in \mathcal{E}_{[n^1]}$ and $\varepsilon_i = 1$ for $1 \leq i \leq n-1$, $\varepsilon_n = (1, \alpha\beta)$, where $\phi(t)$ is the Euler function.

Proof (1) Notice that for a representation of $C(i)$, $i = 1, 2, \dots, \frac{2n}{k}$, because the group $\langle \mathcal{P}_n, \alpha\beta \rangle$ is not transitive on $\mathcal{X}_{\alpha\beta}$, there is one and only one stable orientable map $\mathcal{B}_n = (\mathcal{X}_{\alpha\beta}, \mathcal{P}_n)$ with $X = E(\mathcal{B}_n)$ and $\mathcal{P}_n = C(\alpha C^{-1} \alpha^-)$, where,

$$C = (x_{11}, x_{21}, \dots, x_{\frac{2n}{k}1}, x_{21}, x_{22}, \dots, x_{\frac{2n}{k}2}, x_{1k}, x_{2k}, \dots, x_{\frac{2n}{k}k}).$$

Counting ways for each possible order for $C(i)$, $i = 1, 2, \dots, \frac{2n}{k}$ and different representations for $C(i)$, we know that

$$|\Phi^O(\xi)| = k^{\frac{2n}{k}} \left(\frac{2n}{k} - 1\right)!$$

for $k \neq 2n$.

Now if $k = 2n$, then the permutation is itself a map underlying graph \mathcal{B}_n . Whence, its power is also an automorphism of this map. Therefore, we get that

$$|\Phi^O(\xi)| = \phi(2n).$$

(2) For $k \geq 3$ and $k \neq 2n$, because the group $\langle \mathcal{P}_n, \alpha\beta \rangle$ is transitive on $\mathcal{X}_{\alpha\beta}$ or not, we can interchange $C(i)$ by $\alpha C(i)^{-1} \alpha^{-1}$ for each cycle not containing the quadricell x_{11} . Notice that we get the same map if the two sides of some edges are interchanged altogether or not. Whence, we find that

$$|\Phi^L(\xi)| = 2^{\frac{2n}{k}-1} k^{\frac{2n}{k}-1} \left(\frac{2n}{k} - 1\right)! = (2k)^{\frac{2n}{k}-1} \left(\frac{2n}{k} - 1\right)!.$$

Now if $\xi = (x_1, \alpha\beta x_1)(x_2, \alpha\beta x_2) \cdots (x_n, \alpha\beta x_n)(\alpha x_1, \beta x_1)(\alpha x_2, \beta x_2) \cdots (\alpha x_n, \beta x_n)$, there is one and only one stable map $(\mathcal{X}_{\alpha\beta}, \mathcal{P}_n^1)$ under the action of ξ , where

$$\mathcal{P}_n^1 = (x_1, x_2, \dots, x_n, \alpha\beta x_1, \alpha\beta x_2, \dots, \alpha\beta x_n)(\alpha x_1, \beta x_n, \dots, \beta x_1, \alpha x_n, \dots, \alpha x_1),$$

which is orientable. Whence, $|\Phi^L(\xi)| = |\Phi^O(\xi)| = 1$.

If $\xi = (x_1)(x_2) \cdots (x_n)(\alpha x_1)(\alpha x_2) \cdots (\alpha x_n)(\beta x_1)(\beta x_2) \cdots (\beta x_n)(\alpha \beta x_1)(\alpha \beta x_2) \cdots (\alpha \beta x_n)$, we can interchange $(\alpha \beta x_i)$ with (βx_i) and obtain different embeddings of B_n on surfaces. Whence,

$$|\Phi^L(\xi)| = 2^n(2n-1)!$$

Now if $\xi = (\zeta; \varepsilon_1, \varepsilon_2, \dots, \varepsilon_n)$ and $\zeta \in \mathcal{E}_{[1^{n-2s}, 2^s]}$ for some integer s , $\varepsilon_i = (1, \alpha\beta)$ for $1 \leq i \leq s$ and $\varepsilon_j = 1$ for $s+1 \leq j \leq n$, we can not interchange $(x_i, \alpha\beta x_i)$ with $(\alpha x_i, \beta x_i)$ to get different embeddings of B_n for it is just interchanging the two sides of one edge. Consequently, we get that

$$|\Phi^L(\xi)| = \frac{n!}{1^{n-2s}(n-2s)!2^s s!} \times 2^s = \frac{n!}{(n-2s)!s!}.$$

For $\xi = (\theta; \varepsilon_1, \varepsilon_2, \dots, \varepsilon_n)$, $\theta \in \mathcal{E}_{[n^1]}$ and $\varepsilon_i = 1$ for $1 \leq i \leq n-1$, $\varepsilon_n = (1, \alpha\beta)$, we can not get different embeddings of B_n by interchanging the two conjugate cycles. Whence, we get that

$$|\Phi^L(\xi)| = |\Phi^O(\xi)| = \phi(2n).$$

This completes the proof. □

Now we enumerate maps on surfaces underlying graph B_n by Lemma 8.6.1.

Theorem 8.6.1 *For an integer $n \geq 1$, the number $n^O(B_n)$ of maps on orientable surfaces underlying graph B_n is*

$$\begin{aligned} n^O(B_n) &= \sum_{k|2n, k \neq 2n} k^{\frac{2n}{k}-1} \left(\frac{2n}{k} - 1\right)! \frac{1}{\left(\frac{2n}{k}\right)!} \frac{\partial^{\frac{2n}{k}}(Z(S_n[S_2]))}{\partial s_k^{\frac{2n}{k}}} \Big|_{s_k=0} \\ &+ \phi(2n) \frac{\partial(Z(S_n[S_2]))}{\partial s_{2n}} \Big|_{s_{2n}=0} \end{aligned}$$

Proof According to the formula (8.3.1) in Corollary 8.3.1, we know that

$$n^O(B_n) = \frac{1}{2 \times 2^n n!} \sum_{\xi \in S_n[S_2] \times \langle \alpha \rangle} |\Phi^T(\xi)|.$$

Since for $\forall \xi_1, \xi_2 \in S_n[S_2]$, if there exists an element $\theta \in S_n[S_2]$ such that $\xi_2 = \theta \xi_1 \theta^{-1}$, then $|\Phi^O(\xi_1)| = |\Phi^O(\xi_2)|$ and $|\Phi^O(\xi)| = |\Phi^O(\xi\alpha)|$. Notice that $|\Phi^O(\xi)|$ has been gotten by Lemma 8.6.1. Applying Lemma 8.6.1(1) and the cycle index $Z(S_n[S_2])$, we get that

$$n^O(B_n) = \frac{1}{2 \times 2^n n!} \left(\sum_{k|2n, k \neq 2n} k^{\frac{2n}{k}-1} \left(\frac{2n}{k} - 1\right)! |\mathcal{J}_k| + \phi(2n) |\mathcal{J}_{2n}| \right)$$

$$\begin{aligned}
 &= \sum_{k|2n, k \neq 2n} k^{\frac{2n}{k}-1} \left(\frac{2n}{k} - 1\right)! \frac{1}{\left(\frac{2n}{k}\right)!} \frac{\partial^{\frac{2n}{k}}(Z(S_n[S_2]))}{\partial s_k^{\frac{2n}{k}}} \Big|_{s_k=0} \\
 &\quad + \phi(2n) \frac{\partial(Z(S_n[S_2]))}{\partial s_{2n}} \Big|_{s_{2n}=0} \quad \square
 \end{aligned}$$

Now we consider maps on non-orientable surfaces underlying graph B_n . Similar to the discussion of Theorem 8.6.1, we get the following enumeration result for the maps on non-orientable surfaces.

Theorem 8.6.2 *For an integer $n \geq 1$, the number $n^N(B_n)$ of maps on non-orientable surfaces underlying graph B_n is*

$$\begin{aligned}
 n^N(B_n) &= \frac{(2n-1)!}{n!} + \sum_{k|2n, 3 \leq k < 2n} (2k)^{\frac{2n}{k}-1} \left(\frac{2n}{k} - 1\right)! \frac{\partial^{\frac{2n}{k}}(Z(S_n[S_2]))}{\partial s_k^{\frac{2n}{k}}} \Big|_{s_k=0} \\
 &\quad + \frac{1}{2^n n!} \left(\sum_{s \geq 1} \frac{n!}{(n-2s)!s!} + 4^n (n-1)! \left(\frac{\partial^n(Z(S_n[S_2]))}{\partial s_2^n} \Big|_{s_2=0} - \lfloor \frac{n}{2} \rfloor \right) \right).
 \end{aligned}$$

Proof Similar to the proof of Theorem 8.6.1, applying formula (1.3.3) in Corollary 8.3.1 and Lemma 8.6.1(2), we get that

$$\begin{aligned}
 n^L(B_n) &= \frac{(2n-1)!}{n!} + \phi(2n) \frac{\partial^n(Z(S_n[S_2]))}{\partial s_{2n}^n} \Big|_{s_{2n}=0} \\
 &\quad + \frac{1}{2^n n!} \left(\sum_{s \geq 0} \frac{n!}{(n-2s)!s!} + 4^n (n-1)! \left(\frac{\partial^n(Z(S_n[S_2]))}{\partial s_2^n} \Big|_{s_2=0} - \lfloor \frac{n}{2} \rfloor \right) \right) \\
 &\quad + \sum_{k|2n, 3 \leq k < 2n} (2k)^{\frac{2n}{k}-1} \left(\frac{2n}{k} - 1\right)! \frac{\partial^{\frac{2n}{k}}(Z(S_n[S_2]))}{\partial s_k^{\frac{2n}{k}}} \Big|_{s_k=0}.
 \end{aligned}$$

Notice that $n^O(B_n) + n^N(B_n) = n^L(B_n)$. Applying Theorem 8.6.1, we find that

$$\begin{aligned}
 n^N(B_n) &= \frac{(2n-1)!}{n!} + \sum_{k|2n, 3 \leq k < 2n} (2k)^{\frac{2n}{k}-1} \left(\frac{2n}{k} - 1\right)! \frac{\partial^{\frac{2n}{k}}(Z(S_n[S_2]))}{\partial s_k^{\frac{2n}{k}}} \Big|_{s_k=0} \\
 &\quad + \frac{1}{2^n n!} \left(\sum_{s \geq 1} \frac{n!}{(n-2s)!s!} + 4^n (n-1)! \left(\frac{\partial^n(Z(S_n[S_2]))}{\partial s_2^n} \Big|_{s_2=0} - \lfloor \frac{n}{2} \rfloor \right) \right).
 \end{aligned}$$

This completes the proof. □

Calculation shows that

$$Z(S_1[S_2]) = \frac{s_1^2 + s_2}{2}$$

and

$$Z(S_2[S_2]) = \frac{s_1^4 + 2s_1^2 s_2 + 3s_2^2 + 2s_4}{8},$$

Whence, if $n = 2$, calculation shows that there are 1 map on the plane, 2 maps on the projective plane, 1 map on the torus and 2 maps on the Klein bottle. All of those maps are non-isomorphic and the same as gotten by Theorems 8.6.1 and 8.6.2 shown in Fig.8.6.1.

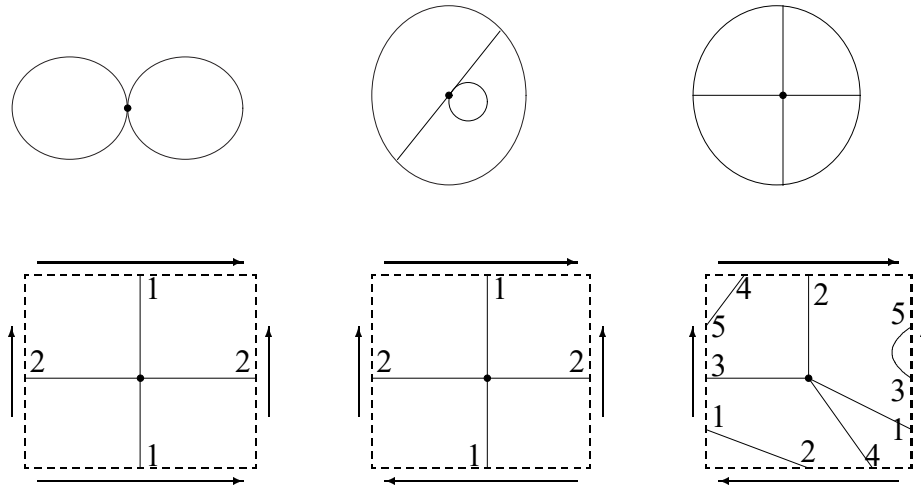

Fig.8.6.1

§8.7 REMARKS

8.7.1 The enumeration problem of maps was first introduced by Tutte on planar rooted triangulation by solving a functional equation in 1962. After him, more and more papers and enumeration result on rooted maps on surfaces published. For surveying such an enumeration, the readers are referred to references [Liu2]-[Liu4] for details.

8.7.2 The enumeration of rooted maps on surfaces is canonically by an analytic approach. Usually, this approach for enumeration of rooted maps applies four steps as follows:

STEP 1. Decompose the set of rooted maps \mathcal{M} considered;

STEP 2. Define the enumeration function $f_{\mathcal{M}}$ on maps by parameters, such as those of order $n(M)$, size $m(M)$, valency of rooted vertex or rooted face, \dots of maps, for example,

$$f_{\mathcal{M}} = \sum_{M \in \mathcal{M}} x^{n(M)}, \quad f_{\mathcal{M}} = \sum_{M \in \mathcal{M}} x^{m(M)}, \quad f_{\mathcal{M}} = \sum_{M \in \mathcal{M}} x^{n(M)}y^{m(M)} \quad \text{and} \quad f_{\mathcal{M}} = \sum_{M \in \mathcal{M}} x^{n(M)}y^{m(M)}z^{l(M)}$$

are four enumeration functions respectively by order $n(M)$, size $m(M)$ and valency of rooted vertex $l(M)$ of map and then establish equations satisfied by $f_{\mathcal{M}}$.

STEP 3. Find properly parametric expression for variables x, y, z, \dots .

STEP 4. Applying the Lagrange inversion, i.e., if $x = t\phi(x)$ with $\phi(0) \neq 0$, then

$$f(x) = f(0) + \sum_{i \geq 1} \frac{t^i}{i!} \frac{d^{i-1}}{dx^{i-1}} \left(\phi^i \frac{df}{dx} \right) \Big|_{x=0}$$

solves the equations for enumeration.

The importance of Theorems 8.1.7 and 8.1.8 is that they clarify the essence of the enumeration of rooted maps on surfaces, i.e., a calculation of the summation

$$\sum_{G \in \mathcal{G}} \frac{2\varepsilon(G) \prod_{v \in V(G)} (\rho(v) - 1)!}{|\text{Aut}_{\frac{1}{2}} G|} \quad \text{or} \quad \sum_{G \in \mathcal{G}} \frac{2^{\beta(G)+1} \varepsilon(G) \prod_{v \in V(G)} (\rho(v) - 1)!}{|\text{Aut}_{\frac{1}{2}} G|}$$

where \mathcal{G} denotes a graph family. For example, we know that the number of rooted tree of size n is $\frac{(2n)!}{n!(n+1)!}$. Whence,

$$\sum_{T \in \mathcal{T}(n)} \frac{\prod_{d \in D(T)} (d-1)!}{|\text{Aut} T|} = \frac{(2n-1)!}{n!(n+1)!},$$

where \mathcal{T} and $D(T)$ denote sets of non-isomorphic trees of size n and the valency sequence of a tree $T \in \mathcal{T}$, respectively.

Similarly, Theorem 8.2.1 implies the enumeration of rooted maps on a surface S of genus i is in fact a calculation of the summation

$$\sum_{G \in \mathcal{G}(S)} \frac{2\varepsilon(G)g_i(G)}{|\text{Aut}_{\frac{1}{2}} G|},$$

where $\mathcal{G}(S)$ denotes a graph family embeddable on S . For example, We know that there are

$$\frac{2(2n-1)!(2n+1)!}{(n+2)!(n+1)!!n!(n-1)!}$$

planar cubic hamiltonian rooted maps. Whence,

$$\sum_{G \in \mathcal{C}_H} \frac{2\varepsilon(G)g_0(G)}{|\text{Aut} G|} = \frac{2(2n-1)!(2n+1)!}{(n+2)!(n+1)!!n!(n-1)!},$$

where \mathcal{C}_H denotes the family of hamiltonian cubic.

8.7.3 By applying Burnside lemma, Biggs and White suggested a scheme for enumerating non-equivalent embeddings of a graph G on surfaces, i.e., orbits under the action of

$\text{Aut}G$ on all embeddings of G in [BiW1]. Such an action is in fact orientation-preserving. Theorem 8.3.2 is a generalization of their result by considering the action of $\text{Aut}_{\frac{1}{2}}G \times \langle \alpha \rangle$ on all embeddings of G on surfaces. This scheme enables one to find non-isomorphic maps on surfaces underlying a graph. Indeed, complete maps, semi-regular maps and one-vertex maps are enumerated in Sections 8.4-8.6. Certainly, there are more maps on surfaces needed to be enumerated, such as those of maps included in problems following.

Problem 8.7.1 *Enumerate maps on surfaces underlying a vertex-transitive, an edge-transitive or a regular graph, particularly, a Cayley graph $\text{Cay}(\Gamma : S)$.*

Problem 8.7.2 *Enumerate maps on surfaces underlying a graph G with known $\text{Aut}_{\frac{1}{2}}G$, such as those of $C_n \times P_2$ and $C_m \times C_n \times C_l$ for integers $n, m, l \geq 1$.*

Problem 8.7.3 *Enumerate a typical maps underlying a graph, for example, regular maps or Cayley maps.*

The enumeration of maps on surfaces underlying a graph also brings about problems following on graphs.

Problem 8.7.4 *Find a graph family \mathcal{G} on a surface S such that the number of non-isomorphic maps underlying graph in \mathcal{G} is summable.*

Problem 8.7.5 *For a surface S and an integer $n \geq 2$, determine the family $\mathcal{G}_n(S)$ embeddable on S with $|\text{Aut}_{\frac{1}{2}}G| = n$ for $\forall G \in \mathcal{G}_n(S)$.*

CHAPTER 9.

Isometries on Smarandache Geometry

We have known that classical geometry includes those of Euclid geometry, Lobachevshy-Bolyai-Gauss geometry and Riemann geometry. Each of the later two is proposed by denial the 5th postulate for parallel lines in Euclid postulates on geometry. For generalizing classical geometry, a new geometry, called *Smarandache geometry* was proposed by Smarandache in 1969, which may enables these three geometries to be united in the same space altogether such that it can be either partially Euclidean and partially non-Euclidean, or non-Euclidean. Such a geometry is really a hybridization of these geometries. It is important for destroying the law that all points are equal in status and introducing contradictory laws in a same geometrical space. For an introduction to such geometry, we formally define Smarandache geometry, particularly, those of mixed geometries in Section 9.1, and classify s-manifolds, a kind of Smarandache 2-manifolds by applying planar maps in Section 2. After then, Sections 3 and 4 concentrate on the isometries on finite or infinite pseudo-Euclidean spaces (\mathbf{R}^n, μ) by verifying the action of isometries of \mathbf{R}^n on (\mathbf{R}^n, μ) for $n \geq 2$. Certainly, all isometries on finite pseudo-Euclidean spaces (\mathbf{R}^n, μ) are automorphisms of (\mathbf{R}^n, μ) , and can be characterized combinatorially by that of maps on surfaces if $n = 2$ or embedded graphs in \mathbf{R}^n if $n \geq 3$.

§9.1 SMARANDACHE GEOMETRY

9.1.1 Geometrical Axiom. As we known, the Euclidean geometrical axiom system consists of five axioms following:

(E1) There is a straight line between any two points.

(E2) A finite straight line can produce an infinite straight line continuously.

(E3) Any point and a distance can describe a circle.

(E4) All right angles are equal to one another.

(E5) If a straight line falling on two straight lines make the interior angles on the same side less than two right angles, then the two straight lines, if produced indefinitely, meet on that side on which are the angles less than the two right angles.

The last axiom (E5) is usually replaced by:

(E5') *For a given line and a point exterior this line, there is one line parallel to this line.*

Then a *hyperbolic geometry* is replaced axiom (E5) by (L5) following

(L5) *There are infinitely many lines parallel to a given line passing through an exterior point,*

and an *elliptic geometry* is replaced axiom (E5) by (R5) following:

There are no parallel to a given line passing through an exterior point.

9.1.2 Smarandache Geometry. These non-Euclidean geometries constructed in the previous subsection implies that one can find more non-Euclidean geometries replacing Euclidean axioms by non-Euclidean axioms. In fact, a Smarandache geometry is such a geometry by denied some axioms (E1)-(E5) following.

Definition 9.1.1 *A rule $R \in \mathcal{R}$ in a mathematical system $(\Sigma; \mathcal{R})$ is said to be Smarandachely denied if it behaves in at least two different ways within the same set Σ , i.e., validated and invalidated, or only invalidated but in multiple distinct ways.*

Definition 9.1.2 *A Smarandache geometry is such a geometry in which there are at least one Smarandachely denied ruler and a Smarandache manifold $(M; \mathcal{A})$ is an n -dimensional manifold M that support a Smarandache geometry by Smarandachely denied axioms in \mathcal{A} .*

In a Smarandache geometry, points, lines, planes, spaces, triangles, \dots are called respectively *s-points*, *s-lines*, *s-planes*, *s-spaces*, *s-triangles*, \dots in order to distinguish them from that in classical geometry.

Example 9.1.1 Let us consider a Euclidean plane \mathbf{R}^2 and three non-collinear points A, B and C . Define *s-points* as all usual Euclidean points on \mathbf{R}^2 and *s-lines* any Euclidean line that passes through one and only one of points A, B and C . Then such a geometry is a Smarandache geometry by the following observations.

Observation 1. The axiom (E1) that through any two distinct points there exist one line passing through them is now replaced by: *one s-line* and *no s-line*. Notice that through any two distinct *s-points* D, E collinear with one of A, B and C , there is one *s-line* passing through them and through any two distinct *s-points* F, G lying on AB or non-collinear with one of A, B and C , there is no *s-line* passing through them such as those shown in Fig.9.1.1(a).

Observation 2. The axiom (E5) that through a point exterior to a given line there is only one parallel passing through it is now replaced by two statements: *one parallel* and *no parallel*. Let L be an *s-line* passes through C and is parallel in the Euclidean sense to AB . Notice that through any *s-point* not lying on AB there is one *s-line* parallel to L and through any other *s-point* lying on AB there is no *s-lines* parallel to L such as those shown in Fig.9.1.1(b).

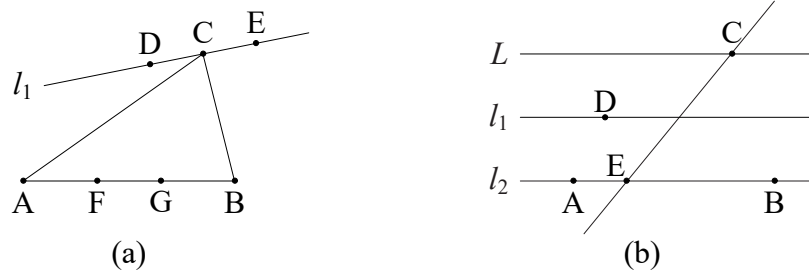

Fig.9.1.1

9.1.3 Mixed Geometry. In references [Sma1]-[Sma2], Smarandache introduced a few mixed geometries, such as those of the paradoxist geometry, the non-geometry, the counter-projective geometry and the anti-geometry by contradicts axioms (E1) – (E5) in a Euclid geometry following. All of these geometries are examples of Smarandache geometry.

Paradoxist Geometry. In this geometry, its axioms consist of $(E1) - (E4)$ and one of the following:

(1) There are at least a straight line and a point exterior to it in this space for which any line that passes through the point intersect the initial line.

(2) There are at least a straight line and a point exterior to it in this space for which only one line passes through the point and does not intersect the initial line.

(3) There are at least a straight line and a point exterior to it in this space for which only a finite number of lines $l_1, l_2, \dots, l_k, k \geq 2$ pass through the point and do not intersect the initial line.

(4) There are at least a straight line and a point exterior to it in this space for which an infinite number of lines pass through the point (but not all of them) and do not intersect the initial line.

(5) There are at least a straight line and a point exterior to it in this space for which any line that passes through the point and does not intersect the initial line.

Non-Geometry. The non-geometry is a geometry by denial some axioms of $(E1) - (E5)$, such as those of the following:

$(E1^-)$ It is not always possible to draw a line from an arbitrary point to another arbitrary point.

$(E2^-)$ It is not always possible to extend by continuity a finite line to an infinite line.

$(E3^-)$ It is not always possible to draw a circle from an arbitrary point and of an arbitrary interval.

$(E4^-)$ Not all the right angles are congruent.

$(E5^-)$ If a line cutting two other lines forms the interior angles of the same side of it strictly less than two right angle, then not always the two lines extended towards infinite cut each other in the side where the angles are strictly less than two right angle.

Counter-Projective Geometry. Denoted by P the point set, L the line set and R a relation included in $P \times L$. A counter-projective geometry is a geometry with these counter-axioms $(C_1) - (C_3)$ following:

$(C1)$ There exist either at least two lines, or no line, that contains two given distinct points.

$(C2)$ Let p_1, p_2, p_3 be three non-collinear points and q_1, q_2 two distinct points. Suppose that $\{p_1, q_1, p_3\}$ and $\{p_2, q_2, p_3\}$ are collinear triples. Then the line containing p_1, p_2

and the line containing q_1, q_2 do not intersect.

(C3) Every line contains at most two distinct points.

Anti-Geometry. A geometry by denial some axioms of the Hilbert's 21 axioms of Euclidean geometry.

§9.2 CLASSIFYING ISERI'S MANIFOLDS

9.2.1 Iseri's Manifold. The idea of Iseri's manifolds was based on a paper [Wee1] and credited to W.Thurston. A more general idea can be found in [PoS1]. Such a manifold is combinatorially defined in [Ise1] as follows:

An Iseri's manifold is any collection $C(T, n)$ of these equilateral triangular disks $T_i, 1 \leq i \leq n$ satisfying the following conditions:

- (1) *Each edge e is the identification of at most two edges e_i, e_j in two distinct triangular disks $T_i, T_j, 1 \leq i, j \leq n$ and $i \neq j$;*
- (2) *Each vertex v is the identification of one vertex in each of five, six or seven distinct triangular disks.*

The vertices of an Iseri's manifold are classified by the number of the disks around them. A vertex around five, six or seven triangular disks is called an *elliptic vertex*, a *Euclid vertex* or a *hyperbolic vertex*, respectively.

An Iseri's manifold is called closed if the number of triangular disks is finite and each edge is shared by exactly two triangular disks, each vertex is completely around by triangular disks. It is obvious that a closed Iseri's manifold is a surface and its Euler characteristic can be defined by Theorem 4.2.6.

Two Iseri's manifolds $C_1(T, n)$ and $C_2(T, n)$ are called to be *isomorphic* if there is an 1-1 mapping $\tau : C_1(T, n) \rightarrow C_2(T, n)$ such that for $\forall T_1, T_2 \in C_1(T, n), \tau(T_1 \cap T_2) = \tau(T_1) \cap \tau(T_2)$. If $C_1(T, n) = C_2(T, n) = C(T, n)$, τ is called an *automorphism* of Iseri's manifold $C(T, n)$. All automorphisms of an Iseri's manifold form a group under the composition operation, called the automorphism group of $C(T, n)$ and denoted by $\text{Aut}C(T, n)$.

9.2.2 A Model of Closed Iseri's Manifold. For a closed Iseri's manifold $C(T, n)$, we can define a map M by $V(M) = \{\text{the vertices in } C(T, n)\}, E(M) = \{\text{the edges in } C(T, n)\}$ and $F(M) = \{T, T \in C(T, n)\}$. Then M is a triangular map with vertex valency $\in \{5, 6, 7\}$.

On the other hand, if M is a triangular map on surface with vertex valency $\in \{5, 6, 7\}$, we can define an Iseri's manifold $C(T, \phi(M))$ by

$$C(T, \phi(M)) = \{f \mid f \in F(M)\}.$$

Then $C(T, \phi(M))$ is an Iseri's manifold. Consequently, we get a result following.

Theorem 9.2.1 *Let $\widehat{C}(T, n)$, $\mathcal{M}(T, n)$ and $\mathcal{M}^*(T, n)$ be the set of Iseri's manifolds with n triangular disks, triangular maps with n faces and vertex valency $\in \{5, 6, 7\}$ and cubic maps of order n with face valency $\in \{5, 6, 7\}$. Then*

- (1) *There is a bijection between $\mathcal{M}(T, n)$ and $\widehat{C}(T, n)$;*
- (2) *There is also a bijection between $\mathcal{M}^*(T, n)$ and $\widehat{C}(T, n)$.*

According to Theorem 9.2.1, we get the following result for the automorphisms of an Iseri's manifold following.

Theorem 9.2.2 *Let $C(T, n)$ be a closed s -manifold with negative Euler characteristic. Then $|\text{Aut}C(T, n)| \leq 6n$ and*

$$|\text{Aut}C(T, n)| \leq -21\chi(C(T, n)),$$

with equality hold only if $C(T, n)$ is hyperbolic, where $\chi(C(T, n))$ denotes the genus of $C(T, n)$.

Proof The inequality $|\text{Aut}C(T, n)| \leq 6n$ is known by the Corollary 6.4.1. Similar to the proof of Theorem 6.4.2, we know that

$$\varepsilon(C(T, n)) = \frac{-\chi(C(T, n))}{\frac{1}{3} - \frac{2}{k}},$$

where $k = \frac{1}{v(C(T, n))} \sum_{i \geq 1} iv_i \leq 7$ and with the equality holds only if $k = 7$, i.e., $C(T, n)$ is hyperbolic. □

9.2.3 Classifying Closed Iseri's Manifolds. According to Theorem 9.2.1, we can classify closed Iseri's manifolds by that of triangular maps with valency in $\{5, 6, 7\}$ as follows:

Classical Type:

- (1) $\Delta_1 = \{5 - \text{regular triangular maps}\}$ (*elliptic*);
- (2) $\Delta_2 = \{6 - \text{regular triangular maps}\}$ (*euclid*);

(3) $\Delta_3 = \{7 - \text{regular triangular maps}\}$ (hyperbolic).

Smarandachely Type:

(4) $\Delta_4 = \{\text{triangular maps with vertex valency 5 and 6}\}$ (euclid-elliptic);

(5) $\Delta_5 = \{\text{triangular maps with vertex valency 5 and 7}\}$ (elliptic-hyperbolic);

(6) $\Delta_6 = \{\text{triangular maps with vertex valency 6 and 7}\}$ (euclid-hyperbolic);

(7) $\Delta_7 = \{\text{triangular maps with vertex valency 5, 6 and 7}\}$ (mixed).

We prove each of these types is not empty following.

Theorem 9.2.3 For classical types $\Delta_1 - \Delta_3$, there are

(1) $\Delta_1 = \{O_{20}, P_{10}\}$;

(2) $\Delta_2 = \{T_i, K_j, 1 \leq i, j \leq +\infty\}$;

(3) $\Delta_3 = \{H_i, 1 \leq i \leq +\infty\}$,

where O_{20}, P_{10} are shown in Fig.9.2.1, T_3, K_3 are shown in Fig.9.2.2 and H_i is the Hurwitz maps, i.e., triangular maps of valency 7.

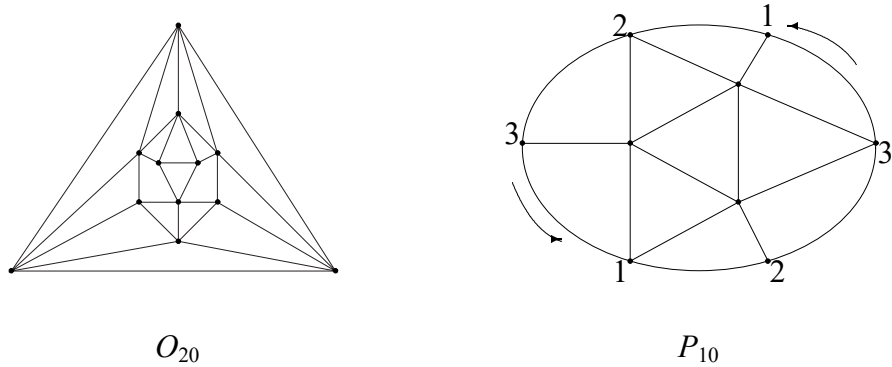

Fig.9.2.1

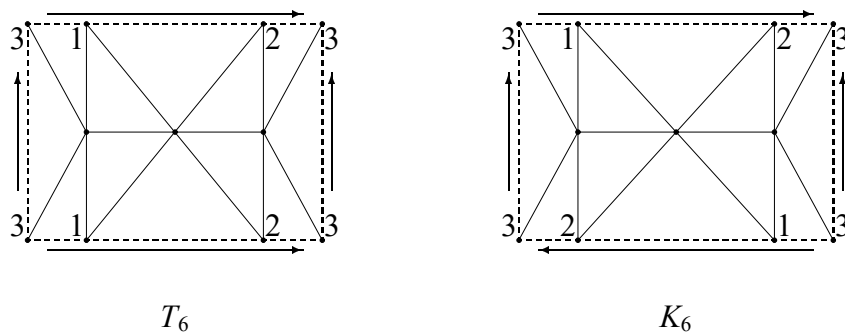

Fig.9.2.2

Proof If M is a k -regular triangulation, we get that $2\varepsilon(M) = 3\phi(M) = k\nu(M)$. Whence, we have

$$\varepsilon(M) = \frac{3\phi(M)}{2} \quad \text{and} \quad \nu(M) = \frac{3\varepsilon(M)}{k}.$$

By the Euler-Poincare formula, we know that

$$\chi(M) = \nu(M) - \varepsilon(M) + \phi(M) = \left(\frac{3}{k} - \frac{1}{2}\right)\phi(M).$$

If M is elliptic, then $k = 5$. Whence, $\chi(M) = \frac{\phi(M)}{10} > 0$. Therefore, if M is orientable, then $\chi(M) = 2$, Whence, $\phi(M) = 20$, $\nu(M) = 12$ and $\varepsilon(M) = 30$, which is just the map O_{20} . If M is non-orientable, then $\chi(M) = 1$, Whence, $\phi(M) = 10$, $\nu(M) = 6$ and $\varepsilon(M) = 15$, which is the map P_{10} .

If M is Euclidean, then $k = 6$. Thus $\chi(M) = 0$, i.e., M is a 6-regular triangulation T_i or K_j for some integer i or j on the torus or Klein bottle, which is inf nite.

If M is hyperbolic, then $k = 7$. Whence, $\chi(M) < 0$. M is a 7-regular triangulation, i.e., the Hurwitz map. According to the results in [Sur1], there are inf nite Hurwitz maps on surfaces. This completes the proof. \square

For these Smarandache Types, the situation is complex. But we can also obtain the enumeration results for each of the types $\Delta_4 - \Delta_7$. First, we prove a condition for the numbers of vertex valency 5 with that of 7.

Lemma 9.2.1 *Let $C(T, n)$ be an Iseri's manifold. Then*

$$v_7 \geq v_5 + 2$$

if $\chi(C(T, n)) \leq -1$ and

$$v_7 \leq v_5 - 2$$

if $\chi(C(T, n)) \geq 1$, where v_i denotes the number of vertices of valency i in $C(T, n)$.

Proof Notice that we have know

$$\varepsilon(C(T, n)) = \frac{-\chi(C(T, n))}{\frac{1}{3} - \frac{2}{k}},$$

where k is the average valency of vertices in $C(T, n)$. Since

$$k = \frac{5v_5 + 6v_6 + 7v_7}{v_5 + v_6 + v_7}$$

and $\varepsilon(C(T, n)) \geq 3$. Consequently, we get that

(1) If $\chi(C(T, n)) \leq -1$, then

$$\frac{1}{3} - \frac{2v_5 + 2v_6 + 2v_7}{5v_5 + 6v_6 + 7v_7} > 0,$$

i.e., $v_7 \geq v_5 + 1$. Now if $v_7 = v_5 + 1$, then

$$5v_5 + 6v_6 + 7v_7 = 12v_5 + 6v_6 + 7 \equiv 1(\text{mod}2).$$

Contradicts to the fact that

$$\sum_{v \in V(G)} \rho_G(v) = 2\varepsilon(G) \equiv 0(\text{mod}2)$$

for a graph G . Whence there must be

$$v_7 \geq v_5 + 2.$$

(2) If $\chi(C(T, n)) \geq 1$, then

$$\frac{1}{3} - \frac{2v_5 + 2v_6 + 2v_7}{5v_5 + 6v_6 + 7v_7} < 0,$$

i.e., $v_7 \leq v_5 - 1$. Now if $v_7 = v_5 - 1$, then

$$5v_5 + 6v_6 + 7v_7 = 12v_5 + 6v_6 - 7 \equiv 1(\text{mod}2).$$

Also contradicts to the fact that

$$\sum_{v \in V(G)} \rho_G(v) = 2\varepsilon(G) \equiv 0(\text{mod}2)$$

for a graph G . Whence, there must be

$$v_7 \leq v_5 - 2.$$

□

Corollary 9.2.1 *There are no Iseri's manifolds $C(T, n)$ such that*

$$|v_7 - v_5| \leq 1,$$

where v_i denotes the number of vertices of valency i in $C(T, n)$.

Define an operator $\Theta : M \rightarrow M^*$ on a triangulation M of a surface by

Choose each midpoint on each edge in M and connect the midpoint in each triangle as shown in Fig.9.2.3. Then the resultant M^* is a triangulation of the same surface and the valency of each new vertex is 6.

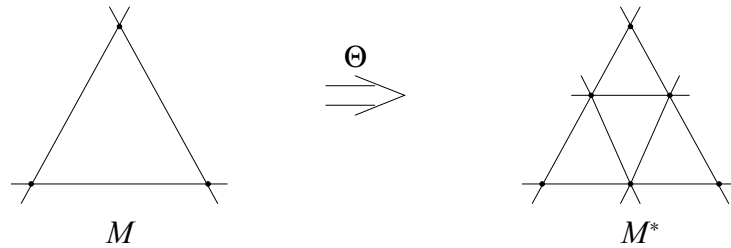

Fig. 9.2.3

Then we get the following result.

Theorem 9.2.4 For these Smarandache Types Δ_4 - Δ_7 , there are

- (1) $|\Delta_5| \geq 2$;
- (2) Each of $|\Delta_4|$, $|\Delta_6|$ and $|\Delta_7|$ is infinite.

Proof For $M \in \Delta_4$, let k be the average valency of vertices in M . Since

$$k = \frac{5v_5 + 6v_6}{v_5 + v_6} < 6 \quad \text{and} \quad \varepsilon(M) = \frac{-\chi(M)}{\frac{1}{3} - \frac{2}{k}},$$

we have that $\chi(M) \geq 1$. Calculation shows that $v_5 = 6$ if $\chi(M) = 1$ and $v_5 = 12$ if $\chi(M) = 2$. We can construct a triangulation with vertex valency 5, 6 on the plane and the projective plane in Fig.9.2.4.

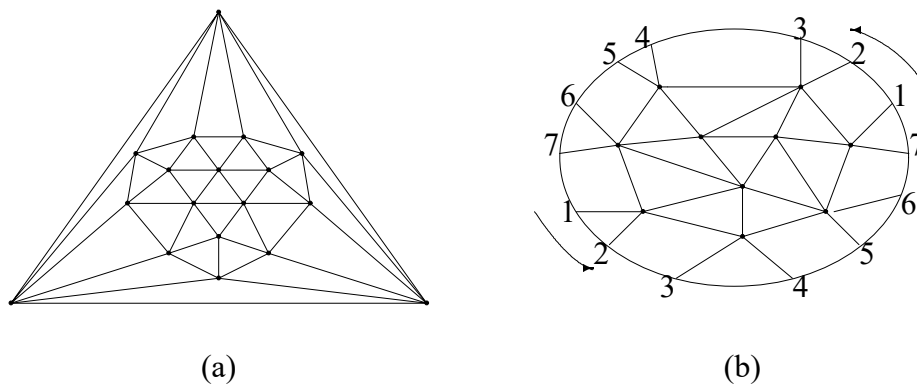

Fig.9.2.4

Now let M be a map in Fig.9.2.4. Then M^Θ is also a triangulation of the same surface

with vertex valency 5, 6 and $M^\Theta \neq M$. Whence, $|\Delta_4|$ is infinite.

For $M \in \Delta_5$, by the Lemma 9.2.1, we know that $v_7 \leq v_5 - 2$ if $\chi(M) \geq 1$ and $v_7 \geq v_5 + 2$ if $\chi(M) \leq -1$. We construct a triangulation on the plane and projective plane in Fig.9.2.5.

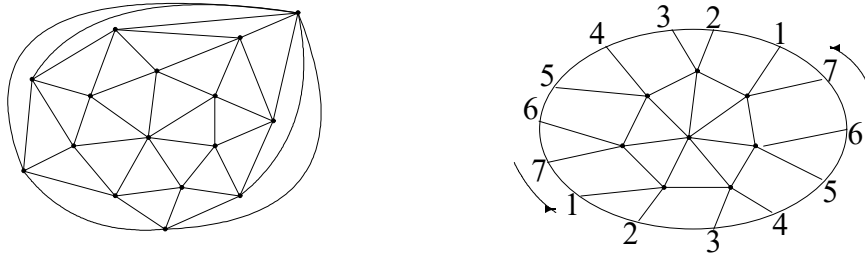

Fig.9.2.5

For $M \in \Delta_6$, we know that $k = \frac{6v_6 + 7v_7}{v_6 + v_7} > 6$. Whence, $\chi(M) \leq -1$. Since $3\phi(M) = 6v_6 + 7v_7 = 2\varepsilon(M)$, we get that

$$v_6 + v_7 - \frac{6v_6 + 7v_7}{2} + \frac{6v_6 + 7v_7}{3} = \chi(M).$$

Therefore, we have $v_7 = -\chi(M)$. Notice that there are infinite Hurwitz maps M on surfaces. Then the resultant triangular map M^* is a triangulation with vertex valency 6, 7 and $M^* \neq M$. Thus $|\Delta_6|$ is infinite.

For $M \in \Delta_7$, we construct a triangulation with vertex valency 5, 6, 7 in Fig.9.2.6.

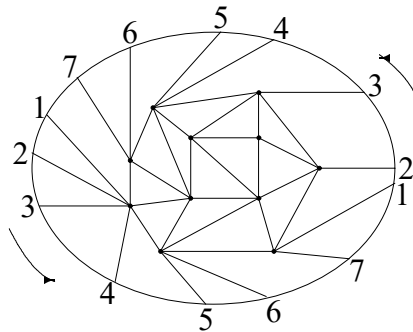

Fig.9.2.6

Let M be one of the maps in Fig.9.2.6. Then the action of Θ on M results infinite triangulations of valency 5, 6 or 7. This completes the proof. \square

For the set Δ_5 , we have the following conjecture.

Conjecture 9.2.1 *The number $|\Delta_5|$ is infinite.*

§9.3 ISOMETRIES OF SMARANDACHE 2-MANIFOLDS

9.3.1 Smarandachely Automorphism. Let $(M; \mathcal{A})$ be a Smarandache manifold. By definition a Smarandachely denied axiom $A \in \mathcal{A}$ can be considered as an action of A on subsets $S \subset M$, denoted by S^A . Now let $(M_1; \mathcal{A}_1)$ and $(M_2; \mathcal{A}_2)$ be two Smarandache manifolds, where $\mathcal{A}_1, \mathcal{A}_2$ are the Smarandachely denied axioms on manifolds M_1 and M_2 , respectively. They are said to be *isomorphic* if there is 1 – 1 mappings $\tau : M_1 \rightarrow M_2$ and $\sigma : \mathcal{A}_1 \rightarrow \mathcal{A}_2$ such that $\tau(S^A) = \tau(S)^{\sigma(A)}$ for $\forall S \subset M_1$ and $A \in \mathcal{A}_1$. Such a pair (τ, σ) is called an isomorphism between $(M_1; \mathcal{A}_1)$ and $(M_2; \mathcal{A}_2)$. Particularly, if $M_1 = M_2 = M$ and $\mathcal{A}_1 = \mathcal{A}_2 = \mathcal{A}$, such an isomorphism (τ, σ) is called a *Smarandachely automorphism* of (M, \mathcal{A}) . Clearly, all such automorphisms of (M, \mathcal{A}) form an group under the composition operation on τ for a given σ . Denoted by $\text{Aut}(M, \mathcal{A})$.

9.3.2 Isometry on \mathbf{R}^2 . Let X be a set and $\rho : X \times X \rightarrow \mathbf{R}$ a metric on X , i.e.,

- (1) $\rho(x, y) \geq 0$ for $x, y \in X$, and with equality hold if and only if $x = y$;
- (2) $\rho(x, y) = \rho(y, x)$ for $x, y \in X$;
- (3) $\rho(x, y) + \rho(y, z) \geq \rho(x, z)$ for $x, y, z \in X$.

A set X with such a metric ρ is called a *metric space*, denoted by (X, ρ) .

Example 9.3.1 Let $\mathbf{R}^2 = \{ (x, y) \mid x, y \in \mathbf{R} \}$. Define

$$\rho(\mathbf{x}_1, \mathbf{x}_2) = \sqrt{(x_1 - x_2)^2 + (y_1 - y_2)^2}$$

for $\mathbf{x}_1 = (x_1, y_1), \mathbf{x}_2 = (x_2, y_2) \in \mathbf{R}^2$. Then such a ρ is a metric on \mathbf{R}^2 . We verify conditions (1)-(3) in the following.

Clearly, conditions (1) and (2) are consequence of $x^2 = 0 \Rightarrow x = 0$ and $x^2 = (-x)^2$ for $x \in \mathbf{R}$. Now let $(x_1, y_1), (x_2, y_2)$ and (x_3, y_3) be three points on \mathbf{R}^2 with

$$\begin{aligned} (x_2, y_2) &= (x_1 + a_1, y_1 + b_1) \\ (x_3, y_3) &= (x_1 + a_1 + a_2, y_1 + b_1 + b_2) \end{aligned}$$

Then the condition (3) implies that

$$\sqrt{a_1^2 + b_1^2} + \sqrt{a_2^2 + b_2^2} \geq \sqrt{(a_1 + a_2)^2 + (b_1 + b_2)^2},$$

which can be verified to be hold immediately.

An *isometry* of a metric space (X, ρ) is a bijective mapping $\phi : X \rightarrow X$ that preserves distance, i.e., $\rho(\phi(\mathbf{x}), \phi(\mathbf{y})) = \rho(\mathbf{x}, \mathbf{y})$. Denote by $\text{Isom}(X, \rho)$ the set of all isometries of (X, ρ) . Then we know the following.

Theorem 9.3.1 *Isom(X, ρ) is a group under the composition operation of mapping.*

Proof Clearly, $1_X \in \text{Isom}(X)$ and if $\phi \in \text{Isom}(X)$, then $\phi^{-1} \in \text{Isom}(X)$. Furthermore, if $\phi_1, \phi_2 \in \text{Isom}(X)$, by definition we know that

$$\rho(\phi_1\phi_2(\mathbf{x}), \phi_1\phi_2(\mathbf{y})) = \rho(\phi_2(\mathbf{x}), \phi_2(\mathbf{y})) = \rho(\mathbf{x}, \mathbf{y}).$$

Whence, $\phi_1\phi_2$ is also an isometry, i.e., $\phi_1\phi_2 \in \text{Isom}(X)$. So $\text{Isom}(X, \rho)$ is a group. □

Let Δ, Δ' be two triangles on \mathbf{R}^2 . They are said to be *congruent* if we can label their vertices, for instance $\Delta = ABC$ and $\Delta' = A'B'C'$ such that

$$\begin{aligned} |AB| &= |A'B'|, \quad |BC| = |B'C'|, \quad |CA| = |C'A'|, \\ \angle CAB &= \angle C'A'B', \quad \angle ABC = \angle A'B'C', \quad \angle BCA = \angle B'C'A'. \end{aligned}$$

Theorem 9.3.2 *Let ϕ be an isometry on R². Then ϕ maps a triangle to its a congruent triangle, preserves angles and maps lines to lines.*

Proof Let Δ be a triangle with vertex labels A, B and C on \mathbf{R}^2 . Then $\phi(\Delta)$ is congruent with Δ by the definition of isometry.

Notice that an angle $\angle < \pi$ and an angle $\angle > \pi$ can be realized respectively as an angle $\angle CAB$, or an exterior angle of a triangle ABC . We have known that $\phi(ABC)$ is congruent with ABC . Consequently, $\angle\phi(C)\phi(A)\phi(B) = \angle CAB$, i.e., ϕ preserves angles in \mathbf{R}^2 . If $\angle = \pi$, this result follows the law of trichotomy.

For a line L in \mathbf{R}^2 , let B, C be two distinct points on L , and let L' be the line through points $B' = \phi(B)$ and $C' = \phi(C)$. Then for any point $A \in \mathbf{R}^2$, it follows that

$$\begin{aligned} \phi(A) \notin \phi(L) &\Leftrightarrow A \notin L \Leftrightarrow 0 \leq \angle CAB < \pi \\ &\Leftrightarrow 0 < \angle C'\phi(A)B' < \pi \Leftrightarrow \phi(A) \notin L'. \end{aligned}$$

Therefore, $\phi(L) = L'$. □

The behavior of an isometry is completely determined by its action on three non-collinear points shown in the next result.

Theorem 9.3.3 *An isometry of \mathbf{R}^2 is determined by its action on three non-collinear points.*

Proof Let A, B, C be three non-collinear points on \mathbf{R}^2 and let $\phi_1, \phi_2 \in \text{Isom}(\mathbf{R}^2)$ have the same action on A, B, C . Thus

$$\phi_1(A) = \phi_2(A), \quad \phi_1(B) = \phi_2(B), \quad \phi_1(C) = \phi_2(C).$$

i.e.,

$$\phi_2^{-1}\phi_1(A) = A, \quad \phi_2^{-1}\phi_1(B) = B, \quad \phi_2^{-1}\phi_1(C) = C.$$

Whence, we must show that if there exists $\varphi \in \text{Isom}(\mathbf{R}^2)$ such that $\varphi(A) = A, \varphi(B) = B, \varphi(C) = C$, then $\varphi(P) = P$ for each point $P \in \mathbf{R}^2$.

In fact, since φ preserves distance and $\varphi(A) = A$, it follows that P and $\varphi(P)$ are equidistant from A . Thus $\varphi(P)$ lies on the circle \mathcal{C}_1 centered at A with radius $|AP|$. Similarly, $\varphi(P)$ also lies on the circle \mathcal{C}_2 centered at B with radius $|BP|$. Whence, $\varphi(P) \in \mathcal{C}_1 \cap \mathcal{C}_2$.

Because \mathcal{C}_1 and \mathcal{C}_2 are not concentric, they intersect in at most two points, such as those shown in Fig.9.3.1 following.

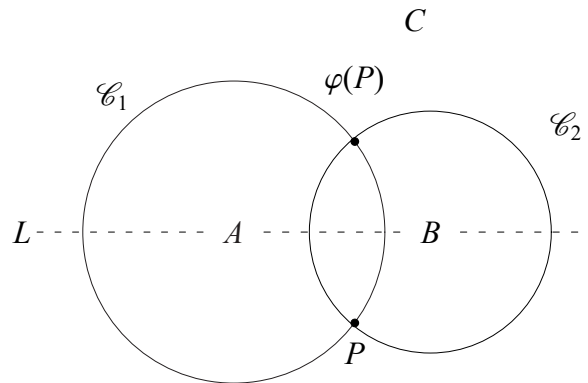

Fig.9.3.1

Notice that P lies on both of \mathcal{C}_1 and \mathcal{C}_2 . Thus $\mathcal{C}_1 \cap \mathcal{C}_2 \neq \emptyset$. Therefore, $|\mathcal{C}_1 \cap \mathcal{C}_2| = 1$ or 2 . If $|\mathcal{C}_1 \cap \mathcal{C}_2| = 1$, then $\varphi(P) = P$. If $|\mathcal{C}_1 \cap \mathcal{C}_2| = 2$, let L be the line through A, B , which is the perpendicular bisector of $\varphi(P)$ and P , such as those shown in Fig.9.3.1. By assumption, $C \notin L$, we get that $|CP| \neq |C\varphi(P)|$. Contradicts to the fact that $P, \varphi(P)$ are equidistant from C . Whence $|\mathcal{C}_1 \cap \mathcal{C}_2| = 1$ and we get the conclusion. \square

There are three types of isometries on \mathbf{R}^2 listed in the following.

Translation \mathbb{T} . A translation T is a mapping that moves every point of \mathbf{R}^2 through a constant distance in a fixed direction, i.e.,

$$T_{a,b} : \mathbf{R}^2 \rightarrow \mathbf{R}^2, \quad (x_1, y_1) \rightarrow (x_1 + a, y_1 + b),$$

where (a, b) is a constant vector. Call the direction of (a, b) the *axis* of T and denoted by $T = T_{a,b}$.

Rotation \mathbb{R}_θ . A rotation R is a mapping that moves every point of \mathbf{R}^2 through a fixed angle about a fixed point, called the *center*. By taking the center O to be the origin of polar coordinates (r, θ) , a rotation $R_\theta : \mathbf{R}^2 \rightarrow \mathbf{R}^2$ is

$$R : (r, \theta) \rightarrow (r, \theta + \varpi),$$

where ϖ is a constant angle, $\varpi \in \mathbf{R} \pmod{2\pi}$. Denoted by $R = R_\theta$.

Reflection \mathbb{F} . A reflection F is a mapping that moves every point of \mathbf{R}^2 to its mirror-image in a fixed line. That line L is called the *axis* of F , denoted by $F = F(L)$. Thus for a point P in \mathbf{R}^2 , if $P \in L$, then $F(P) = P$, and if $P \notin L$, then $F(P)$ is the unique point in \mathbf{R}^2 such that L is the perpendicular bisector of P and $F(P)$.

Theorem 9.3.4 *For a chosen line L and a fixed point $O \in L$ in \mathbf{R}^2 , any element $\varphi \in \text{Isom}(\mathbf{R}^2)$ can written uniquely in the form*

$$\varphi = TRF^\epsilon,$$

where F denotes the reflection in L , $\epsilon = 0$ or 1 , R is the rotation centered at O , $T \in \mathbb{T}$, and the subgroup of orientation-preserving isometries of \mathbf{R}^2 consists of those φ with $\epsilon = 0$.

Proof Let T be the translation transferring O to $\varphi(O)$. Clearly, $T^{-1}\varphi(O) = O$. Now let $P \in L$ be a point with $P \neq O$. By definition,

$$0 < \rho(O, P) = \rho(T^{-1}\varphi(O), T^{-1}\varphi(P)) = \rho(O, T^{-1}\varphi(P)),$$

there exists a rotation R centered at O transferring P to $T^{-1}\varphi(P)$. Thus $R^{-1}T^{-1}\varphi$ fixes both points O and P .

Finally, let $Q \notin L$ be a point. Then points Q and $R^{-1}T^{-1}\varphi(Q)$ are equidistant both from points O and P . Similar to the proof of Theorem 9.3.3, we know that points Q and

$R^{-1}T^{-1}\varphi(Q)$ are either equal or mirror-images in L . Choose $\epsilon = 0$ if $Q = R^{-1}T^{-1}\varphi(Q)$ and $\epsilon = 1$ if $Q \neq R^{-1}T^{-1}\varphi(Q)$. Then the isometry $F^\epsilon R^{-1}T^{-1}\varphi$ fixes non-collinear points O , P and Q . According to Theorem 9.3.3, there must be

$$F^\epsilon R^{-1}T^{-1}\varphi = 1_{\mathbf{R}^2}.$$

Thus

$$\varphi = TRF^\epsilon.$$

For the uniqueness of the form, assume that

$$TRF^\epsilon = T'R'F^\delta,$$

where $\epsilon, \delta \in \{0, 1\}$, $T, T' \in \mathbb{T}$ and $R, R' \in \mathbb{R}_O$. Clearly, $\epsilon = \delta$ by previous argument. Cancelling F if necessary, we get that $TR = T'R'$. But then $(T')^{-1}T = R'R^{-1}$ belongs to $\mathbb{R}_O \cap \mathbb{T}$, i.e., a translation fixes point O . Whence, it is the identity mapping 1_r . Thus $T = T'$ and $R = R'$.

Notice that T, R are orientation-preserving but F is orientation-reversing. It follows that TRF^ϵ is orientation-preserving or orientation-reversing according to $\epsilon = 0$ or 1 . This completes the proof. \square

9.3.3 Finitely Smarandache 2-Manifold. A point P on a Euclidean plane \mathbf{R}^2 is in fact associated with a real number π . Generally, we consider a function $\mu : \mathbf{R}^2 \rightarrow [0, 2\pi)$ and classify points on \mathbf{R}^2 into three classes following:

Elliptic Type. All points $P \in \mathbf{R}^2$ with $\mu(P) < \pi$.

Euclidean Type. All points $Q \in \mathbf{R}^2$ with $\mu(P) = \pi$.

Hyperbolic Type. All points $U \in \mathbf{R}^2$ with $\mu(P) > \pi$.

Such a Euclidean plane \mathbf{R}^2 with elliptic or hyperbolic points is called a *Smarandache plane*, denoted by (\mathbf{R}^2, μ) and these elliptic or hyperbolic points are called *non-Euclidean points*. A finitely Smarandache plane is such a Smarandache plane with finite non-Euclidean points.

Let L be an s-line in a Smarandache plane (\mathbf{R}^2, μ) with non-Euclidean points A_1, A_2, \dots, A_n for an integer $n \geq 0$. Its *curvature* $R(L)$ is defined by

$$R(L) = \sum_{i=1}^n (\pi - \mu(A_i)).$$

An s-line L is called *Euclidean* or *non-Euclidean* if $R(L) = \pm 2\pi$ or $\neq \pm 2\pi$. The following result characterizes s-lines on (\mathbf{R}^2, μ) .

Theorem 9.3.5 *An s-line without self-intersections is closed if and only if it is Euclidean.*

Proof Let (\mathbf{R}^2, μ) be a Smarandache plane and let L be a closed s-line without self-intersections on (\mathbf{R}^2, μ) with vertices A_1, A_2, \dots, A_n . From the Euclid geometry on plane, we know that the angle sum of an n -polygon is $(n - 2)\pi$. Whence, the curvature $R(L)$ of s-line L is $\pm 2\pi$ by definition, i.e., L is Euclidean.

Now if an s-line L is Euclidean, then $R(L) = \pm 2\pi$ by definition. Thus there exist non-Euclidean points B_1, B_2, \dots, B_n such that

$$\sum_{i=1}^n (\pi - \mu(B_i)) = \pm 2\pi.$$

Whence, L is nothing but an n -polygon with vertices B_1, B_2, \dots, B_n on \mathbf{R}^2 . Therefore, L is closed without self-intersection. \square

Furthermore, we find conditions for an s-line to be that of regular polygon on \mathbf{R}^2 following.

Corollary 9.3.1 *An s-line without self-intersection passing through non-Euclidean points A_1, A_2, \dots, A_n is a regular polygon if and only if all points A_1, A_2, \dots, A_n are elliptic with*

$$\mu(A_i) = \left(1 - \frac{2}{n}\right)\pi$$

or all A_1, A_2, \dots, A_n are hyperbolic with

$$\mu(A_i) = \left(1 + \frac{2}{n}\right)\pi$$

for integers $1 \leq i \leq n$.

Proof If an s-line L without self-intersection passing through non-Euclidean points A_1, A_2, \dots, A_n is a regular polygon, then all points A_1, A_2, \dots, A_n must be elliptic (hyperbolic) and calculation easily shows that

$$\mu(A_i) = \left(1 - \frac{2}{n}\right)\pi \text{ or } \mu(A_i) = \left(1 + \frac{2}{n}\right)\pi$$

for integers $1 \leq i \leq n$ by Theorem 9.3.5. On the other hand, if L is an s-line passing through elliptic (hyperbolic) points A_1, A_2, \dots, A_n with

$$\mu(A_i) = \left(1 - \frac{2}{n}\right)\pi \text{ or } \mu(A_i) = \left(1 + \frac{2}{n}\right)\pi$$

for integers $1 \leq i \leq n$, then it is closed by Theorem 9.3.5. Clearly, L is a regular polygon with vertices A_1, A_2, \dots, A_n . □

Let ρ be the metric on \mathbf{R}^2 defined in Example 9.3.1. An isometry on a Smarandache plane (\mathbf{R}^2, μ) is such an isometry $\tau : \mathbf{R}^2 \rightarrow \mathbf{R}^2$ with $\mu(\tau(x)) = \mu(x)$ for $x \in \mathbf{R}^2$. Clearly, all isometries on (\mathbf{R}^2, μ) also form a group under the composition operation, denoted by $\text{Isom}(\mathbf{R}^2, \mu)$. Corollary 9.3.1 enables one to determine isometries of finitely Smarandache planes following.

Theorem 9.3.6 *Let (\mathbf{R}^2, μ) be a finitely Smarandache plane. Then any isometry \mathcal{T} of (\mathbf{R}^2, μ) is generated by a rotation R and a reflection F on \mathbf{R}^2 , i.e., $\mathcal{T} = RF^\epsilon$ with $\epsilon = 0, 1$.*

Proof Let \mathcal{T} be an isometry on a finitely Smarandache plane (\mathbf{R}^2, μ) . Then for a point A on (\mathbf{R}^2, μ) , the type of A and $\mathcal{T}(A)$ must be the same with $\mu(\mathcal{T}(A)) = \mu(A)$ by definition. Whence, if there is constant vector $(a, b) \in \mathbf{R}^2$ such that $T_{a,b} : (\mathbf{R}^2, \mu) \rightarrow (\mathbf{R}^2, \mu)$ determined by

$$(x, y) \rightarrow (x + a, y + b)$$

is an isometry and A a non-Euclidean point in (\mathbf{R}^2, μ) , then there are infinite non-Euclidean points $A, T_{a,b}(A), T_{a,b}^2(A), \dots, T_{a,b}^n(A), \dots$, for integers $n \geq 1$, contradicts the assumption that (\mathbf{R}^2, μ) is finitely Smarandache. Thus \mathcal{T} can be only generated by a rotation and a reflection. Thus $\mathcal{T} = RF^\epsilon$. Conversely, we are easily constructing a rotation R and a reflection F on (\mathbf{R}^2, μ) . For example, a rotation $R : \theta \rightarrow \theta + \pi/2$ centered at O and a reflection F in line L on a finitely Smarandache plane (\mathbf{R}^2, μ) is shown in Fig.9.3.2 (a) and (b) in which the labeling number on a point P is $\mu(P)$ if $\mu(P) \neq \pi$. Otherwise, $\mu(P) = \pi$ if there are no a label for $p \in \mathbf{R}^2$. □

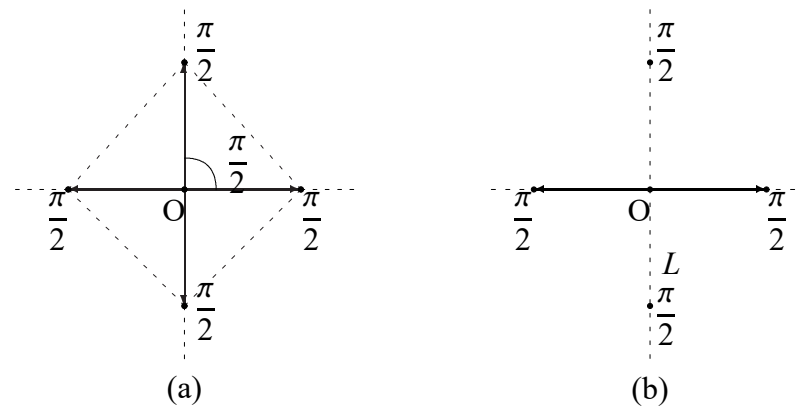

Fig.9.3.2

The classification on finitely Smarandache planes is the following result.

Theorem 9.3.7 *Let $k|n$ or $k|(n - 1)$ and $0 < d_1 < d_2 < \dots < d_k$ an integer sequence. Then there exist one and only one finitely Smarandache plane (\mathbf{R}^2, μ) with n non-Euclidean points A_1, A_2, \dots, A_n such that*

$$\text{Isom}(\mathbf{R}^2, \mu) \simeq D_{2k}$$

and

$$\rho(O, A_{i_j}) = d_j, \quad \mu(A_{i_j}) = \left(1 - \frac{2}{k}\right), \quad (j - 1)k + 1 \leq i_j \leq jk; \quad 1 \leq j \leq \frac{n}{k}$$

if $k|n$, or

$$\rho(O, A_{i_j}) = d_j, \quad \mu(A_{i_j}) = \left(1 - \frac{2}{k}\right), \quad (j - 1)k + 1 \leq i_j \leq jk; \quad 1 \leq j \leq \frac{n - 1}{k}$$

with $O = A_n$ if $k|(n - 1)$.

Proof Choose $\varpi = \frac{2\pi}{k}$ and a rotation $R_\varpi : (r, \theta) \rightarrow (r, \theta + \varpi)$ centered at O . Assume $k|n$. Let $\mathcal{P}_1, \mathcal{P}_2, \dots, \mathcal{P}_{\frac{n}{k}}$ be $\frac{n}{k}$ concentrically regular k -polygons at O with radius d_1, d_2, \dots, d_k . Place points A_1, A_2, \dots, A_k on vertices of $\mathcal{P}_1, A_{k+1}, A_{k+2}, \dots, A_{2k}$ on vertices of \mathcal{P}_2, \dots , and $A_{n-k+1}, A_{n-k+2}, \dots, A_n$ on vertices of $\mathcal{P}_{\frac{n}{k}}$, such as those shown in Fig.9.3.3.

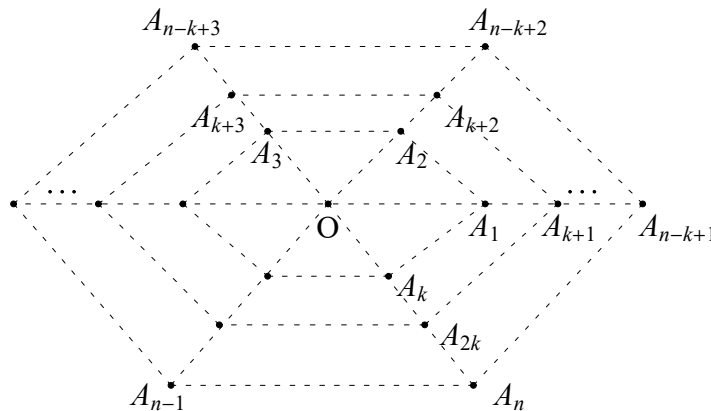

Fig.9.3.3

Then we are easily know that

$$\text{Isom}(\mathbf{R}^2, \mu) \simeq D_{2k}.$$

For the uniqueness, let $\mathcal{P}'_1, \mathcal{P}'_2, \dots, \mathcal{P}'_{\frac{n}{k}}$ be $\frac{n}{k}$ concentrically regular k -polygons at O' with radius d_1, d_2, \dots, d_k and vertices A'_1, A'_2, \dots, A'_n labeled likely that in Fig.9.3.3.

Choose $T_{O',O}$ being a translation moving point O' to O and $R_{A'_1,A_1}$ a rotation centered at O moving A'_1 to A_1 . Transfer it first by $T_{O',O}$ and then by $R_{A'_1,A_1}$. Then each non-Euclidean point A'_i coincides with A_i for integers $1 \leq i \leq n$, i.e., they are the same Smarandache plane (\mathbf{R}^2, μ) .

Similarly, we can get the result for the case of $k|(n-1)$ by putting $O = A_n$. \square

9.3.4 Smarandachely Map. Let S be a surface associated with $\mu : x \rightarrow [0, 2\pi)$ for each point $x \in S$, denoted by (S, μ) . A point $x \in S$ is called *elliptic*, *Euclidean* or *hyperbolic* if it has a neighborhood U_x homeomorphic to a 2-disk neighborhood of an elliptic, Euclidean or a hyperbolic point in (\mathbf{R}^2, μ) . Similarly, a line on (S, μ) is called an s-line.

A map $M = (\mathcal{X}_{\alpha,\beta}, \mathcal{P})$ on (S, μ) is called *Smarandachely* if all of its vertices is elliptic (hyperbolic). Notice that these pendent vertices is not important because it can be always Euclidean or non-Euclidean. We concentrate our attention to non-separated maps. Such maps always exist circuit-decompositions. The following result characterizes Smarandachely maps.

Theorem 9.3.8 *A non-separated planar map M is Smarandachely if and only if there exist a directed circuit-decomposition*

$$E_{\frac{1}{2}}(M) = \bigoplus_{i=1}^s E(\vec{C}_i)$$

of M such that one of the linear systems of equations

$$\sum_{v \in V(\vec{C}_i)} (\pi - x_v) = 2\pi, \quad 1 \leq i \leq s$$

or

$$\sum_{v \in V(\vec{C}_i)} (\pi - x_v) = -2\pi, \quad 1 \leq i \leq s$$

is solvable, where $E_{\frac{1}{2}}(M)$ denotes the set of semi-arcs of M .

Proof If M is Smarandachely, then each vertex $v \in V(M)$ is non-Euclidean, i.e., $\mu(v) \neq \pi$. Whence, there exists a directed circuit-decomposition

$$E_{\frac{1}{2}}(M) = \bigoplus_{i=1}^s E(\vec{C}_i)$$

of semi-arcs in M such that each of them is an s-line in (\mathbf{R}^2, μ) . Applying Theorem 9.3.5, we know that

$$\sum_{v \in V(\vec{C}_i)} (\pi - \mu(v)) = 2\pi \text{ or } \sum_{v \in V(\vec{C}_i)} (\pi - \mu(v)) = -2\pi$$

for each circuit C_i , $1 \leq i \leq s$. Thus one of the linear systems of equations

$$\sum_{v \in V(\vec{C}_i)} (\pi - x_v) = 2\pi, \quad 1 \leq i \leq s \text{ or } \sum_{v \in V(\vec{C}_i)} (\pi - x_v) = -2\pi, \quad 1 \leq i \leq s$$

is solvable.

Conversely, if one of the linear systems of equations

$$\sum_{v \in V(\vec{C}_i)} (\pi - x_v) = 2\pi, \quad 1 \leq i \leq s \text{ or } \sum_{v \in V(\vec{C}_i)} (\pi - x_v) = -2\pi, \quad 1 \leq i \leq s$$

is solvable, define a mapping $\mu : \mathbf{R}^2 \rightarrow [0, 4\pi)$ by

$$\mu(x) = \begin{cases} x_v & \text{if } x = v \in V(M), \\ \pi & \text{if } x \notin V(M). \end{cases}$$

Then M is a Smarandachely map on (\mathbf{R}^2, μ) . This completes the proof. □

In Fig.9.3.4, we present an example of a Smarandachely planar maps with μ defined by numbers on vertices.

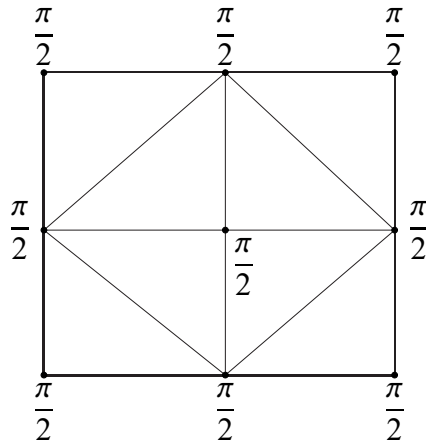

Fig.9.3.4

Let $\omega_0 \in (0, \pi)$. An s-line L is called *non-Euclidean of type ω_0* if $R(L) = \pm 2\pi \pm \omega_0$. Similar to Theorem 9.3.8, we can get the following result.

Theorem 9.3.9 *A non-separated map M is Smarandachely if and only if there exist a directed circuit-decomposition*

$$E_{\frac{1}{2}}(M) = \bigoplus_{i=1}^s E(\vec{C}_i)$$

of M into s -lines of type ω_0 , $\omega_0 \in (0, \pi)$ for integers $1 \leq i \leq s$ such that one of the linear systems of equations

$$\begin{aligned} \sum_{v \in V(\vec{C}_i)} (\pi - x_v) &= 2\pi - \omega_0, & 1 \leq i \leq s, \\ \sum_{v \in V(\vec{C}_i)} (\pi - x_v) &= -2\pi - \omega_0, & 1 \leq i \leq s, \\ \sum_{v \in V(\vec{C}_i)} (\pi - x_v) &= 2\pi + \omega_0, & 1 \leq i \leq s, \\ \sum_{v \in V(\vec{C}_i)} (\pi - x_v) &= -2\pi + \omega_0, & 1 \leq i \leq s \end{aligned}$$

is solvable.

9.3.5 Inf nitely Smarandache 2-Manifold. Notice that the function $\mu : \mathbf{R}^2 \rightarrow [0, 2\pi)$ is not continuous if there are only f nitely non-Euclidean points in (\mathbf{R}^2, μ) . We consider a continuous function $\mu : \mathbf{R}^2 \rightarrow [0, 2\pi)$ in this subsection, in which we meet inf nite non-Euclidean points.

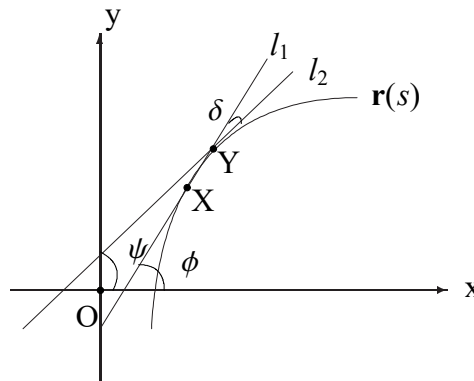

Fig.9.3.5

Let $\mathbf{r} : (a, b) \rightarrow \mathbf{R}^2$ be a plane curve C parametrized by arc length s , seeing Fig.9.3.5. Notice that $\mu(x)$ is an angle variant from π of a Euclidean point to $\mu(x)$ of a non-Euclidean

x in finitely Smarandache plane. Consider points moves from X to Y on $\mathbf{r}(s)$. Then the variant of angles from l_1 to l_2 is $\delta = \phi - \psi$. Thus $\mu(x) = \left. \frac{d\phi}{ds} \right|_x$. Define the curvature $R(C)$ of curve C by

$$R(C) = \int_C \frac{d\phi}{ds}.$$

Then if C is a closed curve on \mathbf{R}^2 without self-intersection, we get that

$$R(C) = \int_C \frac{d\phi}{ds} = \int_0^{2\pi r} \frac{d\phi}{ds} = \phi|_{2\pi r} - \phi|_0 = 2\pi.$$

Let $\mathbf{r} = (x(s), y(s))$ be a plane curve in \mathbf{R}^2 . Then

$$\frac{dx}{ds} = \cos \phi, \quad \frac{dy}{ds} = \sin \phi.$$

Consequently,

$$\frac{d^2x}{ds^2} = -\sin \phi \frac{d\phi}{ds} = -\frac{dy}{ds} \frac{d\phi}{ds}, \quad \frac{d^2y}{ds^2} = \cos \phi \frac{d\phi}{ds} = \frac{dx}{ds} \frac{d\phi}{ds}.$$

Multiplying the first formula by $-\frac{dy}{ds}$, the second by $\frac{dx}{ds}$ on both sides and plus them, we get that

$$\frac{d\phi}{ds} = \frac{dx}{ds} \frac{d^2y}{ds^2} - \frac{d^2x}{ds^2} \frac{dy}{ds}$$

by applying $\sin^2 \phi + \cos^2 \phi = 1$.

If $\mathbf{r}(t) = (x(t), y(t))$ is a plane curve C parametrized by t , where t maybe not the arc length, since

$$s = \int_0^t \sqrt{\left(\frac{dx}{dt}\right)^2 + \left(\frac{dy}{dt}\right)^2} dt,$$

we know that

$$\frac{ds}{dt} = \sqrt{\left(\frac{dx}{dt}\right)^2 + \left(\frac{dy}{dt}\right)^2}, \quad \frac{dx}{ds} = \left(\frac{dx}{dt}\right) / \left(\frac{ds}{dt}\right) \quad \text{and} \quad \frac{dy}{ds} = \left(\frac{dy}{dt}\right) / \left(\frac{ds}{dt}\right).$$

Whence,

$$\frac{d\phi}{ds} = \frac{\frac{dx}{dt} \frac{d^2y}{dt^2} - \frac{d^2x}{dt^2} \frac{dy}{dt}}{\left(\left(\frac{dx}{dt}\right)^2 + \left(\frac{dy}{dt}\right)^2\right)^{\frac{3}{2}}}.$$

Consequently, we get the following result by definition.

Theorem 9.3.10 *A curve C determined by $\mathbf{r} = (x(t), y(t))$ exists in a Smarandache plane (\mathbf{R}^2, μ) if and only if the following differential equation*

$$\frac{\frac{dx}{dt} \frac{d^2y}{dt^2} - \frac{d^2x}{dt^2} \frac{dy}{dt}}{\left(\left(\frac{dx}{dt} \right)^2 + \left(\frac{dy}{dt} \right)^2 \right)^{\frac{3}{2}}} = \mu$$

is solvable.

Example 9.3.1 Let $\mathbf{r}(\theta) = (\cos \theta, \sin \theta)$ ($0 \leq \theta \leq 2\pi$) be a unit circle C on \mathbf{R}^2 . Calculation shows that

$$\frac{dx}{d\theta} \frac{d^2y}{d\theta^2} - \frac{d^2x}{d\theta^2} \frac{dy}{d\theta} = \sin^2 \theta + \cos^2 \theta = 1$$

and

$$\left(\left(\frac{dx}{dt} \right)^2 + \left(\frac{dy}{dt} \right)^2 \right)^{\frac{3}{2}} = \sin^2 \theta + \cos^2 \theta = 1.$$

Whence, the circle C exists in a Smarandache plane (\mathbf{R}^2, μ) if and only if $\mu(x, y) = 1$ for $\forall (x, y) \in C$.

Example 9.3.2 Let $\mathbf{r}(t) = (a(t - \sin t), a(1 - \cos t))$ ($0 \leq t \leq 2\pi$) be a spiral line on \mathbf{R}^2 . Calculation shows that

$$\frac{d\phi}{ds} = -\frac{1}{4a \sin \frac{t}{2}}.$$

Whence, this spiral line exists in a Smarandache plane (\mathbf{R}^2, μ) if and only if

$$\mu(x, y) = -\frac{1}{4a \sin \frac{t}{2}}$$

for $x = a(t - \sin t)$ and $y = a(1 - \cos t)$.

Now we turn our attention to isometries of Smarandache plane (\mathbf{R}^2, μ) with infinitely Smarandache points. These points in (\mathbf{R}^2, μ) can be classified into three classes, i.e., *elliptic points* V_{el} , *Euclidean points* V_{eu} and *hyperbolic points* V_{hy} following:

$$V_{el} = \{ u \in (\mathbf{R}^2, \mu) \mid \mu(u) < \pi \},$$

$$V_{eu} = \{ v \in (\mathbf{R}^2, \mu) \mid \mu(v) = \pi \},$$

$$V_{hy} = \{ w \in (\mathbf{R}^2, \mu) \mid \mu(w) > \pi \}.$$

Theorem 9.3.11 *Let (\mathbf{R}, μ) be a Smarandache plane. If $V_{el} \neq \emptyset$ and $V_{hy} \neq \emptyset$, then $V_{eu} \neq \emptyset$.*

Proof By assumption, we can choose points $u \in V_{el}$ and $v \in V_{hy}$. Consider points on line segment uv in (\mathbf{R}^2, μ) . Notice that $\mu(u) < \pi$ and $\mu(v) > \pi$. Applying the connectedness of μ , there exists at least one point w , $w \in uv$ such that $\mu(w) = \pi$, i.e., $w \in V_{eu}$ by the intermediate value theorem on continuous function. Thus $V_{eu} \neq \emptyset$. \square

Corollary 9.3.2 *Let (\mathbf{R}, μ) be a Smarandache plane. If $V_{eu} = \emptyset$, then either all points of (\mathbf{R}^2, μ) are elliptic or hyperbolic.*

Corollary 9.3.2 enables one to classify Smarandache planes into classes following:

Euclidean Type. These Smarandache planes in which each point is Euclidean.

Elliptic Type. These Smarandache planes in which each point is elliptic.

Hyperbolic Type. These Smarandache planes in which each point is hyperbolic.

Smarandachely Type. These Smarandache planes in which there are elliptic, Euclidean and hyperbolic points simultaneously. This type can be further classified into three classes by Corollary 9.3.2:

- (S1) Such Smarandache planes just containing elliptic and Euclidean points;
- (S2) Such Smarandache planes just containing Euclidean and hyperbolic points;
- (S3) Such Smarandache planes containing elliptic, Euclidean and hyperbolic points.

By definition, these isometries of a Euclidean plane \mathbf{R}^2 , i.e., translation, rotation and reflection exist also in Smarandache planes (\mathbf{R}^2, μ) of elliptic and hyperbolic types if we let $\mu : \mathbf{R}^2 \rightarrow [0, \pi)$ be a constant $< \pi$ or $> \pi$. We concentrate our discussion on these Smarandachely types.

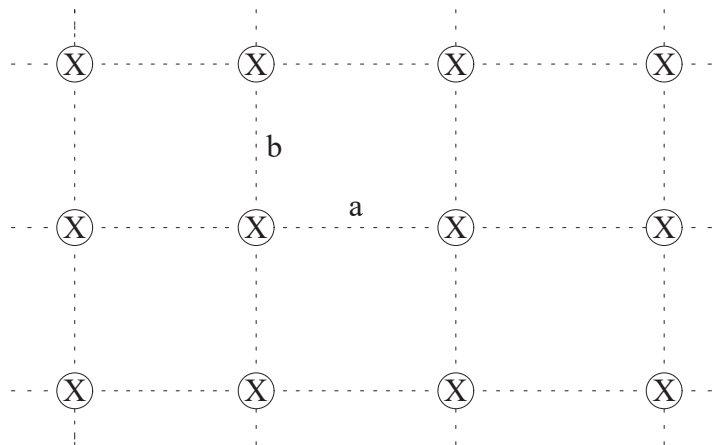

Fig.9.3.6

For convenience, we respectively colour the elliptic, Euclidean and hyperbolic points by colors red (R), yellow (Y) and white (W). For the cases (S1) or (S2), if there is an isometry of translation $T_{a,b}$ on (\mathbf{R}^2, μ) , then this Smarandache plane can be only the case shown in Fig.9.3.6, where $X = R$ or W and all other points colored by Y . Whence, if there is also a rotation R_θ on (\mathbf{R}^2, μ) , there must be $a = b$ and $\theta = \pi/2$ with center at X or the center of one square. In this case, we can easily find a reflection F in a horizontal or a vertical line passing through X . Whence, there are isometries of types translation, rotation and reflection in cases (S1) and (S2).

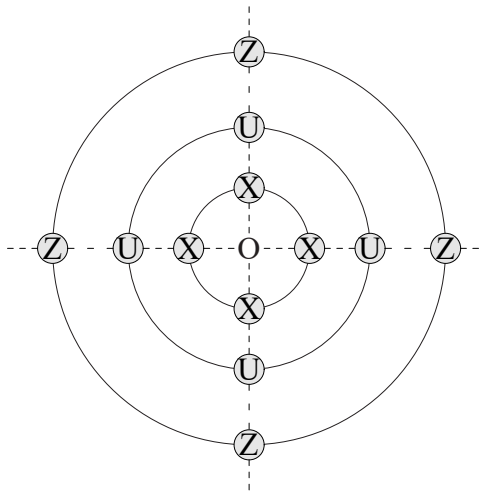

Fig.9.3.7

Furthermore, if there is an isometry of rotation R_θ on (\mathbf{R}^2, μ) , then this Smarandache plane can be only the case shown in Fig.9.3.7, where $X, U, Z \in \{R, W\}$ and all other points colored by Y . In this case, there are reflections F in lines passing through points O, X and there are translations $T_{a,b}$ on (\mathbf{R}^2, μ) only if $\theta = \pi/2$ and $a = b$.

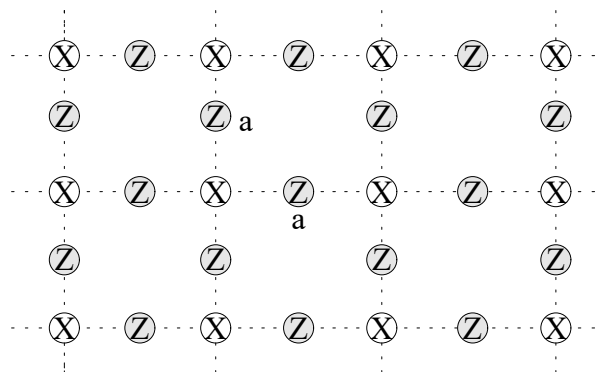

Fig.9.3.8

Consider the case of (S3). In this case, if there is an isometry of translation $T_{a,b}$ on (\mathbf{R}^2, μ) , then this Smarandache plane can be only the case shown in Fig.9.3.8, where $X \in \{\mathbf{R}, \mathbf{W}\}$, $Z \in \{\mathbf{R}, \mathbf{W}\} \setminus \{X\}$ and all other points colored by Y. Now if there is an isometry of rotation R_θ on (\mathbf{R}^2, μ) , there must be $a = b$ and $\theta = \pi/2$ centered at X, Z or the center of one square.

Similarly, if there is an isometry of rotation R_θ on (\mathbf{R}^2, μ) such as those shown in Fig.9.3.7. Then there are reflections F in lines passing through points O, X. In this case, there exist translations $T_{a,b}$ on (\mathbf{R}^2, μ) only if $\theta = \pi/2$ and $a = b$.

Summarizing up all the previous discussions, we get the following result on isometries of Smarandache planes (\mathbf{R}^2, μ) with a continuous function $\mu : \mathbf{R}^2 \rightarrow [0, 2\pi)$.

Theorem 9.3.12 *Let (\mathbf{R}^2, μ) be a Smarandachely type plane with $\mu : \mathbf{R}^2 \rightarrow [0, 2\pi)$ a continuous function. Then there are isometries of translation $T_{a,b}$ and rotations R_θ only if $a = b$ and $\theta = \pi/2$, and there are indeed such a Smarandache plane (\mathbf{R}^2, μ) with isometries of types translation, rotation and reflection concurrently in each of classes (S1)-(S3).*

§9.4 ISOMETRIES OF PSEUDO-EUCLIDEAN SPACES

9.4.1 Euclidean Space. A *Euclidean space* on a real vector space \mathbf{E} over a field \mathcal{F} is a mapping

$$\langle \cdot \cdot \rangle : \mathbf{E} \times \mathbf{E} \rightarrow \mathbf{R} \text{ with } (\bar{e}_1, \bar{e}_2) \rightarrow \langle \bar{e}_1, \bar{e}_2 \rangle \text{ for } \forall \bar{e}_1, \bar{e}_2 \in \mathbf{E}$$

such that for $\bar{e}, \bar{e}_1, \bar{e}_2 \in \mathbf{E}, \alpha \in \mathcal{F}$

$$(A1) \quad \langle \bar{e}, \bar{e}_1 + \bar{e}_2 \rangle = \langle \bar{e}, \bar{e}_1 \rangle + \langle \bar{e}, \bar{e}_2 \rangle;$$

$$(A2) \quad \langle \bar{e}, \alpha \bar{e}_1 \rangle = \alpha \langle \bar{e}, \bar{e}_1 \rangle;$$

$$(A3) \quad \langle \bar{e}_1, \bar{e}_2 \rangle = \langle \bar{e}_2, \bar{e}_1 \rangle;$$

$$(A4) \quad \langle \bar{e}, \bar{e} \rangle \geq 0 \text{ and } \langle \bar{e}, \bar{e} \rangle = 0 \text{ if and only if } \bar{e} = \bar{0}.$$

In an Euclidean space \mathbf{E} , the number $\sqrt{\langle \bar{e}, \bar{e} \rangle}$ is called its *norm*, denoted by $\|\bar{e}\|$ for abbreviation. It can be shown that

$$(1) \quad \langle \bar{0}, \bar{e} \rangle = \langle \bar{e}, \bar{0} \rangle = 0 \text{ for } \forall \bar{e} \in \mathbf{E};$$

$$(2) \quad \left\langle \sum_{i=1}^n x_i \bar{e}_i^1, \sum_{j=1}^m y_j \bar{e}_j^2 \right\rangle = \sum_{i=1}^n \sum_{j=1}^m x_i y_j \langle \bar{e}_i^1, \bar{e}_j^2 \rangle, \text{ for } \bar{e}_i^s \in \mathbf{E}, \text{ where } 1 \leq i \leq \max\{m, n\} \text{ and}$$

$s = 1$ or 2 .

Certainly, let $\bar{e}_1 = \bar{e}_2 = \bar{0}$ in (A1), we find that $\langle \bar{e}, \bar{0} \rangle = 0$. Applying (A3), we get that $\langle \bar{0}, \bar{e} \rangle = 0$. This is the formula in (1). For (2), applying (A1)-(A2), we know that

$$\begin{aligned} \left\langle \sum_{i=1}^n x_i \bar{e}_i^1, \sum_{j=1}^m y_j \bar{e}_j^2 \right\rangle &= \sum_{j=1}^m \left\langle \sum_{i=1}^n x_i \bar{e}_i^1, y_j \bar{e}_j^2 \right\rangle = \sum_{j=1}^m y_j \left\langle \sum_{i=1}^n x_i \bar{e}_i^1, \bar{e}_j^2 \right\rangle \\ &= \sum_{j=1}^m y_j \left\langle \bar{e}_j^2, \sum_{i=1}^n x_i \bar{e}_i^1 \right\rangle = \sum_{i=1}^n \sum_{j=1}^m x_i y_j \langle \bar{e}_j^2, \bar{e}_i^1 \rangle \\ &= \sum_{i=1}^n \sum_{j=1}^m x_i y_j \langle \bar{e}_i^1, \bar{e}_j^2 \rangle. \end{aligned}$$

9.4.2 Linear Isometry on Euclidean Space. Let \mathbf{E} be an n -dimensional Euclidean space with normal basis $\{\bar{e}_1, \bar{e}_2, \dots, \bar{e}_n\}$, i.e., $\langle \bar{e}_i, \bar{e}_j \rangle = 0$ and $|\bar{e}_i| = 1$ for integers $1 \leq i, j \leq n$. A linear isometry $T : \mathbf{E} \rightarrow \mathbf{E}$ is such a transformation that

$$T(c_1 \bar{e}_1 + c_2 \bar{e}_2) = c_1 T(\bar{e}_1) + c_2 T(\bar{e}_2) \quad \text{and} \quad \langle T(\bar{e}_1), T(\bar{e}_2) \rangle = \langle \bar{e}_1, \bar{e}_2 \rangle$$

for $\bar{e}_1, \bar{e}_2 \in \mathbf{E}$ and $c_1, c_2 \in \mathcal{F}$.

Theorem 9.4.1 Let \mathbf{E} be an n -dimensional Euclidean space with normal basis $\{\bar{e}_1, \bar{e}_2, \dots, \bar{e}_n\}$ and T a linear transformation on \mathbf{E} . Then T is an isometry on \mathbf{E} if and only if $\{T(\bar{e}_1), T(\bar{e}_2), \dots, T(\bar{e}_n)\}$ is a normal basis of \mathbf{E} .

Proof If T is a linear isometry, then $\langle T(\bar{e}_i), T(\bar{e}_j) \rangle = \langle \bar{e}_i, \bar{e}_j \rangle = \delta_{ij}$ by definition, where $\delta_{ij} = 1$ if $i = j$ and 0 otherwise. Whence, $\{T(\bar{e}_1), T(\bar{e}_2), \dots, T(\bar{e}_n)\}$ is a normal basis of \mathbf{E} .

Conversely, let $\{\bar{e}_1, \bar{e}_2, \dots, \bar{e}_n\}, \{T(\bar{e}_1), T(\bar{e}_2), \dots, T(\bar{e}_n)\}$ be normal basis of \mathbf{E} and $\bar{v} \in \mathbf{E}$. Without loss of generality, assume $\bar{v} = a_1 \bar{e}_1 + a_2 \bar{e}_2 + \dots + a_n \bar{e}_n$. Then we know that $T(\bar{v}) = a_1 T(\bar{e}_1) + a_2 T(\bar{e}_2) + \dots + a_n T(\bar{e}_n)$. Notice that $\langle T(\bar{e}_i), T(\bar{e}_j) \rangle = \delta_{i,j}$ and $\langle \bar{e}_i, \bar{e}_j \rangle = \delta_{ij}$ for integers $1 \leq i, j \leq n$. We get that

$$\langle \bar{v}, \bar{v} \rangle = a_1^2 + a_2^2 + \dots + a_n^2 \quad \text{and} \quad \langle T(\bar{v}), T(\bar{v}) \rangle = a_1^2 + a_2^2 + \dots + a_n^2.$$

Thus $\langle T(\bar{v}), T(\bar{v}) \rangle = \langle \bar{v}, \bar{v} \rangle$. □

A matrix $A = [a_{ij}]_{n \times n}$ is called orthogonal if $AA^t = I_{n \times n}$, where A^t is the transpose of A if

$$a_{i1}^2 + a_{i2}^2 + \dots + a_{in}^2 = 1 \quad \text{and} \quad a_{i1}a_{j1} + a_{i2}a_{j2} + \dots + a_{in}a_{jn} = 0$$

for integers $1 \leq i, j \leq n, i \neq j$.

Theorem 9.4.2 *Let \mathbf{E} be an n -dimensional Euclidean space with normal basis $\{\bar{\epsilon}_1, \bar{\epsilon}_2, \dots, \bar{\epsilon}_n\}$ and T a linear transformation on \mathbf{E} determined by $\bar{Y}^t = [a_{ij}]_{n \times n} \bar{X}^t$, where $\bar{X} = (\bar{\epsilon}_1, \bar{\epsilon}_2, \dots, \bar{\epsilon}_n)$ and $\bar{Y} = (T(\bar{\epsilon}_1), T(\bar{\epsilon}_2), \dots, T(\bar{\epsilon}_n))$. Then T is a linear isometry on \mathbf{E} if and only if $[a_{ij}]_{n \times n}$ is an orthogonal matrix.*

Proof If T is a linear isometry on \mathbf{E} , then $\langle T(\bar{\epsilon}_i), T(\bar{\epsilon}_j) \rangle = \langle \bar{\epsilon}_i, \bar{\epsilon}_j \rangle = \delta_{ij}$. Thus

$$a_{i1}a_{j1} + a_{i2}a_{j2} + \dots + a_{in}a_{jn} = \delta_{ij},$$

i.e., $[a_{ij}]_{n \times n}$ is an orthogonal matrix by definition.

On the other hand, if $[a_{ij}]_{n \times n}$ is an orthogonal matrix, then we easily know that $\{T(\bar{\epsilon}_1), T(\bar{\epsilon}_2), \dots, T(\bar{\epsilon}_n)\}$ is a normal basis of \mathbf{E} . Let $\bar{b} = b_1\bar{\epsilon}_1 + b_2\bar{\epsilon}_2 + \dots + b_n\bar{\epsilon}_n \in \mathbf{E}$. Then

$$T(\bar{b}) = T(b_1\bar{\epsilon}_1 + b_2\bar{\epsilon}_2 + \dots + b_n\bar{\epsilon}_n) = b_1T(\bar{\epsilon}_1) + b_2T(\bar{\epsilon}_2) + \dots + b_nT(\bar{\epsilon}_n).$$

Thus

$$\langle T(\bar{b}), T(\bar{b}) \rangle = b_1^2 + b_2^2 + \dots + b_n^2 = \langle \bar{b}, \bar{b} \rangle,$$

i.e., T is a linear isometry by definition. □

9.4.3 Isometry on Euclidean Space. Let \mathbf{E} be an n -dimensional Euclidean space with normal basis $\{\bar{\epsilon}_1, \bar{\epsilon}_2, \dots, \bar{\epsilon}_n\}$. As in the case of \mathbf{R}^2 by the distance-preserving property, any isometry on \mathbf{E} is a composition of three isometries on \mathbf{E} following:

Translation $\mathbb{T}_{\bar{e}}$. A mapping that moves every point (x_1, x_2, \dots, x_n) of \mathbf{E} by

$$T_{\bar{e}} : (x_1, x_2, \dots, x_n) \rightarrow (x_1 + e_1, x_2 + e_2, \dots, x_n + e_n),$$

where $\bar{e} = (e_1, e_2, \dots, e_n)$.

Rotation $\mathbb{R}_{\bar{\theta}}$. A mapping that moves every point of \mathbf{E} through a fixed angle about a fixed point. Similarly, taking the center O to be the origin of polar coordinates $(r, \phi_1, \phi_2, \dots, \phi_{n-1})$, a rotation $R_{\theta_1, \theta_2, \dots, \theta_{n-1}} : \mathbf{E} \rightarrow \mathbf{E}$ is

$$R_{\theta_1, \theta_2, \dots, \theta_{n-1}} : (r, \phi_1, \phi_2, \dots, \phi_{n-1}) \rightarrow (r, \phi_1 + \theta_1, \phi_2 + \theta_2, \dots, \phi_{n-1} + \theta_{n-1}),$$

where θ_i is a constant angle, $\theta_i \in \mathbf{R} \pmod{2\pi}$ for integers $1 \leq i \leq n-1$.

Reflection \mathbb{F} . A reflection F is a mapping that moves every point of \mathbf{E} to its mirror-image in a fixed Euclidean subspace E' of dimensional $n-1$, denoted by $F = F(E')$. Thus

for a point P in \mathbf{E} , $F(P) = P$ if $P \in E'$, and if $P \notin E'$, then $F(P)$ is the unique point in \mathbf{E} such that E' is the perpendicular bisector of P and $F(P)$.

The following result is easily to know similar to the proof of Theorem 9.3.4 by the distance-preserving property of isometries.

Theorem 9.4.3 *All isometries fixing the origin on a Euclidean space \mathbf{E} are linear.*

Whence, by Theorems 9.4.1-9.4.2, we get the following result.

Theorem 9.4.4 *Any isometry \mathcal{I} on a Euclidean space \mathbf{E} is affine, i.e.,*

$$\vec{Y}' = \lambda [a_{ij}]_{n \times n} \vec{X}' + \vec{e},$$

where λ is a constant number, $[a_{ij}]_{n \times n}$ a orthogonal matrix and \vec{e} a constant vector in \mathbf{E} .

9.4.4 Pseudo-Euclidean Space. Let $\mathbf{R}^n = \{(x_1, x_2, \dots, x_n)\}$ be a Euclidean space of dimensional n with a normal basis $\vec{e}_1 = (1, 0, \dots, 0)$, $\vec{e}_2 = (0, 1, \dots, 0)$, \dots , $\vec{e}_n = (0, 0, \dots, 1)$, $\vec{x} \in \mathbf{R}^n$ and $\vec{V}_{\vec{x}}, \vec{x}\vec{V}$ two vectors with end or initial point at \vec{x} , respectively. A *pseudo-Euclidean space* (\mathbf{R}^n, μ) is such a Euclidean space \mathbf{R}^n associated with a mapping $\mu : \vec{V}_{\vec{x}} \rightarrow \vec{x}\vec{V}$ for $\vec{x} \in \mathbf{R}^n$, such as those shown in Fig.9.4.1,

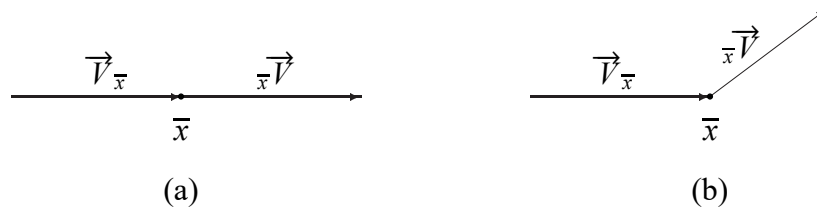

Fig.9.4.1

where $\vec{V}_{\vec{x}}$ and $\vec{x}\vec{V}$ are in the same orientation in case (a), but not in case (b). Such points in case (a) are called *Euclidean* and in case (b) *non-Euclidean*. A pseudo-Euclidean (\mathbf{R}^n, μ) is *fnite* if it only has fnite non-Euclidean points, otherwise, *infnite*.

Notice that a vector \vec{V} can be uniquely determined by the basis of \mathbf{R}^n . For $\vec{x} \in \mathbf{R}^n$, there are infnite orthogonal frames at point \vec{x} . Denoted by $O_{\vec{x}}$ the set of all normal bases at point \vec{x} . Then a *pseudo-Euclidean space* (\mathbf{R}, μ) is nothing but a Euclidean space \mathbf{R}^n associated with a linear mapping $\mu : \{\vec{e}_1, \vec{e}_2, \dots, \vec{e}_n\} \rightarrow \{\vec{e}'_1, \vec{e}'_2, \dots, \vec{e}'_n\} \in O_{\vec{x}}$ such that $\mu(\vec{e}_1) = \vec{e}'_1, \mu(\vec{e}_2) = \vec{e}'_2, \dots, \mu(\vec{e}_n) = \vec{e}'_n$ at point $\vec{x} \in \mathbf{R}^n$. Thus if $\vec{V}_{\vec{x}} = c_1\vec{e}_1 + c_2\vec{e}_2 + \dots + c_n\vec{e}_n$, then $\mu(\vec{x}\vec{V}) = c_1\mu(\vec{e}_1) + c_2\mu(\vec{e}_2) + \dots + c_n\mu(\vec{e}_n) = c_1\vec{e}'_1 + c_2\vec{e}'_2 + \dots + c_n\vec{e}'_n$.

and *Euclidean* if $R(L) = I_{n \times n}$, otherwise, *non-Euclidean*. It is obvious that a point in a Euclidean space \mathbf{R}^n is indeed Euclidean by this definition. Furthermore, we immediately get the following result for Euclidean s-lines in (\mathbf{R}^n, μ) .

Theorem 9.4.6 *Let (\mathbf{R}^n, μ) be a pseudo-Euclidean space and L an s-line in (\mathbf{R}^n, μ) passing through non-Euclidean points $\bar{x}_1, \bar{x}_2, \dots, \bar{x}_m \in \mathbf{R}^n$. Then L is closed if and only if L is Euclidean.*

Proof If L is a closed s-line, then L is consisted of vectors $\overrightarrow{\bar{x}_1\bar{x}_2}, \overrightarrow{\bar{x}_2\bar{x}_3}, \dots, \overrightarrow{\bar{x}_n\bar{x}_1}$. By definition,

$$\frac{\overrightarrow{\bar{x}_{i+1}\bar{x}_i}}{|\overrightarrow{\bar{x}_{i+1}\bar{x}_i}|} = \frac{\overrightarrow{\bar{x}_{i-1}\bar{x}_i}}{|\overrightarrow{\bar{x}_{i-1}\bar{x}_i}|} \mu(\bar{x}_i)$$

for integers $1 \leq i \leq m$, where $i + 1 \equiv (\text{mod } m)$. Consequently,

$$\overrightarrow{\bar{x}_1\bar{x}_2} = \overrightarrow{\bar{x}_1\bar{x}_2} \prod_{i=1}^m \mu(\bar{x}_i).$$

Thus $\prod_{i=1}^m \mu(\bar{x}_i) = I_{n \times n}$, i.e., L is Euclidean.

Conversely, let L be Euclidean, i.e., $\prod_{i=1}^m \mu(\bar{x}_i) = I_{n \times n}$. By definition, we know that

$$\frac{\overrightarrow{\bar{x}_{i+1}\bar{x}_i}}{|\overrightarrow{\bar{x}_{i+1}\bar{x}_i}|} = \frac{\overrightarrow{\bar{x}_{i-1}\bar{x}_i}}{|\overrightarrow{\bar{x}_{i-1}\bar{x}_i}|} \mu(\bar{x}_i), \quad \text{i.e.,} \quad \overrightarrow{\bar{x}_{i+1}\bar{x}_i} = \frac{|\overrightarrow{\bar{x}_{i+1}\bar{x}_i}|}{|\overrightarrow{\bar{x}_{i-1}\bar{x}_i}|} \overrightarrow{\bar{x}_{i-1}\bar{x}_i} \mu(\bar{x}_i)$$

for integers $1 \leq i \leq m$, where $i + 1 \equiv (\text{mod } m)$. Whence, if $\prod_{i=1}^m \mu(\bar{x}_i) = I_{n \times n}$, then there must be

$$\overrightarrow{\bar{x}_1\bar{x}_2} = \overrightarrow{\bar{x}_1\bar{x}_2} \prod_{i=1}^m \mu(\bar{x}_i).$$

Thus L consisted of vectors $\overrightarrow{\bar{x}_1\bar{x}_2}, \overrightarrow{\bar{x}_2\bar{x}_3}, \dots, \overrightarrow{\bar{x}_n\bar{x}_1}$ is a closed s-line in (\mathbf{R}^n, μ) . \square

Let $n = 2$. We consider the pseudo-Euclidean space (\mathbf{R}^2, μ) and find the rotation matrix $\mu(\bar{x})$ for points $\bar{x} \in \mathbf{R}^2$. Let $\theta_{\bar{x}}$ be the angle from \bar{e}_1 to $\mu\bar{e}_1$. Then it is easily to know that

$$\mu(\bar{x}) = \begin{pmatrix} \cos \theta_{\bar{x}} & \sin \theta_{\bar{x}} \\ \sin \theta_{\bar{x}} & -\cos \theta_{\bar{x}} \end{pmatrix}.$$

Now if an s-line L passing through non-Euclidean points $\bar{x}_1, \bar{x}_2, \dots, \bar{x}_m \in \mathbf{R}^2$, then Theorem 9.4.6 implies that

$$\begin{pmatrix} \cos \theta_{\bar{x}_1} & \sin \theta_{\bar{x}_1} \\ \sin \theta_{\bar{x}_1} & -\cos \theta_{\bar{x}_1} \end{pmatrix} \begin{pmatrix} \cos \theta_{\bar{x}_2} & \sin \theta_{\bar{x}_2} \\ \sin \theta_{\bar{x}_2} & -\cos \theta_{\bar{x}_2} \end{pmatrix} \dots \begin{pmatrix} \cos \theta_{\bar{x}_m} & \sin \theta_{\bar{x}_m} \\ \sin \theta_{\bar{x}_m} & -\cos \theta_{\bar{x}_m} \end{pmatrix} = I_{n \times n}.$$

Thus

$$\mu(\bar{x}) = \begin{pmatrix} \cos(\theta_{\bar{x}_1} + \theta_{\bar{x}_2} + \dots + \theta_{\bar{x}_m}) & \sin(\theta_{\bar{x}_1} + \theta_{\bar{x}_2} + \dots + \theta_{\bar{x}_m}) \\ \sin(\theta_{\bar{x}_1} + \theta_{\bar{x}_2} + \dots + \theta_{\bar{x}_m}) & \cos(\theta_{\bar{x}_1} + \theta_{\bar{x}_2} + \dots + \theta_{\bar{x}_m}) \end{pmatrix} = I_{n \times n}.$$

Whence, $\theta_{\bar{x}_1} + \theta_{\bar{x}_2} + \dots + \theta_{\bar{x}_m} = 2k\pi$ for an integer k . This fact is in agreement with that of Theorem 9.3.5.

An *embedded graph* G on \mathbf{R}^n is a 1 – 1 mapping $\tau : G \rightarrow \mathbf{R}^n$ such that for $\forall e, e' \in E(G)$, $\tau(e)$ has no self-intersection and $\tau(e), \tau(e')$ maybe only intersect at their end points. Such an embedded graph G in \mathbf{R}^n is denoted by $G_{\mathbf{R}^n}$. For example, the n -cube C_n is such an embedded graph with vertex set $V(C_n) = \{ (x_1, x_2, \dots, x_n) \mid x_i = 0 \text{ or } 1 \text{ for } 1 \leq i \leq n \}$ and two vertices (x_1, x_2, \dots, x_n) and $(x'_1, x'_2, \dots, x'_n)$ are adjacent if and only if they are differ exactly in one entry. We present two n -cubes in Fig.9.4.2 for $n = 2$ and $n = 3$.

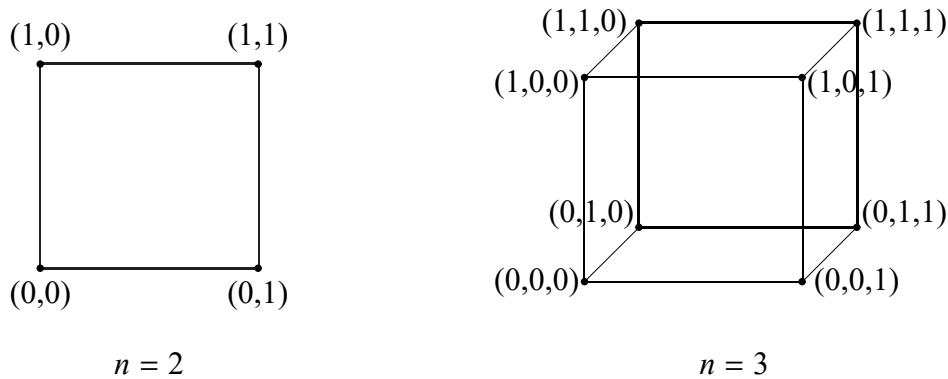

Fig.9.4.2

An embedded graph $G_{\mathbf{R}^n}$ is called *Smarandachely* if there exists a pseudo-Euclidean space (\mathbf{R}^n, μ) with a mapping $\mu : \bar{x} \in \mathbf{R}^n \rightarrow [\bar{x}]$ such that all of its vertices are non-Euclidean points in (\mathbf{R}^n, μ) . Certainly, these vertices of valency 1 is not important for Smarandachely embedded graphs. We concentrate our attention on embedded 2-connected graphs.

Theorem 9.4.7 *An embedded 2-connected graph $G_{\mathbf{R}^n}$ is Smarandachely if and only if there is a mapping $\mu : \bar{x} \in \mathbf{R}^n \rightarrow [\bar{x}]$ and a directed circuit-decomposition*

$$E_{\frac{1}{2}} = \bigoplus_{i=1}^s E(\vec{C}_i)$$

such that these matrix equations

$$\prod_{\bar{x} \in V(\vec{C}_i)} X_{\bar{x}} = I_{n \times n} \quad 1 \leq i \leq s$$

are solvable.

Proof By definition, if $G_{\mathbf{R}^n}$ is Smarandachely, then there exists a mapping $\mu : \bar{x} \in \mathbf{R}^n \rightarrow [\bar{x}]$ on \mathbf{R}^n such that all vertices of $G_{\mathbf{R}^n}$ are non-Euclidean in (\mathbf{R}^n, μ) . Notice there are only two orientations on an edge in $E(G_{\mathbf{R}^n})$. Traveling on $G_{\mathbf{R}^n}$ beginning from any edge with one orientation, we get a closed s-line \vec{C} , i.e., a directed circuit. After we traveled all edges in $G_{\mathbf{R}^n}$ with the possible orientations, we get a directed circuit-decomposition

$$E_{\frac{1}{2}} = \bigoplus_{i=1}^s E(\vec{C}_i)$$

with an s-line \vec{C}_i for integers $1 \leq i \leq s$. Applying Theorem 9.4.6, we get

$$\prod_{\bar{x} \in V(\vec{C}_i)} \mu(\bar{x}) = I_{n \times n} \quad 1 \leq i \leq s.$$

Thus these equations

$$\prod_{\bar{x} \in V(\vec{C}_i)} X_{\bar{x}} = I_{n \times n} \quad 1 \leq i \leq s$$

have solutions $X_{\bar{x}} = \mu(\bar{x})$ for $\bar{x} \in V(\vec{C}_i)$.

Conversely, if these is a directed circuit-decomposition

$$E_{\frac{1}{2}} = \bigoplus_{i=1}^s E(\vec{C}_i)$$

such that these matrix equations

$$\prod_{\bar{x} \in V(\vec{C}_i)} X_{\bar{x}} = I_{n \times n} \quad 1 \leq i \leq s$$

are solvable, let $X_{\bar{x}} = A_{\bar{x}}$ be such a solution for $\bar{x} \in V(\vec{C}_i)$, $1 \leq i \leq s$. Define a mapping $\mu : \bar{x} \in \mathbf{R}^n \rightarrow [\bar{x}]$ on \mathbf{R}^n by

$$\mu(\bar{x}) = \begin{cases} A_{\bar{x}} & \text{if } \bar{x} \in V(G_{\mathbf{R}^n}), \\ I_{n \times n} & \text{if } \bar{x} \notin V(G_{\mathbf{R}^n}). \end{cases}$$

Then we get a Smarandachely embedded graph $G_{\mathbf{R}^n}$ in the pseudo-Euclidean space (\mathbf{R}^n, μ) by Theorem 9.4.6. □

Now let $C(t) = (x_1(t), x_2(t), \dots, x_n(t))$ be a curve in \mathbf{R}^n , i.e.,

$$C(t) = x_1(t)\bar{\epsilon}_1 + x_2(t)\bar{\epsilon}_2 + \dots + x_n(t)\bar{\epsilon}_n.$$

If it is an s-line in a pseudo-Euclidean space (\mathbf{R}^n, μ) , then

$$\mu(\bar{\epsilon}_1) = \frac{x_1(t)}{|x_1(t)|}\bar{\epsilon}_1, \quad \mu(\bar{\epsilon}_2) = \frac{x_2(t)}{|x_2(t)|}\bar{\epsilon}_2, \dots, \mu(\bar{\epsilon}_n) = \frac{x_n(t)}{|x_n(t)|}\bar{\epsilon}_n.$$

Whence, we get the following result.

Theorem 9.4.8 *A curve $C(t) = (x_1(t), x_2(t), \dots, x_n(t))$ with parameter t in \mathbf{R}^n is an s-line of a pseudo-Euclidean space (\mathbf{R}^n, μ) if and only if*

$$\mu(t) = \begin{pmatrix} x_1(t) & & & & \\ & x_2(t) & & & \\ & & \ddots & & \\ O & & & \ddots & \\ & & & & x_n(t) \end{pmatrix}.$$

9.4.5 Isometry on Pseudo-Euclidean Space. We have known $\text{Isom}(\mathbf{R}^n) = \langle \mathbb{T}_{\bar{e}}, \mathbb{R}_{\bar{e}}, \mathbb{F} \rangle$. An isometry τ of a pseudo-Euclidean space (\mathbf{R}^n, μ) is an isometry on \mathbf{R}^n such that $\mu(\tau(\bar{x})) = \mu(\bar{x})$ for $\forall \bar{x} \in \mathbf{R}^n$. Clearly, all such isometries form a group $\text{Isom}(\mathbf{R}^n, \mu)$ under composition operation with $\text{Isom}(\mathbf{R}^n, \mu) \leq \text{Isom}(\mathbf{R}^n)$. We determine isometries of pseudo-Euclidean spaces in this subsection.

Certainly, if $\mu(\bar{x})$ is a constant matrix $[c]$ for $\forall \bar{x} \in \mathbf{R}^n$, then all isometries on \mathbf{R}^n is also isometries on (\mathbf{R}^n, μ) . Whence, we only discuss those cases with at least two values for $\mu : \bar{x} \in \mathbf{R}^n \rightarrow [\bar{x}]$ similar to that of (\mathbf{R}^2, μ) .

Translation. Let (\mathbf{R}^n, μ) be a pseudo-Euclidean space with an isometry of translation $T_{\bar{e}}$, where $\bar{e} = (e_1, e_2, \dots, e_n)$ and $P, Q \in (\mathbf{R}^n, \mu)$ a non-Euclidean point, a Euclidean

point, respectively. Then $\mu(T_{\bar{e}}^k(P)) = \mu(P)$, $\mu(T_{\bar{e}}^k(Q)) = \mu(Q)$ for any integer $k \geq 0$ by definition. Consequently,

$$\begin{aligned} &P, T_{\bar{e}}(P), T_{\bar{e}}^2(P), \dots, T_{\bar{e}}^k(P), \dots, \\ &Q, T_{\bar{e}}(Q), T_{\bar{e}}^2(Q), \dots, T_{\bar{e}}^k(Q), \dots \end{aligned}$$

are respectively infinite non-Euclidean and Euclidean points. Thus there are no isometries of translations if (\mathbf{R}^n, μ) is finite.

In this case, if there are rotations $R_{\theta_1, \theta_2, \dots, \theta_{n-1}}$, then there must be $\theta_1, \theta_2, \dots, \theta_{n-1} \in \{0, \pi/2\}$ and if $\theta_i = \pi/2$ for $1 \leq i \leq l$, $\theta_i = 0$ if $i \geq l + 1$, then $e_1 = e_2 = \dots = e_{l+1}$.

Rotation. Let (\mathbf{R}^n, μ) be a pseudo-Euclidean space with an isometry of rotation $R_{\theta_1, \theta_2, \dots, \theta_{n-1}}$ and $P, Q \in (\mathbf{R}^n, \mu)$ a non-Euclidean point, a Euclidean point, respectively. Then $\mu(R_{\theta_1, \theta_2, \dots, \theta_{n-1}}(P)) = \mu(P)$, $\mu(R_{\theta_1, \theta_2, \dots, \theta_{n-1}}(Q)) = \mu(Q)$ for any integer $k \geq 0$ by definition. Whence,

$$\begin{aligned} &P, R_{\theta_1, \theta_2, \dots, \theta_{n-1}}(P), R_{\theta_1, \theta_2, \dots, \theta_{n-1}}^2(P), \dots, R_{\theta_1, \theta_2, \dots, \theta_{n-1}}^k(P), \dots, \\ &Q, R_{\theta_1, \theta_2, \dots, \theta_{n-1}}(Q), R_{\theta_1, \theta_2, \dots, \theta_{n-1}}^2(Q), \dots, R_{\theta_1, \theta_2, \dots, \theta_{n-1}}^k(Q), \dots \end{aligned}$$

are respectively non-Euclidean and Euclidean points.

In this case, if there exists an integer k such that $\theta_i | 2k\pi$ for all integers $1 \leq i \leq n - 1$, then the previous sequences is finite. Thus there are both finite and infinite pseudo-Euclidean space (\mathbf{R}^n, μ) in this case. But if there is an integer i_0 , $1 \leq i_0 \leq n - 1$ such that $\theta_{i_0} \nmid 2k\pi$ for any integer k , then there must be either infinite non-Euclidean points or infinite Euclidean points. Thus there are isometries of rotations in a finite non-Euclidean space only if there exists an integer k such that $\theta_i | 2k\pi$ for all integers $1 \leq i \leq n - 1$. Similarly, an isometry of translation exists in this case only if $\theta_1, \theta_2, \dots, \theta_{n-1} \in \{0, \pi/2\}$.

Reflection. By definition, a reflection F in a subspace E' of dimensional $n - 1$ is an involution, i.e., $F^2 = 1_{\mathbf{R}^n}$. Thus if (\mathbf{R}^n, μ) is a pseudo-Euclidean space with an isometry of reflection F in E' and $P, Q \in (\mathbf{R}^n, \mu)$ are respectively a non-Euclidean point and a Euclidean point. Then it is only need that $P, F(P)$ are non-Euclidean points and $Q, F(Q)$ are Euclidean points. Therefore, a reflection F can be exists both in finite and infinite pseudo-Euclidean spaces (\mathbf{R}^n, μ) .

Summing up all these discussions, we get results following for finite or infinite pseudo-Euclidean spaces.

Theorem 9.4.9 *Let (\mathbf{R}^n, μ) be a finite pseudo-Euclidean space. Then there may be isometries of translations $T_{\bar{e}}$, rotations $R_{\bar{\theta}}$ and reflections on (\mathbf{R}^n, μ) . Furthermore,*

(1) *If there are both isometries $T_{\bar{e}}$ and $R_{\bar{\theta}}$, where $\bar{e} = (e_1, e_2, \dots, e_n)$ and $\bar{\theta} = (\theta_1, \theta_2, \dots, \theta_{n-1})$, then $\theta_1, \theta_2, \dots, \theta_{n-1} \in \{0, \pi/2\}$ and if $\theta_i = \pi/2$ for $1 \leq i \leq l$, $\theta_i = 0$ if $i \geq l + 1$, then $e_1 = e_2 = \dots = e_{l+1}$.*

(2) *If there is an isometry $R_{\theta_1, \theta_2, \dots, \theta_{n-1}}$, then there must be an integer k such that $\theta_i \mid 2k\pi$ for all integers $1 \leq i \leq n - 1$.*

(3) *There always exist isometries by putting Euclidean and non-Euclidean points $\bar{x} \in \mathbf{R}^n$ with $\mu(\bar{x})$ constant on symmetric positions to E' in (\mathbf{R}^n, μ) .*

Theorem 9.4.10 *Let (\mathbf{R}^n, μ) be a infinite pseudo-Euclidean space. Then there may be isometries of translations $T_{\bar{e}}$, rotations $R_{\bar{\theta}}$ and reflections on (\mathbf{R}^n, μ) . Furthermore,*

(1) *There are both isometries $T_{\bar{e}}$ and $R_{\bar{\theta}}$ with $\bar{e} = (e_1, e_2, \dots, e_n)$ and $\bar{\theta} = (\theta_1, \theta_2, \dots, \theta_{n-1})$, only if $\theta_1, \theta_2, \dots, \theta_{n-1} \in \{0, \pi/2\}$ and if $\theta_i = \pi/2$ for $1 \leq i \leq l$, $\theta_i = 0$ if $i \geq l + 1$, then $e_1 = e_2 = \dots = e_{l+1}$.*

(2) *There exist isometries of rotations and reflections by putting Euclidean and non-Euclidean points in the orbits $\bar{x}^{(R_{\bar{\theta}})}$ and $\bar{y}^{(F)}$ with a constant $\mu(\bar{x})$ in (\mathbf{R}^n, μ) .*

We determine isometries on (\mathbf{R}^3, μ) with a 3-cube C^3 shown in Fig.9.4.2. Let $[\bar{a}]$ be an 3×3 orthogonal matrix, $[\bar{a}] \neq I_{3 \times 3}$ and let $\mu(x_1, x_2, x_3) = [\bar{a}]$ for $x_1, x_2, x_3 \in \{0, 1\}$, otherwise, $\mu(x_1, x_2, x_3) = I_{3 \times 3}$. Then its isometries consist of two types following:

Rotations:

R_1, R_2, R_3 : these rotations through $\pi/2$ about 3 axes joining centres of opposite faces;

$R_4, R_5, R_6, R_7, R_8, R_9$: these rotations through π about 6 axes joining midpoints of opposite edges;

$R_{10}, R_{11}, R_{12}, R_{13}$: these rotations through about 4 axes joining opposite vertices.

Reflection F : the reflection in the centre fixes each of the grand diagonal, reversing the orientations.

Then $\text{Isom}(\mathbf{R}^3, \mu) = \langle R_i, F, 1 \leq i \leq 13 \rangle \simeq S_4 \times Z_2$. But if let $[\bar{b}]$ be another 3×3 orthogonal matrix, $[\bar{b}] \neq [\bar{a}]$ and define $\mu(x_1, x_2, x_3) = [\bar{a}]$ for $x_1 = 0, x_2, x_3 \in \{0, 1\}$, $\mu(x_1, x_2, x_3) = [\bar{b}]$ for $x_1 = 1, x_2, x_3 \in \{0, 1\}$ and $\mu(x_1, x_2, x_3) = I_{3 \times 3}$ otherwise. Then only the rotations R, R^2, R^3, R^4 through $\pi/2, \pi, 3\pi/2$ and 2π about the axis joining centres of

opposite face

$$\{(0, 0, 0), (0, 0, 1), (0, 1, 0), (0, 1, 1)\} \text{ and } \{(1, 0, 0), (1, 0, 1), (1, 1, 0), (1, 1, 1)\},$$

and reflection F through to the plane passing midpoints of edges

$$(0, 0, 0) - (0, 0, 1), (0, 1, 0) - (0, 1, 1), (1, 0, 0) - (1, 0, 1), (1, 1, 0) - (1, 1, 1)$$

$$\text{or } (0, 0, 0) - (0, 1, 0), (0, 0, 1) - (0, 1, 1), (1, 0, 0) - (1, 1, 0), (1, 0, 1) - (1, 1, 1)$$

are isometries on (\mathbf{R}^3, μ) . Thus $\text{Isom}(\mathbf{R}^3, \mu) = \langle R_1, R_2, R_3, R_4, F \rangle \simeq D_8$.

Furthermore, let $[\bar{a}_i]$, $1 \leq i \leq 8$ be orthogonal matrixes distinct two by two and define $\mu(0, 0, 0) = [\bar{a}_1]$, $\mu(0, 0, 1) = [\bar{a}_2]$, $\mu(0, 1, 0) = [\bar{a}_3]$, $\mu(0, 1, 1) = [\bar{a}_4]$, $\mu(1, 0, 0) = [\bar{a}_5]$, $\mu(1, 0, 1) = [\bar{a}_6]$, $\mu(1, 1, 0) = [\bar{a}_7]$, $\mu(1, 1, 1) = [\bar{a}_8]$ and $\mu(x_1, x_2, x_3) = I_{3 \times 3}$ if $x_1, x_2, x_3 \neq 0$ or 1. Then $\text{Isom}(\mathbf{R}^3, \mu)$ is nothing but a trivial group.

§9.5 REMARKS

9.5.1 The Smarandache geometry is proposed by Smarandache by denial the 5th postulate for parallel lines in Euclidean postulates on geometry in 1969 (See [Sma1]-[Sma2] for details). Then a formal definition on such geometry was suggested by Kuciuk and Antholy in [KuA1]. More materials and results on Smarandache geometry can be found in references, such as those of [Sma1]-[Sma2], [Iser1]-[Iser2], [Mao4], [Mao25] and [Liu4].

9.5.2 For Smarandache 2-manifolds, Iseri constructed 2-manifolds by equilateral triangular disks on Euclidean plane \mathbf{R}^2 . Such manifold can be really come true by paper model in \mathbf{R}^3 for elliptic, Euclidean and hyperbolic cases ([Isei1]). Observing the essence of identification 5, 6, 7 equilateral triangles in Iseri's manifolds is in fact a mapping $\mu : \mathbf{R}^2 \rightarrow 5\pi/3, 2\pi$ or $7\pi/3$, a general construction for Smarandache 2-manifolds, i.e., *map geometry* was suggested in [Mao3] by applying a general mapping $\mu : \mathbf{R}^2 \rightarrow [0, 2\pi)$ on vertices of a map, and then proved such approach can be used for constructing paradoxist geometry, anti-geometry and counter-geometry in [Mao4]. It should be noted that a more general Smarandache n -manifold, i.e., *combinatorial manifold* was combinatorially constructed in [Mao15]. Moreover, a differential theory on such manifold was also established in [Mao15]-[Mao17], which can be also found in the surveying monograph [Mao25].

9.5.3 All points are equal in status in a Euclidean space \mathbf{E} . But it is not always true in

Smarandache 2-manifolds and pseudo-Euclidean spaces. This fact means that not every isometry of \mathbf{R}^n is still an isometry of (\mathbf{R}^n, μ) . For finite Smarandache 2-manifolds or pseudo-Euclidean space, we can determine isometries by a combinatorial approach, i.e., maps on surfaces or embedded graphs in Euclidean spaces. But for infinite Smarandache 2-manifolds or pseudo-Euclidean spaces, this approach is not always effective. However, we have know all isometries of Euclidean spaces. Applying the fact that every isometry of a pseudo-Euclidean space (\mathbf{R}^n, μ) must be that of \mathbf{R}^n , It is not hard for determining isometries of a pseudo-Euclidean space (\mathbf{R}^n, μ) .

9.5.4 Let $D : \mathbf{E} \rightarrow \mathbf{E}$ be a mapping on a Euclidean space \mathbf{E} . If

$$\|D(\bar{x}) - D(\bar{y})\| = \|\bar{x} - \bar{y}\|$$

holds for all $\bar{x}, \bar{y} \in \mathbf{E}$, then D is called a *norm-preserving mapping*. Notice that Theorems 9.4.3 and 9.4.4 is established on the condition of *distance-preserving*. Whence, They are also true for norm-preserving mapping, i.e., there exist a orthogonal matrix $[a_{ij}]_{n \times n}$, a constant vector \bar{e} and a constant number λ such that

$$G = \lambda [a_{ij}]_{n \times n} + \bar{e}.$$

9.5.5 Let \mathbf{E} be a Euclidean space and $T : \mathbf{E} \rightarrow \mathbf{E}$ be a linear mapping. If there exists a real number λ such that

$$\langle T(\bar{v}_1), T(\bar{v}_2) \rangle = \lambda^2 \langle \bar{v}_1, \bar{v}_2 \rangle,$$

for all $\bar{v}_1, \bar{v}_2 \in \mathbf{E}$, then T is called a *linear conformal mapping*. It is easily to verify that

$$\|T(\bar{v})\| = |\lambda| \|\bar{v}\|$$

for $\bar{v} \in \mathbf{E}$. Such a linear conformal mapping T is indeed an angle-preserving mapping. In fact, let \bar{v}_1, \bar{v}_2 be two vectors with angle θ . Then by definition

$$\cos \angle(T(\bar{v}_1), T(\bar{v}_2)) = \frac{\langle T(\bar{v}_1), T(\bar{v}_2) \rangle}{\|T(\bar{v}_1)\| \|T(\bar{v}_2)\|} = \frac{\lambda^2 \langle \bar{v}_1, \bar{v}_2 \rangle}{\lambda^2 \|\bar{v}_1\| \|\bar{v}_2\|} = \frac{\langle \bar{v}_1, \bar{v}_2 \rangle}{\|\bar{v}_1\| \|\bar{v}_2\|} = \cos \theta.$$

Thus $\angle(T(\bar{v}_1), T(\bar{v}_2)) = \theta$ for $0 \leq \angle(T(\bar{v}_1), T(\bar{v}_2)), \theta \leq \pi$.

Problem 9.5.1 Determine linear conformal mappings on finite or infinite pseudo-Euclidean spaces (\mathbf{R}^n, μ) .

9.5.6 For a Euclidean spaces \mathbf{E} , a homeomorphism $f : \mathbf{E} \rightarrow \mathbf{E}$ is called a *differentiable isometry* or *conformal differentiable mapping* if there is an real number λ such that

$$\langle df(\bar{v}_1), df(\bar{v}_2) \rangle = \langle \bar{v}_1, \bar{v}_2 \rangle \quad \text{or} \quad \langle df(\bar{v}_1), df(\bar{v}_2) \rangle = \lambda^2 \langle \bar{v}_1, \bar{v}_2 \rangle$$

for $\forall \bar{v}_1, \bar{v}_2 \in \mathbf{E}$. Then it is clear that the integral of a linear isometry is a differentiable. and that of a linear conformal mapping is a differentiable conformal mapping by definition. Thus the differentiable isometry or conformal differentiable mapping is a generalization of that linear isometry or linear conformal mapping, respectively. Whence, a natural question arises on pseudo-Euclidean spaces following.

Problem 9.5.2 *Determine all differentiable isometries and conformal differentiable mappings on a pseudo-Euclidean space (\mathbf{R}^n, μ) .*

CHAPTER 10.

CC Conjecture

The main trend of modern sciences is overlap and hybrid, i.e., combining different fields into one underlying a combinatorial structure. This implies the importance of combinatorics to modern sciences. As a powerful tool for dealing with relations among objectives, combinatorics mushroomed in the past century, particularly in catering to the need of computer science and children games. However, an even more important work for mathematician is to apply it to other mathematics and other sciences besides just to find combinatorial behavior for objectives. *How can it contribute more to the entirety of mathematical science, not just in various games, but in metric mathematics? What is a right mathematical theory for the original face of our world?* I have brought a heartening conjecture for advancing mathematics in 2005, i.e., *A mathematical science can be reconstructed from or made by combinatorialization* after a long time speculation on combinatorics, also a bringing about Smarandache multi-space for mathematics. This conjecture is not just like an open problem, but more like a deeply thought for advancing the modern mathematics. i.e., the *mathematical combinatorics* resulting in the combinatorial conjecture for mathematics. For example, maps and graphs embedded on surfaces contribute more and more to other branches of mathematics and sciences discussed in Chapters 1 – 8.

§10.1 CC CONJECTURE ON MATHEMATICS

10.1.1 Combinatorial Speculation. Modern science has so advanced that to find a universal genus in the society of sciences is nearly impossible. Thereby a scientist can only give his or her contribution in one or several fields. The same thing also happens for researchers in combinatorics. Generally, combinatorics deals with twofold:

Question 1.1. *to determine or find structures or properties of configurations, such as those structure results appeared in graph theory, combinatorial maps and design theory, ..., etc..*

Question 1.2. *to enumerate configurations, such as those appeared in the enumeration of graphs, labeled graphs, rooted maps, unrooted maps and combinatorial designs, ..., etc..*

Consider the contribution of a question to science. We can separate mathematical questions into three ranks:

Rank 1 *they contribute to all sciences.*

Rank 2 *they contribute to all or several branches of mathematics.*

Rank 3 *they contribute only to one branch of mathematics, for instance, just to the graph theory or combinatorial theory.*

Classical combinatorics is just a *rank 3 mathematics* by this view. This conclusion is despair for researchers in combinatorics, also for me 5 years ago. *Whether can combinatorics be applied to other mathematics or other sciences? Whether can it contribute to human's lives, not just in games?*

Although become a universal genus in science is nearly impossible, *our world is a combinatorial world*. A combinatorician should stand on all mathematics and all sciences, not just on classical combinatorics and with a real combinatorial notion, i.e., *combine different fields into a unifying field*, such as combine different or even anti-branches in mathematics or science into a unifying science for its freedom of research. This notion requires us answering three questions for solving a combinatorial problem before. *What is this problem working for? What is its objective? What is its contribution to science or human's society?* After these works be well done, modern combinatorics can applied to all sciences and all sciences are combinatorialization.

10.1.2 CC Conjecture. There is a prerequisite for the application of combinatorics to other mathematics and other sciences, i.e, to introduce various metrics into combina-

torics, ignored by the classical combinatorics since they are the fundamental of scientific realization for our world. For applying combinatorics to other branch of mathematics, a good idea is to pullback measures on combinatorial objects again, ignored by the classical combinatorics and reconstructed or make combinatorial generalization for the classical mathematics, such as those of algebra, Euclidean geometry, differential geometry, Riemann geometry, metric geometries, \dots and the mechanics, theoretical physics, \dots . This notion naturally induces the combinatorial conjecture for mathematics, abbreviated to *CC conjecture* following.

Conjecture 10.1.1(CC Conjecture) *The mathematical science can be reconstructed from or made by combinatorialization.*

Remark 10.1.1 We need some further clarifications for this conjecture.

(1) This conjecture assumes that one can select finite combinatorial rulers and axioms to reconstruct or make generalization for classical mathematics.

(2) The classical mathematics is a particular case in the combinatorialization of mathematics, i.e., the later is a combinatorial generalization of the former.

(3) We can make one combinatorialization of different branches in mathematics and find new theorems after then.

Therefore, a branch in mathematics can not be ended if it has not been combinatorialization and all mathematics can not be ended if its combinatorialization has not completed. There is an assumption in one's realization of our world, i.e., *science can be made by mathematicalization*, which enables us get a similar combinatorial conjecture for the science.

Conjecture 10.1.2(CCS Conjecture) *Science can be reconstructed from or made by combinatorialization.*

A typical example for the combinatorialization of classical mathematics is the combinatorial surface theory, i.e., a combinatorial theory for surfaces discussed in Chapter 4. Combinatorially, a surface S is topological equivalent to a polygon with even number of edges by identifying each pairs of edges along a given direction on it. If label each pair of edges by a letter e , $e \in \mathcal{E}$, a surface S is also identifying to a cyclic permutation such that each edge e , $e \in \mathcal{E}$ just appears two times in S , one is e and another is e^{-1} . Let a, b, c, \dots denote the letters in \mathcal{E} and A, B, C, \dots the sections of successive letters in a linear order on

a surface S (or a string of letters on S). Then, a surface can be represented as follows:

$$S = (\cdots, A, a, B, a^{-1}, C, \cdots),$$

where, $a \in \mathcal{E}$, A, B, C denote a string of letters. Define three elementary transformations as follows:

- (O_1) $(A, a, a^{-1}, B) \Leftrightarrow (A, B)$;
 (O_2) (i) $(A, a, b, B, b^{-1}, a^{-1}) \Leftrightarrow (A, c, B, c^{-1})$;
 (ii) $(A, a, b, B, a, b) \Leftrightarrow (A, c, B, c)$;
 (O_3) (i) $(A, a, B, C, a^{-1}, D) \Leftrightarrow (B, a, A, D, a^{-1}, C)$;
 (ii) $(A, a, B, C, a, D) \Leftrightarrow (B, a, A, C^{-1}, a, D^{-1})$.

If a surface S can be obtained from S_0 by these elementary transformations O_1 - O_3 , we say that S is elementary equivalent with S_0 , denoted by $S \sim_{El} S_0$. Then we can get the classification theorem of compact surface as follows:

Any compact surface S is homeomorphic to one of the following standard surfaces:

(P_0) *the sphere: aa^{-1} ;*

(P_n) *the connected sum of $n, n \geq 1$ tori:*

$$a_1 b_1 a_1^{-1} b_1^{-1} a_2 b_2 a_2^{-1} b_2^{-1} \cdots a_n b_n a_n^{-1} b_n^{-1};$$

(Q_n) *the connected sum of $n, n \geq 1$ projective planes:*

$$a_1 a_1 a_2 a_2 \cdots a_n a_n.$$

We have known what is a map in Chapter 5. By the view of combinatorial maps, these standard surfaces P_0, P_n, Q_n for $n \geq 1$ is nothing but the bouquet B_n on a locally orientable surface with just one face. Therefore, the maps are nothing but the combinatorialization of surfaces.

10.1.3 CC Problems in Mathematics. Many open problems are motivated by the CC conjecture. Here we present some of them.

Problem 10.1.1 Simple-Connected Riemann Surface. The uniformization theorem on simple connected Riemann surfaces is one of those beautiful results in Riemann surfaces stated as follows ([FaK1]).

Theorem 10.1.1 *If \mathcal{S} is a simple connected Riemann surface, then \mathcal{S} is conformally equivalent to one and only one of the following three:*

- (1) $\mathbb{C} \cup \infty$;
- (2) \mathbb{C} ;
- (3) $\Delta = \{z \in \mathbb{C} \mid |z| < 1\}$.

We have proved in Chapter 5 that any automorphism of map is conformal. Therefore, we can also introduced the conformal mapping between maps. Then, *how can one define the conformal equivalence for maps enabling us to get the uniformization theorem of maps? What is the correspondence class maps with the three type (1)-(3) Riemann surfaces?*

Problem 10.1.2 Riemann-Roch Theorem. Let \mathcal{S} be a Riemann surface. A divisor on \mathcal{S} is a formal symbol

$$\mathcal{U} = \prod_{i=1}^k P_i^{\alpha(P_i)}$$

with $P_i \in \mathcal{S}$, $\alpha(P_i) \in \mathbb{Z}$. Denote by $Div(\mathcal{S})$ the free commutative group on the points in \mathcal{S} and define

$$deg \mathcal{U} = \sum_{i=1}^k \alpha(P_i).$$

Denote by $\mathcal{H}(\mathcal{S})$ the field of meromorphic function on \mathcal{S} . Then for $\forall f \in \mathcal{H}(\mathcal{S}) \setminus \{0\}$, f determines a divisor $(f) \in Div(\mathcal{S})$ by

$$(f) = \prod_{P \in \mathcal{S}} P^{ord_P f},$$

where, if we write $f(z) = z^n g(z)$ with g holomorphic and non-zero at $z = P$, then the $ord_P f = n$. For $\mathcal{U}_1 = \prod_{P \in \mathcal{S}} P^{\alpha_1(P)}$, $\mathcal{U}_2 = \prod_{P \in \mathcal{S}} P^{\alpha_2(P)} \in Div(\mathcal{S})$, call $\mathcal{U}_1 \geq \mathcal{U}_2$ if $\alpha_1(P) \geq \alpha_2(P)$. Now we define a vector space

$$L(\mathcal{U}) = \{f \in \mathcal{H}(\mathcal{S}) \mid (f) \geq \mathcal{U}, \mathcal{U} \in Div(\mathcal{S})\}$$

$$\Omega(\mathcal{U}) = \{\omega \mid \omega \text{ is an abelian differential with } (\omega) \geq \mathcal{U}\}.$$

Then the Riemann-Roch theorem says that([WLC1])

$$dim(L(\mathcal{U}^{-1})) = deg \mathcal{U} - g(\mathcal{S}) + 1 + dim \Omega(\mathcal{S}).$$

Comparing with the divisors and their vector space, there is also cycle space and cocycle space in graphical space theory ([Liu1]). Then *what is their relation? whether can one rebuilt the Riemann-Roch theorem by maps, i.e., find its discrete form?*

Problem 10.1.3 Combinatorial Construction of Algebraic Curve. A complex plane algebraic curve C_l is a homogeneous equation $f(x, y, z) = 0$ in $P_2\mathbb{C} = (\mathbb{C}^2 \setminus (0, 0, 0))/\sim$, where $f(x, y, z)$ is a polynomial in x, y and z with coefficients in \mathbb{C} . The degree of $f(x, y, z)$ is defined to be the *degree of the curve* C_l . For a Riemann surface S , a well-known result is that ([WSY1]) *there is a holomorphic mapping $\varphi : S \rightarrow P_2\mathbb{C}$ such that $\varphi(S)$ is a complex plane algebraic curve and*

$$g(S) = \frac{(d(\varphi(S)) - 1)(d(\varphi(S)) - 2)}{2}.$$

By definition, we have known that a combinatorial map is on surface with genus. Then *whether can one get an algebraic curve by all edges in a map or by make operations on the vertices or edges of the map to get plane algebraic curve with given k -multiple points? and then how do one find the equation $f(x, y, z) = 0$?*

Problem 10.1.4 Classification of s -Manifolds by Map. We have classified the closed s -manifolds by maps in the last chapter. For the general s -manifolds, their correspondence combinatorial model is the map on surfaces with boundary, founded by Bryant and Singerman in 1985. The later is also related to that of modular groups of spaces and need to investigate further itself. Now the questions are

- (1) *How can one combinatorially classify the general s -manifolds by maps with boundary?*
- (2) *How can one find the automorphism group of an s -manifold?*
- (3) *How can one know the numbers of non-isomorphic s -manifolds, with or without roots?*
- (4) *Find rulers for drawing an s -manifold on surface, such as, the torus, the projective plane or Klein bottle, not just the plane.*

These s -manifolds only apply such triangulations of surfaces with vertex valency in $\{5, 6, 7\}$. Then *what is its geometrical meaning of other maps, such as, 4-regular maps on surfaces*. It is already known that the later is related to the Gauss cross problem of curves ([Liu1]).

Problem 10.1.5 Gauss Mapping. In the classical differential geometry, a *Gauss mapping* among surfaces is defined as follows([Car1]):

Definition 10.1.1 *Let $S \subset R^3$ be a surface with an orientation N . The mapping $N : S \rightarrow$*

R^3 takes its value in the unit sphere

$$S^2 = \{(x, y, z) \in R^3 | x^2 + y^2 + z^2 = 1\}$$

along the orientation \mathbf{N} . The map $N : S \rightarrow S^2$, thus defined, is called the Gauss mapping.

We know that for a point $P \in S$ such that the Gaussian curvature $K(P) \neq 0$ and V a connected neighborhood of P with K does not change sign,

$$K(P) = \lim_{A \rightarrow 0} \frac{N(A)}{A},$$

where A is the area of a region $B \subset V$ and $N(A)$ is the area of the image of B by the Gauss mapping $N : S \rightarrow S^2$. Now the questions are

- (1) *What is its combinatorial meaning of the Gauss mapping? How to realizes it by maps?*
- (2) *how we can define various curvatures for maps and rebuilt the results in the classical differential geometry?*

Problem 10.1.6 Gauss-Bonnet Theorem. Let S be a compact orientable surface. Then

$$\int \int_S K d\sigma = 2\pi\chi(S),$$

where K is Gaussian curvature on S . This is the famous *Gauss-Bonnet theorem* for compact surface ([WLC1], [WSY1]). This theorem should has a combinatorial form. Now the questions are

- (1) *How can one define various metrics for combinatorial maps, such as those of length, distance, angle, area, curvature, ...?*
- (2) *Can one rebuilt the Gauss-Bonnet theorem by maps for dimensional 2 or higher dimensional compact manifolds without boundary?*

§10.2 CC CONJECTURE TO MATHEMATICS

10.2.1 Contribution to Algebra. By the view of combinatorics, algebra can be seen as a combinatorial mathematics itself. The combinatorial speculation can generalize it by the means of combinatorialization. For this objective, a Smarandachely multi-algebraic system is combinatorially defined in the following definition.

Def nition 10.2.1 For any integers $n, n \geq 1$ and $i, 1 \leq i \leq n$, let A_i be a set with an operation set $O(A_i)$ such that $(A_i, O(A_i))$ is a complete algebraic system. Then the union

$$\bigcup_{i=1}^n (A_i, O(A_i))$$

is called an n multi-algebra system.

An example of multi-algebra systems is constructed by a finite additive group. Now let n be an integer, $Z_1 = (\{0, 1, 2, \dots, n-1\}, +)$ an additive group ($\text{mod } n$) and $P = (0, 1, 2, \dots, n-1)$ a permutation. For any integer $i, 0 \leq i \leq n-1$, define

$$Z_{i+1} = P^i(Z_1)$$

satisfying that if $k + l = m$ in Z_1 , then $P^i(k) +_i P^i(l) = P^i(m)$ in Z_{i+1} , where $+_i$ denotes the binary operation $+_i : (P^i(k), P^i(l)) \rightarrow P^i(m)$. Then we know that

$$\bigcup_{i=1}^n Z_i$$

is an n multi-algebra system .

The conception of multi-algebra systems can be extensively used for generalizing conceptions and results for these existent algebraic structures, such as those of groups, rings, bodies, fields and vector spaces, \dots , etc.. Some of them are explained in the following.

Def nition 10, 2.2 Let $\widetilde{G} = \bigcup_{i=1}^n G_i$ be a closed multi-algebra system with a binary operation set $O(\widetilde{G}) = \{\times_i, 1 \leq i \leq n\}$. If for any integer $i, 1 \leq i \leq n$, $(G_i; \times_i)$ is a group and for $\forall x, y, z \in \widetilde{G}$ and any two binary operations “ \times ” and “ \circ ”, $\times \neq \circ$, there is one operation, for example the operation \times satisfying the distribution law to the operation “ \circ ” provided their operation results existing, i.e.,

$$x \times (y \circ z) = (x \times y) \circ (x \times z),$$

$$(y \circ z) \times x = (y \times x) \circ (z \times x),$$

then \widetilde{G} is called a multi-group.

For a multi-group $(\widetilde{G}, O(\widetilde{G}))$, $\widetilde{G}_1 \subset \widetilde{G}$ and $O(\widetilde{G}_1) \subset O(\widetilde{G})$, call $(\widetilde{G}_1, O(\widetilde{G}_1))$ a sub-multi-group of $(\widetilde{G}, O(\widetilde{G}))$ if \widetilde{G}_1 is also a multi-group under the operations in $O(\widetilde{G}_1)$, denoted by $\widetilde{G}_1 \leq \widetilde{G}$. For two sets A and B , if $A \cap B = \emptyset$, we denote the union $A \cup B$ by $A \oplus B$. Then we get a generalization of the Lagrange theorem on finite group following.

Theorem 10.2.1 For any sub-multi-group \tilde{H} of a fnite multi-group \tilde{G} , there is a representation set T , $T \subset \tilde{G}$, such that

$$\tilde{G} = \bigoplus_{x \in T} x\tilde{H}.$$

For a sub-multi-group \tilde{H} of \tilde{G} , $x \in O(\tilde{H})$ and $\forall g \in \tilde{G}(x)$, if for $\forall h \in \tilde{H}$,

$$g \times h \times g^{-1} \in \tilde{H},$$

then call \tilde{H} a *normal sub-multi-group* of \tilde{G} . An order of operations in $O(\tilde{G})$ is said an *oriented operation sequence*, denoted by $\vec{O}(\tilde{G})$. We get a generalization of the Jordan-Hölder theorem for fnite multi-groups following.

Theorem 10.2.2 For a fnite multi-group $\tilde{G} = \bigcup_{i=1}^n G_i$ and an oriented operation sequence $\vec{O}(\tilde{G})$, the length of maximal series of normal sub-multi-groups is a constant, only dependent on \tilde{G} itself.

A complete proof of Theorems 10.2.1 and 10.2.2 can be found in the reference [Mao6]. Notice that if we choose $n = 2$ in Definition 10.2.2, $G_1 = G_2 = \tilde{G}$. Then \tilde{G} is a body. If $(G_1; \times_1)$ and $(G_2; \times_2)$ both are commutative groups, then \tilde{G} is a fld. For multi-algebra systems with two or more operations on one set, we introduce the conception of multi-rings and multi-vector spaces in the following.

Def nition 10.2.3 Let $\tilde{R} = \bigcup_{i=1}^m R_i$ be a closed multi-algebra system with double binary operation set $O(\tilde{R}) = \{(+_i, \times_i), 1 \leq i \leq m\}$. If for any integers i, j , $i \neq j$, $1 \leq i, j \leq m$, $(R_i; +_i, \times_i)$ is a ring and for $\forall x, y, z \in \tilde{R}$,

$$(x +_i y) +_j z = x +_i (y +_j z), \quad (x \times_i y) \times_j z = x \times_i (y \times_j z)$$

and

$$x \times_i (y +_j z) = x \times_i y +_j x \times_i z, \quad (y +_j z) \times_i x = y \times_i x +_j z \times_i x$$

provided all their operation results exist, then \tilde{R} is called a *multi-ring*. If for any integer $1 \leq i \leq m$, $(R_i; +_i, \times_i)$ is a fld, then \tilde{R} is called a *multi-fld*.

Def nition 10.2.4 Let $\tilde{V} = \bigcup_{i=1}^k V_i$ be a closed multi-algebra system with binary operation set $O(\tilde{V}) = \{(+_i, \cdot_i) \mid 1 \leq i \leq m\}$ and $\tilde{F} = \bigcup_{i=1}^k F_i$ a multi-fld with double binary operation

set $O(\widetilde{F}) = \{(+_i, \times_i) \mid 1 \leq i \leq k\}$. If for any integers $i, j, 1 \leq i, j \leq k$ and $\forall \mathbf{a}, \mathbf{b}, \mathbf{c} \in \widetilde{V}$, $k_1, k_2 \in \widetilde{F}$,

- (1) $(V_i; \dot{+}_i, \cdot_i)$ is a vector space on F_i with vector additive $\dot{+}_i$ and scalar multiplication \cdot_i ;
- (2) $(\mathbf{a} \dot{+}_i \mathbf{b}) \dot{+}_j \mathbf{c} = \mathbf{a} \dot{+}_i (\mathbf{b} \dot{+}_j \mathbf{c})$;
- (3) $(k_1 \dot{+}_i k_2) \cdot_j \mathbf{a} = k_1 \dot{+}_i (k_2 \cdot_j \mathbf{a})$;

provided all those operation results exist, then \widetilde{V} is called a multi-vector space on the multi-fled \widetilde{F} with a binary operation set $O(\widetilde{V})$, denoted by $(\widetilde{V}; \widetilde{F})$.

Similarly, we also obtained results for multi-rings and multi-vector spaces to generalize classical results in rings or linear spaces.

10.2.2 Contribution to Metric Space. First, we generalize classical metric spaces by the combinatorial speculation.

Def nition 10.2.5 A multi-metric space is a union $\widetilde{M} = \bigcup_{i=1}^m M_i$ such that each M_i is a space with metric ρ_i for $\forall i, 1 \leq i \leq m$.

We generalized two well-known results in metric spaces.

Theorem 10.2.3 Let $\widetilde{M} = \bigcup_{i=1}^m M_i$ be a completed multi-metric space. For an ϵ -disk sequence $\{B(\epsilon_n, x_n)\}$, where $\epsilon_n > 0$ for $n = 1, 2, 3, \dots$, the following conditions hold:

- (1) $B(\epsilon_1, x_1) \supset B(\epsilon_2, x_2) \supset B(\epsilon_3, x_3) \supset \dots \supset B(\epsilon_n, x_n) \supset \dots$;
- (2) $\lim_{n \rightarrow +\infty} \epsilon_n = 0$.

Then $\bigcap_{n=1}^{+\infty} B(\epsilon_n, x_n)$ only has one point.

Theorem 10.2.4 Let $\widetilde{M} = \bigcup_{i=1}^m M_i$ be a completed multi-metric space and T a contraction on \widetilde{M} . Then

$$1 \leq^{\#} \Phi(T) \leq m.$$

A complete proof of Theorems 10.2.3 and 10.2.4 can be found in the reference [Mao7]. Particularly, let $m = 1$. We get the *Banach fixed-point theorem* again.

Corollary 10.2.1(Banach) Let M be a metric space and T a contraction on M . Then T has just one fixed point.

A *Smarandache n-manifold* is an n -dimensional manifold that supports a Smarandache geometry. Now there are many approaches to construct Smarandache manifolds for $n = 2$. A general way is by the so called *map geometries* without or with boundary underlying orientable or non-orientable maps.

Definition 10.2.6 For a combinatorial map M with each vertex valency ≥ 3 , endow with a real number $\mu(u), 0 < \mu(u) < \frac{4\pi}{\rho_M(u)}$, to each vertex $u, u \in V(M)$. Call (M, μ) a map geometry without boundary, $\mu(u)$ an angle factor of the vertex u and orientable or non-orientable if M is orientable or not.

Definition 10.2.7 For a map geometry (M, μ) without boundary and faces $f_1, f_2, \dots, f_l \in F(M), 1 \leq l \leq \phi(M) - 1$, if $S(M) \setminus \{f_1, f_2, \dots, f_l\}$ is connected, then call $(M, \mu)^{-l} = (S(M) \setminus \{f_1, f_2, \dots, f_l\}, \mu)$ a map geometry with boundary f_1, f_2, \dots, f_l , where $S(M)$ denotes the locally orientable surface underlying map M .

The realization for vertices $u, v, w \in V(M)$ in a space \mathbf{R}^3 is shown in Fig.3.2, where $\rho_M(u)\mu(u) < 2\pi$ for the vertex $u, \rho_M(v)\mu(v) = 2\pi$ for the vertex v and $\rho_M(w)\mu(w) > 2\pi$ for the vertex w , are called to be elliptic, Euclidean or hyperbolic, respectively.

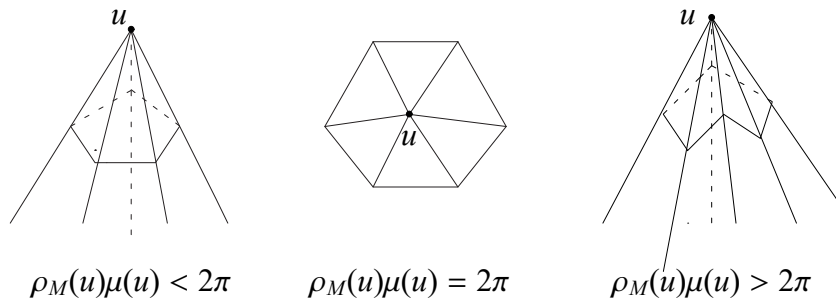

Fig.10.2.1

Theorem 10.2.5 There are Smarandache geometries, including paradoxist geometries, non-geometries and anti-geometries in map geometries without or with boundary.

A proof of this result can be found in [Mao4]. Furthermore, we generalize the ideas in Definitions 10.2.6 and 10.2.7 to metric spaces and find new geometries.

Definition 10.2.8 Let U and W be two metric spaces with metric $\rho, W \subseteq U$. For $\forall u \in U$, if there is a continuous mapping $\omega : u \rightarrow \omega(u)$, where $\omega(u) \in \mathbf{R}^n$ for an integer $n, n \geq 1$ such that for any number $\epsilon > 0$, there exists a number $\delta > 0$ and a point $v \in W, \rho(u - v) < \delta$

such that $\rho(\omega(u) - \omega(v)) < \epsilon$, then U is called a metric pseudo-space if $U = W$ or a bounded metric pseudo-space if there is a number $N > 0$ such that $\forall w \in W, \rho(w) \leq N$, denoted by (U, ω) or (U^-, ω) , respectively.

For the case $n = 1$, we can also explain $\omega(u)$ being an angle function with $0 < \omega(u) \leq 4\pi$ as in the case of map geometries without or with boundary, i.e.,

$$\omega(u) = \begin{cases} \omega(u)(\text{mod}4\pi), & \text{if } u \in W, \\ 2\pi, & \text{if } u \in U \setminus W \end{cases} \quad (*)$$

and get some interesting metric pseudo-space geometries. For example, let $U = W =$ Euclid plane $= \Sigma$, then we obtained some interesting results for pseudo-plane geometries (Σ, ω) as shown in results following ([Mao4]).

Theorem 10.2.6 *In a pseudo-plane (Σ, ω) , if there are no Euclidean points, then all points of (Σ, ω) is either elliptic or hyperbolic.*

Theorem 10.2.7 *There are no saddle points and stable knots in a pseudo-plane plane (Σ, ω) .*

Theorem 10.2.8 *For two constants $\rho_0, \theta_0, \rho_0 > 0$ and $\theta_0 \neq 0$, there is a pseudo-plane (Σ, ω) with*

$$\omega(\rho, \theta) = 2\left(\pi - \frac{\rho_0}{\theta_0\rho}\right) \text{ or } \omega(\rho, \theta) = 2\left(\pi + \frac{\rho_0}{\theta_0\rho}\right)$$

such that

$$\rho = \rho_0$$

is a limiting ring in (Σ, ω) .

Now for an m -manifold M^m and $\forall u \in M^m$, choose $U = W = M^m$ in Definition 10.2.8 for $n = 1$ and $\omega(u)$ a smooth function. We get a pseudo-manifold geometry (M^m, ω) on M^m . By definitions, a Minkowski norm on M^m is a function $F : M^m \rightarrow [0, +\infty)$ such that

- (1) F is smooth on $M^m \setminus \{0\}$;
- (2) F is 1-homogeneous, i.e., $F(\lambda\bar{u}) = \lambda F(\bar{u})$ for $\bar{u} \in M^m$ and $\lambda > 0$;
- (3) for $\forall y \in M^m \setminus \{0\}$, the symmetric bilinear form $g_y : M^m \times M^m \rightarrow R$ with

$$g_y(\bar{u}, \bar{v}) = \frac{1}{2} \frac{\partial^2 F^2(y + s\bar{u} + t\bar{v})}{\partial s \partial t} \Big|_{t=s=0}$$

is positive definite and a Finsler manifold is a manifold M^m endowed with a function $F : TM^m \rightarrow [0, +\infty)$ such that

- (1) F is smooth on $TM^m \setminus \{0\} = \cup\{T_{\bar{x}}M^m \setminus \{0\} : \bar{x} \in M^m\}$;
- (2) $F|_{T_{\bar{x}}M^m} \rightarrow [0, +\infty)$ is a Minkowski norm for $\forall \bar{x} \in M^m$.

As a special case, we choose $\omega(\bar{x}) = F(\bar{x})$ for $\bar{x} \in M^m$, then (M^m, ω) is a *Finsler manifold*. Particularly, if $\omega(\bar{x}) = g_{\bar{x}}(y, y) = F^2(x, y)$, then (M^m, ω) is a *Riemann manifold*. Therefore, we get a relation for Smarandache geometries with Finsler or Riemann geometry.

Theorem 10.2.9 *There is an inclusion for Smarandache, pseudo-manifold, Finsler and Riemann geometries as shown in the following:*

$$\begin{aligned} \{Smarandache\ geometries\} &\supset \{pseudo - manifold\ geometries\} \\ &\supset \{Finsler\ geometry\} \\ &\supset \{Riemann\ geometry\}. \end{aligned}$$

§10.3 CC CONJECTURE TO PHYSICS

The progress of theoretical physics in last twenty years of the 20th century enables human beings to probe the mystic cosmos: *where are we came from? where are we going to?*. Today, these problems still confuse eyes of human beings. Accompanying with research in cosmos, new puzzling problems also arose: *Whether are there fnite or infnite cosmoses? Are there just one? What is the dimension of the Universe? We do not even know what the right degree of freedom in the Universe is*, as Witten said.

We are used to the idea that our living space has three dimensions: *length, breadth and height*, with time providing the fourth dimension of spacetime by Einstein. Applying his principle of general relativity, i.e. *all the laws of physics take the same form in any reference system* and equivalence principle, i.e., *there are no difference for physical effects of the inertial force and the gravitation in a feld small enough.*, Einstein got the *equation of gravitational feld*

$$R_{\mu\nu} - \frac{1}{2}Rg_{\mu\nu} + \lambda g_{\mu\nu} = -8\pi GT_{\mu\nu}.$$

where $R_{\mu\nu} = R_{\nu\mu} = R^{\alpha}_{\mu i \nu}$,

$$R^{\alpha}_{\mu i \nu} = \frac{\partial \Gamma^i_{\mu\nu}}{\partial x^{\nu}} - \frac{\partial \Gamma^i_{\mu\nu}}{\partial x^i} + \Gamma^{\alpha}_{\mu i} \Gamma^i_{\alpha\nu} - \Gamma^{\alpha}_{\mu\nu} \Gamma^i_{\alpha i},$$

$$\Gamma_{mn}^g = \frac{1}{2}g^{pq}\left(\frac{\partial g_{mp}}{\partial u^n} + \frac{\partial g_{np}}{\partial u^m} - \frac{\partial g_{mn}}{\partial u^p}\right)$$

and $R = g^{\nu\mu}R_{\nu\mu}$. Combining the Einstein's equation of gravitational field with the *cosmological principle*, i.e., *there are no difference at different points and different orientations at a point of a cosmos on the metric $10^4 l.y.$* , Friedmann got a standard model of cosmos. The metrics of the standard cosmos are

$$ds^2 = -c^2 dt^2 + a^2(t)\left[\frac{dr^2}{1 - Kr^2} + r^2(d\theta^2 + \sin^2 \theta d\phi^2)\right]$$

and

$$g_{tt} = 1, g_{rr} = -\frac{R^2(t)}{1 - Kr^2}, g_{\phi\phi} = -r^2 R^2(t) \sin^2 \theta.$$

The standard model of cosmos enables the birth of big bang model of the Universe in thirties of the 20th century. The following diagram describes the developing process of our cosmos in different periods after the big bang.

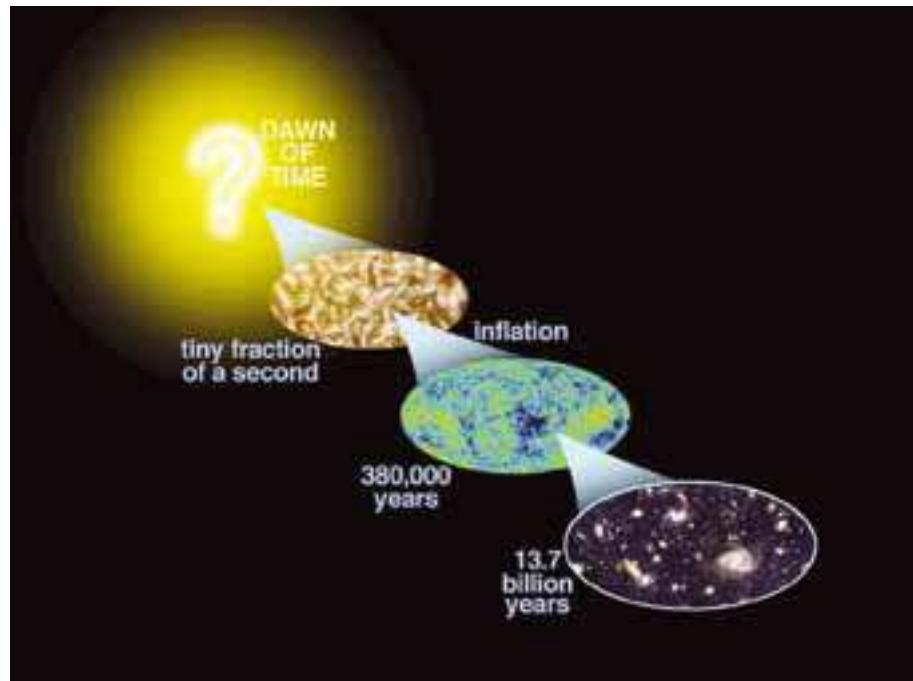

Fig.4.1

10.3.1 M-Theory. The M-theory was established by Witten in 1995 for the unity of those five already known string theories and superstring theories, which postulates that all matter and energy can be reduced to *branes* of energy vibrating in an 11 dimensional space, then in a higher dimensional space solve the Einstein's equation of gravitational

field under some physical conditions. Here, a *brane* is an object or subspace which can have various spatial dimensions. For any integer $p \geq 0$, a p -*brane* has length in p dimensions. For example, a 0-*brane* is just a point or particle; a 1-*brane* is a string and a 2-*brane* is a surface or membrane, \dots .

We mainly discuss line elements in differential forms in Riemann geometry. By a geometrical view, these p -branes in M-theory can be seen as *volume elements in spaces*. Whence, we can construct a graph model for p -branes in a space and combinatorially research graphs in spaces.

Definition 10.3.1 For each m -brane \mathbf{B} of a space \mathbf{R}^m , let $(n_1(\mathbf{B}), n_2(\mathbf{B}), \dots, n_p(\mathbf{B}))$ be its unit vibrating normal vector along these p directions and $q : \mathbf{R}^m \rightarrow \mathbf{R}^4$ a continuous mapping. Now construct a graph phase $(\mathcal{G}, \omega, \Lambda)$ by

$$V(\mathcal{G}) = \{p - \text{branes } q(\mathbf{B})\},$$

$$E(\mathcal{G}) = \{(q(\mathbf{B}_1), q(\mathbf{B}_2)) | \text{there is an action between } \mathbf{B}_1 \text{ and } \mathbf{B}_2\},$$

$$\omega(q(\mathbf{B})) = (n_1(\mathbf{B}), n_2(\mathbf{B}), \dots, n_p(\mathbf{B})),$$

and

$$\Lambda(q(\mathbf{B}_1), q(\mathbf{B}_2)) = \text{forces between } \mathbf{B}_1 \text{ and } \mathbf{B}_2.$$

Then we get a graph phase $(\mathcal{G}, \omega, \Lambda)$ in \mathbf{R}^4 . Similarly, if $m = 11$, it is a graph phase for the M-theory.

As an example for applying M-theory to find an accelerating expansion cosmos of 4-dimensional cosmoses from supergravity compactification on hyperbolic spaces is the *Townsend-Wohlfarth type metric* in which the line element is

$$ds^2 = e^{-m\phi(t)}(-S^6 dt^2 + S^2 dx_3^2) + r_c^2 e^{2\phi(t)} ds_{H_m}^2,$$

where

$$\phi(t) = \frac{1}{m-1}(\ln K(t) - 3\lambda_0 t),$$

$$S^2 = K^{\frac{m}{m-1}} e^{-\frac{m+2}{m-1}\lambda_0 t}$$

and

$$K(t) = \frac{\lambda_0 \zeta r_c}{(m-1) \sin[\lambda_0 \zeta |t + t_1|]}$$

with $\zeta = \sqrt{3 + 6/m}$. This solution is obtainable from space-like brane solution and if the proper time ς is defined by $d\varsigma = S^3(t)dt$, then the conditions for expansion and acceleration are $\frac{dS}{d\varsigma} > 0$ and $\frac{d^2S}{d\varsigma^2} > 0$. For example, the expansion factor is 3.04 if $m = 7$, i.e., a really expanding cosmos.

According to M-theory, the evolution picture of our cosmos started as a perfect 11 dimensional space. However, this 11 dimensional space was unstable. The original 11 dimensional space finally cracked into two pieces, a 4 and a 7 dimensional subspaces. The cosmos made the 7 of the 11 dimensions curled into a tiny ball, allowing the remaining 4 dimensions to inflate at enormous rates, the Universe at the final.

10.3.2 Combinatorial Cosmos. The combinatorial notion made the following combinatorial cosmos in the reference.

Definition 10.3.2 A combinatorial cosmos is constructed by a triple (Ω, Δ, T) , where

$$\Omega = \bigcup_{i \geq 0} \Omega_i, \quad \Delta = \bigcup_{i \geq 0} O_i$$

and $T = \{t_i; i \geq 0\}$ are respectively called the cosmos, the operation or the time set with the following conditions hold.

(1) (Ω, Δ) is a Smarandache multi-space dependent on T , i.e., the cosmos (Ω_i, O_i) is dependent on time parameter t_i for any integer $i, i \geq 0$.

(2) For any integer $i, i \geq 0$, there is a sub-cosmos sequence

$$(S) : \Omega_i \supset \cdots \supset \Omega_{i1} \supset \Omega_{i0}$$

in the cosmos (Ω_i, O_i) and for two sub-cosmoses (Ω_{ij}, O_i) and (Ω_{il}, O_i) , if $\Omega_{ij} \supset \Omega_{il}$, then there is a homomorphism $\rho_{\Omega_{ij}, \Omega_{il}} : (\Omega_{ij}, O_i) \rightarrow (\Omega_{il}, O_i)$ such that

(i) for $\forall (\Omega_{i1}, O_i), (\Omega_{i2}, O_i), (\Omega_{i3}, O_i) \in (S)$, if $\Omega_{i1} \supset \Omega_{i2} \supset \Omega_{i3}$, then

$$\rho_{\Omega_{i1}, \Omega_{i3}} = \rho_{\Omega_{i1}, \Omega_{i2}} \circ \rho_{\Omega_{i2}, \Omega_{i3}},$$

where “ \circ ” denotes the composition operation on homomorphisms.

(ii) for $\forall g, h \in \Omega_i$, if for any integer $i, \rho_{\Omega, \Omega_i}(g) = \rho_{\Omega, \Omega_i}(h)$, then $g = h$.

(iii) for $\forall i$, if there is an $f_i \in \Omega_i$ with

$$\rho_{\Omega_i, \Omega_i \cap \Omega_j}(f_i) = \rho_{\Omega_j, \Omega_i \cap \Omega_j}(f_j)$$

for integers $i, j, \Omega_i \cap \Omega_j \neq \emptyset$, then there exists an $f \in \Omega$ such that $\rho_{\Omega, \Omega_i}(f) = f_i$ for any integer i .

By this definition, there is just one cosmos Ω and the sub-cosmos sequence is

$$\mathbf{R}^4 \supset \mathbf{R}^3 \supset \mathbf{R}^2 \supset \mathbf{R}^1 \supset \mathbf{R}^0 = \{P\} \supset \mathbf{R}_7^- \supset \cdots \supset \mathbf{R}_1^- \supset \mathbf{R}_0^- = \{Q\}.$$

in the string/M-theory. In Fig.10.3.2, we have shown the idea of the combinatorial cosmos.

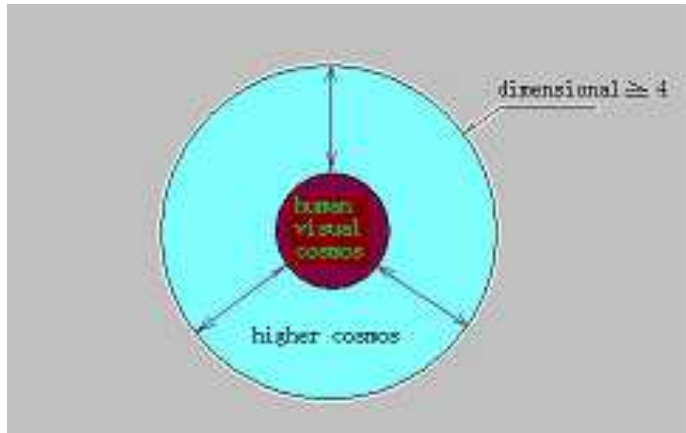

Fig.10.3.2

For spaces of dimensional 5 or 6, it has been established a dynamical theory by combinatorial notion (see [Pap1]-[Pap2] for details). In this dynamics, we look for a solution in the Einstein's equation of gravitational field in 6-dimensional spacetime with a metric of the form

$$ds^2 = -n^2(t, y, z)dt^2 + a^2(t, y, z)d \sum_k^2 + b^2(t, y, z)dy^2 + d^2(t, y, z)dz^2$$

where $d \sum_k^2$ represents the 3-dimensional spatial sections metric with $k = -1, 0, 1$ respective corresponding to the hyperbolic, flat and elliptic spaces. For 5-dimensional spacetime, deletes the indefinite z in this metric form. Now consider a 4-brane moving in a 6-dimensional *Schwarzschild-ADS spacetime*, the metric can be written as

$$ds^2 = -h(z)dt^2 + \frac{z^2}{l^2}d \sum_k^2 + h^{-1}(z)dz^2,$$

where

$$d \sum_k^2 = \frac{dr^2}{1 - kr^2} + r^2 d\Omega_{(2)}^2 + (1 - kr^2)dy^2$$

and

$$h(z) = k + \frac{z^2}{l^2} - \frac{M}{z^3}.$$

Then the equation of a 4-dimensional cosmos moving in a 6-spacetime is

$$2\frac{\ddot{R}}{R} + 3\left(\frac{\dot{R}}{R}\right)^2 = -3\frac{\kappa_{(6)}^4}{64}\rho^2 - \frac{\kappa_{(6)}^4}{8}\rho p - 3\frac{\kappa}{R^2} - \frac{5}{l^2}$$

by applying the *Darmois-Israel conditions* for a moving brane. Similarly, for the case of $a(z) \neq b(z)$, the equations of motion of the brane are

$$\frac{d^2\dot{R} - d\ddot{R}}{\sqrt{1 + d^2\dot{R}^2}} - \frac{\sqrt{1 + d^2\dot{R}^2}}{n} \left(d\dot{n} + \frac{\partial_z n}{d} - (d\partial_z n - n\partial_z d)\dot{R}^2 \right) = -\frac{\kappa_{(6)}^4}{8}(3(p + \rho) + \hat{p}),$$

$$\frac{\partial_z a}{ad} \sqrt{1 + d^2\dot{R}^2} = -\frac{\kappa_{(6)}^4}{8}(\rho + p - \hat{p}),$$

$$\frac{\partial_z b}{bd} \sqrt{1 + d^2\dot{R}^2} = -\frac{\kappa_{(6)}^4}{8}(\rho - 3(p - \hat{p})),$$

where the energy-momentum tensor on the brane is

$$\hat{T}_{\mu\nu} = h_{\nu\alpha} T_{\mu}^{\alpha} - \frac{1}{4} T h_{\mu\nu}$$

with $T_{\mu}^{\alpha} = \text{diag}(-\rho, p, p, p, \hat{p})$ and the *Darmois-Israel conditions*

$$[K_{\mu\nu}] = -\kappa_{(6)}^2 \hat{T}_{\mu\nu},$$

where $K_{\mu\nu}$ is the extrinsic curvature tensor.

The combinatorial cosmos also presents new questions to combinatorics, such as:

- (1) Embed a graph into spaces with dimensional ≥ 4 ;
- (2) Research the phase space of a graph embedded in a space;
- (3) Establish graph dynamics in a space with dimensional $\geq 4, \dots$, etc..

For example, we have gotten the following result for graphs in spaces.

Theorem 10.3.1 *A graph G has a nontrivial including multi-embedding on spheres $P_1 \supset P_2 \supset \dots \supset P_s$ if and only if there is a block decomposition $G = \biguplus_{i=1}^s G_i$ of G such that for any integer $i, 1 < i < s$,*

- (1) G_i is planar;
- (2) for $\forall v \in V(G_i), N_G(x) \subseteq \left(\bigcup_{j=i-1}^{i+1} V(G_j) \right)$.

A complete proof of Theorem 10.3.1 can be found in [Mao4]. Further consideration of combinatorial cosmos will enlarge the knowledge of combinatorics and cosmology, also get the combinatorialization for cosmological science.

References

- R.D.M.Accola
- [Acc1] On the number of automorphisms of a closed Riemann surface, *Tran. Amer. Math. Soc.*, vol.131,398-408(1968).
- L.V.Ahlfors and L.Sario
- [AhS1] Riemann Surfaces, Princeton University Press, N.J., 1960.
- N.L.Alling
- [All1] Foundation of the Theory of Klein Surfaces, *Lect.Notes in Math.*, 219, Springer-Verlag, Berlin,etc.(1971).
- B.Alspach
- [Als1] Point-symmetric graphs and digraphs of prime order and transitive permutation groups of prime degree, *J.Combin.Theory,Ser.B*, 15(1973),12-17.
- I.Antoniadis
- [Ant1] Physics with large extra dimensions: String theory under experimental test, *Current Science*, Vol.81, No.12, 25(2001),1609-1613.
- M.A.Armstrong
- [Arm1] Basic Topology, McGraw-Hill, Berkshire, England, 1979.
- C.Ashbacher
- [Ash1] Smarandache geometries, *Smarandache Notions Journal*, Vol.8, No. 1-2-3 (1997), 212-215.
- L.Babai
- [Bab1] Automorphism groups, isomorphism, reconstruction, in R. Graham, M.Grotschel

and L.Lovasz ed: *Handbook of Combinatorics*, Elsevier Science B.V, (1995), 1447-1540.

E.Bujalance, J.J.Etayo and J.M.Gamboa

[BEG1] Hyperelliptic Klein surfaces, *Qurt. J.Math.Oxford*(2),36(1985), 141-157.

E.Bujalance, J.J.Etayo, J.M.Gamboa and G.Gromadzki

[BEGG1] Automorphism groups of compact bordered Klein surfaces, *Lect. Notes in Math.*, 1439, Springer-Verlag, Berlin, etc.(1990).

N.Biggs

[Big1] Automorphisms of imbedded graphs, *J.Combin. Theory*, Vol.11(1971), 132-138.

[Big2] Algebraic Graph Theory (Second Edition), Cambridge University Press, 1993.

G.Birkhoff and S.MacLane

[BiM1] A Survey of Modern Algebra (4th edition), Macmillan Publishing Co., Inc, 1977.

N.L.Biggs and A.T.White

[BiW1] Permutation Groups and Combinatoric Structure, Cambridge University Press, 1979.

L.Brankovic, M.Miller et al

[BrM1] A note on constructing large Cayley graphs of given degree and diameter by voltage assignments, *The Electronic J. Combinatorics*, 5(1998), #R9.

R.P.Bryant and D.Singerman

[BrS1] Foundations of the theory of maps on surfaces with boundary, *Quart.J.Math. Oxford*(2), 36(1985), 17-41.

E.Bujalance

[Buj1] Cyclic group automorphisms of compact non-orientable Klein surfaces without boundary, *Pacific J. Mathematics*, vol.109, No.2, 279-289(1983).

Peter J.Cameron

[Cam1] Automorphism groups of graphs, in *Selected Topics in Graph Theory*, ed. Lowell W.Beineke and Robin J.Wilson, Academic Press, London, 1983, 89-127.

Mantredo P.de Carmao

[Car1] Differential Geometry of Curves and Surfaces, Pearson Education Asia Ltd., 2004.

J.Chern, J.L.Gross and R.G.Rieper

- [CGR1] Overlap matrices and total imbedding distributions, *Discrete Math.*, 128(1994), 73-94.
C.Y.Chao
- [Cha1] On the classification of symmetrical graphs with a prime number of vertices, *Trans.Amer.Math.Soc.* 158(1971), 247-256.
S.Chimienti and M.Bencze
- [ChB1] Smarandache paradoxist geometry, *Bulletin of Pure and Applied Sciences*, Delhi, India, Vol.17E, No.1(1998), 123-1124.
S.S.Chern and W.H.Chern
- [ChC1] Lectures in Differential Geometry (in Chinese), Peking University Press, 2001.
Gary Chartrand and Linda Lesniak
- [ChL1] Graphs & Digraph (Second Edition), Wadsworth, Inc., USA, 1986.
B.P.Chetia and K.Patra
- [ChP1] On metabelian groups of automorphisms of compact Riemann surfaces, *J. London Math.Soc.*, Vol.33, No.2, 467-472(1986).
X.G.Chen and Z.F.Zhang
- [ChZ1] Adjacent vertex distinguishing total coloring on $P_m \vee P_n$, *J. Northwest Normal University* (Natural Science), Vol.41, 1(2005).
M.Conder and P.Dobcsányi
- [CoD1] Determination of all regular maps of small genus, *J.Combin. Theory*, Series B, 81(2001), 224-242.
H.S.M.Coxeter and W.O.J.Moser
- [CoM1] Generators and Relations for Discrete Groups, Springer, New York, 1980.
John D.Dixon and Brian Mortimer
- [DiM1] Permutation Groups, Springer-Verlag New York Inc., 1996.
A.B.D'azevedo, R.Nedela and J.Širáň
- [DNS1] Classification of regular maps of negative prime Euler characteristic, *Trans. Amer. Math. Soc.*, Vol.357, 10(2004), 4175-4190.
M.J.Duff
- [Duf1] A layman's guide to M-theory, *arXiv*: hep-th/9805177, v3, 2 July(1998).

J.Edmonds

- [Edm1] A combinatorial representation for polyhedral surfaces, *Notices Amer. Math. Soc.*, 7(1960).

H. M.Farkas and I.Kra

- [FaK1] Riemann Surfaces, Springer-Verlag New York inc(1980).

M.L.Furst, J.L.Gross and R.Statman

- [FGS1] Genus distributions for two class of graphs, *J.Combin.Theory*, Ser. B, 46(1989), 22-36.

A.Gardiner, R.Nedela, J.Širáň and M.Škovera

- [GNSS1] Characterization of graphs which underlie regular maps on closed surfaces, *J.London Math. Soc.*(2)59(1999),100-108.

C.Godsil

- [God1] Neighbourhood of transitive graphs and GRR's, *J.Combin. Theory*, Ser.B, 29(1980), 116-140.

- [God2] GRR's for non-solvable groups, in *Algebraic Methods in Graph Theory*, ed. L.Lovasz and V.T.Sós, North-Holland, Amsterdam, 1981, 157-164.

C.Godsil and G.Royle

- [GoR1] Algebraic Graph Theory, Springer-Verlag New York, Inc., 2001.

J.L.Gross and M.L.Furst

- [GrF1] Hierarchy for imbedding-distribution invariants of a graph, *J.Graph Theory*, 11(1987), 205-220.

- [GrF2] Genus distribution for bouquets of circles, *J.Combin. Theory*, Ser. B, 47(1989), 292-306.

G.Gromadzki

- [Gro1] Abelian Groups of automorphisms of compact non-orientable Klein surfaces without boundary, *Commentationes Mathematicae*, 28(1989),197-217.

J.L.Groos and T.W.Tucker

- [GrT1] Topological Graph Theory, John Wiley & Sons, 1987.

J.E.Graver and M.E.Watkins

- [GrW1] Combinatorics with Emphasis on the Theory of Graphs, Springer-Verlag, New York

Inc,1977.

U.Günther and A.Zhuk

[GuZ1] Phenomenology of brane-world cosmological models, *arXiv: gr-qc/0410130*.

W.J.Harvey

[Har1] Cyclic groups of automorphisms of compact Riemann surfaces, *Quart J.Math. Oxford*, vol.17, No.2, 86-97(1966).

F.Harary and W.T.Tutte

[HaT1] On the order of the group of a planar map, *J.Combin. Theory*, 1(1966), 194-195.

D.Ida

[Ida1] Brane-world cosmology, *arXiv: gr-qc/9912002*.

H.Iseri

[Ise1] Smarandache Manifolds, American Research Press, Rehoboth, NM,2002.

[Ise2] Partially Paradoxist Smarandache Geometries, <http://www.gallup.unm.edu/~smarandache/Howard-Iseri-paper.htm>.

L.D.James and G.A.Jones

[JaJ1] Regular orientable imbeddings of complete graphs, *J.Combin. Theory, Series B*, 39(1985), 353-367.

D.L.Johnson

[Joh1] Symmetries, Springer-Verlag, 2001.

G.A.Jones and D.Singerman

[JoS1] Theory of maps on orientable surfaces, *Proc.London Math. Soc.*(3),37(1978), 273-307.

M.Kaku

[Kak1] Hyperspace: A Scientific Odyssey through Parallel Universe, Time Warps and 10th Dimension, Oxford Univ. Press, 1994.

W.B.Vasantha Kandasmy and D.Meiyappan

[KaM1] Bigroup and fuzzy bigroup, *Bol.Soc.Paran Mat.*, 18(1998), 59-63.

W.B.Vasantha Kandasmy

[Kan1] Bialgebraic Structure and Smarandache Bialgebraic Structure, American Research

Press, 2003.

V.Krishnamurthy

[Kri1] Combinatorics: Theory and Application, Ellis Horwood Limited, 1986.

J.H.Kwak and S.H.Shim

[KwS1] Total embedding distribution for bouquets of circles, *Discrete Math.*, 248(2002), 93-108.

L.Kuciuk and M.Antholy

[KuA1] An Introduction to Smarandache Geometries, *Mathematics Magazine, Aurora, Canada*, Vol.12(2003)

John M.Lee

[Lee1] Introduction to Topological Manifolds, Springer-Verlag New York, Inc., 2000.

[Lee2] Riemann Manifolds, Springer-Verlag New York, Inc(1997).

S.W.Liang

[Lia1] On the Smarandachely Adjacent Vertex Total Coloring of k-Cube Graph, *J. Tangshan College*, Vol.22, 3(2009).

[Lia2] On Smarandachely Adjacent Edge Coloring of a Class of Extended Petersen Graph, *J. Hebei North University(Natural Science)*, 25(5), 2009.

Y.P.Liu

[Liu1] Embeddability in Graphs, Kluwer Academic Publisher, Dordrecht / Boston / London (1995).

[Liu2] Enumerative Theory of Maps, Kluwer Academic Publishers , Dordrecht/ Boston/ London, 1999.

[Liu3] Advances in Combinatorial Maps, Northern Jiaotong University Publisher, Beijing (2003).

[Liu4] Introductory Map Theory, Kapa & Omega, Glendale, AZ, USA, 2010.

[Liu5] The maximum non-orientable genus of a graph (in Chinese), *Scientia Sinica (Special Issue on Math)*, I(1979), 191-201.

X.Lv

[LvX1] Smarandachely Adjacent Vertex Total of Graph $P_m + P_n$, *Ludong University Journal (Natural Science)*, 25(4), 2009.

Y.N.Lv and X.L.Zhang

- [LvZ1] Riemann Surfaces, Sciences Publisher Press, Beijing, 1991.
J.W.Li, Z.F.Zhang, Z.W.Wang, E.Q.Zhu, F.Wen and B.Yao
- [LZW1] The Smarandachely adjacent-vertex total coloring of three classes of 3-regular Halin graphs, *Computational Intelligence and Software Engineering*, 2009. CiSE 2009. International Conference on Issue Date: 11-13 Dec. 2009.
C.Maclachlan
- [Mac1] Abelian groups of automorphisms of compact Riemann surfaces, *Proc.London Math.Soc.*, vol.15,No.3,699-712(1965).
P.L.Maggu
- [Mag1] On introduction of bigroup concept with its applications industry, *Pure Appl. Math. Sic.*, 39(1994), 171-173.
P.L.Maggu and Rajeev Kumar
- [MaK1] On sub-bigroup and its applications, *Pure Appl.Math. Sic.*, 43(1996), 85-88.
A.Malnic
- [Mal1] Group action,coverings and lifts of automorphisms, *Discrete Math*, 182(1998), 203-218.
A.Malinic, R.Nedela and M.Škoviera
- [MNS1] Lifting graph automorphisms by voltage assignment, *Europ.J.Combinatorics*, 21(2000),927-947.
L.F.Mao
- [Mao1] *A census of maps on surface with given underlying graph*, A doctor thesis in Northern Jiaotong University, Beijing, 2002.
- [Mao2] Automorphism Groups of Maps, Surfaces and Smarandache Geometries, American Research Press, 2005.
- [Mao3] On automorphism groups of maps, surfaces and Smarandache geometries, *Scientia Magna*, Vol.1(2005), No.2,55-73.
- [Mao4] Smarandache Multi-Space Theory, Hexis, Phoenix, USA, 2006.
- [Mao5] Selected Papers on Mathematical Combinatorics, World Academic Union, 2006.
- [Mao6] On algebraic multi-group spaces, *Scientia Magna*, Vol.2, No.1 (2006), 64-70.
- [Mao7] On multi-metric spaces, *Scientia Magna*, Vol.2,No.1(2006), 87-94.
- [Mao8] On algebraic multi-vector spaces, *Scientia Magna*, Vol.2,No.2 (2006), 1-6.

- [Mao9] On algebraic multi-ring spaces, *Scientia Magna*, Vol.2, No.2(2006), 48-54.
- [Mao10] Smarandache multi-spaces with related mathematical combinatorics, in Yi Yuan and Kang Xiaoyu ed. *Research on Smarandache Problems*, High American Press, 2006.
- [Mao11] Combinatorial speculation and combinatorial conjecture for mathematics, *International J.Math. Combin.* Vol.1(2007), No.1, 1-19.
- [Mao12] An introduction to Smarandache multi-spaces and mathematical combinatorics, *Scientia Magna*, Vol.3, No.1(2007), 54-80.
- [Mao13] Pseudo-manifold geometries with applications, *International J. Math. Combin.* Vol.1(2007), No.1, 45-58.
- [Mao14] A combinatorial generalized Stokes theorem on integration, *International J. Math. Combin.* Vol.1(2007), No.1, 67-86.
- [Mao15] Geometrical theory on combinatorial manifolds, *JP J.Geometry and Topology*, Vol.7, No.1(2007), 65-114.
- [Mao16] Curvature equations on combinatorial manifolds with applications to theoretical physics, *International J.Math.Combin.*, Vol.1(2008), No.1, 16-35.
- [Mao17] Combinatorially Riemannian Submanifolds, *International J. Math. Combin.*, Vol. 2(2008), No.1, 23-45.
- [Mao18] Differential geometry on Smarandache manifolds, in Yuhua Fu, Linfan Mao and Mihaly Bencze ed: *Scientific Elemwnts*, Vol.1, InfoLearnQuest Press, USA, 2007.
- [Mao19] Combinatorially differential geometry, in Yuhua Fu, Linfan Mao and Mihaly Bencze ed: *Scientific Elemwnts*, Vol.1, InfoLearnQuest Press, USA, 2007.
- [Mao20] Extending homomorphism theorem to multi-systems, *International J.Math. Combin.* Vol.3(2008), 1-27.
- [Mao21] Action of multi-groups on finite multi-sets, *International J.Math. Combin.* Vol.3(2008), 111-121.
- [Mao22] Topological multi-groups and multi-fields, *International J.Math. Combin.* Vol.1 (2009), 08-17.
- [Mao23] Euclidean pseudo-geometry on \mathbf{R}^n , *International J.Math. Combin.* Vol.1 (2009), 90-95.
- [Mao24] Combinatorial fields - an introduction, *International J.Math. Combin.* Vol.3 (2009), 01-22.
- [Mao25] *Combinatorial Geometry with Applications to Field Theory*, InfoQuest, USA, 2009.
- [Mao26] A combinatorial decomposition of Euclidean space \mathbf{R}^n with contribution to visibility,

International J.Math. Combin., Vol.1(2010), 47-64.

- [Mao27] Labeling, covering and decomposing of graphs– Smarandache’s notion in graph theory, *International J.Math. Combin.*, Vol.3 (2010), 108-124.
- [Mao28] Let’s Flying by Wing – Mathematical Combinatorics and Smarandache Multi-Spaces, Chinese Branch Xiquan House, USA, 2010.

L.F.Mao and Y.P.Liu

- [MaL1] New automorphism groups identity of trees, *Chinese Advance in Mathematics*, 113-117,5(2002).
- [MaL2] On the roots on orientable embeddings of graph, *Acta Math. Scientia*, 23A(3), 287-293(2003).
- [MaL3] Group action approach for enumerating maps on surfaces, *J. Applied Math. & Computing*, Vol.13, No.1-2,201-215.
- [MaL4] A new approach for enumerating maps on orientable surfaces, *Australasian J. Combinatorics*, Vol.30(2004), 247-259.

L.F.Mao and F.Tian

- [MaT1] A combinatorial refinement of Hurwitz theorem on Riemann surfaces, *Collection papers in The Symposia of 2004 Postdoctoral Forum on Frontal & Interdisciplinary Sciences of Chinese Academy of Sciences*, 75-89, December 2004.
- [MaT2] On oriented 2-factorable graphs, *J.Applied Math. & Computing*, Vol.17, No.1-2. 25-38.

L.F.Mao, Y.P.Liu and F.Tian

- [MLT1] Automorphisms of maps with a given underlying graph and their application to enumeration, *Acta.Math.Sinica*, Vol.21, 2(2005), 225-236.

L.F.Mao, Y.P.Liu and E.L.Wei

- [MLW1] The semi-arc automorphism group of a graph with application to map enumeration, *Graphs and Combinatorics*, Vol.22, No.1(2006) 93-101.

W.S.Massey

- [Mas1] Algebraic topology: an introduction, Springer-Verlag, New York, etc.(1977).
- [Mas2] Singular Homology Theory, Springer-Verlag, New York, etc.(1980).

B.Mohar and C.Thomassen

- [MoT1] Graphs on Surfaces, The Johns Hopkins University Press, London, 2001.

B.P.Mull, R.G.Rieper and A.T.White

- [MRW1] Enumeration 2-cell imbeddings of connected graphs, *Proc.Amer.Math.Soc.*, 103 (1988), 321-330.

B.P.Mull

- [Mul1] Enumerating the orientable 2-cell imbeddings of complete bipartite graphs, *J.Graph Theory*, Vol 30, 2(1999), 77-90.

James R.Munkres

- [Mun1] *Topology (Second Edition)*, Prentice Hall, Inc, 2000.

R.Nedela

- [Ned1] Regular maps – combinatorial objects relating different fields of mathematics, *J. Korean Math.Soc.*, Vol. , (2001), 1069-1105.

R.Nedela and M.Škoviera

- [NeS1] R.Nedela and M.Škoviera, Regular embeddings of canonical double coverings of graphs, *J.Combin. Theory, Ser.B* 67, 249-277(1996).
 [NeS2] R.Nedela and M.Škoviera, Regular maps from voltage assignments and exponent groups, *Europ.J.Combinatorics*, 18(1997), 807-823.

E.Papantonopoulos

- [Pap1] Braneworld cosmological models, *arXiv: gr-qc/0410032*.
 [Pap2] Cosmology in six dimensions, *arXiv: gr-qc/0601011*.

J.A.Peacock

- [Pea1] *Cosmological Physics*, Cambridge University Press, 2003.

PlanetMath

- [PIM1] Smarandache Geometries, <http://planetmath.org/encyclopedia/Smarandache-Geometries.htm>1.

J.Polchinski

- [Pol1] *String Theory, Vol.1-Vol.2*, Cambridge University Press, 2003.

K.Polthier and M.Schmies

- [PoS1] Straightest geodesics on polyhedral surfaces, in *Mathematical Visualization* (ed. by H.C.Hege and K.Polthier), Springer-Verlag, Berlin, 1998.

C.E.Prager, R.J. Wang and M.Y.Xu

- [PWX1] Symmetric graph of order a product of two distinct primes, *J.Combinatorial Theory, Ser.B*, Vol.58, 2(1993), 299-318.

D.Rabounski

- [Rab1] Declaration of academic freedom: Scientific Human Rights, *Progress in Physics*, January (2006), Vol.1, 57-60.

Derke J.S.Robinson

- [Rob1] A Course in the Theory of Groups, Springer-Verlag New York Inc, 1982.

D.Singerman

- [Sin1] Automorphisms of compact non-orientable Riemann surface, *Glasgow J. Math.*, 12(1971), 50-59.

J.Širáň

- [Sir1] Triangle group representations and constructions of regular maps, *Proc. London Math. Soc.*, Vol.82, 3(2001), 513-532.
- [Sir2] Regular maps on a given surface: A survey, in M.Klazar et. al. ed. *Topics in Discrete Math., Algorithms and Combinatorics*, Vol.26, 591-609, Springer, Berlin, 2006.

F.Smarandache

- [Sma1] Paradoxist mathematics, *Collected Papers*, Vol.II, 5-28, University of Kishinev Press, 1997.
- [Sma2] Mixed noneuclidean geometries, arXiv: math/0010119, 10/2000.

S.Stahl

- [Sta1] Generalized embedding schemes, *J.Graph Theory* Vol.2(1978), 41-52.
- [Sta2] The embedding of a graph—A survey, *J.Graph Theory* 2(1978), 275-298.

T.R.Stallings

- [Sta11] Graphical theory of automorphisms of free groups, in *Combinatorial group theory and topology*(ed. by S.M.Gersten and J.R.Stallings), Princeton University Press, 1987.

J.Stillwell

- [Sti1] Classical Topology and Combinatorial Group Theory, Springer-Verlag New York Inc., (1980).
- [Sur1] D.B.Surowski, Lifting map automorphisms and MacBeath's theorem, *J. Combin. Theory*, Ser. B, 50(1990),135-149.

S.Somasundaram, A.Nagarajan and G.Mahadevan

- [SNM1] Graphoidal tree d -cover, *International J.Math. Combin.* Vol.2 (2009), 66-78.
- [SNM2] Decomposition of graphs into internally disjoint trees, *International J.Math. Combin.* Vol.2 (2009), 90-102.
- W.T.Tutte
- [Tut1] What is a maps? in *New Directions in the Theory of Graphs* (ed.by F.Harary), Academic Press (1973), 309-325.
- [Tut2] *Graph Theory*, Cambridge University Press, 2001.
- A.Vince
- [Vin1] Combinatorial maps, *J. Combin. Theory*, Ser B 34 (1983), 1-21.
- [Vin2] Regular combinatorial maps, *J. Combin. Theory*, Ser B 35 (1983), 256-277.
- E.F. Wang
- [Wan1] *Fundamental Group Theory*, Peking University Press, 1986.
- R.J. Wang and M.Y.Xu
- [WaX1] A classification of symmetric graphs of order $3p$, *J. Combin. Theory*, Vol.58, 2(1993), 197-216.
- J.K.Weeks
- [Wee1] *The Shape of Space*, New York, Marcel Dekker, Inc, 1985.
- A.T.White
- [Whi1] *Graphs of Group on Surfaces – Interactions and Models*, Elsevier Science B.V., 2001.
- Wielandt.H
- [Wie1] *Finite Permutation Groups*, Academic Press, 1964.
- H.X.Wu, Y.N.Lv and Z.H.Chern
- [WLC1] *Introduction to Compact Riemann Surfaces (In Chinese)*, Science Publisher Press, Beijing, 1999.
- H.X.Wu, C.L.Shen and Y.L.Yu
- [WSY1] *Elementary Riemann Geometry (In Chinese)*, Peking University Press, 1989.
- C.Q.Wang, D.J.Wang and M.Y.Xu
- [WWX1] On normally Cayley graphs of finite groups, *Scientia Sinica*, 28(1998), 131-139.
- M.Y.Xu, J.H.Huang, H.L.Li and S.R.Li
- [XHLL1] *Introduction to Group Theory (in Chinese)(II)*, Science Press, Beijing, 1999.

Mingyao Xu

- [Xum1] Introduction to the Finite Groups (**I**), Science Publisher Press, Beijing, 1999.
[Xum2] Automorphism groups and isomorphisms of Cayley digraphs, *Discrete Math.*, 182 (1998), 309-319.

Young-Gheel Baik, Yanquan Feng, Hyo-Seob Sim and Mingyao Xu

- [YYHX] On the normality of Cayley graphs of Abelian groups, *Algebra Colloquium*, Vol. 5, 3(1998), 297-304.

H.P.Yap

- [Yap1] Some Topics in Graph Theory, *London Mathematical Society Lecture Note Series* 108, Cambridge University Press, 1986.

Y.D.Zhang

- [Zha1] The Structure of Finite Groups, Science Publisher Press, Beijing, 1984.

Z.F. Zhang et.al.

- [ZhE1] On the AVSDT-Coloring of $S_m + W_n$, *International J.Math. Combin.* Vol.3 (2008), 105-110.

E.Q.Zhu, Z.W.Wang and Z.F.Zhang

- [ZWZ1] On the Smarandachely-adjacent-vertex edge coloring of some double graphs, *J. Shandong University(Natural Science)*, 44(12), 2009.

Index

A

Abelian multigroup 36
Abelian system 7
additive group 96
adjacency matrix 81
affine group 48
affine transformation 48
 A_J -compatible 221
 A_J -uniform 221
algebraic system 6
analytic mapping 146
angle on map 227
angle transformation 227
anti-geometry 310
arc 118
arc transitive graph 101
arcwise-connected 118
asymmetric graph 285
associative 7
automorphism 49, 92, 149, 184, 310
automorphism group 49, 92, 149, 186

B

Banach fixed-point theorem 355
band decomposition 170
basis 26
basic permutation 175
bigroup 37
bijection 4

binary operation 6
brane 359
Burnside Lemma 42

C

cardinality 4
Cayley graph 92
Cayley map 195
CC conjecture 348
cell embedding 168
center 50, 51
characteristic subgroup 52
circuit 81
combinatorial cosmos 361
commutator subgroup 53
compact 120
complete map 197, 248
conformal differentiable mapping 345
conjugate group 51
connected sum 125
connectivity 85
continuous mapping 119
coset 13
coset representation 14
countable set 4
counter-projective geometry 309
covering space 212
covering mapping 213
crosscap map group 292
curvature 321, 328, 336
cycle index 299
cyclic group 12

D

decomposition of a graph 86
 differentiable isometry 345
 diagonal type 68
 dianalytic mapping 146
 direct product 24, 26
 discontinuous action 159
 divisor 350
 dominating set 86
 dual map 177
 double cover 158

E

edge chromatic number 85
 edge-connectivity 85
 edge cover 86
 edge independent set 86
 edge set 80
 elementary equivalence 129
 elementary subdivision 88
 elementary transformations 128
 elliptic point 329
 elliptic vertex 310
 embedding sequence 278
 equivalent embedding 172
 equivalent permutation 42
 Euclid point 329
 Euclidean space 332
 Euclid vertex 310
 Euler characteristic 134, 173
 even permutation 17

F

factorization 86
 faithful permutation 42
 finite set 4
 Finsler manifold 358
 first countable 118
 folding mapping 148
 Frobenius group 198
 fundamental group 138

G

Gauss mapping 351
 Gauss-Bonnet theorem 352
 genus 136, 179
 globally primitive 77
 globally k -transitive 74, 113
 globally transitive 74
 graph 80
 graph group 92
 graph property 85
 graphical regular representation 99
 group 8

H

half-transitive graph 102
 Hausdorff space 118
 homeomorphic space 120
 homomorphism 20
 homotopic mapping 136
 Huriwitz Theorem 229
 hyperbolic area 155
 hyperbolic point 329

hyperbolic vertex 310
 hyperbolic tessellation 200
 hypergraph 115

I

image 3, 20, 35
 imprimitive block 61
 imprimitive group 61
 inclusion mapping 141
 induced action 105
 induced subgraph 83
 infinite set 4
 injection 4
 inner automorphism 50
 intersection set 2
 inverse 7
 involution 16
 Iseri's manifold 310
 isometry 318, 323
 isomorphic graph 82
 isomorphic group 10
 isomorphic multigroup 31
 isomorphic rooted map 272
 isomorphism 20, 149, 181

K

kernel 20, 35
 Klein 4-group 8, 175
 Klein surface 146
 k -factorable 86
 k -transitive 46
 k -transitive extended 71

L

Legendre symbol 58
 lifted automorphism 220
 lifting arc 212
 lifting graph 215
 lifting map 217
 limit point 118
 linear conformal mapping 344
 linear isometry 333
 local action group 69
 locally compact 120
 locally transitive group 69
 locally regular group 69
 locally k -transitive group 70
 locally sharply k -transitive group 70
 locally primitive group 71
 loop 80

M

map 176
 map geometry 356
 map-automorphism graph 260
 map exponent 221
 map group 186
 mapping 3
 metric pseudo-space 357
 metric space 317
 minimal normal subgroup 66
 morphism 148
 multi-algebra system 353
 multigroup 30
 multiple edge 80

multigroup action graph 110
 multi-metric space 355
 multipolygon 206
 multisurface 206

N

natural homomorphism 23
 NEC group 150
 neighborhood 81, 118
 n -manifold 121
 non-Euclid area of map 227
 non-Euclidean point 321, 335
 non-geometry 309
 non-orientable genus polynomial 276
 non-orientable map 179
 non-orientable surface 123
 norm 332
 norm-preserving mapping 344
 normally Cayley graph 93
 normalizer 51
 normal subgroups 15
 normal submultigroup 33
 n -sheeted covering 213

O

odd permutation 17
 one face map 261
 one-point extended 71
 opened cover 120
 order 11, 80
 orientable embedding index 269
 orientable genus polynomial 276

orientable map 179
 orientable surface 123
 orientation-preserving 123, 170, 242
 orientation-reversing 123, 170, 242
 outer automorphism group 51

P

paradoxist geometry 309
 path 81
 p -element 28
 p -subgroup 28
 permutation 16
 permutation groups 42
 permutation pair 286
 permutation representation 42
 planar graph 87
 planar regular tessellation 199
 point 118
 polygonal presentation 128
 power set 3
 primitive extended 71
 primitive group 61
 projection 124, 212
 projective plane 124
 pseudo- Euclidean space 335
 pure rotation 168

Q

quadricell 175
 quotient group 23
 quotient multigroup 34
 quotient space 123

quotient topology 123

R

reflection 320, 334, 341

regular group 46

regular map 191

regular representation 19

Riemann manifold 358

Riemann surface 147

right action 42

root 268

rooted map 272

rooted map sequence 278

rooted orientable map polynomial 275

rooted non-orientable map polynomial 275

rooted total map polynomial 275

root polynomial 268

rotation 320, 334, 341

rotation embedding scheme 168

rotation matrix 336

rotation system 171

S

Schwarzschild-ADS spacetime 362

second countable 118

Seifert- Van Kampen theorem 141

set 2

semi-arc automorphism 104

semi-arc set 103

semi-arc transitive 105

semigroup 7

semidirect product 25

semi-regular group 46

semi-regular graph 256

semi-regular map 256

sharply k-transitive group 47

similarity 42

simply connected space 140

simple graph 80

simple group 15

signature 155

size 80

s-line 308, 336

Smarandache geometry 307

Smarandache graphoidal cover 89

Smarandache graphoidal tree cover 89

Smarandache manifold 307

Smarandache multi-space 40

Smarandache plane 321

Smarandachely automorphism 317

Smarandachely chromatic number 89

Smarandachely coloring 89

Smarandachely decomposition 89

Smarandachely denied 307

Smarandachely embeddable graph 89

Smarandachely embedded graph 338

Smarandachely graph 89

Smarandachely map 325

Smarandachely path cover 89

Smarandachely property 89

socele 66

spanning subgraph 83

spherical tessellation 200

s-plane 308

s-space 308

s-triangle 308
stabilizer 42
standard map 179
straight-line homotopy 137
subgraph 82
subgroup 12
submultigroup 31
subset 3
surface 121
surface group 143
surface presentation 128
surjection 4
Sylow p -subgroup 28

T

topology 118
total genus polynomial 276
Townsend-Wohlfarth type metric 360
trail 81
triangulation 126
transitive group 45
translation 320, 334, 340
transitive root 268

U

union set 2
unit 7
universal map 195

V

valency 81
vertex chromatic number 85

vertex cover 86
vertex independent set 86
vertex set 80
voltage graph 215
voltage map 216

W

walk 81



Linfan Mao is a researcher of *Chinese Academy of Mathematics and System Science*, an honorary professor of *Beijing Institute of Architectural Engineering*, also a deputy general secretary of the *China Tendering & Bidding Association* in Beijing. He got his Ph.D in Northern Jiaotong University in 2002 and finished his postdoctoral report for *Chinese Academy of Sciences* in 2005. His research interest is mainly on mathematical combinatorics and Smarandache multi-spaces with applications to sciences, includes combinatorics, algebra, topology, differential geometry, theoretical physics and parallel universe.

ABSTRACT: Automorphisms of a system survey its symmetry and appear nearly in all mathematical branches, such as those of algebra, combinatorics, geometry, \dots and theoretical physics or chemistry. The main motivation of this book is to present a systematically introduction to automorphism groups on algebra, graphs, maps, i.e., graphs on surfaces and geometrical structures with applications. Topics covered in this book include elementary groups, symmetric graphs, graphs on surfaces, regular maps, lifted automorphisms of graphs or maps, automorphisms of maps underlying a graph with applications to map enumeration, isometries on Smarandache geometry and CC conjecture, etc., which is suitable as a textbook for graduate students, and also a valuable reference for researchers in group action, graphs with groups, combinatorics with enumeration, Smarandache multispaces, particularly, Smarandache geometry with applications.

