

In this book, the authors have proved the analogues of the Bolzano Weierstrass theorem for the linguistic version. Several concepts in the case of the linguistic continuum are very distinct from the natural classical real continuum. Categorically, we have three linguistic variables: one leading to a continuum, some finite and orderable set and some not orderable. We define a linguistic plane associated with linguistic variables and give graphs associated with linguistic functions.

LINGUISTIC FUNCTIONS

linguistic functions

linguistic term

linguistic variable

**W.B.VASANTHA KANDASAMY
K. ILANTHENRAL
FLORENTIN SMARANDACHE**



US \$40.00

ISBN 978-1-59973-748-5



9 781599 737485 >

W B VASANTHA KANDASAMY
K ILANTHENRAL
FLORENTIN SMARANDACHE

Linguistic Functions

**W. B. Vasantha Kandasamy
Ilanthenral K
Florentin Smarandache**

Editorial Global Knowledge
2022

Copyright 2022 by *Editorial Global knowledge* and the *Authors*

This book can be ordered from:

Editorial Global Knowledge
848 BRICKELL AVE STE 950 MIAMI, FLORIDA, US 33131.
info@egk.ccgecon.us

This work is licensed under a Creative Commons Attribution-NonCommercial-NoDerivatives 4.0 International License.

Peer reviewers:

Dr. Octavian Cira, Aurel Vlaicu University of Arad, Romania.
Said Broumi, University of Hassan II Mohammedia,
Hay El Baraka Ben M'sik, Casablanca B. P. 7951.
Morocco.
Dr. Huda E . Khalid, Department of Mathematics,
Telafer University, Iraq.

Many books can be downloaded from the following
Digital Library of Science:
<http://www.gallup.unm.edu/eBooks-otherformats.htm>

ISBN-13: 978-1-59973-748-5
EAN: 9781599737485

Printed in the United States of America

CONTENTS

Preface	4
Chapter One INTRODUCTION	7
Chapter Two LINGUISTIC MAPS, FUNCTIONS AND THEIR PROPERTIES	62
Chapter Three LINGUISTIC PLANES AND GRAPHS	112

FURTHER READING	175
INDEX	178
ABOUT THE AUTHORS	183

PREFACE

In this book, for the first time, authors try to introduce the concept of linguistic variables as a continuum of linguistic terms/elements/words in par or similar to a real continuum. For instance, we have the linguistic variable, say the heights of people, then we place the heights in the linguistic continuum [shortest, tallest] unlike the real continuum $(-\infty, \infty)$ where both $-\infty$ or $+\infty$ is only a non-included symbols of the real continuum, but in case of the linguistic continuum we generally include the ends or to be more mathematical say it is a closed interval, where shortest denotes the shortest height of a person, maybe the born infant who is very short from usual and the tallest will denote the tallest one usually very tall; however this linguistic continuum [shortest, tallest] in the real continuum will be the closed interval say [1 foot, 8 feet] or [1, 8] the measurement in terms of feet. So, the real interval is a subinterval with which we have associated the real continuum in terms of qualifying unit feet and inches in this case.

Likewise, suppose the linguistic variable is age. In that case, we have a linguistic continuum given by the closed interval [youngest, oldest], youngest corresponding to the just born baby and oldest corresponding to 100 years. So, with units, days, months and years, we qualify this linguistic continuum. In the case of reals, one can take the interval [0, 100], where 0 corresponds to zero year, from time of birth to one year. The units of measurement are the year.

However, in chapter one of this book, we have described and developed linguistic words or terms of linguistic variables and its difference from the classical fuzzy way.

This book has three chapters, and chapter one is introductory. Chapter two introduces linguistic maps and functions and discusses their properties. The final chapter describes and develops the notion of linguistic planes and linguistic graphs of the linguistic functions on linguistic planes.

We have proved the analogues of the Bolzano Weierstrass theorem for the linguistic version. Several concepts in the case of the linguistic continuum are very distinct from the natural classical real continuum. We have several linguistic continuums which depend on the linguistic variable under consideration.

There are linguistic variables associated with them only a finite collection of linguistic terms which may not be orderable or a continuum.

For instance, consider the various shades of people's eye colour or skin colour or hair colour. Further, the colour of the hair of different nationalities. The diseases of the plants whose leaves are affected. All these linguistic variables give only a finite number of linguistic terms/words associated with them. So categorically, we can have three linguistic variables: one leading to a continuum, some finite and totally orderable set and some not totally orderable.

However, we can define a linguistic plane associated with linguistic variables or can give graphs associated with linguistic functions represented in these planes. We have two linguistic maps, one semilinguistic map and the other linguistic map. The study of the linguistic variable indeterminacy is beyond the scope of this book as it is an abstract variable for beginners to understand. We have suggested some problems for interested readers at the end of each chapter.

We acknowledge Dr K.Kandasamy with gratitude for his continuous support.

W.B.VASANTHA KANDASAMY
ILANTHENRAL K
FLORENTIN SMARANDACHE

Chapter One

INTRODUCTION

In this chapter, we introduce the basic concepts used in this book to make it a self-contained one. The very concept of linguistic sets or linguistic terms happens to be very new. In this book we are mainly interested in introducing, the new notion of linguistic planes associated with linguistics sets which are related with the linguistics variables.

Unlike the real plane or complex plane which are unique these linguistic planes are many and it is dependent on the linguistics variable under consideration. Further all linguistic variables cannot pave way to linguistics planes. There are several criteria for a linguistics variable to have a related linguistic plane.

However, at this juncture, it is important to note that there are infinite number of mod planes [19].

But given a positive number $m \in \mathbb{Z}^+ \setminus \{1\}$ we can have only one such mod plane but as m varies in $\mathbb{Z}^+ \setminus \{1\}$ we have infinite number of such mod planes.

Now we also give conditions for the linguistics planes to exist in the following chapters.

We now describe some basic properties of linguistics variables by examples; also we explain the need for such study.

In the first place suppose some on lookers look at a person and they are interested to assess the height of the person. One of the on looker says he is tall, some other says he is just tall another one says not very tall and so on. So, in case of determining the height of a person, this is a natural way to find the height. It is not by giving it in centimeters or inches but give it approximately tall or very tall or just tall and so on.

Further at this juncture the method of giving the value as a membership is not plausible or to give the value as a fuzzy membership either.

Thus, the only way to express the height is by giving it in terms of natural language which happens to be more normal to a common man. Hence representing a value by natural language by any one is the most natural way of expression.

Thus, we want to develop all possible ways by which the natural language which we call as linguistic terms or linguistic sets and impose on them possible mathematical classical tools so that it becomes a well-equipped one mathematically and scientifically.

So, we do not use the linguistics variables and the study of properties as mentioned in [24-29]; for we do not want to once again use the concept of fuzzy membership in these linguistics variables.

So the notion of exact use of terminology given by [24-29] like, linguistic hedge, linguistic information, linguistic approximations, linguistic trajectory or linguistic states etc.; will not be used as we do not want to use the linguistics membership [24], and define the notion of linguistics variables as a quintuple (v, T, X, g, m) in which v is the name of the variable, T is the set of linguistics terms of v that refer to a base variable whose values range over a universal set X , g is a syntactic rule (a grammar) for generating linguistics terms and m is the semantic rule that assigns to each linguistic term $t \in T$ its meaning $m(t)$, which is a fuzzy set on X (i.e. $m:T \rightarrow \mathcal{F}(X)$).

However, we do not want to use this definition or concept of linguistics variables in our book for we want to develop this notion to build the concept not only for researcher but to school students at large so that they do not fear mathematics. Another definition of linguistics variables as given by Zadeh [24] who has defined a linguistics variable as a variable whose values are sentences or words in a artificial or a natural language.

Neutrosophic Linguistics: Linguistic Neutrosophic Numbers (LNN)

Fang and Ye [3] have defined Linguistic Neutrosophic Numbers (LNN) as follows.

Definition 1.1: [3] *Set a finite language set $\psi = \{\psi_t \mid t \in [0, K]\}$ where ψ_t is a linguistic variable, $K + 1$ is the cardinality of ψ . Then, we define $u = (\psi_\beta, \psi_\gamma, \psi_\delta)$, in which $\psi_\beta, \psi_\gamma, \psi_\delta \in \psi$ and $\beta, \gamma, \delta \in [0, k]$ ψ_β, ψ_δ and ψ_γ express the truth, falsity and indeterminacy degree respectively, we call u a LNN.*

However [3] have defined Simplified Neutrosophic Linguistics Sets (SNLS) or Simplified Neutrosophic Linguistic Numbers (SNLN), but the way we define linguistic neutrosophic term/value or equally neutrosophic linguistic term in a very different way.

The definitions in the case of fuzzy linguistic values or its generalizations to neutrosophic linguistics values are never defined in the same way in our study. For the main deviation being we do not give any numerical real value to the variable.

However, as the linguistic variable indeterminate happens to be an abstract one, their study is beyond the scope of this book. The linguistic continuum associated with this variable is (not indeterminate, entirely indeterminate). The authors aim to remove the phobia of mathematics in children, adults, and researchers in non-mathematics fields.

But we use a little modified form of linguistics variables. We represent a linguistic variable only as words in a natural language which we define as a linguistic set or linguistics terms associated with linguistics variables V .

We can also denote it by $w(V)$.

We describe this by an example before we define it abstractly.

Example 1.1. Consider the linguistic variable V . If the linguistic variable V is going to be the general age of people. Then one can put them as

youngest, younger, very very young, so on, middle aged, just middle aged; so on; old, very very old, ..., oldest.

One can imagine them naturally to be put in the interval
[youngest, oldest]

and we call this interval as the linguistic continuum or linguistic interval for it is continuous and it can be easily totally ordered.

However, if one is interested in finding the age of a finite group of people linguistically then they can fix it by a finite linguistic set/term S and $S \subseteq [\text{youngest, oldest}]$.

This set S will also be a totally ordered set.

Hence the linguistic variable ‘age’ yields a totally ordered set.

We just recall the definition of totally ordered set in the following.

For more refer [6, 9].

Definition 1.2. *Let M be a non-empty set (concepts / numbers or so on). We say M is a totally ordered set if for every pair of distinct elements, a, b in M we can compare them as*

$$a \leq b \quad \text{or} \quad b \leq a$$

That is a is less than b or b is less than a (or used in the mutually exclusive sense). If on the other hand a and b are not distinct that is they are identical then we say a is less than or equal to b by default of notation.

On similar lines we can define for any distinct pair of elements $a, b \in M$, $a \geq b$ or $b \geq a$ (or used in the mutually exclusive sense).

We say (M, \leq) (or (M, \geq)) is a totally ordered set.

We will provide an example or two. For more refer [6].

Example 1.2. Let $P = \{0.9, 8, 11, -19, -12, 3.5, -4.8, 1, 99\}$ be a set. We show P is a totally ordered set.

$$-19 \leq -12 \leq -4.8 \leq 0.9 \leq 1 \leq 3.5 \leq 8 \leq 11 \leq 99 \quad \dots I$$

$$(\text{or } 99 \geq 11 \geq 8 \geq 3.5 \geq 1 \geq 0.9 \geq -4.8 \geq -12 \geq -19) \quad \dots II$$

Clearly (P, \leq) (or (P, \geq)) is a totally ordered set.

Example 1.3. Consider some subsets P of a set

$S = \{a, b, c, d, e, f, g, h\}$ where

$P = \{\{a\}, \{a, b\}, \{a, b, h\}, \{a, b, h, d\}, \{a, b, h, d, e, f\},$
 $\{a, b, h, d, e, f, c\}\}.$

Thus, P under subset containment ordering is a totally ordered set.

$$\begin{aligned} \text{For } \{a\} &\subseteq \{a, b\} \subseteq \{a, b, h\} \subseteq \{a, b, h, d\} \\ &\subseteq \{a, b, h, d, e, f\} \subseteq \{a, b, h, d, e, f, c\}. \end{aligned}$$

Thus $\{P, \subseteq\}$ is a totally ordered set.

It may so happen we may have a nonempty set in which there exists at least two distinct elements a, b such that $a \leq b$ (or $b \geq a$).

They are not totally ordered set. This leads to the definition of a partially ordered set.

Definition 1.3. Let S be a non-empty set. We say S is a partially ordered set if there exists at least a distinct pair of elements say $a, b \in S$ such that a and b are comparable.

It can be $a \geq b$ (or $a \leq b$) and $(a \neq b)$.

We will provide some examples of them.

Example 1.4. Let $S = \{a, b, c, d\}$ be a set. $P(S)$ be the power set of S given by

$$P(S) = \{\emptyset, \{a\}, \{b\}, \{c\}, \{d\}, \{a, b\}, \{a, c\}, \{a, d\}, \{b, c\}, \{b, d\}, \{c, d\}, \{a, b, c\}, \{a, b, d\}, \{a, c, d\}, \{b, c, d\}, \{a, b, c, d\} = S\}.$$

Clearly $P(S)$ is only a partially ordered set.

For take $\{a, b, c\}$ and $\{a, b, c, d\} \in P(S)$, we see

$$\{a, b, c\} \subseteq \{a, b, c, d\}$$

' \subseteq ' is the containment relation of the subsets of S .

Consider $\{a, b, c\}$ and $\{b, d\} \in P(S)$, we see $\{b, d\}$ is in no way comparable with $\{a, b, c\}$. So, every pair of elements in $P(S)$ is not comparable, so $P(S)$ cannot be a totally ordered set. We see $P(S)$ is only a partially ordered set.

We have several such partially ordered sets using powerset of a non-empty set S .

Theorem 1.1. Let S be a nonempty set and $P(S)$ be the power set of S . $\{P(S), \subseteq\}$ is a partially ordered set.

Proof is left as an exercise to the reader.

Theorem 1.2. Let S be a nonempty set if $\{S, \leq\}$ (or $\{S, \geq\}$) is a totally ordered set then $\{S, \leq\}$ (or $\{S, \geq\}$) is a partially ordered set.

If $\{S, \subseteq\}$ is a partially ordered set then $\{S, \subseteq\}$ is not a totally ordered set.

Now we will provide examples of partially ordered linguistics sets associated with linguistics variables.

Example 1.5. Let us study the problem of colour of eyes of people internationally. So, the linguistic variable V is the colour of eyes.

Suppose the expert finds the colour of the eyes of a group of people as

$$S = \{\text{black, brown, honey colour, green and blue}\}.$$

Clearly S is the linguistics set associated with the linguistics variable colour of the eyes.

We see no element in the set S is comparable. So the set S is not comparable so S is neither partially ordered not totally ordered.

Suppose some other experts find the colour of the eyes of people internationally and says;

$$R = \{\text{brown, dark brown, black, light brown, green, dark green, light green, blue, honey coloured}\}$$

be the linguistic set associated with the linguistics variable colour of the eyes.

We see R is a partially ordered set for

brown \leq dark brown,

light green \leq green \leq dark green.

However brown and blue cannot be compared, so R is only a partially ordered set and not a totally ordered set.

Thus unlike reals or rationals or integers which are always a totally ordered set and in fact every subset of these are also totally ordered, we see in case of linguistic set associated with a linguistic variable is not in general a totally ordered set or a partially order set. It can also be an unordered set and the 'order' property is dependent on the linguistic variable under consideration.

We have given examples of totally ordered linguistic set, partially ordered linguistic set and unordered set.

We will proceed onto define some more properties associated with them.

We see one can form in case of linguistic set S associated with some linguistic variable V ; $S = w(V)$, where

$$w(V) = \{\text{set of all words associated with the variable } V\}.$$

The ordering of S is totally dependent on the linguistic variable under consideration.

We give examples of them.

Example 1.6. Let us consider the linguistic variable quality of mango fruits. The quality is based on the size, colour and the sweetness. So, the linguistic set

$P = \{\text{small, large, medium size, very small, very large, just large, yellow, orange, red mixed orange and so on, very sweet, just sweet, no taste sweet, bitter and so on}\}.$

P is not orderable.

Now we consider only the study of linguistic variable size of the mango fruits. The linguistic set A associated with the linguistic variable size of the mango fruit is

$A = \{\text{very large, largest, just large, large, just medium size, medium size, small, very small, smallest and so on}\}.$

We can totally order them.

Consider the linguistic variable colour of the mango fruit. Let

$C = \{\text{red, bright yellow, yellow, orange, shades with green and yellow}\}.$

Clearly, we cannot order C.

We provide another example of linguistic sets.

Example 1.7. Let us consider the linguistic variable weather report for a month of a particular state in India. We want to study only the temperature of each day.

This linguistic set associated with variable is a linguistic continuum given by $P = [\text{lowest, highest}]$.

Clearly P is the totally ordered set.

Now we proceed onto give an example of a linguistic partially ordered set.

Example 1.8. Let

$$S = \{\text{good, bad, very good, fair, worst, very bad}\}$$

be the linguistic set associated with the performance of 20 students in a classroom. Let $P(S)$ be the linguistic power set of S given by

$$P(S) = \{\{\emptyset, \{\text{good}\}, \{\text{bad}\}, \{\text{very good}\}, \{\text{fair}\}, \{\text{worst}\}, \{\text{very bad}\}, \{\text{good, bad}\}, \{\text{good, very good}\}, \{\text{good, fair}\}, \{\text{good, very good, bad}\}, \{\text{worst, good, bad, fair}\}, \{\text{bad, worst, very bad, good, fair}\}, \dots, \{\text{good, bad, very good, fair, worst}\}, \{\text{good, very bad, bad, very good, fair}\}, \{\text{good, very bad, very good, worst}\}, \dots, S\}$$

be the power set of S with order of $P(S)$ to be 2^6 .

Consider the pair of elements $\{\text{good, fair}\}$ and $\{\text{very bad, very good}\}$ in $P(S)$, they are not comparable. So, $P(S)$ is not a totally ordered set as we have in $P(S)$ a pair of distinct elements which are not comparable.

To show $P(S)$ is a partially ordered set it is enough if we can find a pair of distinct elements in $P(S)$ which are comparable.

$$\text{For take } \{\text{good, very good, bad}\} \text{ and } \{\text{good, very good, bad, very bad}\} \in P(S).$$

We see

$$\{\text{good, very good, bad}\} \subseteq \{\text{good, very good, bad, very bad}\}.$$

That is the set {good, very good, bad} is contained in
 {good, very good, bad, very bad}.

Since there exist at least two distinct pair in $P(S)$ which are comparable and as we have shown already the existence of a distinct pair which is not comparable.

The linguistic power set $P(S)$ is only a partially ordered linguistic set.

We have infinitely many linguistic partially ordered sets. Those have been already described.

Next, we proceed onto recall about mappings or functions in general and we proceed onto define and develop it in case of linguistic sets / terms.

Example 1.9. Consider the linguistic variables colour of the eyes of 57 nationalities from 7 countries given by S .

$$S = \{\text{Indian, English, African, Tamils, Chinese, Spanish and Russian}\}.$$

The colour of their eyes are

$$R = \{\text{dark brown, brown, green, bluish, light brown, gray, hazel, black}\}$$

British or English have green, blue and brown, Spanish have brown eyes, Russian have brown, gray or blue.

Now we can map which we call as linguistic map from 7 nations set S to R the set of colours of the eyes of the people.

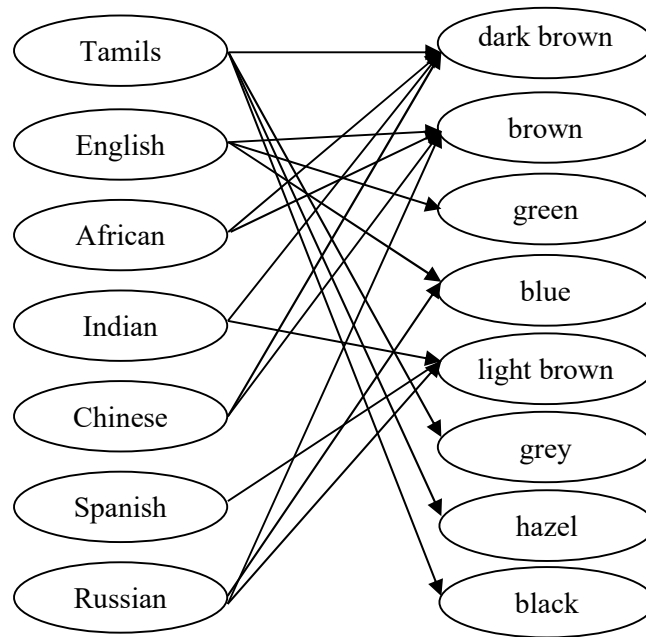

Figure 1.1

We cannot call this as a map in the classical sense as in case of classical maps we have only three types of maps one to one, many to one and onto which we will give as examples.

So in case of linguistic maps, we need not have for any element in the domain space we must have one and only one range element in the range space.

So, this linguistic map does not fall under any of the classical maps / functions.

Even if we exchange the domain with range also we see the linguistic map / function is as follows.

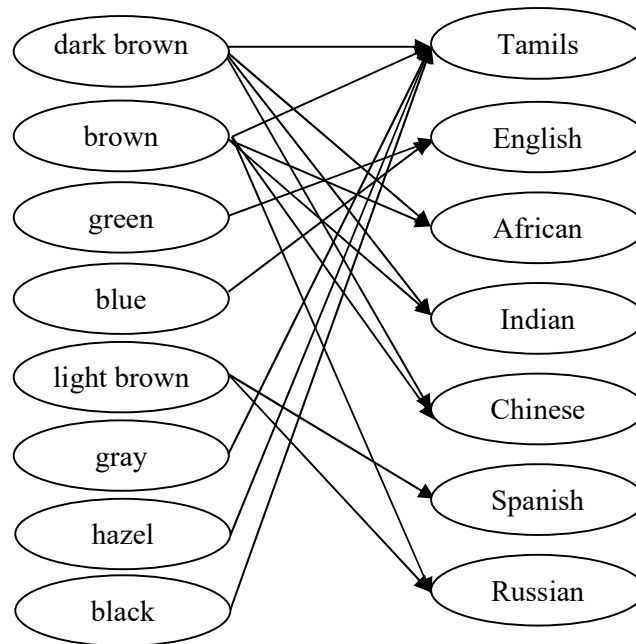

Figure 1.2

This map also does not fall under any of the classical functions (maps).

The classical maps (functions) are entirely different from the linguistic maps (functions).

Now provide a few types of classical functions / maps in the following.

Here by default of notation we may use both the terms maps for functions and functions for maps.

Definition 1.4. A function or a map f is a set of ordered pairs (x, y) ($f = \{(x, y) \mid x \text{ and } y \text{ can be number or objects or attributes where } x \in D, \text{ the domain space and } y \in R \text{ the range space}\}$)

where no two of them can have the same first member. That is if $(x, y) \in f$ and $(x, z) \in f$ then $y = z$.

In other words the definition of function or map requires that for every x in the domain D of the function f there is exactly one y in the range R such that $(x, y) \in f$. It is customary to call y the value of f at x and to write $y = f(x)$ instead of $(x, y) \in f$; to denote (x, y) is in the set f .

We have the following result.

Theorem 1.3. Two functions (or maps) f and g are equal if and only if

- i) f and g must have the same domain space
- ii) $f(a) = g(a)$ for every $a \in D$.

For more refer [9].

A function / map defined a set S is said to be one to one on S if and only if for every $x, y \in S$; $f(x) = f(y)$ implies $x = y$.

We will illustrate this situation by some examples.

Example 1.10. Consider the set of positive integers Z^+ as the set

Let $\eta: Z^+ \rightarrow Z^+$ defined by $\eta(x) = 2x$.

Clearly η for $(x, 2x) \in S = Z^+ \times 2Z^+$;

however $(2x, x) \notin S$ for take $x = 1$, $(2, 1) \notin Z^+ \times 2Z^+$ hence we have $(x, 2x) \in S$ but $(2x, x) \notin S$.

Hence the claim.

However, for the sake of clarity we would be defining the concepts of different types of functions in a systematic way which is also not very abstract and provide simple examples of them.

To make a better understanding of types of functions; injective, bijective, one to one onto etc. we first start to define the notion of domain, codomain, and range of a function.

A function $f : Z^+ \rightarrow Z^+$; that is $f : A \rightarrow B$

defined as $f(x) = 2x$ for every $x \in Z^+ = A$.

We call $A = Z^+$ as the domain of the function f and $B = Z^+$ is called as the codomain of the function f . So, both domain and codomain of f are positive integers.

When we take $\{f(x) / x \in Z^+\} = \{2x / x \in Z^+\}$

= set of only positive even integers which can be denoted by $2Z^+$.

Clearly $2Z^+ \subseteq Z^+$ so only a part of the codomain is used by this function f .

This part of the codomain by definition is called as the range of f .

range of $f \subsetneq$ codomain of f .

Thus, the range of f is a subset of the codomain.

We will provide a few examples of them.

Example 1.11. Let $f: T \rightarrow V$ be a function from domain T to the codomain V of f were

$T = \{a, b, c, d, e, f, g\}$ and codomain of f be

$V = \{1, 2, 3, 4, 5, 6, 7, 8, 9, 10, 11, 12, 13\}$.

Define $f: T \rightarrow V$ as follows:

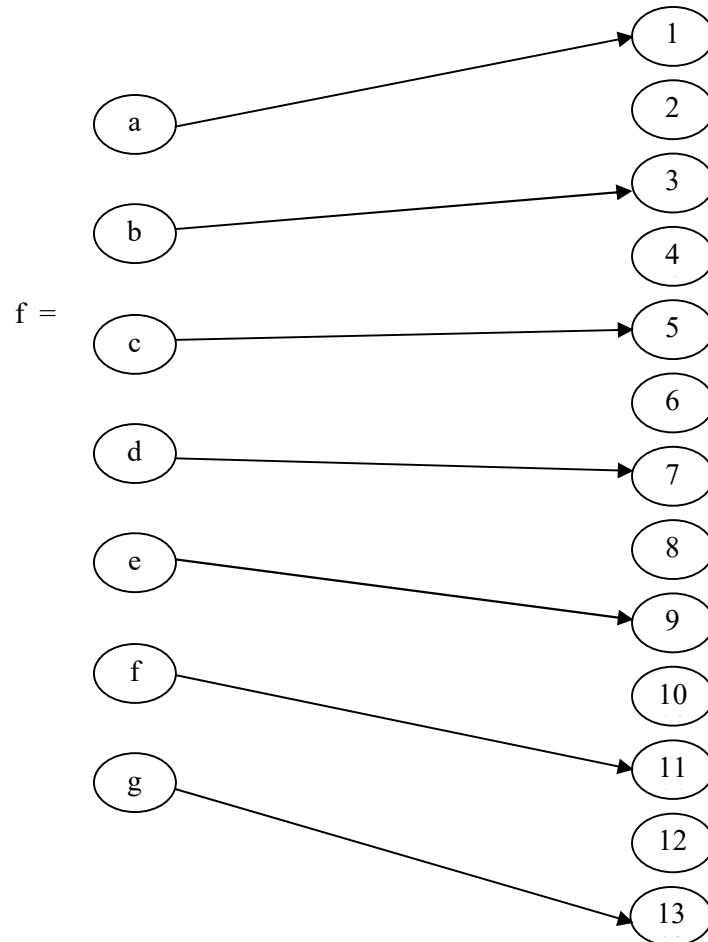

Figure 1.3

The domain $D(f) = T = \{a, b, c, d, e, f, g\}$ and the codomain of f is

$$V = \{1, 2, 3, 4, 5, 6, 7, 8, 9, 10, 11, 12, 13\}.$$

Range of f ;

$$\text{Range}(f) = \{1, 3, 5, 7, 9, 11, 13\} \subseteq V = \text{codomain of } f.$$

Clearly f is a 1 - 1 function which is only injective.

Now f is a 1 - 1 function on a subset of V then the restriction of f has an inverse.

We will give an example of a one-to-one function g .

Consider the sets $S = \{10, 20, 30, 40, 50, 60\}$ and

$$V = \{x, y, z, w, v, u\}.$$

Let $g: S \rightarrow V$ given by

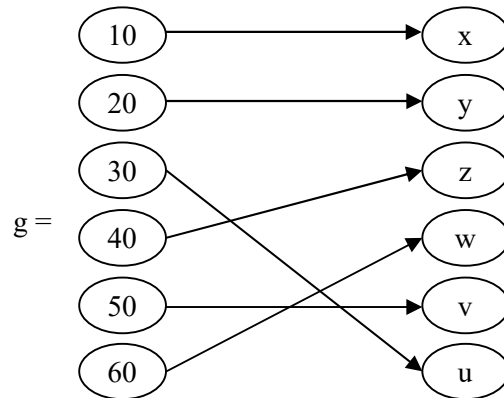

Figure 1.4

We see g is a one to one function which is bijective.

In fact $\text{range of } g = \text{range}$ and $V = \text{codomain of } f$.

g^{-1} that is inverse of g exists as for $(t, u) \in S$ the relation
 $(u, t) \in S$.

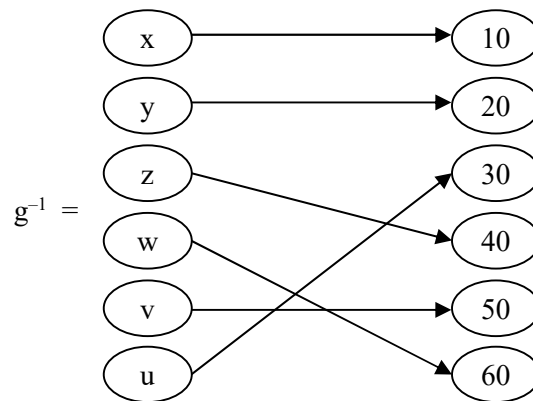

Figure 1.5

g^{-1} is also a one-to-one bijective function / map.

We see $g \circ g^{-1}$ and $g^{-1} \circ g$ are identity functions from S to S given by the following figure $g \circ g^{-1}$ is given by

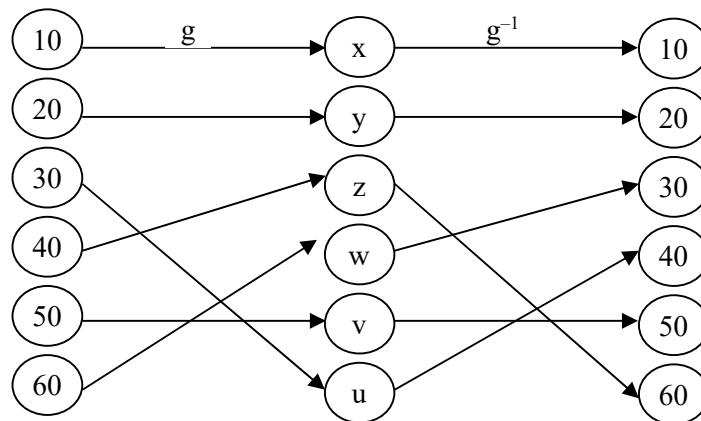

Figure 1.6

Thus $g \circ g^{-1}(x) = x \in S$.

So $g \circ g^{-1} : S \rightarrow S$ is the identity function on S which is always one to one and bijective.

Consider the map $g^{-1} \circ g$ which is given by the following figure.

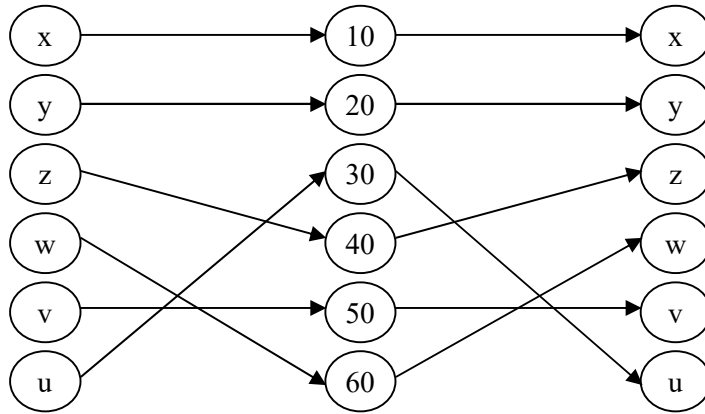

Figure 1.7

$g^{-1} \circ g(x) = x$ for all $x \in V$.

Thus $g^{-1} \circ g$ is the identity function from V to V which is always one to one and bijective on V .

We have also given examples of injective one to one maps which are not bijective.

Now we proceed onto describe onto map by some examples.

Example 1.12. Let $S = \{5, 10, 15, 20, 25, 30, 35\}$ and

$B = \{a, b, c, d, e, f, g\}$ be two sets.

Consider the map $h : S \rightarrow B$

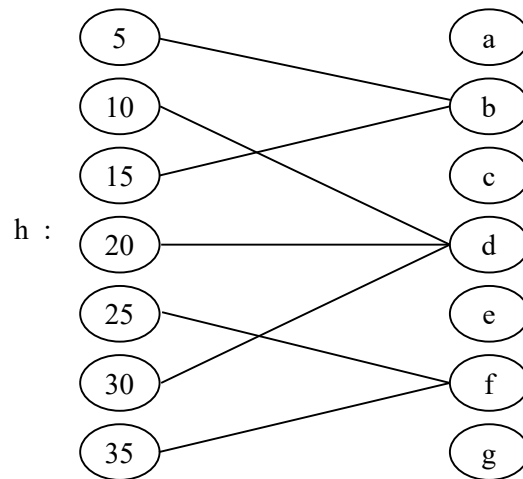

Figure 1.8

Clearly h is a onto map. It is neither injective nor bijective.

This sort of onto mappings has lot of relevance computer science applications.

For we do very easily the clustering and measure the distance etc.

So many to one maps are a boon in our study.

We can also have another type of onto mapping / functions which is described in the following.

Example 1.13. Let $P = \{a, b, c, i, d, e, f, g, h\}$ and

$$Q = \{10, 15, 20\}.$$

Let $m: P \rightarrow Q$ be defined as follows.

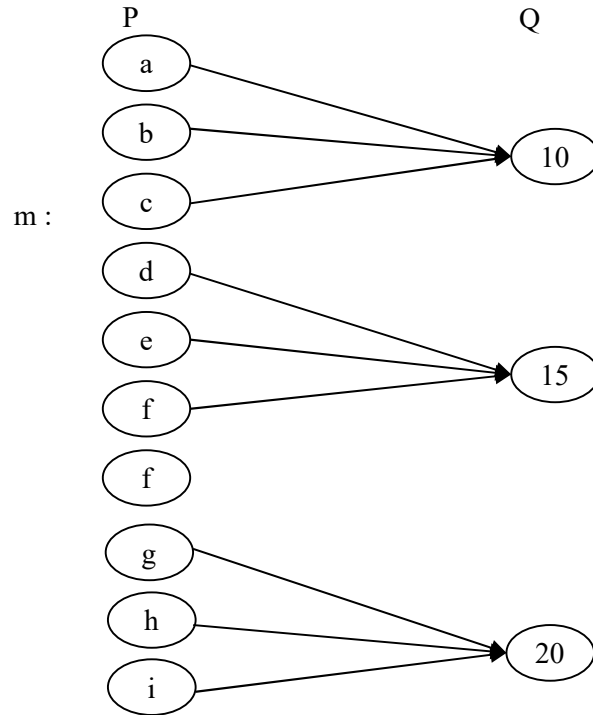

Figure 1.9

Clearly m is an onto mapping and not injective or bijective however very different from example 1.13 for in that example $|S| = |B| = 7$ but the elements a, c, e and g are left out in the codomain.

Consider the example $|P| = 9$ and that of Q is 3. This gives way to three clusters and no element is left out in the codomain of m .

Clearly codomain of $m = \text{range of } m$.

Example 1.14. Consider the set $S = \{m, n, o, p, q, r, s\}$ and

$$T = \{3, 6, 9, 12\}.$$

Let w be a map from S to T given in the following

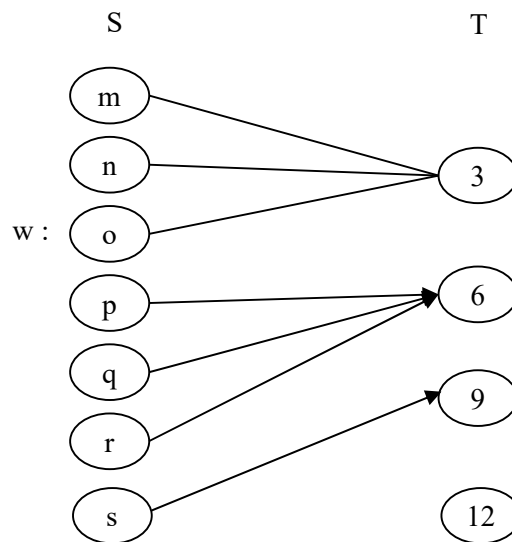

Figure 1.10

We see w is an onto function this map has produced 3 clusters viz $\{m, n, o\}$ associated with 3.

$\{p, q, r\}$ associated with 6 and $\{s\}$ associated with 9 and 12 is left out $|S| = 7$ and $|T| = 4$.

However codomain of $w \neq \text{range } w$ as 12 is left out range

$$w = \{\text{codomain of } w\} \subseteq T;$$

that is range of w is only a proper subset of codomain of $w = T$.

Now we provide examples of mappings / functions from two linguistic sets associated with two different linguistic variables which fall under the preview of classical maps.

Example 1.15. Let us consider the set of 9 persons belonging to different sets of age group.

We will denote the person by the set

$$S = \{a, b, c, d, e, f, g, h, i\}.$$

Let $P = \{\text{very young, very old, young old, just old, medium age (middle aged), oldest, very old, youngest}\}$ be the linguistic set / term associated with the linguistic variable age.

Consider the semilinguistic map connecting the group of people from the set S to the linguistic set P associated with the linguistic variable age of people.

The map or function p is from a usual set of people to the linguistic set; P which describes the age of people in linguistic terms.

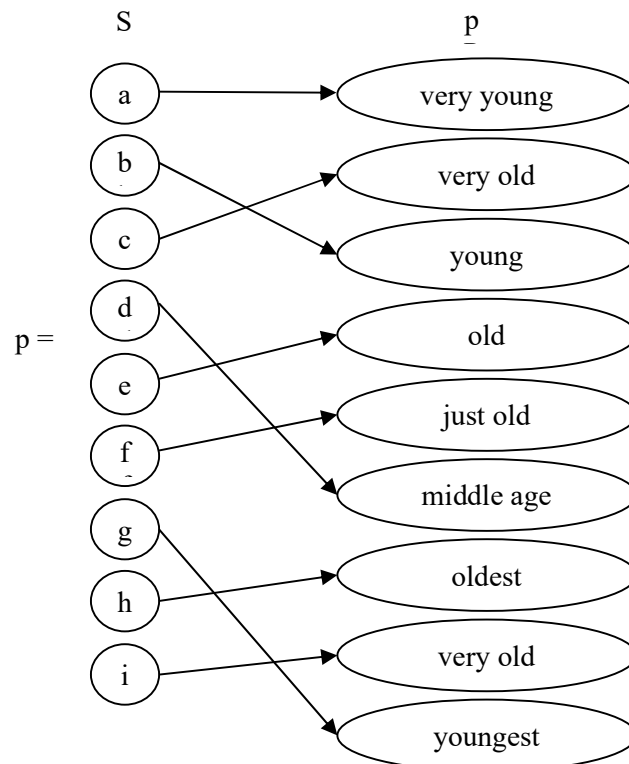

Figure 1.11

This is a one-to-one semilinguistic function or semilinguistic one to one function which is also semilinguistic bijective function or by default of notation also known as bijective semilinguistic function as the persons belong to different age groups.

We call these as semilinguistic function as both the sets under consideration are not linguistic sets only one of them is a linguistic set.

On the other hand if we have say some persons in different age groups given by the set

$P = \{p_1, p_2, p_3, \dots, p_{12}\}$ and the linguistic set / terms given by the

$W = \{\text{young, very young, old, very old, just old, just young, youngest, middle aged, very very young}\},$

the one associated with the linguistic variable age given by the following figure 1.12.

It is pertinent to keep on record that the set P is only an ordinary or classical set of 12 people in different age groups. It is not a linguistic set. However, W is a linguistic set / term.

Let η be the semilinguistic function which is as follows.

We see the semilinguistic map is onto and not bijective. Further range of η is only proper subset of the codomain set which is a linguistic set.

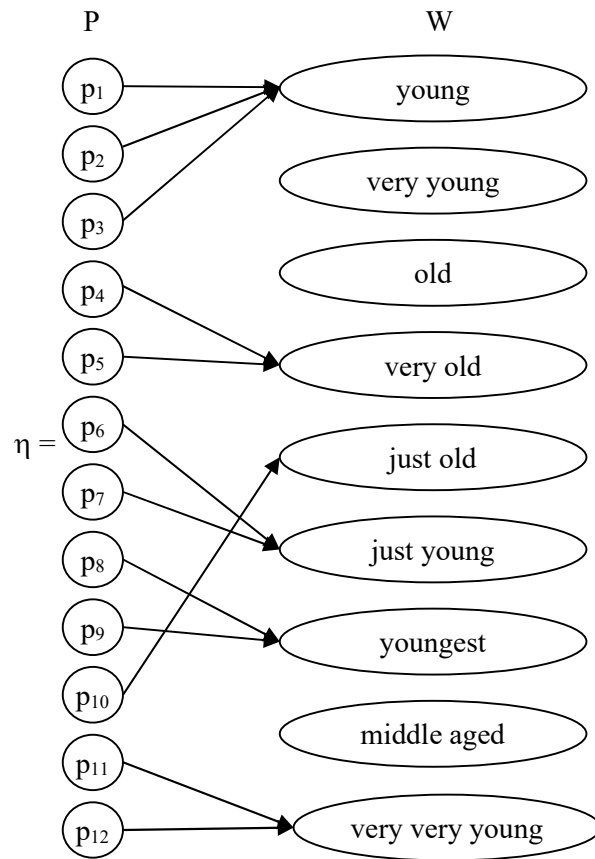

Figure 1.12

Now we provide some more examples of semilinguistic functions / maps.

Example 1.16. Let $S = \{s_1, s_2, s_3, s_4, \dots, s_{10}\}$ be the set of 10 children in a classroom.

Let $I = \{\text{good, very good, bad, poor, fair}\}$

be a linguistic set / term associated with the linguistic variable the performance of these ten students in the classroom. S is only an ordinary classical set.

Let S be the semilinguistic map from S to I given in the following.

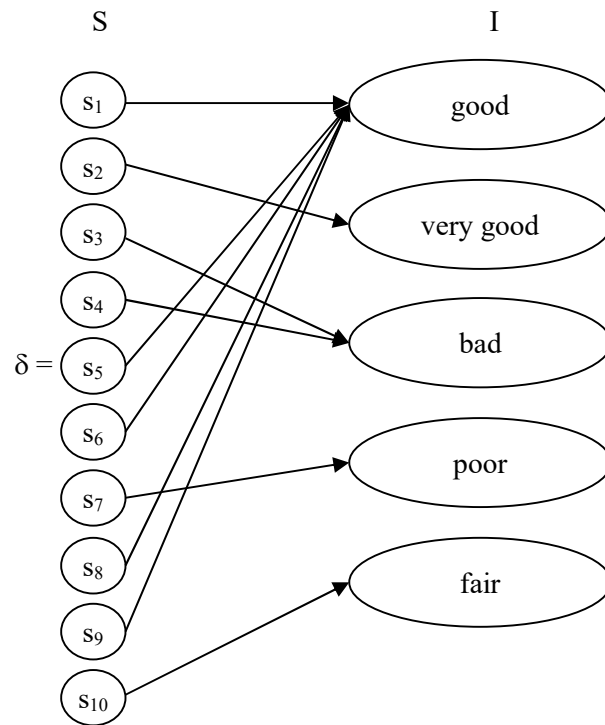

Figure 1.13

We see δ is a semilinguistic map which is onto.

In fact δ is an onto function, however the codomain of δ is the same as the range δ .

Now we have given only semilinguistic maps which are classical maps. However, we can also have in case of semilinguistic maps few types of functions / maps which are not classical.

We will first illustrate this situation by some examples.

Example 1.17: Consider the classical set

$$S = \{a_1, a_2, a_3, a_4, a_5, a_6, a_7\}$$

of six persons which colour of the eyes are mapped. Let P be the linguistic set

$P = \{\text{grey, brown, green, hazel, light brown and dark brown}\}$ associated with the colour of the eyes of people all over the world.

Consider the map μ from $S \rightarrow P$ given by the following figure

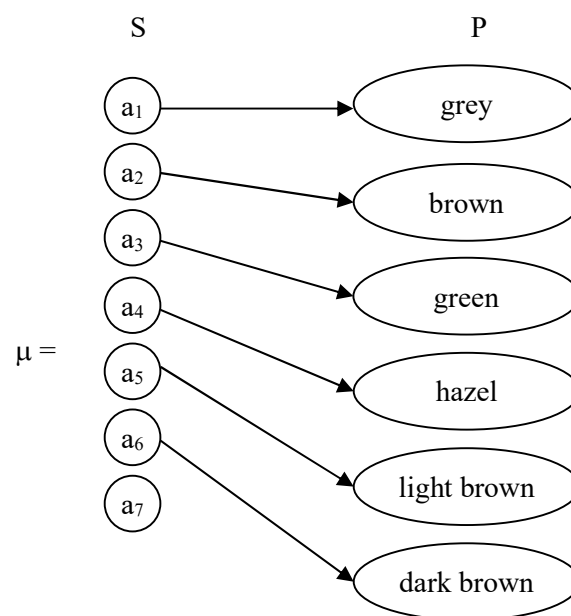

Figure 1.14

Clearly μ is a one-to-one semilinguistic map / function of type I as a_7 cannot be mapped with any of the given linguistic

terms of the set P as the colour of the eyes of a_7 is red and violet as he/she suffers from some disease.

Now having seen type I semilinguistic maps / functions we proceed define this as follows.

We call this type I semilinguistic map / function and one to one and not bijective and none of these semilinguistic functions can be bijective if they fall under types where all elements of the domain space are not given representation in the range / codomain space.

Next, we show by example type II and type III semilinguistic maps / functions.

Example 1.18. Let us consider 9 workers working in an industry. We first give some linguistic set/term by which the industry/company assess their work performance. Only in 5 categories, if their work performance does not fall under these 5 categories they will be sent out from their job.

$$\text{Let } S = \{w_1, w_2, w_3, w_4, w_5, w_6, w_7, w_8, w_9\}$$

be the set of 9 workers whose work performance is to be measured. Clearly S is not a linguistic set only a classical set.

$$\text{Let } P = \{\text{good, very good, fair, just good, just fair}\}$$

be the set which measures the work performance.

Clearly P is a linguistic set / term associated with the linguistic variable performance aspects of workers in a particular industry.

Let f be the linguistic map defined by the following figure.

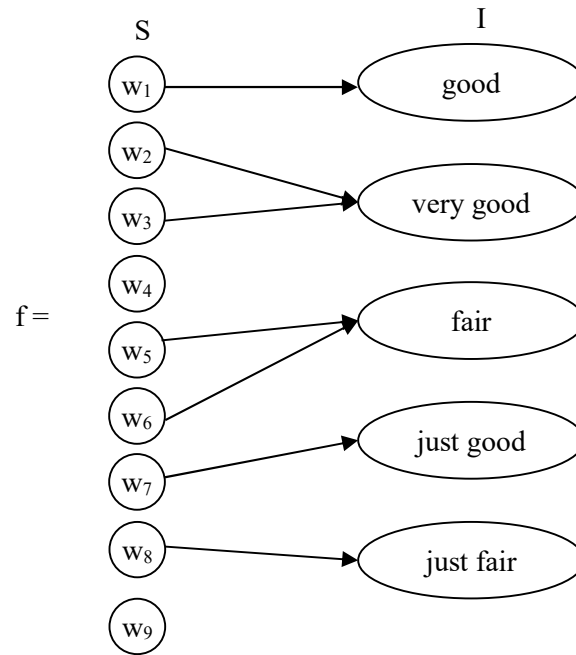

Figure 1.15

Clearly f does not fall under any of the classical maps of semilinguistic maps / functions.

We call f is a special semilinguistic map of type II. For elements in the domain space of f has elements for which $f(w)$ does not associate itself with an element in the range space and further f is not one to one for other elements.

Clearly in this case we see the elements w_4 and w_9 in S are not mapped. This sort of map never fall under the category of classical maps.

Now consider the form of semilinguistic maps of type II given by the following figure 1.16.

Some other experts for the same set of S and P gives a different function g given by the following figure.

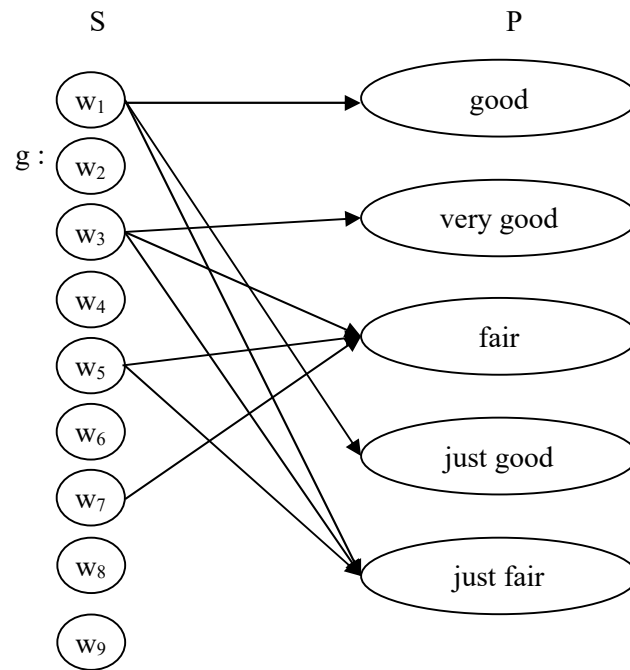

Figure 1.16

Clearly g does not fall under any of the classical maps neither do they fall under any of the semilinguistic maps.

We see g is not also semilinguistic map / function of type II.

So only we define this semilinguistic maps / function as type III linguistic maps when some elements / terms of the domain space under g are mapped to more than one member in the codomain space and some of the terms in the domain space find no element in the range space.

Next, we proceed onto give an example of a semilinguistic map / function of type IV.

Example 1.19. Let

$$S = \{a_1, a_2, a_3, a_4, a_5, a_6, a_7, a_8, a_9, a_{10}, a_{11}, a_{12}\}$$

be a set of persons whose height is to be measured and let

$$P = \{\text{very tall, tall, medium height, just tall}\}$$

be linguistic set associated with the linguistic variable height of persons.

Let $\eta: S \rightarrow P$ be a semilinguistic map given by the following figure.

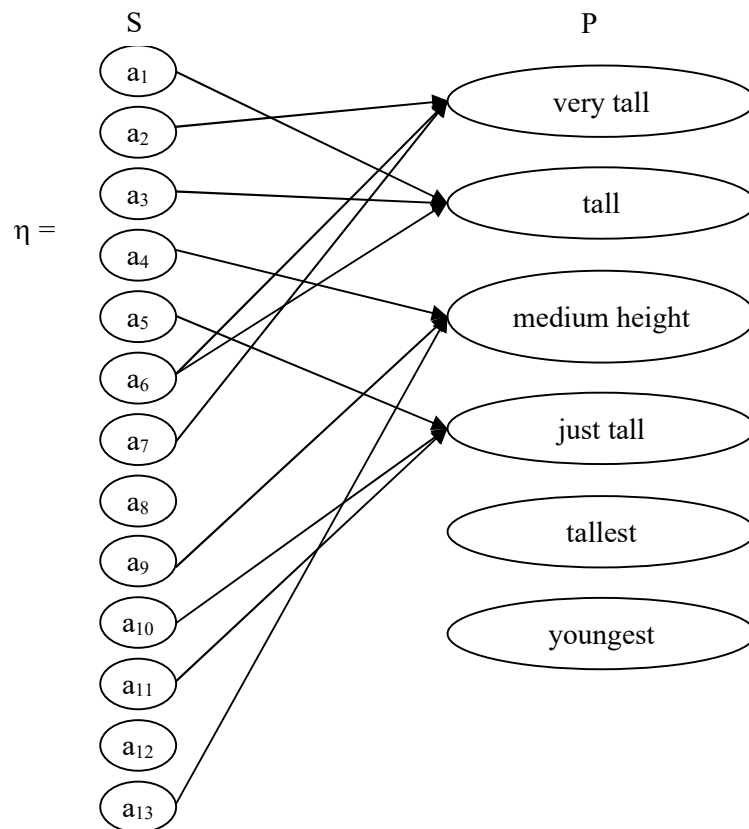

Figure 1.17

This is an onto semilinguistic map of type IV.

Now we proceed to abstractly first define classical semilinguistic functions / maps.

Definition 1.5. Let S be a classical set P be a linguistic set associated with some linguistic variable L . Let g be a map / function from S to P , that is $g: S \rightarrow P$.

If every element in S has a unique element in P , that is for x and $y \in S$ we have $g(x), g(y) \in P$, then we define g as the classical function or map.

If every element in S has a unique element in P , that is for x and $y \in S$

$g(x) = g(y)$ implies $x = y$ then we define g to be a one-to-one semilinguistic map which is injective if

$\text{codomain } g \neq \text{range } g$.

If on the other hand if g is a one-to-one semilinguistic map which is bijective such that

$\text{codomain } g = \text{range of } g$ then we call that g as a bijective semilinguistic map.

Now suppose we have a semilinguistic function g defined on S which is an onto map then we define that g as a linguistic map, we see onto semilinguistic maps are of two varieties

a) We may have $\text{codomain of } g = \text{range } g$ or

b) $\text{codomain of } g \neq \text{range of } g$ and

$\text{range of } g = \text{range } g$ is a proper subset of the codomain of g .

We have given examples already to this effect.

Definition 1.6. Let S be a classical set and P be a linguistic set.

A semilinguistic map can be of the following types.

- i) A semilinguistic map $g_1 : S \rightarrow P$ which is such that g_1 is a linguistic function such that there are elements in S which has no corresponding elements in codomain. But

$$\text{codomain of } g_1 = \text{range } g_1$$

such semilinguistic maps we define as type I semilinguistic maps or functions.

- ii) Let $g_2: S \rightarrow P$ we say g_2 is a semilinguistic map of type II if one element S is mapped onto one elements of P and some elements in S are left out under g_2 and

$$\text{codomain } g_2 = \text{range } g_2.$$

- iii) Let $g_3: S \rightarrow P$; g_3 is defined as a semilinguistic function of type III if one element in S is mapped onto several distinct elements in P . Some element can be left out in S .

- iv) A semilinguistic map g_4 is defined to be a type IV semilinguistic map if for some element S we have a unique element in P and some elements are left out both in S and P , that is

$$\text{codomain } g_4 \neq \text{range } g_4.$$

Now having seen examples of semilinguistic maps we proceed onto describe by examples first the notion of classical linguistic maps.

Example 1.20: Let S and T be two linguistic sets associated with the linguistic variables age and height of a persons respectively. Let

$S = \{\text{old, young, very young, middle aged, youth, just old}\}$ and

$T = \{\text{tall, very tall, short very short, medium height}\}$

be the linguistic sets or terms.

Consider the linguistic function $f: S \rightarrow T$ given by the following figure.

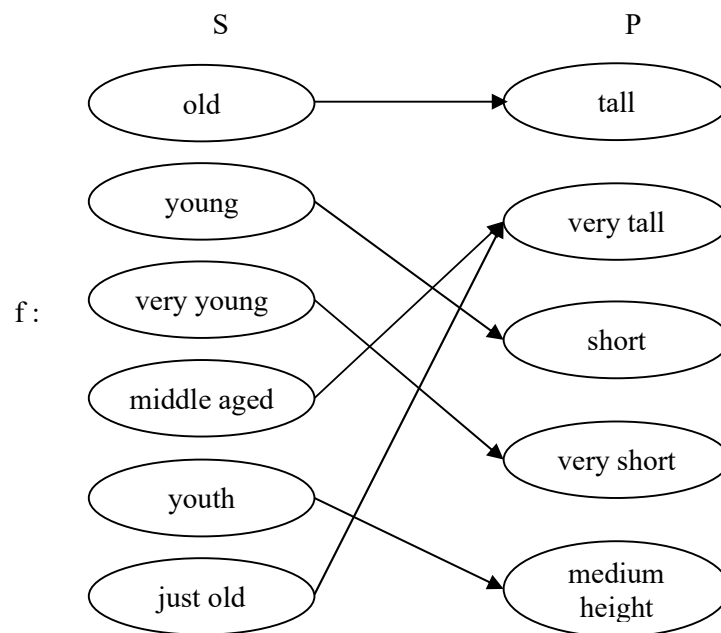

Figure 1.18

Clearly f is a linguistic function / map of S to T .

Here $\text{range } f = \text{codomain of } f$.

However f is not one to one it is onto.

Example 1.21. Consider two linguistic sets S and T associated with the linguistic variables weight of persons and age of persons respectively. Consider the linguistic set

$$S = \{\text{light, very light, heavy, very heavy, medium weight, just heavy, just light, heaviest}\}$$

be the linguistic set / term associated with the linguistic variable weight of people.

$$T = \{\text{old, young, oldest, very old, middle age, just young, just old, youth}\}$$

be the linguistic set / term associated with the linguistic variable age of people.

Let $g: S \rightarrow T$ be a linguistic map from S to T defined in the following.

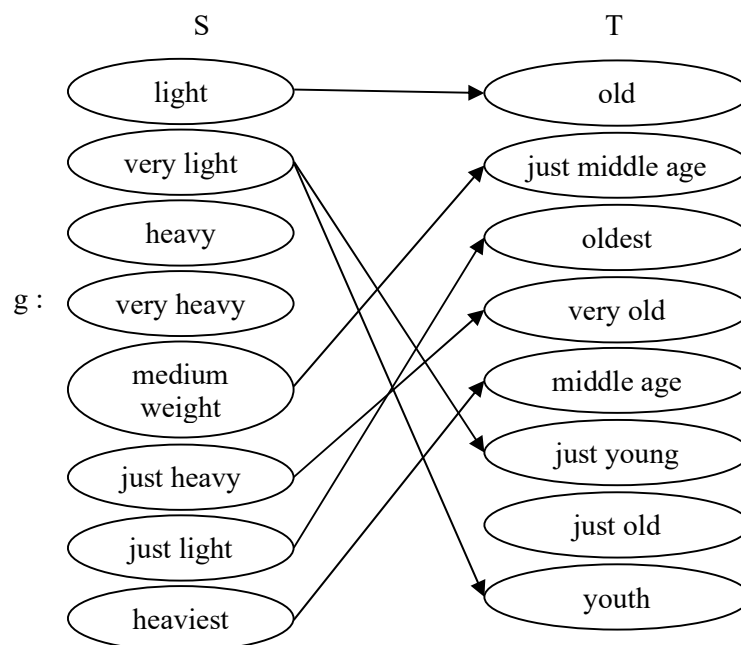

Figure 1.19

Clearly g is bijective linguistic map/function.

Next, we provide another example of onto linguistic function. We can in an analogous way define linguistic functions of all the four types.

Example 1.22. Let us consider two linguistic set S and T associated with two linguistic variables performance of students and performance of teachers respectively, were

$S = \{\text{good, very good, average, poor, very poor, bad, very bad}\}$
and

$T = \{\text{devoted, careless, lazy, very devoted, very lazy, indifferent, fairly performed}\}$

are linguistic sets associated with linguistic variables performance of students and performance of teachers respectively.

Let $\eta : S \rightarrow T$ be a linguistic map given by the following figure.

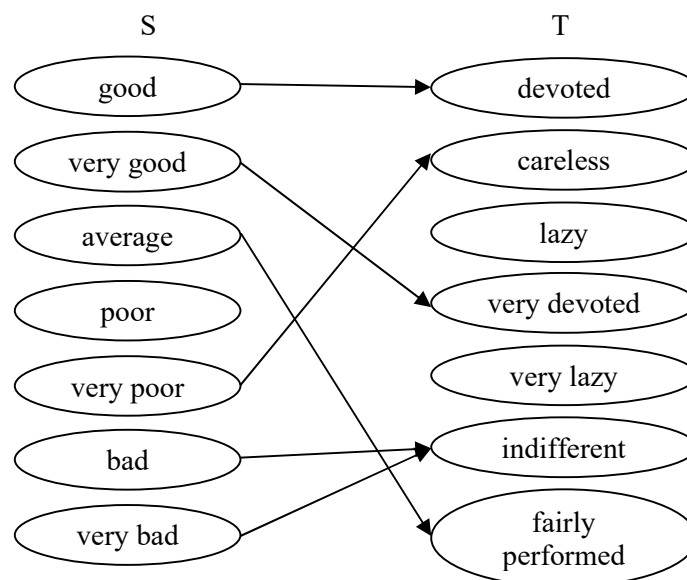

Figure 1.20

Clearly η is an onto linguistic function.

Example 1.23. Let W and V denote the linguistic sets associated with the linguistic variables quality of the products and customers recommendations of these products respectively.

$W = \{\text{good, best, just good, very good, bad, very bad}\}$
and

$V = \{\text{good, very good, bad, very bad, average}\}$

be the linguistic sets associated with the linguistic variables quality of products and recommendations of products respectively.

Let $\delta: W \rightarrow V$ be a linguistic function from W to V given by the following figure.

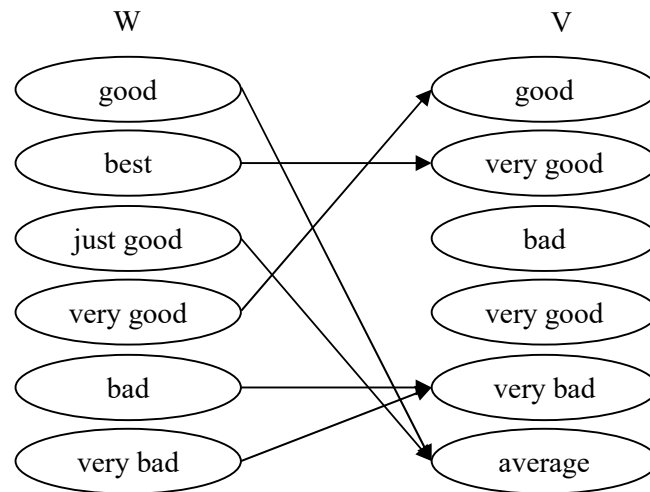

Figure 1.21

δ is an onto linguistic map we see $\text{range } \delta \subsetneq \text{codomain of } \delta$.

That is δ is only a onto linguistic map such that range of δ is a proper subset of codomain of δ .

We provide some more example of a special linguistic functions which do not fall under the classical functions.

Example 1.24. Consider two linguistic sets S and T associated with the linguistic variables heights of the paddy plants and yield respectively.

$S = \{\text{tall, just tall, stunted, very stunted, tallest, average height, just short, most stunted, very short, short}\}$ and

$T = \{\text{very good, good, average, just average, bad and very bad}\}$ be the linguistic sets associated with the linguistic variables heights of the paddy plants and yield of these plants.

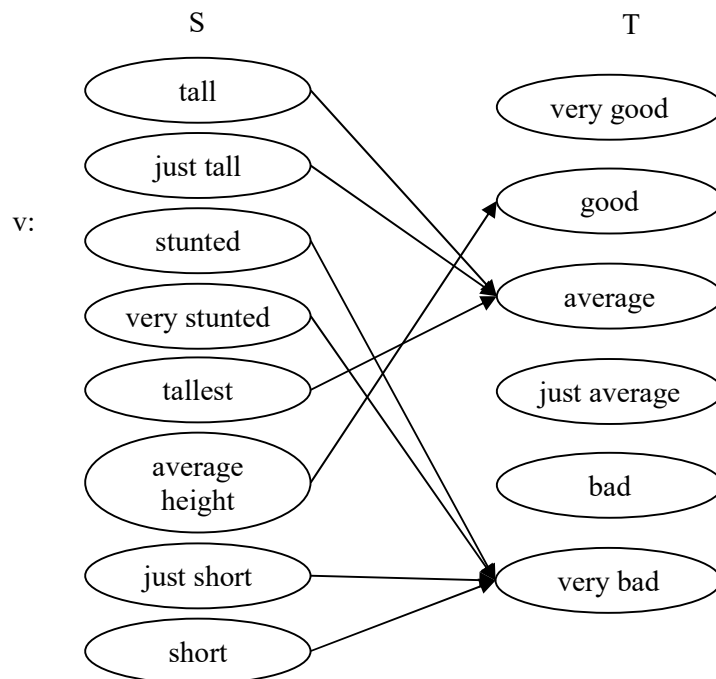

Figure 1.22

It is to be kept on record according to some experts if the crop grows very tall and tall than its average height the yield is not very good for the energy of the plant is spent on growth and not on the production.

Let $v: S \rightarrow T$ be a linguistic map given by the following figure.

Clearly v is a linguistic map which is onto where as in this case

codomain of $v \neq \text{range } v$.

Thus range of v is a proper subset of codomain of v .

Several elements in are S mapped onto a single element in T .

Next we proceed onto view the linguistic term most stunted in S , the expert have not put any linguistic term in T . Thus the linguistic term “most stunted” is left in the domain of v . So this linguistic map v does not fall under any of the classical maps / functions.

We define this linguistic function as a onto linguistic function of type III.

We now describe the notion of one to one linguistic function of type I by an example.

Example 1.25. Let S and T denote the linguistic sets associated with the linguistic variables companies profit/functioning and the workers quality respectively.

$S = \{\text{high, highest, very high, low, moderate, very low, loss, big loss}\}$ and

$T = \{\text{efficient, devoted, lazy, evading, indifferent, just medium, dodging}\}$

be the linguistic sets associated with the linguistic variables companies profit / loss and workers quality of working respectively.

Let us define a linguistic function $f: S \rightarrow T$ given by the following figure. It is also pertinent to keep on record that all the examples we give are just examples for the reader to understand them.

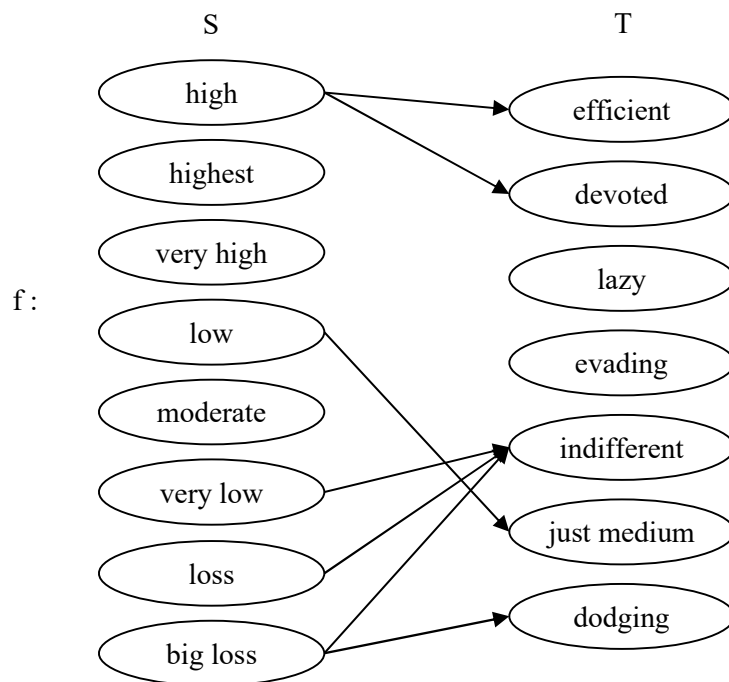

Figure 1.23

This is the way we obtain the linguistic map f . Clearly f is not any of the classical maps.

It is only a special type II linguistic maps where some elements of domain of f cannot be matched with codomain of f .

Further range of f is only a proper subset of codomain of f .

The linguistic terms highest, very high, moderate cannot be matched with any of the codomain of f as we have no matches who work moderately or very efficiently.

This is onto linguistic function of type II.

This is different from classical maps as element in the domain of f is mapped to two distinct elements in codomain of f . For instance, big loss the linguistic term in domain of f is mapped onto two distinct terms indifferent and dodging, which is not possible in classical maps.

Likewise, the linguistic term high in the domain of f , is mapped onto two different linguistic terms efficient and devoted in the codomain of f .

Next we proceed onto give examples of one to one bijective and one to one injective linguistic functions of type I.

Example 1.26. Let us consider the two linguistic sets S and T associated with linguistic variables quality of the mango fruits and size of the mango fruit.

$$T = \{\text{large, just large, medium, very medium, small, just small, very small}\}$$

be the linguistic set associated with the linguistic variable size of the mango fruit and let

$S = \{\text{high quality, just high less quality, medium quality, quality, very bad quality, bad quality}\}$

be the linguistic set associated with linguistic variable quality of mango fruits.

Usually, the quality of the mango fruit is more dependent on the size of the fruit. For each type of mango fruit is associated with a specific size. So using that size and quality only we define the linguistic map / function.

The linguistic function is defined by the following figure.

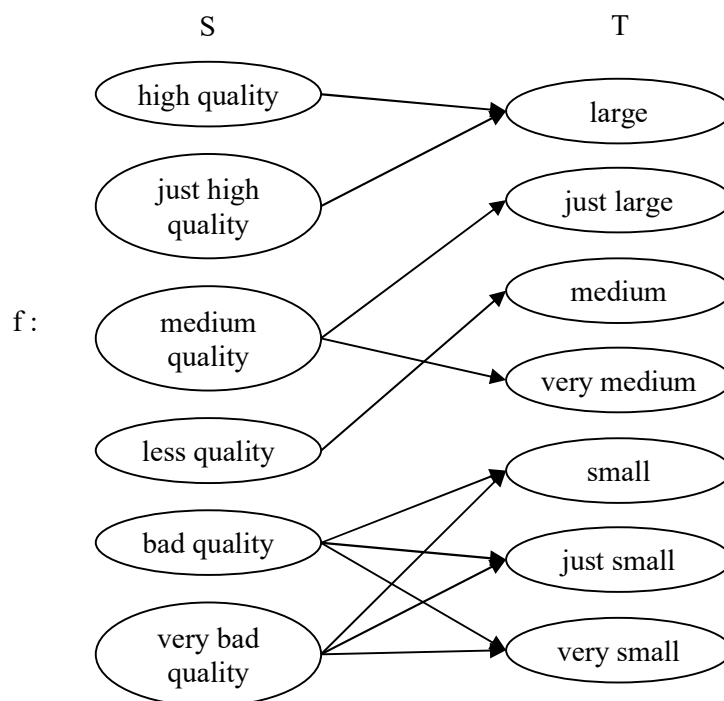

Figure 1.24

Now we see this is a linguistic map of type I as bad quality of the domain of f is mapped onto three elements in the codomain of f viz.

$$\{\text{small, just small, very small}\}.$$

Similarly, very bad quality is also mapped onto

$$\{\text{small, just small, very small}\}$$

of the codomain of f .

Thus, we get a pair of cluster one cluster from the domain of f given by

$$\{\text{bad quality, very bad quality}\}$$

and that of the cluster from codomain of f is

$$\{\text{small, just small, very small}\}.$$

Also corresponding to the linguistic term “medium quality” of the domain of f we have two linguistic terms associated with it

$$\{\text{just large, very medium}\}$$

of the codomain of f yielding another cluster.

Now clearly $\text{range of } f = \text{codomain of } f$.

Now having seen different types of linguistic functions we proceed onto define these concepts abstractly in the following.

We have already defined linguistic function / maps which are classical. These classical form of linguistic function/maps can be injective one to one linguistic map which is similar to classical injective one to one map.

Similarly bijective one to one linguistic map which is similar to classical bijective one to one classical map/function. Finally onto linguistic map which is similar to onto classical function / map.

However the linguistic functions/maps of type I, type II type III and type IV do not fall under any of these classical maps for they can be deviant or different in classical one.

- i) These linguistic maps of type I or type II or type III or type IV can have linguistic terms left out in the domain of f ; which is impossible by definition of classical function or maps.
- ii) Linguistic maps of type I or type II or type III or type IV can have for any one linguistic term of domain space mapped onto more than one linguistic term in the codomain space of f .
- iii) Linguistic maps f of type I or type II or type III or type IV can satisfy both (i) and (ii) mentioned above.

This is the basic difference between linguistic maps of type I or type II or type III or type IV the classical maps / functions.

With these in mind we can also define linguistic function composition of linguistic maps of all type or the classical form of linguistic functions.

First we illustrate this situation by some examples.

Example 1.27. Let S , T and V be three sets of linguistic sets associated with three linguistic variables height of paddy plants, yield of paddy plants and colour of the leaves of the paddy plants respectively.

The linguistic set

$$S = \{\text{very tall, tall, just tall, medium height, stunted height, very stunted height}\}$$

is associated with the linguistic height of the paddy plants.

$$T = \{\text{good, just good, medium, high, very poor, low, very low, poor}\}$$

be the linguistic set associated with the linguistic variable yield of the paddy plants.

$$V = \{\text{yellow, brown dots on leaves, light green, brown, dark green, green}\}$$

be the linguistic set associated with the linguistic variable colour of the leaves of the paddy plant.

According to experts the colour of the paddy leaves also has some impact on yield.

Let $f: S \rightarrow T$ be a linguistic function defined by the following figure;

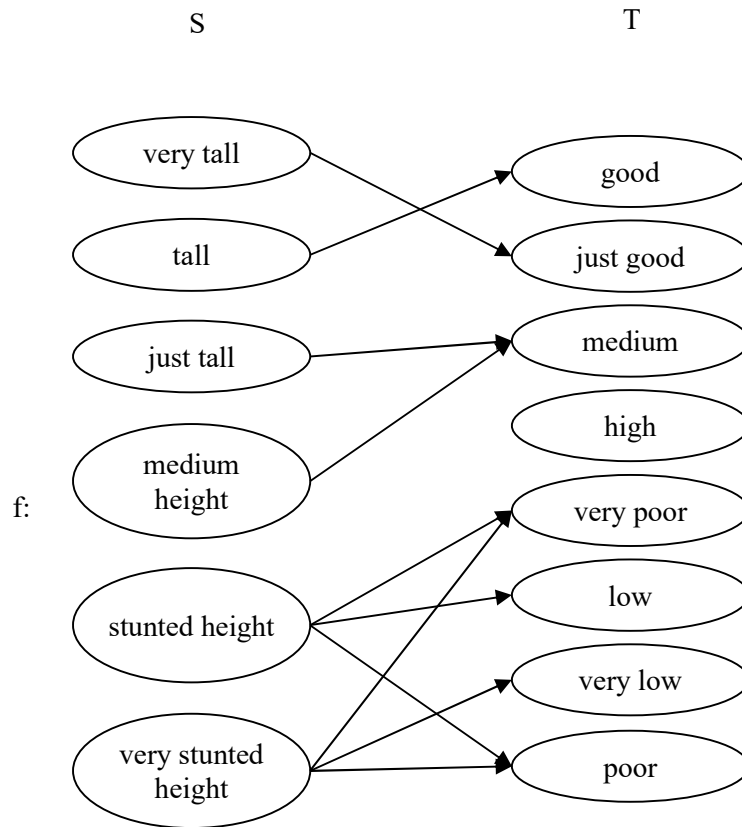

Figure 1.25

Clearly f is a linguistic function of type II.

Let $g: T \rightarrow V$ be the linguistic function defined from T to V given by the following figure;

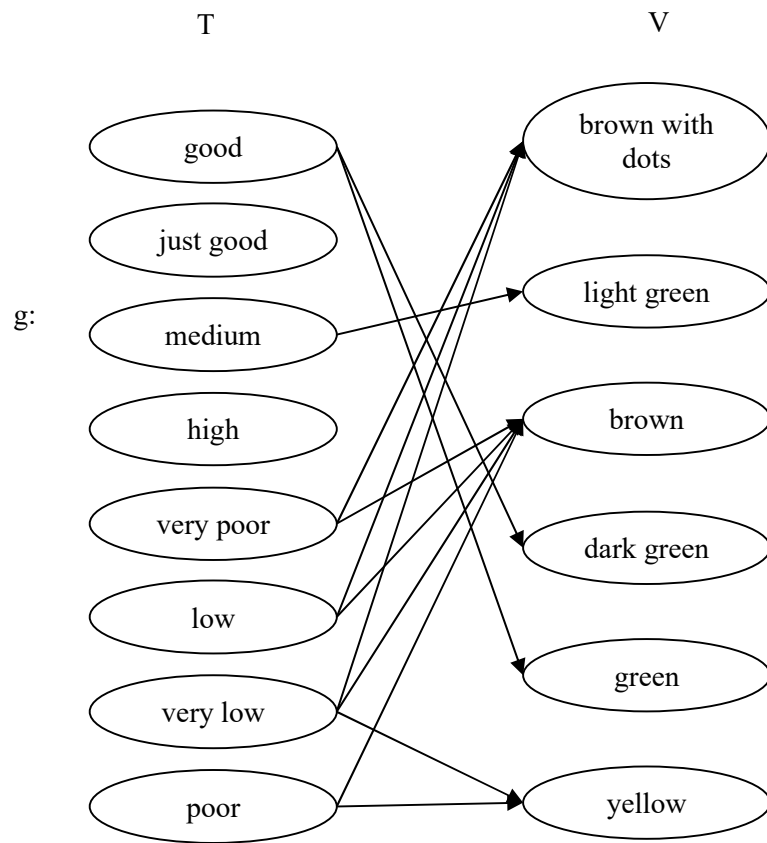

Figure 1.26

Consider the composition of $f \circ g$ given by the following figure.

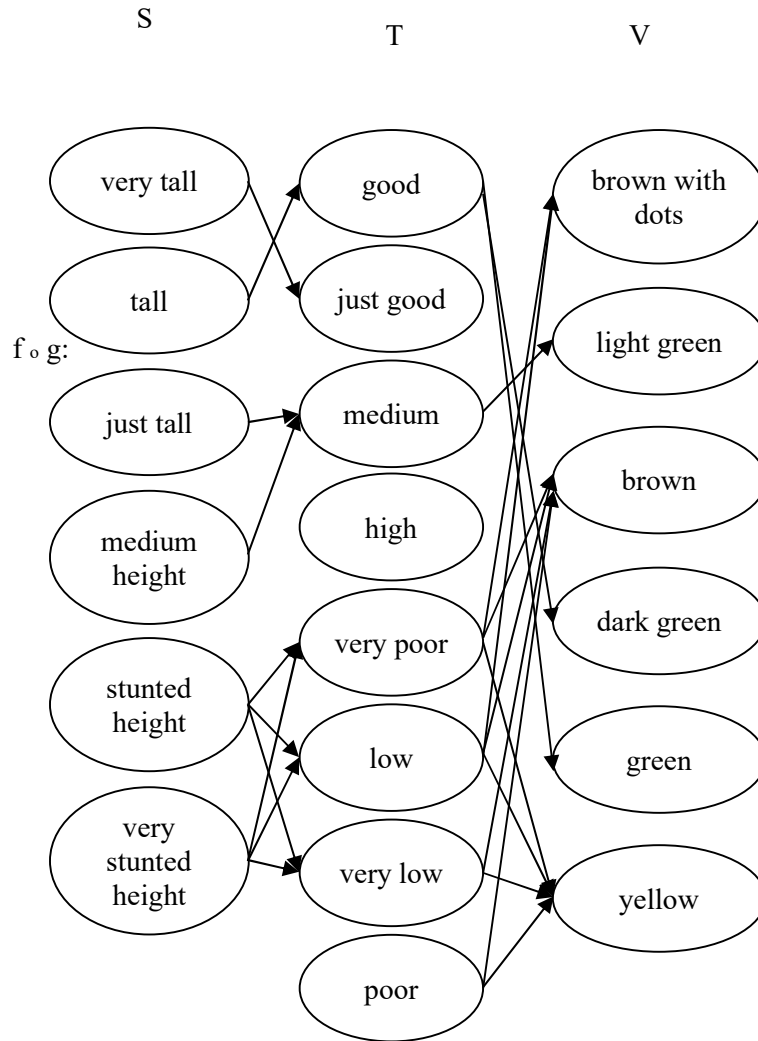

Figure 1.27

Now we find $f \circ g$ (very tall) is blank.

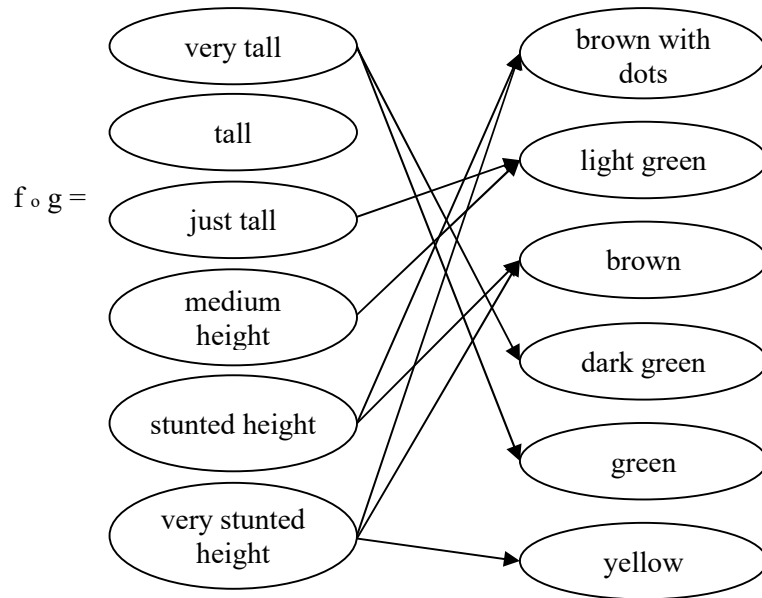

Figure 1.28

We $f \circ g$ is also linguistic map of type II for in the domain space of $f \circ g$ the linguistic term very tall is left out.

Thus, indirect association or which we call as hidden map does relate in a special way.

As in case of classical maps we can define in case of linguistic maps of any type combine two linguistic maps f and g provided the codomain of f is the domain of g . This is the short rule for combined linguistic maps of any type.

Now we proceed onto suggest a few problems for the reader.

Solving them will make the reader familiar with this new notion. However, stated problems are difficult to solve by beginners.

PROBLEMS

1. Give examples of linguistic variables to which we can have linguistic sets of finite order.
2. Give examples of linguistic variables which have linguistic sets of infinite order.
3. Can we say all linguistic sets of infinite order are totally orderable?
4. Can we say all linguistic variables associated with linguistic sets which yield linguistic continuum are always time dependent?
5. Give 5 examples of time dependent linguistic variables which have linguistic continuum associated with them.
6. Does there exist time dependent linguistic variables which do have the linguistic set which are not linguistic continuums?
7. Consider the linguistic variable; performance aspects of school children in the class room and the qualities of the teacher as another linguistic variable.
 - i) Give the corresponding linguistic sets/terms of the above-mentioned linguistic variables.

ii) If S and T are the linguistic sets corresponding to the linguistic variables associated with student performance and teacher quality of tackling the students respectively.

a) Find the linguistic function f .

b) Draw the linguistic graph related with f

c) Under which type does this linguistic function f fall?

8. Let $T = \{\text{good, bad, best, very bad, very good, fair, just good, just fair}\}$

be the linguistic set / term associated with the linguistic variable, performance aspects of the 15 students; $S = \{s_1, \dots, s_{15}\}$ are the students 15 students.

i) Define $f: T \rightarrow S$ as the semilinguistic onto function from T to S .

ii) Is $\text{range } f = \text{codomain of } f$?

iii) Is f given by you unique or can reasonably vary from expert to expert? Justify your claim?

9. Enlist all special features associated with semilinguistic maps / functions.

10. Give an example of semilinguistic function of type I.

11. Describe by an example semilinguistic function of type II.

12. How is semilinguistic function of type I different from linguistic function of type II?
13. Can we say type I is type II and vice versa? Justify your claim?
14. What are the special features associated with semilinguistic maps of type III.
 - a) How is it different from type II and type II semilinguistic maps?
15. Give an example of a semilinguistic function of type III and type IV.
16. Does there exist any relation between semilinguistic functions of type I, type II, type III and type IV?
- 17*. Describe by an example type IV semilinguistic function. Is it different from type I, type II and type III semilinguistic functions? Substantiate your claim.
18. Is every linguistic function a classical function? Justify your claim!
19. How is a linguistic function of type I cannot be a classical function? Illustrate by an example.
20. What is the difference between a linguistic function and semilinguistic function of different types?
21. Give example of each of the linguistic functions of all types?

- 22*. Are different types of linguistic functions related in any manner? Substantiate your claim.
23. Obtain conditions under which linguistic functions of 2 different types be combined.
 - a) What is the resultant of the composition?
 - b) Will they be different from these types?
24. Is it possible to combine two semilinguistic functions of different types? Justify your claim.
25. Give an example of a onto linguistic function of different types.
26. Give an example of a semilinguistic function of type IV.
27. Can one combine a semilinguistic functions of different types?
 - i) Will it be only a semilinguistic function?
 - ii) Can linguistic functions be the resultant?
28. Give an example of a linguistic function of that types which maps one element of domain space to several elements of the codomain space.
29. Show by an example, a semilinguistic function of type III that is different from the semilinguistic function of type II.

30. Use linguistic functions of various types to study the real world problem of density of plantations, soil quality and water supply.
31. What is the advantage of using linguistic functions of various types in the place of usual classical maps? Justify your claim.
32. What is the limitation of semilinguistic maps in the place of classical maps and vice versa?
33. Under what conditions one can have a semilinguistic function f combined with a linguistic function g yield (i) $f \circ g$ as a semilinguistic map (ii) Will $g \circ f$ be a linguistic map?
- 34*. Can we define semilinguistic functions using the linguistic variable indeterminate?

Chapter Two

LINGUISTIC MAPS, FUNCTIONS AND THEIR PROPERTIES

In the last chapter we have defined the notion of linguistic variables and the associated linguistic sets which are only words/terms. We have also discussed about ordering and partial ordering of these linguistic sets or terms. In fact we have also described those linguistic sets which are neither partially ordered nor totally ordered or unordered.

Now when we speak about linguistic sets associated with a linguistic variable we have the following.

First, we mention a word (or note) of caution. Unlike the natural numbers like of set of integers or set of rational numbers or set of reals which are unique in the case of linguistic sets they are infinitely many depending on the linguistic variable under consideration.

So typical linguistic sets in for any linguistic variables L, I or S a linguistic continuum described as

$$[a_1, a_n] ; a_1 < a_n.$$

That is a_1 is the least linguistic term and a_n is the largest linguistic term like real line of the numerical system.

$S = \{\text{finite collection of linguistic terms associated with the linguistic variable } L\}$.

$S_\infty = \{\text{infinite collection of linguistic terms associated with the linguistic variable like positive integers of the number system}\}$.

S may be totally orderable or may not be orderable depending on the linguistic variable under consideration.

Empty linguistic term or word is denoted by ϕ and the empty linguistic set by $\{\phi\}$.

We say two linguistic sets S and S_1 to be equal if $|S| = |S_1|$ and both S and S_1 have the same set of elements and in addition both of them are associated with the same linguistic variable. In every linguistic set also a linguistic term occurs only once.

Now we proceed onto define linguistic subsets and linguistic supersets.

Let S and T be any two nonempty linguistic sets, if each member of S is also a member of T that is if $x \in S$ then $x \in T$ then S is called as a linguistic subset of the linguistic set T and write it as $S \subseteq T$.

We also say T is a linguistic superset of S and write it as $T \supseteq S$.

Now we define the notion of linguistic subsets as follows;

Thus, if $S \subseteq T$ then there is no linguistic term in S which is not in T i.e. if $y \notin T$ then $y \notin S$.

We have $S \subseteq S$ as linguistic sets and the empty linguistic set $\{\phi\}$ is always a linguistic subset of every linguistic set.

If for the linguistic sets S and T ; S is a proper linguistic subset of T (or properly contained in T and we write it as $S \subset T$ if every linguistic term in S is in the linguistic set T and there exist at least one linguistic term in T which is not a member of the linguistic set S).

So we say two linguistic sets S and T are comparable if $S \subseteq T$ or $T \subseteq S$; otherwise they are not comparable.

Let S and T be a linguistic sets finite or infinite.

We define linguistic union of the linguistic sets S and T analogous to classical sets as all the elements belongs to S or to T or to both and the union of S and T is denoted by $S \cup T$. Clearly $S \cup \{\phi\} = S$. $S \cup S = S$ and $S \cup T = T \cup S$.

We will illustrate this situation by some examples.

Example 2.1. Let

$S = \{\text{good, bad, very good, fair, very bad, just good}\}$ and

$T = \{\text{very very good, just bad, just fair, best, bad, worst}\}$

be any two linguistic sets.

We find

$$\begin{aligned}
S \cup T &= \{\text{good, bad, very good, fair, very bad, just good}\} \cup \\
&\quad \{\text{very very good, just bad, just fair, best, bad, worst}\} \\
&= \{\text{good, bad, very good, fair, very bad, just good, very very} \\
&\quad \text{good, just bad, just fair, best, worst}\}.
\end{aligned}$$

We see $S \cup T$ contains all those linguistic terms which belong to S or to B or to both.

$$\text{Clearly } S \cup \{\phi\} = S \text{ and } T \cup \{\phi\} = T.$$

It is easily verified $S \cup S = S$, $T \cup T = T$ and $S \cup T = T \cup S$.

Now we proceed onto define and describe the notion of linguistic intersection.

Linguistic intersection; if S and T are two linguistic sets then the set consists of all linguistic terms both in S and T is called the intersection of S and T and is denoted by $S \cap T$.

We will describe this by an example.

Example 2.2. Let $S = \{\text{tall, short, very short, very tall, very very short, shortest, just tall}\}$ and

$$T = \{\text{tall, just tall, tallest, very short, short, just short, very very tall}\}$$

be two linguistic sets. We find

$$\begin{aligned}
S \cap T &= \{\text{tall, short, very short, very tall, shortest, just tall, very} \\
&\quad \text{very short}\} \cap \{\text{tall, just tall, tallest, very short, short, just short,} \\
&\quad \text{very very tall}\} \\
&= \{\text{tall, short, very short, just tall}\}.
\end{aligned}$$

The linguistic terms which belong to both S and T is given by $S \cap T$.

We see $T \cap \{\phi\} = \{\phi\}$ and $T \cap T = T$ and $T \cap S = S \cap T$.

Union and intersection of an arbitrary family of linguistic sets is again a linguistic set.

Let A_1, A_2, \dots, A_n be a family of arbitrary linguistic sets.

Now we know operations of formings unions and intersections are basically binary operation; that is each is a process which applies to a pair of linguistic sets and this yields a third linguistic set. This is done by the use of parentheses to indicate the order in which the operations are performed

$$(A_1 \cup A_2) \cup A_3 ; ((A_1 \cap A_2) \cap A_3)$$

where the parentheses directs one to unite A_1 and A_2 (or intersect A_1 and A_2) then unite the result with the linguistic set A_3 (then intersect with the linguistic set A_3). This is possible as the law of associativity holds good.

That is $(A_1 \cup A_2) \cup A_3 = A_1 \cup (A_2 \cup A_3)$

and $(A_1 \cap A_2) \cap A_3 = A_1 \cap (A_2 \cap A_3)$.

Thus for any finite class of linguistic sets $\{A_1, A_2, \dots, A_n\}$ we can form

$$A_1 \cup A_2 \cup \dots \cup A_n \text{ and } A_1 \cap A_2 \cap \dots \cap A_n.$$

In the same way as we do for classical sets.

In order to shorten the notion we denote it as

$$\bigcup_{i=1}^n A_i \text{ and } \bigcap_{i=1}^n A_i$$

So we can redefine the \cup and \cap of linguistic sets as

$$\bigcup_i A_i = \{x / x \in A_i \text{ for atleast one } A_i ; 1 \leq i \leq n\}$$

$$\bigcap_i A_i = \{x / x \in A_i \text{ for every } A_i ; 1 \leq i \leq n\}$$

n can also be infinite.

We call the linguistic continuum, or the linguistic set S associated with the linguistic variable L as the linguistic universal set or universal linguistic set.

Now we define difference of linguistic sets and complement of a linguistic sets.

If S and T are two linguistic sets; the difference linguistic set of S and T is denoted by

$$S \setminus T \text{ or } S - T$$

and is the linguistic set consisting of all those elements of S which do not belong to T .

If however T is a subset of S then we say $S - T$ is the complement of S in T .

But the complement of a linguistic set S in the universal linguistic set U is called the linguistic complement of S and is denoted by S^c .

We will illustrate these situations by some examples.

Example 2.3. Let $S = [\text{worst, best}]$ be the linguistic continuum or the universal linguistic set. $U = S = [\text{worst, best}]$.

Let $D = \{\text{worst, good, very good, just good, very bad, best, fair, very fair, very very bad, bad, just fair}\}$

$C = \{\text{very fair, good, worst, very very very bad, very very good, very very fair}\}$

be two linguistic sets. The difference set

$D - C = D \setminus C = \{\text{set of those elements in } D \text{ which do not belong to } C\}$.

Thus $D \setminus C = \{\text{very good, just good, very bad, best, fair, very very bad, bad, just fair}\}$.

Consider two linguistic sets E and F where $E \subset F$.

$E = \{\text{good, bad, best, just good, fair, just fair}\}$ and

$F = \{\text{good, bad, best, just good, fair, just fair, worst, just bad, very bad, very good, very fair}\}$

be two linguistic sets such that $E \subset F$.

Now the difference linguistic set

$F \setminus E = \{\text{worst, just bad, very bad, very good, very fair}\}$.

Next we proceed onto define the new notion of linguistic functions or by default of notation the function of any two linguistic sets D and C in the following.

Let D and C be any two linguistic sets and let there be a rule which associates each linguistic member x of D to a linguistic member y of C .

Such a rule or correspondence f_L under which to each x of the linguistic set D there corresponds exactly one linguistic term y in C is called a linguistic mapping or a linguistic function.

We represent this by $f_L: D \rightarrow C$;

i.e. f_L is a linguistic function of D into C .

D is called the linguistic domain of the linguistic function f_L and C is defined as the linguistic codomain of the linguistic function f_L . This definition is analogous to the classical function.

The unique linguistic term of C which corresponds to a linguistic term x of D is defined as the linguistic image of x or the value of the linguistic function f_L and it is denoted by $f_L(x)$. x is called the linguistic preimage of $f_L(x)$.

It is important to note that every linguistic term in D has its linguistic image in C but there may be linguistic terms in C which has no linguistic terms which are not linguistic images of any element of the linguistic domain C .

We represent it as

$$f_L: D \rightarrow C$$

i.e., f_L is a linguistic mapping or linguistic function of D to C .

The set of all those elements of the codomain C which are the images of the elements of the domain D is called the linguistic range set of the linguistic function f_L .

If the codomain C itself of f_L itself is the range set of f_L then we say that f_L is a linguistic function from D onto C .

If the linguistic terms of the domain set D are denoted by x and those of the range set C by y then $y = f_L(x)$ is the value of the linguistic function f_L at x .

We call a linguistic function $f_L: D \rightarrow C$ is said to be one to one if two different linguistic terms in D always has two different images under f_L i.e.

$$x_1 \neq x_2 \text{ implies } f_L(x_1) \neq f_L(x_2) \text{ for all } x_1, x_2 \in D.$$

If $f_L: D \rightarrow C$ is both one to one and onto then we can define inverse linguistic mapping

$$f_L^{-1}: C \rightarrow D \text{ as}$$

if y in C is such that

$$f_L(x) = y \text{ (x exist and is unique since } f_L \text{ is one to one and onto).}$$

We define $x = f_L^{-1}(y)$.

The equation $x = f_L^{-1}(y)$ results in solving

$$y = f_L(x) \text{ for } x.$$

If $f_L : D \rightarrow C$ is both one to one and onto then we say that f_L is a one to one correspondence between D and C .

In this case $f_L^{-1} : C \rightarrow D$ is also a one-to-one correspondence between C and D .

If $D_1 \subseteq D$ then its image $f_L(D_1)$ is a linguistic subset of C defined by

$$f_L(D_1) = \{f(x) \in C / x \in D_1\}.$$

Similarly, if C_1 is a linguistic subset of C then its inverse image $f_L^{-1}(C_1)$ is a linguistic subset of D defined by

$$f_L^{-1}(C_1) = \{x \in D / f(x) \in C_1\}.$$

A linguistic function f_L is called an extension of a linguistic function g_L (and g_L is called the restriction linguistic function of f_L) if the linguistic domain of f_L contains the linguistic domain of g_L and $f_L(x) = g_L(x)$ for each x in the linguistic domain of g_L .

As in the case of classical function one can combine two functions to get a composite function here also if we have two linguistic functions $f_L : D \rightarrow C$ and $g_L : C \rightarrow E$ we define the composite linguistic function $g_L \circ f_L : D \rightarrow E$ defined by

$$(g_L \circ f_L)(x) = g_L(f_L(x)) \text{ for every } x \in D.$$

The linguistic function $I_L : D \rightarrow D$ defined by $I_L(x) = x$ for every $x \in D$ is called the identity linguistic function on D .

If $g_L \circ f_L = f_L \circ g_L = I_L$ then we have $g_L^{-1} = f_L$ or $f_L^{-1} = g_L$.

The following properties as in case of classical functions are also true in case of linguistic functions f_L .

The main properties of $f_L: D \rightarrow C$ are as follows:

- i) $f_L(\phi) = \{\phi\}$ where ϕ is the linguistic empty set
- ii) $f_L(D) \subseteq C$
- iii) If $D_1 \subseteq D_2$ then $f_L(D_1) \subseteq f_L(D_2)$
- iv) For any finite collection of linguistic sets D_1, D_2, \dots, D_n $f_L(\bigcup_i D_i) = \bigcup_i f_L(D_i)$
- v) $f_L(\bigcap_i D_i) \subseteq \bigcap_i f_L(D_i)$
- vi) $f_L^{-1}(\phi) = \phi$ and $f_L^{-1}(C) = A$
- vii) For any finite collection of linguistic sets C_1, C_2, \dots, C_n we have $f_L^{-1}(\bigcup_i C_i) = \bigcup_i (f_L^{-1}(C_i))$
- viii) $f_L^{-1}(\bigcap_i C_i) = \bigcap_i f_L^{-1}(C_i)$
- ix) $f_L^{-1}(C^c) = (f_L^{-1}(C))^c$

Example 2.4. Let

$S = \{\text{worst, good, bad, fair, just good, very good, very bad, just fair, best, just bad}\}$

Let $A = \{\text{best, good, bad, very bad, fair}\}$ and

$B = \{\text{very good, just good, just bad, worst, just fair}\}$
 be two linguistic sets.

We define the linguistic function $f_L: A \rightarrow B$ as follows:

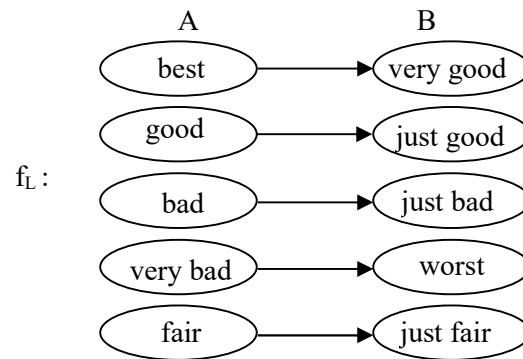

Figure 2.1

That is we have

$$f_L(\text{best}) = \text{very good}$$

$$f_L(\text{good}) = \text{just good}$$

$$f_L(\text{bad}) = \text{just bad}$$

$$f_L(\text{very bad}) = \text{worst}$$

$$f_L(\text{fair}) = \text{just fair.}$$

f_L is one to one onto linguistic mapping from A to B.

We can define inverse mapping as follows:

$$f_L^{-1}: B \rightarrow A \text{ as follows :}$$

$$\begin{aligned} \text{Now } f_L^{-1} \circ f_L(\text{best}) &= f_L^{-1}(f_L(\text{best})) \\ &= f_L^{-1}(\text{very good}) \\ &= \text{best.} \end{aligned}$$

$$f_L \circ f_L^{-1}(x) = x \text{ for all } x \in B.$$

Thus $f_L \circ f_L^{-1} : B \rightarrow B$

is the linguistic identity map of the linguistic set B to B.

Similarly $f_L^{-1} \circ f_L(x) = x$ for all $x \in A$.

Thus $f_L^{-1} \circ f_L : A \rightarrow A$ is a linguistic identity map of A to A.

Now we define $g_L : A \rightarrow B$ a linguistic map as follows.

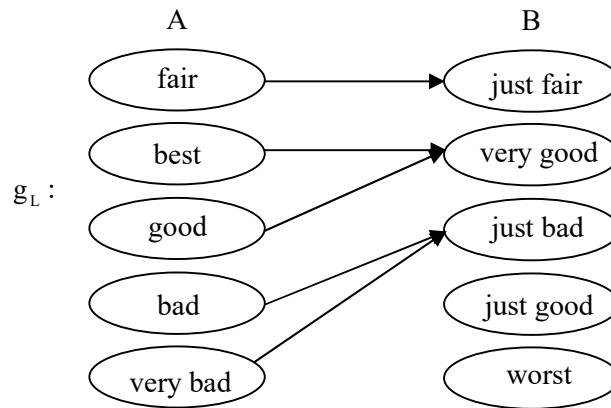

Figure 2.3

We see g_L is not a one to one linguistic map or function

$$g_L(A_i) = \{\text{just fair, very good, just bad}\}$$

is a linguistic subset of B.

$$g_L^{-1}(B_1) = \{x \in A; (g_L(x) \in B_1)\}$$

$g_L^{-1}(B_1)$ a linguistic subset of A.

We can have the concept of equivalent linguistic sets analogous to the equivalence of classical sets.

Two linguistic sets A and B are given in the following;

A = {best, good, average, bad} and

B = {satisfactory, very satisfactory, not satisfactory,
highly satisfactory}

be two linguistic sets.

We say the two linguistic sets are linguistically equivalent written as $A \sim_L B$ if there exists a one-to-one correspondence between the elements.

A is linguistically equivalent to B and the one-to-one correspondence can be seen as

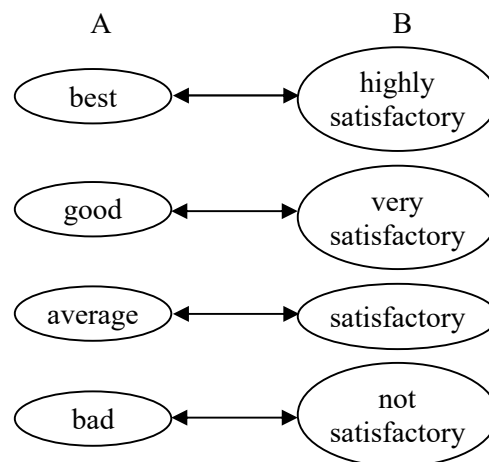

Figure 2.4

Each of the two linguistic sets A and B have five linguistic terms. Here these two linguistic sets should be finite and have equal number of elements but the one to one correspondence must be meaningful.

Here in case of linguistic sets we cannot define the notion of addition + or product \times instead we define specifically four types of operations \cup, \cap, \min and \max .

Here we develop the algebraic structure on these linguistic sets and order the structure.

First of all we wish to impose certain conditions on the linguistic sets associated with the linguistic variable.

If we are interested in building algebraic structures it is mandatory the linguistic set under consideration must allow for a linguistic total order to be defined on it. Thus we in this book in times of need define certain properties only a special type of linguistic sets for which we associate linguistic variables such that linguistic set is linguistically totally orderable.

Already this has been mentioned in chapter I of this book.

Thus, we use those linguistic variables which has its associated linguistic set to be a linguistic continuum or a totally order linguistic set in case S is finite.

The linguistic variables like age of people, height of people, performance aspects of students in a classroom, performance aspects of workers in an industry (that is employee's performance, yield of a crop or growth of crops etc have their associated linguistic set to be a totally ordered set.

We define a totally ordered linguistic set and give examples of them.

Definition 2.1. *Let S be a linguistic set or a linguistic continuum. We say S is a linguistically totally ordered set if every pair of linguistic terms / words are comparable that is if*

$a_i, a_j \in S$ then $a_i \leq a_j$ (or $a_j \leq a_i$) or more mathematically

$\min\{a_i, a_j\} = a_i$ if and only if $\max\{a_i, a_j\} = a_j$ that is $a_i \leq a_j$.

It is pertinent to keep on record that all linguistic sets in general are not totally orderable.

We in this definition of algebraic structures on linguistic sets take only those linguistic sets which can be a totally ordered linguistic set or a linguistically totally ordered set.

Semifield structure on linguistic sets which are totally ordered (or linguistically ordered set) are obtained.

Before we start to define the notion of any algebraic operations on linguistic sets we first discuss some important limitations of linguistic sets in general.

- i) All linguistic sets are not totally orderable or linguistically ordered. Here we consider only totally or linguistically orderable linguistic sets to build algebraic structures on them.
- ii) It is not possible to define or develop the usual or classical addition operation or subtraction operation or multiplication or division operations on linguistic sets.

- iii) We can have on linguistic sets the pair of operations $\{\min, \max\}$ or $\{\cup, \cap\}$.

However, in case of linguistic sets which are linguistically orderable

$$\min\{a, b\} = a \cap b$$

$$\max\{a, b\} = a \cup b$$

Definition of some linguistic algebraic structure are given in the following:

It is pertinent to keep on record that in case of linguistic sets we cannot have the notion of negative element.

So only at this point we are satisfied to have a linguistic commutative monoid structure under max operation.

Definition 2.2: Let S be a totally ordered linguistic set S is said to be a linguistic semifield if two compositions / operation \min and \max are defined in it be such that for all $a, b, c \in S$;

- i) S is closed that is for any $a, b \in S$ we have $\max\{a, b\} \in S$.
- ii) $\max\{a, b\} = \max\{b, a\}$ that is the max operation on S is commutative.
- iii) max operation on S is associative; that is
- $$\max\{\max\{a, b\}, c\} = \max\{a, \max\{b, c\}\}$$
- iv) Since S is a totally ordered set we have a least element say l in S and this l is such that

$\max\{l, a\} = a$ for all $a \in S$. That is l serves as the linguistic identity with respect to \max .

Thus $\{S, \max\}$ is a commutative linguistic monoid.

Now we define operation \min on the linguistic ordered set S .

- a) For any $a, b \in S$ we have $\min\{a, b\}$ is in S that is S is closed under \min operation.
- b) We have $\min\{a, b\} = \min\{b, a\}$ for all $a, b \in S$. The \min operate on S is commutative.
- c) \min operation on S is associative

$$\min\{a, \min\{b, c\}\} = \min\{\min\{a, b\}, c\}$$
- d) We for every $a \in S$ the greatest element say g which acts as the linguistic identity for the \min operation.

That is $\min\{g, a\} = a$ for all $a \in S$.

Thus $\{S, \min\}$ is a commutative monoid.

Now we have the distributive identities. \min is distributive over to \max ;

$$\begin{aligned} \text{i.e. } \min\{a, (\max\{b, c\})\} &= \max\{\min\{a, b\}, \min\{a, c\}\} \\ &= \max\{a, \min\{b, c\}\} \\ &= \min\{\max\{a, b\}, \max\{a, c\}\} \end{aligned}$$

for all $a, b, c \in S$.

So we have $\{S, \max, \min\}$ to be a linguistic semifield if the two operations \min and \max satisfies the above said operations.

The semifield S is an ordered linguistic structure.

Law of Trichotomy;

that is if

$$a > b \text{ or } a = b \text{ or } a < b.$$

For if $\min\{a, b\} = a$ then $a < b$

b then $b < a$

$a = b$ if $a = b$

Similarly

$$\max\{a, b\} = \begin{cases} a & \text{then } a > b \\ b & \text{then } a < b \\ a = b & \text{then } a = b \end{cases}$$

for any pair $a, b \in S$.

Transitivity:

$$\text{For all } a, b, c \in S \ (a > b) \wedge (b > c) \Rightarrow a > c.$$

Compatibility of order relation with \max operation;

$$\text{If } a > b \text{ implies } \max\{a, c\} \geq \max\{b, c\}$$

if $a > b > c$ so we need greater than or equal to.

Compatibility of order relation with min operation.

$$a > b \wedge c > \{\text{least element}\} \text{ implies } \min\{a, c\} > \min\{b, c\}$$

Now we proceed onto describe linguistic intervals - open and closed intervals.

Every subset A of a linguistic interval or a linguistic totally ordered set contains the following:

- i) A has at least two distinct linguistic terms and
- ii) Every element in A lies between any two linguistic members of A .

Open linguistic interval:

Let a and b be two distinct linguistic terms with $a < b$ then $(a, b) = \{x / a < x < b\}$ is defined as the open linguistic interval.

It is denoted by (a, b) or $]a, b[$.

Closed linguistic interval:

Let a and b be any two distinct linguistic terms $a < b$.

Closed interval $[a, b] = \{x / a \leq x \leq b\}$ consisting of a and b and all linguistic terms lying between a and b . Closed linguistic interval is denoted $[a, b]$.

Semiclosed or semiopen linguistic intervals.

$$(a, b] =]a, b] \{x / a < x \leq b\} \text{ and}$$

$$[a, b) = [a, b[= \{x / a \leq x < b\};$$

where $\{a, b\}$ half open and half closed and $[a, b)$ is half closed and half open linguistic intervals.

These linguistic intervals also are known as semiclosed or semiopen linguistic intervals.

All the linguistic sets used here are bounded as either they are totally ordered linguistic sets which are finite or a closed linguistic continuum.

We have already discussed about the least element and the greatest element of the ordered linguistic set S .

As in case of a classical numbers in case of linguistic totally order set or continuum also we have a linguistic least upper bound or linguistic supremum and the linguistic lower bound or the linguistic infimum.

It is easily verified that linguistic completeness or linguistic order completeness is possessed by all linguistic continuums.

In fact we can say linguistic completeness exists for linguistic continuums.

We can also define the notion of Dedekind's form of completeness property of reals \mathbb{R} in an analogous way to linguistic continuum.

We will refer the following as Dedekind's linguistic property.

If I_L be the linguistic continuum that is divided into two non empty classes L and U such that every member of L is less than every member of U , then there exists a unique linguistic

term say a ; such that every linguistic term less than a belongs to L and every linguistic term greater than a belongs to U .

Clearly the two classes L and U so defined are disjoint and the linguistic term a belongs either to L or U . This linguistic property of linguistic terms will be known as the Dedekind's linguistic property.

We may restate the Dedekind's linguistic property as follows:

If L and U are two subsets of I_L such that:

- i) Let $L \neq \{\phi\}$ and $U \neq \{\phi\}$ that is each linguistic class has at least one term.
- ii) $L \cup U = I_L =$ (linguistic continuum)
- iii) Every linguistic term of L is less than every linguistic term of U ,
 i.e. $x \in L \wedge y \in U$ then $x < y$
 then either L has the greatest linguistic term or U has the smallest linguistic term.

We prove the equivalence of the two forms of completeness.

We first show that the order completeness property of linguistic continuum (linguistic numbers) implies Dedekind's property.

Let I_L be the linguistic continuum that has order completeness property; every non-empty subset of I_L which is bounded above (below) has supremum (infimum).

Let L and U be two linguistic subsets of I_L such that

- i) $L \neq \phi, \quad U \neq \phi;$
- ii) $L \cup U = I_L$
- iii) Every member of L is less than or equal to every other member of U .

Proof analogous to real continuum.

Representation of linguistic terms on the linguistic straight line.

Let $S = [\text{youngest, oldest}]$ be the linguistic continuum associated with the linguistic variable, age of people S is given a linguistic straight line representation given by the following figure 2.5;

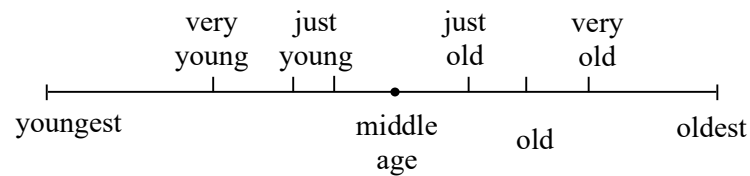

Figure 2.5

The middle age is given as two equal parts; it is in the increasing order from the least to the greatest.

Between any two linguistic terms as in case of real subintervals have infinite number of linguistic terms.

To every linguistic term in the linguistic continuum there corresponds a unique point on the linguistic directed line and to every point on the directed linguistic line there corresponds a unique linguistic term.

As we have not talked about negative linguistic terms so far we cannot accommodate the concept of negative linguistic terms on the linguistic line defined and described here.

Most of the concepts associated with + or \times we cannot easily derive complete equivalent forms which is a limitation of this book as this book is basically for beginners and more so only introductory in nature.

It is pertinent to keep on record that linguistic continuum satisfies the Dedekind's form of completeness property.

However, it is important to note that not all linguistic variables do give way to linguistic set which are linguistic continuum or linguistic totally ordered sets.

We can as in case of classical number system define in case of linguistic continuum or totally ordered linguistic set also the notion of the linguistic neighbourhood of a linguistic point which is the same as the notion of linguistic term / word.

We proceed onto define the new notion of linguistic neighbourhood of a linguistic term or neighbourhood of a linguistic point / term / word.

Definition 2.3 *Let S be a linguistic totally ordered set or a linguistic continuum.*

A linguistic set $N_L \subseteq S$ is called the linguistic neighbourhood of a linguistic term S , where $a \in S$ if there exist linguistic a open interval I_o in S containing a and contained in N_L that is

$$a \in I_o \subseteq N_L.$$

We can provide some examples of the same.

While discussing linguistic neighbourhoods of a point we have to discuss the following important concepts.

First, we provide some examples to show which set has linguistic neighbourhoods and which set do not have linguistic neighbourhoods.

Example 2.5. Let $S = [\text{worst}, \text{best}]$ be the linguistic continuum associated with the linguistic variable the performance aspects of students in the classroom.

We see this linguistic set S is the linguistic neighbourhood of each of its points other than worst and best.

For we see the linguistic term good has infinitely many linguistic neighborhoods.

$$N_1 = [\text{just good}, \text{very good}]$$

$$N_2 = [\text{bad}, \text{very good}]$$

$$N_3 = [\text{worst}, \text{best}] \text{ and so on.}$$

We see all neighbourhoods in case of linguistic continuum S are only closed linguistic intervals which are clearly linguistic subintervals of S .

In all these cases the linguistic term $\text{good} \in N_i$ for all i .

However $M_1 = (\text{good}, \text{best}]$ is only a deleted linguistic neighbourhood of good; so is $M_2 = (\text{bad}, \text{good})$ is also a deleted linguistic neighbourhood of good.

Suppose $M = \{\text{worst}, \text{very bad}, \text{bad}, \text{just bad}, \text{fair}, \text{just fair}, \text{good}, \text{just good}, \text{very good}, \text{best}\}$

be the finite totally ordered linguistic set associated with the linguistic variable performance aspects of an employee in an industry.

Clearly M is a linguistic totally ordered set, and M is not a linguistic neighbourhood of any of its linguistic terms (points)

- i) In general the linguistic open interval (a,b) is the linguistic neighbourhood of each of its points.
- ii) The closed interval is the linguistic neighbourhood of each of point $]a, b[$ but is not the linguistic neighbourhood of the end linguistic points / terms a and b .

The null or empty linguistic set $\{\emptyset\}$ is the linguistic neighbourhood of each of its linguistic terms in the sense there is no linguistic term in $\{\emptyset\}$ of which is not a neighbourhood.

Theorem 2.1 *A non-empty finite linguistic set A of a linguistic continuum S cannot be a neighbourhood for any linguistic point / term $S \in S$.*

Proof. Let S be a linguistic continuum. A set can be a linguistic neighbourhood (nbd) of a linguistic term only if it contains an open linguistic interval containing that point. Since an interval necessarily contains infinite number of linguistic points, therefore a finite linguistic set cannot be a linguistic neighbourhood of any linguistic term / point. Hence the claim.

However we wish to keep on record we will define linguistic intervals as those which may have even finite number of points. The criteria which we take is atleast in that linguistic open or closed interval must have one linguistic term different from the end points. However for these linguistic intervals we cannot define the very concept of linguistic neighbourhood.

So for us to define linguistic neighbourhoods we need only linguistic continuum as the basic linguistic set.

Thus it is mandatory that to define linguistic neighbourhoods only the notion is linguistic continuum must be taken for linguistic intervals and these linguistic intervals must have infinite number of points.

Theorem 2.2. *Let S be a linguistic continuum. Every superset of a linguistic neighbourhood of a linguistic point / term x is also a linguistic neighbourhood of x , that is if N is a neighbourhood of linguistic point x and $N \subseteq M$ ($M \supseteq N$) then M is also a linguistic neighbourhood of x .*

Proof is direct and hence left as an exercise to the reader.

Theorem 2.3. *Union (finite or arbitrary) of linguistic neighbourhoods of a linguistic term x is again a neighbourhood of linguistic term x .*

Proof is direct and hence left as an exercise to the reader.

Theorem 2.4. *Let M and N be two linguistic neighbourhoods of a linguistic point or a term x . Then $M \cap N$ is also a (linguistic) neighbourhood of the linguistic term x .*

Proof. Follows from the fact if N and M are linguistic neighbourhoods of the linguistic term x then clearly $M \cap N$ will contain the linguistic neighbourhood of the linguistic term x .

Now we proceed onto define the concept of linguistic interior term / point of a linguistic set S . By default of notation we use in certain places neighbourhood for neighbourhood.

Definition 2.4. *Let S be a linguistic continuum. A linguistic term or a point x is said to be a linguistic interior point of a linguistic set S if S is a linguistic neighbourhood of x .*

That is there exists a linguistic interval (a, b) containing x , viz; $x \in (a, b) \subseteq S$.

Now we proceed onto define the new notion of linguistic interior of a linguistic set S .

Definition 2.5. *The set of all linguistic interior points of a linguistic set S is called the linguistic interior of the linguistic set denoted by S^i or $\text{int } S$*

Result 2.1. Linguistic interior of a linguistic continuum S is itself.

Result 2.2. Linguistic interior of the linguistic set of finite order is the empty linguistic set $\{\phi\}$.

Theorem 2.5. Let S be a linguistic set with x as a interior linguistic point.

Linguistic interior of S denoted by $S^i = \text{int } S = \{\text{all linguistic interior points of } S\}$ is a linguistic subset of S .

Proof is direct hence left as an exercise to the reader.

Now we proceed onto define linguistic open sets.

Definition 2.6 A linguistic set S is said to be linguistic open set if the linguistic neighbourhood of each of its linguistic points / terms, i.e. for each $x \in S$ there exist an open linguistic interval I_x such that $x \in I_x \subseteq S$.

Thus, every linguistic point of a linguistic open set is an interior point, that is $S = \text{int } S = S^i$.

Thus S is a open linguistic set if and only if $S = \text{int } S = S^i$.

We say a linguistic set S is not open if it is not a linguistic neighbourhood of at least one of its points or that there is at least one point which is not an interior point of S .

Theorem 2.6. Every linguistic open interval is a linguistic open set.

Proof is left as an exercise to the reader.

Theorem 2.7. The interior of a linguistic set is a linguistic open set.

Proof is left as an exercise to the reader.

Theorem 2.8. *The interior of a linguistic set S is the largest open linguistic subset of S .*

or

The interior of a linguistic set S contains every linguistic open subset of S .

Proof is left as an exercise to the reader.

The proof is analogous to classical ones with simple appropriate changes.

Theorem 2.9. *The union of an arbitrary family of linguistic open sets is a linguistic open set.*

Proof is direct left as an exercise to the reader.

Theorem 2.10. *The intersection of a finite number of linguistic open sets is a linguistic open set.*

Proof analogous to classical sets hence is left as an exercise to the reader.

We now proceed onto define the new notion of linguistic limit point of a linguistic continuum.

Definition 2.7. *A linguistic term l is a linguistic limit point (or ling. limit term of a linguistic set S_l (contained in a linguistic continuum) if every linguistic neighbourhood of l contains an infinite number of ling. terms of S_l .*

Thus l is a linguistic limit point / term of the linguistic set S_1 if for any linguistic neighbourhood N of l is such that $N \cap S_1$ is an infinite linguistic set.

A linguistic limit point or term of a linguistic continuum is also called as linguistic cluster point (or ling. term) or a linguistic condensation point (ling condensation term) or a linguistic accumulation point (term).

It is pertinent to keep in record as in case of classical limit point the linguistic limit point / term may or may not be a member of the linguistic set.

Further a linguistic finite set cannot have a linguistic limit point or term.

Theorem 2.11. *Let S be a finite linguistic set, S cannot have a linguistic limit point (term).*

Proof: Follows from the very definition of the linguistic limit point.

The famous Bolzano-Weierstrass Theorem (for linguistic sets) can be proved.

Theorem 2.12: *(Bolzano Weierstrass Theorem for linguistic continuum).*

Every infinite bounded linguistic continuum has a linguistic limit point.

Proof: Let S be any infinite bounded linguistic continuum with m the linguistic infimum that is m is the greatest lower bound (g.l.b) or the linguistic infimum of S and M be the

linguistic supremum; that is M is the least upper bound (l.u.b) or the linguistic supremum of S (recall both M and m are unique as our linguistic continuum S is just like the reals).

Let P be the set of all linguistic terms defined as

$x \in P$ if and only if x exceeds at the most a finite number of members of S .

Clearly as $m \in P$, P is non-empty. Further M is an upper bound P , for no number greater than or equal to M can belong to P . Thus, P is non empty and bounded above.

Hence by order completeness property, P has a linguistic supremum say η . We shall now show that η is a linguistic limit point of S .

Consider any linguistic neighbourhood of η .

Let $((\max(\eta, \theta_1), (\max(\eta, \theta_2)))$ where θ_1 is very little less than η and θ_2 is similarly little greater than η .

(This is always possible for we can easily say as in case of reals $-\epsilon$ and ϵ , $\epsilon > 0$ are equal we can say there θ_1 and θ_2 such that θ_1 is little less than η and θ_2 is little more than η .

Since η is the linguistic supremum of P , $\max\{\eta, \theta_2\}$ does not belong to P , and consequently $\max\{\eta, \theta_2\}$ must exceed an infinite number of linguistic terms of S .

Since $\max\{\eta, \theta_1\}$ exceeds at the most a infinite number of linguistic terms of S and $\max\{\eta, \theta_2\}$ exceeds infinitely many linguistic members of S implies

$(\max\{\eta, \theta_1\}, \max\{\eta, \theta_2\})$ contains infinite linguistic terms (members) of S .

Hence η is the linguistic limit point of S .

We can as in case of classical sets $S \subseteq \mathbb{R}$ define the concept of linguistic adherent point or term of a linguistic set S .

Let S be a linguistic continuum. An infinite proper linguistic subinterval $S_1 \subseteq S$; S_1 is called or defined as the linguistic subcontinuum of the linguistic continuum S .

Definition 2.8. *A linguistic term η of a linguistic subcontinuum $S_1 \subseteq S$ is said to be an linguistic adherent term / point of the linguistic set S_1 if every neighbourhood of η contains at least one linguistic term of S_1 .*

Clearly a linguistic adherent point or term may or may not belong to the linguistic set S_1 and it may or may not be a linguistic limit point / term of the linguistic set S_1 .

Now from the definition of the linguistic adherent point / term η which is in S ($\eta \in S$) is automatically a linguistic adherent term / point of the linguistic set S , for every linguistic neighbourhood of a linguistic term of the linguistic set contains at least one linguistic term of the linguistic set namely the linguistic term itself.

$\eta \notin S$ is a linguistic adherent point / term of S only if η is a linguistic limit point of S for every linguistic neighbourhood of η , there contains at least one linguistic term of S which is other than η .

Definition 2.9: Thus the set of all linguistic adherent terms of S' of S , called closure of S which is denoted by \tilde{S} is such that $\tilde{S} = S \cup S'$.

Thus we can define S to be closed linguistic set if and only if

$$S' \subseteq S \text{ or } \tilde{S} = S.$$

S is linguistically not closed set does not imply S is linguistically open. For there exists linguistic sets which are neither open nor closed.

So a linguistic continuum is linguistically open as well as linguistically closed.

For example, the set

$S_1 \subseteq S = [\text{worst, best}]$ where $S_1 = [\text{bad, good}]$ is linguistically closed and not linguistically open.

For the linguistic limit points are two in number and they are the linguistic terms bad and good.

Definition 2.10: A linguistic subset B of any linguistic continuum S is said to be linguistically dense (or dense in S or every where dense) if every linguistic term / point of S is a linguistic term / point of B or a linguistic limit point / term of B or equivalently $\bar{B} = S$; \bar{B} denotes the linguistically dense set of $B \subseteq S$.

A linguistic set B is said to be linguistically dense in itself if every linguistic point of B is a linguistic limit point of B that is

if $B \subseteq B'$. Thus, a linguistic set which is dense in itself has no isolated linguistic points.

We say a linguistic set B is nowhere dense (non-dense) relative to the linguistic continuum S if no neighbourhood in S is contained in the linguistic closure of B .

That is the complement of the linguistic closure of B is linguistic dense in S .

Now we can define linguistic perfect set analogous to the classical perfect set.

Definition 2.11. Let S be a linguistic continuum. A linguistic set is said to be linguistic perfect set if it is identical with its linguistic derived set or equivalently a linguistically set which is linguistic closed and linguistic dense in itself.

Some relevant theorems we mention in the following.

Theorem 2.13. A linguistic set is linguistic closed if and only if its linguistic complement is open.

Necessary Part: Let S_1 be a closed linguistic set of S , S is a linguistic continuum. We have to prove $S \setminus S_1 = M$ is an open linguistic set.

Let x be any linguistic point of M .

$$x \in M \text{ implies } x \notin S_1.$$

Also, since S_1 is closed, x cannot be a linguistic limit point of S_1 . Thus, there exists a linguistic neighbourhood N of x such that

$$N \cap S_1 = \phi$$

implies N is contained in S . So, every linguistic point of M is an linguistic interior point.

Thus, M is a linguistic open set.

Sufficient Part: Let S_1 be the linguistic set such that $S \setminus S_1 = M$ where M is linguistic open set.

To show S_1 is a linguistic closed set we shall show every linguistic limit point of S_1 is in S_1 .

If possible let η be a linguistic limit point of S_1 which is not in S_1 but is in M . As it is given M is a linguistic open set there exist a linguistic neighbourhood of η contained in T and thus containing no point of S_1 which implies η is not a linguistic limit point of S_1 which is a contradiction.

Hence no linguistic limit point of S_1 exist is not in S_1 .

So S_1 is closed.

Theorem 2.14. *The intersection of an arbitrary family of linguistic closed sets is linguistic closed set.*

Proof. Let F be the intersection of linguistic sets of an arbitrary family F of linguistic closed sets where

$$F = \{S_\lambda / \lambda \in \Lambda\}$$

of linguistic closed sets and Λ an indexing set.

If the linguistic derived set F' of F is ϕ , i.e., when F is a finite set or an infinite set without linguistic limit points, then evidently it is a linguistic closed set.

When $F' \neq \{\phi\}$ let $\eta \in F'$ where η is a linguistic limit point of F , so that every linguistic neighbourhood of η contains a family F of closed linguistic sets.

This implies η is a linguistic limit point of each closed linguistic set S_λ .

Thus η belongs to each S_λ which implies $\eta \in \bigcap_{\lambda \in \Lambda} S_\lambda = F$.

Hence F is a linguistic closed set.

Theorem 2.15. *Union of two closed linguistic sets in S is again a closed linguistic set.*

Proof. Let M and N be two closed linguistic sets. To show $E = M \cup N$ is a closed linguistic set.

Let η be a linguistic limit point of E .

We have to prove $\eta \in E$, then the set E will be closed.

If possible $\eta \notin E$ so $\eta \notin M$ and $\eta \notin N$. Since both M and N are closed the point η which does not belong to both of them cannot be their linguistic limit point of either. Thus we have linguistic neighbourhoods N_1 and N_2 of η such that

$N_1 \cap N = \phi$ and $N_2 \cap M = \phi$ and let $N_1 \cap N_2 = P$ where $\eta \in P$.

From the above equation it follows that

$P \cap (M \cup N) = \phi$ which in turn implies $P \cap E = \{\phi\}$.

Thus, there exist a linguistic neighbourhood which is not a linguistic point of E .

This in turn implies η is not a linguistic limit point of E ; a contradiction. No point in E can be a linguistic limit point, consequently $E = M \cup N$ is a linguistic closed set.

Hence the claim.

Theorem 2.16. *The linguistic derived set of a linguistic set is a closed linguistic set.*

Proof. Let S be a linguistic set and S' the derived linguistic set of S .

We have to prove the derived linguistic set S'' of the derived linguistic set S' is contained in S' ; that is to prove $S'' \subseteq S'$.

Two cases arise

- i) If $S'' = \{\phi\}$ then S' is either a finite set or an infinite linguistic set without linguistic limit points, then $S'' = \{\phi\} \subseteq S'$ and therefore S' is closed.
- ii) If $S'' \neq \{\phi\}$, let $\eta \in S''$ that is η be a linguistic limit point of S' .

Every neighbourhood N of η contains at least one point $\delta \neq \eta$ of S' .

Again $\delta \in S'$ implies δ is a limit point of S .

This implies for every linguistic neighbourhood of δ , N being a linguistic neighbourhood contains infinitely many linguistic terms / points of S .

This in turn implies η is a linguistic limit point of S that is $\eta \in S'$.

Thus $\eta \in S''$ implies $\eta \in S'$.

Hence $S'' \subseteq S'$ i.e. S' is a closed set. Hence the claim.

We have the following corollaries.

Corollary 2.1. S'' is closed hence closure of S' is S' ; i.e. $\tilde{S} = S'$.

Corollary 2.2. For every linguistic set S the closure \tilde{S} is closed.

To this end if we show that $(\tilde{S})' \subseteq \tilde{S}$.

Now $(\tilde{S})' = (S \cup S')' = S' \cup S'' = S' \subseteq \tilde{S}$

From the above theorem and properties enjoyed by these linguistic sets.

Now our result is a special property of a linguistic closed set.

Theorem 2.17. *A linguistic closed set B either contains a linguistic interval or else B is nowhere dense.*

Proof. Let B be any linguistic closed set and is not nowhere dense in δ a linguistic continuum. Thus, there is some linguistic interval I such that for each interval $J \subseteq I$ we have $J \cap B \neq \phi$.

To prove $I \subseteq B$.

Let $x \in I$, then every linguistic neighbourhood of x contains within it at least one point of A . This implies that either $x \in B$ or else x is a linguistic limit point of B . Since B is closed it contains all linguistic limit points so $x \in B$. Hence the claim.

Theorem 2.18: *The linguistic supremum M (infimum) of a bounded linguistic non empty set $T (\subseteq S, S$ a linguistic continuum); must be in T if not then a member of T is a limit point of T .*

Proof. Let M be the linguistic supremum of the bounded set $T \subseteq S$ which must exist by the linguistic order completeness property of T .

If $M \notin T$, then for any linguistic member θ_1 there exist atleast one linguistic term x of T such that $\min \{M, \theta_1\} < x < M$.

Thus every linguistic neighbourhood of M contains atleast one linguistic term x of the set T other than M . Hence M is a linguistic limit point of T .

Corollary 2.3. The linguistic sup (inf) M of a linguistic bounded set T is always a member of the linguistic closure \tilde{T} of T .

We discuss two cases

- i) $M \in T$ and
- ii) $M \notin T$.

If $M \in T$ it implies $M \in T \cup T' = \tilde{T}$ so $M \in \tilde{T}$.

Hence the claim.

When $M \notin T$, then $M \notin \tilde{T}$ implies $M \in T'$ implies

$$M \in T \cup T' = \tilde{T}.$$

Consequently $M \in \tilde{T}$.

We prove that as in case of classical analysis we have the following theorem.

Theorem 2.19. *The linguistic derived set of a linguistic bounded set is linguistic bounded.*

Proof. Let m and M be the linguistic inf and linguistic sup respectively be the linguistic bounded of the set T .

We will now prove that no linguistic limit point of S can be outside the linguistic interval $[m, M]$.

Let $\theta_1 > M$ be a linguistic limit point of S and θ_2 be a linguistic term such that $\theta_2 < \min \{\theta_1, M\}$

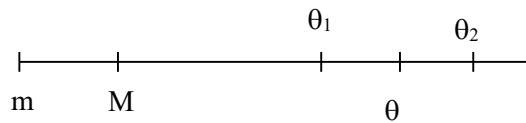

Figure 2.6

Since M is the linguistic upper bound of S , no member of S can lie in the linguistic interval (θ_1, θ_2) thus there exists a linguistic neighbourhood of θ which contains no linguistic terms of S , so θ cannot be a linguistic limit point of S .

Hence S has no linguistic limit point greater than M .

On similar lines we can show that no linguistic limit point of S is less than m .

Hence $S' \subseteq [m, M]$.

Corollary 2.4. If T is a bounded linguistic set then so is its linguistic closure \tilde{T} .

$T \subseteq [m, M]$ which implies $T' \subseteq [m, M]$ which in turn implies $\tilde{T} = T \cup T' \subseteq [m, M]$.

We prove the following theorem.

Theorem 2.20. *The linguistic derived set T' of a linguistic bounded infinite set T ($\subseteq S$, S a linguistic continuum) has the linguistic smallest and linguistic greatest members.*

Proof. Given T is linguistic bounded set, so T' is also linguistic bounded set. Further $T' \neq \{\phi\}$ by Bolzano Weierstrass theorem for linguistic sets T has at least one linguistic limit point / term.

Now T' may be finite or infinite.

When $T' (\neq \{\phi\})$ is finite evidently it has both greatest and least linguistic terms.

Suppose T' is finite evidently it has linguistic greatest and least members.

When T' is infinite, being the bounded set of linguistic term, by order completeness property of the linguistic continuum S , it has the linguistic supremum G and linguistic infimum g .

It will be shown that G and g are linguistic limit points of T ; i.e.

$$G \in T' \text{ and } g \in T'.$$

Consider G

$(\min\{G, \theta_1\}, \max\{G, \theta_2\})$ where $(\theta_1 < G < \theta_2)$ be any neighbourhood of G .

Now G being the linguistic supremum of T' , there exist at least one linguistic member η of T' such that

$$\min\{G, \theta_1\} < \eta \leq G.$$

Thus $(\min\{G, \theta_1\}, \max\{G, \theta_2\})$ is a linguistic neighbourhood of η .

But η is a linguistic limit point of T so that

$$(\min\{G, \theta_1\}, \max\{G, \theta_2\})$$

contains infinite number of linguistic members of T .

Any linguistic neighbourhood $(\min\{G, \theta_1\}, \max\{G, \theta_2\})$ of G contains an infinite number of linguistic members of T .

This implies G is a linguistic limit point of T which implies $G \in T'$.

On similar lines we can prove $g \in T'$.

Thus $G \in T'$ and $g \in T$ being linguistic sup and linguistic inf of T' are the greatest and smallest linguistic members of G' .

Thus we can restate this theorem as follows;

Theorem 2.21. *Every linguistic bounded infinite set has the linguistic smallest and the linguistic greatest limit points.*

Now we proceed onto define the notion of linguistic countable and uncountable sets.

An infinite linguistic set is said to be countably infinite if it is equivalent to the set N of natural numbers.

Example 2.6. Let {worst, very very very very bad, very very very bad, ..., bad, just bad, just fair, fair, very fair, very very fair, ..., just good, good, very good, ..., best} = [worst, best] be a linguistic collection.

We can put an equivalent with natural numbers.

However, the linguistic continuum say [worst, best] or [youngest, oldest] or [slowest, fastest] are uncountable.

In fact any linguistic subinterval of the linguistic continuum is also uncountable.

However, in case of linguistic countable sets any linguistic subinterval is countable.

But as in case of reals we cannot give it a number theoretical proof for we are interested in linguistic mathematical analysis.

For any linguistic term we can have linguistic intervals as

$$L_x = (\min\{x, \theta_1\}, x, \max\{x, \theta_2\})$$

where $\theta_1 < x_1 < \theta_2$ where θ_1 and θ_2 two distinct linguistic terms one very close to x but greater than x and another one very close to x lesser than x . So if S is a linguistic continuum then

$$S \subseteq \bigcup_{x \in S} L_x \text{ but however we cannot conclude any result}$$

analogous to \mathbb{R} , the set of reals.

Now we proceed onto suggest a few problems. How every * (starred) problems are difficult to solve.

PROBLEMS

1. Given S_1 and S_2 are two linguistic sets of orders 6 and 9 respectively.
 - a) How many one to onto linguistic maps can be got from S_1 to S_2 ?
 - b) How many into linguistic maps can be defined from S_1 to S_2 ?
 - c) Can we say if $f_L: S_1 \rightarrow S_2$ such that f_L is a linguistic one to one map, we always have a g_L such that $f_L^{-1} = g_L$ or $g_L^{-1} = f_L$? Justify your claim.

2. Let $S = \{\text{good, very good, bad, just bad, fair, worst}\}$

be a linguistic set associated with the linguistic variable performance aspects of students in classroom.

 - i) Does there exist a linguistic map $f_L: S \rightarrow S$ such that f_L^{-1} does not exist?

- ii) Give an example of a linguistic map $g_L: S \rightarrow S$ such that we have a $f_L: S \rightarrow S$ with

$$g_L \circ f_L = f_L \circ g_L = I_L \text{ (} I_L \text{ the linguistic identity map).}$$

- iii) If $M_L = \{\text{collection of all linguistic maps from } S \text{ to } S\}$.

Will $\{M_L, \circ\}$ (where 'o' is the composition of linguistic maps) be a linguistic semigroup?

- iv) What is $o(M_L)$?

3. If S_1, S_2 and S_3 be three linguistic sets and $f_L: S_1 \rightarrow S_2$ and $g_L: S_2 \rightarrow S_3$ be two linguistic maps

- i) Will $g_L \circ f_L: S_1 \rightarrow S_3$ is a linguistic map from S_1 to S_3 ?

- i) Prove the following

a) $f_L(S_1) \subseteq S_2$

b) If $T_1 \subseteq T_2 \subseteq S_1$ then $f_L(T_1) \subseteq f_L(T_2)$.

4. Give example of unorderable linguistic sets.

5. If S is a totally orderable linguistic set. Prove

- a) $\{S, \min\} = \{S, \cap\}$ is a linguistic semigroup.

- b) Is $\{S, \max\} = \{S, \cup\}$ is a linguistic semigroup?

- c) Prove $\{S, \max, \min\}$ is a linguistic semifield.

- d) Does there exist a linguistic semifield of finite order? Justify your claim.
- e) Will $S = \{\text{good, bad, } \phi, \text{ fair}\}$, the linguistic set, be a linguistic semifield of order 4?
Justify your claim!
6. Derive the Dedekind form of completeness in case of linguistic continuum.
7. Can a finite linguistic set satisfy Dedekind form of completeness? Justify your claim.
8. Give a linguistic line representation of the linguistic continuum [youngest, oldest].
9. Obtain all similar and distinct features between linguistic continuum and reals.
10. Define linguistic neighbourhood in case of a linguistic continuum. Illustrate by an example.
11. Obtain any other special features enjoyed by linguistic sets and linguistic continuum.
12. Describe by an example the notion of linguistic supremum and linguistic infimum.
13. Illustrate linguistic adherent point of a linguistic set by an example.
14. Let $S = [\text{lowest, highest}]$ be a linguistic continuum;

- i) Give example of 4 nonintersecting open intervals.
 - ii) Give examples of 4 intersecting closed intervals.
 - iii) Find the closure of the one given in the examples in (i) and (ii).
 - iv) Are they same or different in case of (ii)?
 - v) What is linguistic interior term? Define and describe by an example.
 - vi) Does the Bolzano Weierstrass theorem true for
 - i) Finite linguistic sets?
 - ii) Partially ordered linguistic set?
 - iii) Linguistic continuum?
 - iv) Give examples of countable and uncountable linguistic sets.
15. Is a linguistic continuum a countable set? Justify your claim.
16. Define linguistic derived set and illustrate it by an example.
17. Is a linguistic derived set bounded? Substantiate your claim.

18. Prove if S is a bounded linguistic set so is its linguistic closure \tilde{S} .
19. Obtain any special feature enjoyed by linguistic derived sets.
20. Prove union of two linguistic closed sets is closed.
21. Prove a linguistic set S is closed if and only if its complement is open. Illustrate this by an example.
22. Define and describe a linguistic dense set.
 - i) Illustrate it by an example.
23. Define and describe linguistic interior points.
24. Prove interior of a linguistic set is a linguistic open set.
- 25*. For the linguistic variable indeterminate give a linguistic line representation.
- 27*. Build linguistic maps / functions using the linguistic variable indeterminate.

Chapter Three

LINGUISTIC PLANES AND GRAPHS

In this chapter we proceed onto define the new notion of linguistic planes and graphs in a very basic way. As this book aims mainly to the basic level of higher secondary students or graduate students in college. We have build linguistic lines (continuum) and discussed about them elaborately in Chapter II of this book. We have also given the diagrammatic representation of the same.

Further we have discussed about closed linguistic intervals, linguistic open intervals, semi open and closed intervals. Properties of linguistic intervals like linguistic boundedness, linguistic interior points, linguistic nbd, linguistic limit points and so on.

We also have discussed about linguistic countable sets and linguistic uncountable sets and so on. We have proved the linguistic version of Bolzano Weierstrass theorem.

Several interesting results in these directions are obtained in the earlier chapter.

We define linguistic planes and develop several properties about them. We have several linguistic planes depending on the linguistic variable. We call the axis as the linguistic horizontal and linguistic vertical axis. For these notions are more a linguistic axis terms than defining them as x and y axis.

To be more precise we will call as linguistic horizontal axis and linguistic vertical axis and proceed onto work. So, this will be our linguistic notation for the axis of the linguistic planes.

Before we go for the rigorous definition of them, we will give examples so that the reader is in a position to understand them.

Example 3.1. Suppose we wish to assess the performance aspects of an employee working in an industry. The linguistic continuum associated with this variable be $S = [\text{worst, best}]$. Taking S along both linguistic axis we get the following plane.

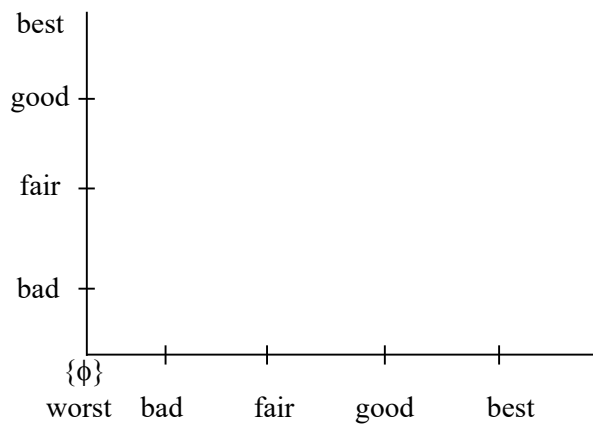

Figure 3.1

Instead of $\{\phi\}$ the empty linguistic set we have taken as the origin which is this case is worst.

However it is pertinent to record the following facts.

Now we give yet another example.

Example 3.2. Let $S = \{\text{old, very old, young, just young, very young, middle aged}\}$

be a linguistic set associated with the age of people.

We have the following linguistic plane associated with S.

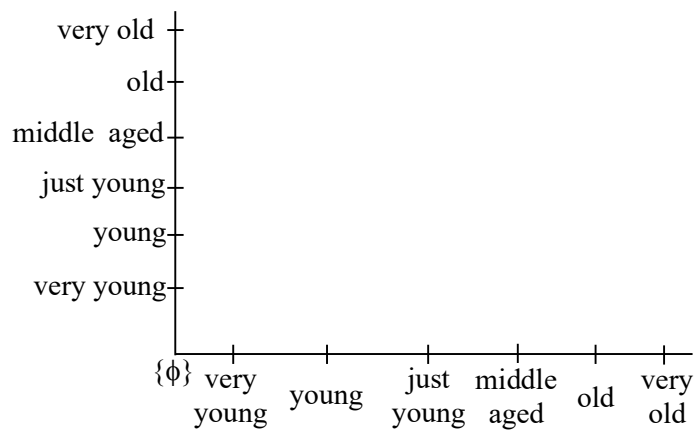

Figure 3.2

We proceed to record the vital properties.

1. Let us consider the horizontal linguistic axis and the vertical linguistic axis and paste them on a plane at right angles to one another in such a way they meet at the linguistic empty word $\{\phi\}$.

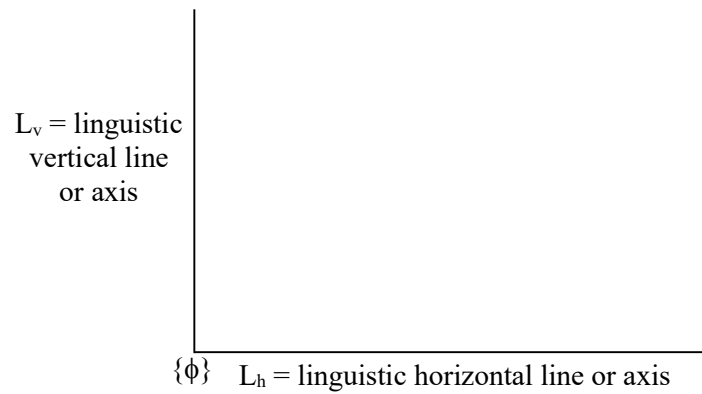

Figure 3.3

The picture of the linguistic plane is given in Figure 3.3.

Let L be a point in the linguistic plane.

We project L perpendicularly onto L_v and L_h on the linguistic vertical and horizontal axes respectively.

If h and v are the linguistic points on L_h and L_v on their respective linguistic axes, we obtain a linguistic point L to the uniquely determined pair (h, v) of real numbers where h and v are called the linguistic horizontal coordinate h and v the vertical linguistic coordinate of L .

We can also reverse the process and starting with the ordered pair of linguistic numbers we can recapture this linguistic point. This is the manner we establish the familiar one-one correspondence between the points L in the linguistic plane and the ordered pair (h, v) of linguistic numbers / terms.

Infact we think or visualize the linguistic point for the first time in the linguistic plane as a geometric object and its corresponding ordered pairs of linguistic numbers / terms (which also can be realized or imagined as an algebraic object) as being for all practical purposes identical with one another.

(That is the linguistic geometric point and the linguistic algebraic point are identical with one another as in the case of classical coordinate planes. They are also identical in the case of linguistic planes).

This will pave way in case of linguistic plane the possibility or probability of defining algebraic structures and development of analytical linguistic geometry or linguistic analytical geometry.

Here for us the linguistic planes is defined to be a set of all ordered linguistic pairs (h, v) of linguistic terms / numbers.

We will denote the linguistic plane by $L \times L$ or L^2 . Presently our linguistic plane is just a linguistic set and has no structure.

We now proceed onto define structure on it.

Recall a space is a set on which we define and combine some algebraic or geometric structure.

We have no means to define on linguistic planes a numerical value between two linguistic pairs of points / terms. We define distance between linguistic terms in a very special way. The line connecting the linguistic points will be known as linguistic line. Every pair of linguistic points we cannot get the

linguistic line, we get the linguistic line if and only if the two linguistic points are comparable.

We must define only linguistic distance, it can start from no distance between two linguistic points which will be denoted by $\{\phi\}$ and the linguistic distance will be measured in the linguistic scale [shortest, longest].

An introduction to linguistic topology can be had from [18] However for the completeness of this book we recall a few of the basic concepts about distance between two linguistic points and so on.

We can associate with two linguistic terms from any linguistic continuum associated with the linguistic variable.

Suppose in the case of linguistic variable performance of students in a classroom, let us consider the linguistic set

[worst, best].

We see for any term good and best, the distance between them is very far or far or is infinite.

Similarly, if we want to find the distance between the two linguistic terms good and just good, we can say just close or just near or close or near.

However, we wish to keep on record this concept of using just close or close is in the hands of the expert or the researchers.

We denote this figuratively or geometrically as

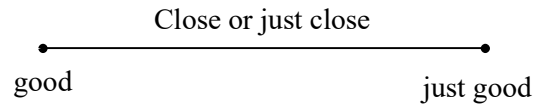
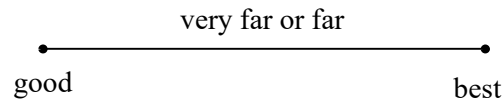
**Figure 3.4****Figure 3.5**

It is important to note this concept of distance is possible only when the linguistic set S on which we give the distance concept or give the distance between two linguistic terms in S are totally orderable.

In case of partially ordered set we define distance for elements which are partially ordered and those that which cannot be related we cannot and do not have the distance between them also will be known as linguistic distance between two linguistic points.

The distance concept geometrically defined for comparable linguistic terms are defined on the plane or linguistic plane.

Now we follow the convention, two or three or more number of linguistic terms can also be given the geometric representation.

For instance we have 3 linguistic terms good, bad, just fair, then the geometric structure is as follows.

We have linguistic straight line connecting good to bad by the linguistic term far or the linguistic distance between good and bad is far.

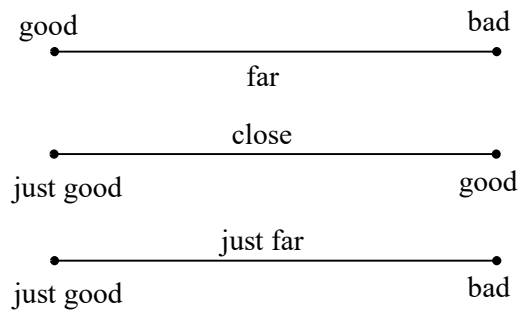

Figure 3.6

Now we have 3 linguistic straight lines clearly we can place them in the form of a linguistic triangle formally or the linguistic geometrical figure is a triangle given by the following figure.

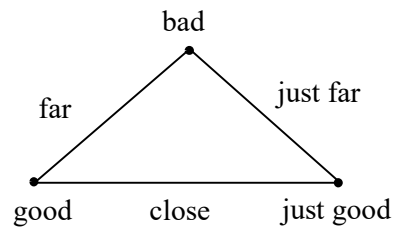

Figure 3.7

To be more like the classical geometry we can say the linguistic straight lines good - just good intersect the other linguistic line good - bad at the point good, the ling lines bad-good and bad just good intersect at bad and the ling lines just good - good and just good - bad intersect at just good resulting

in a ling triangle with ling vertices, bad, good and just good. It is pertinent to keep on record that in general two linguistic lines may not intersect and in general 3 linguistic lines may not form a linguistic triangle.

That is they intersect at good, bad and just fair forming a linguistic triangle.

Suppose we have arbitrarily the following linguistic lines from different linguistic sets.

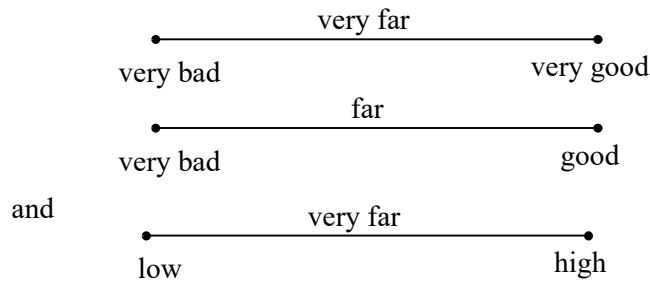

Figure 3.8

Now we see the linguistic straight line l_1 and l_2 intersect at the linguistic term very bad, the linguistic straight line l_3 cannot intersect l_1 and l_2 remains separately.

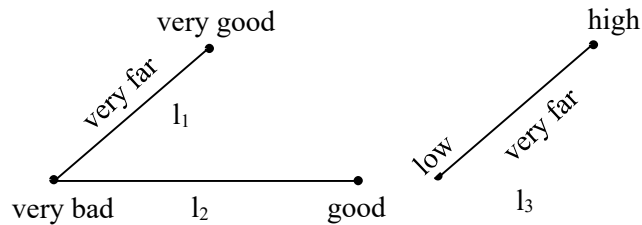

Figure 3.9

Such things can also happen.

Consider the set of linguistic points or terms associated with fruits

{large size, small, orange, green, yellow, light green, medium size, very large, very small}.

Now we have the following linguistic straight lines and linguistic terms

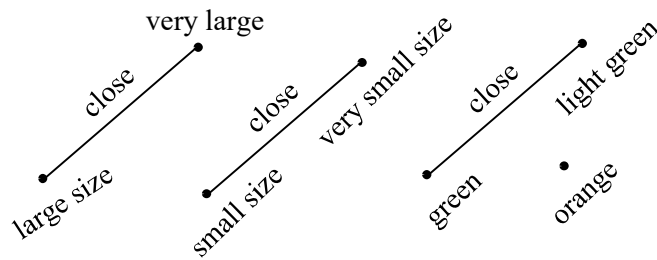

Figure 3.10

Thus, in this book we only use linguistic straight lines with linguistic length associated with it.

However, if two linguistic terms are provided certainly, we call it fixed linguistic length.

Since in this chapter we are interested in linguistic planes and working with elements in the linguistic planes with linguistic horizontal and vertical axis and very linguistic point in this linguistic plane is only a set of ordered pair of points, we proceed onto work with them.

However, if S is a linguistic continuum the ordered linguistic pairs are not totally orderable only partially orderable.

This will give a nice example of a partially ordered linguistic sets.

For consider the linguistic plane $L \times L = H \times V$ where H denotes the linguistic horizontal axis and V denotes the linguistic vertical axis.

Let us take the same linguistic continuum [shortest, tallest] with the linguistic variable height of people. Let ϕ be the empty linguistic term which is got by intersecting the horizontal linguistic axis with the linguistic vertical axis given by the following figure 3.11.

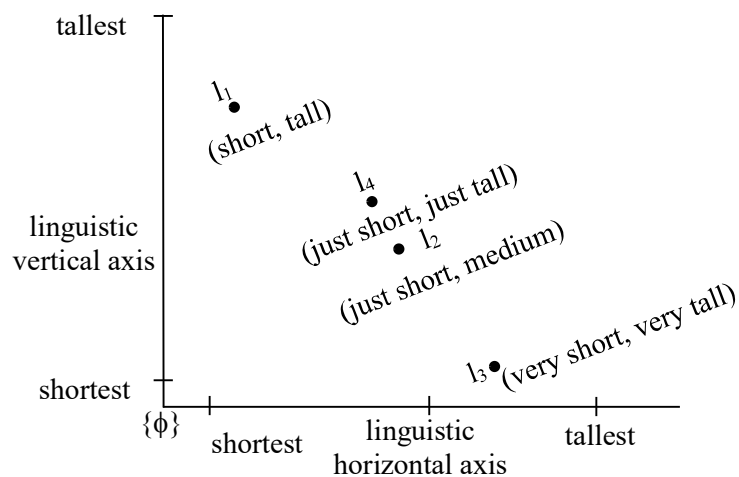

Figure 3.11

Now consider the four linguistic pairs

- l_1 - (short, tall)
- l_2 - (just short, medium)
- l_3 - (very short, very tall) and
- l_4 - (just short, just tall)

Now using the total ordering we get

$$\text{very short} \leq \text{just short} \leq \text{short} \leq \text{medium} \leq \text{just tall} \\ \leq \text{tall} \leq \text{very tall}$$

We say (h_1, v_1) and (h_2, v_2) are comparable if and only if

$h_1 \leq h_2$ and $v_1 \leq v_2$ (or $h_1 \leq h_2$ and $v_1 \geq v_2$; or used in the mutually exclusive sense).

If $h_1 \leq h_2$, and $v_1 \leq v_2$ we say $(h_1, v_1) \leq (h_2, v_2)$ on the other hand if $h_1 \geq h_2$ and $v_1 \geq v_2$ then $(h_1, v_1) \geq (h_2, v_2)$.

Consider l_1 and l_2

- l_1 - (short, tall) and
- l_2 - (just short, medium).

Clearly $\text{just short} \geq \text{short}$, for just short is not short, for we say he is a short man short but not that short will be termed as just short so, $\text{short} \leq \text{just short}$ which are the first entries of l_1 and l_2 respectively.

Now consider the second coordinates of l_1 and l_2 , they are tall and medium respectively. Further

$$\text{medium} < \text{tall} \quad \text{and} \\ \text{short} < \text{just short}$$

Now we cannot order l_1 with l_2 . So they are not comparable as ling pairs.

We can say (h_1, v_1) and (h_2, v_2) are not comparable if either

$$h_1 \geq h_2 \text{ and } v_1 \leq v_2 \quad \dots(1)$$

or
$$h_1 \leq h_2 \text{ and } v_1 \geq v_2 \quad \dots(2)$$

Now in case of l_1 and l_2 the second equation is true so l_1 and l_2 are not comparable.

Consider l_1 and l_3 , we have

$$l_1 = (\text{short, tall}) \text{ and}$$

$$l_3 = (\text{very tall, very short}).$$

$\text{short} \leq \text{very tall}$ and $\text{tall} \geq \text{very short}$ so equation (2) is true hence l_1 and l_3 are not comparable.

Now to compare l_1 and l_4

$$l_1 = (\text{short, tall}) \text{ and } l_4 = (\text{just short, just tall}),$$

$$\text{short} \leq \text{just short}$$

$$\text{just tall} \leq \text{tall}.$$

We see only equation (2) is satisfied hence l_1 and l_4 are not comparable.

l_2 and l_4 are comparable as

$$l_2 = (\text{just short, medium}) \text{ and}$$

$$l_4 = (\text{just short, just tall})$$

$$\text{just short} = \text{just short} \text{ and } \text{medium} \leq \text{just tall}.$$

Hence the claim. $l_2 \leq l_4$.

Only in these l_1, l_2, l_3 and l_4

l_2 and l_4 are comparable.

That is why we mentioned earlier that

$L \times L = \{(h, v) / h, v \in L\}$ is only a partially ordered linguistic set and not a totally ordered linguistic set.

Now in case of real plane $R \times R$

if $x = (8, 3)$ and $y = (2, 7) \in R \times R$;

we see $8 > 2$ and $3 < 7$ hence x and y are not comparable however we have a distance concept defined between x and y

$$\begin{aligned} d(x, y) &= \sqrt{(8-2)^2 + (3-7)^2} \\ &= \sqrt{36+36} = \sqrt{152} = 2\sqrt{13}. \end{aligned}$$

However, in the linguistic planes we have the linguistic distance to be defined very differently.

If we have the following linguistic plane with horizontal linguistic axis as the age of people and vertical linguistic axis as the height of the people in the linguistic continuum

[youngest, oldest] and [shortest, tallest] respectively.

We see

$x = [\text{young, just tall}]$ and $y = [\text{old, very short}]$ in the linguistic plane is not comparable.

However we see the $l_d(x, y)$, where $l_d(x,y)$ denotes the linguistic distance between the linguistic pairs x and y where

$x = (\text{young, just tall})$ and

$y = (\text{old, very short})$ is given by

$l_d(x, y) = (\text{far, very far})$ where the linguistic distance between young and old is far and that of just tall and very short is very far thus

$l_d(x, y) = (\text{far, very far})$ is always a linguistic pair and it is denoted by

$$l_d(x, y) = l_d(d_1(\text{young, old}), d_1(\text{just tall, very short})) \\ = (\text{far, very far}).$$

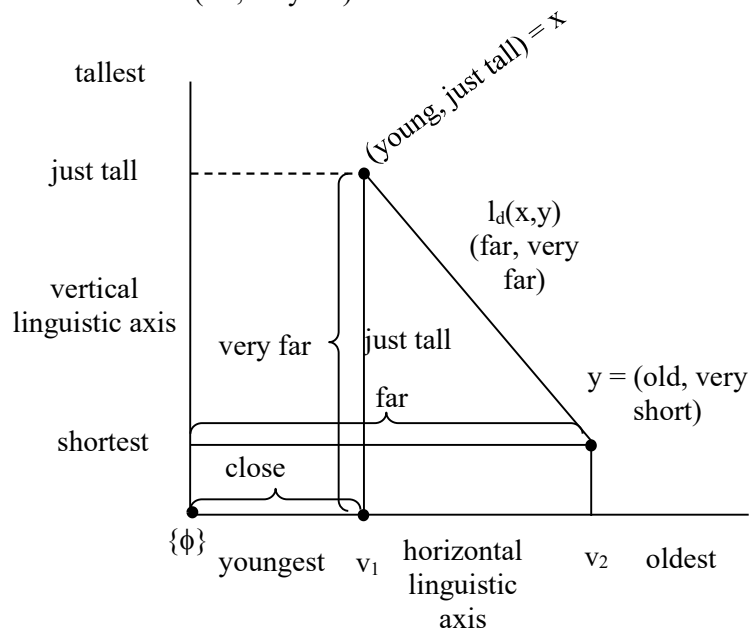

Figure 3.12

Now the distance from the origin ϕ to the ordinate of the vertical linguistic line drawn parallel to the linguistic vertical axis, which denotes the linguistic distance from ϕ to v_1 that is

the linguistic distance from ϕ to young which is close. The linguistic distance from ϕ to just tall is very far.

On similar lines for the linguistic point

$$y = (\text{old, very short}).$$

The linguistic distance from ϕ to old is far and that of the linguistic distance from very short to the linguistic term ϕ is close.

First we will illustrate the concept by one or more examples.

Example 3.3. Let us take the same linguistic vertical and horizontal linguistic axis to form the linguistic plane given by the following figure.

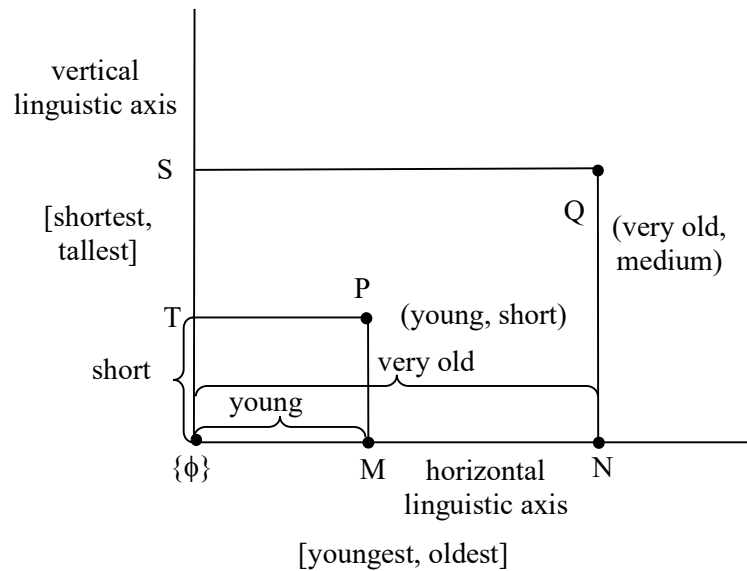

Figure 3.13

Clearly from the linguistic point P draw perpendicular to the linguistic vertical axis and linguistic horizontal axis as PT and PM respectively.

The linguistic distances from ϕ to M is close and that of from ϕ to T is also close respectively.

The linguistic distance from P to ϕ or from ϕ to P is (close, close).

Let Q (very old, medium) be a linguistic point of the linguistic plane.

Draw QN the perpendicular from Q to the linguistic horizontal axis and name it N and QS the perpendicular from Q to the vertical linguistic axis and call the foot of the perpendicular as S.

ϕ N is the linguistic term / value very old and QS is the linguistic term / value medium.

Now the linguistic distance of ϕ N is very far and that of the linguistic distance ϕ S is medium distance.

Hence the linguistic distance ϕ Q is the pair

(very far, medium).

Now we find the linguistic distance in the linguistic plane where the linguistic horizontal axis corresponds to the growth of the plants in a field and linguistic vertical axis corresponds to the yield of the plants.

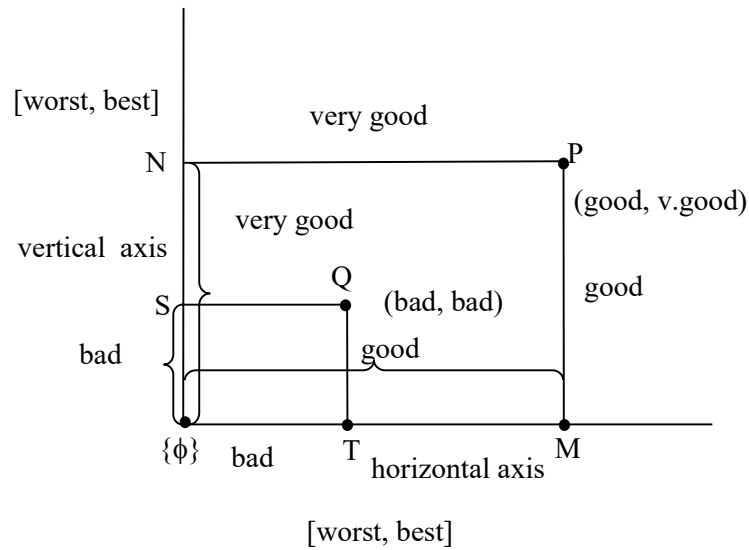

Figure 3.14

Both the yield and the growth are measured in the linguistic scale [worst, best]. However, it is in the hands of the expert to measure the growth of plants by height as

[shortest, tallest] and so on.

It is also pertinent to keep on record at this juncture as there are several linguistic continuums so are the number of linguistic planes.

We have only one real plane but several numbers of linguistic planes depending on the linguistic variable under study.

We have just now described how to represent a linguistic point in a linguistic plane. Also, we have defined the new concept of linguistic distance of any two linguistic point.

The linguistic distance is also a pair of linguistic terms, the first coordinate represents the distance between two linguistic terms represented by the horizontal linguistic line. The second coordinate representative linguistic distance between the linguistic vertical terms.

That is if $x = (h_1, v_1)$ and $y = (h_2, v_2)$ then

$$l_d(x, y) = (d_1(h_1, h_2), d_1(v_1, v_2));$$

this is the way we represent the linguistic plane which, represents linguistic points (pairs) and the linguistic distance between pairs of points.

Now we give the definition of linguistic functions and linguistic graphs represented by them.

Suppose the linguistic horizontal line takes the values [shortest, longest]; the length of the paddy plants grown in a field and the linguistic vertical axis has the linguistic value [poorest, best] which depicts the yield of the paddy plant.

Let f be a function from

[shortest, longest] to [poorest, best] given as follows.

$f(\text{shortest}) = \text{poorest}$

$f(\text{very short}) = \text{poor}$

$f(\text{short}) = \text{poor}$

$f(\text{just short}) = \text{just medium}$

$f(\text{just medium}) = \text{good}$

$f(\text{medium}) = \text{good}$

$f(\text{just tall}) = \text{very good}$

f (tall) = very good

f (very tall) = very good

f (tallest) = good

f is such that every value in the linguistic continuum

[shortest, tallest] takes values in the linguistic continuum [poorest, best].

We get the linguistic plane using [shortest, tallest] as the linguistic horizontal axis and [poorest, best] is taken as the linguistic vertical axis.

The linguistic plane is given in figure 3.15.

We have defined $f(h) = v$ where $h \in [\text{shortest}, \text{tallest}]$ and $v \in [\text{poorest}, \text{best}]$.

Now we plot the points on the linguistic plane given in Figure 3.15.

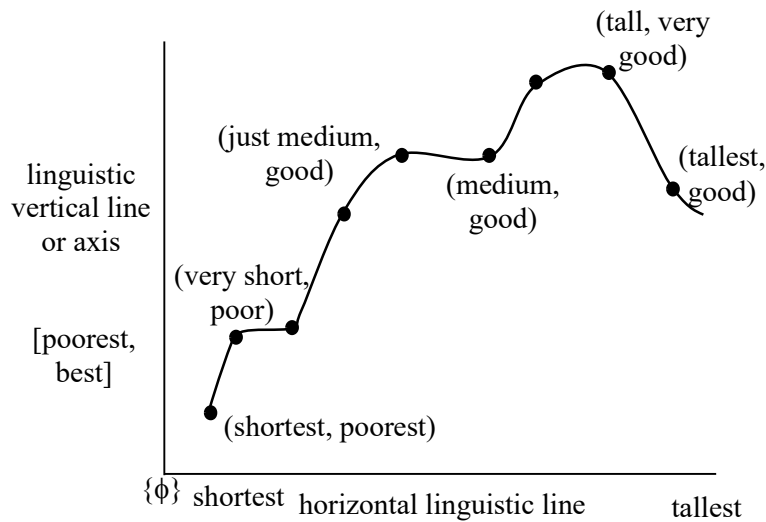

Figure 3.15

The following observations are important.

- i) $f(h) = v$ where $h \in [\text{shortest, tallest}]$ and $v \in [\text{poorest, best}]$ is a continuous curve.
- ii) It is increasing till it reaches very tall at the stage of tallest then it decreases (the observations by the experts is when the paddy plant grows very very tall, that is a height which is very much higher than the average height the yield becomes not the best or very good, it is good only; for the energy of the growth in height hinders the best yield in some cases. Study in this direction is mandatory).

In fact, when the paddy does not grow to the specified height it implies short or very short or just short are only stunted growth, so naturally the yield will be comparatively low or very low.

Thus, the function is a continuous one and the graph of $f(h)$ is given in Figure 3.15.

This curve from the observation shows that it is continuous cannot say increasing all the time for there are sub intervals which are linguistically constant.

We now proceed onto give more examples of linguistic functions and their graphs.

Example 3.4. Consider the linguistic variables performance aspect students and teachers who teach them and their performances with linguistic continuums [worst, best] and [worst, best] respectively. That is both are evaluated on the same linguistic scale.

Taking on the linguistic vertical axis the performance of teacher and that of students on the linguistic horizontal axis we get the linguistic plane and the linguistic graph in figure 3.16.

The linguistic function $f: [\text{worst, best}] \rightarrow [\text{worst, best}]$ is defined in the following way.

f : student performance \rightarrow teacher performance

- $f(\text{very bad}) = \text{worst teacher}$
- $f(\text{bad}) = \text{very bad}$
- $f(\text{fair}) = \text{just good}$
- $f(\text{good}) = \text{good}$
- $f(\text{very good}) = \text{good}$
- $f(\text{best}) = \text{very good}$

We give the linguistic plane and the linguistic graph of the linguistic function in the Figure 3.16.

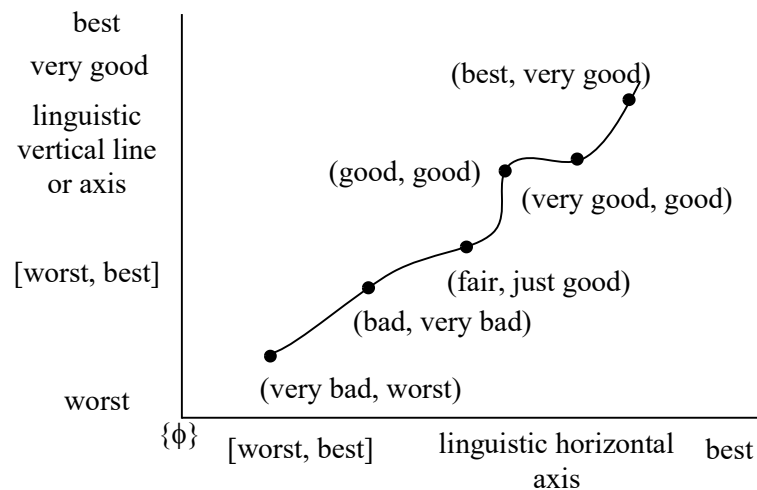

Figure 3.16

The linguistic graph of the linguistic function is a continuous curve.

Now we give an example of linguistic plane whose linguistic horizontal axis is the customers feedback of some products and on the linguistic vertical axis is the quality of the product.

It is in the hands of the expert to choose the linguistic set / continuum for the customers feedback as [worst, best] and that of the quality of the product in the linguistic continuum as [worst, best].

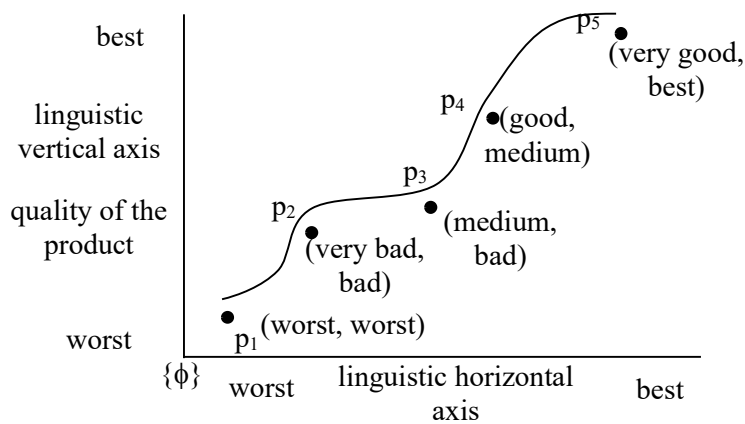

Figure 3.17 Customers feedback

Let $f: [\text{worst, best}] \rightarrow [\text{worst, best}]$

$f: \{\text{customers feedback}\} \rightarrow \{\text{quality of the product}\}$

From the linguistic graph one can map the function f in the following way.

p_1 (worst, worst) is mapped as $f(\text{worst}) = \text{worst}$

p_2 (very bad, bad) is mapped as $f(\text{very bad}) = \text{bad}$

p_3 (medium, bad) is mapped as $f(\text{medium}) = \text{bad}$

p_4 (good, medium) is mapped as $f(\text{good}) = \text{medium}$

p_5 (very good, best) is mapped as $f(\text{very good}) = \text{best}$.

This customer happens to be giving quite a positive report about the product.

This is the way the mappings are done in general.

Different customer can give different opinions on the same product. This can be kept in mind as the values basically depends on the expert's opinion only.

Next, we discuss about the increasing and decreasing linguistic functions.

It is pertinent to keep on record a given linguistic function even if it is a continuous linguistic function, it may not always be decreasing or increasing or at times constant. The linguistic function can be linguistically increasing in some linguistic sub interval and remain constant in some linguistic subinterval and decreasing in some other linguistic subinterval.

Thus, for instance consider the linguistic graph given in figure 3.15.

The linguistic function f is increasing in the linguistic sub interval [shortest, very short], remains constant in the linguistic

sub interval [very short, short] for if take the constant value poor.

It is interesting and important to note when the linguistic function happens to be constant it is parallel to the linguistic horizontal axis.

The linguistic function decreases in the linguistic sub interval [tall to tallest].

Thus a linguistic function f need not always be an increasing one throughout the linguistic continuum, or decreasing one throughout the linguistic continuum or is constant throughout the linguistic continuum.

Now we define these concepts abstractly.

Definition 3.1. Let $L \times L$ be a linguistic plane with linguistic variable l_1 associated with the linguistic horizontal axis and l_2 associated with the linguistic vertical axis;

$f: \{\text{linguistic set associated with the linguistic variable } l_1\} \rightarrow$

$\{\text{linguistic set associated with the linguistic variable } l_2\}$

Both l_1 and l_2 contribute only to a linguistic continuum for otherwise;

we will not have the linguistic plane.

Now we say f is a increasing continuous linguistic function; if $x_1 > x_2$ in the linguistic terms then $f(x_1) > f(x_2)$.

If this happens in whole of the linguistic continuum then we say the linguistic function is an increasing one or strictly increasing one.

If on the other hand it increases only on a linguistic subinterval then we say the linguistic function increases only on the linguistic subinterval.

The linguistic function f is said to be a decreasing linguistic function if x_1 and x_2 are linguistic terms associated with l_1 and if $x_1 > x_2$ then we have $f(x_1) < f(x_2)$. If this is true in the whole of the linguistic continuum then we say f is a decreasing linguistic function. If on the other hand the linguistic function decreases only on some linguistic subintervals then we say the function decreasing on some linguistic subintervals only.

The linguistic function f is said to be a constant one if $x_1 > x_2$ (x_1 and x_2 linguistic terms associated with l_1) we have $f(x_1) = f(x_2)$. If $f(x_i) = f(x_j)$ ($x_i > x_j$; $i \neq j$) for all i and j then we say the linguistic function is a constant linguistic function.

If for $x_i > x_j$ ($i \neq j$) we have $f(x_i) = f(x_j)$ only for some linguistic subinterval of the given linguistic interval then we say the linguistic function is a constant linguistic function only on the linguistic subinterval and not on the whole of the linguistic interval.

We give examples of all the three situations.

Example 3.5. Let l_1 be the linguistic variable associated in the age group from middle age to old age [middle age, old age], be the linguistic continuum.

Taking height of the person in this age group as the linguistic variable l_2 .

We have the linguistic plane taking the linguistic variable l_2 as the vertical linguistic axis and l_1 as the horizontal linguistic axis this is given in the following figure 3.18.

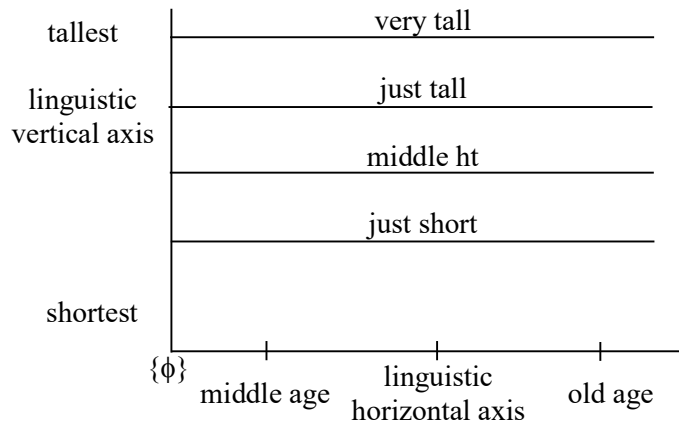

Figure 3.18

Since the growth of people in height in the age group [middle age, old age] is the same they have no growth in height in this linguistic interval period of age.

Thus $f: [\text{middle age}, \text{old age}] \rightarrow [\text{shortest}, \text{tallest}]$

is always a constant, so is a constant linguistic function.

Now having seen example of a linguistic constant function we now proceed onto give an example of a linguistic increasing function.

Example 3.6. Let us take the linguistic variable age from youngest to youth, that is the linguistic continuum or interval [youngest, youth] along the linguistic horizontal axis. Let the linguistic variable height of people have its associated linguistic set / interval to be taken as the linguistic vertical axis [shortest, tallest].

The resulting linguistic plane is as follows.

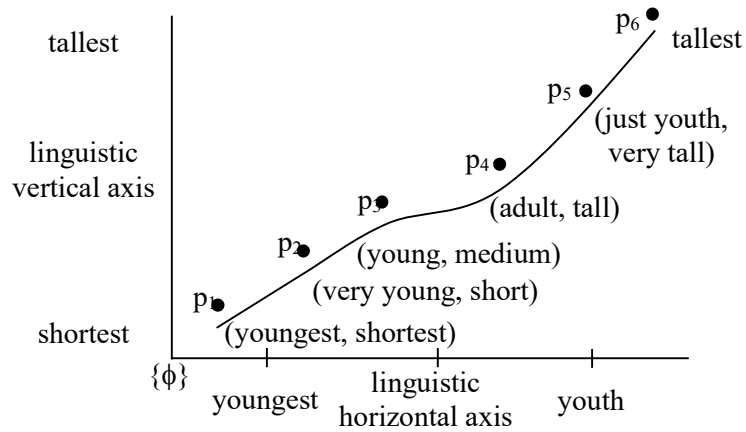

Figure 3.19

We see the linguistic graph of the linguistic function f defined from

$$f: \{\text{linguistic variable age}\} \rightarrow \{\text{linguistic variable height}\}$$

is defined for a person with a normal growth.

That is $f: [\text{youngest}, \text{youth}] \rightarrow [\text{shortest}, \text{tallest}]$.

Here the study not the usual medical growth chart but the growth of an infant in height till its youth where the person does

not grow any more so the linguistic term shortest mean it's the infants height at the birth and the linguistic term tallest means the highest value that persons has achieved no more growth takes place.

Now we have seen the linguistic function and the linguistic curve associated with those linguistic function

$$f: [\text{youngest, youth}] \rightarrow [\text{shortest, tallest}].$$

For $p_1 = (\text{youngest, shortest}); f(\text{youngest}) = \text{shortest}$

For $p_2 (\text{very young, short}); f(\text{very young}) = \text{short}$

and so on.

It is pertinent to keep on record this linguistic function f only gives the value of the linguistic term height at each stage of growth of a child, it is not this height for that specific child is tall and so on and so forth.

We see it is a continuous linguistic curve which is increasing in that continuum.

Next we study about some decreasing linguistic function on the given interval.

Let us consider the linguistic variable temperature of the in cold months day from midday noon to mid night. We take the linguistic set / continuum along the linguistic horizontal axis. Along the vertical linguistic axis we take the temperature [lowest, highest], the linguistic continuum associated with it.

Now let the linguistic planes of these linguistic variables be as follows.

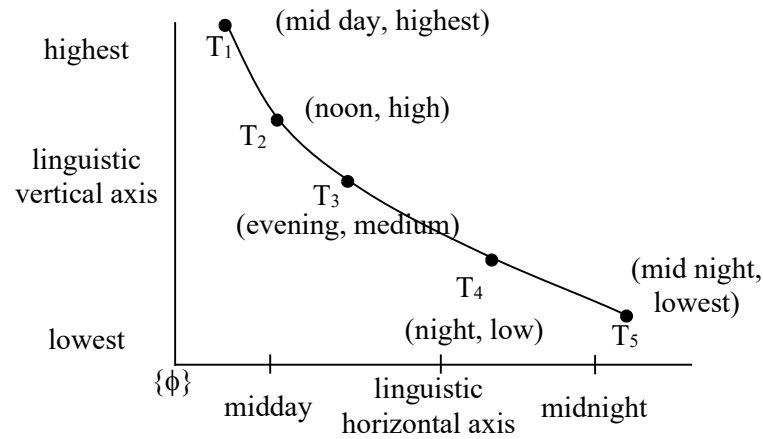

Figure 3.20

Let f be the linguistic function defined from the linguistic continuum;

$$f: [\text{mid day, mid night}] \rightarrow [\text{lowest, highest}]$$

That is f is a linguistic function from the {linguistic continuum; [mid day, mid night] from mid day to mid night on a day in winter} \rightarrow {linguistic continuum [lowest, highest], the temperature on a day in winter}.

Clearly f is a continuous function.

Infact a decreasing function as in the mid day we have the highest temperature of the day and gradually decreases and by evening the temperature becomes medium and in the mid night the temperature is lowest.

Now we give the interpretation of the linguistic points given the figure 3.20.

$T_1 = (\text{mid day, highest})$ will mean $f(\text{mid day}) = \text{highest}$

T_2 will mean; $f(\text{noon}) = \text{high}$.

That is the temperature at mid day is the highest.

Similarly the temperature at noon is high and so on and so forth.

$(\text{mid night, lowest})$ means that temperature at mid night is the lowest

i.e. $f(\text{mid night}) = \text{lowest}$.

The curve is decreasing, and the linguistic function is also a decreasing one. However, it is pertinent to record at this juncture we can have linguistic function which are constant or increasing or decreasing.

Further we can also have a linguistic function which can be increasing in a linguistic subinterval, decreasing in some linguistic subinterval and constant in some other linguistic subinterval.

We cannot specify them as increasing or decreasing or a constant linguistic function. Examples of them are given.

Next, we wish to discuss about graphs of those linguistic functions which has only a finite set of linguistic points. However, these linguistic terms are from a linguistic continuum associated with a linguistic variable.

So, the linguistic plane for these linguistic continuum is well defined.

If the linguistic terms belong to these two linguistic continuums which forms the linguistic plane then only the function which is a map from a finite linguistic set of the horizontal linguistic axis to that of the finite linguistic set of the vertical linguistic axis.

We will supply some examples to this effect which will make the reader to understand these concepts.

Example 3.7. Let us study the age of a finite number of people given as

$$S_1 = \{\text{old, young, just young, very old, very young, middle aged}\}$$

the linguistic set associated with linguistic variable age of people.

Clearly $S_1 \subseteq [\text{youngest, oldest}]$.

Let

$$S_2 = \{\text{short, just short, very short, tall}\} \subseteq [\text{shortest, tallest}]$$

be the linguistic finite set associated with the linguistic variable weight.

S_2 the linguistic set corresponds to the linguistic weight of the persons given in the linguistic set S_1 .

Let η be a linguistic map or function from S_1 to S_2 given by the following figure 3.21.

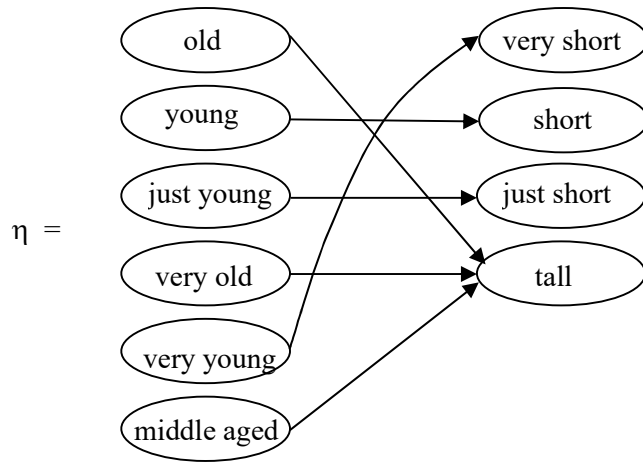

Figure 3.21

So $\eta(\text{old}) = \text{tall}$

that is he is tall and he is fully grown likewise

$\eta(\text{middle aged}) = \eta(\text{very old}) = \text{tall}$

$\eta(\text{very young}) = \text{very short}$

$\eta(\text{just young}) = \text{just short}$

$\eta(\text{young}) = \text{short.}$

Now the linguistic plane with the linguistic horizontal axis taken as [youngest, oldest] and the linguistic vertical axis as [shortest, tallest].

The linguistic plane taking the linguistic continuum [youngest, oldest] as the linguistic horizontal axis and along the linguistic vertical axis we take the linguistic continuum [shortest, tallest].

On this linguistic plane we map the linguistic function of these finite sets given in figure 3.21.

The linguistic finite set S_1 takes its values along the linguistic horizontal axis and linguistic finite set S_2 takes its values along the linguistic vertical axis and the linguistic graph is not a continuous linguistic graph only linguistic points pair, which is represented in figure 3.22.

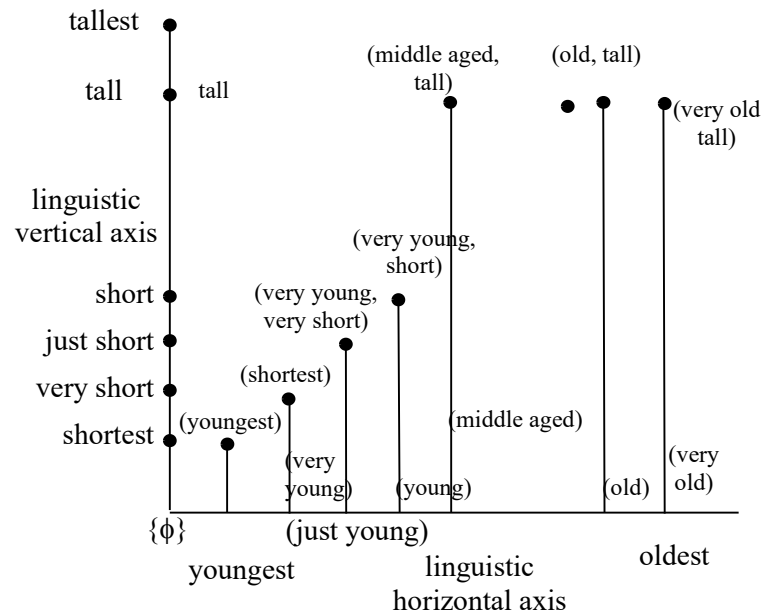

Figure 3.22

So they are just points or in fact linguistic pairs so we have only line graphs. If on the other hand if we define the function not as maps from the finite linguistic set S_1 to the linguistic set S_2 we see f is not connected or a continuous linguistic graph.

Now define the linguistic map g from the linguistic sub interval.

$$[\text{very young, very old}] \rightarrow [\text{very short, tall}] \text{ and}$$

$$g(x) = f(x) \text{ for } x \in [\text{very young, very old}]$$

then we get a continuous linguistic graph of g for this linguistic function.

The linguistic graph in these linguistic subintervals is continuous and given in figure 3.23.

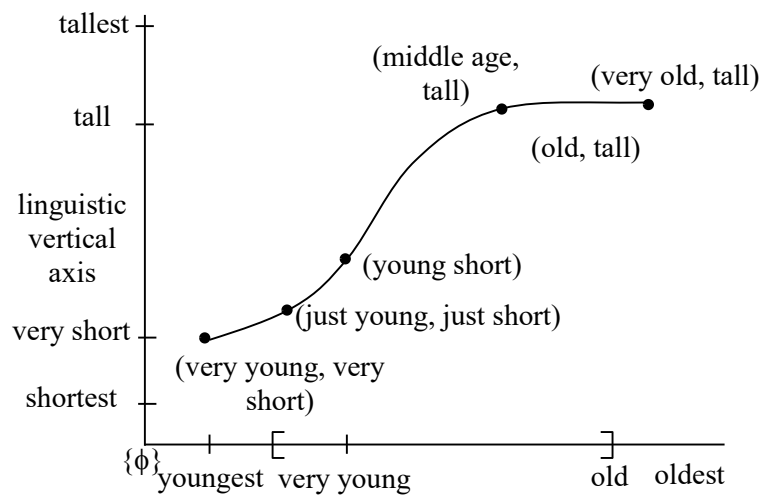

Figure 3.23

We see the function

$$g: [\text{very young, very old}] \rightarrow [\text{very short, tall}]$$

defined on the linguistic subintervals in an linguistic extension of the linguistic map f .

We say as in the case of classical function, a linguistic function g is an extension of the linguistic function f if

$$f(x) = g(x) \text{ for all } x \text{ in the domain of } f.$$

It is observed the linguistic function g on this linguistic subintervals is

- i) Continuous linguistic function.
- ii) It is both increase and constant in fact increasing in the subinterval
[very old], [very young, middle age]
and constant on linguistic subinterval
[middle age, very old].

However the linguistic function g is not decreasing.

Now having seen examples of graphs of discontinuous linguistic functions we now proceed onto give examples of them.

Example 3.8. Let $L \times L$ be a linguistic plane obtained by taking along the linguistic horizontal axis the growth of the paddy plants in a specified which is the linguistic variable associated with the linguistic interval [worst, best].

Let the linguistic vertical axis correspond of the linguistic interval

[most unsatisfactory, very satisfactory]

associated with the linguistic variable yield of those paddy plants. The linguistic plane is given in figure 3.23.

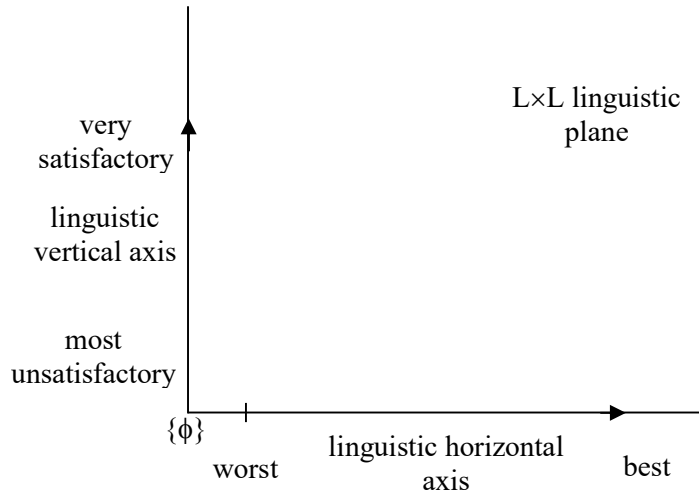

Figure 3.24

Consider the linguistic set

$P_1 = [\text{bad, medium}] \cup [\text{good to very good}] \subset [\text{worst, best}]$ and
 $P_2 = [\text{most unsatisfactory, very satisfactory}]$.

The linguistic function $f: P_1 \rightarrow P_2$ is defined as

$f(\text{bad}) = \text{very unsatisfactory}$
 $\cdot \quad \quad \quad \cdot$
 $\cdot \quad \quad \quad \cdot$
 $\cdot \quad \quad \quad \cdot$

$f(\text{medium}) = \text{just satisfactory}$

$f(\text{good}) = \text{satisfactory}$
 $\cdot \quad \quad \quad \cdot$
 $\cdot \quad \quad \quad \cdot$
 $\cdot \quad \quad \quad \cdot$

$f(\text{best}) = \text{very satisfactory,}$

Clearly the linguistic function f or the map is well defined.

Now we give the linguistic graph of the linguistic function given in the linguistic plane given in figure 3.25 in the following.

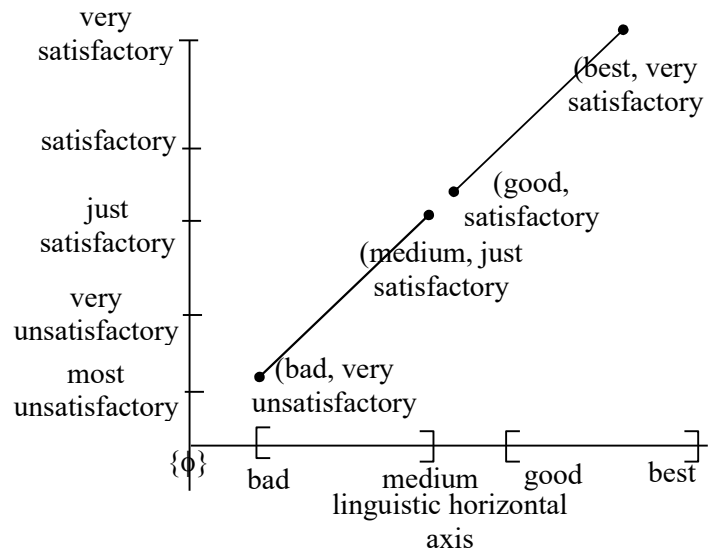

Figure 3.25

Clearly the linguistic graph is not a continuous graph. However, it is increasing in both the linguistic sub intervals.

This is an example of discontinuous linguistic graph.

Next we take for

$$R_1 = \{\text{very bad, just medium, medium}\} \cup$$

$$[\text{just good, very good}] \subseteq [\text{worst, best}]$$

as the linguistic set associated with the linguistic horizontal axis
and

$$R_2 = [\text{most unsatisfactory, very satisfactory}]$$

taken as the linguistic interval associated with the linguistic
vertical plane.

We use the linguistic plane given in figure 3.26 to draw
the linguistic graph of the linguistic function g defined from
 $R_1 \rightarrow R_2$ as

$$g(\text{very bad}) = \text{very unsatisfactory,}$$

$$g(\text{just medium}) = \text{just satisfactory,}$$

$$g(\text{medium}) = \text{just satisfactory, and}$$

$$g(\text{just good}) = \text{satisfactory}$$

$$\begin{array}{ccc} \cdot & & \cdot \\ \cdot & & \cdot \\ \cdot & & \cdot \end{array}$$

$$g(\text{very good}) = \text{very satisfactory}$$

Now we give the linguistic graph of the linguistic
function g by the following figure 3.26.

Graph of linguistic function g given in figure 3.26

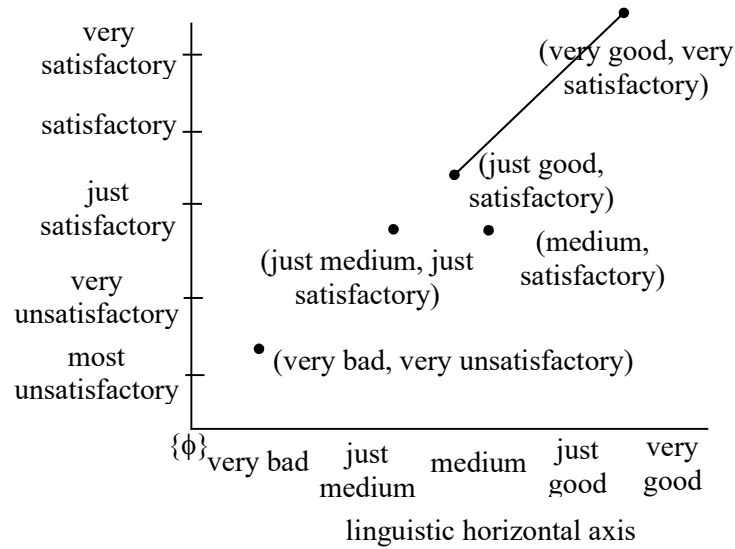

Figure 3.26

Clearly the linguistic graph of the linguistic function g is not a continuous linguistic map, however this discontinuity is different from the linguistic graph associated with the linguistic function f given in figure 3.25.

Now having seen the notion of continuity, increasing non decreasing, decreasing, non-increasing linguistic functions we proceed onto define distance concept in the linguistic plane between pair of linguistic points in it.

Already we have discussed that if (x_1, y_1) and (x_2, y_2) are two linguistic points then

$$d_l(x_1, y_1), (x_2, y_2) = (l_d(x_1, x_2), l_d(y_1, y_2))$$

where x_i, y_i are linguistic points in a linguistic set or a linguistic continuum.

Now we represent this explicitly.

Consider the linguistic continuum [worst, best] and let $L \times L$ be the linguistic plane taking along both the linguistic horizontal axis as well the linguistic vertical axis the same linguistic continuum [worst, best].

Let us consider $P(\text{good, bad})$ and $Q(\text{bad, good})$ two linguistic points in that linguistic plane given by the following figure 3.27.

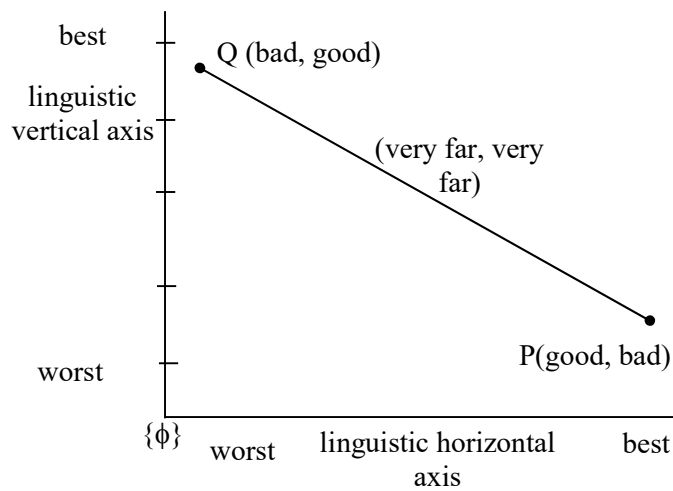

Figure 3.27

$$d_l(\text{bad, good}) = d_l(\text{good, bad})$$

as it is the linguistic very far distance between bad and good and good and bad.

So reaching from bad to good or good to bad is in fact very far.

So $d_i(P, Q) = (\text{very far, very far})$.

Now on the same linguistic plane given in figure 3.27, we find the linguistic distance between the linguistic pair of points. $T(\text{worst, bad})$ and $M(\text{good, far})$ and them in the linguistic plane and is described in figure 3.28.

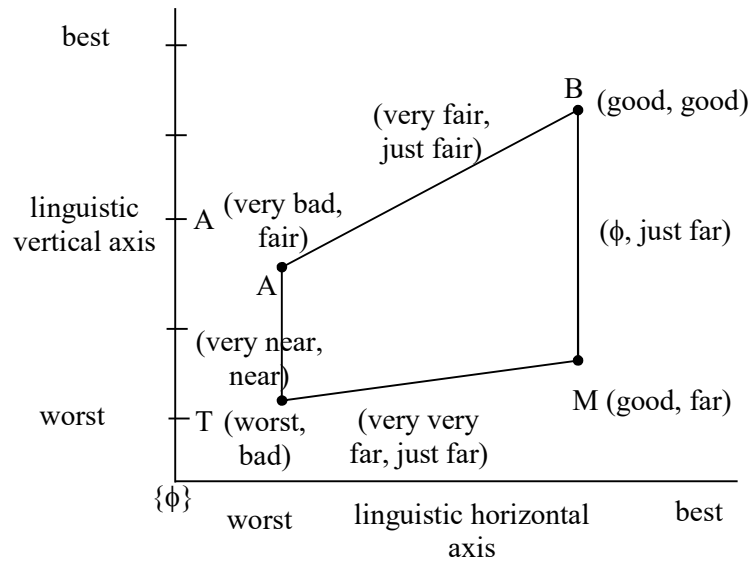

Figure 3.28

Suppose on the same plane we have A and B given by $A(\text{very bad, fair})$ and $B(\text{good, good})$.

We see AB the linguistic line does not intersect the linguistic line TM. In fact we can consider the distances TA and BM.

Thus TABM or TMBA is a linguistic quadrilateral in the linguistic plane. We can also find the distance between the diagonals. Infact they intersect.

We will depict linguistic lines, linguistic triangles and so on in the following linguistic plane and describe it in the figure 3.30.

Now first we proceed onto describe the straight line in the linguistic plane.

Example 3.9. Let us consider the linguistic plane formed with age as the linguistic variable on the linguistic horizontal axis which takes the linguistic continuum [youngest, oldest] and for the linguistic vertical axis we take the linguistic continuum [shortest, tallest] associated with the linguistic variable height of people.

We take a pair of linguistic points A (young, short) and B (old, very tall) of two persons A and B which is described in the following figure 3.29.

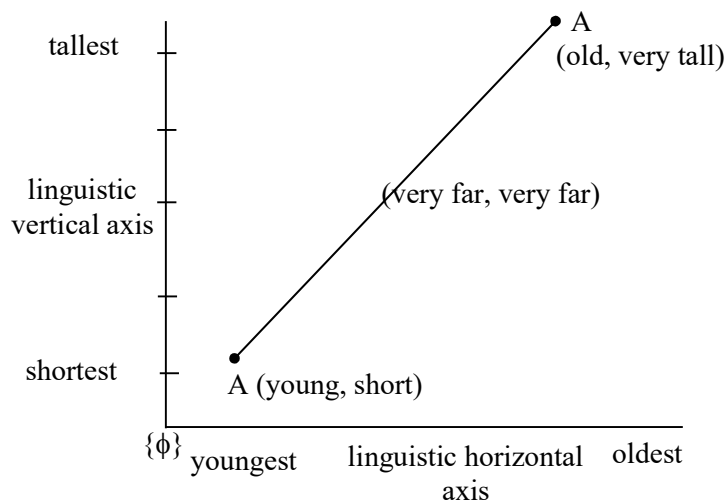

Figure 3.29

The linguistic distance between the linguistic pair A and B denoted by

$$d_l(A, B) = (\text{very far, very far}).$$

So we can have linguistic line connecting two linguistic points and the linguistic distance is also a linguistic pair. This can say how far is those points linguistic from each other (distance of linguistic points on linguistic horizontal axis, distance linguistic of linguistic points on linguistic vertical axis).

Now we will show on the same linguistic plane height of two persons say P_1 and P_2 where P_1 is a middle aged man and P_2 is a old man. It is from observation both are tall.

Now we describe the linguistic line connecting P_1 and P_2 on the linguistic plane given in figure 3.30.

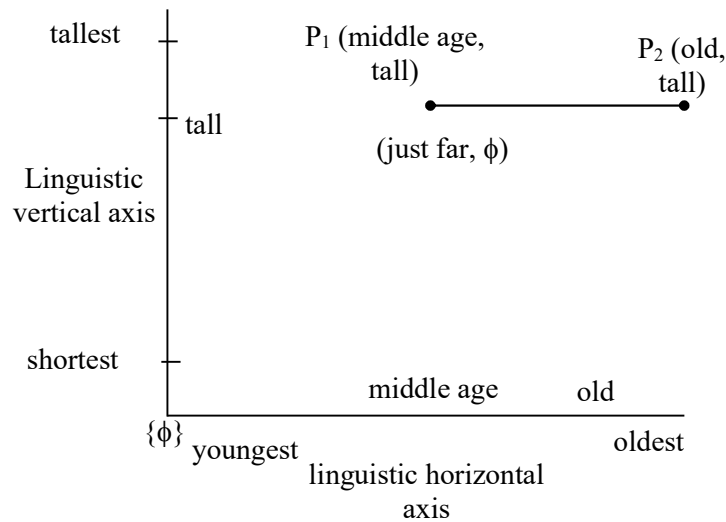

Figure 3.30

We see the linguistic points P_1 and P_2 forms a straight line which is parallel with the linguistic horizontal axis. The linguistic distance between P_1 and P_2 is (just far, ϕ).

On the same linguistic plane we draw the linguistic straight line connection

Let Q_1 (middle age, medium height) and

Q_2 (middle age, very tall)

of two persons in the age group, middle age.

We represent it in the same linguistic planes used in figure 3.30 and figure 3.31 which is given in the following.

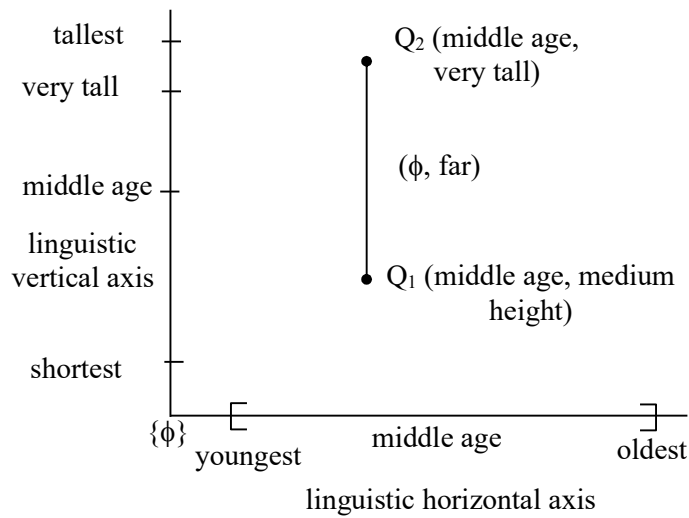

Figure 3.31

The linguistic straight line Q_1Q_2 has a linguistic distance to be (ϕ , far).

The specialty about the linguistic line is that it is a linguistic vertical line parallel to the linguistic vertical axis.

We characterize linguistic lines parallel to linguistic vertical axis and linguistic horizontal axis in the following:

- i) A linguistic straight line P_1P_2 is horizontal and is parallel to the linguistic horizontal axis if and only if the second component of the linguistic variable of the linguistic pairs in P_1 and P_2 are equal or equivalently the linguistic distance between the second two components is ϕ ; refer figure 3.30.
- ii) A linguistic straight line Q_1Q_2 is vertical or is parallel to the linguistic vertical axis if and only if the first component of the linguistic variable of the pairs Q_1 and Q_2 are equal or equivalently the linguistic distance between the first two components is ϕ , refer figure 3.31.

Now abstractly for linguistic line to be parallel with linguistic horizontal axis if

P_1 (middle age, tall) and P_2 (old, tall),

we see the second linguistic components of P_1 and P_2 is tall in both P_1 and P_2 . So the linguistic distance between tall and tall is ϕ .

For linguistic lines Q_1Q_2 to be parallel with linguistic vertical axis if

Q_1 (middle age, medium height), and

Q_2 (middle age, very tall)

we see the first linguistic components of Q_1 and Q_2 is same that is middle age or equivalently the linguistic distance of the first component is ϕ .

Now we find the linguistic triangles in these linguistic plane given in figure 3.30 and 3.31.

Let A (young, short), B (middle age, tall) and C (old, tall) be three linguistic pairs connecting the linguistic sets associated with age and height respectively.

We represent the triangle in the linguistic plane in figure 3.33.

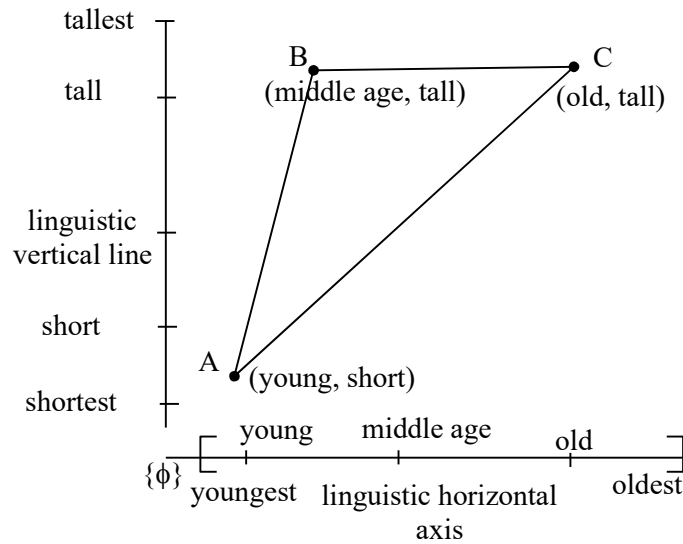

Figure 3.32

Consider 3 persons in the same age group say youth then respective heights are

A (youth, just short)

B (youth, medium height) and

C (youth, tall)

we fix them in the linguistic plane described in figure 3.32.

The linguistic graph is given by the following figure 3.33.

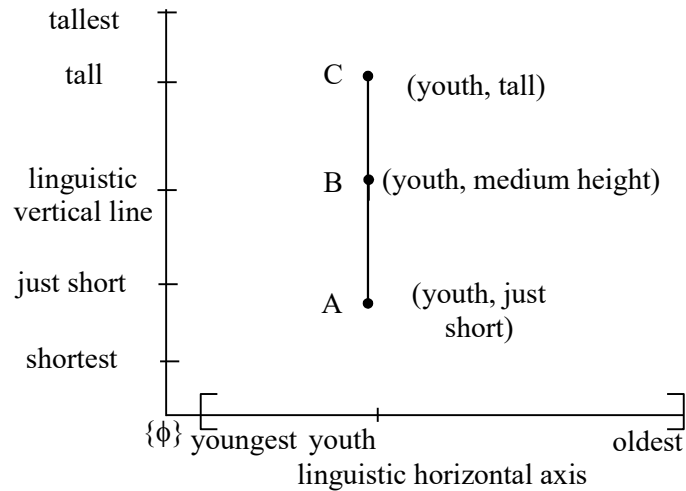

Figure 3.33

We see the 3 linguistic points are collinear as is seen from the graph in figure 3.33.

In fact, it is a linguistic line parallel to the linguistic vertical axis as all the three linguistic pairs A, B and C have their first linguistic coordinate to be youth.

Now consider the three people in the age group old, very old and middle aged all of them happen to be tall given by the three linguistic pair of points.

A (old, tall), B(very old, tall) and C (middle aged, tall)

given by the following graph using the linguistic plane given in figure 3.34.

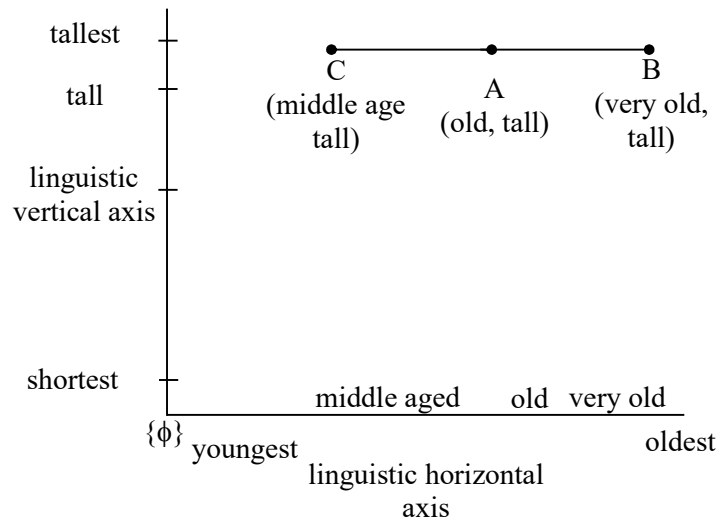

Figure 3.34

Consider the 3 linguistic points A, B and C they lie on the linguistic line CAB that is they are collinear and since all the second component linguistic term is the same for all the three viz tall we see this linguistic line CAB is parallel to the linguistic horizontal axis.

Now consider the three linguistic pair given by A, B and C represented in the same linguistic plane given as in figure 3.36.

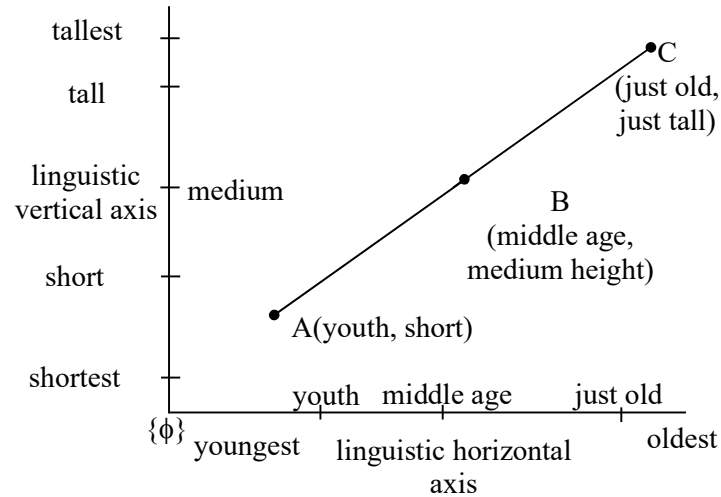

Figure 3.35

We see the linguistic line ABC is neither parallel to the linguistic horizontal axis nor parallel to the linguistic vertical axis. Further all the three linguistic points ABC are collinear.

Now we see three are four types of 3 linguistic pair of points given in figures 3.32 to 3.35 respectively.

Next, we consider four linguistic pairs of points on the same linguistic plane given in figure 3.35 where

A (youth, short), B (middle age, medium height),

C (just old, just tall) and D (middle age, just tall)

where B and D two person in the middle age and B is just medium height whereas D is just tall.

We give the linguistic graph of ABCD in the following figure 3.36.

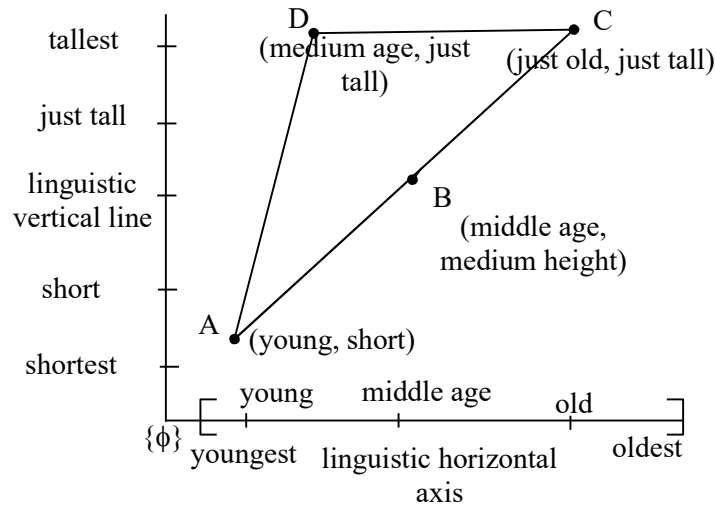

Figure 3.36

We see for the four linguistic points ABCD since the three points ABC are collinear and D is not on ABC the four linguistic points ABCD forms only linguistic triangle. The set of points A, D and C are linguistic non collinear.

Now consider the four linguistic points

A(young, very short), B(young, medium height),

C(old, just tall) and D(old, very tall).

Using the same linguistic plane as given in figure 3.36 we obtain the linguistic graph of these four linguistic points and that is given by the figure 3.37.

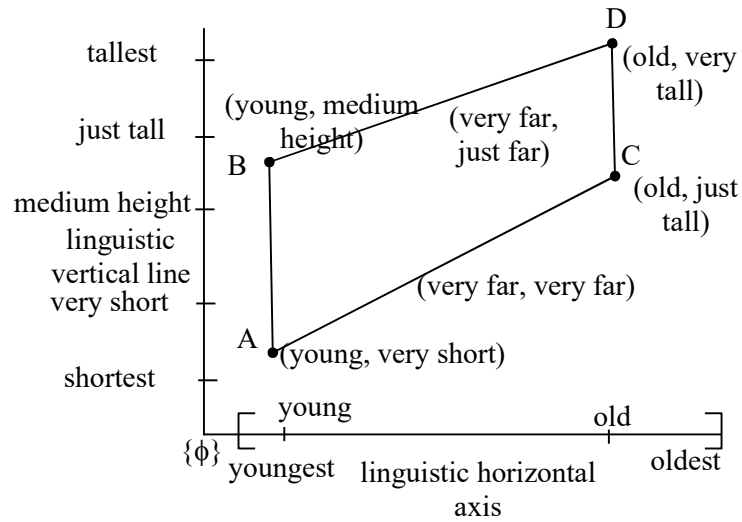

Figure 3.37

Clearly ABCD contributes to a quadrilateral. It is not a parallelogram as the linguistic distance of AB is not the same as the linguistic distance of CD.

Also AC and BD are not parallel for the linguistic distance AB and CD are not equal.

Next we consider four linguistic points related to the linguistic plane given in figure 3.37.

A(youngest, shortest), B(youth, medium height),

C(media age, just tall) and D(very old, tallest)

be the given four linguistic points.

Draw the linguistic graph of these four linguistic points in the linguistic plane as given in figure 3.38. The linguistic graph is as follows.

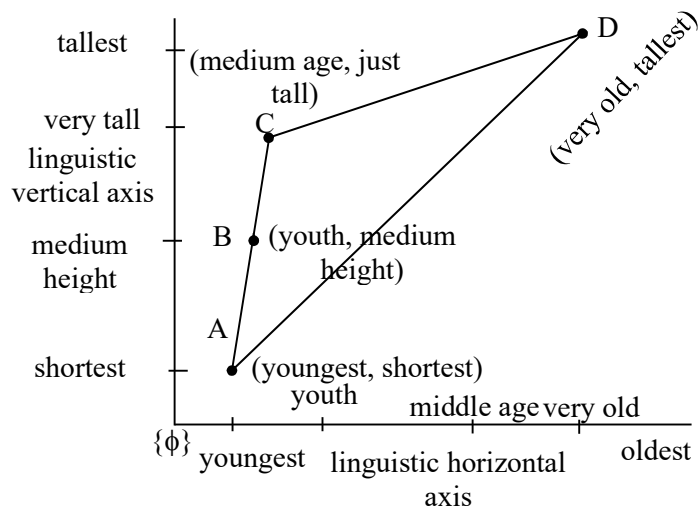

Figure 3.38

We see the linguistic graph is a linguistic triangle.

Now we just for the sake of completeness give a linguistic graph with six linguistic points given by

A(youngest, shortest), B(youth, medium height),

C(youth, tall), D(medium age, short),

E(medium age, very tall) and F(old, just tall)

given in the linguistic plane given in Figure 3.38.

We give the linguistic graph of these 6 linguistic points by the following figure 3.39.

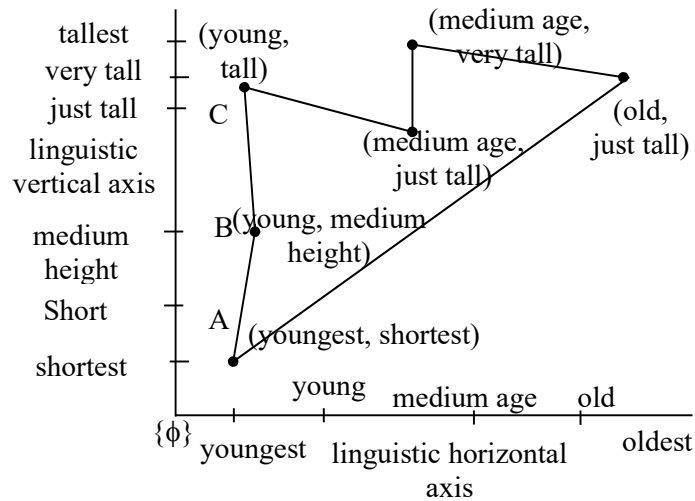

Figure 3.39

This is a linguistic polygon with 6 edges given by the above figure shows it is a very irregular linguistic polygon.

Next we proceed onto discuss about linguistic continuous maps. For us to have a linguistic continuous map we basically need both the linguistic domains space and the linguistic range space must be linguistic continuums then only the resulting linguistic curves will be a continuous one.

Even if one of the linguistic domain or the linguistic range is not a continuous continuum then the linguistic graph of the linguistic function cannot be continuous linguistic curve.

We have provided several examples of them.

We see that if a linguistic finite set is taken for some linguistic variable for the linguistic graph to exist we must have

the linguistic finite set must be a proper subset of the linguistic continuum. That is the finite linguistic set is also a totally ordered one.

This is the basic criteria for one to have the linguistic graph. For in the classical real plane we see the points which forms a curve must be a proper subset of the reals. Unordered subset or set cannot contribute to graphs in general. So is the case of linguistic graphs, for linguistic graphs also to exist based on a finite set, that linguistic finite set S should be a subset of a linguistic continuum, that is, $S \subseteq [a, b]$ a is the least linguistic element of the linguistic continuum and b ; the greatest element of the linguistic continuum $[a, b]$.

In the following we supply a series of problems for the reader by solving these problems it will make the reader equip himself / herself with fundamentals of linguistic graphs and linguistic maps.

We supply a few problems for the reader to familiarize this new concept. Further * problems are difficult for solving for a general reader.

PROBLEMS

1. Give 3 examples of linguistic variables which is associated with linguistic sets which are linguistic continuums.
2. Give 3 examples of linguistic variables which is associated with linguistic sets which are not linguistic continuums.

3. Can we say the linguistic sets given in problem 1 are totally orderable?
4. Can we say all linguistic sets associated with linguistic variables are totally ordered sets?
5. Give an example of a linguistic variable that has a linguistic set which is not orderable?
6. Suppose one expert observes a large number of mango fruits depending on size, colour and sweetness and takes them as a linguistic variable.
 - i) Find the linguistic set S associated with it.
 - ii) Is it a linguistic continuum?
 - iii) Is S a totally ordered set?
 - iv) Is S finite or infinite?
 - v) Obtain any other special feature associated with this linguistic variable?
 - vi) How is this linguistic variable different from the linguistic variable studying the height of people?
 - vii) Suppose the linguistic variable is the colour of the eyes of multinationals; compare it with the linguistic variable of mango fruits discussed.
 - viii) How is this linguistic variable different from the performance aspects of students in the classroom?

7. Is there any condition for the linguistic graph to exist one should have the linguistic variables on the linguistic vertical and linguistic horizontal axis to be linguistic continuums?
8. Can we say if we have a linguistic plane even arbitrary finite linguistic set with the relevance to the linguistic plane can be given representation in this ling plane? Give one example of such graph.
9. For the given linguistic variable performance aspects of the workers in an industry and the production of that industry. Taking performances as the linguistic horizontal axis and production as the linguistic vertical axis from the linguistic plane.
 - i) On this linguistic plane draw the linguistic graph given by
 $f: \{\text{performance}\} \rightarrow \text{production}$. (define as per the wishes of the reader).
 - ii) Is this a continuous linguistic graph?
 - iii) Can we say this linguistic graph is an increasing one?
 - iv) Can we say this linguistic graph is a decreasing one? Justify this in the case of linguistic function f you have defined.
 - v) Can we say depending on the experts opinion the linguistic function f can be defined?

10. Define a linguistic function f for two finite linguistic subsets

$$S_1 \subseteq [\text{worst, best}] \text{ and}$$

$$S_2 = [\text{most unsatisfactory, very satisfactory}]$$

where S_1 is related with the growth of a paddy plants and S_2 corresponds to the yield of these paddy plants.

- a) Will the linguistic graph of the linguistic function;

$f: S_1 \rightarrow S_2$ be a continuous curve? Justify your claim.

- b) Suppose $P_1 = [\text{very bad, just good}] \cup [\text{very good, best}] \subseteq [\text{worst, best}]$ and

$$P_2 = [\text{very unsatisfactory, just satisfactory}] \cup \{\text{satisfactory}\} \subseteq [\text{most unsatisfactory, very satisfactory}]$$

be linguistic subintervals / subsets of the linguistic continuum.

Will the linguistic graph of the linguistic map

$$\eta: P_1 \rightarrow P_2$$

be a continuum one?

Justify your claim and give the figure of the linguistic graph.

- c) Let $T_1 = [\text{very bad, good}] \subseteq [\text{worst, best}]$ and
 $T_2 = [\text{unsatisfactory, satisfactory}]$
 $\subseteq [\text{most unsatisfactory, very satisfactory}]$

be two linguistic subintervals.

Let $\delta : [\text{very bad, good}] \rightarrow [\text{unsatisfactory, satisfactory}]$

- i) Is δ a continuous linguistic function?
 ii) Will δ yield a continuous linguistic graph?
 Justify your claim.

- iii) If $[\text{unsatisfactory, satisfactory}]$
 $\subseteq [\text{most unsatisfactory, very satisfactory}]$

is replaced by the linguistic sub set.

$W_2 = \{\text{just satisfactory, unsatisfactory, very satisfactory}\}$

$\subseteq [\text{most unsatisfactory, very satisfactory}]$

define a linguistic function / map from

$\gamma : [\text{very bad, good}] \rightarrow W_2$

- iv) Will γ be a continuous linguistic map?
 v) Can γ yield a continuous linguistic graph? Justify your claim.

d) Let $W_1 = \{\text{very bad, bad, just bad, good, very good}\} \subseteq [\text{worst, best}]$

be the finite linguistic subset of the linguistic continuum $[\text{worst, best}]$ and let the linguistic range space be as before

$[\text{most unsatisfactory, very satisfactory}]$.

Let $w: W_1 \rightarrow [\text{most unsatisfactory, very satisfactory}]$

be a linguistic map.

- i) Is the linguistic map w a continuous one?
- ii) Is the linguistic graph of w a continuous one? Justify your claim!

11. Give an example of a linguistic map η which is decreasing only.

- a) Can this η be a linguistic graph which is increasing? Justify your claim!

12. Give an example of a linguistic map δ which is an increasing linguistic function / map.

- i) Can this linguistic functioning give way to a linguistic graph which is decreasing? Justify your claim.

13. Give an example of a linguistic function η which is neither increasing nor decreasing.

- i) Can we say η is a linguistic constant function?
- ii) Will the linguistic graph of η be a linguistic constant graph? Justify!

14. Give an example of a linguistic map / function which is both increasing and decreasing.
15. Give an example of a linguistic function/map which is both increasing and constant continuous linguistic function.
16. Give an example of a linguistic continuous function which is increasing, decreasing and is constant.
17. Give an example of a linguistic function η on a linguistic plane which is not continuous.
18. Construct a linguistic function

$$\delta: [\text{worst, best}] \rightarrow [\text{worst, best}]$$

such that δ yields a continuous linguistic graph.

Can there be a linguistic function

$$\alpha: [\text{worst, best}] \rightarrow [\text{worst, best}]$$

which does not yield a continuous linguistic graph?

19. Obtain any other special features enjoyed by linguistic continuous functions defined on linguistic planes.
20. Obtain some special features that can be associated with discontinuous linguistic functions.

21. Can every linguistic set associated with a linguistic variable contribute a linguistic continuous graph?

Justify your claim.

22. What are the essential features for a linguistic plane to exist?

23. What are the main properties of the linguistic set to contribute to a linguistic continuous increasing graph?
Justify your claim!

24. Suppose the linguistic variable is the colour of the eyes of different nationalities.

- a) Can this linguistic variable result in a linguistic set which is a linguistic continuum?

Justify your claim.

- b) Can this linguistic set be associated with a linguistic plane? Justify your claim!

- c) Can this linguistic variable be given a linguistic graphical structure? Justify your claim!

- d) Can a discrete set of linguistic variable be mapped as a continuous linguistic function?

- e) Can these problems be related to the several linguistic planes depending on the different linguistic variables?

- 25*. Can we use linguistic variable indeterminate to describe the colour of eyes of different nationalities? Substantiate your plane.
- 26*. Can a linguistic plane be appropriately constructed using the linguistic variable indeterminate. What are the drawback?
- 27*. Illustrate any linguistic continuous function using the linguistic variable indeterminate.

FURTHER READING

1. Broumi S, Ye J, Smarandache F. An extended TOPSIS method for multiple attribute decision making based on interval neutrosophic uncertain linguistic variables. *Infinite Study*; 2015 Jul 1.
2. Dat LQ, Thong NT, Ali M, Smarandache F, Abdel-Basset M, Long HV. Linguistic approaches to interval complex neutrosophic sets in decision making. *IEEE access*. 2019 Mar 4;7:38902-17.
3. Fan C, Feng S, Hu K. Linguistic neutrosophic numbers einstein operator and its application in decision making. *Mathematics*. 2019 Apr 28;7(5):389.
4. Fan C, Ye J, Hu K, Fan E. Bonferroni mean operators of linguistic neutrosophic numbers and their multiple attribute group decision-making methods. *Information*. 2017 Sep 1;8(3):107.
5. Fang Z, Ye J. Multiple attribute group decision-making method based on linguistic neutrosophic numbers. *Symmetry*. 2017 Jul 7;9(7):111.
6. Herstein., I.N., *Topics in Algebra*, Wiley Eastern Limited, (1975).
7. Kamacı H. Linguistic single-valued neutrosophic soft sets with applications in game theory. *International Journal of Intelligent Systems*. 2021 Aug;36(8):3917-60.

8. Kandasamy WV, Ilanthenral K, Smarandache F. Algebraic Structures on MOD Planes. Infinite Study; 2015.
9. Lang, S., Algebra, Addison Wesley, (1967).
10. Li YY, Zhang H, Wang JQ. Linguistic neutrosophic sets and their application in multicriteria decision-making problems. *International Journal for Uncertainty Quantification*. 2017;7(2).
11. Meyer A, Zimmermann HJ. Applications of fuzzy technology in business intelligence. *International Journal of Computers Communications & Control*. 2011 Sep 1;6(3):428-41.
12. Peng X, Dai J, Smarandache F. Research on the assessment of project-driven immersion teaching in extreme programming with neutrosophic linguistic information. *International Journal of Machine Learning and Cybernetics*. 2022 Oct 10:1-6.
13. Peng, X., Dai, J. & Smarandache, F. Research on the assessment of project-driven immersion teaching in extreme programming with neutrosophic linguistic information. *Int. J. Mach. Learn. & Cyber.* (2022). <https://doi.org/10.1007/s13042-022-01669-6>.
14. Smarandache F, Broumi S, Singh PK, Liu CF, Rao VV, Yang HL, Patrascu I, Elhassouny A. Introduction to neutrosophy and neutrosophic environment. In *Neutrosophic Set in Medical Image Analysis 2019* Jan 1 (pp. 3-29). Academic Press.
15. Smarandache F. Linguistic paradoxes and tautologies. *Collect. Pap. Vol. III*. 2000;3:122.
16. Smarandache, Florentin, Neutrosophic Logic—Generalization of the Intuitionistic Fuzzy Logic, Special Session on Intuitionistic Fuzzy Sets and Related Concepts, International EUSFLAT Conference, Zittau, Germany, 10-12 September 2003.
17. Tian ZP, Wang J, Zhang HY, Chen XH, Wang JQ. Simplified neutrosophic linguistic normalized weighted Bonferroni mean operator and its application to multi-criteria decision-making problems. *Filomat*. 2016 Jan 1;30(12):3339-60.

18. Vasantha Kandasamy WB, Smarandache F, Amal K. Fuzzy Linguistic Topological Spaces. arXiv e-prints. 2012 Mar:arXiv-1203.
19. Vasantha Kandasamy, W.B., Ilanthenral, K., and Smarandache, F., MOD planes, EuropaNova, (2015).
20. Vasantha Kandasamy, W.B., Ilanthenral, K., and Smarandache, F., MOD Functions, EuropaNova, (2015).
21. Vasantha Kandasamy, W.B., Ilanthenral, K., and Smarandache, F., Multidimensional MOD planes, EuropaNova, (2015).
22. Vasantha Kandasamy, W.B., Ilanthenral, K., and Smarandache, F., Natural Neutrosophic numbers and MOD Neutrosophic numbers, EuropaNova, (2015).
23. Ye J. Some aggregation operators of interval neutrosophic linguistic numbers for multiple attribute decision making. *Journal of Intelligent & Fuzzy Systems*. 2014 Jan 1;27(5):2231-41.
24. Zadeh LA. The concept of a linguistic variable and its application to approximate reasoning—I. *Information sciences*. 1975 Jan 1;8(3):199-249.
25. Zadeh LA. The concept of a linguistic variable and its application to approximate reasoning—II. *Information sciences*. 1975 Jan 1;8(4):301-57.
26. Zadeh LA. The concept of a linguistic variable and its application to approximate reasoning-III. *Information sciences*. 1975 Jan 1;9(1):43-80.
27. Zimmermann HJ. Description and optimization of fuzzy systems. *International journal of general System*. 1975 Jan 1;2(1):209-15.
28. Zimmermann HJ. Fuzzy set theory. *Wiley interdisciplinary reviews: computational statistics*. 2010 May;2(3):317-32.
29. Zimmermann HJ. Fuzzy set theory—and its applications. *Springer Science & Business Media*; 2011 Jun 27.

INDEX

A

Analytical linguistic geometry, 110 - 119

B

Bijjective function, 19 – 27

Bijjective Semilinguistic function / map29 - 40

Bolzano - Weirstrass Theorem for linguistic

C

Classical Map or Functions, 19 - 27

Closed linguistic interval, 71 - 80

Collinear linguistic points, 150 - 155

Commutative linguistic monoid, 70 - 75

Complement of a linguistic set, 62 - 74

Constant linguistic function, 126 - 136

Continuous linguistic function, 120 - 125

Continuum, 84 - 97

D

Decreasing linguistic function, 126 - 136

Dedekind completeness property, 74 - 83

Dedekind linguistic property, 74 - 83

Discontinuous linguistic function, 135 - 140

E

Equivalent linguistic sets, 70 - 76
Extension of linguistic function, 65 - 74

F

Fuzzy linguistic values, 9-10
Fuzzy membership, 8 - 9

H

Half-closed linguistic interval 71 - 80
Half-open linguistic interval 71 - 80
Horizontal Linguistic axis, 107 - 129

I

Identity linguistic function, 68 - 75
Increasing linguistic function, 126 - 130
Injective function, 19 - 27
Interior of linguistic set, 82 - 95

L

Linguistic accumulation points, 84 - 97
Linguistic adherent point, 86 - 98
Linguistic approximations, 8 - 9
Linguistic bounded, 92 - 99
Linguistic closure, 86 - 99
Linguistic cluster point, 83 - 97
Linguistic codomain, 62 - 74
Linguistic collinear points, 150 - 155
Linguistic commutative monoid, 70 - 75
Linguistic complement, 62 - 74

Linguistic completeness, 72 - 82
Linguistic condensation point, 83 - 97
Linguistic continuum, 9 - 12
Linguistic curve or graph, 120 - 125
Linguistic derived set, 92 - 98
Linguistic domain, 62 - 74
Linguistic empty word, 107 - 128
Linguistic geometry, 110 - 119
Linguistic hedge, 8 - 9
Linguistic horizontal axis, 107 - 125
Linguistic identity function, 68 - 75
Linguistic image, 62 - 74
Linguistic infimum, 72 - 82
Linguistic information, 8 - 9
Linguistic interior points, 80 - 94
Linguistic interval, 9 - 12, 69 - 75
Linguistic least upper bound, 72 - 80
Linguistic limit point, 83 - 97
Linguistic line, 110 - 113
Linguistic lower bound, 72 - 80
Linguistic map / function of type I, 43 - 53
Linguistic map / function of type II, 43 - 54
Linguistic map / function of type III, 43 - 54
Linguistic map / function of type IV, 43 - 54
Linguistic map / function, 18 - 25, 43 - 53
Linguistic membership, 9 - 12
Linguistic neighbourhood of a point, 78 - 91
Linguistic Neutrosophic Numbers (LNN), 9-10
Linguistic order completeness, 72 - 82
Linguistic ordered pair, 110 - 119
Linguistic partially ordered set, 14 - 18
Linguistic perfect set, 92 - 97
Linguistic plane, 7, 106 - 128
Linguistic planes, 7
Linguistic polygon, 156 - 159
Linguistic power set of a linguistic set, 15 - 20

Linguistic preimage, 62 - 74
 Linguistic quadrilateral, 145 - 150
 Linguistic semifield, 70 - 75
 Linguistic sets, 7
 Linguistic state, 8 - 9
 Linguistic straight line, 76 – 93, 110 - 112
 Linguistic sub continuum, 86 - 97
 Linguistic subsets, 62 - 74
 Linguistic supersets, 62 - 75
 Linguistic supremum, 72 - 80
 Linguistic totally ordered set, 14 - 18
 Linguistic trajectory, 8 - 9
 Linguistic triangle, 112 - 115
 Linguistic universal set, 62 - 74
 Linguistic variables, 7
 Linguistic vertical axis, 107 - 128
 Linguistically equivalent linguistic sets, 70 – 76
 Linguistically totally orderable, 69 - 75

M

Mod planes, 7 - 8

N

Neutrosophic Linguistics, 9-10
 Non decreasing linguistic function, 139 - 143
 Non increasing linguistic function, 139 - 143
 Noncollinear linguistic points, 153 - 158

O

One to one semilinguistic map / function, 29 - 41
 Open linguistic interval, 71 - 80

P

Partially ordered linguistic set, 14 - 18
Partially ordered, 9 - 12

R

Restriction of linguistic function, 65 - 74

S

Semi open linguistic interval, 71 - 80
Semiclosed linguistic interval, 71 - 80
Semilinguistic bijective function / map, 29 - 40
Semilinguistic function / map of type III, 36 - 49
Semilinguistic function / map of type IV, 36 - 49
Semilinguistic function / map, 29 - 40
Semilinguistic functions that are not classical, 33 - 42
Semilinguistic map / function of type I, 35 - 49
Semilinguistic map / function of type II, 35 - 49
Semilinguistic one to one map / function, 29 - 41
Simplified Neutrosophic Linguistic sets (SNLS), 10
Special linguistic functions, 44 – 50

T

Totally ordered linguistic set, 14 – 18, 69 - 75
Totally ordered, 9 - 12

U

Universal linguistic set, 62 - 74
Unordered set, 9 - 12

V

Vertical linguistic axis, 107 - 129

ABOUT THE AUTHORS

Dr.W.B.Vasantha Kandasamy is a Professor in the School of Computer Science and Engg, VIT University, India. In the past decade she has guided 13 Ph.D. scholars in the different fields of non-associative algebras, algebraic coding theory, transportation theory, fuzzy groups, and applications of fuzzy theory of the problems faced in chemical industries and cement industries. She has to her credit 694 research papers. She has guided over 100 M.Sc. and M.Tech. projects. She has worked in collaboration projects with the Indian Space Research Organization and with the Tamil Nadu State AIDS Control Society. She is presently working on a research project funded by the Board of Research in Nuclear Sciences, Government of India. This is her 132nd book. On India's 60th Independence Day, Dr.Vasantha was conferred the Kalpana Chawla Award for Courage and Daring Enterprise by the State Government of Tamil Nadu in recognition of her sustained fight for social justice in the Indian Institute of Technology (IIT) Madras and for her contribution to mathematics. The award, instituted in the memory of Indian-American astronaut Kalpana Chawla who died aboard Space Shuttle Columbia, carried a cash prize of five lakh rupees (the highest prize-money for any Indian award) and a gold medal.

She can be contacted at vasanthakandasamy@gmail.com

Web Site: <http://www.wbvasantha.in>

Dr. K. Ilanthenral is Assistant Professor in the School of Computer Science and Engg, VIT University, India. She can be contacted at ilanthenral@gmail.com

Dr. Florentin Smarandache is a professor of mathematics at the University of New Mexico, USA. He got his MSc in Mathematics and Computer Science from the University of Craiova, Romania, PhD in Mathematics from the State University of Kishinev, and Postdoctoral in Applied Mathematics from Okayama University of Sciences, Japan. He is the founder of neutrosophy (generalization of dialectics), neutrosophic set, logic, probability and statistics since 1995 and has published hundreds of papers on neutrosophic physics, superluminal and instantaneous physics, unmatter, quantum paradoxes, absolute theory of relativity, redshift and blueshift due to the medium gradient and refraction index besides the Doppler effect, paradoxism, outerart, neutrosophy as a new branch of philosophy, Law of Included Multiple-Middle, multispace and multistructure, degree of dependence and independence between neutrosophic components, refined neutrosophic set, neutrosophic over-under-offset, plithogenic set, neutrosophic triplet and duplet structures, quadruple neutrosophic structures, DSMT and so on to many peerreviewed international journals and many books and he presented papers and plenary lectures to many international conferences around the world.

<http://fs.unm.edu/FlorentinSmarandache.htm>

He can be contacted at smarand@unm.edu