

Neutrosophic Operational Research

Volume II

Editors:

Prof. Florentin Smarandache

Dr. Mohamed Abdel-Basset

Dr. Victor Chang



NEUTROSOPHIC OPERATIONAL RESEARCH

Volume II

Editors:

Prof. Florentin Smarandache

Dr. Mohamed Abdel-Basset

Dr. Victor Chang

Dedication

Dedicated with love to our parents for the developments of our cognitive minds, ethical standards, and shared do-good values & to our beloved families for the continuous encouragement, love, and support.

Acknowledgment

The book would not have been possible without the support of many people: first, the editors would like to express their appreciation to the advisory board; second, we are very grateful to the contributors; and third, the reviewers for their tremendous time, effort, and service to critically review the various chapters. The help of top leaders of public and private organizations, who inspired, encouraged, and supported the development of this book.

Peer Reviewers

Prof. Madad Khan

Department of Mathematics, COMSATS Institute of Information Technology
Abbottabad, Pakistan.

Prof. Young Bae Jun

Department of Mathematics Education, Gyeongsang National University
Jinju 52828, S. Korea.

Prof. Seok-Zun Song

Department of Mathematics, Jeju National University
Jeju 63243, S. Korea.

Dr. Xiaohong Zhang

Department of Mathematics, Shaanxi University of Science &
Technology, Xi'an, 710021, P. R. China;
or Department of Mathematics, Shanghai Maritime University, Shanghai,
201306, P. R. China.

Dr. Xinliang Liang

Department of Mathematics, Shaanxi University of Science
& Technology, Xi'an, 710021, P. R. China.

Neutrosophic Operational Research

Volume II

Foreword by John R. Edwards

Preface by the editors

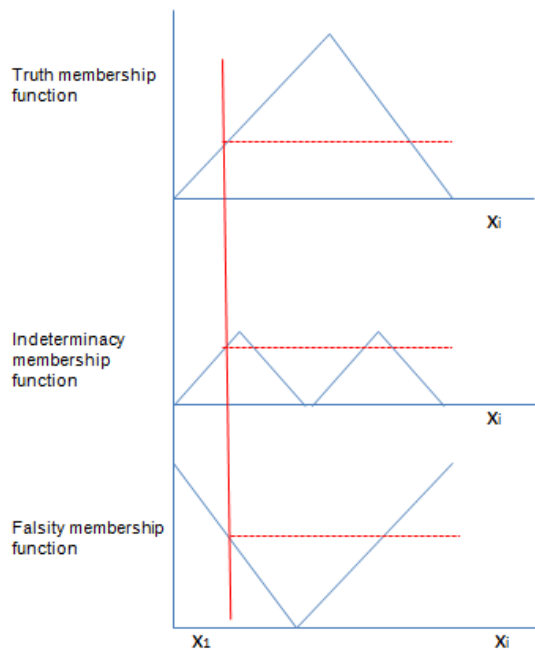

Pons
Brussels, 2017

Editors:

Prof. Florentin Smarandache, PhD, Postdoc

Mathematics & Science Department

University of New Mexico, USA

Dr. Mohamed Abdel-Basset

Operations Research Dept.

Faculty of Computers and Informatics

Zagazig University, Egypt

Dr. Victor Chang

Xi'an Jiaotong-Liverpool University

Suzhou, China

Pons Publishing House / Pons asbl

Quai du Batelage, 5

1000 - Bruxelles

Belgium

DTP: George Lukacs

ISBN 978-1-59973-537-5

Table of Contents

Foreword.....	7
Preface	9
I Application of Neutrosophic Optimization Technique on Multi-objective Reliability Optimization Model.....	13
Sahidul Islam, Tanmay Kundu	
II Teacher Selection Strategy Based on Bidirectional Projection Measure in Neutrosophic Number Environment.....	29
Surapati Pramanik, Rumi Roy, Tapan Kumar Roy	
III A New Concept of Matrix Algorithm for MST in Undirected Interval Valued Neutrosophic Graph.....	54
Said Broumi, Assia Bakali, Mohamed Talea, Florentin Smarandache, Kishore Kumar P K	
IV Optimization of Welded Beam Structure using Neutrosophic Optimization Technique: A Comparative Study	71
Mridula Sarkar, Tapan Kumar Roy	
V Multi-Objective Neutrosophic Optimization Technique and Its Application to Riser Design Problem.....	101
Mridula Sarkar, Pintu Das, Tapan Kumar Roy	
VI Truss Design Optimization using Neutrosophic Optimization Technique	113
Mridula Sarkar, Tapan Kumar Roy	
VII Multi-objective Neutrosophic Optimization Technique and its Application to Structural Design	133
Mridula Sarkar, Tapan Kumar Roy	

Editors: *Prof. Florentin Smarandache*
Dr. Mohamed Abdel-Basset
Dr. Victor Chang

VIII Multi-Objective Welded Beam Optimization using Neutrosophic Goal Programming Technique	153
Mridula Sarkar, Tapan Kumar Roy	
IX Neutrosophic Modules	181
Necati Olgun, Mikail Bal	
X Neutrosophic Triplet Inner Product	193
Mehmet Şahin, Abdullah Kargın	

Foreword

John R. Edwards

This book is an excellent exposition of the use of Data Envelopment Analysis (DEA) to generate data analytic insights to make evidence-based decisions, to improve productivity, and to manage cost-risk and benefit-opportunity in public and private sectors. The design and the content of the book make it an up-to-date and timely reference for professionals, academics, students, and employees, in particular those involved in strategic and operational decision-making processes to evaluate and prioritize alternatives to boost productivity growth, to optimize the efficiency of resource utilization, and to maximize the effectiveness of outputs and impacts to stakeholders. It is concerned with the alleviation of world changes, including changing demographics, accelerating globalization, rising environmental concerns, evolving societal relationships, growing ethical and governance concern, expanding the impact of technology; some of these changes have impacted negatively the economic growth of private firms, governments, communities, and the whole society.

Preface

Prof. Florentin Smarandache

Dr. Mohamed Abdel-Basset

Dr. Victor Chang

This book treats all kind of data in neutrosophic environment, with real-life applications, approaching topics as multi-objective programming, bidirectional projection method, decision-making, teacher selection, interval valued neutrosophic graph, score function, Minimum Spanning Tree (MST), single-objective welded beam optimization, multi-objective Riser design optimization, non-linear membership function, structural optimization, generalized neutrosophic goal programming, arithmetic aggregation, geometric aggregation, welded beam design optimization, neutrosophic group, neutrosophic ring, neutrosophic R-module, weak neutrosophic R-module, strong neutrosophic R-module, neutrosophic R-module homomorphism, neutrosophic triplet inner product, neutrosophic triplet metric spaces, neutrosophic triplet vector spaces, neutrosophic triplet normed spaces, and so on.

The first chapter (*Application of Neutrosophic Optimization Technique on Multi-objective Reliability Optimization Model*) proposes a multi-objective non-linear reliability optimization model taking system reliability and system cost as two objective functions. As a generalized version of fuzzy set and intuitionistic fuzzy set, neutrosophic set is a very useful tool to express uncertainty, impreciseness in more general way. Thus, here the authors Sahidul Islam and Tanmay Kundu have considered neutrosophic optimization technique with linear and non-linear membership function to solve a multi-objective reliability optimization model. This proposed method is an extension of fuzzy and intuitionistic fuzzy optimization technique in which the degree of acceptance, indeterminacy and rejection of objectives are simultaneously considered. To demonstrate the methodology and applicability of the proposed approach, numerical examples are presented and evaluated by comparing the result obtained by neutrosophic approach with the intuitionistic fuzzy optimization technique.

Teacher selection strategy is a multiple criteria decision-making process involving indeterminacy and vagueness, which can be represented by neutrosophic numbers of the form $a + bI$, where a represents determinate component and bI represents indeterminate component. The purpose of the

second chapter (*Teacher Selection Strategy Based on Bidirectional Projection Measure in Neutrosophic Number Environment*) is to develop a multiple criteria group decision-making model for teacher selection strategy based on bidirectional projection measure based method in neutrosophic number environment. Seven criteria obtained from expert opinions are considered for selection process. The criteria are, namely: demonstration, pedagogical knowledge, action research, emotional stability, knowledge on child psychology, social quality, and leadership quality. Weights of the decision makers are considered as equal. The bidirectional projection measure of neutrosophic numbers is a useful mathematical tool that can deal with decision-making problems with indeterminate information. Using the bidirectional projection measure, a new multi criteria decision-making strategy is proposed. Using bidirectional projection measures between each alternative and the ideal alternative, all the alternatives are preference-ranked to select the best one. Finally, teacher selection problem for secondary education is solved, example by authors Surapati Pramanik, Rumi Roy and Tapan Kumar Roy, demonstrating the applicability and effectiveness of the developed bidirectional projection strategy.

In the third chapter (*A New Concept of Matrix Algorithm for MST in Undirected Interval Valued Neutrosophic Graph*), Said Broumi, Assia Bakali, Mohamed Talea, Florentin Smarandache and Kishore Kumar P K introduce a new algorithm for finding a minimum spanning tree (MST) of an undirected neutrosophic weighted connected graph whose edge weights are represented by an interval valued neutrosophic number. In addition, the authors compute the cost of MST and compare the de-neutrosophied value with an equivalent MST having the deterministic weights. Finally, a numerical example is provided.

The fourth chapter (*Optimization of Welded Beam Structure using Neutrosophic Optimization Technique: A Comparative Study*) investigates Neutrosophic Optimization (NSO) approach to optimize the cost of welding of a welded steel beam, while the maximum shear stress in the weld group, maximum bending stress in the beam, maximum deflection at the tip and buckling load of the beam have been considered as flexible constraints. The problem of designing an optimal welded beam consists of dimensioning a welded steel beam and the welding length so as to minimize its cost, subject to the constraints as stated above. Specifically based on truth, indeterminacy and falsity membership function, a single objective NSO algorithm has been developed by authors Mridula Sarkar and Tapan Kumar Roy to optimize the welding cost, subjected to a set of flexible constraints. It is shown that NSO is an efficient method in finding out the optimum value in comparison to other iterative methods for nonlinear welded beam design in precise and imprecise environment. Numerical example is also given to demonstrate the efficiency of the proposed NSO approach.

The fifth chapter (*Multi-Objective Neutrosophic Optimization Technique and Its Application to Riser Design Problem*) aims to give computational algorithm to solve a multi-objective non-linear programming problem (MONLPP) using neutrosophic optimization method. The proposed method is for solving MONLPP with single valued neutrosophic data. A comparative study of optimal solution has been made between intuitionistic fuzzy and neutrosophic optimization technique. The developed algorithm has been illustrated by a numerical example. Finally, optimal riser design problem is presented by authors Mridula Sarkar, Pintu Das and Tapan Kumar Roy as an application of such technique.

Mridula Sarkar and Tapan Kumar Roy develop in the sixth chapter (*Truss Design Optimization using Neutrosophic Optimization Technique*) a neutrosophic optimization (NSO) approach for optimizing the design of plane truss structure with single objective subject to a specified set of constraints. In this optimum design formulation, the objective functions are the weight of the truss and the deflection of loaded joint; the design variables are the cross-sections of the truss members; the constraints are the stresses in members. A classical truss optimization example is presented to demonstrate the efficiency of the neutrosophic optimization approach. The test problem includes a two-bar planar truss subjected to a single load condition. This single-objective structural optimization model is solved by fuzzy and intuitionistic fuzzy optimization approach as well as neutrosophic optimization approach. Numerical example is given to illustrate our NSO approach. The result shows that the NSO approach is very efficient in finding the best discovered optimal solutions.

The seventh chapter, called *Multi-objective Neutrosophic Optimization Technique and its Application to Structural Design*, is authored also by Mridula Sarkar and Tapan Kumar Roy, who develop a multi-objective non-linear neutrosophic optimization (NSO) approach for optimizing the design of plane truss structure with multiple objectives subject to a specified set of constraints. In this optimum design formulation, the objective functions are the weight of the truss and the deflection of loaded joint; the design variables are the cross-sections of the truss members; the constraints are the stresses in members. A classical truss optimization example is presented to demonstrate the efficiency of the neutrosophic optimization approach. The test problem includes a three-bar planar truss subjected to a single load condition. This multi-objective structural optimization model is solved by neutrosophic optimization approach. With linear and non-linear membership function.

The eight chapter (*Multi-Objective Welded Beam Optimization using Neutrosophic Goal Programming Technique*) investigates multi-objective

Neutrosophic Goal Optimization (NSGO) approach to optimize the cost of welding and deflection at the tip of a welded steel beam, while the maximum shear stress in the weld group, maximum bending stress in the beam, and buckling load of the beam have been considered as constraints. The problem of designing an optimal welded beam consists of dimensioning a welded steel beam and the welding length so as to minimize its cost, subject to the constraints as stated above. The classical welded beam design structure is presented to demonstrate the efficiency of the neutrosophic goal programming approach. The model is numerically illustrated by generalized NSGO technique with different aggregation method. The result shows that the Neutrosophic Goal Optimization technique is very efficient in finding the best optimal solutions.

The ninth chapter (*Neutrosophic Modules*) attempts to study the neutrosophic modules and neutrosophic submodules. Neutrosophic logic is an extension of the fuzzy logic in which indeterminacy is included. Neutrosophic Sets are a significant tool of describing the incompleteness, indeterminacy, and inconsistency of the decision-making information. Modules are one of fundamental and rich algebraic structure with respect to some binary operation in the study of algebra. In this chapter, the authors Necati Olgun and Mikail Bal study some basic definition of neutrosophic R-modules, and neutrosophic submodules in algebra are generalized. Some properties of neutrosophic R-modules and neutrosophic submodules are presented. The authors use classical modules and neutrosophic rings. Consequently, they introduce neutrosophic R-modules, which is completely different from the classical module in the structural properties. Also, neutrosophic quotient modules and neutrosophic R-module homomorphism are explained, and some definitions and theorems are given. Finally, some useful examples are given to verify the validity of the proposed definitions and results.

In the tenth and last chapter (Neutrosophic Triplet Inner Product), a notion of neutrosophic triplet inner product is given and properties of neutrosophic triplet inner product spaces are studied. The neutrosophic triplets and neutrosophic triplet structures were introduced by Smarandache and Ali in 2014-2016. Furthermore, the authors Mehmet Şahin and Abdullah Kargin also show that this neutrosophic triplet notion is different from the classical notion.

I

Application of Neutrosophic Optimization Technique on Multi-objective Reliability Optimization Model

Sahidul Islam¹ • Tanmay Kundu^{2*}

^{1,2}Department of Mathematics, University of Kalyani, Kalyani, 741235, West Bengal, India.
^{*} Corresponding author. E-mail: tanmaykundu.math@gmail.com

Abstract

In this paper, we propose a multi-objective non-linear reliability optimization model taking system reliability and system cost as two objective functions. As a generalized version of fuzzy set and intuitionistic fuzzy set, neutrosophic set is a very useful tool to express uncertainty, impreciseness in more general way. Thus, here we have considered neutrosophic optimization technique with linear and non-linear membership function to solve this multi-objective reliability optimization model. This proposed method is an extension of fuzzy and intuitionistic fuzzy optimization technique in which the degree of acceptance, indeterminacy and rejection of objectives are simultaneously considered. To demonstrate the methodology and applicability of the proposed approach, numerical examples are presented and evaluated by comparing the result obtained by neutrosophic approach with the intuitionistic fuzzy optimization technique at the end of the paper.

Keywords

Reliability, Multi-objective programming, Neutrosophic set, Neutrosophic optimization.

1 Introduction

In 1965, Zadeh [1] first introduced the concept of fuzzy set. The fuzzy set theory which considers the degree of membership of elements, is a very effective tool to measure uncertainty in real life situation. In recent time, the fuzzy set

theory has been widely developed and generalized form have appeared. Intuitionistic fuzzy set (IFS) theory is one of the generalized versions of fuzzy set theory. In 1986, Atanassov [2] extended the concept of fuzzy set and introduced intuitionistic fuzzy set theory, which consider not only the degree of membership but also the degree of non-membership function such that the sum of both values is less than one.

As a generalization of fuzzy set theory [12], intuitionistic fuzzy set theory [11], interval valued fuzzy sets [9] etc. , neutrosophic sets (NSs) was first introduced by Smarandache in 1995 [3] . In real world situations we often encounter with incomplete, indeterminate and inconsistent information, neutrosophic set is a powerful mathematical tool to deal with them. Neutrosophic sets which is characterized by a truth membership function , an indeterminacy membership function and a falsity membership function , contains both the real standard and non-standard intervals and thus it is very difficult to apply NSs in practical field such as real scientific and engineering applications. In order to use NSs in real life application, Wang et al. [4] proposed single valued neutrosophic sets (SVNSs) and also introduced the concept of interval valued neutrosophic sets (IVNS) [5], which is more realistic , precise and flexible than SVNSs.

Reliability engineering is one of the important tasks in designing and development of a technical system. The primary goal of the reliability engineer has been always to find the best way to increase system reliability. The diversity of system resources, resource constraints and options for reliability improvement lead to the construction and analysis of several optimization models. In daily life, due to some uncertainty in judgements of the decision maker (DM), there are some coefficients and parameters in the optimization model, which are always imprecise with vague in nature. In order to handle such type of nature in multi-objective optimization model, fuzzy approach is use to evaluate this. Park [6] first applied fuzzy optimization techniques to the problem of reliability apportionment for a series system. Ravi et al. [7] used fuzzy global optimization reliability model. Huang [8] presented a multi objective fuzzy optimization method to reliability optimization problem. Later, intuitionistic fuzzy optimization method is also applied to various field of research work. Sharma [10] proposed a method to analyse the network system reliability which is based on intuitionistic fuzzy set theory. Jana and Roy [13] described intuitionistic fuzzy linear programming method in transportation problems. Also, Mahapatra [14] introduced intuitionistic fuzzy multi objective mathematical programming on reliability optimization model.

Nowadays neutrosophic optimization technique is an open field of research work. Roy [15] applied neutrosophic linear programming approach to multi

objective production planning problem. Pranmanik [16] discussed the framework of neutrosophic multi objective linear programming problem. Baset et al. [17,22-30] introduced goal programming in neutrosophic environment.

In this paper we have introduced a fuzzy multi-objective reliability optimization model in which system reliability and cost of the system are considered as two objective functions. This is very first when neutrosophic optimization technique is applied on multi-objective non-linear reliability optimization model. The motivation of the present study is to give a computational procedure for solving multi-objective reliability optimization model by neutrosophic optimization approach to find the optimal solution which maximize the system reliability and minimize the cost of the system. Also as an application of the proposed optimization technique to a reliability model of LCD, display unit is presented. The results of the proposed approach are evaluated by comparing with intuitionistic fuzzy optimization (IFO) technique at the end of the paper.

2 Mathematical model

Let R_j be the reliability of the j th component of a system and $R_S(R)$ represents the system reliability. Let $C_S(R)$ denote the cost of the system. Here we consider a complex system, which includes a five-stage combination reliability model.

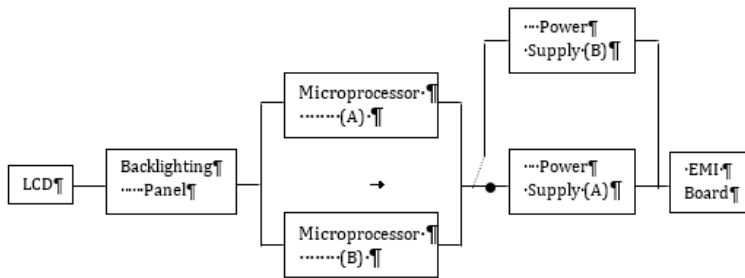

Fig 1: Reliability model of a LCD display unit.

2.1. Reliability model of a LCD display unit

Now we are interested to find out the system reliability of a LCD display unit [21] which consists of several component connected to one another. This complex system mainly consists five stages $L_i, (i = 1, 2, \dots, 5)$, which are in series. Thus, the generalized formula for the system reliability of the proposed model is given by

$$R_S(R) = L_1 \times L_2 \times L_3 \times L_4 \times L_5 = \prod_{j=1}^5 L_j \quad (2.1.1)$$

where

L_1 : LCD panel with reliability R_1 ,

i.e. $L_1 = R_1$;

L_2 : A backlighting board with 10 bulbs with individual bulb reliability R_2 such that the board functions with at most one bulb failure,

i.e. $L_2 = R_2^{10} + 10R_2^9(1 - R_2)$;

L_3 : Two Microprocessor boards A and B hooked up in parallel, each with reliability R_3 ,

i.e. $L_3 = 1 - (1 - R_3)^2$;

L_4 : Dual power supplies in standby redundancy, each power supply with reliability R_4 ,

i.e. $L_4 = R_4 + R_4 \ln(1/R_4)$;

L_5 : EMI board with reliability R_5 hooked in series with common input of the power supply A,

i.e. $L_5 = R_5$;

Thus we have the following system reliability

$$R_S(R) = R_1 \left(R_2^{10} + 10R_2^9(1 - R_2) \right) \left(1 - (1 - R_3)^2 \right) \left(R_4 + R_4 \ln(1/R_4) \right) R_5 \quad (2.1.1)$$

2.2. Multi-objective Reliability Optimization Model

Here we consider cost of the proposed complex system as an additional objective function. Now system reliability has to be maximized and cost of the system is to be minimized subject to system space as target goal. Thus, the model becomes –

$$\begin{aligned} \text{Max } R_S(R) &= R_1 \left(R_2^{10} + 10R_2^9(1 - R_2) \right) \left(1 - (1 - R_3)^2 \right) \\ &\quad \left(R_4 + R_4 \ln(1/R_4) \right) R_5 \\ \text{Min } C_S(R) &= \sum_{j=1}^5 c_j \left[\tan\left(\frac{\pi}{2}\right) R_j \right]^{\alpha_j} \\ \text{s.t. } V_S(R) &= \sum_{j=1}^5 v_j R_j^{\alpha_j} \leq V_{lim} \\ 0.5 &\leq R_{j,min} \leq R_j \leq 1, 0 \leq R_S \leq 1; j = 1, 2, \dots, 5 \end{aligned} \quad (2.2.1)$$

where v_j and c_j represent the space and cost of the j -th component of the system respectively. V_{lim} is the system space limitation and $R_{j,min}$ is the lower bound of the reliability of each component j .

Now for simplicity of calculation and to convert the above problem to one type maximization problem, we consider $-C_S'(R) = -C_S(R)$.

Thus the model (2.2.1) have the following form

$$\text{Max } R_S(R) \quad \text{Max } C_S'(R) \quad (2.2.2)$$

subject to the same constraints defined in (2.2.1).

3 Preliminaries

Definition 3.1. (Fuzzy Set)

A fuzzy set \tilde{A} in X is a set of ordered pairs

$$\tilde{A} = \{(x, \mu_{\tilde{A}}(x)) \mid x \in X\},$$

where X is a collection of objects denoted generically by x and $\mu_{\tilde{A}}(x): X \rightarrow [0,1]$ is called the membership function or grade of membership of x in \tilde{A} .

Definition 3.2. (Intuitionistic fuzzy set)

An intuitionistic fuzzy set (IFS) \tilde{A}^i in X , where X is the universe of discourse, is defined as an object of the following form

$$\tilde{A}^i = \{ \langle x, \mu_{\tilde{A}^i}(x), \nu_{\tilde{A}^i}(x) \rangle \mid x \in X \},$$

where $\mu_{\tilde{A}^i}(x): X \rightarrow [0,1]$ and $\nu_{\tilde{A}^i}(x): X \rightarrow [0,1]$ defined the degree of membership and the degree of non-membership of the element $x \in X$ respectively and for every $x \in X$, $0 \leq \mu_{\tilde{A}^i}(x) + \nu_{\tilde{A}^i}(x) \leq 1$.

Now for each element $x \in X$, the value of $\pi_{\tilde{A}^i}(x) = 1 - \mu_{\tilde{A}^i}(x) - \nu_{\tilde{A}^i}(x)$ is called the degree of uncertainty of the element $x \in X$ to the intuitionistic fuzzy set \tilde{A}^i .

Definition 3.3. (Neutrosophic set) [18]

Let X be a space of points with a generic element in X denoted by x . A neutrosophic set (NS) \tilde{A}^N in X is characterized by a truth membership function $\mu_A(x)$, an indeterminacy membership function $\sigma_A(x)$ and a falsity membership function $\nu_A(x)$ and having of the form

$$\tilde{A}^N = \{ \langle x, \mu_A(x), \nu_A(x), \sigma_A(x) \rangle \mid x \in X \}$$

where $\mu_A(x), \nu_A(x)$ and $\sigma_A(x)$ are real standard or non-standard subsets of $]0^-, 1^+[$ i.e.

$$\mu_A(x): X \rightarrow]0^-, 1^+[$$

$$\nu_A(x): X \rightarrow]0^-, 1^+[$$

and $\sigma_A(x): X \rightarrow]0^-, 1^+[$.

There is no restriction on the sum of $\mu_A(x)$, $\nu_A(x)$ and $\sigma_A(x)$.

$$\text{So, } 0^- \leq \sup \mu_A(x) + \sup \nu_A(x) + \sup \sigma_A(x) \leq 3^+.$$

From the philosophical point of view, the NS takes the value from the real standard or non-standard subsets of $]0^-, 1^+[$. But in real life application in scientific and engineering problems it is difficult to use NS with value from the subsets of $]0^-, 1^+[$.

Ye [19] reduced NSs of non-standards intervals into a kind of simplified neutrosophic sets of standard intervals that will preserve the operations of NSs.

Definition 3.4. (Single-valued neutrosophic set) [20]

Let X be a space of points with a generic element x in X. A single-valued neutrosophic set (SVNS) \tilde{A}^N in X is characterized by $\mu_A(x)$, $\nu_A(x)$ and $\sigma_A(x)$, and having the form

$$\tilde{A}^N = \{ \langle x \mid \mu_A(x), \nu_A(x), \sigma_A(x) \rangle \mid x \in X \}$$

where $\mu_A(x): X \rightarrow [0,1]$

$$\nu_A(x): X \rightarrow [0,1]$$

and $\sigma_A(x): X \rightarrow [0,1]$

with $0 \leq \mu_A(x) + \nu_A(x) + \sigma_A(x) \leq 3$ for all $x \in X$.

4 Mathematical Analysis

4.1. Neutrosophic Optimization Technique

Here we are presenting a computational algorithm to solve multi-objective reliability optimization model (MOROM) by single valued neutrosophic optimization (NSO) approach and the following steps are used –

Computational algorithm

Step 1: A multi-objective non-linear programming taking k objective functions can be taken as -

$$\text{Maximize } (f_1(x), f_2(x), \dots \dots f_k(x))$$

$$\text{Subject to } g_i(x) \leq b_i, \quad i = 1, 2, \dots, m; \quad x \geq 0; \quad (4.1.1)$$

Step 2: Solve the above multi-objective non-linear programming model (4.1.1) taking only one objective function at a time and avoid the others, so that we can get the ideal solutions. With the values of all objective functions evaluated at these ideal solutions, the pay-off matrix can be formulated as follows-

Table 1: Pay-off matrix of the solution of k single objective non-linear programming problem.

	f_1	f_2	...	f_k
x^1	$f_1^*(x^1)$	$f_2(x^1)$...	$f_k(x^1)$
x^2	$f_1(x^2)$	$f_2^*(x^2)$...	$f_k(x^2)$
\vdots	\vdots	\vdots		\vdots
x^k	$f_1(x^k)$	$f_2(x^k)$...	$f_k^*(x^k)$

Step 3: Determine the upper bound and lower bound for each objective function as follows –

$$\begin{aligned}
 &U_r^T = \max \{f_r(x^1), f_r(x^2), \dots, f_r(x^k)\} \quad \forall r = 1, 2, \dots, k \\
 \text{and} \quad &L_r^T = \min \{f_r(x^1), f_r(x^2), \dots, f_r(x^k)\} \quad \forall r = 1, 2, \dots, k \quad (4.1.2) \\
 &\text{So,} \quad L_r^T \leq f_r(x) \leq U_r^T
 \end{aligned}$$

Where U_r^T and L_r^T are respectively upper and lower bounds for truth membership of the r-th objective function $f_r(x)$, $\forall r$.

Step 4: Now the upper and lower bounds for indeterminacy and falsity membership of objectives can be presented as follows –

$$\begin{aligned}
 &U_r^I = U_r^T \quad \text{and} \quad L_r^I = U_r^T - t_1(U_r^T - L_r^T) \\
 &U_r^F = U_r^T - t_2(U_r^T - L_r^T) \quad \text{and} \quad L_r^F = L_r^T \quad \forall r. \quad (4.1.3)
 \end{aligned}$$

Where U_r^I , L_r^I are upper and lower bounds for indeterminacy membership and U_r^F , L_r^F are upper and lower bounds for falsity membership of the r-th objective function $f_r(x)$.

Here t_1 and t_2 are two real parameters lies between 0 and 1.

Step 5: Construct the truth membership, indeterminacy membership and falsity membership functions as follows –

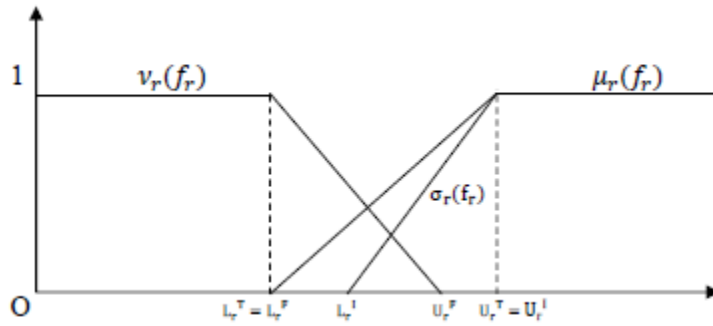

(A) Linear membership function

$$\mu_r(f_r) = \begin{cases} 0 & , f_r(x) \leq L_r^T \\ \frac{f_r(x) - L_r^T}{U_r^T - L_r^T} & , L_r^T \leq f_r(x) \leq U_r^T \\ 1 & , f_r(x) \geq U_r^T \end{cases} \quad \forall r = 1, 2, \dots, k \quad (4.1.4)$$

$$\sigma_r(f_r) = \begin{cases} 0 & , f_r(x) \leq L_r^I \\ \frac{f_r(x) - L_r^I}{U_r^I - L_r^I} & , L_r^I \leq f_r(x) \leq U_r^I \\ 1 & , f_r(x) \geq U_r^I \end{cases} \quad \forall r = 1, 2, \dots, k \quad (4.1.5)$$

$$\nu_r(f_r) = \begin{cases} 1 & , f_r(x) \leq L_r^F \\ \frac{U_r^F - f_r(x)}{U_r^F - L_r^F} & , L_r^F \leq f_r(x) \leq U_r^F \\ 0 & , f_r(x) \geq U_r^F \end{cases} \quad \forall r = 1, 2, \dots, k \quad (4.1.6)$$

(B) Non-linear membership function

$$\mu_r(f_r) = \begin{cases} 0 & , f_r(x) \leq L_r^T \\ 1 - \exp\left\{-\Psi \frac{f_r(x) - L_r^T}{U_r^T - L_r^T}\right\} & , L_r^T \leq f_r(x) \leq U_r^T \\ 1 & , f_r(x) \geq U_r^T; \end{cases} \quad \forall r = 1, 2, \dots, k \quad (4.1.7)$$

$$\sigma_r(f_r) = \begin{cases} 0 & , f_r(x) \leq L_r^I \\ \exp\left(\frac{f_r(x)-L_r^I}{U_r^I-L_r^I}\right) & , L_r^I \leq f_r(x) \leq U_r^I \\ 1 & , f_r(x) \geq U_r^I \end{cases} \quad \forall r = 1,2,\dots,k \quad (4.1.8)$$

$$v_r(f_r) = \begin{cases} 1 & , f_r(x) \leq L_r^F \\ \frac{1}{2} + \frac{1}{2} \tanh\left\{\delta_r \left(\frac{U_r^F+L_r^F}{2}\right) - f_r(x)\right\} & , L_r^F \leq f_r(x) \leq U_r^F \\ 0 & , f_r(x) \geq U_r^F ; \forall r = 1,2,\dots,k \end{cases} \quad (4.1.9)$$

where Ψ and δ_r are two non-zero parameters prescribed by the decision maker.

Step 6: Now using neutrosophic optimization technique the given multi-objective non-linear programming (MONLP) is equivalent to the following non-linear problem as

$$\text{Max } \mu_r(f_r(x))$$

$$\text{Min } v_r(f_r(x))$$

$$\text{Max } \sigma_r(f_r(x))$$

$$\text{Subject to } \mu_r(f_r) \geq v_r(f_r) ,$$

$$\mu_r(f_r) \geq \sigma_r(f_r) ,$$

$$v_r(f_r) \geq 0 ,$$

$$0 \leq \mu_r(f_r) + \sigma_r(f_r) + v_r(f_r) \leq 3 ,$$

$$g_i(x) \leq b_i , \quad i = 1,2,\dots,m; \quad x \geq 0 ,$$

$$\forall r = 1,2,\dots,k \quad (4.1.10)$$

where $\mu_r(f_r)$, $\sigma_r(f_r)$ and $v_r(f_r)$ are the truth membership function, indeterminacy membership function and falsity membership function of neutrosophic decision set respectively.

Step 7: Now using additive operator, the above problem (4.1.10) is reduced to the following crisp model

$$\text{Maximize } \sum_{r=1}^k \{\mu_r(f_r) - v_r(f_r) + \sigma_r(f_r)\}$$

$$\text{subject to the same constraints described in (4.1.10).} \quad (4.1.11)$$

Step 8: Solve (4.1.12) to get optimal solution.

4.2. Neutrosophic Optimization technique on Multi-objective Reliability Optimization problem

To solve the above defined problem in (2.2.2) , pay-off matrix is formulated as follows -

	$R_S(R)$	$C_S'(R)$
R^1	$R_S^*(R^1)$	$C_S'(R^1)$
R^2	$R_S(R^2)$	$C_S''(R^2)$

Now the best upper bound and worst lower bound are identified.

The upper and lower bound for truth membership function of the objective functions are defined as –

$$\begin{aligned}
 U_{R_S}^T &= \max\{ R_S(R^1) , R_S(R^2) \} \\
 U_{C_S'}^T &= \max\{ C_S'(R^1) , C_S'(R^2) \} \\
 L_{R_S}^T &= \min\{ R_S(R^1) , R_S(R^2) \} \\
 L_{C_S'}^T &= \min\{ C_S'(R^1) , C_S'(R^2) \} \quad (4.2.1)
 \end{aligned}$$

where $L_{R_S}^T \leq R_S(R) \leq U_{R_S}^T$ and $L_{C_S'}^T \leq C_S'(R) \leq U_{C_S'}^T$

Also the upper and lower bounds for indeterminacy and falsity membership of objective functions can be presented as

$$\begin{aligned}
 U_{R_S}^I &= U_{R_S}^T \text{ and } L_{R_S}^I = U_{R_S}^T - t_1(U_{R_S}^T - L_{R_S}^T) \\
 U_{C_S'}^I &= U_{C_S'}^T \text{ and } L_{C_S'}^I = U_{C_S'}^T - t_1(U_{C_S'}^T - L_{C_S'}^T) \\
 U_{R_S}^F &= U_{R_S}^T - t_2(U_{R_S}^T - L_{R_S}^T) \text{ and } L_{R_S}^F = L_{R_S}^T \\
 U_{C_S'}^F &= U_{C_S'}^T - t_2(U_{C_S'}^T - L_{C_S'}^T) \text{ and } L_{C_S'}^F = L_{C_S'}^T \quad (4.2.2)
 \end{aligned}$$

Now the linear and non-linear membership functions are formulated for the objective functions $R_S(R)$ and $C_S'(R)$.

After electing the membership functions, the crisp non-linear programming problem is formulated as follows –

$$\text{Maximize } [\mu_{R_S}(R_S(R)) + \mu_{C_S'}(C_S'(R)) - \nu_{R_S}(R_S(R)) - \nu_{C_S'}(C_S'(R)) + \sigma_{R_S}(R_S(R)) + \sigma_{C_S'}(C_S'(R))]$$

Subject to

$$\begin{aligned} \mu_{R_S}(R_S) &\geq \nu_{R_S}(R_S) \\ \mu_{R_S}(R_S) &\geq \sigma_{R_S}(R_S) \\ \mu_{C_S'}(C_S') &\geq \nu_{C_S'}(C_S') \\ \mu_{C_S'}(C_S') &\geq \sigma_{C_S'}(C_S') \\ 0 \leq \mu_{R_S}(R_S) + \nu_{R_S}(R_S) + \sigma_{R_S}(R_S) &\leq 3 \\ 0 \leq \mu_{C_S'}(C_S') + \nu_{C_S'}(C_S') + \sigma_{C_S'}(C_S') &\leq 3 \\ \nu_{R_S}(R_S) \geq 0, \nu_{C_S'}(C_S') &\geq 0 \end{aligned} \quad (4.2.3)$$

$$\sum_{j=1}^5 v_j R_j^{a_j} \leq V_{lim} ,$$

$$0.5 \leq R_{j,min} \leq R_j \leq 1, 0 \leq R_S \leq 1; j = 1, 2, \dots, 5$$

Solve the above crisp model to obtain optimal solution of the system reliability and cost of the system.

5 Numerical example

Now a five-stage combination reliability model of a complex system is considered for numerical exposure. The problem becomes as follows:

$$\text{Max } R_S(R) = R_1 \left(R_2^{10} + 10R_2^9(1 - R_2) \right) (1 - (1 - R_3)^2) (R_4 + R_4 \ln(1/R_4)) R_5$$

$$\text{Min } C_S(R) = \sum_{j=1}^5 c_j \left[\tan\left(\frac{\pi}{2}\right) R_j \right]^{\alpha_j}$$

$$\text{s. t. } V_S(R) = \sum_{j=1}^5 v_j R_j^{a_j} \leq V_{lim}$$

$$0.5 \leq R_{j,min} \leq R_j \leq 1, 0 \leq R_S \leq 1; j = 1, 2, \dots, 5 \quad (5.1)$$

Table 2: The input data for the MOROM (5.1) is given as follows:

c_1	c_2	c_3	c_4	c_5	v_1	v_2	v_3	v_4	v_5	$\alpha_j (\forall j)$	$a_j (\forall j)$	V_{lim}
40	30	35	36	32	6	4.75	2	3	7	0.75	1	22

Table 3: With the above solutions pay-off matrix of the objective functions is formulated as follows :

	$R_S(R)$	$C_S'(R)$
R^1	0.9457139	-6564.526
R^2	0.001705135	-156.8623

Now the upper and lower bound for truth membership of objective functions are given by

$$U_{R_S}^T = 0.9457139, U_{C_S'}^T = -156.8623;$$

$$L_{R_S}^T = 0.0017051, L_{C_S'}^T = -6564.526; \text{ and can be written as}$$

$$0.0017051 \leq R_S(R) \leq 0.9457139$$

$$\text{and } -6564.526 \leq C_S'(R) \leq -156.8623;$$

the upper and lower bounds for indeterminacy and falsity membership of objective functions can be presented as

$$U_{R_S}^I = 0.9457139 \text{ and } L_{R_S}^I = 0.9457139 - t_1(0.9440087)$$

$$U_{C_S'}^I = -156.8623 \text{ and } L_{C_S'}^I = -156.8623 - t_1(6407.6637)$$

$$U_{R_S}^F = 0.9457139 - t_2(0.9440087) \text{ and } L_{R_S}^F = 0.0017051$$

$$U_{C_S'}^F = -156.8623 - t_2(0.9440087) \text{ and } L_{C_S'}^F = -6564.526$$

Here we consider $t_1 = 0.002, t_2 = 0.085; \delta_1 = 1.15, \delta_2 = 0.005;$ and $\Psi = 4.$

Table 4: Comparison of optimal solutions by IFO and NSO technique

Method	R_1	R_2	R_3	R_4	R_5	$R_S(R)$	$C_S(R)$
(1) IFO approach	0.93213	0.96262	0.87069	0.83953	0.93914	0.80533	864.82
(2/A) NSO approach with Linear membership function	0.93143	0.96421	0.86244	0.82633	0.93934	0.80438	860.6
(2/B) NSO approach with Non-linear membership function	0.93964	0.96731	0.87357	0.84005	0.94663	0.82854	932.8

The above table shows the comparison of results of the proposed approach with the intuitionistic optimization approach. It is clear from the table (4) that NSO technique with linear membership function gives more of less same system reliability and the system cost with the intuitionistic fuzzy optimization (IFO) approach. However, in perspective of system reliability neutrosophic optimization technique with non-linear membership function gives better result than the IFO approach.

7 Conclusions and Future Work

Here we have introduced neutrosophic optimization technique with linear and non-linear membership function to find the optimal solution of the proposed multi-objective non-linear reliability optimization model. The main aim of this paper is to give a computational procedure for solving multi-objective reliability optimization model by neutrosophic optimization approach to find the optimal solution, which maximize the system reliability and minimize the cost of the system. In table (4), the result obtained in the neutrosophic optimization technique was compared with the IFO method and it shows that NSO technique with non-linear membership function gives better reliable system. Thus, the proposed method is an efficient and modified optimization technique and gives a highly reliable system than the other existing method.

Acknowledgements

The authors wish to acknowledge the University of Kalyani for financial support through the university research scholarship (URS) and DST-PURSE in the Department of Mathematics, University of Kalyani, Kalyani.

References

- [1] L.A.Zadeh, Fuzzy sets, *Information and Control*,8(1965), pp.338-353.
- [2] K. Atanassov, "Intuitionistic fuzzy sets", *Fuzzy sets and system*, 20(1986), pp. 87-96
- [3] F. Smarandache, *Neutrosophy, Neutrosophic probability, set and logic*, Amer. Res. Press, Rehoboth, USA, 105p, 1998.
- [4] H. Wang, F. Smarandache, Y. Zhang, and R. Sunderraman. *Single Valued Neutrosophic Sets, Multispace and Multistructure*, 4 (2010) 410-413.
- [5] H. Wang, F. Smarandache, Zhang, Y.-Q. and R.Sunderraman, "Interval Neutrosophic Sets and Logic: Theory and Applications in Computing", Phoenix: Hexis, 2005
- [6] K.S.Park, Fuzzy apportionment of system reliability, *IEEE Transaction on Reliability*, Vol R-36 , 1987 ,PP. 129-132
- [7] V. Ravi, P. Reddy and H. Zimmerman, "Fuzzy global optimization of complex system reliability", *IEEE Transactions on Fuzzy Systems*, 8(2000), pp. 241- 248.

- [8] H.Z. Huang, "Fuzzy multi-objective optimization decision making of reliability of series system", *Microelectronic and Reliability*, 37(1997), pp. 447-449
- [9] I. Turksen. "Interval valued fuzzy sets based on normal forms", *Fuzzy Sets and Systems*, vol. 20 (1986) 191-210.
- [10] M. Sharma, V. Sharma and R. Dangwal, "Reliability Analysis of a System Using Intuitionistic Fuzzy Sets", *International Journal of Soft Computing and Engineering*, 2(2012), pp. 431-440
- [11] K. Atanassov, "Intuitionistic fuzzy sets", *Physica- Verlag, Heidelberg, New York*.
- [12] H.J.Zimmermann, "Fuzzy Set Theory – and its applications", *Allied Publishers limited*
- [13] B. Jana and T.K.Roy, "Multi-objective intuitionistic fuzzy linear programming and its application in transportation model" *Notes on Intuitionistic fuzzy sets*, 13(2013), pp. 34-51.
- [14] G.S. Mahapatra, T.K.Roy, "Intuitionistic Fuzzy Multi-Objective Mathematical Programming on Reliability Optimization Model", *International Journal of Fuzzy Systems*, 12(2010), 259-266
- [15] R. Roy and P.Das, "A Multi-Objective Production Planning Problem Based on Neutrosophic Linear Programming Approach", *International Journal of Fuzzy Mathematical Archive*, 2(8), 2015, pp. 81-91.
- [16] Pramanik et al., "Neutrosophic Multi-Objective Linear Programming", *Global journal of engineering science and research management*, 3(8): 2016, pp. 36-46
- [17] M. A. Baest, M. Hezam, F. Smarandache, "Neutrosophic goal programming", *Neutrosophic Sets and Systems*, 11(2006), pp. 112-118.
- [18] U.Rivieccio, "Neutrosophic logics: Prospects problems", *Fuzzy sets and systems*, 159(2008), 1860-1868
- [19] J. Ye, "Multi-criteria decision making method using the correlation coefficient under single-value neutrosophic environment", *International Journal of General system*, 42(4), 2013, pp. 386-394.
- [20] J. Ye, "Multi-criteria decision making method using aggregation operators for simplified neutrosophic sets", *Journal of Intelligent and fuzzy systems*, 2013, Doi:10.3233/IFS-130916
- [21] K. Neubeck, "Practical Reliability Analysis", *Pearson Prentice Hall Publication, New Jersey*, 2004, 21-22
- [22] Abdel-Basset, Mohamed, et al. "A novel group decision-making model based on triangular neutrosophic numbers." *Soft Computing* (2017): 1-15. DOI: <https://doi.org/10.1007/s00500-017-2758-5>
- [23] Hussian, Abdel-Nasser, et al. "Neutrosophic Linear Programming Problems." *Peer Reviewers*: 15.
- [24] Abdel-Basset, Mohamed, Mai Mohamed, and Arun Kumar Sangaiah. "Neutrosophic AHP-Delphi Group decision making model based on trapezoidal neutrosophic numbers." *Journal of Ambient Intelligence and Humanized Computing* (2017): 1-17. DOI: <https://doi.org/10.1007/s12652-017-0548-7>
- [25] Mohamed, Mai, et al. "A Critical Path Problem in Neutrosophic Environment." *Peer Reviewers*: 167.
- [26] Mohamed, Mai, et al. "A Critical Path Problem Using Triangular Neutrosophic Number." *Peer Reviewers*: 155.
- [27] Mohamed, Mai, et al. "Using Neutrosophic Sets to Obtain PERT Three-Times Estimates in Project Management." *Peer Reviewers*: 143.
- [28] Mohamed, Mai, et al. "Neutrosophic Integer Programming Problem." *Neutrosophic Sets & Systems* 15 (2017).

- [29] Hezam, Ibrahim M., Mohamed Abdel-Baset, and Florentin Smarandache. "Taylor series approximation to solve neutrosophic multiobjective programming problem." *Neutrosophic Sets and Systems* 10 (2015): 39-46.
- [30] El-Hefenawy, Nancy, et al. "A review on the applications of neutrosophic sets." *Journal of Computational and Theoretical Nanoscience* 13.1 (2016): 936-944.
- [31] Mridula Sarkar, Samir Dey, Tapan Kumar Roy: Truss Design Optimization using Neutrosophic Optimization Technique, *Neutrosophic Sets and Systems*, vol. 13, 2016, pp. 62-69. doi.org/10.5281/zenodo.570869
- [32] Pintu Das, Tapan Kumar Roy: Multi-objective non-linear programming problem based on Neutrosophic Optimization Technique and its application in Riser Design Problem, *Neutrosophic Sets and Systems*, vol. 9, 2015, pp. 88-95. doi.org/10.5281/zenodo.571480
- [33] Mona Gamal Gafar, Ibrahim El-Henawy: Integrated Framework of Optimization Technique and Information Theory Measures for Modeling Neutrosophic Variables, *Neutrosophic Sets and Systems*, vol. 15, 2017, pp. 80-89. doi.org/10.5281/zenodo.570939
- [34] Naga Raju I, Rajeswara Reddy P, Dr. Diwakar Reddy V, Dr. Krishnaiah G: Real Life Decision Optimization Model, *Neutrosophic Sets and Systems*, vol. 14, 2016, pp. 71-79. doi.org/10.5281/zenodo.570889
- [35] Wenzhong Jiang, Jun Ye: Optimal Design of Truss Structures Using a Neutrosophic Number Optimization Model under an Indeterminate Environment, *Neutrosophic Sets and Systems*, vol. 14, 2016, pp. 93-97. doi.org/10.5281/zenodo.570888

II

Teacher Selection Strategy Based on Bidirectional Projection Measure in Neutrosophic Number Environment

Surapati Pramanik^{1*} ▪ Rumi Roy² ▪ Tapan Kumar Roy³

¹ Department of Mathematics, Nandalal Ghosh B.T. College, Panpur, P.O.-Narayanpur, District –North 24 Parganas, 743126, West Bengal, India. E-mail: sura_pati@yahoo.co.in

² Department of Mathematics, Indian Institute of Engineering Science and Technology, Shibpur, Howrah, 711103, West Bengal, India. E-mail: roy.rumir@gmail.com

³ Department of Mathematics, Indian Institute of Engineering Science and Technology, Shibpur, Howrah, 711103, West Bengal, India. E-mail: roy_t_k@gmail.com

Abstract

Teacher selection strategy is a multiple criteria decision-making process involving indeterminacy and vagueness, which can be represented by neutrosophic numbers of the form $a + bI$, where a represents determinate component and bI represents indeterminate component. The purpose of this study is to develop a multiple criteria group decision making model for teacher selection strategy based on bidirectional projection measure based strategy in neutrosophic number environment. Seven criteria obtained from expert opinions are considered for selection process. The criteria are namely demonstration, pedagogical knowledge, action research, emotional stability, knowledge on child psychology, social quality, and leadership quality. Weights of the decision makers are considered as equal. The bidirectional projection measure of neutrosophic numbers is a useful mathematical tool that can deal with decision making problems with indeterminate information. Using the bidirectional projection measure, a new multi criteria decision making strategy is proposed in the article. Using bidirectional projection measures between each alternative and the ideal alternative, all the alternatives are preference ranked to select the best one. Finally, teacher selection problem for secondary education is solved to demonstrate the applicability and effectiveness of the developed bidirectional projection strategy.

Keywords

Neutrosophic number, Bidirectional Projection method, Decision making, Teacher selection.

1 Introduction

Multiple criteria group decision making (MCGDM) [1, 2, 3] addresses the problem of finding the most desirable alternative from all the feasible alternatives. In crisp environment decision makers can express their ratings in terms of traditional number or crisp numbers for classical MCGDM [1, 2, 3]. deals with crisp numbers. However, when uncertainty involves in MCGDM, then new mathematical tool is needed to deal with uncertainty. Fuzzy set [4] and intuitionistic fuzzy set [5] are widely used mathematical tools to deal with non-statistical uncertainty. Intuitionistic fuzzy MCGDM [6, 7, 8, 9, 10, 11] strategies were reported in the literature, which employed the fuzzy or intuitionistic fuzzy numbers directly or through linguistic variables to represent the ratings and weights associated with the problems. However, when indeterminacy involves as independent entity, then fuzzy and intuitionistic fuzzy cannot deal such situation. To deal indeterminacy as independent entity, F. Smarandache defined neutrosophic set [12]. Later single valued neutrosophic set (SVNS) [13], a subclass of neutrosophic set receives much popularity in engineering, scientific and medical field. Various strategies [14-42, 71-78] for neutrosophic multi criteria decision making (MCDM) and MCDGM have been reported in the literature. Various neutrosophic hybrid structures such as rough neutrosophic set [43, 44], bipolar neutrosophic set (45), rough bipolar neutrosophic set [46], neutrosophic cubic set [47, 48], neutrosophic soft set [49], neutrosophic refined set [50], neutrosophic hesitant fuzzy set [51] have been proposed in the literature. The trend toward the study of neutrosophic theory and applications can be found in [52].

Teacher selection strategy is a MCDGM problem. G. B. Redfern [53] opinioned that in teacher selection strategy paradoxical aspect exists. In crisp environment, teacher selection strategy and related issues have been discussed in [54-57]

In intuitionistic fuzzy environment. Pramanik and Mukhopadhaya [58] developed intuitionistic fuzzy MCGDM strategy for teacher selection based on grey relational analysis. Motivated by the work of Pramanik and Mukhopadhaya [58], Mondal and Pramanik [59] extended it in single valued neutrosophic environment by employing score function and accuracy function where neutrosophic number is expressed as three independent components representing

membership, indeterminacy and falsity membership degrees. F. Smarandache [60, 61] defined neutrosophic number (NN) in another form which is easy to understand and cognitively suitable for working in the form $r+sI$, where r reflects determinate components and sI reflects indeterminate component respectively. If $N = sI$ i.e. the indeterminate component reaches the maximum label, the worst situation occurs. If $N = r$ i.e. the indeterminate component vanishes, the best situation occurs. Therefore, it seems that employment of NNs is more promising mathematical tool to deal with the indeterminate and incomplete information in practical decision making situations. J. Ye [62] proposed linear programming strategy with NN and solved production planning problem. In the same study, J. Ye [62] presented some basic operations of neutrosophic numbers and neutrosophic number function. Pramanik and Banerjee [63] developed three new neutrosophic goal programming model to solve multi-objective programming problems with neutrosophic coefficients, where coefficients are expressed as NNs in the form $r+sI$.

J. Ye [64] grounded a de-neutrosophication strategy and a possibility degree ranking strategy for NNs. In the same study, J. Ye [64] demonstrated the applicability of ranking strategy by solving a numerical MCGDM problem. Kong, Wu, and Ye [65] defined cosine similarity measure of NNs and employed it to deal with the misfire fault diagnosis of gasoline engine. In NNs environment, Liu and Liu [66] proposed MAGDM based on NN generalized weighted power averaging operator. Zheng et al. [67] developed a MAGDM method based on NN generalized hybrid weighted averaging operator. Literature review reflects that MCGDM in NNs environment is in its infancy. Therefore, it is necessary to investigate new strategy to solve MCGDM problems in NNs environment.

Projection strategies were used for solving MCGDM with intuitionistic fuzzy information [68, 69]. J. Ye [70] pointed out the general projection measures have shortcoming in some cases and need to be improved. In the same study, J. Ye [70] developed a bidirectional projection strategy for solving MCGDM under NNs environment. In NNs environment, teacher selection strategy is yet to appear. To fill the research gap, MCGDM strategy based on bidirectional measure is proposed for teacher selection for secondary education. This study is the extension work of Pramanik and Mukhopadhyaya [58] to NN environment. Selection criteria are obtained from experts' opinion. For this study, some criteria are common to the previous study [58] because experts agree to include these criteria for secondary education also. So operational definitions can be found in [58]. The selected seven criteria are demonstration (C1), pedagogical knowledge (C2), action research (C3), emotional stability (C4), knowledge on child psychology (C5), social quality (C6) and leadership quality (C7). An illustrative example is solved to demonstrate the feasibility and applicability of the proposed

strategy in NNs environment. In this study, strategy is comprehensively used including method, approach, process, technique, etc.

Rest of the paper is organized in the following way. Section 2 describes some basic concepts of NNs, the general projection measure and bidirectional projection measure between NNs. Section 3 describes projection and bidirectional projection based strategies for solving MCGDM problem. In section 4, an illustrative example of teacher selection strategy is presented. Finally, section 6 presents conclusion and future scope of work.

2 Preliminaries

In this Section, we provide some basic definitions that are useful in the paper.

2.1 Some concepts of neutrosophic numbers

Smarandache [13, 14, 15] firstly proposed the concept of neutrosophic numbers which consists of a determinate component and an indeterminate component and is denoted by $N = r + sI$ where r and s are real numbers and I is the indeterminacy such that $I^n = I$ for $n > 0$, $0 \times I = 0$, and $bI/kI =$ undefined for any real number k .

For example, assume that $N = 2 + 3I$ is a NN. If $I \in [0, 0.5]$, it is equivalent to $N \in [2, 3.5]$ for such $N \geq 2$, this means that its determinate component is 2 and its indeterminate component is $3I$ with the indeterminacy $I \in [0, 0.5]$ and the possibility for the number “ N ” is within the interval $[2, 3.5]$. In general, a NN may be considered as a changeable interval.

Let $N = r + sI$ be a neutrosophic number. If $r, s \geq 0$, then they are stated.

Let $N_1 = r_1 + s_1I$, and $N_2 = r_2 + s_2I$ be two neutrosophic numbers, then:

$$N_1 + N_2 = r_1 + r_2 + (s_1 + s_2)I; \quad (a)$$

$$N_1 - N_2 = r_1 - r_2 + (s_1 - s_2)I; \quad (b)$$

$$N_1 N_2 = r_1 r_2 + (s_1 r_2 + s_2 r_1 + s_1 s_2)I; \quad (c)$$

$$\frac{N_1}{N_2} = \frac{r_1}{r_2} + \frac{r_2 s_1 - s_2 r_1}{r_2(r_2 + s_2)} I \text{ for } r_2 \neq 0 \text{ and } r_2 \neq -s_2 \quad (d)$$

$$\begin{aligned} \sqrt{N_1} = & \{ \sqrt{r_1} - (\sqrt{r_1} + \sqrt{r_1 + s_1})I \\ & \sqrt{r_1} - (\sqrt{r_1} - \sqrt{r_1 + s_1})I \\ & \sqrt{r_1} + (\sqrt{r_1} + \sqrt{r_1 + s_1})I \\ & \sqrt{r_1} + (\sqrt{r_1} - \sqrt{r_1 + s_1})I \end{aligned} \quad (e)$$

2.2 Projection measure of neutrosophic numbers [70]

Definition 2.1 [70]

Let $R = (r_1, r_2, \dots, r_n)$ and $S = (s_1, s_2, \dots, s_n)$ be two NN vectors, where $r_j = [a_j + b_j I^l, a_j + b_j I^u]$ and $s_j = [c_j + d_j I^l, c_j + d_j I^u]$ for $I \in [I^l, I^u]$ and $j = 1, 2, \dots, n$. Then the moduli of R and S are defined as Then, the projection of the vector R on the vector S is defined as $Proj_S(R) = \|R\| \cos(R, S)$

Here, $\cos(R, S)$ is called the cosine the included angle between R and S and is defined as $\cos(R, S) = \frac{R.S}{\|R\| \|S\|}$.

Then the moduli of R and S are defined as:

$$\|R\| = \sqrt{\sum_{j=1}^n \left[(a_j + b_j I^l)^2 + (a_j + b_j I^u)^2 \right]} \quad \text{and} \quad \|S\| = \sqrt{\sum_{j=1}^n \left[(c_j + d_j I^l)^2 + (c_j + d_j I^u)^2 \right]}.$$

and the inner product of R and S is defined as

$$R.S = \sum_{j=1}^n \left[(a + b_j I^l)(c_j + d_j I^l) + (a + b_j I^u)(c_j + d_j I^u) \right].$$

Here, $\cos(R, S)$ is called the cosine measure and is defined as $\cos(R, S) = \frac{R.S}{\|R\| \|S\|}$.

Then,

$$\begin{aligned} Proj_S(R) &= \|R\| \cos(R, S) \\ &= \frac{R.S}{\|S\|} \end{aligned} \tag{1}$$

$$= \frac{\sum_{j=1}^n \left[(a + b_j I^l)(c_j + d_j I^l) + (a + b_j I^u)(c_j + d_j I^u) \right]}{\sum_{j=1}^n \sqrt{\left[(c_j + d_j I^l)^2 + (c_j + d_j I^u)^2 \right]}} \tag{2}$$

2.3 Bidirectional Projection Measure of NNs [70]

This section presents a bidirectional projection measure between NNs.

Definition 3.1 [70] Let $R = (r_1, r_2, \dots, r_n)$ and $S = (s_1, s_2, \dots, s_n)$ be two NN vectors, where $r_j = [a_j + b_j I^l, a_j + b_j I^u]$ and $s_j = [c_j + d_j I^l, c_j + d_j I^u]$ for $I \in [I^l, I^u]$ and $j = 1, 2, \dots, n$. Then the moduli of R and S are defined as

▪ $\|R\| = \sqrt{\sum_{j=1}^n [(a_j + b_j I^l)^2 + (a_j + b_j I^u)^2]}$ and $\|S\| = \sqrt{\sum_{j=1}^n [(c_j + d_j I^l)^2 + (c_j + d_j I^u)^2]}$
 and the inner product of R and S is defined as $R.S = \sum_{j=1}^n [(a + b_j I^l)(c_j + d_j I^l) + (a + b_j I^u)(c_j + d_j I^u)]$. Then the bidirectional projection measure between R and S is defined as:

$$\text{Bproj}(R, S) = \frac{1}{1 + \left| \frac{R.S}{\|S\|} - \frac{R.S}{\|R\|} \right|} = \frac{\|R\|\|S\|}{\|R\|\|S\| + \|R\| - \|S\|R.S}. \quad (3)$$

Obviously, the closure the value of $\text{Bproj}(R, S)$ is to 1, the closure R is to S .

$\text{Bproj}(R, S) = 1$ if and only if $R = S$.

$0 \leq \text{Bproj}(R, S) \leq 1$ for any two NN vector R and S which is a normalized measure.

Definition 3.2 [70] Let $R = (x_{kj})_{r \times q}$ and $S = (y_{kj})_{r \times q}$ be two NN matrices, where $x_{kj} = [a_{xkj} + b_{xkj} I^l, a_{xkj} + b_{xkj} I^u]$ and $y_{kj} = [a_{ykj} + b_{ykj} I^l, a_{ykj} + b_{ykj} I^u]$ for $I \in [I^l, I^u]$ and $k = 1, 2, \dots, r; j = 1, 2, \dots, q$.

Then, kj

$$\|R\| = \sqrt{\sum_{k=1}^r \sum_{j=1}^q [(a_{xkj} + b_{xkj} I^l)^2 + (a_{xkj} + b_{xkj} I^u)^2]},$$

$$\|S\| = \sqrt{\sum_{k=1}^r \sum_{j=1}^q [(a_{ykj} + b_{ykj} I^l)^2 + (a_{ykj} + b_{ykj} I^u)^2]},$$

$$\text{and } R.S = \sum_{k=1}^r \sum_{j=1}^q [(a_{xkj} + b_{xkj} I^l)(a_{ykj} + b_{ykj} I^l) + (a_{xkj} + b_{xkj} I^u)(a_{ykj} + b_{ykj} I^u)]$$

Then the bidirectional projection measure between R and S is defined as

$$\text{Bproj}(R, S) = \frac{\|R\|\|S\|}{\|R\|\|S\| + \|R\| - \|S\|R.S} \quad (4)$$

3 Projection and Bidirectional Projection Based Strategies for Solving MCGDM Problem

In this section, we extends work of Ye [70] to present two strategies for MCGDM problems using the (i) projection measure, (ii) bidirectional projection measure of NNs for teacher selection.

For a MCGDM problem with NNs, assume that $A = \{A_1, A_2, \dots, A_p\}$ be a set of applicants, $C = \{C_1, C_2, \dots, C_q\}$ be a set of criteria/attributes, and $D = \{D_1, D_2, \dots, D_m\}$ be a set of DMs or experts. If the decision maker (DM) D_k ($k = 1, 2, \dots, m$) provides an evaluation value of the attribute C_j ($j = 1, 2, \dots, q$) for the alternative A_i ($i = 1, 2, \dots, p$) by utilizing a scale from 1 (less fit) to 10 (more fit) with indeterminacy I that is represented by a NN $r_{kj}^i = a_{kj}^i + b_{kj}^i I$, $a_{kj}^i, b_{kj}^i \geq 0$ and $a_{kj}^i, b_{kj}^i \in R$ ($k = 1, 2, \dots, m$, $b_{kj}^i I \in [I^l, I^u]$). Then, we can construct the alternative decision matrix of NNs R^i ($i = 1, 2, \dots, p$):

$$R^i = \begin{bmatrix} r_{11}^i & r_{12}^i & \dots & r_{1n}^i \\ r_{21}^i & r_{22}^i & \dots & r_{2n}^i \\ \vdots & \vdots & \ddots & \vdots \\ r_{t1}^i & r_{t2}^i & \dots & r_{tn}^i \end{bmatrix}$$

The importance of the DMs in the selection committee may be differential in decision making situation. For the decision makers D_k ($k = 1, 2, \dots, m$), weight vector is considered as:

$$V = (v_1, v_2, \dots, v_m)^T \text{ with } v_j \geq 0 \text{ and } \sum_{j=1}^m v_j = 1.$$

The weights of attributes are generally different, and the weight of the attribute reflects the importance of the attribute in decision making situation. For the attributes C_j ($j = 1, 2, \dots, q$) the weight vector of attributes is considered as:

$$W = (w_1, w_2, \dots, w_q)^T \text{ with } w_j \geq 0 \text{ and } \sum_{j=1}^q w_j = 1.$$

(i) MCGDM Strategy-1 using projection measure (see Fig. 1):

Step 1 In decision making situation, to perform de-neutrosophication [70], each alternative decision matrix of NNs X^i is transformed into an equivalent alternative decision matrix of interval numbers. NN $r_{kj}^i = a_{kj}^i + b_{kj}^i I$ is transformed into $r_{kj}^i = [a_{kj}^i + b_{kj}^i I^l, a_{kj}^i + b_{kj}^i I^u]$ with respect to the prescribed indeterminacy $I \in [I^l, I^u]$. Specification of $I \in [I^l, I^u]$ depends on decision makers' choice and need of the practical situation.

Step 2 On calculating $s_{kj}^i = [s_{kj}^{li}, s_{kj}^{ui}] = [w_j s_{kj}^{li}, w_j s_{kj}^{ui}]$ ($k = 1, \dots, m; j = 1, \dots, q; i = 1, \dots, p$) for s_{kj}^i , we obtain the weighted alternative decision matrix

$$S^i = \begin{bmatrix} S_{11}^i & S_{12}^i & \dots & S_{1q}^i \\ S_{21}^i & S_{22}^i & \dots & S_{2q}^i \\ \vdots & \vdots & \ddots & \vdots \\ S_{m1}^i & S_{m2}^i & \dots & S_{mq}^i \end{bmatrix}$$

Step 3 To obtain the ideal alternative matrix

$$S^* = \begin{bmatrix} S_{11}^* & S_{12}^* & \dots & S_{1q}^* \\ S_{21}^* & S_{22}^* & \dots & S_{2q}^* \\ \vdots & \vdots & \ddots & \vdots \\ S_{m1}^* & S_{m2}^* & \dots & S_{mq}^* \end{bmatrix}$$

We calculate $s_{kj}^* = [s_{kj}^{i*}, s_{kj}^{u*}] = [\max_i (s_{kj}^{li}), \max_i (s_{kj}^{ui})]$ ($k = 1, \dots, m; j = 1, \dots, q; i = 1, \dots, p$).

Step 4 The projection measure between each weighted alternative decision matrix S^i ($i = 1, 2, \dots, p$) and the ideal alternative matrix S^* can be calculated by using equation (4) as follows: .

$$Proj_{S^*}(S^i) = \frac{S^i \cdot S^*}{\|S^*\|} \quad (5)$$

where

$$\|S^i\| = \sqrt{\sum_{k=1}^m \sum_{j=1}^q [(s_{kj}^{li})^2 + (s_{kj}^{ui})^2]}, \quad \|S^*\| = \sqrt{\sum_{k=1}^m \sum_{j=1}^q [(s_{kj}^{*})^2 + (s_{kj}^{*})^2]}$$

Step 5 The alternatives are ranked in a descending order according to the values of $Proj_{S^*}(S^i)$ for $i = 1, 2, \dots, p$. The greater value of $Proj_{S^*}(S^i)$ reflects the better alternative A_i .

Step 6 End.

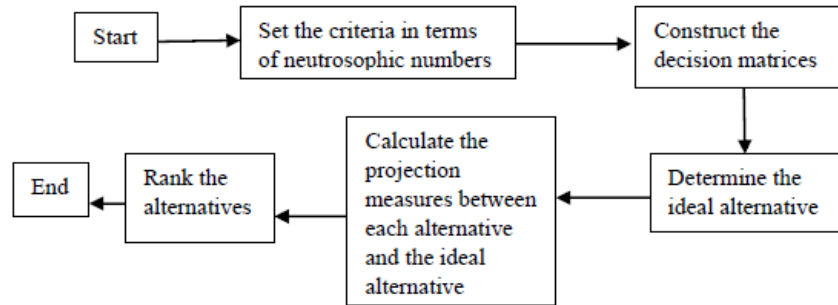

Fig. 1: Flowchart for MCGDM strategy based on projection measure

(ii) MCGDM Strategy-2 using bidirectional projection measure
(See fig. 2):

Step 1 Step 1 is the same as MCGDM strategy 1.

Step 2 Step 2 is the same as MCGDM strategy 1.

Step 3 Step 3 is the same as MCGDM strategy 1.

Step 4 The bidirectional projection measure between each weighted alternative decision matrix S^i ($i = 1, 2, \dots, p$) and the ideal alternative matrix S^* can be calculated by utilizing the equation (4) as follows: .

$$B_{\text{proj}}(S^i, S^*) = \frac{\|S^i\| \|S^*\|}{\|S^i\| \|S^*\| + \|S^i\| - \|S^*\| \|S^i\|} \quad (6)$$

where

$$\|S^i\| = \sqrt{\sum_{k=1}^m \sum_{j=1}^q [(s_{kj}^{li})^2 + (s_{kj}^{ui})^2]}, \quad \|S^*\| = \sqrt{\sum_{k=1}^m \sum_{j=1}^q [(s_{kj}^*)^2 + (s_{kj}^*)^2]}$$

Step 5 The alternatives are ranked in a descending order according to the values of $B_{\text{Proj}}(S^i, S^*)$ for $i = 1, 2, \dots, m$. The greater value of $B_{\text{Proj}}(S^i, S^*)$ means the better alternative A_i .

Step 6 End.

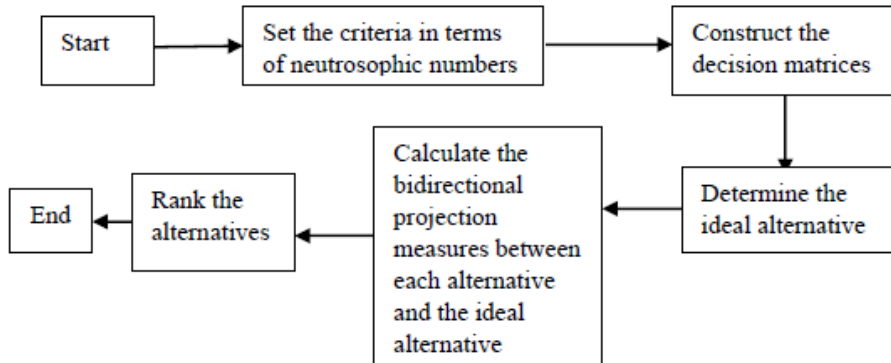

Fig.2: Flowchart for MCGDM strategy 2 based on bidirectional projection measure

4 Illustrative example

In this section, an illustrative example about teacher selection is given to show the applicability of the proposed method.

Suppose that a secondary institution is going to recruit in the post of a mathematics teacher.

After initial screening, five candidates (i.e. alternatives) A_1, A_2, A_3, A_4, A_5 remain for further evaluation. A committee of five decision makers or experts, E_1, E_2, E_3, E_4, E_5 has been formed to conduct the interview and select the most appropriate candidate. Seven criteria obtained from expert opinions, namely, demonstration (C_1), pedagogical knowledge(C_2), action research(C_3), emotional stability(C_4), knowledge on child psychology (C_5), social quality (C_6) and leadership quality(C_7) are considered for selection criteria.

Thus, the five alternative decision matrices are expressed, respectively, as tabular form:

Table 1: Alternative decision matrix provided by the decision maker E_1

$X_1 =$

7+I	8+I	7+I	7+I	7+I	5+4I	6+2I
6+2I	7+I	7+I	5+4I	6+2I	7+I	8+I
6+2I	7+I	6+2I	5+4I	5+4I	3+5I	6+2I
7+I	8+I	6+2I	7+I	5+4I	5+4I	7+I
7+I	7+I	6+2I	7+I	7+I	7+I	6+2I

Table 2: Alternative decision matrix provided by the decision maker E_2

$X_2 =$

6+2I	7+I	7+I	7+I	7+I	5+4I	6+2I
7+I	8+I	7+I	6+2I	6+2I	7+I	7+I
6+2I	7+I	6+2I	6+2I	6+2I	3+5I	7+I
7+I	7+I	6+2I	7+I	7+I	7+I	6+2I
6+2I	7+I	6+2I	7+I	7+I	7+I	6+2I

Table 3: Alternative decision matrix provided by the decision maker E_3

$X_3 =$

7+I	8+I	7+I	7+I	7+I	7+I	7+I
7+I	7+I	7+I	5+4I	6+2I	7+I	8+I
6+2I	7+I	6+2I	5+4I	7+I	3+5I	6+2I
5+4I	5+4I	6+2I	7+I	5+4I	7+I	5+4I
7+I	6+2I	6+2I	7+I	7+I	5+4I	6+2I

Table 4: Alternative decision matrix provided by the decision maker E_4

$X_4 =$

7+I	8+I	7+I	7+I	7+I	5+4I	6+2I
6+2I	7+I	7+I	5+4I	6+2I	7+I	8+I
6+2I	7+I	6+2I	5+4I	3+5I	3+5I	6+2I
7+I	8+I	6+2I	7+I	5+4I	5+4I	7+I
7+I	7+I	6+2I	7+I	7+I	7+I	6+2I

Table 5: Alternative decision matrix provided by the decision maker E_5

$X_5 =$

8+I	8+I	7+I	5+4I	7+I	6+2I	5+4I
8+I	7+I	7+I	7+I	6+2I	7+I	8+I
5+4I	7+I	8+I	7+I	7+I	7+I	5+4I
5+4I	7+I	8+I	7+I	5+4I	5+4I	7+I
7+I	7+I	6+2I	5+4I	7+I	5+4I	7+I

Then the developed strategy is applied to the decision making problem and described by the following steps:

Step 1: Assume that the specified indeterminacy is $I \in [0,0.5]$. Then each X^k can be transferred into the following forms:

Table 6: Alternative decision matrix provided by the decision maker E_1 after deneutrofication

$X_1 =$

[7,7.5]	[8,8.5]	[7,7.5]	[7,7.5]	[7,7.5]	[5,7]	[6,7]
[6,7]	[7,7.5]	[7,7.5]	[5,7]	[6,7]	[7,7.5]	[8,8.5]
[6,7]	[7,7.5]	[6,7]	[5,7]	[5,7]	[3,5.5]	[6,7]
[7,7.5]	[8,8.5]	[6,7]	[7,7.5]	[5,7]	[5,7]	[7,7.5]
[7,7.5]	[7,7.5]	[6,7]	[7,7.5]	[7,7.5]	[7,7.5]	[6,7]

Table 7: Alternative decision matrix provided by the decision maker E_2 after deneutrofication

$X_2 =$

[6,7]	[7,7.5]	[7,7.5]	[7,7.5]	[7,7.5]	[5,7]	[6,7]
[7,7.5]	[8,8.5]	[7,7.5]	[6,7]	[6,7]	[7,7.5]	[7,7.5]
[6,7]	[7,7.5]	[6,7]	[6,7]	[6,7]	[3,5.5]	[7,7.5]
[7,7.5]	[7,7.5]	[6,7]	[7,7.5]	[7,7.5]	[7,7.5]	[6,7]
[6,7]	[7,7.5]	[6,7]	[7,7.5]	[7,7.5]	[7,7.5]	[6,7]

Table 8: Alternative decision matrix provided by the decision maker E_3 after deneutrofication

$X_3 =$

[7,7.5]	[8,8.5]	[7,7.5]	[7,7.5]	[7,7.5]	[7,7.5]	[7,7.5]
[7,7.5]	[7,7.5]	[7,7.5]	[5,7]	[6,7]	[7,7.5]	[8,8.5]
[6,7]	[7,7.5]	[6,7]	[5,7]	[7,7.5]	[3,5.5]	[6,7]
[5,7]	[5,7]	[6,7]	[7,7.5]	[5,7]	[7,7.5]	[5,7]
[7,7.5]	[6,7]	[6,7]	[7,7.5]	[7,7.5]	[5,7]	[6,7]

Table 9: Alternative decision matrix provided by the decision maker E_4 after deneutrofication

$X_4 =$

[7,7.5]	[8,8.5]	[7,7.5]	[7,7.5]	[7,7.5]	[5,7]	[6,7]
[6,7]	[7,7.5]	[7,7.5]	[5,7]	[6,7]	[7,7.5]	[8,8.5]
[6,7]	[7,7.5]	[6,7]	[5,7]	[5,7]	[3,5.5]	[6,7]
[7,7.5]	[8,8.5]	[6,7]	[7,7.5]	[5,7]	[5,7]	[7,7.5]
[7,7.5]	[7,7.5]	[6,7]	[7,7.5]	[7,7.5]	[7,7.5]	[6,7]

Table 10: Alternative decision matrix provided by the decision maker E_5 after deneutrofication

$X_5 =$

[8,8.5]	[8,8.5]	[7,7.5]	[5,7]	[7,7.5]	[6,7]	[5,7]
[8,8.5]	[7,7.5]	[7,7.5]	[7,7.5]	[6,7]	[7,7.5]	[8,8.5]
[5,7]	[7,7.5]	[8,8.5]	[7,7.5]	[7,7.5]	[7,7.5]	[5,7]
[5,7]	[7,7.5]	[8,8.5]	[7,7.5]	[5,7]	[5,7]	[7,7.5]
[7,7.5]	[7,7.5]	[6,7]	[5,7]	[7,7.5]	[5,7]	[7,7.5]

Step 2: Assume that the weighting vector of the attributes is $W = (0.2, 0.2, 0.2, 0.1, 0.1, 0.1, 0.1)^T$. Then the five weighted decision matrices are obtained as follows:

Table 11: Weighted decision matrix provided by the decision maker E_1

$Y_1 =$

[1.4,1.5]	[1.6,1.7]	[1.4,1.5]	[.7,.75]	[.7,.75]	[.5,.7]	[.6,.7]
[1.2,1.4]	[1.4,1.5]	[1.4,1.5]	[.5,.7]	[.6,.7]	[.7,.75]	[.8,.85]
[1.2,1.4]	[1.4,1.5]	[1.2,1.4]	[.5,.7]	[.5,.7]	[.3,.55]	[.6,.7]
[1.4,1.5]	[1.6,1.7]	[1.2,1.4]	[.7,.75]	[.5,.7]	[.5,.7]	[.7,.75]
[1.4,1.5]	[1.4,1.5]	[1.2,1.4]	[.7,.75]	[.7,.75]	[.7,.75]	[.6,.7]

Table 12: Weighted decision matrix provided by the decision maker E_2

$Y_2 =$

[1.2,1.4]	[1.4,1.5]	[1.4,1.5]	[.7,.75]	[.7,.75]	[.5,.7]	[.6,.7]
[1.4,1.5]	[1.6,1.7]	[1.4,1.5]	[.6,.7]	[.6,.7]	[.7,.75]	[.7,.75]
[1.2,1.4]	[1.4,1.5]	[1.2,1.4]	[.6,.7]	[.6,.7]	[.3,.55]	[.7,.75]
[1.4,1.5]	[1.4,1.5]	[1.2,1.4]	[.7,.75]	[.7,.75]	[.7,.75]	[.6,.7]
[1.2,1.4]	[1.4,1.5]	[1.2,1.4]	[.7,.75]	[.7,.75]	[.7,.75]	[.6,.7]

Table 13: Weighted decision matrix provided by the decision maker E_3

$Y_3 =$

[1.4,1.5]	[1.6,1.7]	[1.4,1.5]	[.7,.75]	[.7,.75]	[.7,.75]	[.7,.75]
[1.4,1.5]	[1.4,1.5]	[1.4,1.5]	[.5,.7]	[.6,.7]	[.7,.75]	[.8,.85]
[1.2,1.4]	[1.4,1.5]	[1.2,1.4]	[.5,.7]	[.7,.75]	[.3,.55]	[.6,.7]
[1,1.4]	[1,1.4]	[1.2,1.4]	[.7,.75]	[.5,.7]	[.7,.75]	[.5,.7]
[1.4,1.5]	[1.2,1.4]	[1.2,1.4]	[.7,.75]	[.7,.75]	[.5,.7]	[.6,.7]

Table 14: Weighted decision matrix provided by the decision maker E_4

$Y_4 =$

[1.4,1.5]	[1.6,1.7]	[1.4,1.5]	[.7,.75]	[.7,.75]	[.5,.7]	[.6,.7]
[1.2,1.4]	[1.4,1.5]	[1.4,1.5]	[.5,.7]	[.6,.7]	[.7,.75]	[.8,.85]
[1.2,1.4]	[1.4,1.5]	[1.2,1.4]	[.5,.7]	[.5,.7]	[.3,.55]	[.6,.7]
[1.4,1.5]	[1.6,1.7]	[1.2,1.4]	[.7,.75]	[.5,.7]	[.5,.7]	[.7,.75]
[1.4,1.5]	[1.4,1.5]	[1.2,1.4]	[.7,.75]	[.7,.75]	[.7,.75]	[.6,.7]

Table 15: Weighted decision matrix provided by the decision maker E₅

Y₅=

[1.6,1.7]	[1.6,1.7]	[1.4,1.5]	[.5,.7]	[.7,.75]	[.6,.7]	[.5,.7]
[1.6,1.7]	[1.4,1.5]	[1.4,1.5]	[.7,.75]	[.6,.7]	[.7,.75]	[.8,.85]
[1,1.4]	[1.4,1.5]	[1.6,1.7]	[.7,.75]	[.7,.75]	[.7,.75]	[.5,.7]
[1,1.4]	[1.4,1.5]	[1.6,1.7]	[.7,.75]	[.5,.7]	[.5,.7]	[.7,.75]
[1.4,1.5]	[1.4,1.5]	[1.2,1.4]	[.5,.7]	[.7,.75]	[.5,.7]	[.7,.75]

Step3: The ideal alternative matrix is determined as follows:

$$Y^* = \begin{pmatrix} [1.6,1.7] & [1.6,1.7] & [1.4,1.5] & [.7,.75] & [.7,.75] & [.7,.75] & [.7,.75] \\ [1.6,1.7] & [1.6,1.7] & [1.4,1.5] & [.7,.75] & [.6,.7] & [.7,.75] & [.8,.85] \\ [1.2,1.4] & [1.4,1.5] & [1.6,1.7] & [.7,.75] & [.7,.75] & [.7,.75] & [.7,.75] \\ [1.4,1.5] & [1.6,1.7] & [1.6,1.7] & [.7,.75] & [.7,.75] & [.7,.75] & [.7,.75] \\ [1.4,1.5] & [1.4,1.5] & [1.2,1.4] & [.7,.75] & [.7,.75] & [.7,.75] & [.7,.75] \end{pmatrix}$$

Step4: The bidirectional projection measure values between each weighted alternative decision matrix Yⁱ(i = 1, 2, ..., 5) and the ideal alternative matrix Y* can be obtained as follows:

$$\|Y^*\| = 9.5586, \|Y_1\| = 8.9250, \|Y_2\| = 8.8431, \|Y_3\| = 8.7418, \|Y_4\| = 8.9250,$$

$$\|Y_5\| = 9.2129$$

$$Y_1.Y^* = 82.2749, Y_2.Y^* = 89.7328, Y_3.Y^* = 77.6600, Y_4.Y^* = 83.6450, Y_5.Y^* = 87.2375.$$

$$\text{Proj}_{Y^*}(Y_1) = 8.607421, \text{Proj}_{Y^*}(Y_2) = 9.387651, \text{Proj}_{Y^*}(Y_3) = 8.124621, \text{Proj}_{Y^*}(Y_4) = 8.750758, \text{Proj}_{Y^*}(Y_5) = 9.126598.$$

$$\text{BProj}(Y_1, Y^*) = 0.6207, \text{BProj}(Y_2, Y^*) = 0.5683, \text{BProj}(Y_3, Y^*) = 0.5687, \text{BProj}(Y_4, Y^*) = 0.6168, \text{BProj}(Y_5, Y^*) = 0.7449.$$

Step5:

$$\text{Since, } \text{Proj}_{Y^*}(Y_2) > \text{Proj}_{Y^*}(Y_5) > \text{Proj}_{Y^*}(Y_4) > \text{Proj}_{Y^*}(Y_1) > \text{Proj}_{Y^*}(Y_3),$$

then, the five candidates are ranked as: A₂ > A₅ > A₄ > A₁ > A₃.

Hence, according to MCGDM strategy 1 based on projection measure, A₂ is the best choice among all candidates.

Since

$BProj(Y^5, Y^*) > BProj(Y^1, Y^*) > BProj(Y^4, Y^*) > BProj(Y^3, Y^*) > BProj(Y^2, Y^*)$,
 then, the five candidates are ranked as: $A_5 \succ A_1 \succ A_4 \succ A_3 \succ A_2$.

Hence, according to MCGDM strategy 2 using bidirectional projection measure, A_5 is the best choice among all candidates.

For $I \in [0, 2]$

Note. We calculate ranking order for $I \in [0, 2]$ and calculations are given in appendix. Similarly, for specified I ranking order can be determined.

7 Conclusion

In real teacher selection process, indeterminacy plays an important role because the experts cannot present all the criteria and traits of applicant's completely and accurately due to time pressure, lack of domain knowledge, suitable environment of interview and other related issues of selection process. So, indeterminacy involves in their rating and decision. To deal such situations, neutrosophic number ($a + bI$, where a is the determinate component and bI is the indeterminate component) is more cognitively efficient to present indeterminate and incomplete information. In this paper, the teacher selection procedure is studied based on projection and bidirectional projection measure. The significance of the paper is that we combine NNs in educational setting to cope with MCGDM problems. Selection criteria are obtained by employing direct interview and opinion from domain experts. The proposed teacher selection strategy is an effective mathematical tool to express cognitive information and taking into account the reliability of the information. The proposed MCGDM strategy for teacher selection simply and reliably represents human cognition by considering the interactivity of criteria and the cognition towards indeterminacy involves in the problem. The developed MCGDM strategy for teacher selection combines the advantages of NNs and MCGDMS, which is more feasible and practical than other strategies. The proposed strategy is fairly flexible and easy to implement. Proposed MCGDM strategy for teacher selection is more comprehensive because when $I = 0$, it reduces to classical MCGDM strategy i.e. crisp MCGDM strategy.

Although this study has demonstrated the effectiveness of the proposed strategy, many areas need to be explored. Future studies should address the following problems: (i) the case when indeterminacy (I) assumes different specifications simultaneously for rating. (ii) unknown weights of the decision makers and unknown weights of the criteria (iii) Other practical decision making where MCGDM involves.

Acknowledgements

The authors are grateful to Prof. Dulal Mukhopahyaya, Department of Education, Netaji Subhas Open University, for his encouragement and dynamic support during the study. Prof. Dulal Mukhopahyaya spent his precious time and intellect to offer his sincere and valuable suggestions in conducting the study.

Appendix

Assume that the specified indeterminacy is $I \in [0,0.2]$ according to the decision makers' choice and real requirements.

Then,

Step 1: Each X^k can be transferred into the following forms:

Table 6: Alternative decision matrix provided by the decision maker E_1 after deneutrofication

$X_1 =$

[7,7.2]	[8,8.2]	[7,7.2]	[7,7.2]	[7,7.2]	[5,5.8]	[6,6.4]
[6,6.4]	[7,7.2]	[7,7.2]	[5,5.8]	[6,6.4]	[7,7.2]	[8,8.2]
[6,6.4]	[7,7.2]	[6,6.4]	[5,5.8]	[5,5.8]	[3,4]	[6,6.4]
[7,7.2]	[8,8.2]	[6,6.4]	[7,7.2]	[5,5.8]	[5,5.8]	[7,7.2]
[7,7.2]	[7,7.2]	[6,6.4]	[7,7.2]	[7,7.2]	[7,7.2]	[6,6.4]

Table 7: Alternative decision matrix provided by the decision maker E_2 after deneutrofication

$X_2 =$

[6,6.4]	[7,7.2]	[7,7.2]	[7,7.2]	[7,7.2]	[5,5.8]	[6,6.4]
[7,7.2]	[8,8.2]	[7,7.2]	[6,6.4]	[6,6.4]	[7,7.2]	[7,7.2]
[6,6.4]	[7,7.2]	[6,6.4]	[6,6.4]	[6,6.4]	[3,4]	[7,7.2]
[7,7.2]	[7,7.2]	[6,6.4]	[7,7.2]	[7,7.2]	[7,7.2]	[6,6.4]
[6,6.4]	[7,7.2]	[6,6.4]	[7,7.2]	[7,7.2]	[7,7.2]	[6,6.4]

Table 8: Alternative decision matrix provided by the decision maker E_3 after deneutrofication

$X_3 =$

[7,7.2]	[8,8.2]	[7,7.2]	[7,7.2]	[7,7.2]	[7,7.2]	[7,7.2]
[7,7.2]	[7,7.2]	[7,7.2]	[5,5.8]	[6,6.4]	[7,7.2]	[8,8.2]
[6,6.4]	[7,7.2]	[6,6.4]	[5,5.8]	[7,7.2]	[3,4]	[6,6.4]
[5,5.8]	[5,5.8]	[6,6.4]	[7,7.2]	[5,5.8]	[7,7.2]	[5,5.8]
[7,7.2]	[6,6.4]	[6,6.4]	[7,7.2]	[7,7.2]	[5,5.8]	[6,6.4]

Table 9: Alternative decision matrix provided by the decision maker E_4 after deneutrofication

$X_4 =$

[7,7.2]	[8,8.2]	[7,7.2]	[7,7.2]	[7,7.2]	[5,5.8]	[6,6.4]
[6,6.4]	[7,7.2]	[7,7.2]	[5,5.8]	[6,6.4]	[7,7.2]	[8,8.2]
[6,6.4]	[7,7.2]	[6,6.4]	[5,5.8]	[3,4]	[3,4]	[6,6.4]
[7,7.2]	[8,8.2]	[6,6.4]	[7,7.2]	[5,5.8]	[5,5.8]	[7,7.2]
[7,7.2]	[7,7.2]	[6,6.4]	[7,7.2]	[7,7.2]	[7,7.2]	[6,6.4]

Table 10: Alternative decision matrix provided by the decision maker E_5 after deneutrofication

$X_5 =$

[8,8.2]	[8,8.2]	[7,7.2]	[5,5.8]	[7,7.2]	[6,6.4]	[5,5.8]
[8,8.2]	[7,7.2]	[7,7.2]	[7,7.2]	[6,6.4]	[7,7.2]	[8,8.2]
[5,5.8]	[7,7.2]	[8,8.2]	[7,7.2]	[7,7.2]	[7,7.2]	[5,5.8]
[5,5.8]	[7,7.2]	[8,8.2]	[7,7.2]	[5,5.8]	[5,5.8]	[7,7.2]
[7,7.2]	[7,7.2]	[6,6.4]	[5,5.8]	[7,7.2]	[5,5.8]	[7,7.2]

Step2: Assume that the weighting vector of the attributes is $W=(0.2,0.2,0.2,0.1,0.1,0.1,0.1)^T$. Then the five weighted decision matrices are obtained as follows:

Table 11: Weighted decision matrix provided by the decision maker E_1

$Y_{1=}$

[1.4,1.44]	[1.6,1.64]	[1.4,1.44]	[.7,.72]	[.7,.72]	[.5,.58]	[.6,.64]
[1.2,1.28]	[1.4,1.44]	[1.4,1.44]	[.5,.58]	[.6,.64]	[.7,.72]	[.8,.82]
[1.2,1.28]	[1.4,1.44]	[1.2,1.28]	[.5,.58]	[.5,.58]	[.3,.4]	[.6,.64]
[1.4,1.44]	[1.6,1.64]	[1.2,1.28]	[.7,.72]	[.5,.58]	[.5,.58]	[.7,.72]
[1.4,1.44]	[1.4,1.44]	[1.2,1.28]	[.7,.72]	[.7,.72]	[.7,.72]	[.6,.64]

Table 12: Weighted decision matrix provided by the decision maker E_2

$Y_{2=}$

[1.2,1.28]	[1.4,1.44]	[1.4,1.44]	[.7,.72]	[.7,.72]	[.5,.58]	[.6,.64]
[1.4,1.44]	[1.6,1.64]	[1.4,1.44]	[.6,.64]	[.6,.64]	[.7,.72]	[.7,.72]
[1.2,1.28]	[1.4,1.44]	[1.2,1.28]	[.6,.64]	[.6,.64]	[.3,.4]	[.7,.72]
[1.4,1.44]	[1.4,1.44]	[1.2,1.28]	[.7,.72]	[.7,.72]	[.7,.72]	[.6,.64]
[1.2,1.28]	[1.4,1.44]	[1.2,1.28]	[.7,.72]	[.7,.72]	[.7,.72]	[.6,.64]

Table 13: Weighted decision matrix provided by the decision maker E_3

$Y_{3=}$

[1.4,1.44]	[1.6,1.64]	[1.4,1.44]	[.7,.72]	[.7,.72]	[.7,.72]	[.7,.72]
[1.4,1.44]	[1.4,1.44]	[1.4,1.44]	[.5,.58]	[.6,.64]	[.7,.72]	[.8,.82]
[1.2,1.28]	[1.4,1.44]	[1.2,1.28]	[.5,.58]	[.7,.72]	[.3,.4]	[.6,.64]
[1.1,1.16]	[1.1,1.16]	[1.2,1.28]	[.7,.72]	[.5,.58]	[.7,.72]	[.5,.58]
[1.4,1.44]	[1.2,1.28]	[1.2,1.28]	[.7,.72]	[.7,.72]	[.5,.58]	[.6,.64]

Table 14: Weighted decision matrix provided by the decision maker E_4

$Y_{4=}$

[1.4,1.44]	[1.6,1.64]	[1.4,1.44]	[.7,.72]	[.7,.72]	[.5,.58]	[.6,.64]
[1.2,1.28]	[1.4,1.44]	[1.4,1.44]	[.5,.58]	[.6,.64]	[.7,.72]	[.8,.82]
[1.2,1.28]	[1.4,1.44]	[1.2,1.28]	[.5,.58]	[.3,.4]	[.3,.4]	[.6,.64]
[1.4,1.44]	[1.6,1.64]	[1.2,1.28]	[.7,.72]	[.5,.58]	[.5,.58]	[.7,.72]
[1.4,1.44]	[1.4,1.44]	[1.2,1.28]	[.7,.72]	[.7,.72]	[.7,.72]	[.6,.64]

Table 15: Weighted decision matrix provided by the decision maker E₅

Y₅=

[1.6,1.64]	[1.6,1.64]	[1.4,1.44]	[.5,.58]	[.7,.72]	[.6,.64]	[.5,.58]
[1.6,1.64]	[1.4,1.44]	[1.4,1.44]	[.7,.72]	[.6,.64]	[.7,.72]	[.8,.82]
[1,1.16]	[1.4,1.44]	[1.6,1.64]	[.7,.72]	[.7,.72]	[.7,.72]	[.5,.58]
[1,1.16]	[1.4,1.44]	[1.6,1.64]	[.7,.72]	[.5,.58]	[.5,.58]	[.7,.72]
[1.4,1.44]	[1.4,1.44]	[1.2,1.28]	[.5,.58]	[.7,.72]	[.5,.58]	[.7,.72]

Step3: The ideal alternative matrix is determined as follows:

$$Y^* = \begin{pmatrix} [1.6,1.64] & [1.6,1.64] & [1.4,1.44] & [.7,.72] & [.7,.72] & [.7,.72] & [.7,.72] \\ [1.6,1.64] & [1.6,1.64] & [1.4,1.44] & [.7,.72] & [.6,.64] & [.7,.72] & [.8,.82] \\ [1.2,1.28] & [1.4,1.44] & [1.6,1.64] & [.7,.72] & [.7,.72] & [.7,.72] & [.7,.72] \\ [1.4,1.44] & [1.6,1.64] & [1.6,1.64] & [.7,.72] & [.7,.72] & [.7,.72] & [.7,.72] \\ [1.4,1.44] & [1.4,1.44] & [1.2,1.28] & [.7,.72] & [.7,.72] & [.7,.72] & [.7,.72] \end{pmatrix}$$

Step4: The projection and bidirectional projection measure values between each weighted alternative decision matrix Yⁱ(i=1, 2, ...,5) and the ideal alternative matrix Y* can be obtained as follows:

$$\|Y^*\| = 9.3455, \|Y_1\| = 8.6247, \|Y_2\| = 8.5618, \|Y_3\| = 8.3938,$$

$$\|Y_4\| = 8.6052, \|Y_5\| = 8.9047$$

$$Y_1.Y^* = 74.7640, Y_2.Y^* = 79.5144, Y_3.Y^* = 77.7436, Y_4.Y^* = 78.8632, Y_5.Y^* = 82.8728.$$

$$\text{Proj}_{Y^*}(Y_1) = 8.0000, \text{Proj}_{Y^*}(Y_2) = 8.5083, \text{Proj}_{Y^*}(Y_3) = 8.3188, \text{Proj}_{Y^*}(Y_4) = 8.4386, \text{Proj}_{Y^*}(Y_5) = 8.8677.$$

$$\text{BProj}(Y_1, Y^*) = 0.5993, \text{BProj}(Y_2, Y^*) = 0.5622, \text{BProj}(Y_3, Y^*) = 0.5146,$$

$$\text{BProj}(Y_4, Y^*) = 0.5794, \text{BProj}(Y_5, Y^*) = 0.6949.$$

Step 5: Since, Proj_{Y*}(Y₅) > Proj_{Y*}(Y₂) > Proj_{Y*}(Y₃) > Proj_{Y*}(Y₄) > Proj_{Y*}(Y₁), then, the five candidates are ranked as: A₅ > A₂ > A₃ > A₄ > A₁.

Hence, according to MCGDM strategy 1, A₅ is the best choice among all candidates.

Since, BProj(Y₅, Y*) > BProj(Y₁, Y*) > BProj(Y₄, Y*) > BProj(Y₂, Y*) > BProj(Y₃, Y*), then, the five candidates are ranked as: A₅ > A₁ > A₄ > A₂ > A₃.

Hence, according to MCGDM strategy 2, A₅ is the best choice among all candidates.

References

- [1] Arvey, R., D., Campion, J., E., (1982). The employment interview: A summary and review of recent research, *Personnel Psychology*, 35(2), 281–322.
- [2] Hwang, L., Lin, M., J., (1987). *Group decision making under multiple criteria: methods and applications*, Springer Verlag, Heidelberg.
- [3] Campion, M., A., Pursell, E., D., Brown, B., K., (1988). Structured interviewing; raising the psychometric properties of the employment interview, *Personnel Psychology*, 41(1), 25–42.
- [4] Zadeh, L. (1965). Fuzzy sets. *Information and Control*, 5, 338-353.
- [5] Atanassov, K. T. (1986). Intuitionistic fuzzy sets, *Fuzzy Sets and Systems*, 20(1), 87–96.
- [6] Lin, L., Yuan, X., H., Xia, Z., Q., (2007). Multicriteria fuzzy decision-making based on intuitionistic fuzzy sets, *Journal of Computers and Systems Sciences*, 73(1), 84–88.
- [7] Boran, F. E., Genc, S., Kurt, M., Akay, D. (2009). A multi-criteria intuitionistic fuzzy group decision making for supplier selection with TOPSIS method. *Expert Systems with Applications* 36(8), 11363–11368.
- [8] Zhang, S. F. & Liu, S. Y. (2011). A GRA-based intuitionistic fuzzy multi-criteria group decision making method for personnel selection, *Expert Systems with Applications* 38 11401–11405.
- [9] Ye, J., (2013). Multiple attribute group decision-making methods with unknown weights in intuitionistic fuzzy setting and interval-valued intuitionistic fuzzy setting, *International Journal of General Systems*, 42(5), 489-502.
- [10] Mondal, K, Pramanik, S. (2014). Intuitionistic fuzzy multicriteria group decision making approach to quality-brick selection problem, *Journal of Applied Quantitative Methods*, 9(2), 35-50.
- [11] Dey, P. P., Pramanik, S., & Giri, B., C. (2015). Multi-criteria group decision making in intuitionistic fuzzy environment based on grey relational analysis for weaver selection in Khadi institution, *Journal of Applied and Quantitative Methods*, 10(4), 1-14.
- [12] Smarandache, F. (1998). *Neutrosophy: neutrosophic probability, set, and logic: analytic synthesis & synthetic analysis*. Rehoboth: American Research Press.
- [13] Wang, H., Smarandache F., Zhang, Y.Q., & Sunderraman, R. (2010). Single valued neutrosophic sets, *Multispace and Multistructure*, 4, 410-413.
- [14] Sodenkamp, M. (2013). *Models, methods and applications of group multiple-criteria decision analysis in complex and uncertain systems*. Dissertation, University of Paderborn, Germany.
- [15] Kharal, A (2014). A neutrosophic multi-criteria decision making method, *New Mathematics and Natural Computation*, 10(2), 143–162.
- [16] Biswas, P., Pramanik, S., and Giri, B. C. (2014a). Entropy based grey relational analysis method for multi-attribute decision-making under single valued neutrosophic assessments, *Neutrosophic Sets and Systems*, 2, 102-110.
- [17] Biswas, P., Pramanik, S., and Giri, B. C. (2014b). A new methodology for neutrosophic multi-attribute decision making with unknown weight information, *Neutrosophic Sets and Systems*, 3, 42-52.
- [18] Biswas, P., Pramanik, S., & Giri, B.C. (2014c). Cosine similarity measure based multi-attribute decision-making with trapezoidal fuzzy neutrosophic numbers, *Neutrosophic Sets and Systems*, 8, 46-56.
- [19] Broumi, S., Smarandache, F. (2014). Single valued neutrosophic trapezoid linguistic aggregation operators based multi-attribute decision making, *Bulletin of Pure & Applied Sciences- Mathematics and Statistics*, 33(32), 135-155.

- [20] Ye, J., & Zhang, Q. (2014). : Single valued neutrosophic similarity measures for multiple attribute decision-making, *Neutrosophic Sets and Systems*, 2, 48-54. doi.org/10.5281/zenodo.571756
- [21] Liu, P., Chu, Y., Li, Y., and Chen, Y. (2014). Some generalized neutrosophic number Hamacher aggregation operators and their application to group decision making, *International Journal of Fuzzy Systems*, 16(2), 242-255.
- [22] Liu, P. and Wang, Y. (2014). Multiple attribute decision-making method based on single valued neutrosophic normalized weighted Bonferroni mean, *Neural Computing and Applications*, 25(7-8), 2001-2010.
- [23] Ye, J. (2014). Single valued neutrosophic minimum spanning tree and its clustering method, *Journal of Intelligent Systems*, 23(3): 311–324.
- [24] Ye, J. (2014). Multiple-attribute decision-making method under a single-valued neutrosophic hesitant fuzzy environment, *Journal of Intelligent Systems*, DOI: 10.1515/jisys-2014-0001.
- [25] P. Biswas, S. Pramanik, & B.C. Giri. (2015). Cosine similarity measure based multi-attribute decision-making with trapezoidal fuzzy neutrosophic numbers, *Neutrosophic Sets and Systems* 8 (2015), 47-57.
- [26] Mondal, K., Pramanik, S., (2015). Neutrosophic decision making model of school choice, *Neutrosophic Sets and Systems*, 7, 62-68.
- [27] Mondal, K., Pramanik, S. (2015). Neutrosophic tangent similarity measure and its application to multiple attribute decision making, *Neutrosophic Sets and Systems*, 9, 85-92.
- [28] Ye, J. (2015). Trapezoidal neutrosophic set and its application to multiple attribute decision-making, *Neural Computing and Applications*, 26, 1157-1166.
- [29] J. Ye. (2015). An extended TOPSIS method for multiple attribute group decision making based on single valued neutrosophic linguistic numbers, *Journal of Intelligent and Fuzzy Systems*, 28(1) (2015) 247–255.
- [30] Biswas, P., Pramanik, S., & Giri, B.C. (2016). TOPSIS method for multi-attribute group decision making under single-valued neutrosophic environment, *Neural Computing and Applications* 27(3), 727-737.
- [31] Biswas, P., Pramanik, S., & Giri, B. C. (2016). Aggregation of triangular fuzzy neutrosophic set information and its application to multi-attribute decision making, *Neutrosophic Sets and Systems* 12, 20-40.
- [32] Biswas, P., Pramanik, S., & Giri, B. C. (2016). Value and ambiguity index based ranking method of single-valued trapezoidal neutrosophic numbers and its application to multi-attribute decision making, *Neutrosophic Sets and Systems* 12, 127-138.
- [33] Şahin, R., Liu, P. Maximizing deviation method for neutrosophic multiple attribute decision making with incomplete weight information, *Neural Computing and Applications*, 27 (7), 2017-2029.
- [34] Tian, Z. P. , Wang, J. , Zhang, H. Y. , Chen, X. H. , & Wang, J. Q. (2016). Simplified neutrosophic linguistic normalized weighted Bonferroni mean operator and its application to multi-criteria decision-making problems, *Filomat*, 30 (12): 3339-3360.
- [35] Zhang, M., Liu, P., Shi, L. (2016). An extended multiple attribute group decision-making TODIM method based on the neutrosophic numbers, *Journal of Intelligent and Fuzzy Systems*, 30, 1773–1781. DOI: 10.3233/IFS-151889.
- [36] Deli, I. & Y. Subas, Y. (2017). A ranking method of single valued neutrosophic numbers and its application to multi-attribute decision making problems, *International Journal of Machine Learning and Cybernetics*, 8 (4), 1309-1322.
- [37] Liang, R., Wang, J. & Zhang, H. (2017). A multi-criteria decision-making method based on single-valued trapezoidal neutrosophic preference relations with complete weight information, *Neural Computing and Applications*. https://doi.org/10.1007/s00521-017-2925-8.

- [38] Pramanik, S., Biswas, P., & Giri, B. C. (2017). Hybrid vector similarity measures and their applications to multi-attribute decision making under neutrosophic environment, *Neural Computing and Applications*, 28 (5), 1163-1176. DOI:10.1007/s00521015-2125-3.
- [39] Biswas, P., Pramanik, S., and Giri, B. C. (2017). Non-linear programming approach for single-valued neutrosophic TOPSIS method, *New Mathematics and Natural Computation*. (In press).
- [40] Abdel-Basset, M., Mohamed, M., & Sangaiah, A. K. (2017). Neutrosophic AHP-Delphi group decision-making model based on trapezoidal neutrosophic numbers, *Journal of Ambient Intelligence and Humanized Computing*, 1-17. <https://doi.org/10.1007/s12652-017-0548-7>.
- [41] Abdel-Basset, M., Mohamed, M., Hussien, A. N., & Sangaiah, A. K. (2017). A novel group decision-making model based on triangular neutrosophic numbers, *Soft Computing*, 1-15. <http://doi.org/10.1007/s00500-017-2758-5>.
- [42] Xu, D. S., Wei, C., Wei, G. W. (2017). TODIM method for single-valued neutrosophic multiple attribute decision-making, *Information*, 8, 125. DOI:10.3390/info8040125.
- [43] Broumi, S., Smarandache, F., & Dhar, M. (2014). Rough neutrosophic sets, *Italian Journal of Pure and Applied Mathematics*, 32, 493–502.
- [44] Broumi, S., Smarandache, F., & Dhar, M. (2014). Rough neutrosophic sets, *Neutrosophic Sets and Systems*, 3, 60-66.
- [45] Deli, I., Ali, M., & Smarandache, F. (2015). Bipolar neutrosophic sets and their applications based on multicriteria decision making problems, *Advanced Mechatronic Systems, (ICAMEchs), International Conference*, 249-254. DOI: 10.1109/ICAMEchs.2015.7287068 .
- [46] Pramanik, S. & Mondal, K. (2016). Rough bipolar neutrosophic set, *Global Journal of Engineering Science and Research Management* 3(6), 71-81.
- [47] Ali, M., Deli, I., & Smarandache, F. (2016). The theory of neutrosophic cubic sets and their applications in pattern recognition, *Journal of Intelligent and Fuzzy Systems*, 30 (4) (2016), 1957-1963.
- [48] Jun, Y. B., Smarandache, F., & Kim, C. S. (2017). Neutrosophic cubic sets, *New Mathematics and Natural Computation*, 13 (1) (2017), 41-54.
- [49] Maji, P. K. (2013). Neutrosophic soft set, *Annals of Fuzzy Mathematics and Informatics*, 5 (1), 157-168.
- [50] Deli, I., Broumi, S. & Smarandache, F. (2015b). On neutrosophic refined sets and their applications in medical diagnosis, *Journal of New Theory*, 6, 88-89.
- [51] Ye, J. (2014 b). Multiple-attribute decision-making method under a single-valued neutrosophic hesitant fuzzy environment, *Journal of Intelligent Systems*, DOI: 10.1515/jisys-2014-0001.
- [52] Smarandache, F. & Pramanik, S. (Eds). (2016). *New trends in neutrosophic theory and applications*. Brussels: Pons Editions.
- [53] Redfern, G. B. (1966). Teacher selection, *Educational Leadership*, 23(7), 560-563.
- [54] Schuttenberg, E. M. (1975). Grading in teacher education and recruitment, *The Teacher Educator*, 11(3), 2-8. DOI:10.1080/08878737509554603.
- [55] Caliendo, R.J. (1986). Selecting capable teachers, *ERS Spectrum* 1,22-26.
- [56] Nicholson, E. W., Mcinerney, W. D. (1988). Hiring the right teacher: a method for selection, *NASSP Bulletin*, 72(511), 88-92. DOI:10.1177/019263658807251120.
- [57] Stronge, J. H., Hindman, J. L. (2006). *The teacher quality index: a protocol for teacher selection*. Association for Supervision and Curriculum Development, Alexandria, VA: DOI:10.1007/978-1-4166-0272-9.

[58] S. Pramanik, D. Mukhopadhyaya. (2011). Grey relational analysis based intuitionistic fuzzy multi criteria group decision-making approach for teacher selection in higher education, *International Journal of Computer Applications* 34(10,), 21-29.

[59] Mondal, K., & Pramanik, S., (2014). Multi-criteria group decision making approach for teacher recruitment in higher education under simplified neutrosophic environment, *Neutrosophic Sets and Systems*, 6, 28-34.

[60] Smarandache, F., (2013). Introduction to neutrosophic measure, neutrosophic integral, and neutrosophic Probability, Sitech & Education Publisher, Craiova – Columbus.

[61] Smarandache, F., (2014). Introduction to neutrosophic statistics, Sitech & Education Publishing.

[62] Ye, J. (2017). Neutrosophic number linear programming method and its application under neutrosophic number environments, *Soft Computing*. doi:10.1007/s00500-017-2646-z.

[63] Pramanik, S., Banerjee, D. (2017). Multi-objective linear goal programming problem with neutrosophic coefficients. In F. Smarandache, & S. Pramanik (Eds), *New trends in neutrosophic theory and application*. Brussels, Belgium: Pons Editions.

[64] Ye, J. (2016). Multiple-attribute group decision-making method under a neutrosophic number environment, *Journal of Intelligent Systems*, 25(3), 377–386.

[65] Kong, L. W., Wu, Y. F., & Ye, J. (2015). Misfire fault diagnosis method of gasoline engines using the cosine similarity measure of neutrosophic numbers, *Neutrosophic Sets and Systems*, 8, 43–46.

[66] Liu, P, & Liu, X. (2016). The neutrosophic number generalized weighted power averaging operator and its application in multiple attribute group decision making, *International Journal of Machine Learning Cybernetics*. DOI: 10.1007/s13042-016-0508-0.

[67] Zheng, E., Teng, F., & Liu, P. (2017). Multiple attribute group decision-making method based on neutrosophic number generalized hybrid weighted averaging operator, *Neural Computing and Applications*, 28 (8), 2063-2074.

[68] Yue, Z., L., (2013). An intuitionistic fuzzy projection-based approach for partner selection, *Applied Mathematical Modelling*, 37, 9538-9551.

[69] Zeng, S., Balezentis, T., Chen, J., and Luo, G. (2013). A projection method for multiple attribute group decision making with intuitionistic fuzzy information, *Informatica*, 24(3), 485-503.

[70] Ye, J., (2015). Bidirectional projection method for multiple attribute group decision making with neutrosophic number, *Neural Computing and Application*, doi: 10.1007/s00521-015-2123-5.

[71] Hussian, Abdel-Nasser, et al. "Neutrosophic Linear Programming Problems." Peer Reviewers: 15.

[72] Mohamed, Mai, et al. "A Critical Path Problem in Neutrosophic Environment." Peer Reviewers: 167.

[73] Mohamed, Mai, et al. "A Critical Path Problem Using Triangular Neutrosophic Number." Peer Reviewers: 155.

[74] Mohamed, Mai, et al. "Using Neutrosophic Sets to Obtain PERT Three-Times Estimates in Project Management." Peer Reviewers: 143.

[75] Mohamed, Mai, et al. "Neutrosophic Integer Programming Problem." *Neutrosophic Sets & Systems* 15 (2017).

[76] Abdel-Baset, Mohamed, Ibrahim M. Hezam, and Florentin Smarandache. "Neutrosophic goal programming." *Neutrosophic Sets Syst* 11 (2016): 112-118.

[77] Hezam, Ibrahim M., Mohamed Abdel-Baset, and Florentin Smarandache. "Taylor series approximation to solve neutrosophic multiobjective programming problem." *Neutrosophic Sets and Systems* 10 (2015): 39-46.

[78] Evelyn Jazmín Henríquez Antepará, Oscar Omar Apolinario Arzube, Jorge Arturo Chicala Arroyave, Eduardo Antonio Alvarado Unamuno, Maikel Leyva Vazquez: Competencies evaluation based on single valued neutrosophic numbers and decision analysis schema, *Neutrosophic Sets and Systems*, vol. 17, 2017, pp. 16-19. <http://doi.org/10.5281/zenodo.1012219>

[79] Silvia Liliana Tejada Yezpez: Decision support based on single valued neutrosophic number for information system project selection, *Neutrosophic Sets and Systems*, vol. 17, 2017, pp. 39-41. <http://doi.org/10.5281/zenodo.1012227>

[80] W. B. Vasantha Kandasamy, K. Ilanthenral, and Florentin Smarandache: Modified Collatz conjecture or $(3a + 1) + (3b + 1)I$ Conjecture for Neutrosophic Numbers, *Neutrosophic Sets and Systems*, vol. 14, 2016, pp. 44-46. doi.org/10.5281/zenodo.570883

[81] Wenzhong Jiang, Jun Ye: Optimal Design of Truss Structures Using a Neutrosophic Number Optimization Model under an Indeterminate Environment, *Neutrosophic Sets and Systems*, vol. 14, 2016, pp. 93-97. doi.org/10.5281/zenodo.570888

[82] Jiqian Chen, Jun Ye: A Projection Model of Neutrosophic Numbers for Multiple Attribute Decision Making of Clay-Brick Selection, *Neutrosophic Sets and Systems*, Vol. 12, 2016, pp. 139-142. doi.org/10.5281/zenodo.571127

III

A New Concept of Matrix Algorithm for MST in Undirected Interval Valued Neutrosophic Graph

Said Broumi^{1,*} ▪ Assia Bakali² ▪ Mohamed Talea¹ ▪ Florentin
Smarandache³ ▪ Kishore Kumar P K⁴

¹Laboratory of Information Processing, Faculty of Science Ben M'Sik, University Hassan II, B.P 7955, Sidi
Othman, Casablanca, Morocco. Email: broumisaid78@gmail.com, taleamohamed@yahoo.fr

²Ecole Royale Navale, Boulevard Sour Jdid, B.P 16303 Casablanca, Morocco. Email: assiabakali@yahoo.fr

³Department of Mathematics, University of New Mexico, 705 Gurley Avenue, Gallup, NM 87301, USA.
Email: smarand@unm.edu

⁴Department of Mathematics, Al Musanna College of Technology, Sultanate of Oman.
Email: kishorePK@act.edu.om

Abstract

In this chapter, we introduce a new algorithm for finding a minimum spanning tree (MST) of an undirected neutrosophic weighted connected graph whose edge weights are represented by an interval valued neutrosophic number. In addition, we compute the cost of MST and compare the de-neutrosophied value with an equivalent MST having the deterministic weights. Finally, a numerical example is provided.

Keywords

Interval valued Neutrosophic Graph, Score function, Minimum Spanning Tree (MST).

1 Introduction

In order to express the inconsistency and indeterminacy that exist in real-life problems reasonably, Smarandache [3] proposed the concept of neutrosophic sets (NSs) from a philosophical standpoint, which is characterized by three totally independent functions, i.e., a truth-function, an indeterminacy function and a falsity function that are inside the real standard or non-standard unit interval]-0, 1+[. Hence, neutrosophic sets can be regarded as many extended forms of classical fuzzy sets [8] such as intuitionistic fuzzy sets [6], interval-valued

intuitionistic fuzzy sets [7] etc. Moreover, for the sake of applying neutrosophic sets in real-world problems efficiently, Smarandache [9] put forward the notion of single valued neutrosophic sets (SVNSs for short) firstly, and then various theoretical operators of single valued neutrosophic sets were defined by Wang et al. [4]. Based on single valued neutrosophic sets, Wang et al. [5] further developed the notion of interval valued neutrosophic sets (IVNSs for short), some of their properties were also explored. Since then, studies of neutrosophic sets and their hybrid extensions have been paid great attention by numerous scholars [19]. Many researchers have proposed a fruitful results on interval valued neutrosophic sets [12,14,16,17,18,20,21-31]

MST is most fundamental and well-known optimization problem used in networks in graph theory. The objective of this MST is to find the minimum weighted spanning tree of a weighted connected graph. It has many real time applications, which includes communication system, transportation problems, image processing, logistics, wireless networks, cluster analysis and so on. The classical problems related to MST [1], the arc lengths are taken and it is fixed so that the decision maker use the crisp data to represent the arc lengths of a connected weighted graph. But in the real world scenarios the arch length represents a parameter which may not have a precise value. For example, the demand and supply, cost problems, time constraints, traffic frequencies, capacities etc., For the road networks, even though the geometric distance is fixed, arc length represents the vehicle travel time which fluctuates due to different weather conditions, traffic flow and some other unexpected factors. There are several algorithms for finding the MST in classical graph theory. These are based on most well-known algorithms such as Prims and Kruskals algorithms. Nevertheless, these algorithms cannot handle the cases when the arc length is fuzzy which are taken into consideration [2].

More recently, some scholars have used neutrosophic methods to find minimum spanning tree in neutrosophic environment. Ye [8] defined a method to find minimum spanning tree of a graph where nodes (samples) are represented in the form of NSs and distance between two nodes represents the dissimilarity between the corresponding samples. Mandal and Basu [9] defined a new approach of optimum spanning tree problems considering the inconsistency, incompleteness and indeterminacy of the information. They considered a network problem with multiple criteria represented by weight of each edge in neutrosophic sets. Kandasamy [11] proposed a double-valued Neutrosophic Minimum Spanning Tree (DVN-MST) clustering algorithm to cluster the data represented by double-valued neutrosophic information. Mullai [15] discussed the MST problem on a graph in which a bipolar neutrosophic number is associated to each

edge as its edge length, and illustrated it by a numerical example. To the end, no research dealt with the cases of interval valued neutrosophic arc lengths.

The main objective of this work is to find the minimum spanning tree of undirected neutrosophic graphs using the proposed matrix algorithm. It would be very much useful and easy to handle the considered problem of interval valued neutrosophic arc lengths using this algorithm.

The rest of the paper is organized as follows. Section 2 briefly introduces the concepts of neutrosophic sets, single valued neutrosophic sets, interval valued neutrosophic sets and the score function of interval valued neutrosophic number. Section 3 proposes a novel approach for finding the minimum spanning tree of interval valued neutrosophic undirected graph. In Section 4, two illustrative examples are presented to illustrate the proposed method. Finally, Section 5 contains conclusions and future work.

2 Preliminaries

Definition 2.1 [3] Let ξ be an universal set. The neutrosophic set A on the universal set ξ categorized in to three membership functions called the true $T_A(x)$, indeterminate $I_A(x)$ and false $F_A(x)$ contained in real standard or non-standard subset of $]0, 1^+[$ respectively.

$$0 \leq \sup T_A(x) + \sup I_A(x) + \sup F_A(x) \leq 3^+ \quad (1)$$

Definition 2.2 [4] Let ξ be a universal set. The single valued neutrosophic sets (SVNs) A on the universal ξ is denoted as following

$$A = \{ \langle x: T_A(x), I_A(x), F_A(x) \rangle \mid x \in \xi \} \quad (2)$$

The functions $T_A(x) \in [0, 1]$, $I_A(x) \in [0, 1]$ and $F_A(x) \in [0, 1]$ are named degree of truth, indeterminacy and falsity membership of x in A, satisfy the following condition:

$$0 \leq T_A(x) + I_A(x) + F_A(x) \leq 3 \quad (3)$$

Definition 2.3 [5]. An interval valued neutrosophic set A in X is defined as an object of the form

$$\tilde{A} = \{ \langle x, \tilde{t}, \tilde{i}, \tilde{f} \rangle : x \in X \},$$

$$\text{where } \tilde{t} = [T_{\tilde{A}}^L, T_{\tilde{A}}^U], \tilde{i} = [I_{\tilde{A}}^L, I_{\tilde{A}}^U], \tilde{f} = [F_{\tilde{A}}^L, F_{\tilde{A}}^U],$$

and $T_{\tilde{A}}^L, T_{\tilde{A}}^U, I_{\tilde{A}}^L, I_{\tilde{A}}^U, F_{\tilde{A}}^L, F_{\tilde{A}}^U : X \rightarrow [0, 1]$. The interval membership degree where $T_{\tilde{A}}^L, T_{\tilde{A}}^U, I_{\tilde{A}}^L, I_{\tilde{A}}^U, F_{\tilde{A}}^L, F_{\tilde{A}}^U$ denotes the lower and upper truth membership, lower and upper indeterminate membership and lower and upper false membership of an element $\in X$ corresponding to an interval valued neutrosophic set A where

$$0 \leq T_M^p + I_M^p + F_M^p \leq 3$$

In order to rank the IVNS, TAN [18] defined the following score function.

Definition 2.4 [18]. Let $\tilde{A} = \langle \tilde{t}, \tilde{i}, \tilde{f} \rangle$ be an interval valued neutrosophic number, where $\tilde{t} = [T_{\tilde{A}}^L, T_{\tilde{A}}^U]$, $\tilde{i} = [I_{\tilde{A}}^L, I_{\tilde{A}}^U]$, $\tilde{f} = [F_{\tilde{A}}^L, F_{\tilde{A}}^U]$. Then, the score function $s(\tilde{A})$, accuracy function $a(\tilde{A})$ and certainty function $c(\tilde{A})$ of an IVNN can be represented as follows:

$$(i) S_{TAN}(\tilde{A}) = \frac{(2 + T_{\tilde{A}}^L - I_{\tilde{A}}^L - F_{\tilde{A}}^L) + (2 + T_{\tilde{A}}^U - I_{\tilde{A}}^U - F_{\tilde{A}}^U)}{6},$$

$$S(\tilde{A}) \in [0, 1] \tag{4}$$

$$(ii) a_{TAN}(\tilde{A}) = \frac{(T_{\tilde{A}}^L - F_{\tilde{A}}^L) - (T_{\tilde{A}}^U - F_{\tilde{A}}^U)}{2} \quad a(\tilde{A}) \in [-1, 1] \tag{5}$$

TAN [18] gave an order relation between two IVNNs, which is defined as follows

Let $\tilde{A}_1 = \langle \tilde{t}_1, \tilde{i}_1, \tilde{f}_1 \rangle$ and $\tilde{A}_2 = \langle \tilde{t}_2, \tilde{i}_2, \tilde{f}_2 \rangle$ be two interval valued neutrosophic numbers then

- i. If $s(\tilde{A}_1) > s(\tilde{A}_2)$, then \tilde{A}_1 is greater than \tilde{A}_2 , that is, \tilde{A}_1 is superior to \tilde{A}_2 , denoted by $\tilde{A}_1 \succ \tilde{A}_2$
- ii. If $s(\tilde{A}_1) = s(\tilde{A}_2)$, and $a(\tilde{A}_1) > a(\tilde{A}_2)$ then \tilde{A}_1 is greater than \tilde{A}_2 , that is, \tilde{A}_1 is superior to \tilde{A}_2 , denoted by $\tilde{A}_1 \succ \tilde{A}_2$
- iii. If $s(\tilde{A}_1) = s(\tilde{A}_2)$, $a(\tilde{A}_1) = a(\tilde{A}_2)$, then \tilde{A}_1 is equal to \tilde{A}_2 , that is, \tilde{A}_1 is indifferent to \tilde{A}_2 , denoted by $\tilde{A}_1 = \tilde{A}_2$

Definition 2.5 [17]: Let $\tilde{A} = \langle [T_{\tilde{A}}^L, T_{\tilde{A}}^U], [I_{\tilde{A}}^L, I_{\tilde{A}}^U], [F_{\tilde{A}}^L, F_{\tilde{A}}^U] \rangle$ be an IVNN, the score function S of \tilde{A} is defined as follows

$$S_{RIDVAN}(\tilde{A}) = \frac{1}{4} (2 + T_A^L + T_A^U - 2I_A^L - 2I_A^U - F_A^L - F_A^U), \quad S(\tilde{A}) \in [-1, 1]. \tag{6}$$

Definition 2.6 [17]: Let $\tilde{A} = \langle [T_{\tilde{A}}^L, T_{\tilde{A}}^U], [I_{\tilde{A}}^L, I_{\tilde{A}}^U], [F_{\tilde{A}}^L, F_{\tilde{A}}^U] \rangle$ be an IVNN, the accuracy function H of \tilde{A} is defined as follows

$$H_{RIDVAN}(\tilde{A}) = \frac{1}{2} \left(\frac{T_{\tilde{A}}^L + T_{\tilde{A}}^U - 2}{I_{\tilde{A}}^U(1 - T_{\tilde{A}}^U) - I_{\tilde{A}}^L(1 - T_{\tilde{A}}^L) - F_{\tilde{A}}^U(1 - I_{\tilde{A}}^L) - F_{\tilde{A}}^L(1 - I_{\tilde{A}}^U)} \right), H(\tilde{A}) \in [-1, 1]. \quad (7)$$

To rank any two IVNNs $\tilde{A} = \langle [T_{\tilde{A}}^L, T_{\tilde{A}}^U], [I_{\tilde{A}}^L, I_{\tilde{A}}^U], [F_{\tilde{A}}^L, F_{\tilde{A}}^U] \rangle$ and $\tilde{B} = \langle [T_{\tilde{B}}^L, T_{\tilde{B}}^U], [I_{\tilde{B}}^L, I_{\tilde{B}}^U], [F_{\tilde{B}}^L, F_{\tilde{B}}^U] \rangle$,

Ridvan [17] introduced the following method.

Definition 2.7 [17]: Let \tilde{A} and \tilde{B} be two IVNNs, $S(\tilde{A})$ and $S(\tilde{B})$ be scores of \tilde{A} and \tilde{B} respectively, and $H(\tilde{A})$ and $H(\tilde{B})$ be accuracy values of \tilde{A} and \tilde{B} respectively, then

- i. If $S(\tilde{A}) > S(\tilde{B})$ then \tilde{A} is larger than \tilde{B} , denoted $\tilde{A} > \tilde{B}$.
- ii. If $S(\tilde{A}) = S(\tilde{B})$ then we check their accuracy values and decide as follows:
 - (a) If $H(\tilde{A}) = H(\tilde{B})$, then $\tilde{A} = \tilde{B}$.
 - (b) However, if $H(\tilde{A}) > H(\tilde{B})$, then \tilde{A} is larger than \tilde{B} , denoted $\tilde{A} > \tilde{B}$.

Definition 2.8 [12]: Let $\tilde{A} = \langle [T_{\tilde{A}}^L, T_{\tilde{A}}^U], [I_{\tilde{A}}^L, I_{\tilde{A}}^U], [F_{\tilde{A}}^L, F_{\tilde{A}}^U] \rangle$ be an IVNN, the score function S of \tilde{A} is defined as follows

$$S_{NANCY}(\tilde{A}) = \frac{4 + (T_{\tilde{A}}^L + T_{\tilde{A}}^U - 2I_{\tilde{A}}^L - 2I_{\tilde{A}}^U - F_{\tilde{A}}^L - F_{\tilde{A}}^U)(4 - T_{\tilde{A}}^L + T_{\tilde{A}}^U - F_{\tilde{A}}^L - F_{\tilde{A}}^U)}{8}, S(\tilde{A}) \in [0, 1].$$

Remark 2.9: In neutrosophic mathematics, the zero sets are represented by the following form $0_N = \{ \langle x, [0, 0], [1, 1], [1, 1] \rangle : x \in X \}$.

3 The proposed algorithm

The following algorithm is a new concept of finding the MST of undirected interval valued neutrosophic graph using the matrix approach.

Algorithm:

Input: the weight matrix $M = [W_{ij}]_{n \times n}$ for the undirected weighted interval valued neutrosophic graph G .

Output: Minimum cost Spanning tree T of G .

Step 1: Input interval valued neutrosophic adjacency matrix A .

Step 2: Convert the interval valued neutrosophic matrix into a score matrix $[S_{ij}]_{n \times n}$ using the score function.

Step 3: Iterate step 4 and step 5 until all $(n-1)$ entries matrix of S are either marked or set to zero or other words all the nonzero elements are marked.

Step 4: Find the weight matrix M either columns-wise or row-wise to determine the unmarked minimum entries S_{ij} which is the weight of the corresponding edge e_{ij} in M .

Step 5: If the corresponding edge e_{ij} of selected S_{ij} produces a cycle with the previous marked entries of the score matrix S then set $S_{ij} = 0$ else mark S_{ij} .

Step 6: Construct the graph T including only the marked entries from the score matrix S which shall be desired minimum cost spanning tree of G .

4 Practical example

4.1 Example 1

In this section, a numerical example of IVNMST is used to demonstrate of the proposed algorithm. Consider the following graph $G=(V, E)$ shown Figure 1, with fives nodes and seven edges. Various steps involved in the construction of the minimum cost spanning tree are described as follow –

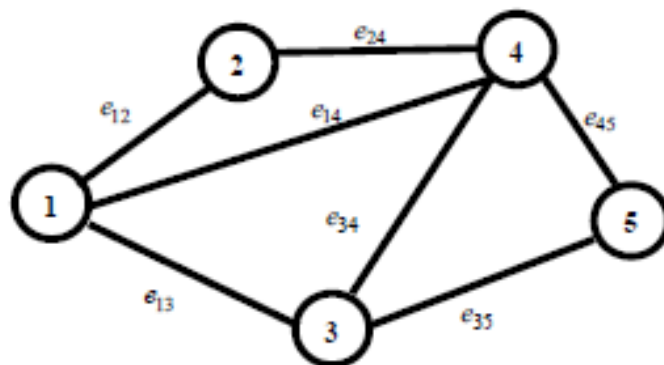

Fig.1. Undirected interval valued neutrosophic graphs

Table 1.

e_{ij}	Edge length
e_{12}	$\langle [0.3, .4], [0.1, .2], \langle [0.2, .4] \rangle \rangle$
e_{13}	$\langle [0.4, .5], [0.2, .6], \langle [0.4, .6] \rangle \rangle$
e_{14}	$\langle [0.1, .3], [0.6, .8], \langle [0.8, .9] \rangle \rangle$
e_{24}	$\langle [0.4, .5], [0.8, .9], \langle [0.3, .4] \rangle \rangle$
e_{34}	$\langle [0.2, .4], [0.3, .4], \langle [0.7, .8] \rangle \rangle$
e_{35}	$\langle [0.4, .5], [0.6, .7], \langle [0.5, .6] \rangle \rangle$
e_{45}	$\langle [0.5, .6], [0.4, .5], \langle [0.3, .4] \rangle \rangle$

The interval valued neutrosophic adjacency matrix A is computed below:

$$A = \begin{bmatrix} 0 & e_{12} & e_{13} & e_{14} & 0 \\ e_{12} & 0 & 0 & e_{24} & 0 \\ e_{13} & 0 & 0 & e_{34} & e_{35} \\ e_{14} & e_{24} & e_{34} & 0 & e_{45} \\ 0 & 0 & e_{35} & e_{45} & 0 \end{bmatrix}$$

Applying the score function proposed by Tan [18], we get the score matrix:

$$S = \begin{bmatrix} 0 & 0.633 & 0.517 & \mathbf{0.217} & 0 \\ 0.633 & 0 & 0 & 0.5 & 0 \\ 0.517 & 0 & 0 & 0.45 & 0.4 \\ 0.217 & 0.5 & 0.45 & 0 & 0.583 \\ 0 & 0 & 0.4 & 0.583 & 0 \end{bmatrix}$$

In this matrix, the minimum entries 0.217 is selected and the corresponding edge (1, 4) is marked by the green color. Repeat the procedure until termination (Figure 2).

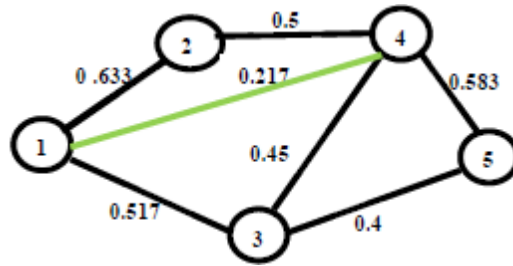

Fig.2. Marked interval valued neutrosophic graphs

The next non-zero minimum entries 0.4 is marked and corresponding edges (3, 5) are also colored (Figure 3).

$$S = \begin{bmatrix} 0 & 0.633 & 0.517 & \mathbf{0.217} & 0 \\ 0.633 & 0 & 0 & 0.5 & 0 \\ 0.517 & 0 & 0 & 0.45 & \mathbf{0.4} \\ 0.217 & 0.5 & 0.45 & 0 & 0.583 \\ 0 & 0 & 0.4 & 0.583 & 0 \end{bmatrix}$$

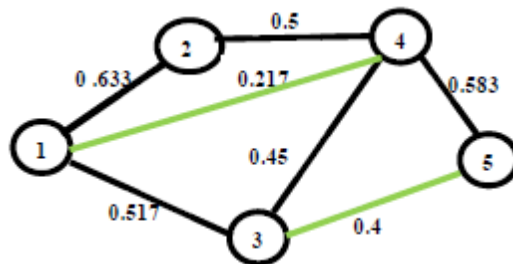

Fig. 3. Marked interval valued neutrosophic graphs in next iteration

$$S = \begin{bmatrix} 0 & 0.633 & 0.517 & \mathbf{0.217} & 0 \\ 0.633 & 0 & 0 & 0.5 & 0 \\ 0.517 & 0 & 0 & \mathbf{0.45} & \mathbf{0.4} \\ 0.217 & 0.5 & 0.45 & 0 & 0.583 \\ 0 & 0 & 0.4 & 0.583 & 0 \end{bmatrix}$$

The next non-zero minimum entries 0.45 is marked. The corresponding marked edges are portrayed in Figure 4.

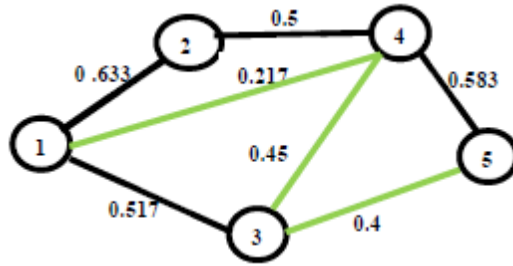

Fig. 4. Marked interval valued neutrosophic graphs in next iteration

$$S = \begin{bmatrix} 0 & 0.633 & 0.517 & \mathbf{0.217} & 0 \\ 0.633 & 0 & 0 & \mathbf{0.5} & 0 \\ 0.517 & 0 & 0 & \mathbf{0.45} & \mathbf{0.4} \\ 0.217 & 0.5 & 0.45 & 0 & 0.583 \\ 0 & 0 & 0.4 & 0.583 & 0 \end{bmatrix}$$

The next non-zero minimum entries 0.5 is marked. The corresponding marked edges are portrayed in Figure 5.

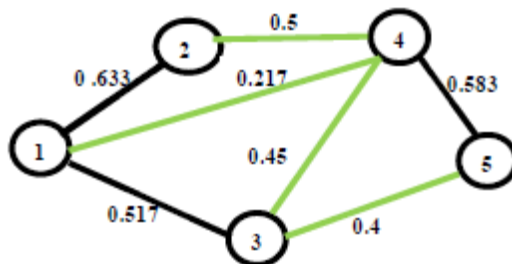

Fig. 5. Marked interval valued neutrosophic graphs in next iteration

$$S = \begin{bmatrix} 0 & 0.633 & \mathbf{0.517} & \mathbf{0.217} & 0 \\ 0.633 & 0 & 0 & \mathbf{0.5} & 0 \\ 0.517 & 0 & 0 & \mathbf{0.45} & \mathbf{0.4} \\ 0.217 & 0.5 & 0.45 & 0 & 0.583 \\ 0 & 0 & 0.4 & 0.583 & 0 \end{bmatrix}$$

The next minimum non-zero element 0.517 is marked. However, while drawing the edges, it produces the cycle so we delete and mark it as 0 instead of 0.517 (Figure 6).

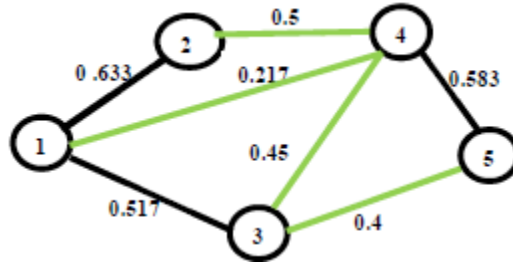

Fig. 6. Cycle {1, 3, 4}

$$S = \begin{bmatrix} 0 & 0.633 & \mathbf{0.517} & \mathbf{0} & \mathbf{0.217} & 0 \\ 0.633 & 0 & 0 & \mathbf{0.5} & 0 & 0 \\ 0.517 & 0 & 0 & \mathbf{0.45} & \mathbf{0.4} & 0 \\ 0.217 & 0.5 & 0.45 & 0 & 0 & 0.583 \\ 0 & 0 & 0.4 & \mathbf{0.583} & \mathbf{0} & 0 \end{bmatrix}$$

The next minimum non-zero element 0.583 is marked. However, while drawing the edges, it produces the cycle so we delete and mark it as 0 instead of 0.583 (Figure 7).

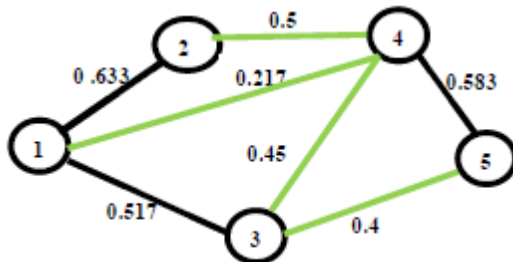

Fig. 7. Cycle {3, 4, 5}

$$S = \begin{bmatrix} 0 & 0.633 & \mathbf{0.517} & \mathbf{0} & \mathbf{0.217} & 0 \\ \mathbf{0.633} & \mathbf{0} & 0 & \mathbf{0.5} & 0 & 0 \\ 0.517 & 0 & 0 & \mathbf{0.45} & \mathbf{0.4} & 0 \\ 0.217 & 0.5 & 0.45 & 0 & 0 & 0.583 \\ 0 & 0 & 0.4 & \mathbf{0.583} & \mathbf{0} & 0 \end{bmatrix}$$

The next minimum non-zero element 0.633 is marked. However, while drawing the edges, it produces the cycle so we delete and mark it as 0 instead of 0.633 (Figure 8).

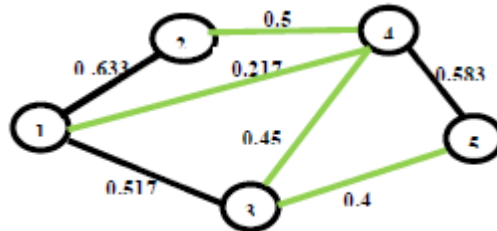

Fig. 8. Marked edges in the next round

Finally, we get the final path of minimum cost of spanning tree of G is portrayed in Figure 9.

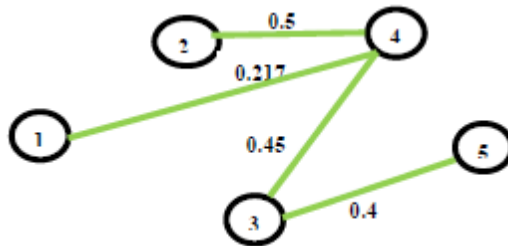
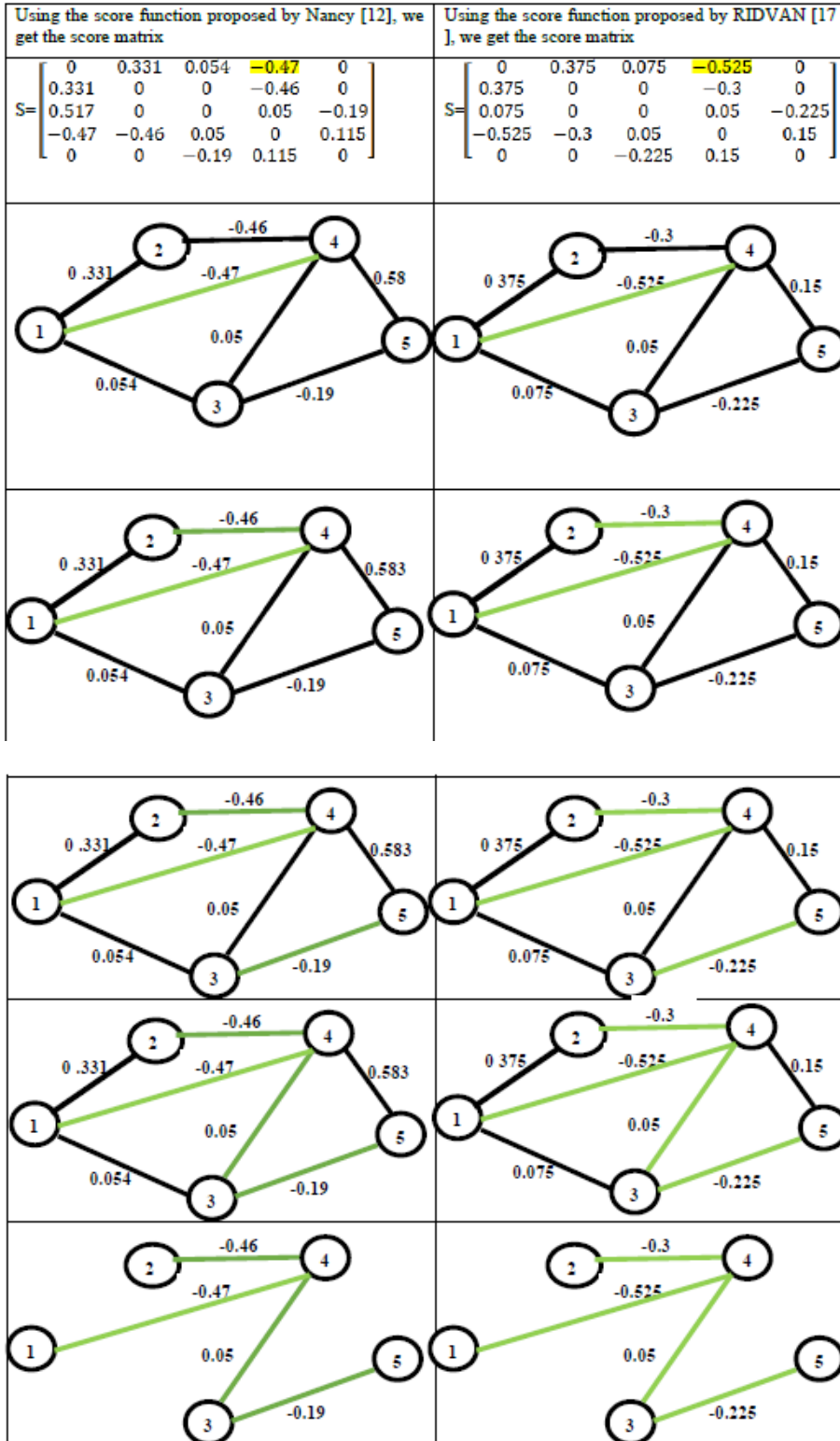

Fig. 9. Final path of minimum cost of spanning tree of the graph

And thus, the crisp minimum cost spanning tree is 1.567 and the final path of minimum cost of spanning tree is $\{2, 4\}, \{4, 1\}, \{4, 3\}, \{3, 5\}$. The procedure is termination.

4.2 Example 2

The score function is used in machine learning involved in manipulating probabilities. Here the score functions in the proposed algorithm plays a vital role in identifying the minimum spanning tree of undirected interval valued neutrosophic graphs. Also based on the order of polynomial time computation the score function used are approaching towards different MST for an Neutrosophic graph. We compare our proposed method with these scoring methods used by different researchers and hence compute the MST of undirected interval valued neutrosophic graphs.



<p>The crisp minimum cost spanning tree is -1.07 and the final path of minimum cost of spanning tree is {2, 4}, {4, 1}, {4, 3}, {3, 5}. The procedure is termination.</p>	<p>The crisp minimum cost spanning tree is -1 and the final path of minimum cost of spanning tree is {2, 4}, {4, 1}, {4, 3}, {3, 5}. The procedure is termination.</p>
---	--

5 Comparative study

In what follows we compare the proposed method presented in section 4 with other existing methods including the algorithm proposed by Mullai et al [15] as follow

Iteration 1:

Let $C_1 = \{1\}$ and $\bar{C}_1 = \{2, 3, 4, 5\}$

Iteration 2:

Let $C_2 = \{1, 4\}$ and $\bar{C}_2 = \{2, 3, 5\}$

Iteration 3:

Let $C_3 = \{1, 4, 3\}$ and $\bar{C}_3 = \{2, 5\}$

Iteration 4:

Let $C_4 = \{1, 3, 4, 5\}$ and $\bar{C}_4 = \{2\}$

Finally, the interval valued neutrosophic minimal spanning tree is

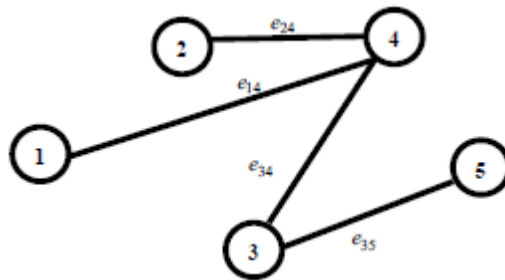

Fig .10. IVN minimal spanning tree obtained by Mullai's algorithm.

So, it can be seen that the interval valued neutrosophic minimal spanning tree $\{2, 4\}, \{4, 1\}, \{4, 3\}, \{3, 5\}$.obtained by Mullai's algorithm, After denutrosophication of edges'weight using the score function, is the same as the path obtained by proposed algorithm. The difference between the proposed algorithm and Mullai's algorithm is that our approach is based on Matrix approach, which can be easily implemented in Matlab, whereas the Mullai's algorithm is based on the comparison of edges in each iteration of the algorithm and this leads to high computation.

7 Conclusions and Future Work

This article analyse about the minimum spanning tree problem where the edges weights are represented by interval valued neutrosophic numbers. In the proposed algorithm, many examples were investigated on MST. The main objective of this study is to focus on algorithmic approach of MST in uncertain environment by using neutrosophic numbers as arc lengths. In addition, the algorithm we use is simple enough and more effective for real time environment. This work could be extended to the case of directed neutrosophic graphs and other kinds of neutrosophic graphs such as bipolar and interval valued bipolar neutrosophic graphs. In future, the proposed algorithm could be implemented to the real time scenarios in transportation and supply chain management in the field of operations research. On the other hand, graph interpretations (decision trees) of syllogistic logics and bezier curves in neutrosophic world could be considered and implemented as the real-life applications of natural logics and geometries of data [31-36].

Acknowledgements

The authors are very grateful to the editor of chapter book and reviewers for their comments and suggestions, which is helpful in improving the paper.

References

- [1] Mandal A, Dutta J, Pal S.C. A new efficient technique to construct a minimum spanning tree. *International Journal of Advanced Research in Computer Science and software Engineering*, Issue 10, 2012, pp.93-97.
- [2] Dey A, Pal A, Prim's algorithm for solving minimum spanning tree problem in fuzzy environment. *Annals of Fuzzy Mathematics and Informatics*.
- [3] Smarandache F. *Neutrosophy. Neutrosophic Probability, Set, and Logic*, ProQuest Information & Learning. Ann Arbor, Michigan, USA, 1998,105 p.
- [4] Wang H, Smarandache F, Zhang Y, and Sunderraman R. Single valued neutrosophic sets. *Multisspace and Multistructure*. 2010; 4: 410-413.
- [5] Wang H, Smarandache F, Zhang Y. Q, and Sunderraman R. *Interval neutrosophic sets and logic: Theory and Applications in Computing*, Hexis, Phoenix, AZ, 2005.
- [6] Atanassov K, Gargov G. Interval valued intuitionistic fuzzy sets. *Fuzzy Sets and Systems*. 1989; vol.31: 343-349.
- [7] Zadeh L. Fuzzy sets. *Inform and Control*. 1965, 8:338-353
- [8] Kandasamy I. Double-Valued Neutrosophic Sets, their Minimum Spanning Trees, and Clustering Algorithm. *Journal of Intelligent system* 2016, pp.1-17.
- [9] Ye J. single valued neutrosophic minimum spanning tree and its clustering method. *Journal of Intelligent system* 23, 2014, pp.311-324.
- [10] Mandal K and Basu K. Improved similarity measure in neutrosophic environment and its application in finding minimum spaning tree. *Journal of Intelligent & Fuzzy System* 31, 2016, pp. 1721-1730.

- [11] Nancy & H. Garg, An improved score function for ranking neutrosophic sets and its application to decision making process, *International Journal for Uncertainty Quantification*, 6 (5), 2016, pp.377–385 .
- [12] Broumi S, Talea M, Bakali A, Smarandache F. Interval Valued Neutrosophic Graphs. *Critical Review*, XII, 2016. pp.5-33
- [13] Broumi S, Smarandache F, Talea M., Bakali A. Decision-making method based on the interval valued neutrosophic graph. *Future Technologie*, 2016, IEEE, pp.44-50.
- [14] Mullai M, Broumi S, Stephen A. Shortest path problem by minimal spanning tree algorithm using bipolar neutrosophic numbers. *International Journal of Mathematic Trends and Technology*, 2017, Vol 46, N2. pp.80-87
- [16] Ye J. Interval Neutrosophic Multiple Attribute Decision-Making Method with Credibility Information. *international Journal of Fuzzy Systems*. 2016:1-10.
- [17] Şahin R and Liu PD. Maximizing deviation method for neutrosophic multiple attribute decision making with incomplete weight information, *Neural Computing and Applications*. (2015), DOI: 10.1007/s00521-015-1995-8
- [18] Tang G. Approaches for Relational Multiple Attribute Decision Making with Interval Neutrosophic Numbers Based on Choquet Integral. Master Thesis, Shandong University of Finance and Economics, Jinan, China, 2016 <http://fs.gallup.unm.edu/NSS/>.
- [19] Deli I, Şubaş Y, Smarandache F and Ali M. Interval valued bipolar neutrosophic sets and their application in pattern recognition. 2016 IEEE International Conference on Fuzzy Systems (FUZZ-IEEE) 2016, pp. 2460 – 2467
- [20] Broumi S, Smarandache F, Talea M and Bakali A. Operations on Interval Valued Neutrosophic Graphs. chapter in book- *New Trends in Neutrosophic Theory and Applications- Florentin Smarandache and Surpati Pramanik (Editors)*, 2016, pp. 231-254. ISBN 978-1-59973-498-9.
- [21] Abdel-Basset, Mohamed, et al. "A novel group decision-making model based on triangular neutrosophic numbers." *Soft Computing* (2017): 1-15. DOI: <https://doi.org/10.1007/s00500-017-2758-5>
- [22] Hussian, Abdel-Nasser, et al. "Neutrosophic Linear Programming Problems." *Peer Reviewers*: 15.
- [23] Abdel-Basset, Mohamed, Mai Mohamed, and Arun Kumar Sangaiah. "Neutrosophic AHP-Delphi Group decision making model based on trapezoidal neutrosophic numbers." *Journal of Ambient Intelligence and Humanized Computing* (2017): 1-17. DOI: <https://doi.org/10.1007/s12652-017-0548-7>
- [24] Mohamed, Mai, et al. "A Critical Path Problem in Neutrosophic Environment." *Peer Reviewers*: 167.
- [25] Mohamed, Mai, et al. "A Critical Path Problem Using Triangular Neutrosophic Number." *Peer Reviewers*: 155.
- [26] Mohamed, Mai, et al. "Using Neutrosophic Sets to Obtain PERT Three-Times Estimates in Project Management." *Peer Reviewers*: 143.
- [27] Mohamed, Mai, et al. "Neutrosophic Integer Programming Problem." *Neutrosophic Sets & Systems* 15 (2017).
- [28] Hezam, Ibrahim M., Mohamed Abdel-Baset, and Florentin Smarandache. "Taylor series approximation to solve neutrosophic multiobjective programming problem." *Neutrosophic Sets and Systems* 10 (2015): 39-46.
- [29] El-Hefenawy, Nancy, et al. "A review on the applications of neutrosophic sets." *Journal of Computational and Theoretical Nanoscience* 13.1 (2016): 936-944.
- [30] M. A. Baest, M. Hezam, F. Smarandache, "Neutrosophic goal programming", *Neutrosophic Sets and Systems*, 11(2006), pp. 112-118.
- [31] Topal, S. and Öner, T. Contrastings on Textual Entailmentness and Algorithms of Syllogistic Logics, *Journal of Mathematical Sciences*, Volume 2, Number 4, April 2015, pp 185-189.

- [32] Topal S. An Object-Oriented Approach to Counter-Model Constructions in A Fragment of Natural Language, *BEU Journal of Science*, 4(2), 103-111, 2015.
- [33] Topal, S. A Syllogistic Fragment of English with Ditransitive Verbs in Formal Semantics, *Journal of Logic, Mathematics and Linguistics in Applied Sciences*, Vol 1, No 1, 2016.
- [34] Topal, S. and Smaradache, F. A Lattice-Theoretic Look: A Negated Approach to Adjectival (Intersective, Neutrosophic and Private) Phrases. The 2017 IEEE International Conference on INnovations in Intelligent SysTems and Applications (INISTA 2017); (accepted for publication).
- [35] Taş, F. and Topal, S. Bezier Curve Modeling for Neutrosophic Data Problem. *Neutrosophic Sets and Systems*, Vol 16, pp. 3- 5, 2017. 70.
- [36] Topal, S. Equivalential Structures for Binary and Ternary Syllogistics, *Journal of Logic, Language and Information*, Springer, 2017, DOI: 10.1007/s10849-017-9260-4
- [37] S. Broumi, A. Dey, A. Bakali, M. Talea, F. Smarandache, L. H. Son, D. Koley: Uniform Single Valued Neutrosophic Graphs, *Neutrosophic Sets and Systems*, vol. 17, 2017, pp. 42-49. <http://doi.org/10.5281/zenodo.1012249>
- [38] T. Chalapathi, R. V M S S Kiran Kumar: Neutrosophic Graphs of Finite Groups, *Neutrosophic Sets and Systems*, vol. 15, 2017, pp. 22-30. doi.org/10.5281/zenodo.570943
- [39] Nasir Shah, Said Broumi: Irregular Neutrosophic Graphs, *Neutrosophic Sets and Systems*, vol. 13, 2016, pp. 47-55. doi.org/10.5281/zenodo.570846
- [40] Nasir Shah: Some Studies in Neutrosophic Graphs, *Neutrosophic Sets and Systems*, vol. 12, 2016, pp. 54-64. doi.org/10.5281/zenodo.571148
- [41] Said Broumi, Assia Bakali, Mohamed Talea, Florentin Smarandache: Isolated Single Valued Neutrosophic Graphs, *Neutrosophic Sets and Systems*, vol. 11, 2016, pp. 74-78. doi.org/10.5281/zenodo.571458

IV

Optimization of Welded Beam Structure using Neutrosophic Optimization Technique: A Comparative Study

Mridula Sarkar¹ • Tapan Kumar Roy²

¹Indian Institute of Engineering Science and Technology, Shibpur, P.O-Botanic Garden, Howrah, 711103, India. Email: mridula.sarkar86@rediffmail.com

²Indian Institute of Engineering Science and Technology, Shibpur, P.O-Botanic Garden, Howrah, 711103, India. Email: email-roy_t_k@yahoo.co.in

Abstract

This paper investigates Neutrosophic Optimization (NSO) approach to optimize the cost of welding of a welded steel beam, while the maximum shear stress in the weld group, maximum bending stress in the beam, maximum deflection at the tip and buckling load of the beam have been considered as flexible constraints.

The problem of designing an optimal welded beam consists of dimensioning a welded steel beam and the welding length so as to minimize its cost, subject to the constraints as stated above.

The purpose of the present study firstly to investigate the effect of truth, indeterminacy and falsity membership function in NSO in perspective of welded beam design in imprecise environment and secondly is to analyse the results obtained by different optimization methods like fuzzy, intuitionistic fuzzy and several deterministic methods so that the welding cost of the welded steel beam become most cost effective.

Specifically based on truth, indeterminacy and falsity membership function, a single objective NSO algorithm has been developed to optimize the welding cost, subjected to a set of flexible constraints. It has been shown that NSO is an efficient method in finding out the optimum value in comparison to other iterative methods for nonlinear welded beam design in precise and imprecise environment.

Numerical example is also given to demonstrate the efficiency of the proposed NSO approach.

Keywords

Neutrosophic Set, Single Valued Neutrosophic Set, Neutrosophic Optimization, Single-Objective welded beam optimization.

1 Introduction

In today's highly competitive market, the pressure on a construction agency is to find better ways to attain the optimal solution. In conventional optimization problems, it is assumed that the decision maker is sure about the precise values of data involved in the model. However, in real world applications all the parameters of the optimization problems may not be known precisely due to uncontrollable factors. Such type of imprecise data is well represented by fuzzy number introduced by Zadeh [1].

In reality, a decision maker may assume that an object belongs to a set to a certain degree, but it is probable that he is not sure about it. In other words, there may be uncertainty about the membership degree. The main premise is that the parameters' demand across the problem are uncertain. So, they are known to fall in a prescribed uncertainty set with some attributed degree. In Fuzzy Set (FS) theory, there is no means to incorporate this hesitation in the membership degree. To incorporate the uncertainty in the membership degree, Intuitionistic Fuzzy Sets (IFSs) proposed by Atanassov [2] is an extension of FS theory. In IFS theory along with degree of membership a degree of non-membership is usually considered to express ill-known quantity. This degree of membership and non-membership functions are so defined as they are independent to each other and sum of them is less or equal to one. So IFS is playing an important role in decision making under uncertainty and has gained popularity in recent years. However an application of the IFSs to optimization problems introduced by Angelov [3]. His technique is based on maximizing the degree of membership, minimizing the degree of non-membership and the crisp model is formulated using the IF aggregation operator.

Now the fact is that in IFS indeterminate information is partially lost, as hesitant information is taken in consideration by default. So indeterminate information should be considered in decision-making process. Smarandache [4, 41-50] defined neutrosophic set that could handle indeterminate and inconsistent information. In neutrosophic sets indeterminacy is quantified explicitly as indeterminacy membership along with truth membership, and falsity membership function which are independent. Wang et.al [5] define single valued neutrosophic set which represents imprecise, incomplete, indeterminate, inconsistent information. Thus taking the universe as a real line we can develop the concept of single valued neutrosophic set as special case of neutrosophic sets. This set is

able to express ill-known quantity with uncertain numerical value in decision making problem. It helps more adequately to represent situations where decision makers abstain from expressing their assessments.

In this way neutrosophic set provides a richer tool to grasp impression and ambiguity than the conventional FS as well as IFSs. Although exactly known, partially unknown and uncertain information handled by fully utilising the properties of transition rate matrices, together with the convexification of uncertain domains [6-8], NSO is more realistic in application of optimum design. These characteristics of neutrosophic set led to the extension of optimization methods in Neutrosophic environment (NSE).

Besides It has been seen that the current research on fuzzy mathematical programming is limited to the range of linear programming introduced by Ziemmermann [9] . It has been shown that the solutions of Fuzzy Linear Programming Problems (FLPPs) are always efficient. The most common approach for solving fuzzy linear programming problem is to change it into corresponding crisp linear programming problem.

But practically there exist so many nonlinear structural designs such as welded beam design problem in various the fields of engineering . So development of nonlinear programming is also essential. Recently a robust and reliable static output feedback (SOF) control for nonlinear systems [25] and for continuous-time nonlinear stochastic systems [26] with actuator fault in a descriptor system framework have been studied. However welding can be defined as a process of joining metallic parts by heating to a suitable temperature with or without the application of pressure. This cost of welding should be economical and welded beam should be durable one.

Since decades, deterministic optimization has been widely used in practice for optimizing welded connection design. These include mathematical traditional optimization algorithms such as David-Fletcher-Powell with a penalty function (DAVID) [10], Griffith and Stewart's Successive Linear Approximation (APPROX) [10], Simplex Method with Penalty Function (SIMPLEX) [10], Recherdson's Random Method (RANDOM) [10], Harmony Search Method [11], GA based Method [12,13], Improved Harmony Search Algorithm [14], Simple Constrained Particle Swarm Optimizer (SiC-PSO) [15], Mezura [16], Constrained Optimization via PSO Algorithm (COPSO) [17], GA based on a co-evolution model (GA1) [18], GA through the use of dominance based tournament selection (GA2) [19], Evolutionary Programming with a cultural algorithm (EP) [20], Co-evolutionary Particle Swarm Optimization (CPSO) [21], Hybrid Particle swarm optimization (HPSO) with a feasibility based rule [22], Hybrid Nelder-Mead Simplex search method and particle swarm optimization (NM-PSO) [23],

Particle Swarm Optimization (PSO) [24], Simulate Anneling (SA) [24], Goldlike (GL) [24], Cuckoo Search (Cuckoo) [24], Firefly Algorithm (FF), Flower Pollination (FP) [24], Ant Lion Optimizer (ALO) [24], Gravitational Search Algorithm (GSA) [24], Multi-Verse Optimizer (MVO) [24] etc. All these deterministic optimizations aim to search the optimum solution under given constraints without consideration of uncertainties.

Therefore, these traditional techniques cannot be applicable in optimizing welded beam design when impreciseness is involved in information. Thus, the research on optimization for nonlinear programming under fuzzy, IF and neutrosophic environment are not only necessary in the fuzzy optimization theory but also has great and wide value in application to welded beam design problem of conflicting and imprecise nature. This is the motivation of our present investigation.

In this regard, it can be cited that Das et al. [27] developed neutrosophic nonlinear programming with numerical example and application of real life problem recently. A single objective plane truss structure [28] and a multi-objective plane truss structure [29] have been optimized in IF environment. A multi-objective structural model has been optimized by IF mathematical programming with IF number for truss structure [30], welded beam structure [37] and neutrosophic number for truss design [36] as coefficient of objective by Sarkaret.al. With the help of linear membership [31] and nonlinear membership [32, 33] for single objective truss design and multi-objective truss design [34] have been optimized in neutrosophic environment. A multi-objective goal programming technique [35] and T-norm, T-conorm based IF optimization technique [38] have been developed to optimize cost of welding in neutrosophic and IF environment respectively.

The aim of this paper is to show the efficiency of single objective NSO technique in finding optimum cost of welding of welded beam in imprecise environment and to make a comparison of results obtained in different deterministic methods.

The paper is organized as follows. In sect. 2, we have presented mathematical preliminaries on neutrosophic set. In sect.3, we have developed mathematical algorithm to solve a single objective nonlinear programming problem. In sect. 4, we have studied detail formulation of welded beam and solved it using NSO technique. In sect. 5 we have solved welded beam design model numerically. Lastly, in sect.6 we arrive at a conclusion.

2 Mathematical Preliminaries

In the following, we briefly describe some basic concepts and basic operational laws related to neutrosophic set [1, 2, 5, 27]

2.1 Fuzzy Set (FS) [1]

Let X be a fixed set. A fuzzy set \tilde{A} of X is an object having the form

$$\tilde{A} = \{(x, T_{\tilde{A}}(x)) | x \in X\} \quad (1)$$

where the function $T_{\tilde{A}} : X \rightarrow [0,1]$ stands for the truth membership of the element $x \in X$ to the set \tilde{A} .

2.2. Intuitionistic Fuzzy Set (IFS) [2]

Let a set X be fixed. An intuitionistic fuzzy set or IFS \tilde{A}^i in X is an object of the form

$$\tilde{A}^i = \{(x, T_{\tilde{A}^i}(x), F_{\tilde{A}^i}(x)) | x \in X\} \quad (2)$$

where $T_{\tilde{A}^i} : X \rightarrow [0,1]$ and $F_{\tilde{A}^i} : X \rightarrow [0,1]$ define the truth membership and falsity membership respectively, for every element of $x \in X$ such that $0 \leq T_{\tilde{A}^i}(x) + F_{\tilde{A}^i}(x) \leq 1$.

2.3. Single-Valued Neutrosophic Set (SVNS) [5]

Let a set X be the universe of discourse. A single valued neutrosophic set \tilde{A}^n over X is an object having the form

$$\tilde{A}^n = \{(x, T_{\tilde{A}^n}(x), I_{\tilde{A}^n}(x), F_{\tilde{A}^n}(x)) | x \in X\} \quad (3)$$

where $T_{\tilde{A}^n} : X \rightarrow [0,1]$, $I_{\tilde{A}^n} : X \rightarrow [0,1]$ and $F_{\tilde{A}^n} : X \rightarrow [0,1]$ are truth, indeterminacy and falsity membership functions respectively so as to $0 \leq T_{\tilde{A}^n}(x) + I_{\tilde{A}^n}(x) + F_{\tilde{A}^n}(x) \leq 3$ for all $x \in X$.

2.4. Union of Neutrosophic Sets (NSs) [27]

The union of two single valued neutrosophic sets \tilde{A}^n and \tilde{B}^n is a single valued neutrosophic set \tilde{U}^n denoted by

$$\tilde{U}^n = \tilde{A}^n \cup \tilde{B}^n = \{(x, T_{\tilde{U}^n}(x), I_{\tilde{U}^n}(x), F_{\tilde{U}^n}(x)) | x \in X\} \quad (4)$$

and is defined by the following conditions

- (i) $T_{\tilde{U}^n}(x) = \max(T_{\tilde{A}^n}(x), T_{\tilde{B}^n}(x))$,
- (ii) $I_{\tilde{U}^n}(x) = \max(I_{\tilde{A}^n}(x), I_{\tilde{B}^n}(x))$,
- (iii) $F_{\tilde{U}^n}(x) = \min(F_{\tilde{A}^n}(x), F_{\tilde{B}^n}(x))$ for all $x \in X$ for Type-I

Or in another way by defining following conditions

- (i) $T_{\tilde{U}^n}(x) = \max(T_{\tilde{A}^n}(x), T_{\tilde{B}^n}(x))$,
- (ii) $I_{\tilde{U}^n}(x) = \min(I_{\tilde{A}^n}(x), I_{\tilde{B}^n}(x))$
- (iii) $F_{\tilde{U}^n}(x) = \min(F_{\tilde{A}^n}(x), F_{\tilde{B}^n}(x))$ for all $x \in X$ for Type-II

where $T_{\tilde{U}^n}(x)$, $I_{\tilde{U}^n}(x)$, $F_{\tilde{U}^n}(x)$ represent truth membership, indeterminacy-membership and falsity-membership functions of union of neutrosophic sets

Example:

Let $\tilde{A}^n = \langle 0.3, 0.4, 0.5 \rangle / x_1 + \langle 0.5, 0.2, 0.3 \rangle / x_2 + \langle 0.7, 0.2, 0.2 \rangle / x_3$ and

$\tilde{B}^n = \langle 0.6, 0.1, 0.2 \rangle / x_1 + \langle 0.3, 0.2, 0.6 \rangle / x_2 + \langle 0.4, 0.1, 0.5 \rangle / x_3$ be two neutrosophic sets. Then the union of \tilde{A}^n and \tilde{B}^n is a single valued neutrosophic set can be calculated for

Type -I as

$$\tilde{A}^n \cup \tilde{B}^n = \langle 0.6, 0.4, 0.2 \rangle / x_1 + \langle 0.5, 0.2, 0.3 \rangle / x_2 + \langle 0.7, 0.2, 0.2 \rangle / x_3 \quad (5)$$

and for Type -II as

$$\tilde{A}^n \cup \tilde{B}^n = \langle 0.6, 0.1, 0.2 \rangle / x_1 + \langle 0.5, 0.2, 0.3 \rangle / x_2 + \langle 0.7, 0.1, 0.2 \rangle / x_3 \quad (6)$$

2.5. Intersection of Neutrosophic Sets

The intersection of two single valued neutrosophic sets \tilde{A}^n and \tilde{B}^n is a single valued neutrosophic set \tilde{E}^n is denoted by

$$\tilde{E}^n = \tilde{A}^n \cap \tilde{B}^n = \{(x, T_{\tilde{E}^n}(x), I_{\tilde{E}^n}(x), F_{\tilde{E}^n}(x)) | x \in X\} \quad (7)$$

and is defined by the following conditions

- (i) $T_{\tilde{E}^n}(x) = \min(T_{\tilde{A}^n}(x), T_{\tilde{B}^n}(x))$,
- (ii) $I_{\tilde{E}^n}(x) = \min(I_{\tilde{A}^n}(x), I_{\tilde{B}^n}(x))$,

$$(iii) F_{\tilde{E}^n}(x) = \max(F_{\tilde{A}^n}(x), F_{\tilde{B}^n}(x)) \text{ for all } x \in X \text{ for Type-I}$$

Or, in another way by defining following conditions

$$(i) T_{\tilde{E}^n}(x) = \min(T_{\tilde{A}^n}(x), T_{\tilde{B}^n}(x)),$$

$$(ii) I_{\tilde{E}^n}(x) = \max(I_{\tilde{A}^n}(x), I_{\tilde{B}^n}(x))$$

$$(iii) F_{\tilde{E}^n}(x) = \max(F_{\tilde{A}^n}(x), F_{\tilde{B}^n}(x)) \text{ for all } x \in X \text{ for Type-II}$$

where $T_{\tilde{E}^n}(x)$, $I_{\tilde{E}^n}(x)$, $F_{\tilde{E}^n}(x)$ represent truth membership, indeterminacy-membership and falsity-membership functions of union of neutrosophic sets

Example:

Let $\tilde{A}^n = \langle 0.3, 0.4, 0.5 \rangle / x_1 + \langle 0.5, 0.2, 0.3 \rangle / x_2 + \langle 0.7, 0.2, 0.2 \rangle / x_3$ and

$\tilde{B}^n = \langle 0.6, 0.1, 0.2 \rangle / x_1 + \langle 0.3, 0.2, 0.6 \rangle / x_2 + \langle 0.4, 0.1, 0.5 \rangle / x_3$ be two neutrosophic sets. Then the union of \tilde{A}^n and \tilde{B}^n is a single valued neutrosophic set can be measured for

Type -I as

$$\tilde{A}^n \cap \tilde{B}^n = \langle 0.3, 0.1, 0.5 \rangle / x_1 + \langle 0.3, 0.2, 0.6 \rangle / x_2 + \langle 0.4, 0.1, 0.5 \rangle / x_3 \quad (8)$$

and for Type -II as

$$\tilde{A}^n \cap \tilde{B}^n = \langle 0.3, 0.4, 0.5 \rangle / x_1 + \langle 0.3, 0.2, 0.6 \rangle / x_2 + \langle 0.4, 0.2, 0.5 \rangle / x_3 \quad (9)$$

3 Mathematical Analysis

Decision making is nothing but a process of solving the problem that achieves goals under constraints. The outcome of the problem is a decision, which should in an action. Decision-making plays an important role in different subject such as field of economic and business, management sciences, engineering and manufacturing, social and political science, biology and medicine, military, computer science etc. It faces difficulty in progress due to factors like incomplete and imprecise information, which often present in real life situations. In the decision making process, the decision maker's main target is to find the value from the selected set with the highest degree of membership in the decision set and these values support the goals under constraints only. However, there may arise situations where some values from selected set cannot support, rather such values strongly against the goals under constraints, which are non-admissible. In this case, we find such values from the selected set with least degree of non-

membership in the decision sets. IFSs can only handle incomplete information not the indeterminate information and inconsistent information, which exists commonly belief in system. In neutrosophic set, indeterminacy is quantified explicitly and truth-membership, indeterminacy-membership and falsity-membership are independent to each other. Therefore, it is natural to adopt for that purpose the value from the selected set with highest degree of truth-membership, highest degree or least degree of indeterminacy-membership and least degree of falsity-membership on the decision set. These factors indicate that a decision making process takes place in neutrosophic environment.

3.1. Neutrosophic Optimization (NSO) Technique to Solve Single objective Nonlinear Programming Problem (SONLPP)

A Nonlinear Programming Problem (NLPP) may be considered in the following form

$$\text{Minimize } g(x) \tag{10}$$

Subject to,

$$g_j(x) \leq b_j; \quad j = 1, 2, \dots, m \tag{11}$$

$$x \geq 0 \tag{12}$$

Usually constraints goals are considered as fixed quantity. However, in real life problems, the constraint goals cannot be always exact. So we can consider the constraint goals for less than type constraints at least b_j and it may be possible to extend to $b_j + b_j^0$ for $j = 1, 2, \dots, m$. This fact seems to take the constraint goals as a neutrosophic set and it will be more realistic descriptions than others. Then NSO problem with neutrosophic goals can be described as follows

$$\text{Minimize } g(x) \tag{13}$$

Subject to,

$$g_j(x) \lesssim^n b_j, \quad j = 1, 2, \dots, m \tag{14}$$

$$x \geq 0 \text{ where } \lesssim^n \text{ represents inequality in neutrosophic sense.} \tag{15}$$

In the case of degree of falsity membership and indeterminacy membership it is to define simultaneously with degree of truth membership of the objective and constraint and while all these three degrees are independent of each other, NSO can be used as a more general tool to describing this uncertainty. Considering maximization of the degree of truth membership together with minimization or maximization of the degree of indeterminacy as per decision

maker's choice and minimizing degree of falsity membership of neutrosophic fuzzy objective and constraints, we can formulate a NSO technique to solve a Neutrosophic Nonlinear Programming(NSNLP)(Eq.13-Eq.15) problem.

To solve the NSNLP (Eq.13-Eq.15), following Warner's [40] and Angelov [39] we are presenting a solution procedure by successive steps as follows

Step-1: Following Warner's approach solve the SONLPP without tolerance in constraints (i.e $g_j(x) \leq b_j$), with tolerance of truth membership in constraints (i.e $g_j(x) \leq b_j + b_j^0$) by appropriate non-linear programming technique

Here they are,

Sub-problem-1

$$\text{Minimize } g(x) \tag{16}$$

Subject to,

$$g_j(x) \leq b_j; \quad j = 1, 2, \dots, m \tag{17}$$

$$x \geq 0 \tag{18}$$

Sub-problem-2

$$\text{Minimize } g(x) \tag{19}$$

Subject to,

$$g_j(x) \leq b_j + b_j^0, \quad j = 1, 2, \dots, m \tag{20}$$

$$x \geq 0 \tag{21}$$

we may get optimal solutions $x^* = x^1, g(x^*) = g(x^1)$ and $x^* = x^2, g(x^*) = g(x^2)$ for sub-problem 1 and 2 respectively.

Step-2: From the result of step 1 we now find the lower bound and upper bound of objective functions. Let $U_{g(x)}^T, U_{g(x)}^I, U_{g(x)}^F$ be the upper bounds of truth, indeterminacy, falsity membership function for the objective respectively and $L_{g(x)}^T, L_{g(x)}^I, L_{g(x)}^F$ be the lower bound of truth, indeterminacy, falsity membership functions of objective respectively using following rules

$$U_{g(x)}^T = \max \{g(x^1), g(x^2)\} \tag{22}$$

$$L_{g(x)}^T = \min \{g(x^1), g(x^2)\} \quad (23)$$

But in single valued NSO technique the degree of truth, indeterminacy and falsity membership are considered so that the sum of these degree of membership values are less than three. To define the falsity and indeterminacy membership function of NLP(Eq.10-Eq.12), let us consider $U_{g(x)}^F$, $L_{g(x)}^F$ and $U_{g(x)}^I$, $L_{g(x)}^I$ be the upper and lower bound of objective function $g(x)$ such that

$$U_{g(x)}^F = U_{g(x)}^T \quad (24)$$

$$L_{g(x)}^F = L_{g(x)}^T + t(U_{g(x)}^T - L_{g(x)}^T) \text{ where } 0 < t < 1 \quad (25)$$

$$L_{g(x)}^I = L_{g(x)}^T \quad (26)$$

$$U_{g(x)}^I = L_{g(x)}^T + s(U_{g(x)}^T - L_{g(x)}^T) \text{ where } 0 < s < 1 \quad (27)$$

The initial neutrosophic model (Model -I) with aspiration levels of objectives can be formulated as

$$\text{Find } x \quad (28)$$

So as to satisfy

$$g(x) \leq^n L_{g(x)}^T \text{ with tolerance } (U_{g(x)}^T - L_{g(x)}^T) \text{ for degree of truth membership} \quad (29)$$

$$g(x) \leq^n L_{g(x)}^I \text{ with tolerance } (U_{g(x)}^I - L_{g(x)}^I) \text{ for degree of indeterminacy membership} \quad (30)$$

$$g(x) \geq^n U_{g(x)}^F \text{ with tolerance } (U_{g(x)}^F - L_{g(x)}^F) \text{ for degree of falsity membership} \quad (31)$$

$$g_j(x) \leq^n b_j \text{ with tolerance } b_j^0 \text{ for degree of truth membership} \quad (32)$$

$$g_j(x) \leq^n b_j \text{ with tolerance } (\xi_{g_j(x)}) \text{ for degree of indeterminacy membership} \quad (33)$$

$$g_j(x) \geq^n b_j + b_j^0 \text{ with tolerance } ((b_j + b_j^0) - (b_j + \varepsilon_{g_j(x)})) \text{ for degree of falsity membership} \quad (34)$$

$$\text{For } j = 1, 2, \dots, m, \varepsilon_{g_j(x)} = t(U_{g_j(x)}^T - L_{g_j(x)}^T); t \in (0, 1)$$

$$\text{and } \xi_{g_j(x)} = s(U_{g_j(x)}^T - L_{g_j(x)}^T); s \in (0, 1)$$

and for Mode-II it can be formulated as

Find x (35)

So as to satisfy

$$g(x) \leq^n L_{g(x)}^T \text{ with tolerance } (U_{g(x)}^T - L_{g(x)}^T) \text{ for degree of truth membership} \quad (36)$$

$$g(x) \geq^n U_{g(x)}^I \text{ with tolerance } (U_{g(x)}^I - L_{g(x)}^I) \text{ for degree of indeterminacy membership} \quad (37)$$

$$g(x) \geq^n U_{g(x)}^F \text{ with tolerance } (U_{g(x)}^F - L_{g(x)}^F) \text{ for degree of falsity membership} \quad (38)$$

$$g_j(x) \leq^n b_j \text{ with tolerance } b_j^0 \text{ for degree of truth membership} \quad (39)$$

$$g_j(x) \geq^n (b_j + \xi_{g_j(x)}) \text{ with tolerance } (\xi_{g_j(x)}) \text{ for degree of indeterminacy membership} \quad (40)$$

$$g_j(x) \geq^n b_j + b_j^0 \text{ with tolerance } ((b_j + b_j^0) - (b_j + \varepsilon_{g_j(x)})) \text{ for degree of falsity membership} \quad (41)$$

$$\text{for } j = 1, 2, \dots, m, \varepsilon_{g_j(x)} = t(U_{g_j(x)}^T - L_{g_j(x)}^T); t \in (0, 1)$$

$$\text{and } \xi_{g_j(x)} = s(U_{g_j(x)}^T - L_{g_j(x)}^T); s \in (0, 1)$$

Here ' \geq^n ' denotes inequality in neutrosophic sense.

Step-3: Here for simplicity linear membership $T_{g(x)}$ for truth, $I_{g(x)}$ for indeterminacy and $F_{g(x)}$ for falsity membership functions of objective function are defined as follows

$$T_{g(x)}(g(x)) = \begin{cases} 1 & \text{if } g(x) \leq L_{g(x)}^T \\ \frac{U_{g(x)}^T - g(x)}{U_{g(x)}^T - L_{g(x)}^T} & \text{if } L_{g(x)}^T \leq g(x) \leq U_{g(x)}^T \\ 0 & \text{if } g(x) \geq U_{g(x)}^T \end{cases} \quad (42)$$

$$I_{g(x)}(g(x)) = \begin{cases} 1 & \text{if } g(x) \leq L_{g(x)}^I \\ \frac{U_{g(x)}^I - g(x)}{U_{g(x)}^I - L_{g(x)}^I} & \text{if } L_{g(x)}^I \leq g(x) \leq U_{g(x)}^I \\ 0 & \text{if } g(x) \geq U_{g(x)}^I \end{cases} \quad (43)$$

$$F_{g(x)}(g(x)) = \begin{cases} 0 & \text{if } g(x) \leq L_{g(x)}^F \\ \frac{g(x) - L_{g(x)}^F}{U_{g(x)}^F - L_{g(x)}^F} & \text{if } L_{g(x)}^F \leq g(x) \leq U_{g(x)}^F \\ 1 & \text{if } g(x) \geq U_{g(x)}^F \end{cases} \quad (44)$$

Step-4: In this step using linear membership function $T_{g_j(x)}$ for truth, $I_{g_j(x)}$ for indeterminacy and $F_{g_j(x)}$ for falsity membership functions we can calculate the membership functions of constraints as follows

$$T_{g_j(x)}(g_j(x)) = \begin{cases} 1 & \text{if } g_j(x) \leq b_j \\ \left(\frac{b_j + b_j^0 - g_j(x)}{b_j^0} \right) & \text{if } b_j \leq g_j(x) \leq b_j + b_j^0 \\ 0 & \text{if } g_j(x) \geq b_j + b_j^0 \end{cases} \quad (45)$$

$$I_{g_j(x)}(g_j(x)) = \begin{cases} 1 & \text{if } g_j(x) \leq b_j \\ \frac{(b_j + \xi_{g_j(x)}) - g_j(x)}{\xi_{g_j(x)}} & \text{if } b_j \leq g_j(x) \leq b_j + \xi_{g_j(x)} \\ 0 & \text{if } g_j(x) \geq b_j + \xi_{g_j(x)} \end{cases} \quad (46)$$

$$F_{g_j(x)}(g_j(x)) = \begin{cases} 0 & \text{if } g_j(x) \leq b_j + \varepsilon_{g_j(x)} \\ \frac{g_j(x) - b_j - \varepsilon_{g_j(x)}}{b_j^0 - \varepsilon_{g_j(x)}} & \text{if } b_j + \varepsilon_{g_j(x)} \leq g_j(x) \leq b_j + b_j^0 \\ 1 & \text{if } g_j(x) \geq b_j + b_j^0 \end{cases} \quad (47)$$

for $j = 1, 2, \dots, m$ $0 < \varepsilon_{g_j(x)}, \xi_{g_j(x)} < b_j^0$. and

Step-5: Now using NSO [31] for single objective optimization with linear truth, indeterminacy and falsity membership functions the NSNLP (Eq.13-Eq.15), can be formulated as

Model-I

$$\text{Maximize } (T_{g(x)}(g(x)), T_{g_j(x)}(g_j(x))) \quad (48)$$

$$\text{Maximize } (I_{g(x)}(g(x)), I_{g_j(x)}(g_j(x))) \quad (49)$$

$$\text{Minimize } (F_{g(x)}(g(x)), F_{g_j(x)}(g_j(x))) \quad (50)$$

Such that

$$T_{g(x)}(x) + I_{g(x)}(x) + F_{g(x)}(x) \leq 3; \quad (51)$$

$$T_{g_j}(x) + I_{g_j}(x) + F_{g_j}(x) \leq 3; \quad (52)$$

$$T_{g(x)}(x) \geq I_{g(x)}(x);$$

$$T_{g(x)}(x) \geq F_{g(x)}(x); \quad (53)$$

$$T_{g_j}(x) \geq I_{g_j}(x); \quad (54)$$

$$T_{g_j}(x) \geq F_{g_j}(x); \quad (55)$$

$$T_{g(x)}(x), I_{g(x)}(x), F_{g(x)}(x) \in [0, 1]$$

$$T_{g_j}(x), I_{g_j}(x), F_{g_j}(x) \in [0, 1]$$

$$x > 0 \quad j = 1, 2, \dots, m \quad (56)$$

Model-II

$$\text{Maximize } (T_{g(x)}(g(x)), T_{g_j(x)}(g_j(x))) \quad (57)$$

$$\text{Minimize } (I_{g(x)}(g(x)), I_{g_j(x)}(g_j(x))) \quad (58)$$

$$\text{Minimize } (F_{g(x)}(g(x)), F_{g_j(x)}(g_j(x))) \quad (59)$$

subject to the same constraints as Model-I

All these crisp nonlinear programming problems (Model -I), (Model-II) can be solved by appropriate mathematical algorithm.

4 Welded Beam Design (WBD) and its Optimization in Neutrosophic Environment

Welding, a process of joining metallic parts with the application of heat or pressure or the both, with or without added material, is an economical and efficient method for obtaining permanent joints in the metallic parts. These welded joints are generally used as a substitute for riveted joint or can be used as an alternative method for casting or forging. The welding processes can broadly be classified into following two groups, the welding process that uses heat alone to join two metallic parts and the welding process that uses a combination of heat

and pressure for joining (Bhandari. V. B). However, above all the design of welded beam should preferably be economical and durable one.

4.1 WBD Formulation

The optimum welded beam design(Fig. 1) can be formulated considering some design criteria such as cost of welding i.e cost function, shear stress, bending stress and deflection ,derived as follows

Cost Function Formulation

The performance index appropriate to this design is the cost of weld assembly. The major cost components of such an assembly are (i) set up labour cost, (ii) welding labour cost, (iii) material cost, i.e

$$C(X) \equiv C_0 + C_1 + C_2 \quad (60)$$

where, $C(X)$ = cost function; C_0 = set up cost; C_1 = welding labour cost; C_2 = material cost. Now

Set up cost C_0 : The company has chosen to make this component a weldment , because of the existence of a welding assembly line. Furthermore, assume that fixtures for set up and holding of the bar during welding are readily available. The cost C_0 can therefore be ignored in this particular total cost model.

Welding labour cost C_1 : Assume that the welding will be done by machine at a total cost of \$10/hr (including operating and maintenance expense). Furthermore suppose that the machine can lay down a cubic inch of weld in 6 min. The labour cost is then

$$C_1 = \left(10 \frac{\$}{hr}\right) \left(\frac{1}{60} \frac{\$}{min}\right) \left(6 \frac{min}{in^3}\right) V_w = 1 \left(\frac{\$}{in^3}\right) V_w \quad (61)$$

Where V_w = weld volume, in^3

$$\text{Material cost } C_2: C_2 = C_3 V_w + C_4 V_B \quad (62)$$

Where C_3 = cost per volume per weld material, $\$/in^3 = (0.37)(0.283)$; C_4 = cost per volume of bar stock, $\$/in^3 = (0.37)(0.283)$; V_B = volume of bar, in^3 .

From geometry $V_w = h^2 l$; volume of the weld material, in^3 ; $V_{weld} = x_1^2 x_2$ and $V_B = tb(L+l)$; volume of bar , in^3 $V_{bar} = x_3 x_4 (L + x_2)$.

Therefore cost function become

$$C(X) = h^2 l + C_3 h^2 l + C_4 tb(L+l) = 1.10471 x_1^2 x_2 + 0.04811 x_3 x_4 (14.0 + x_2) \quad (63)$$

Constraints Derivation from Engineering Relationship

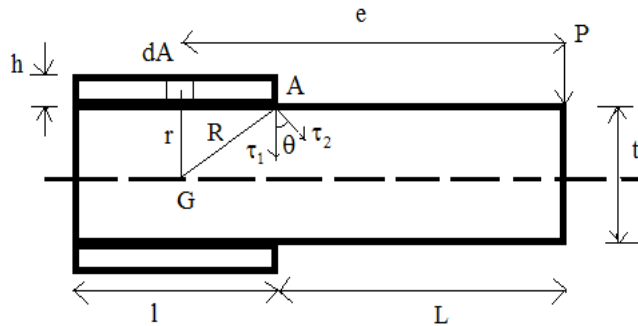

Fig. 1 Shear stresses in the weld group.

Maximum shear stress in weld group

To complete the model it is necessary to define important stress states

Direct or primary shear stress i.e

$$\tau_1 = \frac{\text{Load}}{\text{Throat area}} = \frac{P}{A} = \frac{P}{\sqrt{2}hl} = \frac{P}{\sqrt{2}x_1x_2} \quad (64)$$

Since the shear stress produced due to turning moment $M = Pe$ at any section, is proportional to its radial distance from centre of gravity of the joint 'G', therefore stress due to M is proportional to R and is in a direction at right angles to R .

In other words $\frac{\tau_2}{R} = \frac{\tau}{r} = \text{constant} \quad (65)$

$$\text{Therefore } R = \sqrt{\left(\frac{l}{2}\right)^2 + \left(\frac{h+t}{2}\right)^2} = \sqrt{\frac{x_2^2}{4} + \frac{(x_1+x_3)^2}{4}} \quad (66)$$

Where, τ_2 is the shear stress at the maximum distance R and τ is the shear stress at any distance r . Consider a small section of the weld having area dA at a distance r from 'G'. Therefore shear force on this small section $= \tau \times dA$ and turning moment of the shear force about centre of gravity is

$$dM = \tau \times dA \times r = \frac{\tau_2}{R} \times dA \times r^2 \quad (67)$$

Therefore total turning moment over the whole weld area

$$M = \frac{\tau_2}{R} \int dA \times r^2 = \frac{\tau_2}{R} J. \quad (68)$$

where J = polar moment of inertia of the weld group about centre of gravity.

Therefore shear stress due to the turning moment i.e.

$$\text{secondary shear stress, } \tau_2 = \frac{MR}{J} \quad (69)$$

In order to find the resultant stress, the primary and secondary shear stresses are combined vectorially. Therefore the maximum resultant shear stress that will be produced at the weld group, $\tau = \sqrt{\tau_1^2 + \tau_2^2 + 2\tau_1\tau_2 \cos \theta}$, (70)

where, θ = angle between τ_1 and τ_2 .

$$\text{As } \cos \theta = \frac{l/2}{R} = \frac{x_2}{2R}; \quad (71)$$

$$\tau = \sqrt{\tau_1^2 + \tau_2^2 + 2\tau_1\tau_2 \frac{x_2}{2R}}. \quad (72)$$

Now the polar moment of inertia of the throat area (A) about the centre of gravity is obtained by parallel axis theorem,

$$J = 2[I_{xx} + A \times x^2] = 2\left[\frac{A \times l^2}{12} + A \times x^2\right] = 2A\left(\frac{l^2}{12} + x^2\right) = 2\left\{\sqrt{2}x_1x_2\left[\frac{x_2^2}{12} + \frac{(x_1+x_3)^2}{2}\right]\right\} \quad (73)$$

where, A = throat area = $\sqrt{2}x_1x_2$, l = Length of the weld,

$$x = \text{Perpendicular distance between two parallel axes} = \frac{t}{2} + \frac{h}{2} = \frac{x_1+x_3}{2} \quad (74)$$

Maximum bending stress in beam

Now Maximum bending moment = PL , maximum bending stress = $\frac{T}{Z}$,

where $T = PL$;

Z = section modulus = $\frac{I}{y}$; I = moment of inertia = $\frac{bt^3}{12}$; y = distance of

extreme fibre from centre of gravity of cross section = $\frac{t}{2}$; Therefore $Z = \frac{bt^2}{6}$.

$$\text{So bar bending stress } \sigma(x) = \frac{T}{Z} = \frac{6PL}{bt^2} = \frac{6PL}{x_4x_3^2}. \quad (75)$$

Maximum deflection in beam

Maximum deflection at cantilever tip

$$\delta(x) = \frac{PL^3}{3EI} = \frac{PL^3}{3E \frac{bt^3}{12}} = \frac{4PL^3}{Ebt^3} = \frac{4PL^3}{Ex_4 x_3^2} \quad (76)$$

Buckling load of beam

$$\text{Buckling load can be approximated by } P_c(x) = \frac{4.013\sqrt{EIC}}{l^2} \left(1 - \frac{a}{l} \sqrt{\frac{EI}{C}} \right) \quad (77)$$

$$= \frac{4.013\sqrt{E \frac{t^2 b^6}{36}}}{L^2} \left(1 - \frac{t}{2L} \sqrt{\frac{E}{4G}} \right) = \frac{4.013\sqrt{EGx_3^6 x_4^6 / 36}}{L^2} \left(1 - \frac{x_3}{2L} \sqrt{\frac{E}{4G}} \right) \quad (78)$$

where, $I = \text{moment of inertia} = \frac{bt^3}{12}$; torsional rigidity $C = GJ = \frac{1}{3}tb^3G$; $l = L$; $a = \frac{t}{2}$.

4.2 Crisp Formulation of WBD

In design formulation a welded beam ([10], Fig. 2) has to be designed at minimum cost whose constraints are shear stress in weld (τ), bending stress in the beam (σ), buckling load on the bar (P), and deflection of the beam (δ). The

design variables are $\begin{bmatrix} x_1 \\ x_2 \\ x_3 \\ x_4 \end{bmatrix} = \begin{bmatrix} h \\ l \\ t \\ b \end{bmatrix}$ where h is the weld size, l is the length of the weld,

t is the depth of the welded beam, b is the width of the welded beam.

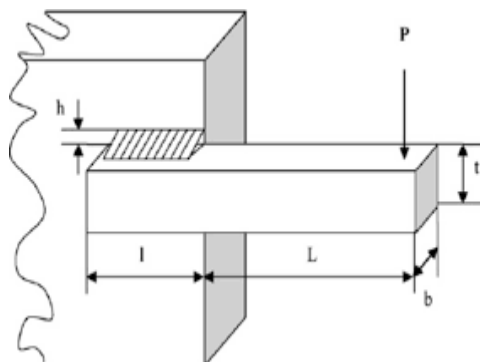

Fig.2 Design of the welded beam

The single-objective crisp welded beam optimization problem can be formulated as follows

$$\text{Minimize } C(X) \equiv 1.10471x_1^2x_2 + 0.04811(14 + x_2)x_3x_4 \quad (79)$$

such that

$$g_1(x) \equiv \tau(x) - \tau_{\max} \leq 0 \quad (80)$$

$$g_2(x) \equiv \sigma(x) - \sigma_{\max} \leq 0 \quad (81)$$

$$g_3(x) \equiv x_1 - x_4 \leq 0 \quad (82)$$

$$g_4(x) \equiv 0.10471x_1^2x_2 + 0.04811x_3x_4(14 + x_2) - 5 \leq 0 \quad (83)$$

$$g_5(x) \equiv 0.125 - x_1 \leq 0 \quad (84)$$

$$g_6(x) \equiv \delta(x) - \delta_{\max} \leq 0 \quad (85)$$

$$g_7(x) \equiv P - P_c(x) \leq 0 \quad (86)$$

$$x_1, x_2, x_3, x_4 \in [0, 1] \quad (87)$$

$$\text{where } \tau(x) = \sqrt{\tau_1^2 + 2\tau_1\tau_2\frac{x_2}{2R} + \tau_2^2} \quad ; \quad \tau_1 = \frac{P}{\sqrt{2}x_1x_2} \quad ; \quad \tau_2 = \frac{MR}{J} \quad ; \quad M = P\left(L + \frac{x_2}{2}\right);$$

$$R = \sqrt{\frac{x_2^2}{4} + \left(\frac{x_1 + x_3}{2}\right)^2} \quad ; \quad J = \left\{ \frac{x_1x_2}{\sqrt{2}} \left[\frac{x_2^2}{12} + \left(\frac{x_1 + x_3}{2}\right)^2 \right] \right\}; \quad \sigma(x) = \frac{6PL}{x_4x_3^2}; \quad \delta(x) = \frac{4PL^3}{Ex_4x_3^2};$$

$$P_c(x) = \frac{4.013\sqrt{EGx_3^6x_4^6/36}}{L^2} \left(1 - \frac{x_3}{2L} \sqrt{\frac{E}{4G}} \right) \text{ as derived as Eq.(70), Eq.(64), Eq.(69),}$$

Eq.(68), Eq.(66), Eq.(73), Eq.(75), , Eq.(76), , Eq.(78) respectively. Again P = Force on beam ; L = Beam length beyond weld; x_1 = Height of the welded beam; x_2 = Length of the welded beam; x_3 = Depth of the welded beam; x_4 = Width of the welded beam; $\tau(x)$ = Design shear stress; $\sigma(x)$ = Design normal stress for beam material; M = Moment of P about the centre of gravity of the weld , J = Polar moment of inertia of weld group; G = Shearing modulus of Beam Material; E = Young modulus; τ_{\max} = Design Stress of the weld; σ_{\max} = Design normal stress for the beam material; δ_{\max} = Maximum deflection; τ_1 = Primary stress on weld throat , τ_2 = Secondary torsional stress on weld.

4.3 WBD Formulation in Neutrosophic Environment

Sometimes slight change of stress or deflection enhances the weight of structures and indirectly cost of processing. In such situation when decision maker (DM) is in doubt to decide the stress constraint goal, the DM can induce the idea of acceptance boundary, hesitancy response or negative response margin of constraints goal. This fact seems to take the constraint goal as a NS instead of FS and IFS. It may be more realistic description than FS and IFS. When the shear stress, normal stress and deflection constraint goals are NS in nature the above crisp welded beam design (Eq.79-Eq.87) can be formulated as

$$\text{Minimize } C(X) \equiv 1.10471x_1^2x_2 + 0.04811(14 + x_2)x_3x_4 \quad (88)$$

Such that

$$g_1(x) \equiv \tau(x) \lesssim^n \tau_{\max} \quad (89)$$

$$g_2(x) \equiv \sigma(x) \lesssim^n \sigma_{\max} \quad (90)$$

$$g_3(x) \equiv x_1 - x_4 \leq 0 \quad (91)$$

$$g_4(x) \equiv 0.10471x_1^2x_2 + 0.04811x_3x_4(14 + x_2) - 5 \leq 0 \quad (92)$$

$$g_5(x) \equiv 0.125 - x_1 \leq 0 \quad (93)$$

$$g_6(x) \equiv \delta(x) \lesssim^n \delta_{\max} \quad (94)$$

$$g_7(x) \equiv P - P_c(x) \leq 0 \quad (95)$$

$$x_1, x_2, x_3, x_4 \in [0, 1] \quad (96)$$

Where all the parameters have their usual meaning as stated in sect.4.2. Here constraint goals are characterized by Neutrosophic Sets

$$\tilde{\tau}_{\max}^n = (\tau_{\max}(x_1, x_2), T_{\tau_{\max}}^n(\tau_{\max}(x_1, x_2)), I_{\tau_{\max}}^n(\tau_{\max}(x_1, x_2)), F_{\tau_{\max}}^n(\tau_{\max}(x_1, x_2))) \quad (97)$$

with $T_{\tau_{\max}}^n(\tau_{\max}(x_1, x_2))$, $I_{\tau_{\max}}^n(\tau_{\max}(x_1, x_2))$, $F_{\tau_{\max}}^n(\tau_{\max}(x_1, x_2))$ as the degree of truth, indeterminacy and falsity membership function of Neutrosophic set $\tilde{\tau}_{\max}^n$;

$$\tilde{\sigma}_{\max}^n = (\sigma_{\max}(x_3, x_4), T_{\sigma_{\max}}^n(\sigma_{\max}(x_3, x_4)), I_{\sigma_{\max}}^n(\sigma_{\max}(x_3, x_4)), F_{\sigma_{\max}}^n(\sigma_{\max}(x_3, x_4))) \quad (98)$$

with $T_{\sigma_{\max}}^n(\sigma_{\max}(x_3, x_4))$, $I_{\sigma_{\max}}^n(\sigma_{\max}(x_3, x_4))$, $F_{\sigma_{\max}}^n(\sigma_{\max}(x_3, x_4))$ as the degree of truth, indeterminacy and falsity membership function of Neutrosophic set $\tilde{\sigma}_{\max}^n$ and

$$\tilde{\delta}_{\max}^n = \left(\delta_{\max} (x_3, x_4), T_{\tilde{\delta}_{\max}^n} (\delta_{\max} (x_3, x_4)), I_{\tilde{\delta}_{\max}^n} (\delta_{\max} (x_3, x_4)), F_{\tilde{\delta}_{\max}^n} (\delta_{\max} (x_3, x_4)) \right) \quad (99)$$

with $T_{\tilde{\delta}_{\max}^n} (\delta_{\max} (x_3, x_4))$, $I_{\tilde{\delta}_{\max}^n} (\delta_{\max} (x_3, x_4))$, $F_{\tilde{\delta}_{\max}^n} (\delta_{\max} (x_3, x_4))$ as the degree of truth, indeterminacy and falsity membership function of Neutrosophic set $\tilde{\delta}_{\max}^n$

4.4 Optimization of WBD in Neutrosophic Environment

To solve the WBD (Eq.88-Eq.96), step 1 of sect.3.1 is used and we will get optimum solutions of two sub problem as X^1 and X^2 . After that according to step 2 we find upper and lower bound of membership function of objective

function as $U_{C(x)}^T, U_{C(x)}^I, U_{C(x)}^F$ and $L_{C(x)}^T, L_{C(x)}^I, L_{C(x)}^F$ where

$U_{C(x)}^T = \max \{C(X^1), C(X^2)\}$, $L_{C(x)}^T = \min \{C(X^1), C(X^2)\}$, Therefore

$$U_{C(x)}^F = U_{C(x)}^T, L_{C(x)}^F = L_{C(x)}^T + \varepsilon_{C(x)} \text{ where } 0 < \varepsilon_{C(x)} < (U_{C(x)}^T - L_{C(x)}^T) \quad (100)$$

$$L_{C(x)}^I = L_{C(x)}^T, U_{C(x)}^I = L_{C(x)}^T + \xi_{C(x)} \text{ where } 0 < \xi_{C(x)} < (U_{C(x)}^T - L_{C(x)}^T) \quad (101)$$

Let the linear membership functions for objective be,

$$T_{C(x)}(C(X)) = \begin{cases} 1 & \text{if } C(X) \leq L_{C(x)}^T \\ \left(\frac{U_{C(x)}^T - C(X)}{U_{C(x)}^T - L_{C(x)}^T} \right) & \text{if } L_{C(x)}^T \leq C(X) \leq U_{C(x)}^T \\ 0 & \text{if } C(X) \geq U_{C(x)}^T \end{cases} \quad (102)$$

$$I_{C(x)}(C(X)) = \begin{cases} 1 & \text{if } C(X) \leq L_{WT(A)}^T \\ \left(\frac{(L_{C(x)}^T + \xi_{C(x)}) - C(X)}{\xi_{C(x)}} \right) & \text{if } L_{C(x)}^T \leq C(X) \leq L_{C(x)}^T + \xi_{C(x)} \\ 0 & \text{if } WT(A) \geq L_{C(x)}^T + \xi_{C(x)} \end{cases} \quad (103)$$

$$F_{C(x)}(C(X)) = \begin{cases} 0 & \text{if } C(X) \leq L_{C(x)}^T + \varepsilon_{C(x)} \\ \left(\frac{C(X) - (L_{C(x)}^T + \varepsilon_{C(x)})}{U_{C(x)}^T - L_{C(x)}^T - \varepsilon_{C(x)}} \right) & \text{if } L_{C(x)}^T + \varepsilon_{C(x)} \leq C(X) \leq U_{C(x)}^T \\ 1 & \text{if } C(X) \geq U_{C(x)}^T \end{cases} \quad (104)$$

and constraints be,

$$T_{\sigma_i(X)}(\sigma_i(X)) = \begin{cases} 1 & \text{if } \sigma_i(X) \leq \sigma_i \\ \left(\frac{(\sigma_i + \sigma_i^0) - \sigma_i(X)}{\sigma_i^0} \right) & \text{if } \sigma_i \leq \sigma_i(X) \leq \sigma_i + \sigma_i^0 \\ 0 & \text{if } \sigma_i(X) \geq \sigma_i + \sigma_i^0 \end{cases} \quad (105)$$

$$I_{\sigma_i(X)}(\sigma_i(X)) = \begin{cases} 1 & \text{if } \sigma_i(X) \leq \sigma_i \\ \left(\frac{(\sigma_i + \xi_{\sigma_i(X)}) - \sigma_i(X)}{\xi_{\sigma_i(X)}} \right) & \text{if } \sigma_i \leq \sigma_i(X) \leq \sigma_i + \xi_{\sigma_i(X)} \\ 0 & \text{if } \sigma_i(X) \geq \sigma_i + \xi_{\sigma_i(X)} \end{cases} \quad (106)$$

$$F_{\sigma_i(X)}(\sigma_i(X)) = \begin{cases} 0 & \text{if } \sigma_i(X) \leq \sigma_i + \varepsilon_{\sigma_i(X)} \\ \left(\frac{\sigma_i(X) - \sigma_i - \varepsilon_{\sigma_i(X)}}{\sigma_i^0 - \varepsilon_{\sigma_i(X)}} \right) & \text{if } \sigma_i + \varepsilon_{\sigma_i(X)} \leq \sigma_i(X) \leq \sigma_i + \sigma_i^0 \\ 1 & \text{if } \sigma_i(X) \geq \sigma_i + \sigma_i^0 \end{cases} \quad (107)$$

for $j = 1, 2, \dots, m$ $0 < \varepsilon_{\sigma_i(X)}, \xi_{\sigma_i(X)} < \sigma_i^0$

Then NSO problem (Eq.88-Eq.96)), can be formulated as the following crisp linear programming problem by considering linear membership as follows,

Type-I

$$\text{Maximize } (\alpha - \beta + \gamma) \quad (108)$$

Such that

$$C(X) + \alpha(U_{C(X)}^T - L_{C(X)}^T) \leq U_{C(X)}^T; \quad (109)$$

$$C(X) + \gamma(U_{C(X)}^T - L_{C(X)}^T - \xi_{C(X)}) \leq L_{C(X)}^T + \xi_{C(X)}; \quad (110)$$

$$C(X) - \beta(U_{C(X)}^T - L_{C(X)}^T - \varepsilon_{C(X)}) \leq L_{C(X)}^T + \varepsilon_{C(X)}; \quad (111)$$

$$\sigma_i(X) + \alpha(U_{\sigma_i(X)}^T - L_{\sigma_i(X)}^T) \leq U_{\sigma_i(X)}^T; \quad (112)$$

$$\sigma_i(X) + \gamma(U_{\sigma_i(X)}^T - L_{\sigma_i(X)}^T - \xi_{\sigma_i(X)}) \leq U_{\sigma_i(X)}^T + \xi_{\sigma_i(X)}; \quad (113)$$

$$\sigma_i(X) - \beta(U_{\sigma_i(X)}^T - L_{\sigma_i(X)}^T - \varepsilon_{\sigma_i(X)}) \leq L_{\sigma_i(X)}^T + \varepsilon_{\sigma_i(X)}; \quad (114)$$

$$\alpha + \beta + \gamma \leq 3; \alpha \geq \beta; \alpha \geq \gamma; \alpha, \beta, \gamma \in [0, 1]$$

Model-II

$$\text{Maximize } (\alpha - \beta - \gamma) \tag{115}$$

Such that

$$C(X) + \alpha(U_{C(X)}^T - L_{C(X)}^T) \leq U_{C(X)}^T; \tag{116}$$

$$C(X) + \gamma \xi_{C(X)} \leq U_{C(X)}^T; \tag{117}$$

$$C(X) - \beta(U_{C(X)}^T - L_{C(X)}^T - \varepsilon_{C(X)}) \leq L_{C(X)}^T; \tag{118}$$

$$\sigma_i(X) + \alpha(U_{\sigma_i(X)}^T - L_{\sigma_i(X)}^T) \leq U_{\sigma_i(X)}^T; \tag{119}$$

$$\sigma_i(X) + \gamma \xi_{\sigma_i(X)} \leq U_{\sigma_i(X)}^T; \tag{120}$$

$$\sigma_i(X) - \beta(U_{\sigma_i(X)}^T - L_{\sigma_i(X)}^T - \varepsilon_{\sigma_i(X)}) \leq L_{\sigma_i(X)}^T; \tag{121}$$

$$\alpha + \beta + \gamma \leq 3; \alpha \geq \beta; \alpha \geq \gamma; \alpha, \beta, \gamma \in [0,1] \tag{122}$$

All these crisp nonlinear programming problem can be solved by appropriate mathematical algorithm.

5 Numerical Illustration

Input data of welded beam design problem(Eq.79-Eq.87) are given in Table 1as follows

Table 1 : Input data for neutrosophic model (Eqs.(88-96))

Applied load P (lb)	Beam length beyond weld L (in)	Young Modulus E (psi)	Value of G (psi)	Maximum allowable shear stress τ_{max} (psi)	Maximum allowable normal stress σ_{max} (psi)	Maximum allowable deflection δ_{max} (in)
6000	14	3×10^6	12×10^6	13600 with allowable tolerance 50	30000 with allowable tolerance 50	0.25 with allowable tolerance 0.05

Solution: According to step 2 of sect. 3.1, we find upper and lower bound of membership function of objective function as $U_{C(x)}^T, U_{C(x)}^I, U_{C(x)}^F$ and $L_{C(x)}^T, L_{C(x)}^I, L_{C(x)}^F$ where $U_{C(x)}^T = 1.861642 = U_{C(x)}^F, L_{C(x)}^T = 1.858613 = L_{C(x)}^I, L_{C(x)}^F = 1.858613 + \varepsilon_{C(x)}$, with $0 < \varepsilon_{C(x)} < .003029$; and $U_{C(x)}^I = L_{C(x)}^T + \xi_{C(x)}$ with $0 < \xi_{C(x)} < .003029$

Now using the bounds we calculate the membership functions for Model-I objective as follows

$$T_{C(x)}(C(X)) = \begin{cases} 1 & \text{if } C(X) \leq 1.858613 \\ \left(\frac{1.861642 - C(X)}{.003029} \right) & \text{if } 1.858613 \leq C(X) \leq 1.861642 \\ 0 & \text{if } C(X) \geq 1.861642 \end{cases} \quad (123)$$

$$I_{C(x)}(C(X)) = \begin{cases} 1 & \text{if } C(X) \leq 1.858613 \\ \left(\frac{(1.858613 + \xi_{C(x)}) - g(x)}{\xi_{C(x)}} \right) & \text{if } 1.858613 \leq C(X) \leq 1.858613 + \xi_{C(x)} \\ 0 & \text{if } C(X) \geq 1.858613 + \xi_{C(x)} \end{cases} \quad (124)$$

$$F_{C(x)}(C(X)) = \begin{cases} 0 & \text{if } C(X) \leq 1.858613 + \varepsilon_{C(x)} \\ \left(\frac{C(X) - 1.858613 - \varepsilon_{C(x)}}{.003029 - \varepsilon_{C(x)}} \right) & \text{if } 1.858613 + \varepsilon_{C(x)} \leq C(X) \leq 1.861642 \\ 1 & \text{if } C(X) \geq 1.861642 \end{cases} \quad (125)$$

similarly the membership functions for shear stress constraint are,

$$T_{g_1(x)}(g_1(x)) = \begin{cases} 1 & \text{if } g_1(x) \leq 13600 \\ \left(\frac{13600 - g_1(x)}{50} \right) & \text{if } 13600 \leq g_1(x) \leq 13650 \\ 0 & \text{if } g_1(x) \geq 13650 \end{cases} \quad (126)$$

$$I_{g_1(x)}(g_1(x)) = \begin{cases} 1 & \text{if } g_1(x) \leq 13600 \\ \left(\frac{(13600 + \xi_{g_1(x)}) - g_1(x)}{\xi_{g_1(x)}} \right) & \text{if } 13600 \leq g_1(x) \leq 13600 + \xi_{g_1(x)} \\ 0 & \text{if } g_1(x) \geq 13600 + \xi_{g_1(x)} \end{cases} \quad (127)$$

$$F_{g_1(x)}(g_1(x)) = \begin{cases} 0 & \text{if } g_1(x) \leq 13600 + \varepsilon_{g_1(x)} \\ \left(\frac{g_1(x) - 13600 - \varepsilon_{g_1(x)}}{50 - \varepsilon_{g_1(x)}} \right) & \text{if } 13600 + \varepsilon_{g_1(x)} \leq g_1(x) \leq 13650 \\ 1 & \text{if } g_1(x) \geq 13650 \end{cases} \quad (128)$$

where $0 < \varepsilon_{g_1(x)}, \xi_{g_1(x)} < .003209$

and the membership functions for normal stress constraint are,

$$T_{g_2(x)}(g_2(x)) = \begin{cases} 1 & \text{if } g_2(x) \leq 30000 \\ \left(\frac{30000 - g_2(x)}{50} \right) & \text{if } 30000 \leq g_2(x) \leq 30050 \\ 0 & \text{if } g_2(x) \geq 30050 \end{cases} \quad (129)$$

$$I_{g_2(x)}(g_2(x)) = \begin{cases} 1 & \text{if } g_2(x) \leq 30000 \\ \left(\frac{(30000 + \xi_{g_2(x)}) - g_2(x)}{\xi_{g_2(x)}} \right) & \text{if } 30000 \leq g_2(x) \leq 30000 + \xi_{g_2(x)} \\ 0 & \text{if } g_2(x) \geq 30000 + \xi_{g_2(x)} \end{cases} \quad (130)$$

$$F_{g_2(x)}(g_2(x)) = \begin{cases} 0 & \text{if } g_2(x) \leq 30000 + \varepsilon_{g_2(x)} \\ \left(\frac{g_2(x) - 30000 - \varepsilon_{g_2(x)}}{50 - \varepsilon_{g_2(x)}} \right) & \text{if } 30000 + \varepsilon_{g_2(x)} \leq g_2(x) \leq 30050 \\ 1 & \text{if } g_2(x) \geq 30050 \end{cases} \quad (131)$$

where $0 < \varepsilon_{g_2(x)}, \xi_{g_2(x)} < 50$

and the membership functions for deflection constraint are,

$$T_{g_6(x)}(g_6(x)) = \begin{cases} 1 & \text{if } g_6(x) \leq 0.25 \\ \left(\frac{0.25 - g_6(x)}{0.05} \right) & \text{if } 0.25 \leq g_6(x) \leq 0.3 \\ 0 & \text{if } g_6(x) \geq 0.3 \end{cases} \quad (132)$$

$$I_{g_6(x)}(g_6(x)) = \begin{cases} 1 & \text{if } g_6(x) \leq 0.25 \\ \left(\frac{(0.25 + \xi_{g_6(x)}) - g_6(x)}{\xi_{g_6(x)}} \right) & \text{if } 0.25 \leq g_6(x) \leq 0.25 + \xi_{g_6(x)} \\ 0 & \text{if } g_6(x) \geq 0.25 + \xi_{g_6(x)} \end{cases} \quad (133)$$

$$F_{g_6(x)}(g_6(x)) = \begin{cases} 0 & \text{if } g_6(x) \leq 0.25 + \varepsilon_{g_6(x)} \\ \left(\frac{g_6(x) - 0.25 - \varepsilon_{g_6(x)}}{0.05 - \varepsilon_{g_6(x)}} \right) & \text{if } 0.25 + \varepsilon_{g_6(x)} \leq g_6(x) \leq 0.3 \\ 1 & \text{if } g_6(x) \geq 0.3 \end{cases} \quad (134)$$

where $0 < \varepsilon_{g_6(x)}, \xi_{g_6(x)} < .05$

Similarly the truth, indeterminacy and falsity membership function can be calculated for objective and constraint functions. Now, using above mentioned truth, indeterminacy and falsity linear membership functions NLP (Eq.79-Eq.87)) can be solved for Model -I, Model-II, by fuzzy, intuitionistic fuzzy and NSO technique with different values of $\varepsilon_{C(x)}, \varepsilon_{g_1(x)}, \varepsilon_{g_2(x)}, \varepsilon_{g_6(x)}$ and $\xi_{C(x)}, \xi_{g_1(x)}, \xi_{g_2(x)}, \xi_{g_6(x)}$. The optimum height, length, depth, width and cost of welding of welded beam design (Eq.79-Eq.87) are given in Table 2 and the solution are compared with other deterministic optimization methods.

Table 2: Comparison of Optimal solution of welded beam design (Eq.79-Eq.87)) based on fuzzy and IF and NSO technique (Model - I and Model- II) with different methods

Methods	Height x_1 (inch)	Length x_2 (inch)	Depth x_3 (inch)	Width x_4 (inch)	Welding cost $C(X)$ \$
DAVID[10]	0.2434	6.2552	8.2915	0.2444	2.3841
APPROX[10]	0.2444	6.2189	8.2915	0.2444	2.3815
SIMPLEX[10]	0.2792	5.6256	7.7512	0.2796	2.5307
RANDOM[10]	0.4575	4.7313	5.0853	0.66	4.1185
Harmony Search Algorithm[11]	0.2442	6.2231	8.2915	0.2443	2.3807
GA Based Method[12]	0.2489	6.173	8.1789	0.2533	2.4328
GA Based Method[13]	0.2088	3.4205	8.9975	0.21	1.7483
Improved Harmony Search Algorithm[14]	0.20573	3.47049	9.03662	0.20573	1.72485
SiC-PSO[15]	0.205729	3.470488	9.036624	0.205729	1.724852
Mezura [16]	0.244438	6.237967	8.288576	0.244566	2.38119
COPSO[17]	0.205730	3.470489	9.036624	0.205730	1.724852
GA1[18]	0.208800	3.420500	8.997500	0.210000	1.748309
GA2[19]	0.205986	3.471328	9.020224	0.206480	1.728226
EP[20]	0.205700	3.470500	9.036600	0.205700	1.724852
CPSO[21]	0.202369	3.544214	9.048210	0.205723	1.728024
HPSO[22]	0.205730	3.470489	9.036624	0.205730	1.724852

NM-PSO[23]		0.205830	0.3.468338	9.036624	0.205730	1.724717
PSO[24]		0.206412	3.528353	8.988437	0.208052	1.742326
SA[24]		0.165306	5.294754	8.872164	0.217625	1.939196
GL[24]		0.204164	3.565391	9.05924	0.206216	1.7428
Cuckoo [24]		0.20573	3.519497	9.036624	0.20573	1.731527
FF[24]		0.214698	3.655292	8.507188	0.234477	1.864164
FP[24]		0.205729	3.519502	9.036628	0.20573	1.731528
ALO[24]		0.177859	4.393466	9.065462	0.20559	1.796793
GSA[24]		0.219556	4.728342	8.50097	0.271548	2.295076
MVO[24]		0.199033	3.652944	9.114448	0.205478	1.749834
Fuzzy single-objective non-linear programming [28]		.2444216	3.028584	8.283678	0.2444216	1.858613
Intuitionistic Fuzzy single-objective non-linear programming (FSONLP) [28]		.2443950	3.034430	8.287578	0.2443950	1.860125
$\varepsilon_{C(x)} = .0015, \varepsilon_{g_{1(x)}} = 25,$ $\varepsilon_{g_{2(x)}} = 25, \varepsilon_{g_{6(x)}} = .025,$						
Proposed Neutrosophic optimization(NSO)	Model-I	.2443950	3.034430	8.287578	0.2443950	1.860125
$\varepsilon_{C(x)} = .0015, \varepsilon_{g_{1(x)}} = 25,$ $\varepsilon_{g_{2(x)}} = 25, \varepsilon_{g_{6(x)}} = .025,$						
	Model-II	.2443950	3.034430	8.287578	0.2443950	1.860125
$\xi_{C(x)} = .0024, \xi_{g_{1(x)}} = 40,$ $\xi_{g_{2(x)}} = 40, \xi_{g_{6(x)}} = .04,$						

A detailed comparison has been made among several deterministic optimization methods for optimizing welding cost with imprecise optimization methods such as fuzzy, IF and NSO methods in Table 2. It has been observed that fuzzy nonlinear optimization provides better result in comparison with IF and NSO methods. Although it has been seen that cost of welding is minimum other than the method studied in this paper, as far as non-deterministic optimization methods concern ,fuzzy, IF and NSO are providing a valuable result in imprecise environment in this paper and literature. It has been seen that Improved Harmony Search Algorithm[14],COPSO[17],EP[20],HPSO[22] are providing minimum most cost of welding where all the parameters have been considered as exact in nature . However, it may also be noted that the efficiency of the proposed method depends on the model chosen to a greater extent because it is not always expected that NSO will provide better results over fuzzy and IF optimization . So overall NSO is an efficient method in finding best optimal solution in imprecise environment. It has been studied that same results have been obtained

while indeterminate membership tried to be maximize (Model- I) or minimize (Model-II) in NSO for this particular problem.

6 Conclusions and Future Work

In this paper, a single objective NSO algorithm has been developed by defining truth, indeterminacy and falsity membership function, which are independent to each other. Using this method firstly optimum height, length, depth, width and cost of welding have been calculated and finally the results are compared with different deterministic methods. So illustrated example of welded beam design has been provided to illustrate the optimization procedure, effectiveness and advantages of the proposed NSO method. The comparison of NSO technique with other optimization techniques has enhanced the acceptability of proposed method. The proposed procedure has not only validated by the existing methods but also it develops a new direction of optimization theory in imprecise environment, which is more realistic.

Acknowledgements

The research work of Mridula Sarkar is financed by Rajiv Gandhi National Fellowship (F1-17.1/2013-14-SC-wes-42549/(SA-III/Website)), Govt of India.

References

- [1] Zadeh, L.A. Fuzzy set. *Information and Control*.1965:8: 338-353.
- [2] Atanassov, K. T. Intuitionistic fuzzy sets. *Fuzzy Sets and Systems*. 1986:20 :87-96.
- [3] Angelov,P.P. Optimization in Intuitionistic Fuzzy Environment, *Fuzzy Sets and Systems* . 1997:86:299-306.
- [4] Wang, H., Smarandache, F., Zhang, Y. Q., Raman,R. Single valued neutrosophic sets, *Multispace and Multistructure*. 2010:4:410–413.
- [5] Wei Y. Qiu, J., Karimi, H. R., Wang ,Mao.: H_∞ model reduction for continuous-time Markovian jump systems with incomplete statistics of mode information. *International Journal of Systems Science*.2014: 45 :1496–1507.
- [6] Wei,Y. Qiu, J., Karimi, H. R. , Wang ,Mao.New results on H_1 dynamic output feedback control for Markovian jump systems with time-varying delay and defective mode information. *Optim. Control Appl. Meth.* 2014:35:656–675.
- [7] Wei,Y. Qiu, J., Karimi, H. R. , Wang, Mao. Filtering design for two-dimensional Markovian jump systems with state-delays and deficient mode information. *Information Sciences* .2014:269: 316–331.
- [8] Zimmermann, H.J.Fuzzy linear programming with several objective function. *Fuzzy sets and systems*.1978:1:45-55.
- [9] Ragsdell, K.M., Phillips, D.T. Optimal design of a class of welded structures using geometric programming, *ASME Journal of Engineering for Industries*, 1976:98 : 1021–1025.
- [10] Lee,K.S., Geem,Z.W. A new meta-heuristic algorithm for continuous engineering optimization: harmony search theory and practice.*Comput. Methods Appl. Mech. Engrg.* 2005:194 :3902–3933.

[11] Deb, K., Pratap, A., Moitra, S. Mechanical component design for multiple objectives using elitist non-dominated sorting GA. In Proceedings of the Parallel Problem Solving from Nature VI Conference, Paris.2000:16–20, 859–868.

[12] Coello, C.A.C. Use of a self-adaptive penalty approach for engineering optimization problems. *Comput. Ind.*2000b:41:113-127. DOI: 10.1016/S0166-3615(99)00046-9.

[13] Mahdavi, M., Fesanghary, M., Damangir, E. An improved harmony search algorithm for solving optimization problems. *Applied Mathematics and Computation*. 2007:188 :1567–1579.

[14] Carlos A. Coello Coello, Solving Engineering Optimization Problems with the Simple Constrained Particle Swarm Optimizer, *Informatica* .2008:32: 319–326.

[15] Coello, C.A.C., Montes, E.M. Useful infeasible solutions in engineering optimization with evolutionary algorithms. *Mexican International Conference on Artificial Intelligence*.2005: DOI: 10.1007/11579427_66.

[16] Aguirre,A.H.,Zavala,A.M.,Diharce,E.V.,Rionda,S.B.COPSO:Constrained Optimization via PSO Algorithm.Centre for Research in Mathematics(CIMAT).2007:Technical report No.I-07-04/22-02-2007.

[17] Coello Coello,C.A. Use of a self-adaptive penalty approach for engineering optimization problems.*Computers in Industry*.2000:41:113-127.

[18] Coello Coello, C.A., Montes, E.M. Constraint-handling techniques in genetic algorithms through dominance based tournament selection .*Advanced Engineering Informatics*.2002:16:193-203.

[19] Coello Coello, C.A., Becerra, R.L., Efficient evolutionary optimization through the use of a cultural algorithm. *Engineering Optimization*.2004:36:219-236.

[20] He, Q. Wang, L. An effective co-evolutionary particle swarm optimization for constrained engineering design problems.*Engineering Applications of Artificial Intelligence*.2007a:20:89-99.

[21] He, Q. Wang, L. A hybrid particle swarm optimization with a feasibility based rule for constrained optimization .*Applied Mathematics and Computation*. 2007b:186:1407-1422.

[22] Zahara,E., Kao,Y.T.Hybrid Nelder-mead simplex search and particle swarm optimization for constrained engineering design problems.*Expert System with Applications*.2009:36:3880-3886.

[23] David, D.C.N, Stephen, S.E.A, Ajoy.J.A. Cost minimization of welded beam design problem using PSO, SA, PS, GOLDLIKE, CUCKOO, FF, FP, ALO, GSA and MVO.*International Journal of Applied Mathematics*.2016:5:1-14.

[24] Wei, Y., Qiu, J., Karimi, H. R. Reliable Output Feedback Control of Discrete-Time Fuzzy Affine Systems With Actuator Faults.2016: Doi: 10.1109/TCSI.2016.2605685 :1-12.

[25] Wei ,Y., Qiu ,J., Lam,H.K., Wu,L., Approaches to T-S Fuzzy-Affine-Model-Based Reliable Output Feedback Control for Nonlinear It'o Stochastic Systems.2016 :DOI 10.1109/TFUZZ.2016.2566810: 1-14.

[26] Das, P., Roy,T.K.,Multi-objective non-linear programming problem based on Neutrosophic Optimization Technique and its application in Riser Design Problem. *Neutrosophic Sets and Systems*. 2015:9:88-95.

[27] Singh,B.; Sarkar,M.,Roy ,T. K.Intuitionistic Fuzzy Optimization of Truss Design:A Comparative Study.*International Journal of Computer &Organization Trends (IJCOT)*.2016:3:25-33.

[28] Sarkar,M. , Roy ,T. K. Intuitionistic Fuzzy Optimization on Structural Design:A Comparative Study.*International Journal of Innovative Research in Science,Engineering and Technology*.2016:5:18471-18482.

- [29] Sarkar, M., Roy, T. K. Truss Design Optimization with Imprecise Load and Stress in Intuitionistic Fuzzy Environment. *Journal of Ultra Scientist of Physical Sciences*. 2017:29:12-23.
- [30] Sarkar, M., Dey, S., Roy, T. K. Truss Design Optimization using Neutrosophic Optimization Technique. *Neutrosophic Sets and Systems*. 2016:13:62-69.
- [31] Sarkar, M., Roy, T. K. Truss Design Optimization using Neutrosophic Optimization Technique: A Comparative Study. *Advances in Fuzzy Mathematics*. 2017:12:411-438.
- [32] Sarkar, M.; Dey, S., Roy, T. K. Neutrosophic optimization technique and its application on structural design. *Journal of Ultra Scientist of Physical Sciences*. 2016:28:309-321.
- [33] Sarkar, M.; Dey, S., Roy, T. K. Multi-Objective Neutrosophic Optimization Technique and its Application to Structural Design. *International Journal of Computer Applications*, 2016:148:31-37.
- [34] Sarkar, M., Roy, T. K. Multi-Objective Welded Beam Optimization using Neutrosophic Goal Programming Technique. *Advances in Fuzzy Mathematics*. 2017:12:515-538.
- [35] Sarkar, M., Roy, T. K.: Truss Design Optimization with Imprecise Load and Stress in Neutrosophic Environment. *Advances in Fuzzy Mathematics*. 2017:12:439-474.
- [36] Sarkar, M., Roy, T. K. Optimization of Welded Beam with Imprecise Load and Stress by Parameterized Intuitionistic Fuzzy Optimization Technique. *Advances in Fuzzy Mathematics*. 2017:12:577-608.
- [37] Sarkar, M., Roy, T. K. Multi-Objective Welded Beam Design Optimization using T-Norm and T-Conorm based Intuitionistic Fuzzy Optimization Technique. *Advances in Fuzzy Mathematics*. 2017:12:549-575.
- [38] Angelov, P.P.: Optimization in Intuitionistic Fuzzy Environment, *Fuzzy Sets and Systems*. 1997:86:299-306.
- [39] Werner, B. Interactive Fuzzy Programming Systems, *Fuzzy Sets and Systems*. 1987:23:133-178.
- [40] Abdel-Basset, Mohamed, et al. "A novel group decision-making model based on triangular neutrosophic numbers." *Soft Computing* (2017): 1-15. DOI: <https://doi.org/10.1007/s00500-017-2758-5>
- [41] Hussian, Abdel-Nasser, et al. "Neutrosophic Linear Programming Problems." *Peer Reviewers*: 15.
- [42] Abdel-Basset, Mohamed, Mai Mohamed, and Arun Kumar Sangaiah. "Neutrosophic AHP-Delphi Group decision making model based on trapezoidal neutrosophic numbers." *Journal of Ambient Intelligence and Humanized Computing* (2017): 1-17. DOI: <https://doi.org/10.1007/s12652-017-0548-7>
- [43] Mohamed, Mai, et al. "Using Neutrosophic Sets to Obtain PERT Three-Times Estimates in Project Management." *Peer Reviewers*: 143.
- [44] Mohamed, Mai, et al. "Neutrosophic Integer Programming Problem." *Neutrosophic Sets & Systems* 15 (2017).
- [45] Abdel-Baset, Mohamed, Ibrahim M. Hezam, and Florentin Smarandache. "Neutrosophic goal programming." *Neutrosophic Sets Syst* 11 (2016): 112-118.
- [46] Hezam, Ibrahim M., Mohamed Abdel-Baset, and Florentin Smarandache. "Taylor series approximation to solve neutrosophic multiobjective programming problem." *Neutrosophic Sets and Systems* 10 (2015): 39-46.
- [47] El-Hefenawy, Nancy, et al. "A review on the applications of neutrosophic sets." *Journal of Computational and Theoretical Nanoscience* 13.1 (2016): 936-944.
- [48] Mridula Sarkar, Samir Dey, Tapan Kumar Roy: Truss Design Optimization using Neutrosophic Optimization Technique, *Neutrosophic Sets and Systems*, vol. 13, 2016, pp. 62-69. doi.org/10.5281/zenodo.570869

[49] Pintu Das, Tapan Kumar Roy: Multi-objective non-linear programming problem based on Neutrosophic Optimization Technique and its application in Riser Design Problem, *Neutrosophic Sets and Systems*, vol. 9, 2015, pp. 88-95. doi.org/10.5281/zenodo.571480

[50] Sabu Sebastian, Florentin Smarandache: Extension of Crisp Functions on Neutrosophic Sets, *Neutrosophic Sets and Systems*, vol. 17, 2017, pp. 88-92. http://doi.org/10.5281/zenodo.1012229

[51] Eman.M.El-Nakeeb, Hewayda ElGhawalby, A.A. Salama, S.A.El-Hafeez: Neutrosophic Crisp Mathematical Morphology, *Neutrosophic Sets and Systems*, Vol. 16 (2017), pp. 57-69. doi.org/10.5281/zenodo.831936

[52] A.A. Salama, Hewayda ElGhawalby, Shima Fathi Ali: Topological Manifold Space via Neutrosophic Crisp Set Theory, *Neutrosophic Sets and Systems*, vol. 15, 2017, pp. 18-21. doi.org/10.5281/zenodo.570946

V

Multi-Objective Neutrosophic Optimization Technique and Its Application to Riser Design Problem

Mridula Sarkar¹ • Pintu Das² • Tapan Kumar Roy³

¹Indian Institute of Engineering Science and Technology, Shibpur, P.O. Botanic Garden, Howrah, 711103, India. Email: mridula.sarkar86@rediffmail.com

²Sitananda College, Nandigram, Purba Medinipur, 721631, West Bengal, India.
Email: mepintudas@yahoo.com

³Indian Institute of Engineering Science and Technology, Shibpur, P.O. Botanic Garden, Howrah, 711103, India. Email: roy_t_k@yahoo.co.in

Abstract

This chapter aims to give computational algorithm to solve a multi-objective non-linear programming problem (MONLPP) using neutrosophic optimization method. The proposed method is for solving MONLPP with single valued neutrosophic data. A comparative study of optimal solution has been made between intuitionistic fuzzy and neutrosophic optimization technique. The developed algorithm has been illustrated by a numerical example. Finally optimal riser design problem is presented as an application of such technique.

Keywords

Neutrosophic Set, Single Valued Neutrosophic Set, Neutrosophic Optimization, Multi-Objective Riser Design optimization.

1 Introduction

The concepts of Fuzzy Sets were introduced by Zadeh in 1965[1]. Since the Fuzzy Sets and Fuzzy Logic have been applied in many real applications to handle uncertainty. The traditional fuzzy sets uses one real value $T_A(x) \in [0,1]$ to represent the Truth membership function of FS A defined on universe X . Sometimes $T_A(x)$ itself is uncertain and hard to be defined by a crisp value. So the concept of interval valued fuzzy sets was proposed [2] to capture the uncertainty of truth membership. In some applications we should consider not

only the truth membership supported by the evident but also the falsity membership against by the evident. That is beyond the scope of fuzzy sets and interval valued fuzzy sets. In 1986, Atanassov introduced the intuitionistic Fuzzy Sets [3], [5], which is a generalization of FS. The IFS consider both Truth membership and Falsity membership. Intuitionistic Fuzzy set can only handle incomplete information not the indeterminate information and inconsistent information. In neutrosophic sets indeterminacy is quantified explicitly and truth, indeterminacy and falsity membership functions are independent. Neutrosophic Set was first introduced by Smarandache in 1995 [4, 16-25].

The motivation of the present study is to give computational algorithm for multi-objective non-linear programming problem by single valued neutrosophic optimization approach. We also aim to study the impact of truth, indeterminacy and falsity membership functions in such optimization process and thus have made comparative study in intuitionistic fuzzy and neutrosophic optimization technique. Also as an application of such optimization technique optimal riser design problem is presented.

2 Mathematical Preliminaries

In the following, we briefly describe some basic concepts and basic operational laws related to neutrosophic set

2.1 Fuzzy Set(FS)

Let X be a fixed set. A fuzzy set \tilde{A} of X is an object having the form

$$\tilde{A} = \{(x, T_{\tilde{A}}(x)) | x \in X\} \quad (1)$$

where the function $T_{\tilde{A}} : X \rightarrow [0,1]$ stands for the truth membership of the element $x \in X$ to the set \tilde{A} .

2.2. Intuitionistic Fuzzy Set(IFS)

Let a set X be fixed. An intuitionistic fuzzy set or IFS \tilde{A}^i in X is an object of the form

$$\tilde{A}^i = \{(x, T_{\tilde{A}^i}(x), F_{\tilde{A}^i}(x)) | x \in X\} \quad (2)$$

where $T_{\tilde{A}^i} : X \rightarrow [0,1]$ and $F_{\tilde{A}^i} : X \rightarrow [0,1]$ define the truth membership and falsity membership respectively, for every element of $x \in X$ such that $0 \leq T_{\tilde{A}^i}(x) + F_{\tilde{A}^i}(x) \leq 1$.

2.3. Single-Valued Neutrosophic Set(SVNS)

Let a set X be the universe of discourse. A single valued neutrosophic set \tilde{A}^n over X is an object having the form

$$\tilde{A}^n = \left\{ \left(x, T_{\tilde{A}^n}(x), I_{\tilde{A}^n}(x), F_{\tilde{A}^n}(x) \right) \mid x \in X \right\} \quad (3)$$

where $T_{\tilde{A}^n} : X \rightarrow [0,1]$, $I_{\tilde{A}^n} : X \rightarrow [0,1]$ and $F_{\tilde{A}^n} : X \rightarrow [0,1]$ are truth, indeterminacy and falsity membership functions respectively so as to $0 \leq T_{\tilde{A}^n}(x) + I_{\tilde{A}^n}(x) + F_{\tilde{A}^n}(x) \leq 3$ for all $x \in X$.

2.4. Union of Neutrosophic Sets(NSs)

The union of two single valued neutrosophic sets \tilde{A}^n and \tilde{B}^n is a single valued neutrosophic set \tilde{U}^n denoted by

$$\tilde{U}^n = \tilde{A}^n \cup \tilde{B}^n = \left\{ \left(x, T_{\tilde{U}^n}(x), I_{\tilde{U}^n}(x), F_{\tilde{U}^n}(x) \right) \mid x \in X \right\} \quad (4)$$

and is defined by the following conditions

- (i) $T_{\tilde{U}^n}(x) = \max(T_{\tilde{A}^n}(x), T_{\tilde{B}^n}(x))$,
- (ii) $I_{\tilde{U}^n}(x) = \max(I_{\tilde{A}^n}(x), I_{\tilde{B}^n}(x))$,
- (iii) $F_{\tilde{U}^n}(x) = \min(F_{\tilde{A}^n}(x), F_{\tilde{B}^n}(x))$ for all $x \in X$ for Type-I

Or in another way by defining following conditions

- (i) $T_{\tilde{U}^n}(x) = \max(T_{\tilde{A}^n}(x), T_{\tilde{B}^n}(x))$,
- (ii) $I_{\tilde{U}^n}(x) = \min(I_{\tilde{A}^n}(x), I_{\tilde{B}^n}(x))$
- (iii) $F_{\tilde{U}^n}(x) = \min(F_{\tilde{A}^n}(x), F_{\tilde{B}^n}(x))$ for all $x \in X$ for Type-II

where $T_{\tilde{U}^n}(x)$, $I_{\tilde{U}^n}(x)$, $F_{\tilde{U}^n}(x)$ represent truth membership, indeterminacy-membership and falsity-membership functions of union of neutrosophic sets

Example:

Let $\tilde{A}^n = \langle 0.3, 0.4, 0.5 \rangle / x_1 + \langle 0.5, 0.2, 0.3 \rangle / x_2 + \langle 0.7, 0.2, 0.2 \rangle / x_3$ and

$\tilde{B}^n = \langle 0.6, 0.1, 0.2 \rangle / x_1 + \langle 0.3, 0.2, 0.6 \rangle / x_2 + \langle 0.4, 0.1, 0.5 \rangle / x_3$ be two neutrosophic sets. Then the union of \tilde{A}^n and \tilde{B}^n is a single valued neutrosophic set can be calculated for

Type -I as

$$\tilde{A}^n \cup \tilde{B}^n = \langle 0.6, 0.4, 0.2 \rangle / x_1 + \langle 0.5, 0.2, 0.3 \rangle / x_2 + \langle 0.7, 0.2, 0.2 \rangle / x_3 \quad (5)$$

and for Type -II as

$$\tilde{A}^n \cup \tilde{B}^n = \langle 0.6, 0.1, 0.2 \rangle / x_1 + \langle 0.5, 0.2, 0.3 \rangle / x_2 + \langle 0.7, 0.1, 0.2 \rangle / x_3 \quad (6)$$

2.5. Intersection of Neutrosophic Sets

The intersection of two single valued neutrosophic sets \tilde{A}^n and \tilde{B}^n is a single valued neutrosophic set \tilde{E}^n is denoted by

$$\tilde{E}^n = \tilde{A}^n \cap \tilde{B}^n = \left\{ (x, T_{\tilde{E}^n}(x), I_{\tilde{E}^n}(x), F_{\tilde{E}^n}(x)) \mid x \in X \right\} \quad (7)$$

and is defined by the following conditions

- (i) $T_{\tilde{E}^n}(x) = \min(T_{\tilde{A}^n}(x), T_{\tilde{B}^n}(x))$,
- (ii) $I_{\tilde{E}^n}(x) = \min(I_{\tilde{A}^n}(x), I_{\tilde{B}^n}(x))$,
- (iii) $F_{\tilde{E}^n}(x) = \max(F_{\tilde{A}^n}(x), F_{\tilde{B}^n}(x))$ for all $x \in X$ for Type-I

Or in another way by defining following conditions

- (i) $T_{\tilde{E}^n}(x) = \min(T_{\tilde{A}^n}(x), T_{\tilde{B}^n}(x))$,
- (ii) $I_{\tilde{E}^n}(x) = \max(I_{\tilde{A}^n}(x), I_{\tilde{B}^n}(x))$
- (iii) $F_{\tilde{E}^n}(x) = \max(F_{\tilde{A}^n}(x), F_{\tilde{B}^n}(x))$ for all $x \in X$ for Type-II

where $T_{\tilde{E}^n}(x)$, $I_{\tilde{E}^n}(x)$, $F_{\tilde{E}^n}(x)$ represent truth membership, indeterminacy-membership and falsity-membership functions of union of neutrosophic sets

Example:

Let $\tilde{A}^n = \langle 0.3, 0.4, 0.5 \rangle / x_1 + \langle 0.5, 0.2, 0.3 \rangle / x_2 + \langle 0.7, 0.2, 0.2 \rangle / x_3$ and

$\tilde{B}^n = \langle 0.6, 0.1, 0.2 \rangle / x_1 + \langle 0.3, 0.2, 0.6 \rangle / x_2 + \langle 0.4, 0.1, 0.5 \rangle / x_3$ be two neutrosophic sets. Then the union of \tilde{A}^n and \tilde{B}^n is a single valued neutrosophic set can be measured for

Type -I as

$$\tilde{A}^n \cap \tilde{B}^n = \langle 0.3, 0.1, 0.5 \rangle / x_1 + \langle 0.3, 0.2, 0.6 \rangle / x_2 + \langle 0.4, 0.1, 0.5 \rangle / x_3 \quad (8)$$

and for Type -II as

$$\tilde{A}^n \cap \tilde{B}^n = \langle 0.3, 0.4, 0.5 \rangle / x_1 + \langle 0.3, 0.2, 0.6 \rangle / x_2 + \langle 0.4, 0.2, 0.5 \rangle / x_3 \quad (9)$$

3 Neutrosophic Optimization Technique to solve Minimization Type Multi-Objective Non-linear Programming Problem

(P1)

A non-linear multi-objective optimization problem is of the form

$$\text{Minimize } \{f_1(x), f_2(x), \dots, f_p(x)\} \quad (10)$$

$$g_j(x) \leq b_j, \quad j=1, 2, \dots, q \quad (11)$$

Now the decision set \tilde{D}^n , a conjunction of neutrosophic objectives and constraints is defined as $\tilde{D}^n = \left(\bigcap_{k=1}^p \tilde{G}_k^n \right) \cap \left(\bigcap_{j=1}^q \tilde{C}_j^n \right) = \{x, T_{\tilde{D}^n}(x), I_{\tilde{D}^n}(x), F_{\tilde{D}^n}(x)\}$ (12)

Here

$$T_{\tilde{D}^n}(x) = \min \{T_{\tilde{G}_1^n}(x), T_{\tilde{G}_2^n}(x), \dots, T_{\tilde{G}_p^n}(x); T_{\tilde{C}_1^n}(x), T_{\tilde{C}_2^n}(x), \dots, T_{\tilde{C}_q^n}(x)\} \text{ for all } x \in X \quad (13)$$

$$I_{\tilde{D}^n}(x) = \min \{I_{\tilde{G}_1^n}(x), I_{\tilde{G}_2^n}(x), \dots, I_{\tilde{G}_p^n}(x); I_{\tilde{C}_1^n}(x), I_{\tilde{C}_2^n}(x), \dots, I_{\tilde{C}_q^n}(x)\} \text{ for all } x \in X \quad (14)$$

$$F_{\tilde{D}^n}(x) = \min \{F_{\tilde{G}_1^n}(x), F_{\tilde{G}_2^n}(x), \dots, F_{\tilde{G}_p^n}(x); F_{\tilde{C}_1^n}(x), F_{\tilde{C}_2^n}(x), \dots, F_{\tilde{C}_q^n}(x)\} \text{ for all } x \in X \quad (15)$$

where $T_{\tilde{D}^n}(x), I_{\tilde{D}^n}(x), F_{\tilde{D}^n}(x)$ are Truth membership function, Indeterminacy membership function, Falsity membership function of Neutrosophic decision set respectively. Now using the neutrosophic optimization the problem (P2) is transferred to the nonlinear programming problem as

(P2)

$$\text{Maximize } \alpha \quad (16)$$

$$\text{Minimize } \beta \quad (17)$$

$$\text{Maximize } \gamma \quad (18)$$

Such that

$$T_{\tilde{G}_k^n}(x) \geq \alpha \quad (19)$$

$$T_{\tilde{C}_j^n}(x) \geq \alpha \quad (20)$$

$$I_{\tilde{G}_j^n}(x) \geq \gamma \quad (21)$$

$$I_{\tilde{c}_j^n}(x) \geq \gamma \quad (22)$$

$$F_{\tilde{c}_k^n}(x) \leq \beta \quad (23)$$

$$F_{\tilde{c}_j^n}(x) \leq \beta \quad (24)$$

$$\alpha + \beta + \gamma \leq 3; \quad (25)$$

$$\alpha \geq \beta, \quad (26)$$

$$\alpha \geq \gamma \quad (27)$$

$$\alpha, \beta, \gamma \in [0, 1] \quad (28)$$

Now this non-linear programming problem (P2) can be easily solved by appropriate mathematical algorithm to give solution of multi-objective linear programming problem (P1) by neutrosophic optimization approach.

Computational Algorithm

Step-1 Solve the MONLP(1) as a single objective non-linear problem p times for each problem by taking one of the objectives at a time and ignoring the others. These solution are known as ideal solutions. Let x^k be the respective optimal solution for the k th different objective and evaluate each objective values for all these k th optimal solution.

Step-2 From the result of Step-1, determine the corresponding values for every objective for each derived solution. With the values of all objectives at each ideal solutions, pay-off matrix can be formulated as follows

$$\begin{bmatrix} f_1^*(x^1) & f_2(x^1) & \dots & f_p(x^1) \\ f_1(x^2) & f_2^*(x^2) & \dots & f_p(x^2) \\ \dots & \dots & \dots & \dots \\ f_1(x^p) & f_2(x^p) & \dots & f_p^*(x^p) \end{bmatrix}$$

Step-3 For each objective $f_k(x)$, the lower bound L_k^T and upper bound U_k^T as

$$U_k^T = \max \{f_k(x^{r*})\} \quad (29)$$

$$\text{and } L_k^T = \min \{f_k(x^{r*})\} \quad (30)$$

where $r = 1, 2, \dots, k$ for truth membership function of objectives.

Step-4 We represents upper and lower bounds for indeterminacy and falsity membership of objectives as follows

$$U_k^F = U_k^T \text{ and } L_k^F = L_k^T + (U_k^T - L_k^T) \quad (31)$$

$$U_k^I = U_k^T \text{ and } L_k^I = L_k^T + (U_k^T - L_k^T) \quad (32)$$

Here t and s are predetermined real number in $(0,1)$

Step-5 Define Truth membership, Inderminacy membership, Falsity membership functions as follows

$$T_k(f_k(x)) = \begin{cases} 1 & \text{if } f_k(x) \leq L_k^T \\ \frac{U_k^T - f_k(x)}{U_k^T - L_k^T} & \text{if } L_k^T \leq f_k(x) \leq U_k^T \\ 0 & \text{if } f_k(x) \geq U_k^T \end{cases} \quad (33)$$

$$I_k(f_k(x)) = \begin{cases} 1 & \text{if } f_k(x) \leq L_k^I \\ \frac{U_k^I - f_k(x)}{U_k^I - L_k^I} & \text{if } L_k^I \leq f_k(x) \leq U_k^I \\ 0 & \text{if } f_k(x) \geq U_k^I \end{cases} \quad (34)$$

$$F_k(f_k(x)) = \begin{cases} 1 & \text{if } f_k(x) \leq L_k^F \\ \frac{f_k(x) - L_k^F}{U_k^F - L_k^F} & \text{if } L_k^F \leq f_k(x) \leq U_k^F \\ 0 & \text{if } f_k(x) \geq U_k^F \end{cases} \quad (35)$$

Step-6 Now neutrosophic optimization method for MONLP problem gives an equivalent nonlinear-programing problem as

(P3)

$$\text{Max } (\alpha - \beta + \gamma) \quad (36)$$

Such that

$$T_k(f_k(x)) \geq \alpha; \quad (37)$$

$$I_k(f_k(x)) \geq \gamma; \quad (38)$$

$$F_k(f_k(x)) \leq \beta; \quad (39)$$

$$\alpha + \beta + \gamma \leq 3; \quad (40)$$

$$\alpha \geq \beta; \tag{41}$$

$$\alpha \geq \gamma; \tag{42}$$

$$\alpha, \beta, \gamma \in [0, 1]; \tag{43}$$

$$g_j(x) \leq b_j; x \geq 0 \tag{44}$$

$$k = 1, 2, \dots, p; j = 1, 2, \dots, q \tag{45}$$

Which is reduced to equivalent non-linear programming problem as

(P4)

$$\text{Max } (\alpha - \beta + \gamma) \tag{46}$$

Such that

$$f_k(x) + (U_k^T - L_k^T) \cdot \alpha \leq U_k^T \tag{47}$$

$$f_k(x) + (U_k^l - L_k^l) \cdot \gamma \leq U_k^l \tag{48}$$

$$f_k(x) - (U_k^F - L_k^F) \cdot \beta \leq L_k^F \tag{49}$$

$$\alpha + \beta + \gamma \leq 3; \tag{50}$$

$$\alpha \geq \beta; \tag{51}$$

$$\alpha \geq \gamma; \tag{52}$$

$$\alpha, \beta, \gamma \in [0, 1]; \tag{53}$$

$$g_j(x) \leq b_j; x \geq 0 \tag{54}$$

$$k = 1, 2, \dots, p; j = 1, 2, \dots, q$$

Mathematical Preliminaries

4 Illustrated Example

(P5)

$$\text{Min } f_1(x_1, x_2) = x_1^{-1} x_2^{-2} \tag{55}$$

$$\text{Min } f_2(x_1, x_2) = 2x_1^{-2} x_2^{-3} \tag{56}$$

Such that

$$x_1 + x_2 \leq 1 \tag{57}$$

$$x_1, x_2 \geq 0 \tag{58}$$

Solution: Here $L_1^T = 6.75$, $U_1^F = U_1^T = 6.94$ and $L_1^F = 6.75 + 0.19t$,
 $L_1^F = L_1^T = 6.75$, and $U_1^F = 6.75 + 0.19s$, $L_2^T = 57.87$, $L_2^F = L_2^T = 60.78$ and
 $L_2^F = 57.87 + 2.91t$, $L_2^F = L_2^T = 57.87$, and $U_2^F = 58.87 + 2.91s$. We take $t = 0.3$ and
 $s = 0.4$

Table 1 : Comparison of optimal solution by IFO and NSO Technique

Optimization Technique	Optimal Decision Variables x_1^*, x_2^*	Optimal Objective Functions f_1^*, f_2^*	Aspiration levels of Truth, Falsity and Indeterminacy Membership Functions	Sum of Optimal Objective Values
Intuitionistic Fuzzy Optimization(IFO)	0.3659009	6.797078	$\alpha^* = 0.719696$ $\beta^* = 0.022953$	65.588178
Proposed Neutrosophic Optimization (NSO)	0.6356811	58.79110	$\alpha^* = 0.7156984$ $\beta^* = 0.01653271$ $\gamma^* = 0.2892461$	65.487833

Table 1 shows that neutrosophic optimization technique gives better result than Intuitionistic Fuzzy Nonlinear Programming Technique.

5 Application of Neutrosophic Optimization in Riser Design Problem

The function of a riser is to supply additional molten metal to a casting to ensure a shrinkage porosity free casting. Shrinkage porosity occurs because of the increase in density from the liquid to solid state of metals. To be effective a riser must be solidify after casting and contain sufficient metal to feed the casting. Casting solidification time is predicted from Chvorinov's rule. Chvorinov's rule provides guidance on why risers are typically cylindrical. The longest solidification time for a given volume is the one where the shape of the part has the minimum surface area. From a practical standpoint cylinder has least surface area for its volume and easiest to make. Since the riser should solidify ³

A cylinder side riser which consists of a cylinder of height H and diameter D. The theoretical basis for riser design is Chvorinov's rule which is

$$t = k(V / SA)^2 \tag{59}$$

where t = solidification time (minutes/seconds), k = solidification constant for molding material (minutes/in² or seconds/cm²), V = riser volume (in³ or cm³), SA = cooling surface area of the riser.

The objective is to design the smallest riser such that $t_R \geq t_C$.where $t_R =$ solidification time of the riser, $t_C =$ solidification time of the casting,

$$K_R (V_R / SA_R)^2 \geq K_C (V_C / SA_C)^2 \quad (60)$$

The riser and casting are assumed to be molded in the same material so that K_R and K_C are equal .So $(V_R / SA_R) \geq (V_C / SA_C)$. (61)

The casting has a specified volume and surface area, so $V_C / SA_C = Y =$ constant, which is called the casting modulus.

$$V_C / SA_C \geq Y, V_R = \pi D_R^2 H_R / 4, SA_R = \pi D_R H_R + 2\pi D_R^2 / 4 \quad (62)$$

$$\text{Therefore } (\pi D_R^2 / 4) (\pi D_R H_R + 2\pi D_R^2 / 4) = (D_R H_R) / (4H_R + 2D_R) \geq Y \quad (63)$$

We take $V_C = 96$ cubic inch. $SA_C = 2(2.8 + 2.6 + 6.8) = 152$ square inch.

$$\text{Then, } \frac{49}{19} D_R^{-1} + \frac{24}{19} H_R^{-1} \leq 1 \quad (64)$$

Therefore Multi-objective cylindrical riser design problem can be stated as **(P6)**

$$\text{Minimize } V_R(D_R, H_R) = \pi D_R^2 H_R / 4 \quad (65)$$

$$\text{Minimize } t_R(D_R, H_R) = (D_R H_R) / (4H_R + 2D_R) \quad (66)$$

$$\text{Subject to } \frac{49}{19} D_R^{-1} + \frac{24}{19} H_R^{-1} \leq 1 \quad (67)$$

$$D_R, H_R > 0 \quad (68)$$

Here pay-off matrix is

$$\begin{matrix} & V_R & T_R \\ \begin{matrix} D_R \\ H_R \end{matrix} & \begin{bmatrix} 42.75642 & 0.631579 \\ 12.510209 & 0.6315786 \end{bmatrix} \end{matrix}$$

Table 2 : Values of Optimal Decision Variables and Objective Functions by Neutrosophic Optimization Technique

Optimal Decision variables	Optimal Objective Functions	Aspiration levels of Truth, Falsity and Indeterminacy Membership Functions
$D_R^* = 3.152158$	$V_R^*(D_R^*, H_R^*) = 24.60870$	$\alpha^* = 0.1428574$
$H_R^* = 3.152158$	$t_R^*(D_R^*, H_R^*) = 0.6315787$	$\beta^* = 0.1428574$
		$\gamma^* = 0.00001$

6 Conclusions and Future Work

In view of comparing the neutrosophic optimization with intuitionistic fuzzy optimization method, we also obtained the solution of the numerical problem by intuitionistic fuzzy optimization method [14] and took the best result obtained for comparison with present study is to give the effective algorithm for neutrosophic optimization method for getting optimal solutions to a Multi-objective non-linear programming problem. The comparisons of results obtained for undertaken problem clearly show the superiority of Neutrosophic Optimization over Intuitionistic Fuzzy Optimization. Finally, as an application of Neutrosophic Multi-objective Riser Design Problem is presented and using Neutrosophic Optimization algorithm an optimization algorithm is obtained.

Acknowledgement

The authors would like to thank the anonymous referees for their constructive comments and suggestions that have helped a lot to come up with this improved form of the chapter.

References

- [1] Zadeh, L. Fuzzy Sets, *Inform and Control* 1965:8:338-353.
- [2] Turksen, I. B. Interval valued fuzzy sets based on normal forms. *Fuzzy sets and systems*. 1986: 20(2): 191-210.
- [3] Atanassov, K. T. Intuitionistic fuzzy sets. *Fuzzy sets and Systems*. 1986: 20(1): 87-96.
- [4] Smarandache, F., *Unifying Field in Logics Neutrosophy: Neutrosophic Probability, Set and Logic*, Rehoboth, American Research Press.
- [5] Atanassov, K. T. More on intuitionistic fuzzy sets. *Fuzzy sets and systems*. 1989:33(1):37-45.
- [6] Wang, H., Smarandache, F., Zhang, Y., & Sunderraman, R. Single valued neutrosophic sets. *Review of the Air Force Academy*. 2010: (1): 10.
- [7] Smarandache, F. Neutrosophic set-a generalization of the intuitionistic fuzzy set. *International Journal of Pure and Applied Mathematics*, 2005:24(3): 287.
- [8] Bharati, S. K., & Singh, S. R. Solving multi objective linear programming problems using intuitionistic fuzzy optimization method: a comparative study. *International Journal of Modeling and Optimization*. 2014: 4(1):10.
- [9] Jana, B., & Roy, T. K. Multi-objective intuitionistic fuzzy linear programming and its application in transportation model. *Notes on Intuitionistic Fuzzy Sets*. 2007: 13(1): 34-51.
- [10] Mahapatra, G. S., Mitra, M., & Roy, T. K. Intuitionistic fuzzy multi-objective mathematical programming on reliability optimization model. *International journal of fuzzy systems*. 2010: 12(3): 259-266.
- [11] Zimmermann, H. J. Fuzzy programming and linear programming with several objective functions. *Fuzzy sets and systems* 1978: 1(1): 45-55.
- [12] Chvorinov, N. Control of the Solidification of Castings by Calculation. *Foundry Trade Journal*. 1939:70(8): 95-98.
- [13] Creese, R. C. Optimal riser design by geometric programming. *AFS cast metals research journal*. 1971: 7(2): 118-121.

- [14] Creese, R. C. Dimensioning of riser for long freezing range alloys by geometric programming. *AFS cast metals research journal* 1971: 7(4): 182-185.
- [15] Angelov, P. P. Optimization in an intuitionistic fuzzy environment. *Fuzzy sets and Systems*. 1997:86(3): 299-306.
- [16] Abdel-Basset, Mohamed, et al. "A novel group decision-making model based on triangular neutrosophic numbers." *Soft Computing* (2017): 1-15. DOI: <https://doi.org/10.1007/s00500-017-2758-5>
- [17] Hussian, Abdel-Nasser, et al. "Neutrosophic Linear Programming Problems." *Peer Reviewers*: 15.
- [18] Abdel-Basset, Mohamed, Mai Mohamed, Arun Kumar Sangaiah. "Neutrosophic AHP-Delphi Group decision making model based on trapezoidal neutrosophic numbers." *Journal of Ambient Intelligence and Humanized Computing* (2017): 1-17. DOI: <https://doi.org/10.1007/s12652-017-0548-7>
- [19] Mohamed, Mai, et al. "A Critical Path Problem in Neutrosophic Environment." *Peer Reviewers*: 167.
- [20] Mohamed, Mai, et al. "A Critical Path Problem Using Triangular Neutrosophic Number." *Peer Reviewers*: 155.
- [21] Mohamed, Mai, et al. "Using Neutrosophic Sets to Obtain PERT Three-Times Estimates in Project Management." *Peer Reviewers*: 143.
- [22] Mohamed, Mai, et al. "Neutrosophic Integer Programming Problem." *Neutrosophic Sets & Systems* 15 (2017).
- [23] Abdel-Baset, Mohamed, Ibrahim M. Hezam, and Florentin Smarandache. "Neutrosophic goal programming." *Neutrosophic Sets Syst* 11 (2016): 112-118.
- [24] Hezam, Ibrahim M., Mohamed Abdel-Baset, and Florentin Smarandache. "Taylor series approximation to solve neutrosophic multiobjective programming problem." *Neutrosophic Sets and Systems* 10 (2015): 39-46.
- [25] El-Hefenawy, Nancy, et al. "A review on the applications of neutrosophic sets." *Journal of Computational and Theoretical Nanoscience* 13.1 (2016): 936-944.
- [26] Mridula Sarkar, Samir Dey, Tapan Kumar Roy: Truss Design Optimization using Neutrosophic Optimization Technique, *Neutrosophic Sets and Systems*, vol. 13, 2016, pp. 62-69. doi.org/10.5281/zenodo.570869
- [27] Pintu Das, Tapan Kumar Roy: Multi-objective non-linear programming problem based on Neutrosophic Optimization Technique and its application in Riser Design Problem, *Neutrosophic Sets and Systems*, vol. 9, 2015, pp. 88-95. doi.org/10.5281/zenodo.571480
- [28] Naga Raju I, Rajeswara Reddy P, Dr. Diwakar Reddy V, Dr. Krishnaiah G: Real Life Decision Optimization Model, *Neutrosophic Sets and Systems*, vol. 14, 2016, pp. 71-79. doi.org/10.5281/zenodo.570889
- [29] Wenzhong Jiang, Jun Ye: Optimal Design of Truss Structures Using a Neutrosophic Number Optimization Model under an Indeterminate Environment, *Neutrosophic Sets and Systems*, vol. 14, 2016, pp. 93-97. doi.org/10.5281/zenodo.570888
- [30] Mona Gamal Gafar, Ibrahim El-Henawy: Integrated Framework of Optimization Technique and Information Theory Measures for Modeling Neutrosophic Variables, *Neutrosophic Sets and Systems*, vol. 15, 2017, pp. 80-89. doi.org/10.5281/zenodo.570939

VI

Truss Design Optimization using Neutrosophic Optimization Technique

Mridula Sarkar¹ ▪ Tapan Kumar Roy²

¹Indian Institute of Engineering Science and Technology, Shibpur, P.O-Botanic Garden, Howrah-711103,
India. Email: mridula.sarkar86@rediffmail.com

²Indian Institute of Engineering Science and Technology, Shibpur, P.O-Botanic Garden, Howrah-711103,
India. Email: roy_t_k@yahoo.co.in

Abstract

In this paper, we develop a neutrosophic optimization (NSO) approach for optimizing the design of plane truss structure with single objective subject to a specified set of constraints. In this optimum design formulation, the objective functions are the weight of the truss and the deflection of loaded joint; the design variables are the cross-sections of the truss members; the constraints are the stresses in members. A classical truss optimization example is presented here in to demonstrate the efficiency of the neutrosophic optimization approach. The test problem includes a two-bar planar truss subjected to a single load condition. This single-objective structural optimization model is solved by fuzzy and intuitionistic fuzzy optimization approach as well as neutrosophic optimization approach. Numerical example is given to illustrate our NSO approach. The result shows that the NSO approach is very efficient in finding the best discovered optimal solutions.

Keywords

Neutrosophic Set; Single Valued Neutrosophic Set; Neutrosophic Optimization; Non-linear Membership Function; Structural Optimization.

1 Introduction

In the field of civil engineering, nonlinear structural design optimizations are of great of importance. Therefore, the description of structural geometry and mechanical properties like stiffness are required for a structural system. However,

the system description and system inputs may not be exact due to human errors or some unexpected situations. At this juncture fuzzy set theory provides a method which deal with ambiguous situations like vague parameters, non-exact objective and constraint. In structural engineering design problems, the input data and parameters are often fuzzy/imprecise with nonlinear characteristics that necessitate the development of fuzzy optimum structural design method. Fuzzy set (FS) theory has long been introduced to handle inexact and imprecise data by Zadeh [2], Later on Bellman and Zadeh [4] used the fuzzy set theory to the decision making problem. The fuzzy set theory also found application in structural design. Several researchers like Wang et al. [8] first applied α -cut method to structural designs where the non-linear problems were solved with various design levels α , and then a sequence of solutions were obtained by setting different level-cut value of α . Rao [3] applied the same α -cut method to design a four-bar mechanism for function generating problem. Structural optimization with fuzzy parameters was developed by Yeh et al. [9]. Xu [10] used two-phase method for fuzzy optimization of structures. Shih et al. [5] used level-cut approach of the first and second kind for structural design optimization problems with fuzzy resources. Shih et al. [6] developed an alternative α -level-cuts methods for optimum structural design with fuzzy resources. Dey et al. [11] used generalized fuzzy number in context of a structural design. Dey et al used basic t-norm based fuzzy optimization technique for optimization of structure. Dey et al. [13] developed parameterized t-norm based fuzzy optimization method for optimum structural design. Also, Dey et.al [14] Optimized shape design of structural model with imprecise coefficient by parametric geometric programming. In such extension, Atanassov [1] introduced Intuitionistic fuzzy set (IFS) which is one of the generalizations of fuzzy set theory and is characterized by a membership function, a non- membership function and a hesitancy function. In fuzzy sets the degree of acceptance is only considered but IFS is characterized by a membership function and a non-membership function so that the sum of both values is less than one. A transportation model was solved by Jana et al.[15]using multi-objective intuitionistic fuzzy linear programming. Dey et al. [12] solved two bar truss non-linear problem by using intuitionistic fuzzy optimization problem. Dey et al. [16] used intuitionistic fuzzy optimization technique for multi objective optimum structural design. Intuitionistic fuzzy sets consider both truth membership and falsity membership. Intuitionistic fuzzy sets can only handle incomplete information not the indeterminate information and inconsistent information. In neutrosophic sets indeterminacy is quantified explicitly and truth membership, indeterminacy membership and falsity membership are independent. Neutrosophic theory was introduced by Smarandache [7,18-27]. The motivation of the present study is to give computational algorithm for solving multi-objective structural problem by single

valued neutrosophic optimization approach. Neutrosophic optimization technique is very rare in application to structural optimization. We also aim to study the impact of truth membership, indeterminacy membership and falsity membership function in such optimization process. The results are compared numerically both in fuzzy optimization technique, intuitionistic fuzzy optimization technique and neutrosophic optimization technique. From our numerical result, it is clear that neutrosophic optimization technique provides better results than fuzzy optimization and intuitionistic fuzzy optimization.

2 Single-objective Structural Model

In sizing optimization problems, the aim is to minimize single objective function, usually the weight of the structure under certain behavioral constraints on constraint and displacement. The design variables are most frequently chosen to be dimensions of the cross sectional areas of the members of the structures. Due to fabrications limitations the design variables are not continuous but discrete for belongingness of cross-sections to a certain set. A discrete structural optimization problem can be formulated in the following form

$$\text{Minimize } WT(A) \tag{1}$$

$$\text{subject to } \sigma_i(A) \leq 0, i = 1, 2, \dots, m \tag{2}$$

$$A_j \in R^d, \quad j = 1, 2, \dots, n \tag{3}$$

where $WT(A)$ represents objective function, $\sigma_i(A)$ is the behavioral constraints, m and n are the number of constraints and design variables respectively. A given set of discrete value is expressed by R^d and in this paper objective function is taken as $WT(A) = \sum_{i=1}^m \rho_i l_i A_i$ and constraint are chosen to be stress of structures as follows $\sigma_i(A) \leq \sigma_i$ with allowable tolerance σ_i^0 for $i = 1, 2, \dots, m$ where ρ_i and l_i are weight of unit volume and length of i^{th} element respectively, m is the number of structural element, σ_i and σ_i^0 are the i^{th} stress ,allowable stress respectively.

2 Mathematical Preliminaries

In the following, we briefly describe some basic concepts and basic operational laws related to neutrosophic set

2.1 Fuzzy Set (FS)

Let X be a fixed set. A fuzzy set \tilde{A} of X is an object having the form

$$\tilde{A} = \{(x, T_{\tilde{A}}(x)) | x \in X\} \quad (4)$$

where the function $T_{\tilde{A}} : X \rightarrow [0,1]$ stands for the truth membership of the element $x \in X$ to the set \tilde{A} .

2.2. Intuitionistic Fuzzy Set (IFS)

Let a set X be fixed. An intuitionistic fuzzy set or IFS \tilde{A}^i in X is an object of the form $\tilde{A}^i = \{(x, T_{\tilde{A}^i}(x), F_{\tilde{A}^i}(x)) | x \in X\}$ (5)

where $T_{\tilde{A}^i} : X \rightarrow [0,1]$ and $F_{\tilde{A}^i} : X \rightarrow [0,1]$ define the truth membership and falsity membership respectively, for every element of $x \in X$ such that $0 \leq T_{\tilde{A}^i}(x) + F_{\tilde{A}^i}(x) \leq 1$.

2.3. Single-Valued Neutrosophic Set (SVNS)

Let a set X be the universe of discourse. A single valued neutrosophic set \tilde{A}^n over X is an object having the form

$$\tilde{A}^n = \{(x, T_{\tilde{A}^n}(x), I_{\tilde{A}^n}(x), F_{\tilde{A}^n}(x)) | x \in X\} \quad (6)$$

where $T_{\tilde{A}^n} : X \rightarrow [0,1]$, $I_{\tilde{A}^n} : X \rightarrow [0,1]$ and $F_{\tilde{A}^n} : X \rightarrow [0,1]$ are truth, indeterminacy and falsity membership functions respectively so as to $0 \leq T_{\tilde{A}^n}(x) + I_{\tilde{A}^n}(x) + F_{\tilde{A}^n}(x) \leq 3$ for all $x \in X$.

2.4. Union of Neutrosophic Sets (NSs)

The union of two single valued neutrosophic sets \tilde{A}^n and \tilde{B}^n is a single valued neutrosophic set \tilde{U}^n denoted by

$$\tilde{U}^n = \tilde{A}^n \cup \tilde{B}^n = \{(x, T_{\tilde{U}^n}(x), I_{\tilde{U}^n}(x), F_{\tilde{U}^n}(x)) | x \in X\} \quad (7)$$

and is defined by the following conditions

$$(i) T_{\tilde{U}^n}(x) = \max(T_{\tilde{A}^n}(x), T_{\tilde{B}^n}(x)),$$

$$(ii) I_{\tilde{U}^n}(x) = \max(I_{\tilde{A}^n}(x), I_{\tilde{B}^n}(x)),$$

$$(iii) F_{\tilde{U}^n}(x) = \min(F_{\tilde{A}^n}(x), F_{\tilde{B}^n}(x)) \text{ for all } x \in X \text{ for Type-I}$$

Or in another way by defining following conditions

- (i) $T_{\tilde{U}^n}(x) = \max(T_{\tilde{A}^n}(x), T_{\tilde{B}^n}(x))$,
- (ii) $I_{\tilde{U}^n}(x) = \min(I_{\tilde{A}^n}(x), I_{\tilde{B}^n}(x))$
- (iii) $F_{\tilde{U}^n}(x) = \min(F_{\tilde{A}^n}(x), F_{\tilde{B}^n}(x))$ for all $x \in X$ for Type-II

where $T_{\tilde{U}^n}(x)$, $I_{\tilde{U}^n}(x)$, $F_{\tilde{U}^n}(x)$ represent truth membership, indeterminacy-membership and falsity-membership functions of union of neutrosophic sets

Example:

Let $\tilde{A}^n = \langle 0.3, 0.4, 0.5 \rangle / x_1 + \langle 0.5, 0.2, 0.3 \rangle / x_2 + \langle 0.7, 0.2, 0.2 \rangle / x_3$ and

$\tilde{B}^n = \langle 0.6, 0.1, 0.2 \rangle / x_1 + \langle 0.3, 0.2, 0.6 \rangle / x_2 + \langle 0.4, 0.1, 0.5 \rangle / x_3$ be two neutrosophic sets. Then the union of \tilde{A}^n and \tilde{B}^n is a single valued neutrosophic set can be calculated for

Type -I as

$$\tilde{A}^n \cup \tilde{B}^n = \langle 0.6, 0.4, 0.2 \rangle / x_1 + \langle 0.5, 0.2, 0.3 \rangle / x_2 + \langle 0.7, 0.2, 0.2 \rangle / x_3 \quad (8)$$

and for Type -II as

$$\tilde{A}^n \cup \tilde{B}^n = \langle 0.6, 0.1, 0.2 \rangle / x_1 + \langle 0.5, 0.2, 0.3 \rangle / x_2 + \langle 0.7, 0.1, 0.2 \rangle / x_3 \quad (9)$$

2.5. Intersection of Neutrosophic Sets

The intersection of two single valued neutrosophic sets \tilde{A}^n and \tilde{B}^n is a single valued neutrosophic set \tilde{E}^n is denoted by

$$\tilde{E}^n = \tilde{A}^n \cap \tilde{B}^n = \{ (x, T_{\tilde{E}^n}(x), I_{\tilde{E}^n}(x), F_{\tilde{E}^n}(x)) | x \in X \} \quad (10)$$

and is defined by the following conditions

- (i) $T_{\tilde{E}^n}(x) = \min(T_{\tilde{A}^n}(x), T_{\tilde{B}^n}(x))$,
- (ii) $I_{\tilde{E}^n}(x) = \min(I_{\tilde{A}^n}(x), I_{\tilde{B}^n}(x))$,
- (iii) $F_{\tilde{E}^n}(x) = \max(F_{\tilde{A}^n}(x), F_{\tilde{B}^n}(x))$ for all $x \in X$ for Type-I

Or in another way by defining following conditions

- (i) $T_{\tilde{E}^n}(x) = \min(T_{\tilde{A}^n}(x), T_{\tilde{B}^n}(x))$,
- (ii) $I_{\tilde{E}^n}(x) = \max(I_{\tilde{A}^n}(x), I_{\tilde{B}^n}(x))$

$$(iii) F_{\tilde{E}^n}(x) = \max(F_{\tilde{A}^n}(x), F_{\tilde{B}^n}(x)) \text{ for all } x \in X \text{ for Type-II}$$

where $T_{\tilde{E}^n}(x)$, $I_{\tilde{E}^n}(x)$, $F_{\tilde{E}^n}(x)$ represent truth membership, indeterminacy-membership and falsity-membership functions of union of neutrosophic sets

Example:

Let $\tilde{A}^n = \langle 0.3, 0.4, 0.5 \rangle / x_1 + \langle 0.5, 0.2, 0.3 \rangle / x_2 + \langle 0.7, 0.2, 0.2 \rangle / x_3$ and

$\tilde{B}^n = \langle 0.6, 0.1, 0.2 \rangle / x_1 + \langle 0.3, 0.2, 0.6 \rangle / x_2 + \langle 0.4, 0.1, 0.5 \rangle / x_3$ be two neutrosophic sets. Then the union of \tilde{A}^n and \tilde{B}^n is a single valued neutrosophic set can be measured for

Type -I as

$$\tilde{A}^n \cap \tilde{B}^n = \langle 0.3, 0.1, 0.5 \rangle / x_1 + \langle 0.3, 0.2, 0.6 \rangle / x_2 + \langle 0.4, 0.1, 0.5 \rangle / x_3 \quad (11)$$

and for Type -II as

$$\tilde{A}^n \cap \tilde{B}^n = \langle 0.3, 0.4, 0.5 \rangle / x_1 + \langle 0.3, 0.2, 0.6 \rangle / x_2 + \langle 0.4, 0.2, 0.5 \rangle / x_3 \quad (12)$$

3 Mathematical Analysis

3.1. Neutrosophic Optimization Technique to Solve Minimization Type Single-Objective Non-linear Programming Problem

Let a nonlinear single-objective optimization problem be

$$\text{Minimize } f(x) \quad (13)$$

Such that

$$g_j(x) \leq b_j \quad j = 1, 2, \dots, m$$

$$x \geq 0$$

Usually constraints goals are considered as fixed quantity .But in real life problem, the constraint goal cannot be always exact. Therefore, we can consider the constraint goal for less than type constraints at least b_j and it may possible

to extend to $b_j + b_j^0$. This fact seems to take the constraint goal as a neutrosophic fuzzy set and which will be more realistic descriptions than others. Then the NLP becomes NSO problem with neutrosophic resources, which can be described as follows

$$\text{Minimize } f(x) \quad (14)$$

Such that

$$g_j(x) \leq \tilde{b}_j^n \quad j = 1, 2, \dots, m$$

$$x \geq 0$$

To solve the NSO (13), we are presenting a solution procedure for single-objective NSO problem (13) as follows

Step-1: Following warner's approach solve the single objective non-linear programming problem without tolerance in constraints (i.e $g_j(x) \leq b_j$), with tolerance of acceptance in constraints (i.e $g_j(x) \leq b_j + b_j^0$) by appropriate non-linear programming technique

Here they are

Sub-problem-1

$$\text{Minimize } f(x) \tag{15}$$

Such that

$$g_j(x) \leq b_j \quad j = 1, 2, \dots, m$$

$$x \geq 0$$

Sub-problem-2

$$\text{Minimize } f(x) \tag{16}$$

Such that

$$g_j(x) \leq b_j + b_j^0, \quad j = 1, 2, \dots, m$$

$$x \geq 0$$

We may get optimal solution $x^* = x^1, f(x^*) = f(x^1)$ and $x^* = x^1, f(x^*) = f(x^1)$

Step-2: From the result of step 1 we now find the lower bound and upper bound of objective functions. If $U_{f(x)}^T, U_{f(x)}^I, U_{f(x)}^F$ be the upper bounds of truth, indeterminacy, falsity function for the objective respectively and $L_{f(x)}^T, L_{f(x)}^I, L_{f(x)}^F$ be the lower bound of truth, indeterminacy, falsity membership functions of objective respectively.

then

$$\begin{aligned}
 U_{f(x)}^F &= U_{f(x)}^T, L_{f(x)}^F = L_{f(x)}^T + \varepsilon_{f(x)} \quad \text{where } 0 < \varepsilon_{f(x)} < (U_{f(x)}^T - L_{f(x)}^T) \\
 U_{f(x)}^F &= U_{f(x)}^T, L_{f(x)}^F = L_{f(x)}^T + \varepsilon_{f(x)} \quad \text{where } 0 < \varepsilon_{f(x)} < (U_{f(x)}^T - L_{f(x)}^T) \\
 L_{f(x)}^I &= L_{f(x)}^T, U_{f(x)}^I = L_{f(x)}^T + \xi_{f(x)} \quad \text{where } 0 < \xi_{f(x)} < (U_{f(x)}^T - L_{f(x)}^T)
 \end{aligned}$$

Step-3: In this step we calculate membership for truth, indeterminacy and falsity membership function of objective as follows

$$T_{f(x)}(f(x)) = \begin{cases} 1 & \text{if } f(x) \leq L_{f(x)}^T \\ 1 - \exp\left\{-\psi \left(\frac{U_{f(x)}^T - f(x)}{U_{f(x)}^T - L_{f(x)}^T}\right)\right\} & \text{if } L_{f(x)}^T \leq f(x) \leq U_{f(x)}^T \\ 0 & \text{if } f(x) \geq U_{f(x)}^T \end{cases} \quad (17)$$

$$I_{f(x)}(f(x)) = \begin{cases} 1 & \text{if } f(x) \leq L_{f(x)}^I \\ \exp\left\{\frac{U_{f(x)}^I - f(x)}{U_{f(x)}^I - L_{f(x)}^I}\right\} & \text{if } L_{f(x)}^I \leq f(x) \leq U_{f(x)}^I \\ 0 & \text{if } f(x) \geq U_{f(x)}^I \end{cases} \quad (18)$$

$$F_{f(x)}(f(x)) = \begin{cases} 0 & \text{if } f(x) \leq L_{f(x)}^F \\ \frac{1}{2} + \frac{1}{2} \tanh\left\{\left(f(x) - \frac{U_{f(x)}^F + L_{f(x)}^F}{2}\right) \tau_{f(x)}\right\} & \text{if } L_{f(x)}^F \leq f(x) \leq U_{f(x)}^F \\ 1 & \text{if } f(x) \geq U_{f(x)}^F \end{cases} \quad (19)$$

where ψ, τ are non-zero parameters prescribed by the decision maker.

Step-4: In this step using exponential and hyperbolic membership function we calculate truth, indeterminacy and falsity membership function for constraints as follows

$$T_{g_j(x)}(g_j(x)) = \begin{cases} 1 & \text{if } g_j(x) \leq b_j \\ 1 - \exp\left\{-\psi \left(\frac{U_{g_j(x)}^T - g_j(x)}{U_{g_j(x)}^T - L_{g_j(x)}^T}\right)\right\} & \text{if } b_j \leq g_j(x) \leq b_j + b_j^0 \\ 0 & \text{if } g_j(x) \geq b_j + b_j^0 \end{cases} \quad (20)$$

$$I_{g_j(x)}(g_j(x)) = \begin{cases} 1 & \text{if } g_j(x) \leq b_j \\ \exp\left\{\frac{(b_j + \xi_{g_j(x)}) - g_j(x)}{\xi_{g_j(x)}}\right\} & \text{if } b_j \leq g_j(x) \leq b_j + \xi_{g_j(x)} \\ 0 & \text{if } g_j(x) \geq b_j + \xi_{g_j(x)} \end{cases} \quad (21)$$

$$F_{g_j(x)}(g_j(x)) = \begin{cases} 0 & \text{if } g_j(x) \leq b_j + \varepsilon_{g_j(x)} \\ \frac{1}{2} + \frac{1}{2} \tanh \left\{ \left(g_j(x) - \frac{2b_j + b_j^0 + \varepsilon_{g_j(x)}}{2} \right) \tau_{g_j(x)} \right\} & \text{if } b_j + \varepsilon_{g_j(x)} \leq g_j(x) \leq b_j + b_j^0 \\ 1 & \text{if } g_j(x) \geq b_j + b_j^0 \end{cases} \quad (22)$$

where ψ, τ are non-zero parameters prescribed by the decision maker and for $j = 1, 2, \dots, m$ $0 < \varepsilon_{g_j(x)}, \xi_{g_j(x)} < b_j^0$.

Step-5: Now using NSO for single objective optimization technique the optimization problem (13) can be formulated as

$$\text{Maximize } (\alpha + \gamma - \beta) \quad (23)$$

Such that

$$T_{f(x)}(x) \geq \alpha; \quad (24)$$

$$T_{g_j}(x) \geq \alpha; \quad (25)$$

$$I_{f(x)}(x) \geq \gamma; \quad (26)$$

$$I_{g_j}(x) \geq \gamma; \quad (27)$$

$$F_{f(x)}(x) \leq \beta; \quad (28)$$

$$F_{g_j}(x) \leq \beta; \quad (29)$$

$$\alpha + \beta + \gamma \leq 3; \quad (30)$$

$$\alpha \geq \beta; \alpha \geq \gamma; \quad (31)$$

$$\alpha, \beta, \gamma \in [0, 1] \quad (32)$$

where

$$\alpha = T_{\bar{D}^n}(x) = \min \left\{ T_{f(x)}(f(x)), T_{g_j(x)}(g_j(x)) \right\} \quad (33)$$

for $j = 1, 2, \dots, m$

$$\gamma = I_{\bar{D}^n}(x) = \min \left\{ I_{f(x)}(f(x)), I_{g_j(x)}(g_j(x)) \right\} \quad (34)$$

for $j = 1, 2, \dots, m$ and

$$\beta = F_{\bar{D}^n}(x) = \min \left\{ F_{f(x)}(f(x)), F_{g_j(x)}(g_j(x)) \right\} \text{ for } j = 1, 2, \dots, m \quad (35)$$

are the truth ,indeterminacy and falsity membership function of decision set $\tilde{D}^n = f^n(x) \prod_{j=1}^m g^n_j(x)$. Now if non-linear membership be considered the above problem (23-35) can be reduced to following crisp linear programming problem

$$\text{Maximize } (\theta + \kappa - \eta) \quad (36)$$

Such that

$$f(x) + \theta \frac{(U_{f(x)}^T - L_{f(x)}^T)}{\psi} \leq U_{f(x)}^T; \quad (37)$$

$$f(x) + \kappa \xi_{f(x)} \leq U_{f(x)}^T; \quad (38)$$

$$f(x) + \frac{\eta}{\tau_{f(x)}} \leq \frac{U_{f(x)}^T + L_{f(x)}^T + \varepsilon_{f(x)}}{2}; \quad (39)$$

$$g_j(x) + \theta \frac{b_j^0}{\psi} \leq b_j + b_j^0; \quad (40)$$

$$g_j(x) + \kappa \xi_{g_j(x)} \leq b_j^0 + \xi_{g_j(x)}; \quad (41)$$

$$g_j(x) + \frac{\eta}{\tau_{g_j(x)}} \leq \frac{2b_j + b_j^0 + \varepsilon_{g_j(x)}}{2}; \quad (42)$$

$$\theta + \kappa + \eta \leq 3; \quad (43)$$

$$\theta \geq \kappa; \theta \geq \eta; \quad (44)$$

$$\theta, \kappa, \eta \in [0,1] \quad (45)$$

$$\text{where } \theta = -\ln(1-\alpha); \quad (46)$$

$$\psi = 4; \quad (47)$$

$$\tau_{f(x)} = \frac{6}{(U_{f(x)}^F - L_{f(x)}^F)}; \quad (48)$$

$$\tau_{g_j(x)} = \frac{6}{(b_j^0 - \varepsilon_j)}, \text{ for } j = 1, 2, \dots, m \quad (49)$$

$$\kappa = \ln \gamma; \quad (50)$$

$$\eta = -\tanh^{-1}(2\beta - 1). \quad (51)$$

This crisp nonlinear programming problem can be solved by appropriate mathematical algorithm.

4 Solution of Single-objective Structural Optimization Problem (SOSOP) by Neutrosophic Optimization Technique

To solve the SOSOP (1), step 1 of 3 is used and we will get optimum solutions of two sub problem as A^1 and A^2 . After that according to step 2 we find upper and lower bound of membership function of objective function as $U_{WT(A)}^T, U_{WT(A)}^I, U_{WT(A)}^F$ and $L_{WT(A)}^T, L_{WT(A)}^I, L_{WT(A)}^F$ where

$$U_{WT(A)}^T = \max\{WT(A^1), WT(A^2)\}, L_{WT(A)}^T = \min\{WT(A^1), WT(A^2)\}, \quad (52)$$

$$U_{WT(A)}^F = U_{WT(A)}^T, L_{WT(A)}^F = L_{WT(A)}^T + \varepsilon_{WT(A)} \text{ where } 0 < \varepsilon_{WT(A)} < (U_{WT(A)}^T - L_{WT(A)}^T) \quad (53)$$

$$L_{WT(A)}^I = L_{WT(A)}^T, U_{WT(A)}^I = L_{WT(A)}^T + \xi_{WT(A)} \text{ where } 0 < \xi_{WT(A)} < (U_{WT(A)}^T - L_{WT(A)}^T) \quad (54)$$

Let the non-linear membership function for objective function $WT(A)$ be

$$T_{WT(A)}(WT(A)) = \begin{cases} 1 & \text{if } WT(A) \leq L_{WT(A)}^T \\ 1 - \exp\left\{-\psi \left(\frac{U_{WT(A)}^T - WT(A)}{U_{WT(A)}^T - L_{WT(A)}^T}\right)\right\} & \text{if } L_{WT(A)}^T \leq WT(A) \leq U_{WT(A)}^T \\ 0 & \text{if } WT(A) \geq U_{WT(A)}^T \end{cases} \quad (55)$$

$$I_{WT(A)}(WT(A)) = \begin{cases} 1 & \text{if } WT(A) \leq L_{WT(A)}^I \\ \exp\left\{\frac{U_{WT(A)}^I - WT(A)}{U_{WT(A)}^I - L_{WT(A)}^I}\right\} & \text{if } L_{WT(A)}^I \leq WT(A) \leq U_{WT(A)}^I \\ 0 & \text{if } WT(A) \geq U_{WT(A)}^I \end{cases} \quad (56)$$

$$I_{\sigma_i(A)}(\sigma_i(A)) = \begin{cases} 1 & \text{if } \sigma_i(A) \leq \sigma_i \\ \exp\left\{\frac{(\sigma_i + \xi_{\sigma_i(x)}) - \sigma_i(A)}{\xi_{\sigma_i(x)}}\right\} & \text{if } \sigma_i \leq \sigma_i(A) \leq \sigma_i + \xi_{\sigma_i(x)} \\ 0 & \text{if } \sigma_i(A) \geq \sigma_i + \xi_{\sigma_i(x)} \end{cases} \quad (57)$$

$$F_{\sigma_i(A)}(\sigma_i(A)) = \begin{cases} 0 & \text{if } \sigma_i(A) \leq \sigma_i + \varepsilon_{\sigma_i(A)} \\ \frac{1}{2} + \frac{1}{2} \tanh\left\{\left(\sigma_i(A) - \frac{2b_j + b_j^0 + \varepsilon_{\sigma_i}}{2}\right)\tau_{\sigma_i}\right\} & \text{if } \sigma_i + \varepsilon_{\sigma_i(A)} \leq \sigma_i(A) \leq \sigma_i + \sigma_i^0 \\ 1 & \text{if } \sigma_i(A) \geq \sigma_i + \sigma_i^0 \end{cases} \quad (58)$$

where ψ, τ are non-zero parameters prescribed by the decision maker and for $j = 1, 2, \dots, m$ $0 < \varepsilon_{\sigma_i(A)}, \xi_{\sigma_i(A)} < \sigma_i^0$, then neutrosophic optimization problem can be formulated as

$$\text{Max } (\alpha + \beta - \gamma) \quad (59)$$

such that

$$T_{WT(A)}(WT(A)) \geq \alpha; \quad (60)$$

$$T_{\sigma_i(A)}(\sigma_i(A)) \geq \alpha; \quad (61)$$

$$I_{WT(A)}(WT(A)) \geq \gamma; \quad (62)$$

$$I_{\sigma_i(A)}(\sigma_i(A)) \geq \gamma; \quad (63)$$

$$F_{WT(A)}(WT(A)) \leq \beta; \quad (64)$$

$$F_{\sigma_i(A)}(\sigma_i(A)) \leq \beta \quad (65)$$

$$\alpha + \beta + \gamma \leq 3; \alpha \geq \beta, \alpha \geq \gamma; \quad (66)$$

$$\alpha, \beta, \gamma \in [0, 1] \quad (67)$$

The above problem can be reduced to following crisp linear programming problem, for non-linear membership as

$$\text{Maximize } (\theta + \kappa - \eta) \quad (68)$$

such that

$$WT(A) + \theta \frac{(U_{WT(A)}^T - L_{WT(A)}^T)}{\psi} \leq U_{WT(A)}^T; \quad (69)$$

$$WT(A) + \frac{\eta}{\tau_{WT(A)}} \leq \frac{U_{WT(A)}^T + L_{WT(A)}^T + \varepsilon_{WT(A)}}{2}; \quad (70)$$

$$WT(A) + \kappa \xi_{WT(A)} \leq U_{WT(A)}^T; \quad (71)$$

$$\sigma_i(A) + \theta \frac{\sigma_i^0}{\psi} \leq \sigma_i + \sigma_i^0; \quad (72)$$

$$\sigma_i(A) + \kappa \xi_{\sigma_i(A)} \leq \sigma_i^0 + \xi_{\sigma_i(A)}; \quad (73)$$

$$\sigma_i(A) + \frac{\eta}{\tau_{\sigma_i(A)}} \leq \frac{2\sigma_i + \sigma_i^0 + \varepsilon_{\sigma_i(A)}}{2}; \quad (74)$$

$$\theta + \kappa - \eta \leq 3; \theta \geq \kappa; \theta \geq \eta; \quad (75)$$

$$\theta, \kappa, \eta \in [0, 1] \quad (76)$$

where

$$\theta = -\ln(1 - \alpha); \quad (77)$$

$$\psi = 4; \quad (78)$$

$$\tau_{WT(A)} = \frac{6}{\left(U_{WT(A)}^F - L_{WT(A)}^F \right)}; \quad (79)$$

$$\kappa = \ln \gamma; \quad (80)$$

$$\eta = -\tanh^{-1}(2\beta - 1). \quad (81)$$

$$\text{and } \tau_{\delta(A)} = \frac{6}{\left(U_{\delta(A)}^F - L_{\delta(A)}^F \right)}; \quad (82)$$

This crisp nonlinear programming problem can be solved by appropriate mathematical algorithm.

5 Numerical illustration

A well-known two-bar [17] planar truss structure is considered. The design objective is to minimize weight of the structural $WT(A_1, A_2, y_B)$ of a statistically loaded two-bar planar truss subjected to stress $\sigma_i(A_1, A_2, y_B)$ constraints on each of the truss members $i = 1, 2$.

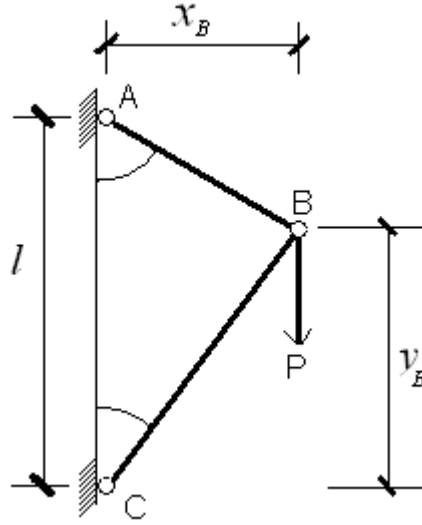

Figure 1. Design of the two-bar planar truss

The multi-objective optimization problem can be stated as follows

$$\text{Minimize } WT(A_1, A_2, y_B) = \rho \left(A_1 \sqrt{x_B^2 + (l - y_B)^2} + A_2 \sqrt{x_B^2 + y_B^2} \right) \quad (83)$$

Such that

$$\sigma_{AB}(A_1, A_2, y_B) \equiv \frac{P \sqrt{x_B^2 + (l - y_B)^2}}{A_1} \leq [\sigma_{AB}^T]; \quad (84)$$

$$\sigma_{BC}(A_1, A_2, y_B) \equiv \frac{P \sqrt{x_B^2 + y_B^2}}{A_2} \leq [\sigma_{BC}^C]; \quad (85)$$

$$0.5 \leq y_B \leq 1.5 \quad (86)$$

$$A_1 > 0, A_2 > 0;$$

where P = nodal load ; ρ = volume density ; l = length of AC ; x_B = perpendicular distance from AC to point B . A_1 = Cross section of bar- AB ; A_2 = Cross section of bar- BC . $[\sigma_T]$ = maximum allowable tensile stress , $[\sigma_C]$ = maximum allowable compressive stress and $y_B = y$ -co-ordinate of node B .

Input data for crisp model (10) is in table 1.

Solution : According to step 2 of 4, we find upper and lower bound of membership function of objective function as

$$U_{WT(A)}^T, U_{WT(A)}^I, U_{WT(A)}^F$$

and $L_{WT(A)}^T, L_{WT(A)}^I, L_{WT(A)}^F$ where

$$U_{WT(A)}^T = 14.23932 = U_{WT(A)}^F \quad (87)$$

$$L_{WT(A)}^T = 12.57667 = L_{WT(A)}^I \quad (88)$$

$$L_{WT(A)}^F = 12.57667 + \varepsilon_{WT(A)}, \quad 0 < \varepsilon_{WT(A)} < 1.66265 \quad (89)$$

$$U_{WT(A)}^I = L_{WT(A)}^T + \xi_{WT(A)}, \quad 0 < \xi_{WT(A)} < 1.66265 \quad (90)$$

Now using the bounds we calculate the membership functions for objective as follows

$$T_{WT(A_1, A_2, y_B)}(WT(A_1, A_2, y_B)) = \begin{cases} 1 & \text{if } WT(A_1, A_2, y_B) \leq 12.57667 \\ 1 - \exp\left\{-4\left(\frac{14.23932 - WT(A_1, A_2, y_B)}{1.66265}\right)\right\} & \text{if } 12.57667 \leq WT(A_1, A_2, y_B) \leq 14.23932 \\ 0 & \text{if } WT(A_1, A_2, y_B) \geq 14.23932 \end{cases} \quad (91)$$

$$I_{WT(A_1, A_2, y_B)}(WT(A_1, A_2, y_B)) = \begin{cases} 1 & \text{if } WT(A_1, A_2, y_B) \leq 12.57667 \\ \exp\left\{\frac{(12.57667 + \xi_{WT}) - WT(A_1, A_2, y_B)}{\xi_{WT}}\right\} & \text{if } 12.57667 \leq WT(A_1, A_2, y_B) \leq 12.57667 + \xi_{WT} \\ 0 & \text{if } WT(A_1, A_2, y_B) \geq 12.57667 + \xi_{WT} \end{cases} \quad (92)$$

$$F_{WT(A_1, A_2, y_B)}(WT(A_1, A_2, y_B)) = \begin{cases} 0 & \text{if } WT(A_1, A_2, y_B) \leq 12.57667 + \varepsilon_{WT} \\ \frac{1}{2} + \frac{1}{2} \tanh\left\{\left(WT(A_1, A_2, y_B) - \frac{(26.81599 + \varepsilon_{WT})}{2}\right) \frac{6}{1.66265 - \varepsilon_{WT}}\right\} & \text{if } 12.57667 + \varepsilon_{WT} \leq WT(A_1, A_2, y_B) \leq 14.23932 \\ 1 & \text{if } WT(A_1, A_2, y_B) \geq 14.23932 \end{cases} \quad (93)$$

Similarly the membership functions for tensile stress are

$$T_{\sigma_T(A_1, A_2, y_B)}(\sigma_T(A_1, A_2, y_B)) = \begin{cases} 1 & \text{if } \sigma_T(A_1, A_2, y_B) \leq 130 \\ 1 - \exp\left\{-4\left(\frac{150 - \sigma_T(A_1, A_2, y_B)}{20}\right)\right\} & \text{if } 130 \leq \sigma_T(A_1, A_2, y_B) \leq 150 \\ 0 & \text{if } \sigma_T(A_1, A_2, y_B) \geq 150 \end{cases} \quad (94)$$

$$I_{\sigma_T(A_1, A_2, y_B)}(\sigma_T(A_1, A_2, y_B)) = \begin{cases} 1 & \text{if } \sigma_T(A_1, A_2, y_B) \leq 130 \\ \exp\left\{\frac{(130 + \xi_{\sigma_T}) - \sigma_T(A_1, A_2, y_B)}{\xi_{\sigma_T}}\right\} & \text{if } 130 \leq \sigma_T(A_1, A_2, y_B) \leq 130 + \xi_{\sigma_T} \\ 0 & \text{if } \sigma_T(A_1, A_2, y_B) \geq 130 + \xi_{\sigma_T} \end{cases} \quad (95)$$

$$F_{\sigma_T(A_1, A_2, y_B)}(\sigma_T(A_1, A_2, y_B)) = \begin{cases} 0 & \text{if } \sigma_T(A_1, A_2, y_B) \leq 130 + \varepsilon_{\sigma_T} \\ \frac{1}{2} + \frac{1}{2} \tanh \left\{ \left(\sigma_T(A_1, A_2, y_B) - \left(\frac{280 + \varepsilon_{\sigma_T}}{2} \right) \right) \frac{6}{20 - \varepsilon_{\sigma_T}} \right\} & \text{if } 130 + \varepsilon_{\sigma_T} \leq \sigma_T(A_1, A_2, y_B) \leq 150 \\ 1 & \text{if } \sigma_T(A_1, A_2, y_B) \geq 150 \end{cases} \quad (96)$$

where $0 < \varepsilon_{\sigma_T}, \xi_{\sigma_T} < 20$

and the membership functions for compressive stress constraint are

$$T_{\sigma_C(A_1, A_2, y_B)}(\sigma_C(A_1, A_2, y_B)) = \begin{cases} 1 & \text{if } \sigma_C(A_1, A_2, y_B) \leq 90 \\ 1 - \exp \left\{ -4 \left(\frac{100 - \sigma_C(A_1, A_2, y_B)}{10} \right) \right\} & \text{if } 90 \leq \sigma_C(A_1, A_2, y_B) \leq 100 \\ 0 & \text{if } \sigma_C(A_1, A_2, y_B) \geq 100 \end{cases} \quad (97)$$

$$I_{\sigma_C(A_1, A_2, y_B)}(\sigma_C(A_1, A_2, y_B)) = \begin{cases} 1 & \text{if } \sigma_C(A_1, A_2, y_B) \leq 90 \\ \exp \left\{ \frac{(90 + \xi_{\sigma_C}) - \sigma_C(A_1, A_2, y_B)}{\xi_{\sigma_C}} \right\} & \text{if } 90 \leq \sigma_C(A_1, A_2, y_B) \leq 90 + \xi_{\sigma_C} \\ 0 & \text{if } \sigma_C(A_1, A_2, y_B) \geq 90 + \xi_{\sigma_C} \end{cases} \quad (98)$$

$$F_{\sigma_C(A_1, A_2, y_B)}(\sigma_C(A_1, A_2, y_B)) = \begin{cases} 0 & \text{if } \sigma_C(A_1, A_2, y_B) \leq 90 + \varepsilon_{\sigma_C} \\ \frac{1}{2} + \frac{1}{2} \tanh \left\{ \left(\sigma_C(A_1, A_2, y_B) - \left(\frac{190 + \varepsilon_{\sigma_C}}{2} \right) \right) \frac{6}{10 - \varepsilon_{\sigma_C}} \right\} & \text{if } 90 + \varepsilon_{\sigma_C} \leq \sigma_C(A_1, A_2, y_B) \leq 100 \\ 1 & \text{if } \sigma_C(A_1, A_2, y_B) \geq 100 \end{cases} \quad (99)$$

where $0 < \varepsilon_{\sigma_C}, \xi_{\sigma_C} < 10$.

Now, using above mentioned truth, indeterminacy and falsity membership function NLP (83-86) can be solved by NSO technique for different values of $\varepsilon_{WT}, \varepsilon_{\sigma_T}, \varepsilon_{\sigma_C}$ and $\xi_{WT}, \xi_{\sigma_T}, \xi_{\sigma_C}$. The optimum solution of SOSOP(83-86) is given in table (2) and the solution is compared with fuzzy and intuitionistic fuzzy optimization technique

Table 1: Input data for crisp model (83-86)

Applied load P (KN)	Volume density ρ (KN/m ³)	Length l (m)	Maximum allowable tensile stress $[\sigma_T]$ (Mpa)	Maximum allowable compressive stress $[\sigma_C]$ (Mpa)	Distance of x_B from AC (m)
100	7.7	2	130 with tolerance 20	90 with tolerance 10	1

Table 2: Comparison of Optimal solution of SOSOP (83-86) based on different methods

Methods	$A_1(m^2)$	$A_2(m^2)$	$WT(A_1, A_2)(KN)$	$y_B(m)$
Fuzzy single-objective non-linear programming (FSONLP) with non-linear membership functions	.5883491	.7183381	14.23932	1.013955
Intuitionistic fuzzy single-objective nonlinear programming (IFSONLP) with non-linear membership functions $\varepsilon_1 = 0.8, \varepsilon_2 = 16, \varepsilon_3 = 8$.6064095	.6053373	13.59182	.5211994
Neutrosophic optimization(NSO) with non-linear membership functions $\varepsilon_1 = 0.8, \varepsilon_2 = 16, \varepsilon_3 = 8$ $\xi_1 = 0.66506, \xi_2 = 8, \xi_3 = 4$.5451860	.677883	13.24173	.7900455

Here we get best solutions for the different tolerance ξ_1, ξ_2 and ξ_3 for indeterminacy exponential membership function of objective functions for this structural optimization problem. From the table 2, it shows that NSO technique gives better Pareto optimal result in the perspective of Structural Optimization.

7 Conclusions

The main objective of this work is to illustrate how neutrosophic optimization technique using non-linear membership function can be utilized to solve a nonlinear structural problem. The concept of neutrosophic optimization technique allows one to define a degree of truth membership, which is not a complement of degree of falsity; rather, they are independent with degree of indeterminacy. The numerical illustration shows the superiority of neutrosophic optimization over fuzzy optimization as well as intuitionistic fuzzy optimization. The results of this study may lead to the development of effective neutrosophic technique for solving other model of nonlinear programming problem in other engineering field.

Acknowledgement

The authors would like to thank the anonymous referees for their constructive comments and suggestions that have helped a lot to come up with this improved form of the chapter.

References

- [1] Atanassov, K. T. Intuitionistic fuzzy sets. *Fuzzy Sets and Systems*.1986:20(1): 87-96.
- [2] Zadeh, L.A. Fuzzy set. *Information and Control*. 1965):8(3):338-353.
- [3] Rao, S. S. Description and optimum design of fuzzy mechanical systems. *Journal of Mechanisms, Transmissions, and Automation in Design*.1987:109(1) 126-132.
- [4] Bellman, R. E., &Zadeh, L. A. Decision-making in a fuzzy environment. *Management science*.1970:17(4):B-141.
- [5] Shih, C. J., & Lee, H. W. Level-cut approaches of first and second kind for unique solution design in fuzzy engineering optimization problems. *Tamkang Journal of Science and Engineering*.2004:7(3):189-198.
- [6] Shih, C. J., Chi, C. C., & Hsiao, J. H. Alternative α -level-cuts methods for optimum structural design with fuzzy resources. *Computers & structures*.2003:81(28): 2579-2587.
- [7] Smarandache, F. *Neutrosophy, neutrosophic probability, set and logic*, Amer. Res. Press, Rehoboth, USA. 1995:105.
- [8] Wang, G.Y. & Wang, W.Q. Fuzzy optimum design of structure. *Engineering Optimization*.1985:8291-300.
- [9] Yeh, Y.C. & Hsu, D.S. Structural optimization with fuzzy parameters. *Computer and Structure*. 1990:37(6):917–924.
- [10] Changwen, X. Fuzzy optimization of structures by the two-phase method. *Computers & Structures*. 1989:31(4):575-580.
- [11] Dey, S., & Roy, T. K. A Fuzzy programming Technique for Solving Multi-objective Structural Problem. *International Journal of Engineering and Manufacturing*, 2014:4(5):24.
- [12] Dey, S., & Roy, T. K. Optimized solution of two bar truss design using intuitionistic fuzzy optimization technique. *International Journal of Information Engineering and Electronic Business*.2014:6(4):45.
- [13] Dey, S., & Roy, T. K. Multi-objective structural design problem optimization using parameterized t-norm based fuzzy optimization programming Technique. *Journal of Intelligent and Fuzzy Systems*.2016:30(2):971-982.
- [14] Dey, S., & Roy, T. Optimum shape design of structural model with imprecise coefficient by parametric geometric programming. *Decision Science Letters*.2015:4(3):407-418.
- [15] Jana, B., & Roy, T. K. Multi-objective intuitionistic fuzzy linear programming and its application in transportation model. *Notes on Intuitionistic Fuzzy Sets*.2007:13(1):34-51.
- [16] Dey, S.,& Roy, T. K. Multi-objective structural optimization using fuzzy and intuitionistic fuzzy optimization technique. *International Journal of Intelligent systems and applications*.2015:7(5):57.
- [17] Ali, N., Behdinin, K., & Fawaz, Z. Applicability and viability of a GA based finite element analysis architecture for structural design optimization. *Computers & structures*.2003:81(22):2259-2271.

- [18] Abdel-Basset, Mohamed, et al. "A novel group decision-making model based on triangular neutrosophic numbers." *Soft Computing* (2017): 1-15. DOI: <https://doi.org/10.1007/s00500-017-2758-5>
- [19] Hussian, Abdel-Nasser, et al. "Neutrosophic Linear Programming Problems." Peer Reviewers: 15.
- [20] Abdel-Basset, Mohamed, Mai Mohamed, and Arun Kumar Sangaiah. "Neutrosophic AHP-Delphi Group decision making model based on trapezoidal neutrosophic numbers." *Journal of Ambient Intelligence and Humanized Computing* (2017): 1-17. DOI: <https://doi.org/10.1007/s12652-017-0548-7>
- [21] Mohamed, Mai, et al. "A Critical Path Problem in Neutrosophic Environment." Peer Reviewers: 167.
- [22] Mohamed, Mai, et al. "A Critical Path Problem Using Triangular Neutrosophic Number." Peer Reviewers: 155.
- [23] Mohamed, Mai, et al. "Using Neutrosophic Sets to Obtain PERT Three-Times Estimates in Project Management." Peer Reviewers: 143.
- [24] Mohamed, Mai, et al. "Neutrosophic Integer Programming Problem." *Neutrosophic Sets & Systems* 15 (2017).
- [25] Abdel-Baset, Mohamed, Ibrahim M. Hezam, and Florentin Smarandache. "Neutrosophic goal programming." *Neutrosophic Sets Syst* 11 (2016): 112-118.
- [26] Mridula Sarkar, Samir Dey, Tapan Kumar Roy: Truss Design Optimization using Neutrosophic Optimization Technique, *Neutrosophic Sets and Systems*, vol. 13, 2016, pp. 62-69. doi.org/10.5281/zenodo.570869
- [27] Pintu Das, Tapan Kumar Roy: Multi-objective non-linear programming problem based on Neutrosophic Optimization Technique and its application in Riser Design Problem, *Neutrosophic Sets and Systems*, vol. 9, 2015, pp. 88-95. doi.org/10.5281/zenodo.571480
- [28] Naga Raju I, Rajeswara Reddy P, Dr. Diwakar Reddy V, Dr. Krishnaiah G: Real Life Decision Optimization Model, *Neutrosophic Sets and Systems*, vol. 14, 2016, pp. 71-79. doi.org/10.5281/zenodo.570889
- [29] Wenzhong Jiang, Jun Ye: Optimal Design of Truss Structures Using a Neutrosophic Number Optimization Model under an Indeterminate Environment, *Neutrosophic Sets and Systems*, vol. 14, 2016, pp. 93-97. doi.org/10.5281/zenodo.570888
- [30] Mona Gamal Gafar, Ibrahim El-Henawy: Integrated Framework of Optimization Technique and Information Theory Measures for Modeling Neutrosophic Variables, *Neutrosophic Sets and Systems*, vol. 15, 2017, pp. 80-89. doi.org/10.5281/zenodo.570939
- [31] Hezam, Ibrahim M., Mohamed Abdel-Baset, and Florentin Smarandache. "Taylor series approximation to solve neutrosophic multiobjective programming problem." *Neutrosophic Sets and Systems* 10 (2015): 39-46.
- [32] El-Hefenawy, Nancy, et al. "A review on the applications of neutrosophic sets." *Journal of Computational and Theoretical Nanoscience* 13.1 (2016): 936-944.

VII

Multi-objective Neutrosophic Optimization Technique and its Application to Structural Design

Mridula Sarkar¹ • Tapan Kumar Roy²

¹Indian Institute of Engineering Science and Technology, Shibpur, P.O-Botanic Garden, Howrah-711103, India. Email: mridula.sarkar86@rediffmail.com

²Indian Institute of Engineering Science and Technology, Shibpur, P.O-Botanic Garden, Howrah-711103, India. Email: roy_t_k@yahoo.co.in

Abstract

In this paper, we develop a multi-objective non-linear neutrosophic optimization (NSO) approach for optimizing the design of plane truss structure with multiple objectives subject to a specified set of constraints. In this optimum design formulation, the objective functions are the weight of the truss and the deflection of loaded joint; the design variables are the cross-sections of the truss members; the constraints are the stresses in members. A classical truss optimization example is presented here in to demonstrate the efficiency of the neutrosophic optimization approach. The test problem includes a three-bar planar truss subjected to a single load condition. This multi-objective structural optimization model is solved by neutrosophic optimization approach. With linear and non-linear membership function. Numerical example is given to illustrate our NSO approach.

Keywords

Neutrosophic Set, Single Valued Neutrosophic Set, Neutrosophic Optimization, Structural model.

1 Introduction

The research area of optimal structural design has been receiving increasing attention from both academia and industry over the past three decades in order to improve structural performance and to reduce design costs. However, in the real world, uncertainty or vagueness is prevalent in the Engineering

Computations. In the context of structural design the uncertainty is connected with lack of accurate data of design factors. This tendency has been changing due to the increase in the use of fuzzy mathematical algorithm for dealing with this class of problems. Fuzzy set (FS) theory has long been introduced to handle inexact and imprecise data by Zadeh [2], Later on Bellman and Zadeh [4] used the fuzzy set theory to the decision making problem. The fuzzy set theory also found application in structural design. Several researchers like Wang et al. [8] first applied α -cut method to structural designs where the non-linear problems were solved with various design levels α , and then a sequence of solutions were obtained by setting different level-cut value of α . Rao [3] applied the same α -cut method to design a four-bar mechanism for function generating problem. Structural optimization with fuzzy parameters was developed by Yeh et al. [9]. Xu [10] used two-phase method for fuzzy optimization of structures. Shih et al. [5] used level-cut approach of the first and second kind for structural design optimization problems with fuzzy resources. Shih et al. [6] developed an alternative α -level-cuts methods for optimum structural design with fuzzy resources. Dey et al. [11] used generalized fuzzy number in context of a structural design. Dey et al. [14] used basic t-norm based fuzzy optimization technique for optimization of structure. Dey et al. [13] developed parameterized t-norm based fuzzy optimization method for optimum structural design. In such extension, Atanassov [1] introduced Intuitionistic fuzzy set (IFS) which is one of the generalizations of fuzzy set theory and is characterized by a membership function, a non-membership function and a hesitancy function. In fuzzy sets the degree of acceptance is only considered but IFS is characterized by a membership function and a non-membership function so that the sum of both values is less than one. A transportation model was solved by Jana et al. [15] using multi-objective intuitionistic fuzzy linear programming. Dey et al. [12] solved two bar truss non-linear problem by using intuitionistic fuzzy optimization problem. Dey et al. [16] used intuitionistic fuzzy optimization technique for multi objective optimum structural design. Intuitionistic fuzzy sets consider both truth membership and falsity membership. Intuitionistic fuzzy sets can only handle incomplete information not the indeterminate information and inconsistent information. In neutrosophic sets indeterminacy is quantified explicitly and truth membership, indeterminacy membership and falsity membership which are independent. Neutrosophic theory was introduced by Smarandache [7,17-26]. The motivation of the present study is to give computational algorithm for solving multi-objective structural problem by single valued neutrosophic optimization approach. Neutrosophic optimization technique is very rare in application to structural optimization. We also aim to study the impact of truth exponential membership, indeterminacy exponential membership and falsity hyperbolic membership function in such optimization process. The results are compared

numerically linear and nonlinear neutrosophic optimization technique. From our numerical result, it has been seen that there is no change between the result of linear and non-linear neutrosophic optimization technique in the perspective of structural optimization technique.

2 Multi-objective Structural Model

In the design problem of the structure i.e. lightest weight of the structure and minimum deflection of the loaded joint that satisfies all stress constraints in members of the structure. In truss structure system, the basic parameters (including allowable stress, etc) are known and the optimization's target is that identify the optimal bar truss cross-section area so that the structure is of the smallest total weight with minimum nodes displacement in a given load conditions .

The multi-objective structural model can be expressed as

$$\text{Minimize } WT(A) \tag{1}$$

$$\text{minimize } \delta(A) \tag{2}$$

$$\text{subject to } \sigma(A) \leq [\sigma] \tag{3}$$

$$A^{\min} \leq A \leq A^{\max}$$

where $A = [A_1, A_2, \dots, A_n]^T$ are the design variables for the cross section, n is the group number of design variables for the cross section bar, $WT(A) = \sum_{i=1}^n \rho_i A_i L_i$ is the total weight of the structure, $\delta(A)$ is the deflection of the loaded joint, where L_i, A_i and ρ_i are the bar length, cross section area and density of the i^{th} group bars respectively. $\sigma(A)$ is the stress constraint and $[\sigma]$ is allowable stress of the group bars under various conditions, A^{\min} and A^{\max} are the lower and upper bounds of cross section area A respectively

3 Mathematical Preliminaries

In the following, we briefly describe some basic concepts and basic operational laws related to neutrosophic set

2.1 Fuzzy Set(FS)

Let X be a fixed set. A fuzzy set \tilde{A} of X is an object having the form

$$\tilde{A} = \left\{ \left(x, T_{\tilde{A}}(x) \right) \mid x \in X \right\} \tag{4}$$

where the function $T_{\tilde{A}} : X \rightarrow [0,1]$ stands for the truth membership of the element $x \in X$ to the set \tilde{A} .

2.2. Intuitionistic Fuzzy Set(IFS)

Let a set X be fixed. An intuitionistic fuzzy set or IFS \tilde{A}^i in X is an object of the form $\tilde{A}^i = \{(X, T_{\tilde{A}^i}(x), F_{\tilde{A}^i}(x)) | x \in X\}$ (5)

where $T_{\tilde{A}^i} : X \rightarrow [0,1]$ and $F_{\tilde{A}^i} : X \rightarrow [0,1]$ define the truth membership and falsity membership respectively, for every element of $x \in X$ such that $0 \leq T_{\tilde{A}^i}(x) + F_{\tilde{A}^i}(x) \leq 1$.

2.3. Single-Valued Neutrosophic Set(SVNS)

Let a set X be the universe of discourse. A single valued neutrosophic set \tilde{A}^n over X is an object having the form

$$\tilde{A}^n = \{(x, T_{\tilde{A}^n}(x), I_{\tilde{A}^n}(x), F_{\tilde{A}^n}(x)) | x \in X\} \quad (6)$$

where $T_{\tilde{A}^n} : X \rightarrow [0,1]$, $I_{\tilde{A}^n} : X \rightarrow [0,1]$ and $F_{\tilde{A}^n} : X \rightarrow [0,1]$ are truth, indeterminacy and falsity membership functions respectively so as to $0 \leq T_{\tilde{A}^n}(x) + I_{\tilde{A}^n}(x) + F_{\tilde{A}^n}(x) \leq 3$ for all $x \in X$.

2.4. Union of Neutrosophic Sets(NSs)

The union of two single valued neutrosophic sets \tilde{A}^n and \tilde{B}^n is a single valued neutrosophic set \tilde{U}^n denoted by

$$\tilde{U}^n = \tilde{A}^n \cup \tilde{B}^n = \{(x, T_{\tilde{U}^n}(x), I_{\tilde{U}^n}(x), F_{\tilde{U}^n}(x)) | x \in X\} \quad (7)$$

and is defined by the following conditions

- (i) $T_{\tilde{U}^n}(x) = \max(T_{\tilde{A}^n}(x), T_{\tilde{B}^n}(x))$,
- (ii) $I_{\tilde{U}^n}(x) = \max(I_{\tilde{A}^n}(x), I_{\tilde{B}^n}(x))$,
- (iii) $F_{\tilde{U}^n}(x) = \min(F_{\tilde{A}^n}(x), F_{\tilde{B}^n}(x))$ for all $x \in X$ for Type-I

Or in another way by defining following conditions

- (i) $T_{\tilde{U}^n}(x) = \max(T_{\tilde{A}^n}(x), T_{\tilde{B}^n}(x))$,
- (ii) $I_{\tilde{U}^n}(x) = \min(I_{\tilde{A}^n}(x), I_{\tilde{B}^n}(x))$

$$(iii) F_{\tilde{U}^n}(x) = \min(F_{\tilde{A}^n}(x), F_{\tilde{B}^n}(x)) \text{ for all } x \in X \text{ for Type-II}$$

where $T_{\tilde{U}^n}(x)$, $I_{\tilde{U}^n}(x)$, $F_{\tilde{U}^n}(x)$ represent truth membership, indeterminacy-membership and falsity-membership functions of union of neutrosophic sets

Example :

Let $\tilde{A}^n = \langle 0.3, 0.4, 0.5 \rangle / x_1 + \langle 0.5, 0.2, 0.3 \rangle / x_2 + \langle 0.7, 0.2, 0.2 \rangle / x_3$ and

$\tilde{B}^n = \langle 0.6, 0.1, 0.2 \rangle / x_1 + \langle 0.3, 0.2, 0.6 \rangle / x_2 + \langle 0.4, 0.1, 0.5 \rangle / x_3$ be two neutrosophic sets. Then the union of \tilde{A}^n and \tilde{B}^n is a single valued neutrosophic set can be calculated for

Type -I as

$$\tilde{A}^n \cup \tilde{B}^n = \langle 0.6, 0.4, 0.2 \rangle / x_1 + \langle 0.5, 0.2, 0.3 \rangle / x_2 + \langle 0.7, 0.2, 0.2 \rangle / x_3 \quad (8)$$

and for Type -II as

$$\tilde{A}^n \cup \tilde{B}^n = \langle 0.6, 0.1, 0.2 \rangle / x_1 + \langle 0.5, 0.2, 0.3 \rangle / x_2 + \langle 0.7, 0.1, 0.2 \rangle / x_3 \quad (9)$$

2.5. Intersection of Neutrosophic Sets

The intersection of two single valued neutrosophic sets \tilde{A}^n and \tilde{B}^n is a single valued neutrosophic set \tilde{E}^n is denoted by

$$\tilde{E}^n = \tilde{A}^n \cap \tilde{B}^n = \{ (x, T_{\tilde{E}^n}(x), I_{\tilde{E}^n}(x), F_{\tilde{E}^n}(x)) | x \in X \} \quad (10)$$

and is defined by the following conditions

$$(i) T_{\tilde{E}^n}(x) = \min(T_{\tilde{A}^n}(x), T_{\tilde{B}^n}(x)),$$

$$(ii) I_{\tilde{E}^n}(x) = \min(I_{\tilde{A}^n}(x), I_{\tilde{B}^n}(x)),$$

$$(iii) F_{\tilde{E}^n}(x) = \max(F_{\tilde{A}^n}(x), F_{\tilde{B}^n}(x)) \text{ for all } x \in X \text{ for Type-I}$$

Or in another way by defining following conditions

$$(i) T_{\tilde{E}^n}(x) = \min(T_{\tilde{A}^n}(x), T_{\tilde{B}^n}(x)),$$

$$(ii) I_{\tilde{E}^n}(x) = \max(I_{\tilde{A}^n}(x), I_{\tilde{B}^n}(x))$$

$$(iii) F_{\tilde{E}^n}(x) = \max(F_{\tilde{A}^n}(x), F_{\tilde{B}^n}(x)) \text{ for all } x \in X \text{ for Type-II}$$

where $T_{\tilde{E}^n}(x)$, $I_{\tilde{E}^n}(x)$, $F_{\tilde{E}^n}(x)$ represent truth membership, indeterminacy-membership and falsity-membership functions of union of neutrosophic sets

Example:

Let $\tilde{A}^n = \langle 0.3, 0.4, 0.5 \rangle / x_1 + \langle 0.5, 0.2, 0.3 \rangle / x_2 + \langle 0.7, 0.2, 0.2 \rangle / x_3$ and

$\tilde{B}^n = \langle 0.6, 0.1, 0.2 \rangle / x_1 + \langle 0.3, 0.2, 0.6 \rangle / x_2 + \langle 0.4, 0.1, 0.5 \rangle / x_3$ be two neutrosophic sets. Then the union of \tilde{A}^n and \tilde{B}^n is a single valued neutrosophic set can be measured for

Type -I as

$$\tilde{A}^n \cap \tilde{B}^n = \langle 0.3, 0.1, 0.5 \rangle / x_1 + \langle 0.3, 0.2, 0.6 \rangle / x_2 + \langle 0.4, 0.1, 0.5 \rangle / x_3 \quad (11)$$

and for Type -II as

$$\tilde{A}^n \cap \tilde{B}^n = \langle 0.3, 0.4, 0.5 \rangle / x_1 + \langle 0.3, 0.2, 0.6 \rangle / x_2 + \langle 0.4, 0.2, 0.5 \rangle / x_3 \quad (12)$$

4 Mathematical Analysis

4.1. Neutrosophic Optimization Technique to Solve Minimization Type Multi-Objective Non-linear Programming Problem

Decision making is a process of solving the problem involving the goals under constraints. The outcome is a decision which should in an action. Decision making plays an important role in engineering science. It is difficult process due to factors like incomplete and imprecise information which tend to presented real life situations. In the decision making process, our main target is to find the value from the selected set with the highest degree of membership in the decision set and these values support the goals under constraints only. But there may be situations where some values from selected set cannot support i.e such values strongly against the goals under constraints which are non-admissible. In this case we find such values from selected set with last degree of non –membership in the decision sets. Intuitionistic fuzzy sets can only handle incomplete information not the indeterminate information and inconsistent information which exists commonly in belief systems. In neutrosophic set, indeterminacy is quantified explicitly and truth membership, indeterminacy –membership and falsity membership are independent. So it is natural to adopt the purpose the value from the selected set with highest degree of truth-membership, indeterminacy-membership and least degree of falsity membership on the decision set. These factors indicate that a decision making process takes place in neutrosophic environment.

A nonlinear multi-objective optimization of the problem is of the form

$$\text{Minimize } \{f_1(x), f_2(x), \dots, f_p(x)\} \quad (13)$$

$$g_j(x) \leq b_j \quad j = 1, 2, \dots, q \quad (14)$$

Now the decision set \tilde{D}^n , a conjunction of Neutrosophic objectives and constraints is defined

$$\tilde{D}^n = \left(\bigcap_{k=1}^p \tilde{G}_k^n \right) \cap \left(\bigcap_{j=1}^q \tilde{C}_j^n \right) = \{ (x, T_{\tilde{D}^n}(x), I_{\tilde{D}^n}(x), F_{\tilde{D}^n}(x)) \} \quad (15)$$

Here

$$T_{\tilde{D}^n}(x) = \min \left\{ \begin{array}{l} T_{\tilde{G}_1^n}(x), T_{\tilde{G}_2^n}(x), T_{\tilde{G}_3^n}(x), \dots, T_{\tilde{G}_p^n}(x); \\ T_{\tilde{C}_1^n}(x), T_{\tilde{C}_2^n}(x), T_{\tilde{C}_3^n}(x), \dots, T_{\tilde{C}_q^n}(x) \end{array} \right\} \quad \text{for all } x \in X \quad (16)$$

$$I_{\tilde{D}^n}(x) = \min \left\{ \begin{array}{l} I_{\tilde{G}_1^n}(x), I_{\tilde{G}_2^n}(x), I_{\tilde{G}_3^n}(x), \dots, I_{\tilde{G}_p^n}(x); \\ I_{\tilde{C}_1^n}(x), I_{\tilde{C}_2^n}(x), I_{\tilde{C}_3^n}(x), \dots, I_{\tilde{C}_q^n}(x) \end{array} \right\} \quad \text{for all } x \in X \quad (17)$$

$$F_{\tilde{D}^n}(x) = \min \left\{ \begin{array}{l} F_{\tilde{G}_1^n}(x), F_{\tilde{G}_2^n}(x), F_{\tilde{G}_3^n}(x), \dots, F_{\tilde{G}_p^n}(x); \\ F_{\tilde{C}_1^n}(x), F_{\tilde{C}_2^n}(x), F_{\tilde{C}_3^n}(x), \dots, F_{\tilde{C}_q^n}(x) \end{array} \right\} \quad \text{for all } x \in X \quad (18)$$

Where $T_{\tilde{D}^n}(x), I_{\tilde{D}^n}(x), F_{\tilde{D}^n}(x)$ are truth-membership function, indeterminacy membership function, falsity membership function of neutrosophic decision set respectively. Now using the neutrosophic optimization, problem (13-14) is transformed to the non-linear programming problem as

$$\text{Max } \alpha \quad (19)$$

$$\text{Max } \gamma \quad (20)$$

$$\text{Min } \beta \quad (21)$$

such that

$$T_{\tilde{G}_k^n}(x) \geq \alpha; \quad (22)$$

$$T_{\tilde{C}_j^n}(x) \geq \alpha; \quad (23)$$

$$I_{\tilde{G}_k^n}(x) \geq \gamma; \quad (24)$$

$$I_{\tilde{C}_j^n}(x) \geq \gamma; \quad (25)$$

$$F_{\tilde{G}_k^n}(x) \leq \beta; \quad (26)$$

$$F_{\tilde{C}_j^n}(x) \leq \beta; \quad (27)$$

$$\alpha + \beta + \gamma \leq 3; \quad (28)$$

$$\alpha \geq \beta; \alpha \geq \gamma; \quad (29)$$

$$\alpha, \beta, \gamma \in [0, 1] \quad (30)$$

Now this non-linear programming problem (19-30) can be easily solved by an appropriate mathematical programming to give solution of multi-objective non-linear programming problem (13-14) by neutrosophic optimization approach.

Computational Algorithm

Step-1: Solve the MONLP problem (13-14) as a single objective non-linear problem p times for each problem by taking one of the objectives at a time and ignoring the others. These solution are known as ideal solutions. Let x^k be the respective optimal solution for the k^{th} different objective and evaluate each objective values for all these k^{th} optimal solution.

Step-2: From the result of step-1, determine the corresponding values for every objective for each derived solution, pay-off matrix can be formulated as follows

$$\begin{bmatrix} f_1^*(x^1) & f_2(x^1) & \dots & f_p(x^1) \\ f_1(x^2) & f_2^*(x^2) & \dots & f_p(x^2) \\ \dots & \dots & \dots & \dots \\ f_1(x^p) & f_2(x^p) & \dots & f_p^*(x^p) \end{bmatrix}$$

Step-3: For each objective $f_k(x)$ find lower bound L_k^μ and the upper bound U_k^μ

$$U_k^T = \max\{f_k(x^{r*})\} \quad \text{and} \quad (31)$$

$$L_k^T = \min\{f_k(x^{r*})\} \quad \text{where } r = 1, 2, \dots, k \quad (32)$$

For truth membership of objectives.

Step-4: We represent upper and lower bounds for indeterminacy and falsity membership of objectives as follows :

for $k = 1, 2, \dots, p$

$$U_k^F = U_k^T \quad \text{and} \quad L_k^F = L_k^T + t(U_k^T - L_k^T); \quad (33)$$

$$L_k^I = L_k^T \quad \text{and} \quad U_k^I = L_k^T + s(U_k^T - L_k^T) \quad (34)$$

Here t, s are predetermined real numbers in $(0, 1)$

Step-5: Define truth membership, indeterminacy membership and falsity membership functions as follows

for $k = 1, 2, \dots, p$

$$T_{f_k(x)}(f_k(x)) = \begin{cases} 1 & \text{if } f_k(x) \leq L_{f_k(x)}^T \\ 1 - \exp\left\{-\psi\left(\frac{U_{f_k(x)}^T - f_k(x)}{U_{f_k(x)}^T - L_{f_k(x)}^T}\right)\right\} & \text{if } L_{f_k(x)}^T \leq f_k(x) \leq U_{f_k(x)}^T \\ 0 & \text{if } f_k(x) \geq U_{f_k(x)}^T \end{cases} \quad (35)$$

$$I_{f_k(x)}(f_k(x)) = \begin{cases} 1 & \text{if } f_k(x) \leq L_{f_k(x)}^I \\ \exp\left\{\frac{U_{f_k(x)}^I - f_k(x)}{U_{f_k(x)}^I - L_{f_k(x)}^I}\right\} & \text{if } L_{f_k(x)}^I \leq f_k(x) \leq U_{f_k(x)}^I \\ 0 & \text{if } f_k(x) \geq U_{f_k(x)}^I \end{cases} \quad (36)$$

$$F_{f(x)}(f(x)) = \begin{cases} 0 & \text{if } f(x) \leq L_{f(x)}^F \\ \frac{1}{2} + \frac{1}{2} \tanh\left\{\left(f(x) - \frac{U_{f(x)}^F + L_{f(x)}^F}{2}\right)\tau_{f(x)}\right\} & \text{if } L_{f(x)}^F \leq f(x) \leq U_{f(x)}^F \\ 1 & \text{if } f(x) \geq U_{f(x)}^F \end{cases} \quad (37)$$

Step-6: Now neutrosophic optimization method for MONLP problem gives a equivalent nonlinear programming problem as:

$$\text{Maximize } (\alpha - \beta + \gamma) \quad (38)$$

such that

$$T_k(f_k(x)) \geq \alpha; \quad (39)$$

$$I_k(f_k(x)) \geq \gamma; \quad (40)$$

$$F_k(f_k(x)) \leq \beta; \quad (41)$$

$$\alpha + \beta + \gamma \leq 3; \quad (42)$$

$$\alpha \geq \beta; \alpha \geq \gamma; \quad (43)$$

$$\alpha, \beta, \gamma \in [0, 1]; \quad (44)$$

$$g_j(x) \leq b_j \quad x \geq 0, \quad (45)$$

$$k = 1, 2, \dots, p; \quad j = 1, 2, \dots, q$$

which is reduced to equivalent non linear programming problem as

$$\text{Maximize } (\theta - \eta + \kappa) \quad (46)$$

such that

$$f_k(x) + \frac{\theta(U_k^T - L_k^T)}{4} \leq L_k^T; \quad (47)$$

$$f_k(x) + \frac{\eta}{\tau_{f_k}} \leq \frac{U_k^T + L_k^T + \varepsilon_{f_k}}{2}; \quad (48)$$

$$f_k(x) + \kappa \xi_{f_k} \leq L_k^T + \xi_{f_k}; \text{ for } k = 1, 2, \dots, p \quad (49)$$

$$\text{where } \theta = -\log(1 - \alpha), \quad (50)$$

$$\kappa = \log \gamma, \quad (51)$$

$$\eta = -\tanh^{-1}(2\beta - 1), \quad (52)$$

$$\psi = 4, \quad (53)$$

$$\tau_{f_k} = \frac{6}{U_k^F - L_k^F} \quad (54)$$

$$\theta + \kappa + \eta \leq 3; \quad (55)$$

$$\theta \geq \kappa; \theta \geq \eta; \quad (56)$$

$$\theta, \kappa, \eta \in [0, 1]; \quad (57)$$

$$g_j(x) \leq b_j; \quad x \geq 0, \quad (58)$$

This crisp nonlinear programming problem can be solved by appropriate mathematical algorithm.

5 Solution of Multi-objective Structural Optimization Problem (MOSOP) by Neutrosophic Optimization Technique

To solve the MOSOP (1), step 1 of 4 is used. After that according to step 2 pay off matrix is formulated.

$$\begin{matrix} WT(A) & \delta(A) \\ A^1 \left[\begin{matrix} WT^*(A^1) & \delta(A^1) \end{matrix} \right] \\ A^2 \left[\begin{matrix} WT(A^2) & \delta^*(A^2) \end{matrix} \right] \end{matrix}$$

According to step-2 the bound of weight objective $U_{WT}^T, L_{WT}^T; U_{WT}^I, L_{WT}^I$ and U_{WT}^F, L_{WT}^F for truth, indeterminacy and falsity membership function respectively. Then

$L_{WT}^I \leq WT(A) \leq U_{WT}^I; L_{WT}^F \leq WT(A) \leq U_{WT}^F$. Similarly the bound of deflection objective are $U_{\delta}^T, L_{\delta}^T; U_{\delta}^I, L_{\delta}^I$ and $U_{\delta}^F, L_{\delta}^F$ are respectively for

truth, indeterminacy and falsity membership function. Then $L_\delta^I \leq \delta(A) \leq U_\delta^I$;
 $L_\delta^I \leq \delta(A) \leq U_\delta^I$; $L_\delta^F \leq \delta(A) \leq U_\delta^F$. Where $U_{WT}^F = U_{WT}^T$, $L_{WT}^F = L_{WT}^T + \varepsilon_{WT}$;
 $L_{WT}^I = L_{WT}^T$, $U_{WT}^I = L_{WT}^T + \varepsilon_{WT}$ (59)

and $U_\delta^F = U_\delta^T$, $L_\delta^F = L_\delta^T + \xi_\delta$; (60)

$L_\delta^I = L_\delta^T$, $U_\delta^I = L_\delta^T + \xi_\delta$ (61)

such that

$$0 < \varepsilon_{WT} < (U_{WT}^T - L_{WT}^T) \text{ and } 0 < \xi_\delta < (U_\delta^T - L_\delta^T).$$

Therefore the truth, indeterminacy and falsity membership functions for objectives are

$$T_{WT(A)}(WT(A)) = \begin{cases} 1 & \text{if } WT(A) \leq L_{WT(A)}^T \\ 1 - \exp\left\{-\psi\left(\frac{U_{WT(A)}^T - WT(A)}{U_{WT(A)}^T - L_{WT(A)}^T}\right)\right\} & \text{if } L_{WT(A)}^T \leq WT(A) \leq U_{WT(A)}^T \\ 0 & \text{if } WT(A) \geq U_{WT(A)}^T \end{cases} \quad (62)$$

$$I_{WT(A)}(WT(A)) = \begin{cases} 1 & \text{if } WT(A) \leq L_{WT(A)}^T \\ \exp\left\{\frac{(L_{WT(A)}^T + \xi_{WT}) - WT(A)}{\xi_{WT}}\right\} & \text{if } L_{WT(A)}^T \leq WT(A) \leq L_{WT(A)}^T + \xi_{WT} \\ 0 & \text{if } WT(A) \geq L_{WT(A)}^T + \xi_{WT} \end{cases} \quad (63)$$

$$F_{WT(A)}(WT(A)) = \begin{cases} 0 & \text{if } WT(A) \leq L_{WT(A)}^T + \varepsilon_{WT} \\ \frac{1}{2} + \frac{1}{2} \tanh\left\{\left[WT(A) - \frac{(U_{WT(A)}^T + L_{WT(A)}^T) + \varepsilon_{WT}}{2}\right] \tau_{WT}\right\} & \text{if } L_{WT(A)}^T + \varepsilon_{WT} \leq WT(A) \leq U_{WT(A)}^T \\ 1 & \text{if } WT(A) \geq U_{WT(A)}^T \end{cases} \quad (64)$$

where $0 < \varepsilon_{WT}, \xi_{WT} < (U_{WT}^T - L_{WT}^T)$

and

$$T_{\delta(A)}(\delta(A)) = \begin{cases} 1 & \text{if } \delta(A) \leq L_\delta^T \\ 1 - \exp\left\{-\psi\left(\frac{U_\delta^T - \delta(A)}{U_\delta^T - L_\delta^T}\right)\right\} & \text{if } L_\delta^T \leq \delta(A) \leq U_\delta^T \\ 0 & \text{if } \delta(A) \geq U_\delta^T \end{cases} \quad (65)$$

$$I_{\delta(A)}(\delta(A)) = \begin{cases} 1 & \text{if } \delta(A) \leq L_{\delta}^T \\ \exp\left\{\frac{(L_{\delta}^T + \xi_{\delta}) - \delta(A)}{\xi_{\delta}}\right\} & \text{if } L_{\delta}^T \leq \delta(A) \leq L_{\delta}^T + \xi_{\delta} \\ 0 & \text{if } \delta(A) \geq L_{\delta}^T + \xi_{\delta} \end{cases} \quad (66)$$

$$F_{\delta(A)}(\delta(A)) = \begin{cases} 0 & \text{if } \delta(A) \leq L_{\delta}^T + \varepsilon_{\delta} \\ \frac{1}{2} + \frac{1}{2} \tanh\left\{\left[\delta(A) - \frac{(U_{\delta}^T + L_{\delta}^T) + \varepsilon_{\delta}}{2}\right] \tau_{\delta}\right\} & \text{if } L_{\delta}^T + \varepsilon_{\delta} \leq \delta(A) \leq U_{\delta}^T \\ 1 & \text{if } \delta(A) \geq U_{\delta}^T \end{cases} \quad (67)$$

where ψ, τ are non-zero parameters prescribed by the decision maker and for where $0 < \varepsilon_{\delta}, \xi_{\delta} < (U_{\delta}^T - L_{\delta}^T)$

According to neutrosophic optimization technique considering truth, indeterminacy and falsity membership function for MOSOP (1), crisp non-linear programming problem can be formulated as

$$\text{Maximize } (\alpha + \gamma - \beta) \quad (68)$$

Subject to

$$T_{WT}(WT(A)) \geq \alpha; \quad (69)$$

$$T_{\delta}(\delta(A)) \geq \alpha; \quad (70)$$

$$I_{WT}(WT(A)) \geq \gamma; \quad (71)$$

$$I_{\delta}(\delta(A)) \geq \gamma; \quad (72)$$

$$F_{WT}(WT(A)) \leq \beta; \quad (73)$$

$$F_{\delta}(\delta(A)) \leq \beta; \quad (74)$$

$$\sigma(A) \leq [\sigma]; \quad (75)$$

$$\alpha + \beta + \gamma \leq 3; \alpha \geq \beta; \alpha \geq \gamma; \quad (76)$$

$$\alpha, \beta, \gamma \in [0, 1], \quad (77)$$

$$A^{\min} \leq A \leq A^{\max} \quad (78)$$

which is reduced to equivalent non linear programming problem as

$$\text{Maximize } (\theta + \kappa - \eta) \quad (79)$$

Such that

$$WT(A) + \theta \frac{(U_{WT}^T - L_{WT}^T)}{\psi} \leq U_{WT}^T; \quad (80)$$

$$WT(A) + \frac{\eta}{\tau_{WT}} \leq \frac{U_{WT}^T + L_{WT}^T + \varepsilon_{WT}}{2}; \quad (81)$$

$$WT(A) + \kappa \xi_{WT} \leq L_{WT}^T + \xi_{WT}; \quad (82)$$

$$\delta(A) + \theta \frac{(U_{\delta}^T - L_{\delta}^T)}{\psi} \leq U_{\delta}^T; \quad (83)$$

$$\delta(A) + \kappa \xi_{\delta} \leq L_{\delta}^T + \xi_{\delta}; \quad (84)$$

$$\delta(A) + \frac{\eta}{\tau_{\delta}} \leq \frac{U_{WT}^T + L_{WT}^T + \varepsilon_{\delta}}{2}; \quad (85)$$

$$\theta + \kappa - \eta \leq 3; \quad (86)$$

$$\theta \geq \kappa; \theta \geq \eta; \quad (87)$$

$$\theta, \kappa, \eta \in [0, 1] \quad (88)$$

$$\text{where } \theta = -\ln(1 - \alpha); \quad (89)$$

$$\psi = 4; \quad (90)$$

$$\tau_{WT} = \frac{6}{(U_{WT}^F - L_{WT}^F)}; \quad (91)$$

$$\tau_{\sigma_i} = \frac{6}{(U_{\sigma_i}^F - L_{\sigma_i}^F)}; \quad (92)$$

$$\kappa = \ln \gamma; \quad (93)$$

$$\eta = -\tanh^{-1}(2\beta - 1). \quad (94)$$

Solving the above crisp model (79-94) by an appropriate mathematical programming algorithm we get optimal solution and hence objective functions i.e structural weight and deflection of the loaded joint will attain Pareto optimal solution.

6 Numerical Illustration

A well known three bar planer truss is considered to minimize weight of the structure $WT(A_1, A_2)$ and minimize the deflection $\delta(A_1, A_2)$ at a loading point of a statistically loaded three bar planer truss subject to stress constraints on each of the truss members

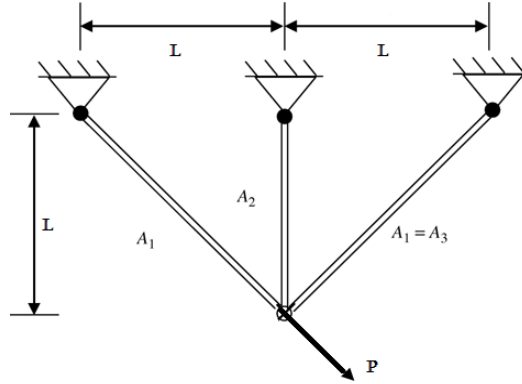

Fig. 1. Design of the three-bar planar truss

The multi-objective optimization problem can be stated as follows

$$\text{Minimize } WT(A_1, A_2) = \rho L(2\sqrt{2}A_1 + A_2) \quad (95)$$

$$\text{Minimize } \delta(A_1, A_2) = \frac{PL}{E(A_1 + \sqrt{2}A_2)} \quad (96)$$

Subject to

$$\sigma_1(A_1, A_2) = \frac{P(\sqrt{2}A_1 + A_2)}{(2A_1^2 + 2A_1A_2)} \leq [\sigma_1^T]; \quad (97)$$

$$\sigma_2(A_1, A_2) = \frac{P}{(A_1 + \sqrt{2}A_2)} \leq [\sigma_2^T]; \quad (98)$$

$$\sigma_3(A_1, A_2) = \frac{PA_2}{(2A_1^2 + 2A_1A_2)} \leq [\sigma_3^C]; \quad (99)$$

$$A_i^{\min} \leq A_i \leq A_i^{\max} \quad i = 1, 2 \quad (100)$$

where P = applied load ; ρ = material density ; L = length ; E = Young's modulus ; A_1, A_3 = Cross section of bar-1 and bar-3; A_2 = Cross section of bar-2; δ is deflection of loaded joint. $[\sigma_1^T]$ and $[\sigma_2^T]$ are maximum allowable tensile stress for bar 1 and bar 2 respectively, $[\sigma_3^C]$ is maximum allowable compressive stress for bar 3.

Table 1: Input data for crisp model (79-94)

Applied load P (KN)	Volume density ρ (KN/m^3)	Length L (m)	Maximum allowable tensile stress $[\sigma_1^T]$ (KN/m^2)	Maximum allowable compressive stress $[\sigma_3^C]$ (KN/m^2)	Young's modulus E (KN/m^2)	A_i^{\min} and A_i^{\max} of cross section of bars ($10^{-4} m^2$)
20	100	1	20	15	2×10^7	$A_1^{\min} = 0.1$ $A_1^{\max} = 5$ $A_2^{\min} = 0.1$ $A_2^{\max} = 5$

Solution: According to step 2 of 4, pay-off matrix is formulated as follows

$$\begin{matrix}
 & WT(A_1, A_2) & \delta(A_1, A_2) \\
 \begin{matrix} A^1 \\ A^2 \end{matrix} & \begin{bmatrix} 2.638958 & 14.64102 \\ 19.14214 & 1.656854 \end{bmatrix}
 \end{matrix}$$

Here

$$U_{WT}^F = U_{WT}^T = 19.14214, \tag{101}$$

$$L_{WT}^F = L_{WT}^T + \varepsilon_1 = 2.638958 + \varepsilon_1; \tag{102}$$

$$L_{WT}^I = L_{WT}^T = 2.638958, \tag{103}$$

$$U_{WT}^I = L_{WT}^T + \xi_1 = 2.638958 + \xi_1 \tag{104}$$

such that $0 < \varepsilon_1, \xi_1 < (19.14214 - 2.638958)$;

$$U_{\delta}^F = U_{\delta}^T = 14.64102, \tag{105}$$

$$L_{\delta}^F = L_{\delta}^T + \varepsilon_2 = 1.656854 + \varepsilon_2; \tag{106}$$

$$L_{\delta}^I = L_{\delta}^T = 1.656854, \tag{107}$$

$$U_{\delta}^I = L_{\delta}^T + \xi_2 = 1.656854 + \xi_2 \tag{108}$$

such that $0 < \varepsilon_2, \xi_2 < (14.64102 - 1.656854)$

.

Here truth, indeterminacy, and falsity membership function for objective functions $WT(A_1, A_2), \delta(A_1, A_2)$ are defined as follows

$$T_{WT(A_1, A_2)}(WT(A_1, A_2)) = \begin{cases} 1 & \text{if } WT(A_1, A_2) \leq 2.638958 \\ 1 - \exp\left\{-4\left(\frac{19.14214 - WT(A_1, A_2)}{16.503182}\right)\right\} & \text{if } 2.638958 \leq WT(A_1, A_2) \leq 19.14214 \\ 0 & \text{if } WT(A_1, A_2) \geq 19.14214 \end{cases}$$

(109)

$$I_{WT(A_1, A_2)}(WT(A_1, A_2)) = \begin{cases} 1 & \text{if } WT(A_1, A_2) \leq 2.638958 \\ \exp\left\{\frac{(2.638958 + \xi_1) - WT(A_1, A_2)}{\xi_1}\right\} & \text{if } 2.638958 \leq WT(A_1, A_2) \leq 2.638958 + \xi_1 \\ 0 & \text{if } WT(A_1, A_2) \geq 2.638958 + \xi_1 \end{cases}$$

(110)

$$F_{WT(A_1, A_2)}(WT(A_1, A_2)) = \begin{cases} 0 & \text{if } WT(A_1, A_2) \leq 2.638958 \\ \frac{1}{2} + \frac{1}{2} \tanh\left\{\left(WT(A_1, A_2) - \frac{21.781098 + \varepsilon_1}{2}\right) \frac{6}{(16.503182 - \varepsilon_1)}\right\} & \text{if } 2.638958 \leq WT(A_1, A_2) \leq 19.14214 \\ 1 & \text{if } WT(A_1, A_2) \geq 19.14214 \end{cases}$$

(111)

$$0 < \varepsilon_1, \xi_1 < 16.503182$$

and

$$T_{\delta(A_1, A_2)}(\delta(A_1, A_2)) = \begin{cases} 1 & \text{if } \delta(A_1, A_2) \leq 1.656854 \\ 1 - \exp\left\{-4\left(\frac{14.64102 - \delta(A_1, A_2)}{12.984166}\right)\right\} & \text{if } 1.656854 \leq \delta(A_1, A_2) \leq 14.64102 \\ 0 & \text{if } \delta(A_1, A_2) \geq 14.64102 \end{cases}$$

(112)

$$I_{\delta(A_1, A_2)}(\delta(A_1, A_2)) = \begin{cases} 1 & \text{if } \delta(A_1, A_2) \leq 1.656854 \\ \exp\left\{\frac{(1.656854 + \xi_2) - \delta(A_1, A_2)}{\xi_2}\right\} & \text{if } 1.656854 \leq \delta(A_1, A_2) \leq 1.656854 + \xi_2 \\ 0 & \text{if } \delta(A_1, A_2) \geq 1.656854 + \xi_2 \end{cases}$$

(113)

$$F_{\delta(A_1, A_2)}(\delta(A_1, A_2)) = \begin{cases} 0 & \text{if } \delta(A_1, A_2) \leq 1.656854 + \varepsilon_2 \\ \frac{1}{2} + \frac{1}{2} \tanh\left\{\left(\delta(A_1, A_2) - \frac{16.297874 + \varepsilon_2}{2}\right) \frac{6}{12.984166 - \varepsilon_2}\right\} & \text{if } 1.656854 + \varepsilon_2 \leq \delta(A_1, A_2) \leq 14.64102 \\ 1 & \text{if } \delta(A_1, A_2) \geq 14.64102 \end{cases}$$

(114)

$$0 < \varepsilon_2, \xi_2 < 12.9842$$

According to neutrosophic optimization technique the MOSOP (95-100) can be formulated as

$$\text{Maximize } (\theta + \kappa - \eta) \tag{115}$$

Such that

$$(2\sqrt{2}A_1 + A_2) + 4.1257\theta \leq 19.14214; \tag{116}$$

$$(2\sqrt{2}A_1 + A_2) + \frac{\eta(16.503182 - \varepsilon_1)}{6} \leq \frac{(21.781098 + \varepsilon_1)}{2}; \tag{117}$$

$$(2\sqrt{2}A_1 + A_2) + \kappa\xi_1 \leq (2.638958 + \xi_1); \tag{118}$$

$$\frac{20}{(A_1 + \sqrt{2}A_2)} + 3.2460415\theta \leq 14.64102; \tag{119}$$

$$\frac{20}{(A_1 + \sqrt{2}A_2)} + \frac{\eta(12.984166 - \varepsilon_2)}{6} \leq \frac{(16.297874 + \varepsilon_2)}{2}; \tag{120}$$

$$\frac{20}{(A_1 + \sqrt{2}A_2)} + \kappa\xi_2 \leq (1.656854 + \xi_2); \tag{121}$$

$$\frac{20(\sqrt{2}A_1 + A_2)}{(2A_1^2 + 2A_1A_2)} \leq 20; \tag{122}$$

$$\frac{20}{(A_1 + \sqrt{2}A_2)} \leq 20; \tag{123}$$

$$\frac{20A_2}{(2A_1^2 + 2A_1A_2)} \leq 15; \tag{124}$$

$$\theta + \kappa + \eta \leq 3; \tag{125}$$

$$\theta \geq \kappa; \tag{126}$$

$$\theta \geq \eta \tag{127}$$

$$0.1 \leq A_1 + A_2 \leq 5 \tag{128}$$

Now , using above mentioned truth, indeterminacy and falsity membership function NLP (95-100) can be solved by NSO technique for different values of $\varepsilon_1, \varepsilon_2$ and ξ_1, ξ_2 . The optimum solution of MOSOP(95-100) is given in table (2) .

Table 2: Comparison of Optimal solution of MOSOP (95-100) based on different method

Methods	A_1 $\times 10^{-4} m^2$	A_2 $\times 10^{-4} m^2$	$WT(A_1, A_2)$ $\times 10^2 KN$	$\delta(A_1, A_2)$ $\times 10^{-7} m$
Neutrosophic optimization (NSO) with linear membership function $\varepsilon_1 = 3.30064, \varepsilon_2 = 2.59696$ $\xi_1 = 1.65032, \xi_2 = 1.29848$.5777658	2.655110	4.289278	2.955334
Neutrosophic optimization (NSO) with nonlinear membership function $\varepsilon_1 = 3.30064, \varepsilon_2 = 2.59696$ $\xi_1 = 1.65032, \xi_2 = 1.29848$.5777658	2.655110	4.289278	2.955334

Here we get same solutions for the different tolerance ξ_1, ξ_2 and ξ_3 for indeterminacy membership function of objective functions. From the table 2, it shows that NSO technique gives same Pareto optimal result for linear and non-linear membership functions in the perspective of Structural Optimization.

7 Conclusion

The main objective of this work is to illustrate how neutrosophic optimization technique can be utilized to solve a nonlinear structural problem. The concept of neutrosophic optimization technique allows one to define a degree of truth membership, which is not a complement of degree of falsity; rather, they are independent with degree of indeterminacy. In this problem, actually, we investigate the effect of non-linear truth, indeterminacy and falsity membership function of neutrosophic set in perspective of multi-objective structural optimization. Here we have considered a non-linear three bar truss design problem. In this test problem, we find out minimum weight of the structure as well as minimum deflection of loaded joint. The comparisons of results obtained for the undertaken problem clearly show the superiority of neutrosophic optimization over fuzzy optimization. The results of this study may lead to the development of effective neutrosophic technique for solving other model of nonlinear programming problem in different field.

Acknowledgement

The research work of MridulaSarkar is financed by Rajiv Gandhi National Fellowship (F1-17.1/2013-14-SC-wes-42549/(SA-III/Website)), Govt of India.

References

- [1] Atanassov, K. T. Intuitionistic fuzzy sets. *Fuzzy Sets and Systems*1986:20(1): 87-96.
- [2] Zadeh, L.A. Fuzzy set. *Information and Control*.1965: 8(3):338-353.
- [3] Rao, S. S. Description and optimum design of fuzzy mechanical systems. *Journal of Mechanisms, Transmissions, and Automation in Design*.1987: 109(1):126-132.
- [4] Bellman, R. E., &Zadeh, L. A. Decision-making in a fuzzy environment. *Management science*,1970:17(4): B-141.
- [5] Shih, C. J., Chi, C. C., & Hsiao, J. H. Alternative α -level-cuts methods for optimum structural design with fuzzy resources. *Computers & structures*.2003: 81(28):2579-2587.
- [6] Shih, C. J., & Lee, H. W. Level-cut approaches of first and second kind for unique solution design in fuzzy engineering optimization problems. *Tamkang Journal of Science and Engineering*,2004:7(3):189-198.
- [7] Smarandache, F. (1998). *Neutrosophy, neutrosophic probability, set and logic*, Amer. Res. Press, Rehoboth, USA, 105.
- [8] Wang, G.Y. & Wang, W.Q. Fuzzy optimum design of structure. *Engineering Optimization*.1985:8:291-300
- [9] Yeh, Y.C. & Hsu, D.S. Structural optimization with fuzzy parameters. *Computer and Structure*.1990:37(6): 917-924.
- [10] Changwen, X. Fuzzy optimization of structures by the two-phase method. *Computers & Structures*.1989:31(4): 575-580.
- [11] Dey, S., & Roy, T. K. A Fuzzy programming Technique for Solving Multi-objective Structural Problem. *International Journal of Engineering and Manufacturing*.2014: 4(5): 24.
- [12] Dey, S., & Roy, T. K. Optimized solution of two bar truss design using intuitionistic fuzzy optimization technique. *International Journal of Information Engineering and Electronic Business*.2014: 6(4): 45.
- [13] Dey, S., & Roy, T. K. Multi-objective structural design problem optimization using parameterized t-norm based fuzzy optimization programming Technique. *Journal of Intelligent and Fuzzy Systems*.2016:30(2): 971-982.
- [14] Dey, S., & Roy, T. Optimum shape design of structural model with imprecise coefficient by parametric geometric programming. *Decision Science Letters*.2015:4(3): 407-418.
- [15] Jana, B., & Roy, T. K. Multi-objective intuitionistic fuzzy linear programming and its application in transportation model. *Notes on Intuitionistic Fuzzy Sets*.2007: 13(1): 34-51.
- [16] Dey, S., & Roy, T. K. Multi-objective structural optimization using fuzzy and intuitionistic fuzzy optimization technique. *International Journal of Intelligent systems and applications*.2015:7(5):57.
- [17] Abdel-Basset, Mohamed, et al. "A novel group decision-making model based on triangular neutrosophic numbers." *Soft Computing* (2017): 1-15. DOI: <https://doi.org/10.1007/s00500-017-2758-5>
- [18] Hussian, Abdel-Nasser, et al. "Neutrosophic Linear Programming Problems." *Peer Reviewers*: 15.
- [19] Abdel-Basset, Mohamed, Mai Mohamed, and Arun Kumar Sangaiah. "Neutrosophic AHP-Delphi Group decision making model based on trapezoidal neutrosophic numbers." *Journal of Ambient Intelligence and Humanized Computing* (2017): 1-17. DOI: <https://doi.org/10.1007/s12652-017-0548-7>
- [20] Mohamed, Mai, et al. "A Critical Path Problem in Neutrosophic Environment." *Peer Reviewers*: 167.

[21] Mridula Sarkar, Samir Dey, Tapan Kumar Roy: Truss Design Optimization using Neutrosophic Optimization Technique, *Neutrosophic Sets and Systems*, vol. 13, 2016, pp. 62-69. doi.org/10.5281/zenodo.570869

[22] Pintu Das, Tapan Kumar Roy: Multi-objective non-linear programming problem based on Neutrosophic Optimization Technique and its application in Riser Design Problem, *Neutrosophic Sets and Systems*, vol. 9, 2015, pp. 88-95. doi.org/10.5281/zenodo.571480

[23] Mona Gamal Gafar, Ibrahim El-Henawy: Integrated Framework of Optimization Technique and Information Theory Measures for Modeling Neutrosophic Variables, *Neutrosophic Sets and Systems*, vol. 15, 2017, pp. 80-89. doi.org/10.5281/zenodo.570939

[24] Naga Raju I, Rajeswara Reddy P, Dr. Diwakar Reddy V, Dr. Krishnaiah G: Real Life Decision Optimization Model, *Neutrosophic Sets and Systems*, vol. 14, 2016, pp. 71-79. doi.org/10.5281/zenodo.570889

[25] Wenzhong Jiang, Jun Ye: Optimal Design of Truss Structures Using a Neutrosophic Number Optimization Model under an Indeterminate Environment, *Neutrosophic Sets and Systems*, vol. 14, 2016, pp. 93-97. doi.org/10.5281/zenodo.570888

[26] Mohamed, Mai, et al. "A Critical Path Problem Using Triangular Neutrosophic Number." *Peer Reviewers*: 155.

[27] Mohamed, Mai, et al. "Using Neutrosophic Sets to Obtain PERT Three-Times Estimates in Project Management." *Peer Reviewers*: 143.

[28] Mohamed, Mai, et al. "Neutrosophic Integer Programming Problem." *Neutrosophic Sets & Systems* 15 (2017).

[29] Abdel-Baset, Mohamed, Ibrahim M. Hezam, and Florentin Smarandache. "Neutrosophic goal programming." *Neutrosophic Sets Syst* 11 (2016): 112-118.

[30] Hezam, Ibrahim M., Mohamed Abdel-Baset, and Florentin Smarandache. "Taylor series approximation to solve neutrosophic multiobjective programming problem." *Neutrosophic Sets and Systems* 10 (2015): 39-46.

[31] El-Hefenawy, Nancy, et al. "A review on the applications of neutrosophic sets." *Journal of Computational and Theoretical Nanoscience* 13.1 (2016): 936-944.

VIII

Multi-Objective Welded Beam Optimization using Neutrosophic Goal Programming Technique

Mridula Sarkar¹ • Tapan Kumar Roy²

¹Indian Institute of Engineering Science and Technology, Shibpur, P.O-Botanic Garden, Howrah-711103,
India. Email: mridula.sarkar86@rediffmail.com

²Indian Institute of Engineering Science and Technology, Shibpur, P.O-Botanic Garden, Howrah-711103,
India. Email: roy_t_k@yahoo.co.in

Abstract

This paper investigates multi-objective Neutrosophic Goal Optimization (NSGO) approach to optimize the cost of welding and deflection at the tip of a welded steel beam, while the maximum shear stress in the weld group, maximum bending stress in the beam, and buckling load of the beam have been considered as constraints. The problem of designing an optimal welded beam consists of dimensioning a welded steel beam and the welding length so as to minimize its cost, subject to the constraints as stated above. The classical welded beam design structure is presented here in to demonstrate the efficiency of the neutrosophic goal programming approach. The model is numerically illustrated by generalized NSGO technique with different aggregation method. The result shows that the Neutrosophic Goal Optimization technique is very efficient in finding the best optimal solutions.

Keywords

Neutrosophic Set; Single Valued Neutrosophic Set; Generalized Neutrosophic Goal Programming; Arithmetic Aggregation; Geometric Aggregation; Welded Beam Design Optimization.

1 Introduction

Welding, a process of joining metallic parts with the application of heat or pressure or the both, with or without added material, is an economical and efficient method for obtaining permanent joints in the metallic parts. This welded

joints are generally used as a substitute for riveted joint or can be used as an alternative method for casting or forging. The welding processes can broadly be classified into following two groups, the welding process that uses heat alone to join two metallic parts and the welding process that uses a combination of heat and pressure for joining (Bhandari. V. B). However, above all the design of welded beam should preferably be economical and durable one. Since decades, deterministic optimization has been widely used in practice for optimizing welded connection design. These include mathematical optimization algorithms (Ragsdell & Phillips 1976) such as APPROX (Griffith & Stewart's) successive linear approximation, DAVID (Davidon Fletcher Powell with a penalty function), SIMPLEX (Simplex method with a penalty function), and RANDOM (Richardson's random method) algorithms, GA-based methods (Deb 1991, Deb 2000, Coello 2000b, Coello 2008), particle swarm optimization (Reddy 2007), harmony search method (Lee & Geem 2005), and Big-Bang Big-Crunch (BB-BC) (O. Hasançebi, 2011) algorithm. SOPT (O. Hasançebi, 2012), subset simulation (Li 2010), improved harmony search algorithm (Mahadavi 2007), were other methods used to solve this problem. Recently a robust and reliable H_{∞} static output feedback (SOF) control for nonlinear systems (Yanling Wei 2016) and for continuous-time nonlinear stochastic systems (Yanling Wei 2016) with actuator fault in a descriptor system framework have been studied. All these deterministic optimizations aim to search the optimum solution under given constraints without consideration of uncertainties. So, while a deterministic optimization approach is unable to handle structural performances such as imprecise stresses and deflection etc. due to the presence of uncertainties, to get rid of such problem fuzzy (Zadeh, 1965), intuitionistic fuzzy (Atanassov, 1986), Neutrosophic [7,21-30] play great roles. Traditionally structural design optimization is a well known concept and in many situations it is treated as single objective form, where the objective is known the weight or cost function. The extension of this is the optimization where one or more constraints are simultaneously satisfied next to the minimization of the weight or cost function. This does not always hold good in real world problems where multiple and conflicting objectives frequently exist. In this consequence a methodology known as multi-objective optimization (MOSO) is introduced. So to deal with different impreciseness such as stresses and deflection with multiple objective, we have been motivated to incorporate the concept of neutrosophic set in this problem, and have developed multi-objective neutrosophic optimization algorithm to optimize the optimum design. Usually Intuitionistic fuzzy set, which is the generalization of fuzzy sets, considers both truth membership and falsity membership that can handle incomplete information excluding the indeterminate and inconsistent information while neutrosophic set can quantify indeterminacy explicitly by defining truth, indeterminacy and falsity membership function

independently. Therefore, Wang et.al (2010) presented such set as single valued neutrosophic set (SVNS) as it comprised of generalized classic set, fuzzy set, interval valued fuzzy set, intuitionistic fuzzy set and Para-consistent set. As application of SVNS optimization method is rare in welded beam design, hence it is used to minimize the cost of welding by considering shear stress, bending stress in the beam, the buckling load on the bar, the deflection of the beam as constraints. Therefore the result has been compared among three cited methods in each of which impreciseness has been considered completely in different way. Moreover using above cited concept, a multi-objective neutrosophic optimization algorithm has been developed to optimize three bar truss design (Sarkar 2016), and to optimize riser design problem (Das 2015). In early 1961 Charnes and Cooper first introduced Goal programming problem for a linear model.

Usually conflicting goal are presented in a multi-objective goal programming problem. Dey et al.(2015) used intuitionistic goal programming on nonlinear structural model. However, the factors governing of former constraints are height and length of the welded beam, forces on the beam, moment of load about the centre of gravity of the weld group, polar moment of inertia of the weld group respectively.

While, the second constraint considers forces on the beam, length and size of the weld, depth and width of the welded beam respectively. Third constraint includes height and width of the welded beam. Fourth constraints consists of height, length, depth and width of the welded beam. Lastly fifth constraint includes height of the welded beam. Besides, flexibility has been given in shear stress, bending stress and deflection only, hence all these parameters become imprecise in nature so that it can be considered as neutrosophic set to from truth, indeterminacy and falsity membership functions. Ultimately, neutrosophic optimization technique has been applied on the basis of the cited membership functions and outcome of such process provides the minimum cost of welding, minimum deflection for nonlinear welded beam design.

The comparison of results shows difference between the optimum value when partially unknown information is fully considered or not. This is the first time NSGO technique is in application to multi-objective welded beam design. The present study investigates computational algorithm for solving multi-objective welded beam problem by single valued generalized NSGO technique. The results are compared numerically for different aggregation method of NSGO technique. From our numerical result, it has been seen that the best result obtained for geometric aggregation method for NSGO technique in the perspective of structural optimization technique.

2 Multi-objective Structural Model

In sizing optimization problems, the aim is to minimize multi objective function, usually the cost of the structure, deflection under certain behavioural constraints which are displacement or stresses. The design variables are most frequently chosen to be dimensions of the height, length, depth and width of the structures. Due to fabrications limitations the design variables are not continuous but discrete for belongingness of cross-sections to a certain set. A discrete structural optimization problem can be formulated in the following form

(P1)

$$\text{Minimize } C(X) \quad (1)$$

$$\text{Minimize } \delta(X) \quad (2)$$

$$\text{subject to } \sigma_i(X) \leq [\sigma_i(X)], i = 1, 2, \dots, m \quad (3)$$

$$X_j \in R^d, \quad j = 1, 2, \dots, n \quad (4)$$

where $C(X)$, $\delta(X)$ and $\sigma_i(X)$ as represent cost function, deflection and the behavioural constraints respectively whereas $[\sigma_i(X)]$ denotes the maximum allowable value, 'm' and 'n' are the number of constraints and design variables respectively. A given set of discrete value is expressed by R^d and in this paper objective functions are taken as

$$C(X) = \sum_{i=1}^T c_i \prod_{n=1}^m x_n^m \quad \text{and} \quad \delta(X)$$

and constraint are chosen to be stress of structures as follows

$$\sigma_i(A) \leq \sigma_i \quad \text{with allowable tolerance } \sigma_i^0 \text{ for } i = 1, 2, \dots, m$$

where c_i is the cost coefficient of i^{th} side and x_n is the n^{th} design variable respectively, m is the number of structural element, σ_i and σ_i^0 are the i^{th} stress, allowable stress respectively

3 Mathematical Preliminaries

In the following, we briefly describe some basic concepts and basic operational laws related to neutrosophic set

3.1 Fuzzy Set (FS)

Let X be a fixed set. A fuzzy set \tilde{A} of X is an object having the form

$$\tilde{A} = \{(x, T_{\tilde{A}}(x)) | x \in X\} \quad (5)$$

where the function $T_{\tilde{A}} : X \rightarrow [0,1]$ stands for the truth membership of the element $x \in X$ to the set \tilde{A} .

3.2 Intuitionistic Fuzzy Set(IFS)

Let a set X be fixed. An intuitionistic fuzzy set or IFS \tilde{A}^i in X is an object of the form $\tilde{A}^i = \{(x, T_{\tilde{A}^i}(x), F_{\tilde{A}^i}(x)) | x \in X\}$ (6)

where $T_{\tilde{A}^i} : X \rightarrow [0,1]$ and $F_{\tilde{A}^i} : X \rightarrow [0,1]$ define the truth membership and falsity membership respectively, for every element of $x \in X$ such that $0 \leq T_{\tilde{A}^i}(x) + F_{\tilde{A}^i}(x) \leq 1$.

3.3 Single-Valued Neutrosophic Set (SVNS)

Let a set X be the universe of discourse. A single valued neutrosophic set \tilde{A}^n over X is an object having the form

$$\tilde{A}^n = \{(x, T_{\tilde{A}^n}(x), I_{\tilde{A}^n}(x), F_{\tilde{A}^n}(x)) | x \in X\} \quad (7)$$

where $T_{\tilde{A}^n} : X \rightarrow [0,1]$, $I_{\tilde{A}^n} : X \rightarrow [0,1]$ and $F_{\tilde{A}^n} : X \rightarrow [0,1]$ are truth, indeterminacy and falsity membership functions respectively so as to $0 \leq T_{\tilde{A}^n}(x) + I_{\tilde{A}^n}(x) + F_{\tilde{A}^n}(x) \leq 3$ for all $x \in X$.

3.4 Union of Neutrosophic Sets (NSs)

The union of two single valued neutrosophic sets \tilde{A}^n and \tilde{B}^n is a single valued neutrosophic set \tilde{U}^n denoted by

$$\tilde{U}^n = \tilde{A}^n \cup \tilde{B}^n = \{(x, T_{\tilde{U}^n}(x), I_{\tilde{U}^n}(x), F_{\tilde{U}^n}(x)) | x \in X\} \quad (8)$$

and is defined by the following conditions

- (i) $T_{\tilde{U}^n}(x) = \max(T_{\tilde{A}^n}(x), T_{\tilde{B}^n}(x))$,
- (ii) $I_{\tilde{U}^n}(x) = \max(I_{\tilde{A}^n}(x), I_{\tilde{B}^n}(x))$,
- (iii) $F_{\tilde{U}^n}(x) = \min(F_{\tilde{A}^n}(x), F_{\tilde{B}^n}(x))$ for all $x \in X$ for Type-I

Or in another way by defining following conditions

$$(i) T_{\tilde{U}^n}(x) = \max(T_{\tilde{A}^n}(x), T_{\tilde{B}^n}(x)),$$

$$(ii) I_{\tilde{U}^n}(x) = \min(I_{\tilde{A}^n}(x), I_{\tilde{B}^n}(x))$$

$$(iii) F_{\tilde{U}^n}(x) = \min(F_{\tilde{A}^n}(x), F_{\tilde{B}^n}(x)) \text{ for all } x \in X \text{ for Type-II}$$

where $T_{\tilde{U}^n}(x)$, $I_{\tilde{U}^n}(x)$, $F_{\tilde{U}^n}(x)$ represent truth membership, indeterminacy-membership and falsity-membership functions of union of neutrosophic sets

Example:

Let $\tilde{A}^n = \langle 0.3, 0.4, 0.5 \rangle / x_1 + \langle 0.5, 0.2, 0.3 \rangle / x_2 + \langle 0.7, 0.2, 0.2 \rangle / x_3$ and

$\tilde{B}^n = \langle 0.6, 0.1, 0.2 \rangle / x_1 + \langle 0.3, 0.2, 0.6 \rangle / x_2 + \langle 0.4, 0.1, 0.5 \rangle / x_3$ be two neutrosophic sets. Then the union of \tilde{A}^n and \tilde{B}^n is a single valued neutrosophic set can be calculated for

Type -I as

$$\tilde{A}^n \cup \tilde{B}^n = \langle 0.6, 0.4, 0.2 \rangle / x_1 + \langle 0.5, 0.2, 0.3 \rangle / x_2 + \langle 0.7, 0.2, 0.2 \rangle / x_3 \quad (9)$$

and for Type -II as

$$\tilde{A}^n \cup \tilde{B}^n = \langle 0.6, 0.1, 0.2 \rangle / x_1 + \langle 0.5, 0.2, 0.3 \rangle / x_2 + \langle 0.7, 0.1, 0.2 \rangle / x_3 \quad (10)$$

3.5 Intersection of Neutrosophic Sets

The intersection of two single valued neutrosophic sets \tilde{A}^n and \tilde{B}^n is a single valued neutrosophic set \tilde{E}^n is denoted by

$$\tilde{E}^n = \tilde{A}^n \cap \tilde{B}^n = \{ (x, T_{\tilde{E}^n}(x), I_{\tilde{E}^n}(x), F_{\tilde{E}^n}(x)) | x \in X \} \quad (11)$$

and is defined by the following conditions

$$(i) T_{\tilde{E}^n}(x) = \min(T_{\tilde{A}^n}(x), T_{\tilde{B}^n}(x)),$$

$$(ii) I_{\tilde{E}^n}(x) = \min(I_{\tilde{A}^n}(x), I_{\tilde{B}^n}(x)),$$

$$(iii) F_{\tilde{E}^n}(x) = \max(F_{\tilde{A}^n}(x), F_{\tilde{B}^n}(x)) \text{ for all } x \in X \text{ for Type-I}$$

Or in another way by defining following conditions

$$(i) T_{\tilde{E}^n}(x) = \min(T_{\tilde{A}^n}(x), T_{\tilde{B}^n}(x)),$$

$$(ii) I_{\tilde{E}^n}(x) = \max(I_{\tilde{A}^n}(x), I_{\tilde{B}^n}(x))$$

$$(iii) F_{\tilde{E}^n}(x) = \max(F_{\tilde{A}^n}(x), F_{\tilde{B}^n}(x)) \text{ for all } x \in X \text{ for Type-II}$$

where $T_{\tilde{E}^n}(x)$, $I_{\tilde{E}^n}(x)$, $F_{\tilde{E}^n}(x)$ represent truth membership, indeterminacy-membership and falsity-membership functions of union of neutrosophic sets

Example:

Let $\tilde{A}^n = \langle 0.3, 0.4, 0.5 \rangle / x_1 + \langle 0.5, 0.2, 0.3 \rangle / x_2 + \langle 0.7, 0.2, 0.2 \rangle / x_3$ and

$\tilde{B}^n = \langle 0.6, 0.1, 0.2 \rangle / x_1 + \langle 0.3, 0.2, 0.6 \rangle / x_2 + \langle 0.4, 0.1, 0.5 \rangle / x_3$ be two neutrosophic sets. Then the union of \tilde{A}^n and \tilde{B}^n is a single valued neutrosophic set can be measured for

Type -I as

$$\tilde{A}^n \cap \tilde{B}^n = \langle 0.3, 0.1, 0.5 \rangle / x_1 + \langle 0.3, 0.2, 0.6 \rangle / x_2 + \langle 0.4, 0.1, 0.5 \rangle / x_3 \quad (12)$$

and for Type -II as

$$\tilde{A}^n \cap \tilde{B}^n = \langle 0.3, 0.4, 0.5 \rangle / x_1 + \langle 0.3, 0.2, 0.6 \rangle / x_2 + \langle 0.4, 0.2, 0.5 \rangle / x_3 \quad (13)$$

4 Mathematical Analysis

4.1 Neutrosophic Goal Programming

Goal programming can be written as

(P2)

$$\text{Find } x = (x_1, x_2, \dots, x_n)^T \quad (14)$$

to achieve:

$$z_i = t_i \quad i = 1, 2, \dots, k \quad (15)$$

Subject to $x \in X$ where t_i are scalars and represent the target achievement levels of the objective functions that the decision maker wishes to attain provided, X is feasible set of constraints.

The nonlinear goal programming problem can be written as

$$\text{Fin } x = (x_1, x_2, \dots, x_n)^T \quad (16)$$

So as to

Minimize z_i with target value t_i , acceptance tolerance a_i , indeterminacy tolerance d_i rejection tolerance c_i

$$x \in X \quad (17)$$

$$g_j(x) \leq b_j, \quad j = 1, 2, \dots, m \quad (18)$$

$x_i \geq 0, i = 1, 2, \dots, n$ with truth-membership, indeterminacy-membership and falsity-membership functions

$$T_i^1(z_i) = \begin{cases} 1 & \text{if } z_i \leq t_i \\ \left(\frac{t_i + a_i - z_i}{a_i} \right) & \text{if } t_i \leq z_i \leq t_i + a_i \\ 0 & \text{if } z_i \geq t_i + a_i \end{cases} \quad (19)$$

$$I_i^1(z_i) = \begin{cases} 0 & \text{if } z_i \leq t_i \\ \left(\frac{z_i - t_i}{d_i} \right) & \text{if } t_i \leq z_i \leq t_i + a_i \\ \left(\frac{t_i + a_i - z_i}{a_i - d_i} \right) & \text{if } t_i + d_i \leq z_i \leq t_i + a_i \\ 0 & \text{if } z_i \geq t_i + a_i \end{cases} \quad (20)$$

$$F_i^1(z_i) = \begin{cases} 0 & \text{if } z_i \leq t_i \\ \left(\frac{z_i - t_i}{c_i} \right) & \text{if } t_i \leq z_i \leq t_i + c_i \\ 1 & \text{if } z_i \geq t_i + c_i \end{cases} \quad (21)$$

To maximize the degree of acceptance and indeterminacy of nonlinear goal programming (NGP) objectives and constraints also to minimize degree of rejection of of NGP objectives and constraints,

(P3)

$$\text{Maximize } T_{z_i}(z_i), \quad i = 1, 2, \dots, k \quad (22)$$

$$\text{Maximize } I_{z_i}(z_i), \quad i = 1, 2, \dots, k \quad (23)$$

$$\text{Minimize } F_{z_i}(z_i), \quad i = 1, 2, \dots, k \quad (24)$$

Subject to

$$0 \leq T_{z_i}(z_i) + I_{z_i}(z_i) + F_{z_i}(z_i) \leq 3, \quad i = 1, 2, \dots, k \quad (25)$$

$$T_{z_i}(z_i) \geq 0, I_{z_i}(z_i) \geq 0, F_{z_i}(z_i) \geq 0, \quad i = 1, 2, \dots, k \quad (26)$$

$$T_{z_i}(z_i) \geq I_{z_i}(z_i), I = 1, 2, \dots, k \quad (27)$$

$$T_{z_i}(z_i) \geq F_{z_i}(z_i), i = 1, 2, \dots, k \quad (28)$$

$$g_j(x) \leq b_j, j = 1, 2, \dots, m \quad (29)$$

$$x_i \geq 0, i = 1, 2, \dots, n \quad (30)$$

where $T_{z_i}(z_i)$, $I_{z_i}(z_i)$ and $F_{z_i}(z_i)$ are truth membership function indeterminacy membership function ,falsity membership function of neutrosophic decision set respectively.

Now the neutrosophic goal programming (NGP) in model (P3) can be represented by crisp programming model using truth membership, indeterminacy membership, and falsity membership functions as

(P4)

$$\text{Maximize } \alpha, \text{Maximize } \gamma, \text{Minimize } \beta \quad (31)$$

$$T_{z_i}(z_i) \geq \alpha, i = 1, 2, \dots, k \quad (32)$$

$$I_{z_i}(z_i) \geq \gamma, i = 1, 2, \dots, k \quad (33)$$

$$F_{z_i}(z_i) \leq \beta, i = 1, 2, \dots, k \quad (34)$$

$$z_i \leq t_i, i = 1, 2, \dots, k \quad (35)$$

$$0 \leq \alpha + \beta + \gamma \leq 3; \quad (36)$$

$$\alpha, \gamma \geq 0, \beta \leq 1; \quad (37)$$

$$g_j(x) \leq b_j, j = 1, 2, \dots, m \quad (38)$$

$$x_i \geq 0, i = 1, 2, \dots, n \quad (39)$$

4.2 Generalized Neutrosophic Goal Programming

The generalized neutrosophic goal programming can be formulated as

(P5)

$$\text{Maximize } T_{z_i}(z_i), i = 1, 2, \dots, k \quad (40)$$

$$\text{Maximize } I_{z_i}(z_i), i = 1, 2, \dots, k \quad (41)$$

$$\text{Minimize } F_{z_i}(z_i), i = 1, 2, \dots, k \quad (42)$$

Subject to

$$0 \leq T_{z_i}(z_i) + I_{z_i}(z_i) + F_{z_i}(z_i) \leq w_1 + w_2 + w_3, i = 1, 2, \dots, k \quad (43)$$

$$T_{z_i}(z_i) \geq 0, I_{z_i}(z_i) \geq 0, F_{z_i}(z_i) \geq 0, I = 1, 2, \dots, k \quad (44)$$

$$T_{z_i}(z_i) \geq I_{z_i}(z_i), I = 1, 2, \dots, k \quad (45)$$

$$T_{z_i}(z_i) \geq F_{z_i}(z_i), i = 1, 2, \dots, k \quad (46)$$

$$0 \leq w_1 + w_2 + w_3 \leq 3 \quad (47)$$

$$w_1, w_2, w_3 \in [0, 1] \quad (48)$$

$$g_j(x) \leq b_j, j = 1, 2, \dots, m \quad (49)$$

$$x_i \geq 0, i = 1, 2, \dots, n \quad (50)$$

Equivalently

(P6)

$$\text{Maximize } \alpha, \text{Maximize } \gamma, \text{Minimize } \beta \quad (51)$$

$$T_{z_i}(z_i) \geq \alpha, i = 1, 2, \dots, k \quad (52)$$

$$I_{z_i}(z_i) \geq \gamma, i = 1, 2, \dots, k \quad (53)$$

$$F_{z_i}(z_i) \leq \beta, i = 1, 2, \dots, k \quad (54)$$

$$z_i \leq t_i, i = 1, 2, \dots, k \quad (55)$$

$$0 \leq \alpha + \beta + \gamma \leq w_1 + w_2 + w_3; \quad (56)$$

$$\alpha \in [0, w_1], \gamma \in [0, w_2], \beta \in [0, w_3]; \quad (57)$$

$$w_1 \in [0, 1], w_2 \in [0, 1], w_3 \in [0, 1]; \quad (58)$$

$$0 \leq w_1 + w_2 + w_3 \leq 3; \quad (59)$$

$$g_j(x) \leq b_j, j = 1, 2, \dots, m \quad (60)$$

$$x_j \geq 0, j = 1, 2, \dots, n \quad (61)$$

Equivalently

(P7)

$$\text{Maximize } \alpha, \text{Maximize } \gamma, \text{Minimize } \beta \tag{62}$$

$$z_i \leq t_i + a_i \left(1 - \frac{\alpha}{w_1} \right), i = 1, 2, \dots, k \tag{63}$$

$$z_i \geq t_i + \frac{d_i}{w_2} \gamma, i = 1, 2, \dots, k \tag{64}$$

$$z_i \leq t_i + a_i - \frac{\gamma}{w_2} (a_i - d_i), i = 1, 2, \dots, k \tag{65}$$

$$z_i \leq t_i + \frac{c_i}{w_3} \beta, i = 1, 2, \dots, k \tag{66}$$

$$z_i \leq t_i, i = 1, 2, \dots, k \tag{67}$$

$$0 \leq \alpha + \beta + \gamma \leq w_1 + w_2 + w_3; \tag{68}$$

$$\alpha \in [0, w_1], \gamma \in [0, w_2], \beta \in [0, w_3]; \tag{69}$$

$$w_1 \in [0, 1], w_2 \in [0, 1], w_3 \in [0, 1]; \tag{70}$$

$$0 \leq w_1 + w_2 + w_3 \leq 3; \tag{71}$$

With the help of generalized truth, indeterminacy, falsity membership function the generalized neutrosophic goal programming based on arithmetic aggregation operator can be formulated as

(P8)

$$\text{Minimize } \left\{ \frac{(1-\alpha) + \beta + (1-\gamma)}{3} \right\} \tag{72}$$

Subject to the same constraints as (P7)

With the help of generalized truth, indeterminacy, falsity membership function the generalized neutrosophic goal programming based on geometric aggregation operator can be formulated as

(P9)

$$\text{Minimize } \sqrt[3]{(1-\alpha)\beta(1-\gamma)} \tag{73}$$

Subjected to same constraints as (P7)

Now this non-linear programming problem (P7 or P8 or P9) can be easily solved by an appropriate mathematical programming to give solution of multi-objective non-linear programming problem (P1) by generalized neutrosophic goal optimization approach.

5 Solution of Multi-objective Welded Beam Optimization Problem (MOWBP) by Generalized Neutrosophic Goal Optimization Technique

The multi-objective neutrosophic fuzzy structural model can be expressed as

(P10)

Minimize $C(X)$ with target value C_0 , truth tolerance a_c , indeterminacy tolerance d_c and rejection tolerance c_c (74)

Minimize $\delta(X)$ with target value δ_0 , truth tolerance a_{δ_0} , indeterminacy tolerance d_{δ_0} and rejection tolerance c_{δ_0} (75)

subject to $\sigma(X) \leq [\sigma]$ (76)

$x_i^{\min} \leq x_i \leq x_i^{\max}$ (77)

where $X = [x_1, x_2, \dots, x_n]^T$ (78)

are the design variables, n is the group number of design variables for the welded beam design.

To solve this problem we first calculate truth, indeterminacy and falsity membership function of objective as follows

$$T_C^{w_1}(C(X)) = \begin{cases} w_1 & \text{if } C(X) \leq C_0 \\ w_1 \left(\frac{C_0 + a_c - C(X)}{a_c} \right) & \text{if } C_0 \leq C(X) \leq C_0 + a_c \\ 0 & \text{if } C(X) \geq C_0 + a_c \end{cases} \quad (79)$$

$$I_{C(X)}^{w_2}(C(X)) = \begin{cases} 0 & \text{if } C(X) \leq C_0 \\ w_2 \left(\frac{C(X) - C_0}{d_c} \right) & \text{if } C_0 \leq C(X) \leq C_0 + a_c \\ w_2 \left(\frac{C_0 + a_c - C(X)}{a_c - d_c} \right) & \text{if } C_0 + d_c \leq C(X) \leq C_0 + a_c \\ 0 & \text{if } C(X) \geq C_0 + a_c \end{cases} \quad (80)$$

$$\text{where } d_c = \frac{w_1}{\frac{w_1}{a_c} + \frac{w_2}{c_c}} \quad (81)$$

$$F_{C(X)}^{w_3}(C(X)) = \begin{cases} 0 & \text{if } C(X) \leq C_0 \\ w_3 \left(\frac{C(X) - C_0}{c_c} \right) & \text{if } C_0 \leq C(X) \leq C_0 + c_c \\ w_3 & \text{if } C(X) \geq C_0 + c_c \end{cases} \quad (82)$$

And

$$T_{\delta(X)}^{w_1}(\delta(X)) = \begin{cases} w_1 & \text{if } \delta(X) \leq \delta_0 \\ w_1 \left(\frac{\delta_0 + a_{\delta_0} - \delta(X)}{a_{\delta_0}} \right) & \text{if } \delta_0 \leq \delta(X) \leq \delta_0 + a_{\delta_0} \\ 0 & \text{if } \delta(X) \geq \delta_0 + a_{\delta_0} \end{cases} \quad (83)$$

$$I_{\delta(X)}^{w_2}(\delta(X)) = \begin{cases} 0 & \text{if } \delta(X) \leq \delta_0 \\ w_2 \left(\frac{\delta(X) - \delta_0}{d_\delta} \right) & \text{if } \delta_0 \leq \delta(X) \leq \delta_0 + a_\delta \\ w_2 \left(\frac{\delta_0 + a_\delta - \delta(X)}{a_\delta - d_\delta} \right) & \text{if } \delta_0 + d_\delta \leq \delta(X) \leq \delta_0 + a_\delta \\ 0 & \text{if } \delta(X) \geq \delta_0 + a_\delta \end{cases} \quad (84)$$

$$d_\delta = \frac{w_1}{\frac{w_1}{a_\delta} + \frac{w_2}{c_\delta}}$$

$$F_{\delta(X)}^{w_3}(\delta(X)) = \begin{cases} 0 & \text{if } \delta(X) \leq \delta_0 \\ w_3 \left(\frac{\delta(X) - \delta_0}{c_\delta} \right) & \text{if } \delta_0 \leq \delta(X) \leq \delta_0 + c_\delta \\ w_3 & \text{if } \delta(X) \geq \delta_0 + c_\delta \end{cases} \quad (85)$$

According to generalized neutrosophic goal optimization technique using truth, indeterminacy and falsity membership function, MOSOP (P1) can be formulated as

Model -I

$$\text{Maximize } \alpha, \text{Maximize } \gamma, \text{Minimize } \beta \quad (86)$$

$$C(X) \leq C_0 + a_c \left(1 - \frac{\alpha}{w_1} \right), \quad (87)$$

$$C(X) \geq C_0 + \frac{d_c}{w_2} \gamma, \quad (88)$$

$$C(X) \leq C_0 + a_c - \frac{\gamma}{w_2} (a_c - d_c), \quad (89)$$

$$C(X) \leq C_0 + \frac{c_c}{w_3} \beta, \quad (90)$$

$$C(X) \leq C_0, \quad (91)$$

$$\delta(X) \leq \delta_0 + a_\delta \left(1 - \frac{\alpha}{w_1} \right), \quad (92)$$

$$\delta(X) \geq \delta_0 + \frac{d_\delta}{w_2} \gamma, \quad (93)$$

$$\delta(X) \leq \delta_0 + a_\delta - \frac{\gamma}{w_2} (a_\delta - d_\delta), \quad (94)$$

$$\delta(X) \leq \delta_0 + \frac{c_\delta}{w_3} \beta, \quad (95)$$

$$\delta(X) \leq \delta_0, \quad (96)$$

$$0 \leq \alpha + \beta + \gamma \leq w_1 + w_2 + w_3; \quad (97)$$

$$\alpha \in [0, w_1], \gamma \in [0, w_2], \beta \in [0, w_3]; \quad (98)$$

$$w_1 \in [0, 1], w_2 \in [0, 1], w_3 \in [0, 1]; \quad (99)$$

$$0 \leq w_1 + w_2 + w_3 \leq 3; \quad (100)$$

$$\sigma_i(X) \leq [\sigma], i = 1, 2, \dots, m \quad (101)$$

$$x_j \geq 0, j = 1, 2, \dots, n \quad (102)$$

With the help of generalized truth, indeterminacy, falsity membership function the generalized neutrosophic goal programming based on arithmetic aggregation operator can be formulated as:

Model -II

$$\text{Minimize } \left\{ \frac{(1-\alpha) + \beta + (1-\gamma)}{3} \right\} \quad (103)$$

Subjected to same constraint as Model I

With the help of generalized truth, indeterminacy, falsity membership function the generalized neutrosophic goal programming based on geometric aggregation operator can be formulated as

Model -III

$$\text{Minimize } \sqrt[3]{(1-\alpha)\beta(1-\gamma)} \quad (104)$$

Subjected to same constraint as Model I

Now these non-linear programming Model-I,II,III can be easily solved through an appropriate mathematical programming to give solution of multi-objective non-linear programming problem (8) by generalized neutrosophic goal optimization approach.

6 Numerical Illustration

Welding, a process of joining metallic parts with the application of heat or pressure or the both, with or without added material, is an economical and efficient method for obtaining permanent joints in the metallic parts. This welded joints are generally used as a substitute for riveted joint or can be used as an alternative method for casting or forging. The welding processes can broadly be classified into following two groups, the welding process that uses heat alone to join two metallic parts and the welding process that uses a combination of heat and pressure for joining (Bhandari. V. B). However, above all the design of welded beam should preferably be economical and durable one.

6.1 WBD Formulation

The optimum welded beam design(Fig. 1) can be formulated considering some design criteria such as cost of welding i.e cost function, shear stress, bending stress and deflection, derived as follows:

Cost Function Formulation

The performance index appropriate to this design is the cost of weld assembly. The major cost components of such an assembly are (i) set up labour cost, (ii) welding labour cost, (iii) material cost, i.e

$$C(X) \equiv C_0 + C_1 + C_2 \quad (105)$$

where, $C(X)$ = cost function; C_0 = set up cost; C_1 = welding labour cost; C_2 = material cost. Now:

Set up cost C_0 : The company has chosen to make this component a weldment, because of the existence of a welding assembly line. Furthermore, assume that fixtures for set up and holding of the bar during welding are readily available. The cost C_0 can therefore be ignored in this particular total cost model.

Welding labour cost C_1 : Assume that the welding will be done by machine at a total cost of \$10/hr (including operating and maintenance expense). Furthermore suppose that the machine can lay down a cubic inch of weld in 6 min. The labour cost is then

$$C_1 = \left(10 \frac{\$}{hr}\right) \left(\frac{1}{60} \frac{\$}{min}\right) \left(6 \frac{min}{in^3}\right) V_w = 1 \left(\frac{\$}{in^3}\right) V_w \quad (106)$$

Where V_w = weld volume, in^3

$$\text{Material cost } C_2 : C_2 = C_3 V_w + C_4 V_B \quad (107)$$

Where C_3 = cost per volume per weld material, $\$/in^3 = (0.37)(0.283)$; C_4 = cost per volume of bar stock, $\$/in^3 = (0.37)(0.283)$; V_B = volume of bar, in^3 .

From geometry $V_w = h^2 l$; volume of the weld material, in^3 ; $V_{weld} = x_1^2 x_2$ and $V_B = tb(L+l)$; volume of bar, in^3 $V_{bar} = x_3 x_4 (L + x_2)$.

Therefore cost function become

$$C(X) = h^2 l + C_3 h^2 l + C_4 tb(L+l) = 1.10471 x_1^2 x_2 + 0.04811 x_3 x_4 (14.0 + x_2) \quad (108)$$

Constraints Derivation from Engineering Relationship

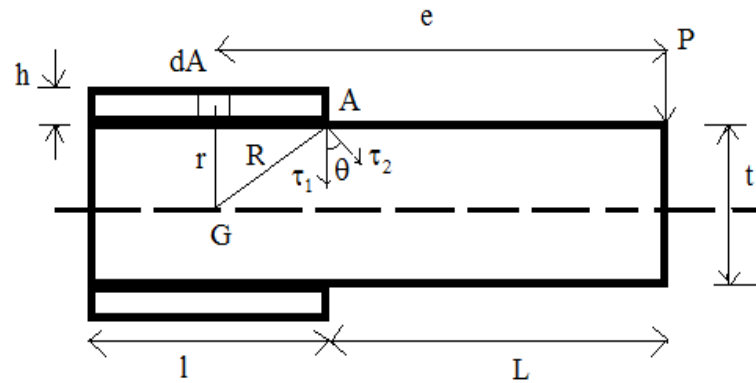

Fig. 1 Shear stresses in the weld group.

Maximum shear stress in weld group

To complete the model it is necessary to define important stress states

Direct or primary shear stress i.e

$$\tau_1 = \frac{\text{Load}}{\text{Throat area}} = \frac{P}{A} = \frac{P}{\sqrt{2}hl} = \frac{P}{\sqrt{2}x_1x_2} \quad (109)$$

Since the shear stress produced due to turning moment $M = Pe$ at any section, is proportional to its radial distance from centre of gravity of the joint 'G', therefore stress due to M is proportional to R and is in a direction at right

angles to R . In other words $\frac{\tau_2}{R} = \frac{\tau}{r} = \text{constant}$ (110)

$$\text{Therefore } R = \sqrt{\left(\frac{l}{2}\right)^2 + \left(\frac{h+t}{2}\right)^2} = \sqrt{\frac{x_2^2}{4} + \frac{(x_1+x_3)^2}{4}} \quad (111)$$

Where, τ_2 is the shear stress at the maximum distance R and τ is the shear stress at any distance r . Consider a small section of the weld having area dA at a distance r from 'G'. Therefore shear force on this small section $= \tau \times dA$ and turning moment of the shear force about centre of gravity is

$$dM = \tau \times dA \times r = \frac{\tau_2}{R} \times dA \times r^2 \quad (112)$$

Therefore total turning moment over the whole weld area

$$M = \frac{\tau_2}{R} \int dA \times r^2 = \frac{\tau_2}{R} J. \quad (113)$$

where J = polar moment of inertia of the weld group about centre of gravity.

Therefore, shear stress due to the turning moment i.e.

$$\text{secondary shear stress, } \tau_2 = \frac{MR}{J} \quad (114)$$

In order to find the resultant stress, the primary and secondary shear stresses are combined vectorially. Therefore the maximum resultant shear stress that will be produced at the weld group, $\tau = \sqrt{\tau_1^2 + \tau_2^2 + 2\tau_1\tau_2 \cos \theta}$, (115)

where, θ = angle between τ_1 and τ_2 .

$$\text{As } \cos \theta = \frac{l/2}{R} = \frac{x_2}{2R}; \quad (116)$$

$$\tau = \sqrt{\tau_1^2 + \tau_2^2 + 2\tau_1\tau_2 \frac{x_2}{2R}}. \quad (117)$$

Now the polar moment of inertia of the throat area (A) about the centre of gravity is obtained by parallel axis theorem,

$$J = 2 \left[I_{xx} + A \times x^2 \right] = 2 \left[\frac{A \times l^2}{12} + A \times x^2 \right] = 2A \left(\frac{l^2}{12} + x^2 \right) = 2 \left\{ \sqrt{2}x_1x_2 \left[\frac{x_2^2}{12} + \frac{(x_1 + x_3)^2}{2} \right] \right\} \quad (118)$$

Where, A = throat area = $\sqrt{2}x_1x_2$, l = Length of the weld,

x = Perpendicular distance between two parallel axes

$$= \frac{t}{2} + \frac{h}{2} = \frac{x_1 + x_3}{2} \quad (119)$$

Maximum bending stress in beam

Now Maximum bending moment = PL , maximum bending stress = $\frac{T}{Z}$,

where $T = PL$;

Z = section modulus = $\frac{I}{y}$; I = moment of inertia = $\frac{bt^3}{12}$; y = distance of

extreme fibre from centre of gravity of cross section = $\frac{t}{2}$; Therefore $Z = \frac{bt^2}{6}$.

So bar bending stress $\sigma(x) = \frac{T}{Z} = \frac{6PL}{bt^2} = \frac{6PL}{x_4x_3^2}$. (120)

Maximum deflection in beam

Maximum deflection at cantilever tip $\delta(x) = \frac{PL^3}{3EI} = \frac{PL^3}{3E \frac{bt^3}{12}} = \frac{4PL^3}{Eb^3} = \frac{4PL^3}{Ex_4x_3^2}$ (121)

Buckling load of beam

Buckling load can be approximated by

$$P_c(x) = \frac{4.013\sqrt{EIC}}{l^2} \left(1 - \frac{a}{l} \sqrt{\frac{EI}{C}} \right) \tag{122}$$

$$= \frac{4.013\sqrt{E \frac{t^2b^6}{36}}}{L^2} \left(1 - \frac{t}{2L} \sqrt{\frac{E}{4G}} \right) = \frac{4.013\sqrt{EGx_3^6x_4^6/36}}{L^2} \left(1 - \frac{x_3}{2L} \sqrt{\frac{E}{4G}} \right) \tag{123}$$

where, $I = \text{moment of inertia} = \frac{bt^3}{12}$; torsional rigidity $C = GJ = \frac{1}{3}tb^3G$; $l = L$; $a = \frac{t}{2}$.

6.2 Crisp Formulation of WBD

In design formulation a welded beam (Fig. 2) has to be designed at minimum cost whose constraints are shear stress in weld (τ), bending stress in the beam (σ), buckling load on the bar (P), and deflection of the beam (δ). The

design variables are $\begin{bmatrix} x_1 \\ x_2 \\ x_3 \\ x_4 \end{bmatrix} = \begin{bmatrix} h \\ l \\ t \\ b \end{bmatrix}$ where h is the weld size, l is the length of the weld

, t is the depth of the welded beam, b is the width of the welded beam.

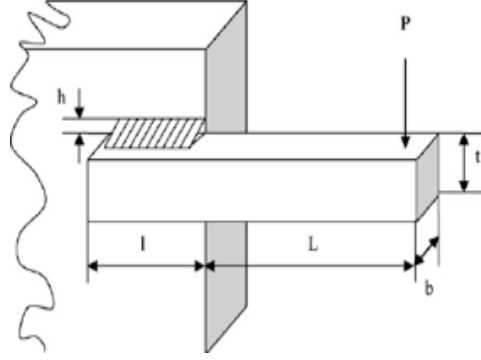

Fig. 2 Design of the welded beam

The single-objective crisp welded beam optimization problem can be formulated as follows:

(P11)

$$\text{Minimize } C(X) \equiv 1.10471x_1^2x_2 + 0.04811(14 + x_2)x_3x_4 \quad (124)$$

such that

$$g_1(x) \equiv \tau(x) - \tau_{\max} \leq 0 \quad (125)$$

$$g_2(x) \equiv \sigma(x) - \sigma_{\max} \leq 0 \quad (126)$$

$$g_3(x) \equiv x_1 - x_4 \leq 0 \quad (127)$$

$$g_4(x) \equiv 0.10471x_1^2x_2 + 0.04811x_3x_4(14 + x_2) - 5 \leq 0 \quad (128)$$

$$g_5(x) \equiv 0.125 - x_1 \leq 0 \quad (129)$$

$$g_6(x) \equiv \delta(x) - \delta_{\max} \leq 0 \quad (130)$$

$$g_7(x) \equiv P - P_c(x) \leq 0 \quad (131)$$

$$x_1, x_2, x_3, x_4 \in [0, 1] \quad (132)$$

$$\text{where } \tau(x) = \sqrt{\tau_1^2 + 2\tau_1\tau_2 \frac{x_2}{2R} + \tau_2^2} ; \tau_1 = \frac{P}{\sqrt{2}x_1x_2} ; \tau_2 = \frac{MR}{J} ; M = P\left(L + \frac{x_2}{2}\right);$$

$$R = \sqrt{\frac{x_2^2}{4} + \left(\frac{x_1 + x_3}{2}\right)^2} ; J = \left\{ \frac{x_1x_2}{\sqrt{2}} \left[\frac{x_2^2}{12} + \left(\frac{x_1 + x_3}{2}\right)^2 \right] \right\}; \sigma(x) = \frac{6PL}{x_4x_3^2}; \delta(x) = \frac{4PL^3}{Ex_4x_3^2};$$

$$P_c(x) = \frac{4.013\sqrt{EGx_3^6x_4^6/36}}{L^2} \left(1 - \frac{x_3}{2L} \sqrt{\frac{E}{4G}} \right) \text{ as derived as Eq.(109), Eq.(114),}$$

Eq.(113), Eq.(111), Eq.(118), Eq.(120), Eq.(121), , Eq.(123), respectively. Again P = Force on beam ; L = Beam length beyond weld; x_1 = Height of the welded

beam; x_2 = Length of the welded beam; x_3 = Depth of the welded beam; x_4 = Width of the welded beam; $\tau(x)$ = Design shear stress; $\sigma(x)$ = Design normal stress for beam material; M = Moment of P about the centre of gravity of the weld, J = Polar moment of inertia of weld group; G = Shearing modulus of Beam Material; E = Young modulus; τ_{\max} = Design Stress of the weld; σ_{\max} = Design normal stress for the beam material; δ_{\max} = Maximum deflection; τ_1 = Primary stress on weld throat, τ_2 = Secondary torsional stress on weld.

Table 1: Input data for crisp model (P11)

Applied load P (lb)	Beam length beyond weld L (in)	Young Modulus E (psi)	Value of G (psi)	Maximum allowable shear stress τ_{\max} (psi)	Maximum allowable normal stress σ_{\max} (psi)	Maximum allowable deflection δ_{\max} (in)
6000	14	3×10^6	12×10^6	13600 with fuzzy region 50	30000 with fuzzy region 50	0.25 with fuzzy region 0.05

This multi objective structural model can be expressed as neutrosophic fuzzy model as

$$\text{Minimize } C(X) \equiv 1.10471x_1^2x_2 + 0.04811(14+x_2)x_3x_4 \text{ with target value } 3.39 \text{ ,truth tolerance } 5 \text{ ,indeterminacy tolerance } \frac{w_1}{0.2w_1 + 0.14w_2} \text{ and rejection tolerance } 7 \quad (133)$$

$$\text{Minimize } \delta(x) \equiv \frac{4PL^3}{Ex_4x_3^2}; \text{ with target value } 0.20 \text{ ,truth tolerance } 0.23 \text{ ,indeterminacy tolerance } \frac{w_1}{4.34w_1 + 4.16w_2} \text{ and rejection tolerance } 0.24 \quad (134)$$

Subject to

$$g_1(x) \equiv \tau(x) - \tau_{\max} \leq 0; \quad (135)$$

$$g_2(x) \equiv \sigma(x) - \sigma_{\max} \leq 0; \quad (136)$$

$$g_3(x) \equiv x_1 - x_4 \leq 0; \quad (137)$$

$$g_4(x) \equiv 0.10471x_1^2x_2 + 0.04811x_3x_4(14 + x_2) - 5 \leq 0; \quad (138)$$

$$g_5(x) \equiv 0.125 - x_1 \leq 0; \quad (139)$$

$$g_6(x) \equiv \delta(x) - \delta_{\max} \leq 0; \quad (140)$$

$$g_7(x) \equiv P - P_c(x) \leq 0; \quad (141)$$

$$0.1 \leq x_1, x_4 \leq 2.0 \quad (142)$$

$$0.1 \leq x_2, x_3 \leq 2.0 \quad (143)$$

$$\text{where } \tau(x) = \sqrt{\tau_1^2 + 2\tau_1\tau_2 \frac{x_2}{2R} + \tau_2^2} \quad ; \quad \tau_1 = \frac{P}{\sqrt{2}x_1x_2} \quad ; \quad \tau_2 = \frac{MR}{J} \quad ; \quad M = P \left(L + \frac{x_2}{2} \right);$$

$$R = \sqrt{\frac{x_2^2}{4} + \left(\frac{x_1 + x_3}{2} \right)^2} \quad ; \quad J = \left\{ \frac{x_1x_2}{\sqrt{2}} \left[\frac{x_2^2}{12} + \left(\frac{x_1 + x_3}{2} \right)^2 \right] \right\}; \quad \sigma(x) = \frac{6PL}{x_4x_3^2}; \quad \delta(x) = \frac{4PL^3}{Ex_4x_3^2};$$

$$P_c(x) = \frac{4.013\sqrt{EGx_3^6x_4^6/36}}{L^2} \left(1 - \frac{x_3}{2L} \sqrt{\frac{E}{4G}} \right);$$

According to generalized neutrosophic goal optimization technique using truth, indeterminacy and falsity membership function, MOWBP (P11) can be formulated as

Model -I

$$\text{Maximize } \alpha, \text{Maximize } \gamma, \text{Minimize } \beta \quad (144)$$

$$1.10471x_1^2x_2 + 0.04811(14 + x_2)x_3x_4 \leq 3.39 + 5 \left(1 - \frac{\alpha}{w_1} \right), \quad (145)$$

$$1.10471x_1^2x_2 + 0.04811(14 + x_2)x_3x_4 \geq 3.39 + \frac{w_1}{w_2(0.2w_1 + 0.14w_2)} \gamma, \quad (146)$$

$$1.10471x_1^2x_2 + 0.04811(14 + x_2)x_3x_4 \leq 3.39 + 5 - \frac{\gamma}{w_2} \left(2 - \frac{w_1}{(0.2w_1 + 0.14w_2)} \right), \quad (147)$$

$$1.10471x_1^2x_2 + 0.04811(14 + x_2)x_3x_4 \leq 3.39 + \frac{7}{w_3} \beta, \quad (148)$$

$$1.10471x_1^2x_2 + 0.04811(14 + x_2)x_3x_4 \leq 3.39, \quad (149)$$

$$\frac{4PL^3}{Ex_4x_3^2} \leq 0.20 + 0.23 \left(1 - \frac{\alpha}{w_1} \right), \quad (150)$$

$$\frac{4PL^3}{Ex_4x_3^2} \geq 0.20 + \frac{w_1}{w_2(4.3w_1 + 4.1w_2)} \gamma, \quad (151)$$

$$\frac{4PL^3}{Ex_4x_3^2} \leq 0.20 + 0.23 - \frac{\gamma}{w_2} \left(0.23 - \frac{w_1}{(4.3w_1 + 4.1w_2)} \right), \quad (152)$$

$$\frac{4PL^3}{Ex_4x_3^2} \leq 0.20 + \frac{0.24}{w_3} \beta, \quad (153)$$

$$\frac{4PL^3}{Ex_4x_3^2} \leq 0.20, \quad (154)$$

$$0 \leq \alpha + \beta + \gamma \leq w_1 + w_2 + w_3; \quad (155)$$

$$\alpha \in [0, w_1], \gamma \in [0, w_2], \beta \in [0, w_3]; \quad (156)$$

$$w_1 \in [0, 1], w_2 \in [0, 1], w_3 \in [0, 1]; \quad (157)$$

$$0 \leq w_1 + w_2 + w_3 \leq 3; \quad (158)$$

$$g_1(x) \equiv \tau(x) - \tau_{\max} \leq 0; \quad (159)$$

$$g_2(x) \equiv \sigma(x) - \sigma_{\max} \leq 0; \quad (160)$$

$$g_3(x) \equiv x_1 - x_4 \leq 0; \quad (161)$$

$$g_4(x) \equiv 0.10471x_1^2x_2 + 0.04811x_3x_4(14 + x_2) - 5 \leq 0; \quad (162)$$

$$g_5(x) \equiv 0.125 - x_1 \leq 0; \quad (163)$$

$$g_6(x) \equiv \delta(x) - \delta_{\max} \leq 0; \quad (164)$$

$$g_7(x) \equiv P - P_c(x) \leq 0; \quad (165)$$

$$0.1 \leq x_1, x_4 \leq 2.0 \quad (166)$$

$$0.1 \leq x_2, x_3 \leq 2.0 \quad (167)$$

where $\tau(x) = \sqrt{\tau_1^2 + 2\tau_1\tau_2 \frac{x_2}{2R} + \tau_2^2}$; $\tau_1 = \frac{P}{\sqrt{2}x_1x_2}$; $\tau_2 = \frac{MR}{J}$; $M = P \left(L + \frac{x_2}{2} \right)$;

$$R = \sqrt{\frac{x_2^2}{4} + \left(\frac{x_1 + x_3}{2} \right)^2} ; J = \left\{ \frac{x_1x_2}{\sqrt{2}} \left[\frac{x_2^2}{12} + \left(\frac{x_1 + x_3}{2} \right)^2 \right] \right\} ; \sigma(x) = \frac{6PL}{x_4x_3^2} ; \delta(x) = \frac{4PL^3}{Ex_4x_3^2} ;$$

$$P_c(x) = \frac{4.013\sqrt{EGx_3^6x_4^6/36}}{L^2} \left(1 - \frac{x_3}{2L} \sqrt{\frac{E}{4G}} \right);$$

With the help of generalized truth, indeterminacy, falsity membership function the generalized neutrosophic goal programming problem (P11) based on arithmetic aggregation operator can be formulated as

Model -II

$$\text{Minimize } \left\{ \frac{(1-\alpha) + \beta + (1-\gamma)}{3} \right\} \quad (168)$$

subjected to same constraints as Model-I

With the help of generalized truth, indeterminacy, falsity membership function the generalized neutrosophic goal programming problem (10) based on geometric aggregation operator can be formulated as

Model -III

$$\text{Minimize } \sqrt[3]{(1-\alpha)\beta(1-\gamma)} \quad (169)$$

subjected to same constraints as Model-I

Now these non-linear programming problem Model-I,II,III can be easily solved by an appropriate mathematical programming to give solution of multi-objective non-linear programming problem (P11) by generalized neutrosophic goal optimization approach and the results are shown in the table 1 is given in table 2. Again value of membership function in GNGP technique for MOWBP (P11) based on different Aggregation is given in Table 3.

Table 2: Comparison of GNGP solution of MOWBP (9) based on different Aggregation

Methods	x_1 in	x_2 in	x_3 in	x_4 in	$C(X)$	$\delta(X)$
Generalized Fuzzy Goal programming(GFGP) $w_1 = 0.15$	1.297612	0.9717430	1.693082	1.297612	3.39	0.20
Generalized Intuitionistic Fuzzy Goal programming(GIFGP) $w_1 = 0.15$ $w_3 = 0.8$	1.297612	0.9717430	1.693082	1.297612	3.39	0.20

Generalized Neutrosophic Goal programming (GNGP) $w_1 = 0.4, w_2 = 0.3, w_3 = 0.7$	1.347503	0.7374240	2	1.347503	3.39	2
Generalized Intuitionistic Fuzzy optimization (GIFGP) based on Arithmetic Aggregation $w_1 = 0.15, w_3 = 0.8$	1.297612	0.9717430	1.693082	1.297612	3.39	0.20
Generalized Neutrosophic optimization (GNGP) based on Arithmetic Aggregation $w_1 = 0.4, w_2 = 0.3, w_3 = 0.7$	1.347503	0.7374240	2	1.347503	3.39	0.20
Generalized Intuitionistic Fuzzy optimization (GIFGP) based on Geometric Aggregation $w_1 = 0.15, w_3 = 0.8$	1.372	0.697176	2	1.37200	3.39	0.2
Generalized Neutrosophic optimization (GNGP) based on Geometric Aggregation $w_1 = 0.4, w_2 = 0.3, w_3 = 0.7$	1.372	0.6971	2	1.372	3.39	0.2

Here we almost same solutions for the different value of w_1, w_2, w_3 in different aggregation method for objective functions. From Table .2 it is clear that the cost of welding and deflection are almost same in fuzzy and intuitionistic fuzzy as well as neutrosophic optimization technique. Moreover it has been seen that desired value obtained in different aggregation method have not affected by variation of methods in perspective of welded beam design optimization.

7 Conclusion

The research study investigates that neutrosophic goal programming can be utilized to optimize a nonlinear welded beam design problem. The results obtained for different aggregation method of the undertaken problem show that the best result is achieved using geometric aggregation method. The concept of neutrosophic optimization technique allows one to define a degree of truth

membership, which is not a complement of degree of falsity; rather, they are independent with degree of indeterminacy. As we have considered a non-linear welded beam design problem and find out minimum cost of welding of the structure as well as minimum deflection, the results of this study may lead to the development of effective neutrosophic technique for solving other model of nonlinear programming problem in different field.

Acknowledgement

The research work of Mridula Sarkar is financed by Rajiv Gandhi National Fellowship (F1-17.1/2013-14-SC-wes-42549/(SA-III/Website)), Govt of India.

References

- [1] Zadeh, L.A. Fuzzy set. *Information and Control*, 1965:8(3): 338-353.
- [2] Coello, C.A.C. 2000b. Use of a self-adaptive penalty approach for engineering optimization problems. *Comput. Ind.*, 41: 113-127. DOI: 10.1016/S0166-3615(99)00046-9.
- [3] Reddy, M. J.; Kumar, D. N. An efficient multi-objective optimization algorithm based on swarm intelligence for engineering design. *Engineering Optimization*. 2007:39(1) :49–68.
- [4] Carlos A. Coello Coello, Solving Engineering Optimization Problems with the Simple Constrained Particle Swarm Optimizer, *Informatica* .2008:32: 319–326.
- [5] Lee, K.S., Geem, Z.W. A new meta-heuristic algorithm for continuous engineering optimization: harmony search theory and practice''*Comput. Methods Appl. Mech. Engrg.* .2005:194: 3902–3933.
- [6] S. Kazemzadeh Azada, O. Hasançebia and O. K. Erol Evaluating efficiency of big-bang big-crunch algorithm in benchmark engineering optimization problems, *Int. J. Optim. Civil Eng.*, 2011:3:495-505.
- [7] Hasançebi, O. and Azad, S.K. An efficient metaheuristic algorithm for engineering optimization: SOPT'' *int. j. optim. civil eng.*, 2012:2(4):479-487.
- [8] Mahdavi, M., Fesanghary, M., Damangir, E. An improved harmony search algorithm for solving optimization problems. *Applied Mathematics and Computation*. 2007:188: 1567–1579.
- [9] Atanassov, K. T. Intuitionistic fuzzy sets. *Fuzzy Sets and Systems*. 1986:20(1): 87-96.
- [10] Smarandache, F. Neutrosophy, neutrosophic probability, set and logic, Amer. Res. Press, Rehoboth, USA, 105. 1995.
- [11] Shuang Li, G. and Au, S.K. Solving constrained optimization problems via Subset Simulation. 2010 4th International Workshop on Reliable Engineering Computing (REC 2010), doi:10.3850/978-981-08-5118-7 069.
- [12] Yanling Wei, Jianbin Qiu, Hamid Reza Karimi, Reliable Output Feedback Control of Discrete-Time Fuzzy Affine Systems with Actuator Faults. Doi: 10.1109/TCSI.2016.2605685, 2016, 1-12.
- [13] Yanling Wei, Jianbin Qiu, Hak-Keung Lam, and Ligang Wu, Approaches to T-S Fuzzy-Affine-Model-Based Reliable Output Feedback Control for Nonlinear Itô Stochastic Systems. 2016, DOI 10.1109/TFUZZ.2016.2566810, pp-1-14.

- [14] Sarkar, M., Dey, Samir, Roy, T.K. Multi-Objective Neutrosophic Optimization Technique and its Application to Structural Design”, *International Journal of Computer Applications*.2016:148(12) :(0975 – 8887) .
- [15] Das, P., Roy, T.K. Multi-objective non-linear programming problem based on Neutrosophic Optimization Technique and its application in Riser Design Problem. *Neutrosophic Sets and Systems*.2015:9:88-95.
- [16] K. Deb, Optimal design of a welded beam via genetic algorithms, *AIAA Journal* .1991:29 (11): 2013–2015.
- [17] Deb, K., Pratap, A. and Moitra, S., Mechanical component design for multiple objectives using elitist non-dominated sorting GA. In *Proceedings of the Parallel Problem Solving from Nature VI Conference, Paris. 2000: 16–20 : 859–868.*
- [18] K.M. Ragsdell, D.T. Phillips, Optimal design of a class of welded structures using geometric programming, *ASME Journal of Engineering for Industries* .1976:98 (3): 1021–1025, Series B.
- [19] Charns, A., & Cooper, R. *Management Models and Industrial Application of Linear Programming*.1961.
- [20] Dey, S., & Roy, T. K. Intuitionistic Fuzzy Goal Programming Technique for Solving Non-Linear Multi-objective Structural Problem. *Journal of Fuzzy Set Valued Analysis*:2015:(3):179-193.
- [21] Abdel-Basset, Mohamed, et al. "A novel group decision-making model based on triangular neutrosophic numbers." *Soft Computing* (2017): 1-15. DOI: <https://doi.org/10.1007/s00500-017-2758-5>
- [22] Hussian, Abdel-Nasser, et al. "Neutrosophic Linear Programming Problems." *Peer Reviewers*: 15.
- [23] Abdel-Basset, Mohamed, Mai Mohamed, and Arun Kumar Sangaiah. "Neutrosophic AHP-Delphi Group decision making model based on trapezoidal neutrosophic numbers." *Journal of Ambient Intelligence and Humanized Computing* (2017): 1-17. DOI: <https://doi.org/10.1007/s12652-017-0548-7>
- [24] Mohamed, Mai, et al. "A Critical Path Problem in Neutrosophic Environment." *Peer Reviewers*: 167.
- [25] Mohamed, Mai, et al. "A Critical Path Problem Using Triangular Neutrosophic Number." *Peer Reviewers*: 155.
- [26] Mridula Sarkar, Samir Dey, Tapan Kumar Roy: Truss Design Optimization using Neutrosophic Optimization Technique, *Neutrosophic Sets and Systems*, vol. 13, 2016, pp. 62-69. doi.org/10.5281/zenodo.570869
- [27] Pintu Das, Tapan Kumar Roy: Multi-objective non-linear programming problem based on Neutrosophic Optimization Technique and its application in Riser Design Problem, *Neutrosophic Sets and Systems*, vol. 9, 2015, pp. 88-95. doi.org/10.5281/zenodo.571480
- [28] Mohamed, Mai, et al. "Using Neutrosophic Sets to Obtain PERT Three-Times Estimates in Project Management." *Peer Reviewers*: 143.
- [29] Mohamed, Mai, et al. "Neutrosophic Integer Programming Problem." *Neutrosophic Sets & Systems* 15 (2017).
- [30] Abdel-Baset, Mohamed, Ibrahim M. Hezam, and Florentin Smarandache. "Neutrosophic goal programming." *Neutrosophic Sets Syst* 11 (2016): 112-118.
- [31] Hezam, Ibrahim M., Mohamed Abdel-Baset, and Florentin Smarandache. "Taylor series approximation to solve neutrosophic multiobjective programming problem." *Neutrosophic Sets and Systems* 10 (2015): 39-46.
- [32] Mona Gamal Gafar, Ibrahim El-Henawy: Integrated Framework of Optimization Technique and Information Theory Measures for Modeling Neutrosophic Variables, *Neutrosophic Sets and Systems*, vol. 15, 2017, pp. 80-89. doi.org/10.5281/zenodo.570939

Editors: *Prof. Florentin Smarandache*
Dr. Mohamed Abdel-Basset
Dr. Victor Chang

[33] Naga Raju I, Rajeswara Reddy P, Dr. Diwakar Reddy V, Dr. Krishnaiah G: Real Life Decision Optimization Model, *Neutrosophic Sets and Systems*, vol. 14, 2016, pp. 71-79. doi.org/10.5281/zenodo.570889

[34] Wenzhong Jiang, Jun Ye: Optimal Design of Truss Structures Using a Neutrosophic Number Optimization Model under an Indeterminate Environment, *Neutrosophic Sets and Systems*, vol. 14, 2016, pp. 93-97. doi.org/10.5281/zenodo.570888

[35] El-Hefenawy, Nancy, et al. "A review on the applications of neutrosophic sets." *Journal of Computational and Theoretical Nanoscience* 13.1 (2016): 936-944.

[36] Rittik Roy, Pintu Das: Neutrosophic Goal Programming applied to Bank - Three Investment Problem, *Neutrosophic Sets and Systems*, vol. 12, 2016, pp. 97-104. doi.org/10.5281/zenodo.571139

IX

Neutrosophic Modules

Necati Olgun¹ • Mikail Bal²

¹Gaziantep University, Faculty of Science and Art, Department of Mathematics, Gaziantep, 27310, Turkey.
Email: olgun@gantep.edu.tr

²Gaziantep University, Faculty of Science and Art, Department of Mathematics, Gaziantep, 27310, Turkey.
Email: mikailbal46@hotmail.com

Abstract

This paper is devoted to the study of neutrosophic modules and neutrosophic submodules. Neutrosophic logic is an extension of the fuzzy logic in which indeterminacy is included. Neutrosophic Sets are a significant tool of describing the incompleteness, indeterminacy, and inconsistency of the decision-making information. Modules are one of fundamental and rich algebraic structure with respect to some binary operation in the study of algebra. In this paper, for the first time, we study to some basic definition of neutrosophic R-modules and neutrosophic submodules in algebra are generalized. Some properties of neutrosophic R-modules and neutrosophic submodules are presented. In this study, we utilized classical modules and neutrosophic rings. Consequently, we introduced neutrosophic R- modules which is completely different from the classical module in the structural properties. In addition, neutrosophic quotient modules and neutrosophic R-module homomorphism are explained and some definitions, theorems are given. Finally, some useful examples are given to verify the validity of the proposed definitions and results.

Keywords

Neutrosophic group; Neutrosophic ring; Neutrosophic R-module;
Weak neutrosophic R-module; Strong neutrosophic R-module;
Neutrosophic R-module homomorphism.

1 Introduction

Neutrosophy is a new branch of philosophy, which studies the nature, origin and scope of neutralities as well as their interaction with ideational spectra.

Neutrosophy is the base of neutrosophic logic which is an extension fuzzy logic in which indeterminacy is included. Florentin Smarandache [6] introduced the Notion of neutrosophy as a new branch of philosophy in 1980. After, he introduced the concept of neutrosophic logic and neutrosophic set where each proposition in neutrosophic logic is approximated to have the percentage of truth in a subset T, the percentage of indeterminacy in a subset I and the percentage of falsity in a subset F so that this neutrosophic logic is called an extension of fuzzy logic especially to intuitionistic fuzzy logic.

In fact neutrosophic set is the generalization of classical set, neutrosophic group and neutrosophic ring the generalization of classical group and ring etc. Same way neutrosophic R-module is the generalization of classical R-module. By utilizing the idea of neutrosophic theory Vasantha Kanasamy and Florentin Smarandache studied neutrosophic algebraic structures in by inserting an indeterminate element I in the algebraic structure and then combine 'I' with each element of the structure with respect to corresponding binary operation. They call it neutrosophic element and the generated algebraic structure is then termed as neutrosophic algebraic structure. They further study several neutrosophic algebraic structure such as neutrosophic fields, neutrosophic groups, neutrosophic rings, neutrosophic semigroups, neutrosophic vector spaces, neutrosophic N-groups, neutrosophic N-semigroups, neutrosophic N loops, neutrosophic biloops, neutrosophic N-loops etc.

Groups are so much important in algebraic structures as they effective in almost all algebraic structures theory. Groups are thought as old algebra due to its rich structure than any other notion. Same way neutrosophic groups are much important in neutrosophic notions formation. Because they are basic structure almost all neutrosophic notions. Neutrosophic logic has wide applications in science, engineering, politics, economics, etc. Therefore, neutrosophic structures are very important and widely area of study. If reader wanted to see details of neutrosophy and neutrosophic algebraic structures, the reader should see [3-21].

2 Preliminaries

Definition 2.1: [9] Let $(G, *)$ be any group and $\langle GUI \rangle = \{a + bI : a, b \in G\}$.

$N(G) = \{\langle GUI \rangle, *\}$ is called a neutrosophic group generated by G and I under the binary operation *. I is called the neutrosophic element with the property $I^2 = I$. For an integer n, $n+1$, and nI are neutrosophic elements and $0.I = 0.I^{-1}$, the inverse of I is not defined and hence does not exist.

Example 1: $(N(Z), +)$ is a neutrosophic group of integers and $(N(Q), +)$ is a neutrosophic group of rational numbers.

Example 2: Let $Z_5 = \{0, 1, 2, 3, 4, 5\}$ be a group under addition modulo 5. $N(G) = \langle \langle Z_5 \cup I \rangle, '+' \text{ modulo } 5 \rangle$ is a neutrosophic group which is a group. For $N(G) = \{a+bI \mid a, b \in Z_5\}$ is a group under '+' modulo 5. Thus, this Neutrosophic group is also a group.

Theorem 2.2: [1] Let $(G, *)$ be any group, $N(G) = \langle \langle G \cup I \rangle, * \rangle$ be the neutrosophic group.

- (1) $N(G)$ in general is not a group.
- (2) $N(G)$ always contain a group.

Proof: (1) Suppose that $N(G)$ is in general a group. Let $X \in N(G)$ be arbitrary. If x is a neutrosophic element then $X^{-1} \in N(G)$ and consequently $N(G)$ is not a group, a contradiction.

(2) Since a group G and an indeterminate I generate $N(G)$, it follows that $G \subseteq N(G)$ and $N(G)$ always contain a group.

Theorem 2.3. [9] $N(G)$ be any neutrosophic group. $(N(G), *)$ is commutative neutrosophic group if

$$\forall a, b \in N(G), ab = ba.$$

Definition 2.4. [9] Let $N(G) = \langle \langle G \cup I \rangle \rangle$ be a neutrosophic group generated by G and I . A proper subset $P(G)$ is said to be a neutrosophic subgroup if $P(G)$ is a neutrosophic group i.e. $P(G)$ must contain a (sub) group.

Theorem 2.5. [1] Let $N(M)$ and $N(P)$ be any two neutrosophic subgroups of a commutative neutrosophic group $N(G)$.

- (1) $N(M) \cap N(P)$ is a neutrosophic subgroup of $N(G)$.
- (2) $N(M).N(P)$ is a neutrosophic subgroup of $N(G)$.
- (3) $N(M) \cup N(P)$ is a neutrosophic subgroup of $N(G)$ if and only if $N(M) \subseteq N(P)$ or $N(P) \subseteq N(M)$.

Definition 2.6: [9] A neutrosophic group $N(G)$ which has no nontrivial neutrosophic normal subgroups is called a simple neutrosophic group.

Definition 2.7: [2] Let $(R, +, *)$ be any ring. The set $\langle \langle R \cup I \rangle \rangle = \{a+bI \mid a, b \in R\}$ is neutrosophic ring generated by R and I under the operation of R .

Example 3: Let Z be the ring of integer $\langle \langle Z \cup I \rangle \rangle = \{a+bI \mid a, b \in Z\}$. $\langle \langle Z \cup I \rangle \rangle$ is a ring called the neutrosophic ring of integer. Also $Z \subseteq \langle \langle Z \cup I \rangle \rangle$.

Example 4: Let Q be the ring of rational numbers $\langle QUI \rangle = \{a+bI \mid a,b \in Q\}$. $\langle QUI \rangle$ is a ring called the neutrosophic ring of rational numbers. Also $Q \subseteq \langle QUI \rangle$.

Example 5: Let $Z_n = \{0,1,2,\dots,n-1\}$ be the ring of integers modulo n . $\langle Z_nUI \rangle$ is the neutrosophic ring of modulo integers n .

Theorem 2.8:[9] Let $\langle RUI \rangle$ be a neutrosophic ring. Then $\langle RUI \rangle$ is a ring.

Note: We have said in teorem 2.2. and teorem 2.8. that a neutrosophic ring is a ring; but neutrosophic group may not have a group structure. This is a big difference between these two algebraic structures.

Theorem 2.9:[2] Let $\langle RUI \rangle$ be a neutrosophic ring. $\langle RUI \rangle$ is commutative neutrosophic ring if $\forall a,b \in \langle RUI \rangle, ab=ba$.

Definition 2.10: [9] Let $\langle RUI \rangle$ be a neutrosophic ring. A proper subset K of $\langle RUI \rangle$ is said to be a neutrosophic subring if K itself is a neutrosophic ring under the operations of $\langle RUI \rangle$. It is essential that $K = \langle SUnI \rangle$, n a positive integer where S is a subring of R . i.e. $\{P$ is generated by the subring S together with $nI. (n \in Z^+)$.

Definition 2.11: [9] Let $\langle RUI \rangle$ be a neutrosophic ring. We say $\langle RUI \rangle$ is a neutrosophic ring of characteristic zero if $nx = 0$ (n an integer) for all $x \in \langle RUI \rangle$ is possible only if $n = 0$, then we call the neutrosophic ring to be a neutrosophic ring of characteristic zero.

Example 6: Let $\langle QUI \rangle$ be the neutrosophic ring of rationals. $\langle QUI \rangle$ is the neutrosophic ring of characteristic zero.

Example 7: Consider $\langle CUI \rangle$ the neutrosophic ring of complex numbers. $\langle CUI \rangle$ is the neutrosophic ring of characteristic zero.

3 Neutrosophic Modules

Definition 3.1: Let $(M,+,\cdot)$ be any R -module over a commutative ring R and let $M(I) = \langle MUI \rangle$ be a neutrosophic set generated by M and I . The triple $(M(I),+,\cdot)$ is called a weak neutrosophic R -module over a ring R . If $M(I)$ is a neutrosophic R -module over a neutrosophic ring $R(I)$, then $M(I)$ is called a strong neutrosophic R -module. The elements of $M(I)$ are called neutrosophic elements and the elements of $R(I)$ are called neutrosophic scalars.

If $m = x+yI$, $m' = z+tI \in M(I)$ where x,y,z, t are elements in M and

$\alpha = u+vI \in R(I)$ where u, v are scalars in R , we define:

$$m+m' = (x+yI)+(z+tI) = (x+z)+(y+t)I,$$

and $\alpha m = (u+vI).(x+yI) = ux+(uy+xv+vy)I.$

Example 1: Let R be a commutative ring, and let J be an ideal of R .

(3.1) A very important example of an neutrosophic R -module is $R(I)$ itself: $R(I)$ is, of course, an neutrosophic abelian group, the multiplication in R gives us a mapping

$$. : R \times R(I) \longrightarrow R(I),$$

and the neutrosophic ring axioms ensure that this scalar multiplication' turns R into an neutrosophic R -module.

(3.2) Since J is closed under addition and under multiplication by arbitrary elements of $R(I)$, it follows that J too is an neutrosophic R -module under the addition and multiplication of R .

(3.3) $R(I)$ is a weak neutrosophic R -module over a ring Q and it is a strong neutrosophic R -module over a neutrosophic ring $Q(I)$.

(3.4) $R^n(I)$ is a weak neutrosophic R -module over a ring R and it is a strong neutrosophic R -module over a neutrosophic ring $R(I)$.

(3.5) $M_{m \times n}(I) = \{[a_{ij}] : a_{ij} \in Q(I)\}$ is a weak neutrosophic R -module over a ring Q and it is a strong neutrosophic R -module over a neutrosophic ring $Q(I)$

Theorem 3.2. Every strong neutrosophic R -module is a weak neutrosophic R -module.

Proof: Suppose that $M(I)$ is a strong neutrosophic module over a neutrosophic ring $R(I)$. Since $R \subseteq R(I)$ for every ring R , it follows that $M(I)$ is a weak neutrosophic R -module.

Theorem 3.3. Every weak (strong) neutrosophic R -module is a R -module.

Proof: Suppose that $M(I)$ is a strong neutrosophic module over a neutrosophic ring $R(I)$. Obviously, $(M(I),+,.)$ is an abelian group. Let $m = x+yI$, $m' = z + tI \in M(I)$, $\alpha = a+bI$, $\beta = c+dI \in R(I)$ where $x,y,z,t \in M$ and $a, b, c, d \in R$. Then

$$\begin{aligned}
 (1) \quad \alpha(m + m^1) &= (a + bI)(x + yI + z + tI) \\
 &= ax + az + [ay + at + bx + by + bz + bt]I \\
 &= (a + bI)(x + yI) + (a + bI)(z + tI) \\
 &= \alpha m + \alpha m^1.
 \end{aligned}$$

$$\begin{aligned}
 (2) \quad (\alpha + \beta)m &= (a + bI + c + dI)(x + yI) \\
 &= ax + cx + [ay + cy + bx + dx + by + dy]I \\
 &= (a + bI)(x + yI) + (c + dI)(x + yI) \\
 &= \alpha m + \beta m
 \end{aligned}$$

$$\begin{aligned}
 (3) \quad (\alpha\beta)m &= ((a + bI)(c + dI))(x + yI) \\
 &= acx + [acy + adx + bcx + bdx + ady + bcy + bdy]I \\
 &= (a + bI)((c + dI)(x + yI)) \\
 &= \alpha(\beta m)
 \end{aligned}$$

(4) For $1 + 0I \in R(I)$, we have

$$\begin{aligned}
 1m &= (1 + 0I)(x + yI) \\
 &= x(y + 0 + 0)I \\
 &= x + yI.
 \end{aligned}$$

Accordingly, $M(I)$ is a R -module.

Lemma 3.4. Let $M(I)$ be a strong neutrosophic R -module over a neutrosophic ring $R(I)$ and let $m = x + yI$, $m^1 = z + tI$, $m^n = u + vI \in M(I)$, $\alpha = a + bI \in R(I)$. Then:

- (1) $m + m^n = m^1 + m^n$ implies $m = m^1$.
- (2) $\alpha 0 = 0$.
- (3) $0m = 0$.
- (4) $(-\alpha)m = \alpha(-m) = -(\alpha m)$

Definition 3.5: Let $M(I)$ be a strong neutrosophic R -module over a neutrosophic ring $R(I)$ and let $N(I)$ be a nonempty subset of $M(I)$. $N(I)$ is called a strong neutrosophic submodule of $M(I)$ if $N(I)$ is itself a strong neutrosophic R -module over $R(I)$. It is essential that $N(I)$ contains a proper subset which is a R -module.

Definition 3.6: Let $M(I)$ be a weak neutrosophic R -module over a ring R and let $N(I)$ be a nonempty subset of $M(I)$. $N(I)$ is called a weak neutrosophic submodule of $M(I)$, if $N(I)$ is itself a weak neutrosophic R -module over R . It is essential that $N(I)$ contains a proper subset which is a R -module.

Theorem 3.7: Let $M(I)$ be a strong neutrosophic R -module over a neutrosophic ring $R(I)$ and let $N(I)$ be a nonempty subset of $M(I)$. $N(I)$ is a strong neutrosophic submodule of $M(I)$ if and only if the following conditions hold:

- (1) $m, m' \in N(I)$ implies $m + m' \in N(I)$.
- (2) $m \in N(I)$ implies $\alpha m \in N(I)$ for all $\alpha = a + bI \in R(I)$ $a, b \in R$.
- (3) $N(I)$ contains a proper subset which is a R -module.

Corollary 3.8 : Let $M(I)$ be a strong neutrosophic R -module over a neutrosophic ring $R(I)$ and let $N(I)$ be a nonempty subset of $M(I)$. $N(I)$ is a strong neutrosophic submodule of $M(I)$ if and only if the following conditions hold:

- (1) $m, m' \in N(I)$ implies $\alpha m + \beta m' \in N(I)$ for all $\alpha, \beta \in R(I)$.
- (2) $N(I)$ contains a proper subset which is a R -module.

Example 2. Let $M(I)$ be a weak (strong) neutrosophic R -module. $M(I)$ is a weak (strong) neutrosophic submodule called a trivial weak (strong) neutrosophic submodule.

Example 3. Let $M(I) = R^3(I)$ be a strong neutrosophic R -module over a neutrosophic ring $R(I)$ and let

$$N(I) = \{(m = a + bI, m' = c + dI, 0 = 0 + 0I) \in M(I) : a, b, c, d \in M\}.$$

Then $N(I)$ is a strong neutrosophic submodule of $M(I)$.

Example 4. Let $M(I) = M_{m \times n}(I) = \{[a_{ij}] : a_{ij} \in R(I)\}$ be a strong neutrosophic R -module over $R(I)$ and let

$$N(I) = A_{m \times n}(I) = \{[b_{ij}] : b_{ij} \in R(I)$$

and $\text{trace}(A) = 0\}$. Then $N(I)$ is a strong neutrosophic submodule of $M(I)$.

Theorem 3.9: Let $M(I)$ be a strong neutrosophic R -module over a neutrosophic ring $R(I)$ and let $\{N_n(I)\}_{n \in \lambda}$ be a family of strong neutrosophic submodules of $M(I)$. Then $\bigcap N_n(I)$ is a strong neutrosophic submodule of $M(I)$.

Proof: Clearly $0_M \in \cap N_n(I)$ and $\cap N_n(I) \neq \emptyset$. Since, for $\forall n \in \lambda$, $0_M \in N_n(I)$.

Let be $x, y \in \cap N_n(I)$ and let be $a \in R$ -module. Then $x-y, ax \in \cap N_n(I)$. Since, for $\forall n \in \lambda$, $x-y \in N_n(I)$ and $ax \in N_n(I)$. Hence $\cap N_n(I)$ is a strong neutrosophic submodule of $M(I)$.

Remark 1. Let $M(I)$ be a strong neutrosophic R -module over a neutrosophic ring $R(I)$ and let $N_1(I)$ and $N_2(I)$ be two distinct strong neutrosophic submodule of $M(I)$. Generally, $N_1(I) \cup N_2(I)$ is not a strong neutrosophic submodule of $M(I)$. However, if $N_1(I) \subseteq N_2(I)$ or $N_2(I) \subseteq N_1(I)$, then $N_1(I) \cup N_2(I)$ is a strong neutrosophic submodule of $M(I)$.

Definition 3.10: Let $M(I)$ and $N(I)$ be strong *neutrosophic* R -modules over a *neutrosophic* ring $R(I)$ and let $\phi : M(I) \rightarrow N(I)$ be a mapping of $M(I)$ into $N(I)$. ϕ is called a *neutrosophic* R -module homomorphism if the following conditions hold:

- (1) ϕ is a R -module homomorphism.
- (2) $\phi(I) = I$.

If ϕ is a bijective *neutrosophic* R -module homomorphism, then ϕ is called a *neutrosophic*

R -module isomorphism and we write $M(I) \cong N(I)$.

Definition 3.11: Let $M(I)$ and $N(I)$ be strong *neutrosophic* R -modules over a *neutrosophic* ring $R(I)$ and let $\phi : M(I) \rightarrow N(I)$ be a *neutrosophic* R -module homomorphism.

(1) The kernel of ϕ denoted by $Ker\phi$ is defined by the set $\{m \in M(I) : \phi(m) = 0\}$.

(2) The image of ϕ denoted by $Im\phi$ is defined by the set $\{n \in N(I) : \phi(m) = n$

for some $m \in M(I)\}$.

Example 5. Let $M(I)$ be a strong *neutrosophic* R -module over a *neutrosophic* ring $R(I)$.

(1) The mapping $\phi : M(I) \rightarrow M(I)$ defined by $\phi(m) = m$ for all $m \in M(I)$ is *neutrosophic* R -module homomorphism and $Ker\phi = 0$.

(2) The mapping $\phi : M(I) \rightarrow M(I)$ defined by $\phi(m) = 0$ for all $m \in M(I)$ is *neutrosophic* R -module homomorphism since $I \in M(I)$ but $\phi(I) \neq 0$.

Definition 3.12: Let $M(I)$ and $N(I)$ be strong neutrosophic R -modules over a neutrosophic ring $R(I)$ and let $\phi : M(I) \rightarrow N(I)$ be a neutrosophic R -module homomorphism. Then:

(1) $\text{Ker}\phi$ is not a strong neutrosophic submodule of $M(I)$ but a submodule of M .

(2) $\text{Im}\phi$ is a strong neutrosophic submodule of $N(I)$.

Proof. (1) Obviously, $I \in M(I)$ but $\phi(I) \neq 0$. That $\text{Ker}\phi$ is a submodule of M is clear.

(2) Clear.

Example 6. Let M be a module over the commutative ring R .

Suppose that N is a second neutrosophic R -module, and that $f : M(I) \rightarrow N(I)$ is a homomorphism of neutrosophic R -modules. The kernel of f , denoted by $\text{Ker } f$, is the set $\{m \in M : f(m) = 0_N\}$. $\text{Ker } f$ is a submodule of $M(I)$. $\text{Ker}f = 0$ if and only if f is a monomorphism.

Theorem 3.13: Let $N(I)$ be a strong neutrosophic submodule of a strong neutrosophic R -module $M(I)$ over a neutrosophic ring $R(I)$. Let $\phi : M(I) \rightarrow M(I)/N(I)$ be a mapping defined by $\phi(m) = m + N(I)$ for all $m \in M(I)$. Then ϕ is not a neutrosophic R -module homomorphism.

Proof. Obvious since $\phi(I) = I + N(I) = N(I) \neq I$.

Theorem 3.14: Let $N(I)$ be a strong neutrosophic submodule of a strong neutrosophic R -module $M(I)$ over a neutrosophic ring $R(I)$ and let $\phi : M(I) \rightarrow K(I)$ be a neutrosophic R -module homomorphism from $M(I)$ into a strong neutrosophic R -module $K(I)$ over $R(I)$.

If $\phi_{N(I)} : N(I) \rightarrow K(I)$ is the restriction of ϕ to $N(I)$ is defined by $\phi_{N(I)}(n) = \phi(n)$ for all, then:

(1) $\phi_{N(I)}$ is a neutrosophic R -module homomorphism.

(2) $N(I) \text{Ker}\phi_{N(I)} = \text{Ker}\phi \cap N(I)$.

(3) $\text{Im}\phi_{N(I)} = \phi(N(I))$.

Remark 2. If $M(I)$ and $N(I)$ are strong neutrosophic R -modules over a neutrosophic ring $R(I)$ and $\phi, \psi : M(I) \rightarrow N(I)$ are neutrosophic R -module homomorphisms, then $(\phi + \psi)$ and $(\alpha\phi)$ are not neutrosophic R -module homomorphisms since

$$(\phi + \psi)(I) = \phi(I) + \psi(I) = I + I = 2I \neq I \text{ and}$$

$$(\alpha\phi)(I) = \alpha\phi(I) = \alpha I \neq I \text{ for all } \alpha \in R(I).$$

Hence, if $Hom(M(I), N(I))$ is the collection of all *neutrosophic* R -module homomorphisms from $M(I)$ into $N(I)$, then $Hom(M(I), N(I))$ is not a *neutrosophic* R -module over $R(I)$. This is different from what is obtainable in the classical R -module.

Definition 3.15: Let $K(I)$, $M(I)$ and $N(I)$ be strong *neutrosophic* R -modules over a *neutrosophic* ring $R(I)$ and let

$$\phi : K(I) \rightarrow M(I), \psi : M(I) \rightarrow N(I)$$

be *neutrosophic* R -module homomorphisms. The composition $\psi\phi : K(I) \rightarrow N(I)$ is defined by $\psi\phi(k) = \psi(\phi(k))$ for all $k \in K(I)$.

Theorem 3.16: Let $K(I)$, $M(I)$ and $N(I)$ be strong *neutrosophic* R -modules over a *neutrosophic* ring $R(I)$ and let

$$\phi : K(I) \rightarrow M(I), \psi : M(I) \rightarrow N(I)$$

be *neutrosophic* R -module homomorphisms. Then the composition $\psi\phi : K(I) \rightarrow N(I)$ is a *neutrosophic* R -module homomorphism.

Proof: Clearly, $\psi\phi$ is a R -module homomorphism. For $k = I \in K(I)$, we have:

$$\begin{aligned} \psi\phi(I) &= \psi(\phi(I)) \\ &= \psi(I) \\ &= I. \end{aligned}$$

Hence $\psi\phi$ is a *neutrosophic* R -module homomorphism.

Corrolary 3.17: Let $P(M(I))$ be the collection of all *neutrosophic* R -module homomorphisms from $M(I)$ onto $M(I)$. Then

$$\phi(\psi\lambda) = (\phi\psi)\lambda \text{ for all } \phi, \psi, \lambda \in P(M(I)).$$

Theorem 3.18: Let $K(I)$, $M(I)$ and $N(I)$ be strong *neutrosophic* R -modules over a *neutrosophic* ring $R(I)$ and let $\phi : K(I) \rightarrow M(I)$, $\psi : M(I) \rightarrow N(I)$ be *neutrosophic* R -module homomorphisms. Then

- (1) If $\psi\phi$ is injective, then ϕ is injective.
- (2) If $\psi\phi$ is surjective, then ψ is surjective.
- (3) If ψ and ϕ are injective, then $\psi\phi$ is injective.

4 Conclusion

In this paper we inspired from the neutrosophic philosophy which F. Smarandache introduced the theory of neutrosophy in 1995. Basically we defined neutrosophic R-modules and neutrosophic submodules which are completely different from the classical module and submodule in the structural properties. It was shown that every weak neutrosophic R-module is a R-module and every strong neutrosophic R-module is a R-module. Finally, neutrosophic quotient modules and neutrosophic R-module homomorphism are explained and some definitions and theorems are given.

References

- [1] Agboola AAA, Akwu AD and Oyebo YT (2012) Neutrosophic Groups and Neutrosophic Subgroups, *Int. J Math. Comb* 3 1-9.
- [2] Agboola AAA, Akwu AD and Oyebo YT (2011) Neutrosophic Rings I, *Int. J. Math. Comb* 4 1-14.
- [3] Agboola AAA, Adeleke EO and Akinleye SA (2012) Neutrosophic Rings II, *Int. J. Math. Comb* 2 1-8.
- [4] Agboola AAA and Akinleye SA (2014) Neutrosophic Vector Space Neutrosophic Sets and Systems, Vol. 4 9-8
- [5] Yetkin E, Olgun N. (2014) A New Type Fuzzy Module over Fuzzy Rings, *The Scientific World Journal*, DOI: 10.1155/2014/730932
- [6] Smarandache F, (2005) *A Unifying Field in Logics. Neutrosophy, Neutrosophic Probability, Set and Logic*. Rehoboth: American Research Press
- [7] Uluçay V, Şahin M, Olgun N, Kilicman A (2017) On neutrosophic soft lattices, *Africa Matematika*, June 2017, Volume 28, Issue 3–4, pp 379–388
- [8] Sharp RY, (2000). *Steps in Commutative Algebra*, (Second edition), Cambridge University Press
- [9] Smarandache, F. Ali, M., (2016) Neutrosophic Triplet Group, *Neural Comput & Applic* doi:10.1007/s00521-016-2535-x
- [10] Kandasamy WBV, Smarandache F, (2006) *Neutrosophic Rings*, Hexis, Phoenix, Arizona
- [11] Kandasamy WBV, Smarandache F, (2004) *Basic Neutrosophic Algebraic Structures and their Applications to Fuzzy and Neutrosophic Models*, Hexis, Phoenix, Arizona
- [12] Abdel-Basset, Mohamed, et al. "A novel group decision-making model based on triangular neutrosophic numbers." *Soft Computing* (2017): 1-15. DOI: <https://doi.org/10.1007/s00500-017-2758-5>
- [13] Hussian, Abdel-Nasser, et al. "Neutrosophic Linear Programming Problems." *Peer Reviewers*: 15.
- [14] Abdel-Basset, Mohamed, Mai Mohamed, and Arun Kumar Sangaiah. "Neutrosophic AHP-Delphi Group decision making model based on trapezoidal neutrosophic numbers." *Journal of Ambient Intelligence and Humanized Computing* (2017): 1-17. DOI: <https://doi.org/10.1007/s12652-017-0548-7>
- [15] Mohamed, Mai, et al. "A Critical Path Problem in Neutrosophic Environment." *Peer Reviewers*: 167.
- [16] Mohamed, Mai, et al. "A Critical Path Problem Using Triangular Neutrosophic Number." *Peer Reviewers*: 155.

- [17] Mohamed, Mai, et al. "Using Neutrosophic Sets to Obtain PERT Three-Times Estimates in Project Management." *Peer Reviewers*: 143.
- [18] Mohamed, Mai, et al. "Neutrosophic Integer Programming Problem." *Neutrosophic Sets & Systems* 15 (2017).
- [19] Abdel-Baset, Mohamed, Ibrahim M. Hezam, and Florentin Smarandache. "Neutrosophic goal programming." *Neutrosophic Sets Syst* 11 (2016): 112-118.
- [20] Hezam, Ibrahim M., Mohamed Abdel-Baset, and Florentin Smarandache. "Taylor series approximation to solve neutrosophic multiobjective programming problem." *Neutrosophic Sets and Systems* 10 (2015): 39-46.
- [21] El-Hefenawy, Nancy, et al. "A review on the applications of neutrosophic sets." *Journal of Computational and Theoretical Nanoscience* 13.1 (2016): 936-944.
- [22] Mumtaz Ali, Florentin Smarandache, Muhammad Shabir: *Soft Neutrosophic Groupoids and Their Generalization*, *Neutrosophic Sets and Systems*, vol. 6, 2014, pp. 62-81. doi.org/10.5281/zenodo.571753
- [23] Muhammad Shabir, Mumtaz Ali, Munazza Naz, Florentin Smarandache: *Soft Neutrosophic Group*, *Neutrosophic Sets and Systems*, vol. 1, 2013, pp. 13-25. doi.org/10.5281/zenodo.571754
- [24] Mumtaz Ali, Florentin Smarandache, Luige Vladareanu, Muhammad Shabir: *Generalization of Soft Neutrosophic Rings and Soft Neutrosophic Fields*, *Neutrosophic Sets and Systems*, vol. 6, 2014, pp. 35-41. doi.org/10.5281/zenodo.571389
- [25] Mumtaz Ali, Florentin Smarandache, Luige Vladareanu, Muhammad Shabir: *Generalization of Soft Neutrosophic Rings and Soft Neutrosophic Fields*, *Neutrosophic Sets and Systems*, vol. 6, 2014, pp. 35-41. doi.org/10.5281/zenodo.571389

X

Neutrosophic Triplet Inner Product

Mehmet Şahin¹ • Abdullah Kargin²

¹Department of Mathematics, Gaziantep University, Gaziantep, 27310, Turkey.
Email: mesahin@gantep.edu.tr

²Department of Mathematics, Gaziantep University, Gaziantep, 27310, Turkey.
Email: abduallahkargin27@gmail.com

Abstract

In this paper, the notion of neutrosophic triplet inner product is given and properties of neutrosophic triplet inner product spaces are studied. Furthermore, we show that this neutrosophic triplet notion is different from the classical notion.

Keywords

Neutrosophic triplet inner product; Neutrosophic triplet metric spaces; Neutrosophic triplet vector spaces; Neutrosophic triplet normed spaces.

1 Introduction

The concept of neutrosophic logic and neutrosophic set were introduced by Smarandache in [1]. In this concept, sets have truth function, falsity function and indeterminacy function. These functions defined as independent on each other. Therefore, the concept overcomes many uncertainties in our daily life. In fact, Zadeh introduced the concept of fuzzy set in [2] and Atanassov introduced the concept of intuitionistic fuzzy set in [3] to overcome uncertainties. The fuzzy set has only truth (membership) function. The intuitionistic fuzzy set has truth function, falsity function and indeterminacy function. But these functions defined as dependent on each other. Therefore, neutrosophic set is the generalization of fuzzy set and intuitionistic fuzzy set. Smarandache et al. introduced neutrosophic algebraic structures in [4, 5] using the neutrosophic theory; Smarandache et al. introduced neutrosophic triplet theory and neutrosophic triplet groups in [6-8]. The neutrosophic triplet set is completely different from the classical sets, since for each element “a” in neutrosophic triplet set N together with a binary operation $*$; there exist a neutral of “a” called $neut(a)$ where $a * neut(a) = neut(a) * a = a$ and an opposite of “a” called $anti(a)$ where

$a * \text{anti}(a) = \text{anti}(a) * a = \text{neut}(a)$. The “ $\text{neut}(a)$ ” is different from the classical algebraic unitary element. A neutrosophic triplet is of the form $\langle a, \text{neut}(a), \text{anti}(a) \rangle$. Also; Smarandache at al. studied the neutrosophic triplet ring in [9] and the neutrosophic triplet field in [10]. Şahin at al. studied neutrosophic triplet metric space, neutrosophic triplet vector space and neutrosophic triplet normed space in [11]. Recently some researchers have been dealing with neutrosophic set theory. For example; Smarandache at al. studied the single valued neutrosophic graphs in [12,30-39], interval valued neutrosophic graphs in [13] and SV-Trapezoidal neutrosophic numbers in [14]. Liu at al. studied interval neutrosophic hesitant set in [15], neutrosophic uncertain linguistic number in [16], some power generalized aggregation operators based on the interval neutrosophic numbers in [17], multi-criteria group decision-making based on interval neutrosophic uncertain linguistic variables in [18], interval neutrosophic prioritized OWA operator and aggregation operators based on Archimedean t-conorm and t-norm for the single valued neutrosophic numbers in [19], multiple attribute decision making method based on normal neutrosophic generalized weighted power averaging operator in [20] and multi-valued neutrosophic number bonferroni mean operators in [21]. Also, in [22-29] neutrosophic set theory was studied.

In this paper, we introduced neutrosophic triplet inner product space. Also, we give new properties and new definitions for this structure. In this paper, in section 2, some preliminary results for neutrosophic triplet sets, neutrosophic triplet ring and field, neutrosophic triplet metric space, neutrosophic triplet vector space and neutrosophic triplet normed space are given. In section 3, neutrosophic triplet inner product space is defined and some properties of a neutrosophic triplet inner product space are given. It is show that neutrosophic triplet inner product different from the classical inner product. Also, it is show that if certain conditions are met; every neutrosophic triplet inner product space can be a neutrosophic triplet normed space and neutrosophic triplet metric space at the same time. Furthermore, the convergence of a sequence and a Cauchy sequence in a neutrosophic triplet inner product space are defined. In section 4, conclusions are given.

2 Preliminaries

Definition 2.1: (Smarandache at al. [2016]) Let N be a set together with a binary operation $*$. Then, N is called a neutrosophic triplet set if for any $a \in N$, there exists a neutral of “ a ” called $\text{neut}(a)$, different from the classical algebraic unitary element, and an opposite of “ a ” called $\text{anti}(a)$, with $\text{neut}(a)$ and $\text{anti}(a)$ belonging to N , such that:

$$a * \text{neut}(a) = \text{neut}(a) * a = a,$$

and

$$a * \text{anti}(a) = \text{anti}(a) * a = a.$$

The elements a , $\text{neut}(a)$ and $\text{anti}(a)$ are collectively called as neutrosophic triplet, and we denote it by $(a, \text{neut}(a), \text{anti}(a))$. Here, we mean neutral of “ a ” and apparently, “ a ” is just the first coordinate of a neutrosophic triplet and it is not a neutrosophic triplet. For the same element “ a ” in N , there may be more neutrals to it $\text{neut}(a)$ and more opposites of it $\text{anti}(a)$.

Definition 2.2 (Smarandache *at al.* [2016]): Let $(N, *)$ be a neutrosophic triplet set. Then, N is called a neutrosophic triplet group, if the following conditions are satisfied.

- 1) If $(N, *)$ is well-defined, i.e. for any $a, b \in N$, one has $a * b \in N$.
- 2) If $(N, *)$ is associative, i.e. $(a * b) * c = a * (b * c)$ for all $a, b, c \in N$.

The neutrosophic triplet group, in general, is not a group in the classical algebraic way.

One can consider that neutrosophic neutrals are replacing the classical unitary element, and the neutrosophic opposites are replacing the classical inverse elements.

Definition 2.3: (Smarandache *at al.* [2016]) Let $(N, *)$ be a neutrosophic triplet group. Then N is called a commutative neutrosophic triplet group if for all $a, b \in N$, we have $a * b = b * a$.

Proposition 2.4: (Smarandache *at al.* [2016]) Let $(N, *)$ be a neutrosophic triplet group with respect to $*$ and $a, b, c \in N$;

- 1) $a * b = a * c$ if and only if $\text{neut}(a) * b = \text{neut}(a) * c$
- 2) $b * a = c * a$ if and only if $b * \text{neut}(a) = c * \text{neut}(a)$
- 3) if $\text{anti}(a) * b = \text{anti}(a) * c$, then $\text{neut}(a) * b = \text{neut}(a) * c$
- 4) if $b * \text{anti}(a) = c * \text{anti}(a)$, then $b * \text{neut}(a) = c * \text{neut}(a)$

Theorem 2.5: (Smarandache *at al.* [2016]) Let $(N, *)$ be a commutative neutrosophic triplet group with respect to $*$ and $a, b \in N$;

- i) $\text{neut}(a) * \text{neut}(b) = \text{neut}(a * b)$;
- ii) $\text{anti}(a) * \text{anti}(b) = \text{anti}(a * b)$;

Theorem 2.6: (Smarandache *at al.* [2016]) Let $(N, *)$ be a commutative neutrosophic triplet group with respect to $*$ and $a \in N$;

- i) $\text{neut}(a) * \text{neut}(a) = \text{neut}(a)$;
- ii) $\text{anti}(a) * \text{neut}(a) = \text{neut}(a) * \text{anti}(a) = \text{anti}(a)$;

Definition 2.7: (Smarandache at al. [2017]) Let $(NTF, *, \#)$ be a neutrosophic triplet set together with two binary operations $*$ and $\#$. Then $(NTF, *, \#)$ is called neutrosophic triplet field if the following conditions hold.

1. $(NTF, *)$ is a commutative neutrosophic triplet group with respect to $*$.
2. $(NTF, \#)$ is a neutrosophic triplet group with respect to $\#$.
3. $a\#(b*c) = (a\#b)*(a\#c)$ and $(b*c)\#a = (b\#a)*(c\#a)$ for all $a, b, c \in NTF$.

Theorem 2.8: (Şahin at al. [2017]) Let $(N, *)$ be a neutrosophic triplet group with no zero divisors and with respect to $*$. For $a \in N$;

If $a = \text{neut}(a)$, then there exists an $\text{anti}(a)$ such that $\text{neut}(a) = \text{anti}(a) = a$.

Theorem 2.9: (Şahin at al. [2017]) Let $(N, *)$ be a neutrosophic triplet group with no zero divisors and with respect to $*$. For $a \in N$;

- i) $\text{neut}(\text{neut}(a)) = \text{neut}(a)$
- ii) $\text{anti}(\text{neut}(a)) = \text{neut}(a)$
- iii) $\text{anti}(\text{anti}(a)) = a$
- iv) $\text{neut}(\text{anti}(a)) = \text{neut}(a)$

Definition 2.10: (Şahin at al. [2017]) Let $(N, *)$ be a neutrosophic triplet set and let $x*y \in N$ for all $x, y \in N$. If the function

$d: N \times N \rightarrow \mathbb{R}^+ \cup \{0\}$ satisfies the following conditions; d is called a neutrosophic triplet metric. For all $x, y, z \in N$;

- a) $d(x, y) \geq 0$;
- b) If $x=y$; then $d(x, y)=0$
- c) $d(x, y) = d(y, x)$
- d) If there exists any element $y \in N$ such that $d(x, z) \leq d(x, z*\text{neut}(y))$, then $d(x, z*\text{neut}(y)) \leq d(x, y) + d(y, z)$.

Furthermore; $((N, *), d)$ space is called neutrosophic triplet metric space.

Definition 2.11: (Şahin at al. [2017]) Let $(NTF, *_1, \#_1)$ be a neutrosophic triplet field and let $(NTV, *_2, \#_2)$ be a neutrosophic triplet set together with binary operations " $*_2$ " and " $\#_2$ ". Then $(NTV, *_2, \#_2)$ is called a neutrosophic triplet vector space if the following conditions hold. For all $u, v \in NTV$ and for all $k \in NTF$; such that $u*_2v \in NTV$ and $u\#_2k \in NTV$;

- 1) $(u*_2v) *_2t = u*_2(v*_2t)$, for every $u, v, t \in NTV$
- 2) $u*_2v = v*_2u$, for every $u, v \in NTV$
- 3) $(v*_2u) \#_2k = (v\#_2k) *_2(u\#_2k)$, for all $k \in NTF$ and for all $u, v \in NTV$

- 4) $(k *_1 t) \#_2 u = (k \#_2 v) *_1 (u \#_2 v)$, for all $k, t \in \text{NTF}$ and for all $u \in \text{NTV}$
- 5) $(k \#_1 t) \#_2 u = k \#_1 (t \#_2 u)$, for all $k, t \in \text{NTF}$ and for all $u \in \text{NTV}$
- 6) For all $u \in \text{NTV}$; such that $u \#_2 \text{neut}(k) = \text{neut}(k) \#_2 u = u$, there exists any $\text{neut}(k) \in \text{NTF}$

Here; the condition 1) and 2) indicate that the neutrosophic triplet set $(\text{NTV}, *_2)$ is a commutative neutrosophic triplet group.

Example 2.12: (Şahin *et al.* [2017]) Let $X = \{1, 2\}$ be a set and $P(X) = \{ \emptyset, \{1\}, \{2\}, \{1, 2\} \}$ be power set of X and let $(P(X), *)$ be a neutrosophic triplet set. Where $* = \cup$, $\text{neut}(\emptyset) = \text{neut}(\{1\}) = \text{neut}(\{2\}) = \emptyset$, $\text{neut}(\{1, 2\}) = \{1\}$ and $\text{anti}(A) = A$ for $A \in P(X)$ and for “*”. Then $(P(X), \cup, \cap)$ is a neutrosophic triplet field, since for $\text{neut}(A) = A$, $\text{anti}(A) = A$ for “ \cup, \cap ”. Now, we show that $(P(X), *, \cap)$ is a neutrosophic triplet vector space on $(P(X), \cup, \cap)$ neutrosophic triplet field.

Definition 2.13: (Şahin *et al.* [2017]) Let $(\text{NTV}, *_2, \#_2)$ be a neutrosophic triplet vector space on $(\text{NTF}, *_1, \#_1)$ neutrosophic triplet field. If $\| \cdot \| : \text{NTV} \rightarrow \mathbb{R}^+ \cup \{0\}$ function satisfies following condition; $\| \cdot \|$ is called neutrosophic triplet normed on $(\text{NTV}, *_2, \#_2)$.

Where; $f : \text{NTF} \times \text{NTV} \rightarrow \mathbb{R}^+ \cup \{0\}$, $f(\alpha, x) = f(\text{anti}(\alpha), \text{anti}(x))$ is a function and for every $x, y \in \text{NTV}$ and $\alpha \in \text{NTF}$;

- a) $\|x\| \geq 0$;
- b) If $x = \text{neut}(x)$, then $\|x\| = 0$
- c) $\|\alpha \#_2 x\| = f(\alpha, x) \cdot \|x\|$
- d) $\|\text{anti}(x)\| = \|x\|$
- e) If $\|x *_2 y\| \leq \|x *_2 y *_2 \text{neut}(k)\|$; then $\|x *_2 y *_2 \text{neut}(k)\| \leq \|x\| + \|y\|$, for any $k \in \text{NTF}$.

Furthermore on $(\text{NTV}, *_2, \#_2)$, the neutrosophic triplet vector space defined by $\| \cdot \|$ is called a neutrosophic triplet normed space and is denoted by $((\text{NTV}, *_2, \#_2), \| \cdot \|)$.

Proposition 2.14: (Şahin *et al.* [2017]) Let $((\text{NTV}, *_2, \#_2), \| \cdot \|)$ be a neutrosophic triplet normed space on $(\text{NTF}, *_1, \#_1)$ neutrosophic triplet field. Then, the function $d : \text{NTV} \times \text{NTV} \rightarrow \mathbb{R}$ defined by $d(x, y) = \|x *_2 \text{anti}(y)\|$ provides neutrosophic triplet metric space conditions.

3 Neutrosophic Triplet Inner Product Space

Now let's define the neutrosophic triplet inner product spaces on the neutrosophic triplet vector space.

Definition 3.1: Let $(NTV, *_2, \#_2)$ be a neutrosophic triplet vector space on $(NTF, *_1, \#_1)$ neutrosophic triplet field. If $\langle \cdot, \cdot \rangle : NTV \times NTV \rightarrow \mathbb{R}^+ \cup \{0\}$ function satisfies following condition; $\langle \cdot, \cdot \rangle$ is called neutrosophic triplet inner product on $(NTV, *_2, \#_2)$.

Where; $f: NTF \times NTV \times NTV \rightarrow \mathbb{R}^+ \cup \{0\}$, $f(\alpha, x, y) = f(\text{anti}(\alpha), \text{anti}(x), \text{anti}(y))$ and $f(\alpha, x, y) = f(\alpha, y, x)$, is a function and for every $x, y \in NTV$ and $\alpha, \beta \in NTF$;

- a) $\langle x, x \rangle \geq 0$;
- b) If $x = \text{neut}(x)$, then $\langle x, x \rangle = 0$
- c) $\langle (\alpha \#_2 x) *_2 (\beta \#_2 y), z \rangle = f(\alpha, x, z) \cdot \langle x, z \rangle + f(\beta, y, z) \cdot \langle y, z \rangle$
- d) $\langle \text{anti}(x), \text{anti}(x) \rangle = \langle x, x \rangle$
- e) $\langle x, y \rangle = \langle y, x \rangle$

Furthermore on $(NTV, *_2, \#_2)$, the neutrosophic triplet vector space defined by $\langle \cdot, \cdot \rangle$ is called a neutrosophic triplet inner product space and is denoted by $((NTV, *_2, \#_2), \langle \cdot, \cdot \rangle)$.

Corollary 3.2: It is clear by definition 3.1 that neutrosophic triplet inner product spaces are generally different from classical inner product spaces, since for there is not any "f" function in classical inner product space.

Example 3.3: From example 2.12; $(P(X), *, \cap)$ is a neutrosophic triplet vector space on $(P(X), \cup, \cap)$ neutrosophic triplet field. Then taking $f: P(X) \times P(X) \times P(X) \rightarrow \mathbb{R}^+ \cup \{0\}$, $f(A, B, C) = s((A \cap B) \setminus C) / s(B \setminus C)$, $\|\cdot\|: P(X) \rightarrow \mathbb{R}^+ \cup \{0\}$. Now we show that, $\langle A, B \rangle = s((A \setminus B) \cup (B \setminus A))$ is a neutrosophic triplet inner product and $((P(X), *, \cap), \|\cdot\|)$ is a neutrosophic triplet normed space. Where; $s(A)$ is number of elements in $A \in P(X)$ and $\text{neut}(A) = \emptyset$, $\text{anti}(A) = A$ for "*" and $A * B = A \cup B$

- a) $\langle A, B \rangle = s(A \cap B) \geq 0$.
- b) If $A = \text{neut}(A) = \emptyset$, then $\langle A, A \rangle = 0$.
- c) It is clear that $\langle (A \cap B) * (C \cap D), E \rangle = f(A, B, E) \cdot \langle B, E \rangle + f(C, D, E) \cdot \langle D, E \rangle$
- d) As, $A = \text{anti}(A)$, it is clear that $\langle \text{anti}(A), \text{anti}(A) \rangle = \langle A, A \rangle$.

e) It is clear that $\langle A, B \rangle = s((A \setminus B) \cup (B \setminus A)) = s((B \setminus A) \cup (A \setminus B)) = \langle B, A \rangle$.

Theorem 3.4: Let $(NTV, *_2, \#_2)$ be a neutrosophic triplet vector space on $(NTF, *_1, \#_1)$ neutrosophic triplet field and let $((NTV, *_2, \#_2), \langle \cdot, \cdot \rangle)$ be a neutrosophic triplet inner product space on $(NTV, *_2, \#_2)$ and $f: NTF \times NTV \times NTV \rightarrow \mathbb{R}^+ \cup \{0\}$, $f(\alpha, x, y) = f(\text{anti}(\alpha), \text{anti}(x), \text{anti}(y))$ is a function and for every $x, y \in NTV$ and $\alpha, \beta \in NTF$; Then;

$$\begin{aligned} & \langle (\alpha \#_2 x) *_2 (\beta \#_2 y), (\alpha \#_2 x) *_2 (\beta \#_2 y) \rangle = \\ & f(\alpha, (\alpha \#_2 x) *_2 (\beta \#_2 y), x) \cdot f(\alpha, x, x) \cdot \langle x, x \rangle + \\ & [f(\alpha, (\alpha \#_2 x) *_2 (\beta \#_2 y), x) \cdot f(\beta, x, y) + f(\beta, (\alpha \#_2 x) *_2 (\beta \#_2 y), y) \cdot f(\alpha, x, \\ & y)] \cdot \langle x, y \rangle + \\ & f(\beta, (\alpha \#_2 x) *_2 (\beta \#_2 y), y) \cdot f(\beta, y, y) \cdot \langle y, y \rangle \end{aligned}$$

Proof.

$$\langle (\alpha \#_2 x) *_2 (\beta \#_2 y), (\alpha \#_2 x) *_2 (\beta \#_2 y) \rangle = f(\alpha, x, (\alpha \#_2 x) *_2 (\beta \#_2 y)) \cdot \langle x, (\alpha \#_2 x) *_2 (\beta \#_2 y) \rangle +$$

$f(\beta, y, (\alpha \#_2 x) *_2 (\beta \#_2 y)) \cdot \langle y, (\alpha \#_2 x) *_2 (\beta \#_2 y) \rangle$. From the definition 3.1; since $\langle x, y \rangle = \langle x, y \rangle$ and $f(\alpha, x, y) = f(\alpha, y, x)$;

$$\begin{aligned} & f(\alpha, x, (\alpha \#_2 x) *_2 (\beta \#_2 y)) \cdot \langle x, (\alpha \#_2 x) *_2 (\beta \#_2 y) \rangle + \\ & f(\beta, y, (\alpha \#_2 x) *_2 (\beta \#_2 y)) \cdot \langle y, (\alpha \#_2 x) *_2 (\beta \#_2 y) \rangle = \\ & f(\alpha, (\alpha \#_2 x) *_2 (\beta \#_2 y), x) \cdot \langle (\alpha \#_2 x) *_2 (\beta \#_2 y), x \rangle + \\ & f(\beta, (\alpha \#_2 x) *_2 (\beta \#_2 y), y) \cdot \langle (\alpha \#_2 x) *_2 (\beta \#_2 y), y \rangle = \\ & f(\alpha, (\alpha \#_2 x) *_2 (\beta \#_2 y), x) \cdot [f(\alpha, x, x) \cdot \langle x, x \rangle + f(\beta, x, y) \cdot \langle x, y \rangle] + \\ & f(\beta, (\alpha \#_2 x) *_2 (\beta \#_2 y), y) \cdot [f(\alpha, x, y) \cdot \langle x, y \rangle + f(\beta, y, y) \cdot \langle y, y \rangle] = \\ & f(\alpha, (\alpha \#_2 x) *_2 (\beta \#_2 y), x) \cdot f(\alpha, x, x) \cdot \langle x, x \rangle + \\ & [f(\alpha, (\alpha \#_2 x) *_2 (\beta \#_2 y), x) \cdot f(\beta, x, y) + f(\beta, (\alpha \#_2 x) *_2 (\beta \#_2 y), y) \cdot f(\alpha, x, \\ & y)] \cdot \langle x, y \rangle + \\ & f(\beta, (\alpha \#_2 x) *_2 (\beta \#_2 y), y) \cdot f(\beta, y, y) \cdot \langle y, y \rangle \end{aligned}$$

Theorem 3.5: Let $(NTV, *_2, \#_2)$ be a neutrosophic triplet vector space on $(NTF, *_1, \#_1)$ neutrosophic triplet field and let $((NTV, *_2, \#_2), \langle \cdot, \cdot \rangle)$ be a neutrosophic triplet inner product space on $(NTV, *_2, \#_2)$ and $f: NTF \times NTV \times NTV \rightarrow \mathbb{R}^+ \cup \{0\}$, $f(\alpha, x, y) = f(\text{anti}(\alpha), \text{anti}(x), \text{anti}(y))$ is a function and for every $x, y \in NTV$ and $\alpha \in NTF$. If $\text{neut}(x) = \text{neut}(y)$ then;

$$\langle x, y \rangle^2 \leq \langle x, x \rangle \cdot \langle y, y \rangle$$

Proof: It is clear that if $x = \text{neut}(x)$ or $y = \text{neut}(y)$ then; $(\langle x, y \rangle)^2 \leq \langle x, x \rangle \cdot \langle y, y \rangle$. We suppose that $x \neq \text{neut}(x)$. From the theorem 3.4; if

$$f(\alpha, (\alpha \#_2 x) *_2 (\beta \#_2 y), x) = f(\alpha, x, x) = f(\alpha, x, x) = \frac{-\langle x, y \rangle}{\langle x, x \rangle},$$

$$f(\beta, (\alpha \#_2 x) *_2 (\beta \#_2 y), y) = f(\beta, y, y) = f(\beta, x, y) = 1 \text{ are taken;}$$

$$0 \leq \langle (\alpha \#_2 x) *_2 (\beta \#_2 y), (\alpha \#_2 x) *_2 (\beta \#_2 y) \rangle =$$

$$f(\alpha, (\alpha \#_2 x) *_2 (\beta \#_2 y), x) \cdot f(\alpha, x, x) \cdot \langle x, x \rangle +$$

$$[f(\alpha, (\alpha \#_2 x) *_2 (\beta \#_2 y), x) \cdot f(\beta, x, y) + f(\beta, (\alpha \#_2 x) *_2 (\beta \#_2 y), y) \cdot f(\alpha, x, y)] \cdot \langle x, y \rangle +$$

$$f(\beta, (\alpha \#_2 x) *_2 (\beta \#_2 y), y) \cdot f(\beta, y, y) \cdot \langle y, y \rangle =$$

$$\left(\frac{\langle x, y \rangle}{\langle x, x \rangle} \right)^2 \cdot \langle x, x \rangle - \frac{\langle x, y \rangle \cdot \langle x, y \rangle}{\langle x, x \rangle} - \frac{\langle x, y \rangle \cdot \langle x, y \rangle}{\langle x, x \rangle} + \langle y, y \rangle =$$

$$\frac{\langle x, y \rangle^2}{\langle x, x \rangle} - \left(\frac{\langle x, y \rangle}{\langle x, x \rangle} \right)^2 - \frac{\langle x, y \rangle^2}{\langle x, x \rangle} + \langle y, y \rangle = \langle y, y \rangle - \frac{\langle x, y \rangle^2}{\langle x, x \rangle}. \text{ Thus; we have}$$

$$0 \leq \langle y, y \rangle - \frac{\langle x, y \rangle^2}{\langle x, x \rangle} \text{ and}$$

$$0 \leq \langle x, x \rangle \cdot \langle y, y \rangle - \langle x, x \rangle \cdot \frac{\langle x, y \rangle^2}{\langle x, x \rangle}$$

$$(\langle x, y \rangle)^2 \leq \langle x, x \rangle \cdot \langle y, y \rangle.$$

Theorem 3.6: Let $(\text{NTV}, *_2, \#_2)$ be a neutrosophic triplet vector space on $(\text{NTF}, *_1, \#_1)$ neutrosophic triplet field and let $(\text{NTV}, *_2, \#_2), \langle \cdot, \cdot \rangle$ be a neutrosophic triplet inner product space on $(\text{NTV}, *_2, \#_2)$ and $f: \text{NTF} \times \text{NTV} \times \text{NTV} \rightarrow \mathbb{R}^+ \cup \{0\}$, $f(\alpha, x, y) = f(\text{anti}(\alpha), \text{anti}(x), \text{anti}(y))$ is a function and for every $x, y \in \text{NTV}$ and $\alpha \in \text{NTF}$. If $f(\alpha, x, x) = f(\alpha, x)$ and $\|x\| = \langle x, x \rangle^{1/2}$. Then; $(\text{NTV}, *_2, \#_2), \|\cdot\|$ is a neutrosophic triplet normed space on $(\text{NTV}, *_2, \#_2)$.

Proof: As $(\text{NTV}, *_2, \#_2), \langle \cdot, \cdot \rangle$ is a neutrosophic triplet inner product space and $f(\alpha, x, x) = f(\alpha, x)$, we have;

a) $\|x\| = \langle x, x \rangle^{1/2} \geq 0.$

b) If $x = \text{neut}(x)$ then; $\langle x, x \rangle^{1/2} = \|x\| = 0.$

c) $\|\alpha \#_2 x\| = \langle \alpha \#_2 x, \alpha \#_2 x \rangle^{1/2} = f(\alpha, x, x)^{1/2} \cdot f(\alpha, x, x)^{1/2} \cdot \langle x, x \rangle^{1/2} = f(\alpha, x, x) \cdot \langle x, x \rangle^{1/2} = f(\alpha, x) \cdot \|x\|$

d) $\|\text{anti}(x)\| = \langle \text{anti}(x), \text{anti}(x) \rangle^{1/2} = \langle x, x \rangle^{1/2} = \|x\|$

e) From the theorem 3.4; if

$$f(\alpha, (\alpha \#_2 x) *_2 (\beta \#_2 y), x) = f(\alpha, x, x) = f(\alpha, x, x) = f(\beta, (\alpha \#_2$$

$x) *_{\#_2} (\beta_{\#_2} y), y) = f(\beta, y, y) = f(\beta, x, y) = 1$ and $\langle (\alpha_{\#_2} x) *_{\#_2} (\beta_{\#_2} y), (\alpha_{\#_2} x) *_{\#_2} (\beta_{\#_2} y) \rangle = \langle x *_{\#_2} y, x *_{\#_2} y \rangle$ are taken;

$$\begin{aligned} \|x *_{\#_2} y\|^2 &= \langle (\alpha_{\#_2} x) *_{\#_2} (\beta_{\#_2} y), (\alpha_{\#_2} x) *_{\#_2} (\beta_{\#_2} y) \rangle = \langle x *_{\#_2} y, x *_{\#_2} y \rangle \\ &= f(\alpha, (\alpha_{\#_2} x) *_{\#_2} (\beta_{\#_2} y), x) \cdot f(\alpha, x, x) \cdot \langle x, x \rangle + [f(\alpha, (\alpha_{\#_2} x) *_{\#_2} (\beta_{\#_2} y), x), \\ & f(\beta, x, y) + f(\beta, (\alpha_{\#_2} x) *_{\#_2} (\beta_{\#_2} y), y) \cdot f(\alpha, x, y)] \cdot \langle x, y \rangle + f(\beta, (\alpha_{\#_2} x) *_{\#_2} (\beta_{\#_2} y), y) \cdot f(\beta, y, y) \cdot \langle y, y \rangle \\ &= \langle x, x \rangle + 2 \cdot \langle x, y \rangle + \langle y, y \rangle \end{aligned}$$

$\|x\|^2 + 2 \cdot \langle x, y \rangle + \|y\|^2$. From the theorem 3.5; if $\text{neut}(x) = \text{neut}(y)$ then;

$$\langle x, y \rangle^2 \leq \langle x, x \rangle \cdot \langle y, y \rangle$$

$$\|x\|^2 + 2 \cdot \langle x, y \rangle + \|y\|^2 \leq$$

$$\|x\|^2 + 2\|x\|\|y\| + \|y\|^2 = (\|x\| + \|y\|)^2.$$

Since $\text{neut}(x) = \text{neut}(y)$; it is clear that $\|x *_{\#_2} y\| \leq \|x *_{\#_2} y *_{\#_2} \text{neut}(k)\|$. Where we can take $\text{neut}(k) = \text{neut}(x)$. Thus; $\|x *_{\#_2} y *_{\#_2} \text{neut}(k)\| \leq \|x\| + \|y\|$

Corollary 3.7: Let $((\text{NTV}, *_{\#_2}, \#_{\#_2}), \|\cdot\|)$ be a neutrosophic triplet normed space on $(\text{NTF}, *_{\#_1}, \#_{\#_1})$ neutrosophic triplet field and let $((\text{NTV}, *_{\#_2}, \#_{\#_2}), \langle \cdot, \cdot \rangle)$ be a neutrosophic triplet inner product space on $(\text{NTF}, *_{\#_1}, \#_{\#_1})$ neutrosophic triplet field such that $\|x\| = \langle x, x \rangle^{1/2}$. Then, the function $d: \text{NTV} \times \text{NTV} \rightarrow \mathbb{R}$ defined by $d(x, y) = \|x *_{\#_2} \text{anti}(y)\| = \langle x *_{\#_2} \text{anti}(y), x *_{\#_2} \text{anti}(y) \rangle^{1/2}$ provides neutrosophic triplet metric space conditions.

Proof: It is clear that from proposition 2.14.

Corollary 3.8: Every neutrosophic triplet metric space is reduced by a neutrosophic triplet inner product space. But the opposite is not always true. Similarly; Every neutrosophic triplet normed space is reduced by a neutrosophic triplet inner product space. But the opposite is not always true.

Definition 3.9: Let $((\text{NTV}, *_{\#_2}, \#_{\#_2}), \|\cdot\|)$ be a $((\text{NTV}, *_{\#_2}, \#_{\#_2}), \langle \cdot, \cdot \rangle)$ normed space on

$(\text{NTF}, *_{\#_1}, \#_{\#_1})$ neutrosophic triplet field and $((\text{NTV}, *_{\#_2}, \#_{\#_2}), \langle \cdot, \cdot \rangle)$ be a neutrosophic triplet inner product space such that $\|x\| = \langle x, x \rangle^{1/2}$. $d: \text{NTV} \times \text{NTV} \rightarrow \mathbb{R}$ neutrosophic triplet metric define by $d(x, y) = \|x *_{\#_2} \text{anti}(y)\| = \langle x *_{\#_2} \text{anti}(y), x *_{\#_2} \text{anti}(y) \rangle^{1/2}$ is called the neutrosophic triplet inner product space reduced by $(\text{NTV}, *_{\#_2}, \#_{\#_2})$.

Now let's define the convergence of a sequence and a Cauchy sequence in the neutrosophic triplet inner space with respect to neutrosophic triplet metric which is reduced by neutrosophic triplet inner space.

Definition 3.10: Let $((NTV, *_2, \#_2), <., .>)$ be a neutrosophic triplet inner product space on $(NTF, *_1, \#_1)$ neutrosophic triplet field, $\{x_n\}$ be a sequence in this space and d be a neutrosophic triplet metric reduced by $((NTV, *_2, \#_2), <., .>)$. For all $\varepsilon > 0$, $x \in NTV$ such that for all $n \geq M$

$$d(x, \{x_n\}) = \langle x *_2 \text{anti}(\{x_n\}), x *_2 \text{anti}(\{x_n\}) \rangle >^{1/2} < \varepsilon$$

if there exists a $M \in \mathbb{N}$; $\{x_n\}$ sequence converges to x . It is denoted by

$$\lim_{n \rightarrow \infty} x_n = x \text{ or } x_n \rightarrow x$$

Definition 3.11: Let $((NTV, *_2, \#_2), <., .>)$ be a neutrosophic triplet inner product space on $(NTF, *_1, \#_1)$ neutrosophic triplet field, $\{x_n\}$ be a sequence in this space and d be a neutrosophic triplet metric reduced by $((NTV, *_2, \#_2), <., .>)$. For all $\varepsilon > 0$, $x \in NTV$ such that for all $n \geq M$

$$d(\{\{x_m\}, \{x_n\}\}) = \|\langle x *_2 \text{anti}(\{x_n\}) \rangle\| < \varepsilon$$

$$(\{\{x_m\} *_2 \text{anti}(\{x_n\}), \{\{x_m\} *_2 \text{anti}(\{x_n\})\}) >^{1/2} < \varepsilon$$

if there exists a $M \in \mathbb{N}$; $\{x_n\}$ sequence is called Cauchy sequence.

Definition 3.12: Let $((NTV, *_2, \#_2), <., .>)$ be a neutrosophic triplet inner product space on $(NTF, *_1, \#_1)$ neutrosophic triplet field, $\{x_n\}$ be a sequence in this space and d be a neutrosophic triplet metric reduced by $((NTV, *_2, \#_2), <., .>)$. If each $\{x_n\}$ Cauchy sequence in this space is convergent to d reduced neutrosophic triplet metric; $((NTV, *_2, \#_2), <., .>)$ is called neutrosophic triplet Hilbert space.

Theorem 3.13: Let $((NTV, *_2, \#_2), <., .>)$ be a neutrosophic triplet inner product space on $(NTF, *_1, \#_1)$ neutrosophic triplet field, and $\{x_n\}$ and $\{y_n\}$ be sequences in $((NTV, *_2, \#_2), <., .>)$ such that $\{x_n\} \rightarrow x \in NTV$ and $\{y_n\} \rightarrow y \in NTV$, then;

$$\lim_{n \rightarrow \infty} \langle x_n, y_n \rangle = \langle x, y \rangle$$

Proof: $|\langle x_n, y_n \rangle - \langle x, y \rangle| = |\langle x_n, y_n \rangle - \langle x_n, y \rangle + \langle x_n, y \rangle - \langle x, y \rangle| \leq |\langle x_n, y_n \rangle - \langle x_n, y \rangle| + |\langle x_n, y \rangle - \langle x, y \rangle| = |\langle x_n, y_n - y \rangle| + |\langle x_n - x, y \rangle|$. From theorem 3.5; as $(\langle x, y \rangle)^2 \leq \langle x, x \rangle \cdot \langle y, y \rangle$ and from definition 3.9; as

$$d(x, y) = \|\langle x *_2 \text{anti}(y) \rangle\| = \langle x *_2 \text{anti}(y), x *_2 \text{anti}(y) \rangle >^{1/2},$$

$$|\langle x_n, y_n - y \rangle| + |\langle x_n - x, y \rangle| \leq \|x_n\| \|y_n - y\| + \|x_n - x\| \|y\|.$$

As $\{x_n\} \rightarrow x$ and $\{y_n\} \rightarrow y$; $\lim_{n \rightarrow \infty} \langle x_n, y_n \rangle = \langle x, y \rangle$

4 Conclusion

In this paper, we introduced neutrosophic triplet inner product space. We also show that this neutrosophic triplet notion different from the classical notion. This neutrosophic triplet notion has several extraordinary properties compared to the classical notion. We also studied some interesting properties of this newly born structure. We give rise to a new field or research called neutrosophic triplet inner product space.

References

- [1] Zadeh Lotfi A., „Fuzzy sets." *Information and control*, (1965), pp. 338-353,
- [2] Atanassov, T. K., (1986) Intuitionistic fuzzy sets, *Fuzzy Sets Syst*, (1986) 20:87–96
- [3] Smarandache F., *A Unifying Field in logics, Neutrosophy: Neutrosophic Probability, Set and Logic*, American Research Press (1999)
- [4] Kandasamy WBV, Smarandache F., Basic neutrosophic algebraic structures and their applications to fuzzy and neutrosophic models, *Hexis, Frontigan* (2004) p 219
- [5] Kandasamy WBV., Smarandache F., Some neutrosophic algebraic structures and neutrosophic n-algebraic structures. *Hexis, Frontigan* (2006) p 219
- [6] Smarandache F., & Ali M., Neutrosophic triplet as extension of matter plasma, unmatter plasma and antimatter plasma, *APS Gaseous Electronics Conference* (2016), doi: 10.1103/BAPS.2016.GEC.HT6.110
- [7] Smarandache F., & Ali M., The Neutrosophic Triplet Group and its Application to Physics, presented by F. S. to Universidad Nacional de Quilmes, Department of Science and Technology, Bernal, Buenos Aires, Argentina (02 June 2014)
- [8] Smarandache F., & Ali M., Neutrosophic triplet group. *Neural Computing and Applications*, (2016) 1-7.
- [9] Smarandache F., & Ali M., Neutrosophic Triplet Field Used in Physical Applications, (Log Number: NWS17-2017-000061), 18th Annual Meeting of the APS Northwest Section, Pacific University, Forest Grove, OR, USA (June 1-3, 2017)
- [10] Smarandache F., & Ali M., Neutrosophic Triplet Ring and its Applications, (Log Number: NWS17-2017-000062), 18th Annual Meeting of the APS Northwest Section, Pacific University, Forest Grove, OR, USA (June 1-3, 2017).
- [11] Şahin, M., and Kargin, A., Neutrosophic triplet normed space, *Open Physics*, (2017). Accepted
- [12] Broumi S., Bakali A., Talea M., Smarandache F., Single Valued Neutrosophic Graphs: Degree, Order and Size. *IEEE International Conference on Fuzzy Systems (FUZZ)* (2016), pp. 2444-2451.
- [13] Broumi S., Bakali A., Talea M., Smarandache F. Decision-Making Method Based On the Interval Valued Neutrosophic Graph, *Future Technologie, IEEE* (2016), pp. 44-50.
- [14] Broumi S., Bakali A., Talea M., Smarandache F., Vladareanu L. Computation of Shortest Path Problem in a Network with SV-Trapezoidal Neutrosophic Numbers, *Proceedings of the 2016 International Conference on Advanced Mechatronic Systems*, Melbourne, Australia, (2016) pp. 417-422.
- [15] Liu P. and Shi L., The Generalized Hybrid Weighted Average Operator Based on Interval Neutrosophic Hesitant Set and Its Application to Multiple Attribute Decision Making, *Neural Computing and Applications* (2015) 26(2): 457-471

- [16] Liu P. and Shi L., Some Neutrosophic Uncertain Linguistic Number Heronian Mean Operators and Their Application to Multi-attribute Group Decision making, *Neural Computing and Applications* (2015) doi:10.1007/s00521-015-2122-6
- [17] Liu P., Tang G., Some power generalized aggregation operators based on the interval neutrosophic numbers and their application to decision making, *Journal of Intelligent & Fuzzy Systems* 30 (2016) 2517-2528
- [18] Liu P. and Tang G., Multi-criteria group decision-making based on interval neutrosophic uncertain linguistic variables and Choquet integral, *Cognitive Computation*, (2016) 8(6) 1036-1056
- [19] Liu P. and Wang Y., Interval neutrosophic prioritized OWA operator and its application to multiple attribute decision making, *journal of systems science & complexity* (2016) 29(3): 681-697
- [20] Liu P., Teng F., Multiple attribute decision making method based on normal neutrosophic generalized weighted power averaging operator, *internal journal of machine learning and cybernetics* (2015) 10.1007/s13042-015-0385-y
- [21] Liu P., Zhang L., Liu X., and Wang P., Multi-valued Neutrosophic Number Bonferroni mean Operators and Their Application in Multiple Attribute Group Decision Making, *internal journal of information technology & decision making* (2016) 15(5) 1181-1210
- [22] Sahin M., and Kargin A., Neutrosophic triplet metric space and neutrosophic triplet normed space, *ICMME -2017, Şanlıurfa*.
- [23] Sahin M., Deli I., I, and Ulucay V., Jaccard vector similarity measure of bipolar neutrosophic set based on multi-criteria decision making. In: *International conference on natural science and engineering (ICNASE'16)*, (2016) March 19–20, Kilis
- [24] Sahin M., Deli I., and Ulucay V., Similarity measure of bipolar neutrosophic sets and their application to multiple criteria decision making, *Neural Comput & Applic* (2016) DOI 10. 1007/S00521
- [25] Liu C. and Luo Y., Power aggregation operators of simplified neutrosophic sets and their use in multi-attribute group decision making, *IEEE/CAA Journal of Automatica Sinica* (2017) Vol pp, issue: 99, DOI: 10.1109/JAS.2017.7510424
- [26] Sahin R. and Liu P., Some approaches to multi criteria decision making based on exponential operations of simplified neutrosophic numbers, *Journal of Intelligent & Fuzzy Systems* (2017) vol. 32, no. 3, pp 2083-2099, DOI: 10.3233/JIFS-161695
- [27] Liu P. and Li H., Multi attribute decision-making method based on some normal neutrosophic bonferroni mean operators, *Neural Computing and Applications* (2017) vol. 28, issue 1, pp 179-194, DOI 10.1007/s00521-015-2048-z
- [28] Şahin M., Olgun N., Uluçay V., Kargin A., and Smarandache, F., A new similarity measure on falsity value between single valued neutrosophic sets based on the centroid points of transformed single valued neutrosophic numbers with applications to pattern recognition, *Neutrosophic Sets and Systems*, (2017) vol 15. Pp 31-48, doi: org/10.5281/zenodo570934
- [29] Şahin M., Ecemiş O., Uluçay V., and Kargin, A., Some new generalized aggregation operators based on centroid single valued triangular neutrosophic numbers and their applications in multi-attribute decision making, *Asian Journal of Mathematics and Computer Research* (2017) 16(2): 63-84.
- [30] Abdel-Basset, Mohamed, et al. "A novel group decision-making model based on triangular neutrosophic numbers." *Soft Computing* (2017): 1-15. DOI: <https://doi.org/10.1007/s00500-017-2758-5>
- [31] Hussian, Abdel-Nasser, et al. "Neutrosophic Linear Programming Problems." *Peer Reviewers*: 15.
- [32] Abdel-Basset, Mohamed, Mai Mohamed, Arun Kumar Sangaiah. "Neutrosophic AHP-Delphi Group decision making model based on trapezoidal neutrosophic numbers."

Journal of Ambient Intelligence and Humanized Computing (2017): 1-17. DOI: <https://doi.org/10.1007/s12652-017-0548-7>

[33] Mohamed, Mai, et al. "A Critical Path Problem in Neutrosophic Environment." Peer Reviewers: 167.

[34] Mohamed, Mai, et al. "A Critical Path Problem Using Triangular Neutrosophic Number." Peer Reviewers: 155.

[35] Mohamed, Mai, et al. "Using Neutrosophic Sets to Obtain PERT Three-Times Estimates in Project Management." Peer Reviewers: 143.

[36] Mohamed, Mai, et al. "Neutrosophic Integer Programming Problem." *Neutrosophic Sets & Systems* 15 (2017).

[37] Abdel-Baset, Mohamed, Ibrahim M. Hezam, Florentin Smarandache. "Neutrosophic goal programming." *Neutrosophic Sets Syst* 11 (2016): 112-118.

[38] Hezam, Ibrahim M., Mohamed Abdel-Baset, and Florentin Smarandache. "Taylor series approximation to solve neutrosophic multiobjective programming problem." *Neutrosophic Sets and Systems* 10 (2015): 39-46.

[39] El-Hefenawy, Nancy, et al. "A review on the applications of neutrosophic sets." *Journal of Computational and Theoretical Nanoscience* 13.1 (2016): 936-944.

[40] I. Arokiarani, R. Dhavaseelan, S. Jafari, M. Parimala: On Some New Notions and Functions in Neutrosophic Topological Spaces, *Neutrosophic Sets and Systems*, Vol. 16 (2017), pp. 16-19. doi.org/10.5281/zenodo.831915

[41] R. Dhavaseelan, S. Jafari, R. Narmada Devi, Md. Hanif Page: Neutrosophic Baire Spaces, *Neutrosophic Sets and Systems*, Vol. 16 (2017), pp. 20-23. doi.org/10.5281/zenodo.831920

[42] P. Iswarya, K. Bageerathi: A Study on Neutrosophic Frontier and Neutrosophic Semi-frontier in Neutrosophic Topological Spaces, *Neutrosophic Sets and Systems*, Vol. 16 (2017), pp. 6-15. doi.org/10.5281/zenodo.831913

[43] A.A.A. Agboola, S.A. Akinleye: Neutrosophic Vector Spaces, *Neutrosophic Sets and Systems*, vol. 4, 2014, pp. 9-18. doi.org/10.5281/zenodo.571579

This book treats all kind of data in neutrosophic environment, with real-life applications, approaching topics as linear programming problem, linear fractional programming, integer programming, triangular neutrosophic numbers, single valued triangular neutrosophic number, neutrosophic optimization, goal programming problem, Taylor series, multi-objective programming problem, neutrosophic geometric programming, neutrosophic topology, neutrosophic open set, neutrosophic semi-open set, neutrosophic continuous function, cylindrical skin plate design, neutrosophic MULTIMOORA, alternative solutions, decision matrix, ratio system, reference point method, full multiplicative form, ordinal dominance, standard error, market research, and so on. The selected papers deal with the alleviation of world changes, including changing demographics, accelerating globalization, rising environmental concerns, evolving societal relationships, growing ethical and governance concern, expanding the impact of technology; some of these changes have impacted negatively the economic growth of private firms, governments, communities, and the whole society.

ISBN 978-1-59973-537-5



9 781599 735375 >