



Granular computing neural-fuzzy modelling: A neutrosophic approach

Adrian Rubio Solis, George Panoutsos*

The University of Sheffield, Department of Automatic Control and Systems Engineering, Mappin St., Sheffield S1 3JD, UK

ARTICLE INFO

Article history:

Received 31 March 2012

Received in revised form 22 July 2012

Accepted 3 September 2012

Available online 23 September 2012

Keywords:

Granular computing
Information granulation
Neural-fuzzy logic
Neutrosophic logic
Charpy toughness

ABSTRACT

Granular computing is a computational paradigm that mimics human cognition in terms of grouping similar information together. Compatibility operators such as cardinality, orientation, density, and multidimensional length act on both in raw data and information granules which are formed from raw data providing a framework for human-like information processing where information granulation is intrinsic. Granular computing, as a computational concept, is not new, however it is only relatively recent when this concept has been formalised computationally via the use of Computational Intelligence methods such as Fuzzy Logic and Rough Sets. Neutrosophy is a unifying field in logics that extends the concept of fuzzy sets into a three-valued logic that uses an indeterminacy value, and it is the basis of neutrosophic logic, neutrosophic probability, neutrosophic statistics and interval valued neutrosophic theory. In this paper we present a new framework for creating Granular Computing Neural-Fuzzy modelling structures via the use of Neutrosophic Logic to address the issue of uncertainty during the data granulation process. The theoretical and computational aspects of the approach are presented and discussed in this paper, as well as a case study using real industrial data. The case study under investigation is the predictive modelling of the Charpy Toughness of heat-treated steel; a process that exhibits very high uncertainty in the measurements due to the thermomechanical complexity of the Charpy test itself. The results show that the proposed approach leads to more meaningful and simpler granular models, with a better generalisation performance as compared to other recent modelling attempts on the same data set.

© 2012 Elsevier B.V. All rights reserved.

1. Introduction

Extracting information and converting it to ‘easy to interpret’ knowledge is a very important but not a trivial task in Systems Engineering, in particular in the case of very complex and non-linear processes [1]. Within this context, Soft Computing techniques can be utilised to offer their transparency and interpretability potential. Transparency plays a significant role as a measure of interpretability and distinguishability, i.e. the more interpretable information of a system under study, the better its understanding. Unlike popular clustering approaches such as Fuzzy C-Means, Granular Computing (GrC) [2,3] groups data not only based on similar mathematical properties such as proximity but also it considers the raw data as conceptual entities that are captured in a compact and transparent manner [4]. Therefore, such individual entities are merged into dense information granules whose similarity [3] can be evaluated in a variety of ways depending on the application at hand. In GrC all operators act on the information granules and raw data, which can embed useful (for the data mining process) granular knowledge

such as the proximity to other information granules, cardinality, density, function similarity, orientation, overlap, etc.

In literature a number of granular frameworks appeared [5–8] via the use of Rough Sets, Fuzzy Logic and Neural Networks.

Even though granulation process [8] groups similar entities, there is not any measure which leads how much a granule must grow. This phenomenon produces a grade of inclusion uncertainty among the new granules as a consequence of a ravenous behaviour. Usually, in fuzzy systems a parsimony model is related to its interpretability as a consequence of a good distinguishability. However, as it is mentioned in [9] when adaptive learning algorithm is introduced into a fuzzy inference system, there might be a loss in the interpretability. We believe a distinguishable and initial granular framework can aid in the estimation of the fuzzy inference parameters. To exemplify a case study model used in this paper is based on a real industry dataset related to the measurement of Charpy Toughness in heat-treatment steel and it suffers from sparsely data set [10,11]. The use of Neutrosophic domain provides an extra dimension which measures the entropy produced by the creation of a new granule. And it persuades the compatibility search in eliminating potential granules to be merged. In this paper we present a systematic approach for the construction of granular objects by means of a Neural-Fuzzy modelling structure based on Radial Basis Functions (RBF) and Neutrosophy. A Neural Fuzzy system combines the learning capabilities of Neural-Networks (NN)

* Corresponding author.

E-mail addresses: coq10ar@sheffield.ac.uk (A.R. Solis), g.panoutsos@sheffield.ac.uk (G. Panoutsos).

and the advantages of system transparency as offered by Fuzzy-Logic (FL) systems. Furthermore, a large number of NF approaches have been proposed in the past, just to name a few [12–18].

In spite of the functional equivalence between RBF neural networks and fuzzy systems (FS) [12,19], fuzzy capabilities such as transparency and interpretability loss their real power as a consequence of black-box properties in RBF neural structures. Therefore, one of the major objectives in Soft Computing (SC) systems and modelling, the development of transparent knowledge and rule-bases is crucial for the interpretation of real world systems. The motivation behind the research work presented in this paper is to propose a systematic methodology by using granulation that is capable of identifying the data uncertainty produced by merging two different information granules in a data space. In particular, those granules which are quite similar, and how their orientation can be influenced in order to produce better distinguishability in the creation of fuzzy partitions.

In this paper, the hesitation produced during information granulation particularly due to the lack of distinguishability in the initial fuzzy partition is measured by the use of a neutrosophic index [20], which is a generalization of the Intuitionistic Fuzzy Sets [21]. In intuitionistic theory the uncertainty of an element A is produced by $\pi_A = \mu_A + \nu_A \leq 1$, and $\mu_A: X \rightarrow [0,1]$ and $\nu_A: X \rightarrow [0,1]$. In neutrosophic sets the tuple $\langle t, i, f \rangle$ represents the truth, falsehood, and indeterminacy, with the latter often used in literature as uncertainty, hesitation, ignorance, etc. From a mathematical point of view, neutrosophic sets and the set-theoretic operators should be defined according to the problem at hand. In this paper we define the set-theoretic operators based on the entropy (uncertainty) produced by the distribution of membership functions in the initial clustering stage. The neutrosophic components $\langle t, i, f \rangle$ define the domain in which an element belongs (t =true=membership) or not (f =false=non-membership) to a certain fuzzy set and if the compatibility criterion in granulation produces a high indeterminate value (uncertainty). In Fuzzy Logic theory, entropy has been employed as a measure of Fuzzy information about a Fuzzy set or system in the universe of discourse. Shannon considered the logarithmic behaviour of the entropy due to its addition property [22], and as an information gain from an event that is inversely related to its occurrence [23].

For example in [24] an ensemble NN was presented to predict mineral prospectivity into deposit or barren cell. In that work, two Neural Networks were employed to estimate the degree of truth and false membership values, and finally calculate the degree of indeterminacy by a using an interpolation method. In this paper, the Neutrosophic scheme is utilised to influence the compatibility measure between granules by evaluating the uncertainty produced by the merging of the information granules. This paper is organised as follows: in the next section, Section 2, a systematic modelling approach is presented based on Granular Computing and an RBF Neural-Fuzzy structure. Section 3 presents a Neutrosophic scheme based on a version of Shannon’s entropy definition for the formulation of uncertainty to account for any uncertainty produced during the merging of the information granules. In Section 4, a case study is presented based on a real industry dataset related to the measurement of Charpy Toughness in heat-treated steel. This process is known in the steel industry for the uncertainty induced in the measurements due to complex thermomechanical phenomena during the mechanical testing of the material. Finally, Section 5 concludes this paper and suggests possible future research directions.

2. Granular computing and RBF neural-fuzzy networks

Granular computing is a computational paradigm that mimics the cognitive human abstraction in order to group together entities

with similar features, i.e. volume, density, geometrical properties, cardinality, function, overlap, etc. To achieve the information grouping, granulation employs a criterion measure that calculates a ‘compatibility index’ based on granular similarity. In essence, granulation is an iterative process, which consists of two main steps. In this paper, we will extend a method based on the iterative approach shown in [4,8]:

- Find the two most compatible information granules and merge them together as a new information granule containing both original granules.
- Repeat the process of finding the two most compatible granules until a satisfactory data abstraction level is achieved.

The compatibility index $C(A,B)$, defined as the merging two different granules A and B is based on various geometrical properties and the number of elements that form each granule. The compatibility defines the most important concept during the granulation process.

$$C(A, B) = \text{Distance}_{\text{MAX}} - \text{Distance}_{A,B} \cdot \exp(-\alpha \times R) \tag{1}$$

in which

$$R = \frac{C_{A,B}/\text{Cardinality}_{\text{MAX}}}{L_{A,B}/\text{Length}_{\text{MAX}}}$$

$\text{Distance}_{\text{MAX}}$ = maximum possible distance in the data set, $\text{Distance}_{A,B}$ = the multidimensional average distance.

Between two granules A, B such as:

$$\text{Distance}_{A,B} = \frac{\sum_{i=1}^d w_i (D_1 - D_2)}{d} \tag{2}$$

In which

$$D_1 = \max(\max_{A_i}, \max_{B_i})$$

$$D_2 = \min(\min_{A_i}, \min_{B_i})$$

w_i : the importance weight for dimension i ; d : the number of dimensions; \max_{X_i} : max limit of granule ‘ X ’ in dimension ‘ i ’; \min_{X_i} : min limit of granule ‘ X ’ in dimension ‘ i ’; α : weights the requirements between distance and cardinality/length [8]; $\text{Cardinality}_{\text{MAX}}$: the maximum possible cardinality in the data set; $\text{Length}_{\text{MAX}}$: the maximum possible length of a granule in the data set; $C_{A,B}$: the cardinality of the resulting granules; $L_{A,B}$: the multidimensional length of the resulting granule, where \max_{X_i} and \min_{X_i} are the maximum and minimum length respectively of the resulting granule at each dimension i .

$$L_{A,B} = \sum_{i=1}^d (\max_{X_i} - \min_{X_i}) \tag{3}$$

To exemplify the compatibility calculation $C(A,B)$ [4], in Fig. 1 is given a 2-dimensional granular space where the granule A and B are merged. The term α is used as a threshold value in the interval $[0-1]$ to balance the two compatibility measures of ‘distance’ and ‘density’ (cardinality/size), and w_i weights each dimension according the problem at hand [4]. In this work, w_i is used with the value of 1 in every dimension. In Fig. 1, granules A and B produce the following values:

$$\text{Distance}_{\text{MAX}} = \sum_{i=1}^d \text{distances}_i = \sum_{i=1}^{d=2} (1 - (-1)) = 4;$$

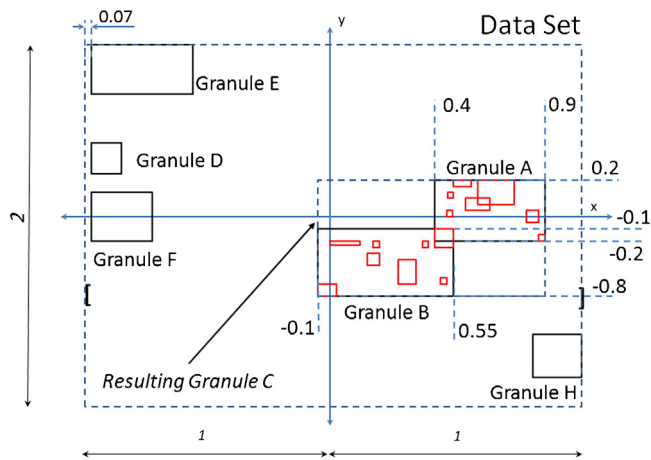

Fig. 1. Resulting Granule 'C'.

$$Distance_{A,B} = \frac{\{\max(0.9, 0.55) - \min(0.4, -0.1)\}}{2} + \frac{\{\max(0.2, -0.1) - \min(-0.8, -0.2)\}}{2} = 1$$

$$C_{A,B} = Cardinality_A + Cardinality_B = 15 \text{ Granules};$$

$$Cardinality_{MAX} = Granule_A + Granule_B + Granule_D + Granule_E + Granule_F + Granule_H = 8 + 7 + 10 + 2 + 6 + 8 + 2 = 43 \text{ Granules}$$

$$L_{A,B} = 2;$$

$$Length_{MAX} = 3.93;$$

$$a = 0.35;$$

$$C(A, B) = 4 - 1 \times \exp(-0.35 \times 0.685) = 3.123$$

Since the compatibility criterion in Equation (1) is based on the multidimensional length of each granule and its cardinality, the granular index decreases while the numbers of iterations increases, as less compatible granules are merged. Fig. 2, illustrates a typical evolution of the compatibility measure. As expected, the index reduces dramatically (fall-off) which represents less compatible (dissimilar information) is merged towards the end of the granulation process. This may be also used as a criterion to terminate the iterative process.

For simplicity purposes just two dimensions are used to demonstrate the granulation concept. Fig. 3 illustrates the granular compression with a two-dimensional data set at various levels. The top left graph in Fig. 3 shows the initial raw data, and then the subsequent graphs show how such data are merged to form the required number of final information granules. Moreover, Fig. 3, depicts the granular process divided into three main steps: (a) raw data; in this stage each datum is considered as a granule into the input space and hence compressed in compact and dense granules, (b) input space-data granulation; during this iterative process the initial number of granules is reduced according to their compatibility in which various similarity measures can be taken into account, such as: the size of granules, the cardinality, overlapping among granules, orientation, etc., and finally (c) output space-density function represents the linguistic interpretation of the final group of dense granules which preserve the original features of the raw data.

In the first stage of granulation the raw data are compressed in dense and compact granules. Without loss of generality, as it was explained in [8] the final geometrical boundaries of each information granule are used to estimate the initial value of C_j and σ_j which are illustrated in Fig. 4. The average hyper-box boundaries of each granule are utilised to calculate the initial C_j as follows:

$$C_j = [C_{11}, \dots, C_{ji}, C_{pn}]; \quad i = 1, \dots, n; j = 1, \dots, P \tag{4}$$

Where j is the j th hidden neuron and i the i th input.

$$C_{ji} = \frac{\max_{X_i} - \min_{X_i}}{2} \tag{5}$$

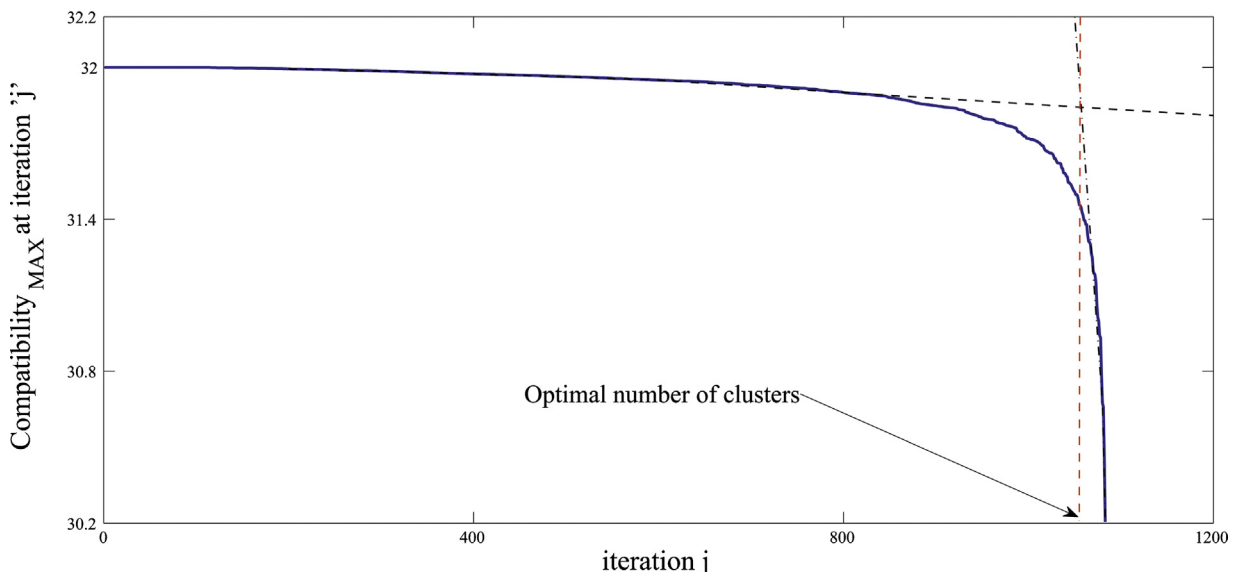

Fig. 2. Compatibility measure example.

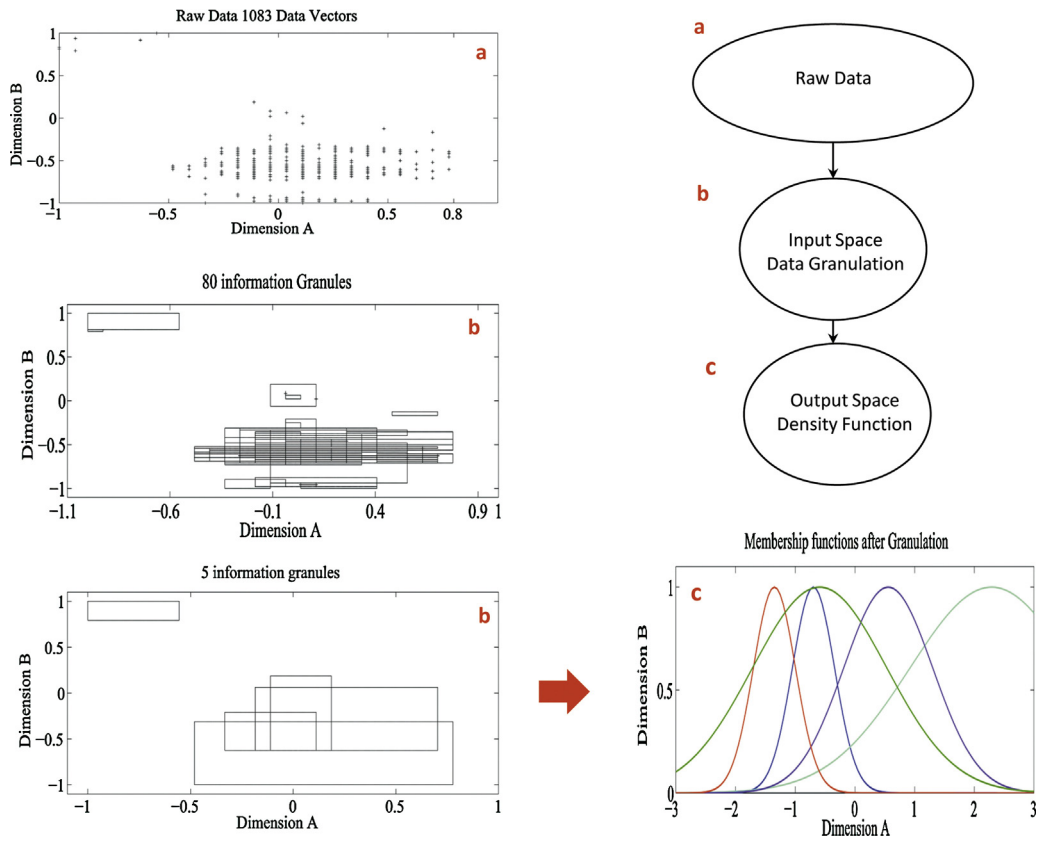

Fig. 3. Data granulation process.

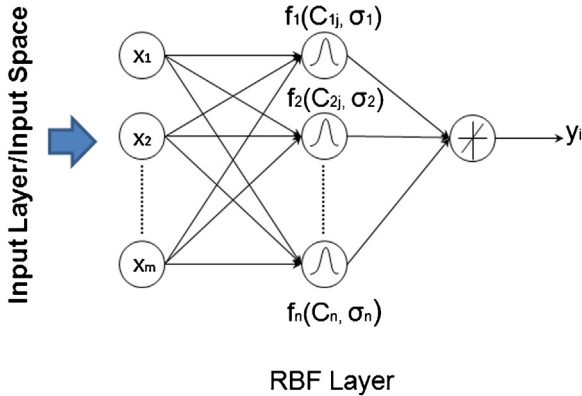

Fig. 4. General structure of an RBF-NN.

Here, the width of the Gaussian function in the RBF layer is estimated by [25] and hence its calculation is done via Equation (6):

$$\sigma_j = \frac{1}{r} \left(\sum_{k=1}^r \geq \|C_k - C_j\|^2 \right)^{1/2} \quad (6)$$

Where C_k is the nearest neighbours of centroid C_j .

2.1. Radial basis function neural networks

Considering the equivalence between the Radial Basis Function Neural Networks (RBFNN) and Takagi-Sugeno type-0 fuzzy systems (or type-1 Mamdani inference engine) as expressed in [13,14], an RBFNN combines the input-output $n + 1$ dimensional space $\{x_1, x_2, \dots, x_i, \dots, x_p, y_{p+1}\}$ where x_i represents the input partition and

y_{p+1} the corresponding output as is illustrated in Fig. 4. Due to this functional equivalence that lies on the fact [13]:

- (a) The number of the receptive fields (hidden layer) is equal to the number of if-then rules.
- (b) The output of each fuzzy if-then rule is composed of a constant.
- (c) The $n + 1$ dimensional membership is chosen as Gaussian function with the same variance.
- (d) The firing strength is based on the t-norm operator.
- (e) The RBFNN output is estimated on weighted average or weighted sum.

The final number of granules (Fig. 3) obtained after granulation process are used as the A_i initial fuzzy sets to construct the if-then rules as follows:

R_i : If x_1 is A_1 and x_2 is A_2, x_i is A_j, \dots , and x_n is A_p
 Then y is $z_i; m = 1, \dots, P = \text{number of hidden neurons}$
 Typically, z_j can take any of the following three forms:

- (1) Singleton
- (2) Fuzzy set
- (3) Input-based polynomial function

By assuming a one-to-one relationship between a multidimensional granule and a Fuzzy Logic linguistic rule of the form shown above, one can construct a whole rule-base using the information granules. The extra granular features (e.g. cardinality, centre of gravity) can be used to estimate an initial centre and width for the resulting Fuzzy sets of the rule-base as it will be shown over Section 3.1.

In this investigation, a system with a centre of gravity defuzzification will be used, product-inference rule, and a singleton output layer, which are expressed by:

$$y = \sum_{j=1}^p z_j \left\{ \frac{\prod_{i=1}^p \mu_{ji}(x_i)}{\sum_{j=1}^p \prod_{i=1}^p \mu_{ji}} \right\} \quad (7)$$

where μ_{ji} is the membership value of the input i which is in j th rule.

$$\mu_{ji} = \exp \left(\frac{-(x_j - c_{ij})^2}{\sigma_{ji}^2} \right) \quad (8)$$

Thus from (7) it can be written that:

$$y = \sum_{j=1}^p z_j g_j(x) \quad (9)$$

where g_j is defined as:

$$g_j(x) = \frac{m_j(x)}{\sum_{i=1}^p m_i(x)} \quad (10)$$

where x is the input vector and m its corresponding membership evaluation which is defined as:

$$m_j(x) = e^{(\|x - C_j\|/\sigma_j^2)} \quad (11)$$

Once the initial parameters c_{ij} and σ_{ij} are estimated, their optimisation can be carried out by using various algorithms including such as algorithms based on gradient descent (GD), or Evolutionary Algorithms (EA). In this research work an adaptive Back-Error-Propagation (BEP) algorithm is employed [13–15], which has been proven in the past to be very efficient in the optimisation of the proposed type of system.

The update rule for the centre estimation:

$$C_j(t + 1, i) = \gamma C_j(t, i) - \alpha e g_j(y_j - y) \left(\frac{x_i - C_j(t, i)}{d_j^2} \right) \quad (12)$$

The update rule for the width estimation:

$$d_j(t + 1) = \gamma d_j(t) - \alpha e g_j(y_j - y) \left(\frac{\sum_{i=1}^2 (x_i - C_j(t, i))^2}{d_j^3} \right) \quad (13)$$

The update rule for the output weight estimation:

$$w_j(t + 1) = \gamma w_j(t) - \alpha g_j e \quad (14)$$

where α : Learning rate; γ : Momentum. $e = y - y_t = \sum_{j=1}^p g_j \cdot y_j - y_t$

e is the training error of the i th data point; Y_j is j th output from the data; y is output from the model; t is t th training data point; i is i input to the neural network.

Although, the BEP leads the objective function to a good local minimum by using a small learning rate, often it does not represent the optimal performance of the system due to the algorithm 'getting stuck' in local minima. In order to overcome this issue a momentum based term and a continuously adaptive version of BEP is used, as previously presented in [8].

3. Neutrosophic logic in granular computing

The concept of Neutrosophic sets was introduced by F. Smarandache as a generalisation of fuzzy and intuitionistic logic [26] in order to deal with the truth (T), falsehood (F) and the indeterminacy (I) of an event to happen. In fact, Smarandache used the concept of infinitesimals in order to define the non-standard [27] real subsets $]^{-}a, b^{+}[$. According to [26,27], a number x is said to be an infinitesimal if and only if for all positive numbers n the number x is defined as $|x| < 1/n$. Moreover, the elements of a non-standard interval are $^{-}a = a - x$ and $b^{+} = b + x$. In Neutrosophic logic, its components are introduced by using a standard or non-standard unit interval as follows:

Let T, I, F be standard or non-standard real subsets of $]^{-}0, 1^{+}[$, with $\sup T = t_{\sup}$, $\inf T = t_{\inf}$
 $\sup I = i_{\sup}$, $\inf I = i_{\inf}$
 $\sup F = f_{\sup}$, $\inf F = f_{\inf}$
 where $\inf]^{-}a, b^{+}[= ^{-}a$ and $\sup]^{-}a, b^{+}[= b^{+}$

The elements T, I, F can be interpreted as intervals, standard or non-standard real sets, discrete, continuous, single-finite sets, operations under intersection or union, fuzzy numbers, normal distribution, etc. For this reason the tuple $\langle t, i, f \rangle$ [26] represents the *truth value, indeterminacy value and falsehood value*. In information theory [28] three basic types of uncertainty are defined, namely: (a) fuzziness: the lack of definite or sharp distinction, (b) ambiguity which is divided into two types (b-1) strife: defined as the disagreement in choosing several alternatives and (b-2) nonspecificity when two or more alternatives are left unspecified. Here, it is considered the lack of sharpness in the sense if two granules really belong to each other based on the local entropy produced by their merging.

The granulation process, as described in [8,29], aims to compress the initial data into compact and dense granules based on the resulting cardinality and the multidimensional length of any two merged granules. Moreover, this methodology exploits as much as possible the density ('richness' of information) of the granules. However, sometimes the introduction of a new granule in the input space produces a lack of distinguishability due to the overlapping which is not considered into the compatibility Equation (1). In order to address this issue we propose the introduction of granulation under a Neutrosophic scheme in order to estimate the uncertainty in the pattern space. The hypothesis is that if the granulation compatibility index 'favours' the merging of granules that will lead to less accumulated uncertainty in the data set then the resulting multidimensional granules, hence Fuzzy Rules, will have less uncertainty leading to more robust Fuzzy Inference models. On one hand, in Neutrosophic terms granulation uncertainty or granulation indeterminacy represents the 'hesitation' of two granules to belong to each other either as a single point or as an interval in the partition space. The interpretation of a granule in N dimensional space can be interpreted as a composition of N standard intervals $]^{-}0, L^{+}[$ where $L \geq 0$. On the other hand, in terms of fuzzy theory, fuzziness has been defined as a result from the *lack of sharpness of relevant distinctions*, and it is different from ambiguity. In [30] the definition of uncertainty is based on a distance function with the same general view of fuzziness.

$$f(A) = - \sum_{x \in X} A(x) \log_2 A(x) + \bar{A}(x) \log_2 \bar{A}(x) \quad (15)$$

In [23,31,32] various definitions of uncertainty have been proposed; here we will employ that defined in [23].

$$e_H = C + p_j e^{(1-p_j)} + (1 - p_j) e^{p_j}, C \in [0, 1] \quad (16)$$

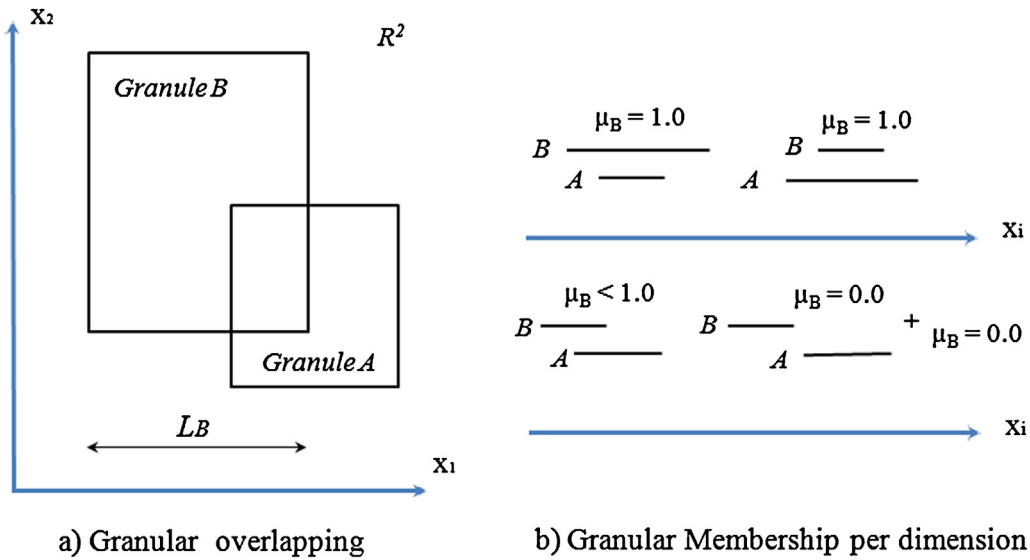

Fig. 5. Interval and numerical membership representation.

Where p is the probability of the event j and $\sum_j p_j = 1, 0 \leq p_j \leq 1$

In order to justify the exponential function, we denote its gain in information corresponding to the occurrence of the i th event [23] and its properties as any entropy expression.

P1: e_H is defined at all points in $[0,1]$

P2: $\lim_{p_i \rightarrow 0} e_H = \Delta e_H (p_i = 0) = k_1, k_1 \geq 0$ and finite

P3: $e_H (p_j = 1) = k_2, k_2 \geq 0$ and finite

P4: $k_2 < k_1$

P5: with increase in $e_H, \Delta e_H$ decreases exponentially.

In other words with increase in the uncertainty the gain in information increases exponentially. In a similar approach to the one presented in Equation (16), in Fuzzy Set theory p_j can represent the membership of an element $\mu_i \in U_x$ where U_x is the set of fuzzy sets. The aims of granulation in the proposed framework are to (a) define the linguistic scenario [8] under the compatibility criterion and (b) define its potential application in high dimensional variable space. From a GrC perspective, the interpretation of the membership in R^2 can be considered as shown in Fig. 5.

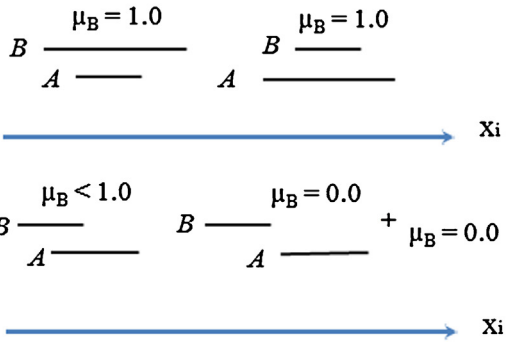

b) Granular Membership per dimension

Here $p_j = \mu_j / \sum_k \mu_k, n =$ all the granules k that overlap to granule j , and μ_j is defined as

$$\mu_B = \frac{A \cap B}{L_B}, L_B = |\sup(B) - \inf(B)| \quad (17)$$

Referring back to the above equation, the tuple $\langle t, i, f \rangle$ can be individually interpreted as

$$t_j = \mu_j; f_j = 1 - t_j [10]; i_j = e_H \quad (18)$$

Therefore, equation (16) can be rewritten as

$$i_j = C + t_j e^{f_j} + f_j e^{t_j}, C \in]0, 1+[\quad (19)$$

Fig. 6 shows plot of the evaluation of granular indeterminacy in terms of t and f . It takes its maximum value i_{max} when the overlapping in granulation is equal to 0.5 and then $t=f$. In other words, i_j depicts the indeterminacy produced by merging two granules A and B and how this (union) affects the granular neighbourhood. Moreover, the indeterminacy between two granules A and B is expressed by:

$$i_{A \cup B} = \frac{1}{d^2} \sum_{j=1}^d i_j, d = \text{number of dimensions} \quad (20)$$

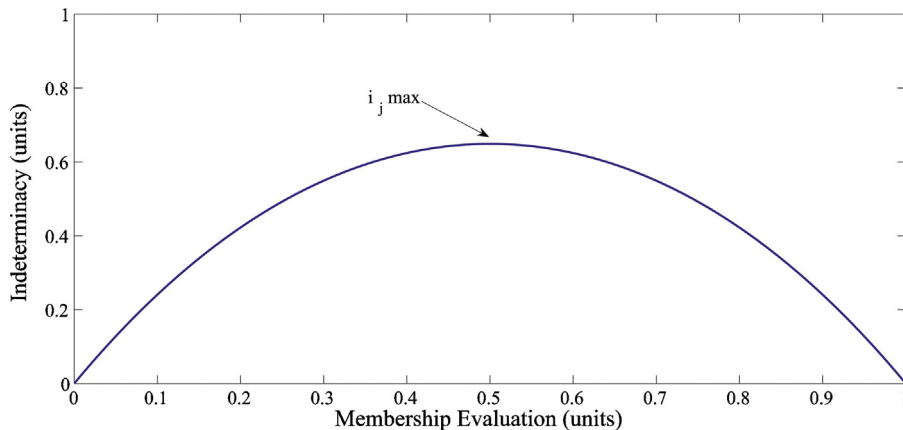

Fig. 6. Indeterminacy value.

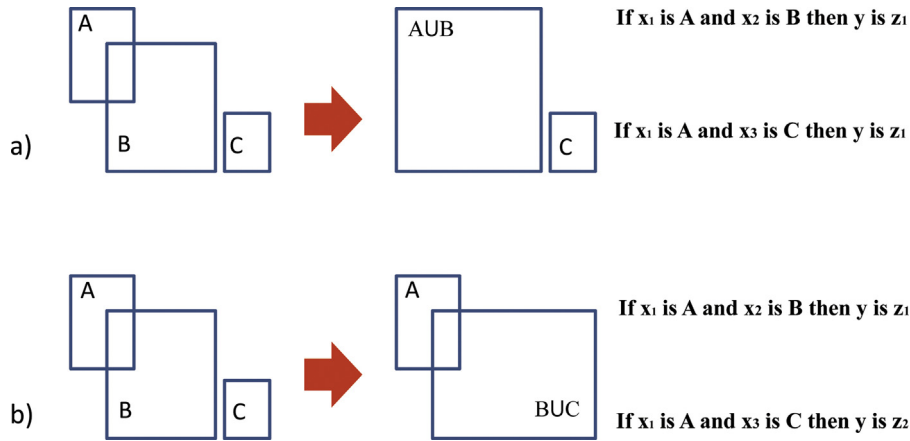

Fig. 7. A granulation step using a distance similarity measure and indeterminacy respectively.

Finally, the granular compatibility criterion, Equation (1), can be written as

$$C(A, B) = \text{Distance}_{\text{MAX}} - [i_{A \cup B} + \text{Distance}_{A, B} \times \exp(-\alpha \times R)] \quad (21)$$

The compatibility criterion, as described by Equation (21), will allow the merging of the most compatible granules while at the same time the granular uncertainty is taken into consideration. Equation (21) is a minimisation cost function; hence the granulation will follow the ‘path’ of the minimum uncertainty. The ‘disorder’ produced during the granulation process in terms of

uncertainty/indeterminacy could be evaluated by using the tuple $\langle t, i, f \rangle$ as a histogram of such components as follows:

$$Ni(t) = \frac{1}{d \times \text{card}} e^{-f(t)} \times i(t) \quad (22)$$

Where:

d : number of dimensions.

card : the resulting cardinality of the new merged granule.

t : iteration t

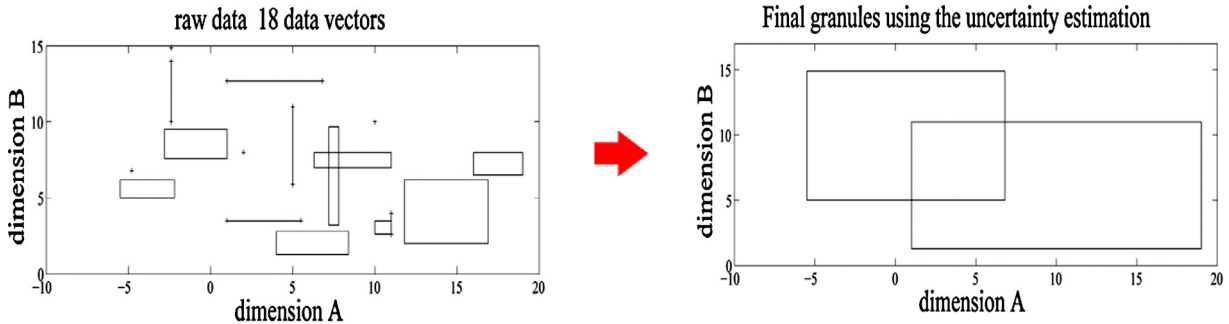

a) Granular Computing using a similarity measure based on distance

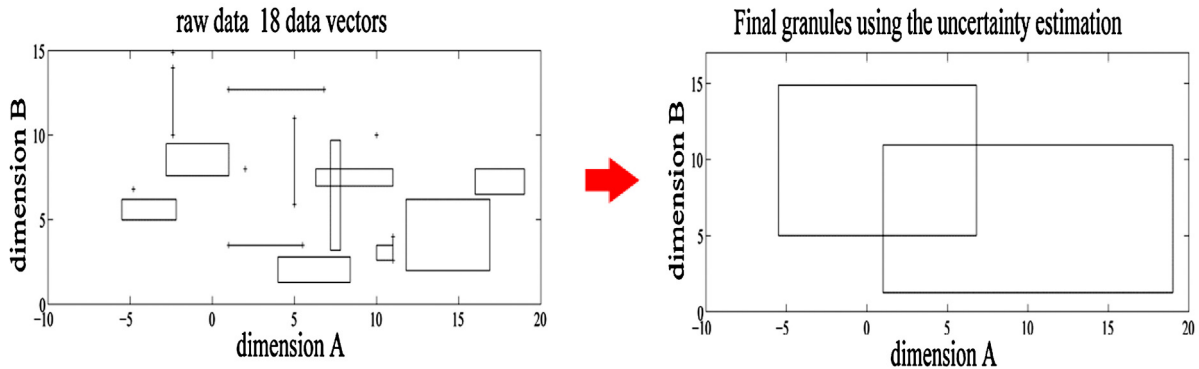

b) Granular Computing using the uncertainty estimation

Fig. 8. Sample granulation scenario.

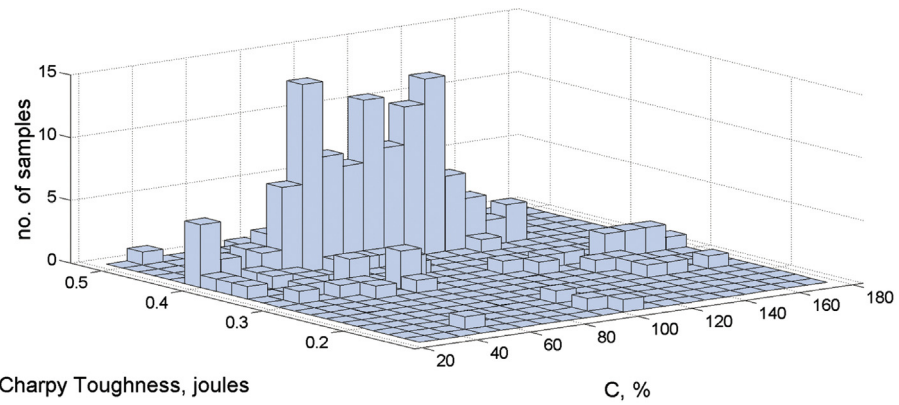

Charpy Toughness, joules

C, %

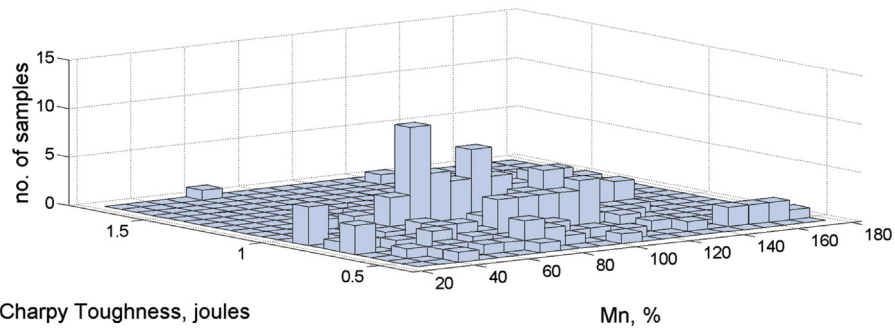

Charpy Toughness, joules

Mn, %

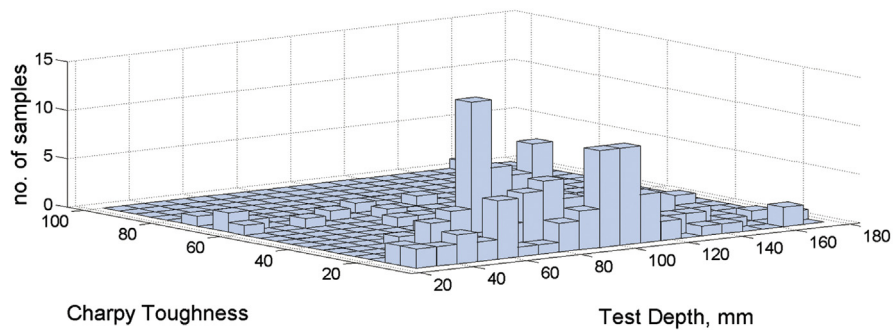

Charpy Toughness

Test Depth, mm

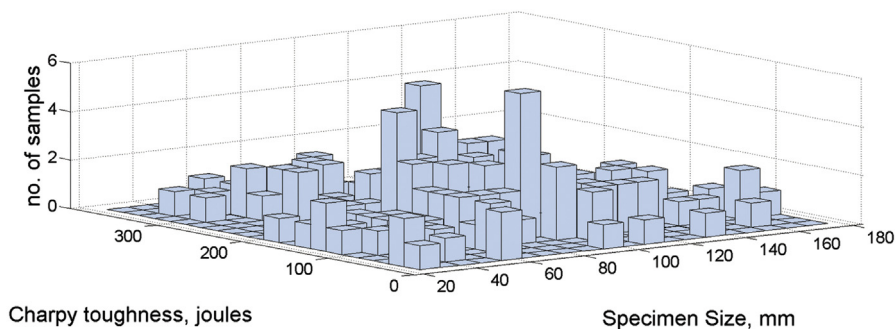

Charpy toughness, joules

Specimen Size, mm

Fig. 9. Sample of Charpy Toughness data space [6].

3.1. Uncertainty in the linguistic scenario and granular information 'coverage'

Taken in its broad sense, granulation iterative methodology described in [8] considers the proximity between any two entities and its cardinality and length as a compatibility measure. However,

there are some situations, in which such a density and distance measures do not produce the best orientation and distribution of the new merged granules. More specifically, this can represent a loss of transparency in the final linguistic rules, and their characterisation. For instance, in Fig. 7a the two final granules produce a misinterpretation of the consequence in the linguistic

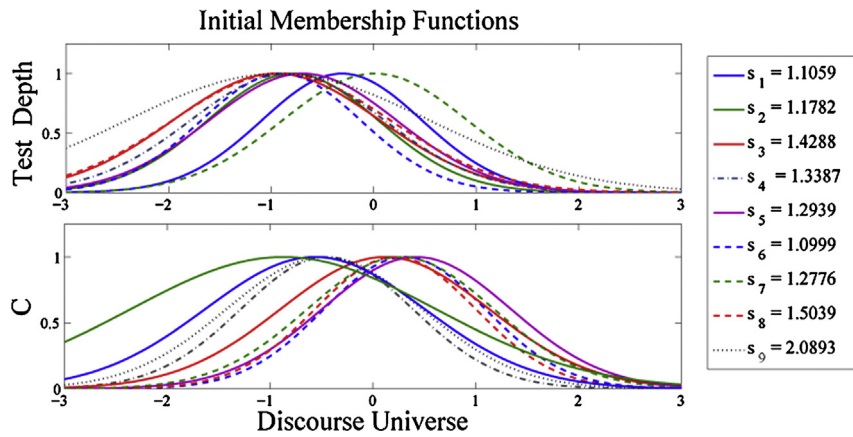

Fig. 10. Initial Membership functions by using Granular Compression.

scenario, and hence this composition bears a lack of a parsimonious modelling. The $A \cup B$ resulting granule covers an area (lower left of the granule) where raw data – information – simply does not exist despite following the compatibility objective function. One of the motivations to include the uncertainty under this merging process is to eliminate as much as possible this undesirable granulation behaviour, and promote a better granular coverage under a Neutrosophic scheme, where the granules are strongly linked with the raw data/information.

As a further example, Fig. 8 illustrates the final granules constructed after applying just the granulation process indicated in Equation (1), and those obtained with the expression shown in Equation (21). The resulting final granules in the second scenario include more granular information on overlapping; however the individual granules represent more accurately the underlying sub-granules/data.

4. Case study and simulation results

In this section, a case study is provided to evaluate the effectiveness of the proposed method for improving the interpretability of the input space partitioning while preserving the global accuracy. The example consists of a data set related to the impact energy tests (Charpy Toughness) of heat-treated C-Mn grade steel.

4.1. Impact energy

One of the most popular and standardized impact techniques is the Charpy test, which is a toughness measurement, and it is usually employed in the industry [33]. This technique is used to

Table 1 Charpy toughness: input variables.

Chemical composition	Test parameters	Heat treatment
C, Si, Mn, S, Cr, Mo, Ni, Al, V	Test depth, Specimen size Test site	Hardening temperature
	Test temperature	Cooling medium Tempering temperature

ascertain the fracture characteristics of materials; it is mainly used to estimate the impact energy (Joules) of a standard size/shape bar of square cross section during its fracture by another standard type of cantilever equipment.

The load is applied as an impact blow from a weighted pendulum hammer, which is released from a specific height. The specimen is placed on a base and suddenly hit by the pendulum that fractures it. Due to its low repeatability, high cost, and imprecise and scattered results obtained under the same input conditions this test turns out within a certain output space region but with high uncertainty and variability [33] inherited in the measurements.

The Charpy toughness data set used in this work consists of 1661 measurements on heat-treated steel [31] (TATA Steel, Yorkshire). The data set has 16 input dimensions, and 1 output (Impact Energy, Joules), the scarcity of some of the data dimensions is illustrated in Table 1.

For cross-validation purposes the data have been split into training, checking and testing, in order to avoid over-fitting the model enhancing its generalisation properties. The initial data used to train the GrC-NF model consists of 1084 (65%), which are composed

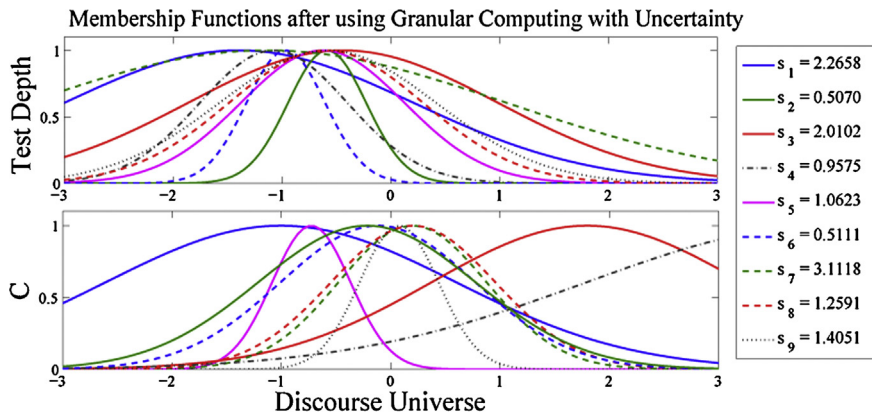

Fig. 11. Final Membership functions by using Granular Compression and Neutrosophy.

Table 2

RMSE performance of 3 similar NF structures using Fuzzy C-means and granular computing.

	Training	Checking	Testing
NF with Fuzzy C-means	18.78	20.18	21.78
GrC-NF [8]	14.66	21.24	20.42
Neutrosophic GrC-NF	16.10	18.3	19.34

of just raw data. The checking data and testing data are 277 (17%) and 300 (18%) respectively.

Unlike the methodology described in [8] the term $i_{A \cup B}$ is introduced to estimate the indeterminacy produced by the overlapping created in each dimension considering just intervals or simply the corresponding face of a granule. Once, the final compression is obtained this information is captured by the GrC-NF in order to train the RBF Neural-Fuzzy structure. In Table 2, it is shown a comparison of two previously obtained results via other granulation methods and those obtained with the proposed indeterminacy estimation. Even though, in [8] the training performance is better, the testing and checking simulation turned out more robust bearing an enhanced generalisation (testing) which is very significant for this type of industrial data.

As it was also suggested in [34], here a simulation with less than 6 or more than 18 granules is not considered due to the potential over-fitting behaviour or under-representation of the raw data occurs during the training stage. In this sense, an RMSE index to measure the performance during the training, checking and testing stage by using an initial partition space of 9 granules is suggested. Table 2 indicates a comparison between the granular computing with uncertainty and those mentioned in [8] and the results obtained by means Fuzzy C-means.

The initial membership functions obtained by just considering granular compression are shown in Fig. 9. There, the overlapping caused by the merging stage is significant and this produces a lack of sharpness in the distinction of rules. In this sense, we try to attenuate this indeterminacy by persuading the combination of granules under a low overlapping scheme. Moreover, we believe that a better understanding in granular uncertainty must be studied taken into account its compatibility features (Fig. 10).

The membership functions obtained by granular computing and uncertainty in Fig. 11 offer a better distinguishability as a result of identifying measuring the uncertainty produce during the granulation and how this value is used. However, this does not represent the best partition; since it is clear there are some input regions with a lack of good interpretability. Fig. 12, illustrates the measured-predicted fitness plots as obtained via the GrC-NF Neutrosophic approach. Table 2 demonstrates the performance of (a) a NF model created via a clustering framework based on the well-known Fuzzy C-Means algorithm [35,36] (b) A GrC-NF model which is based on the results obtained in [8], and (c) GrC-NF with the neutrosophic tuple $\langle t, i, f \rangle$. From the results shown in Table 2 one can notice the improved checking performance and most importantly the improved testing performance (generalisation). Finally, Figs. 13 and 14 show the Neutrosophic index evaluation and the RMSE progression during the optimisation procedure respectively. The 'path' followed by the Neutrosophic GrC-NF model is slower convergent however it reaches to a better performing final model, possibly by the inclusion of higher quality information granules (rules) which have less inherent uncertainty. The neutrosophic index evaluation plot shows that during the end-stage of the optimisation routine the resulting indeterminacy of the final granules (rules) is less on the case of the GrC-NF Neutrosophic model. In short, Fig. 13 represents the distribution order of the final granules in the partition space.

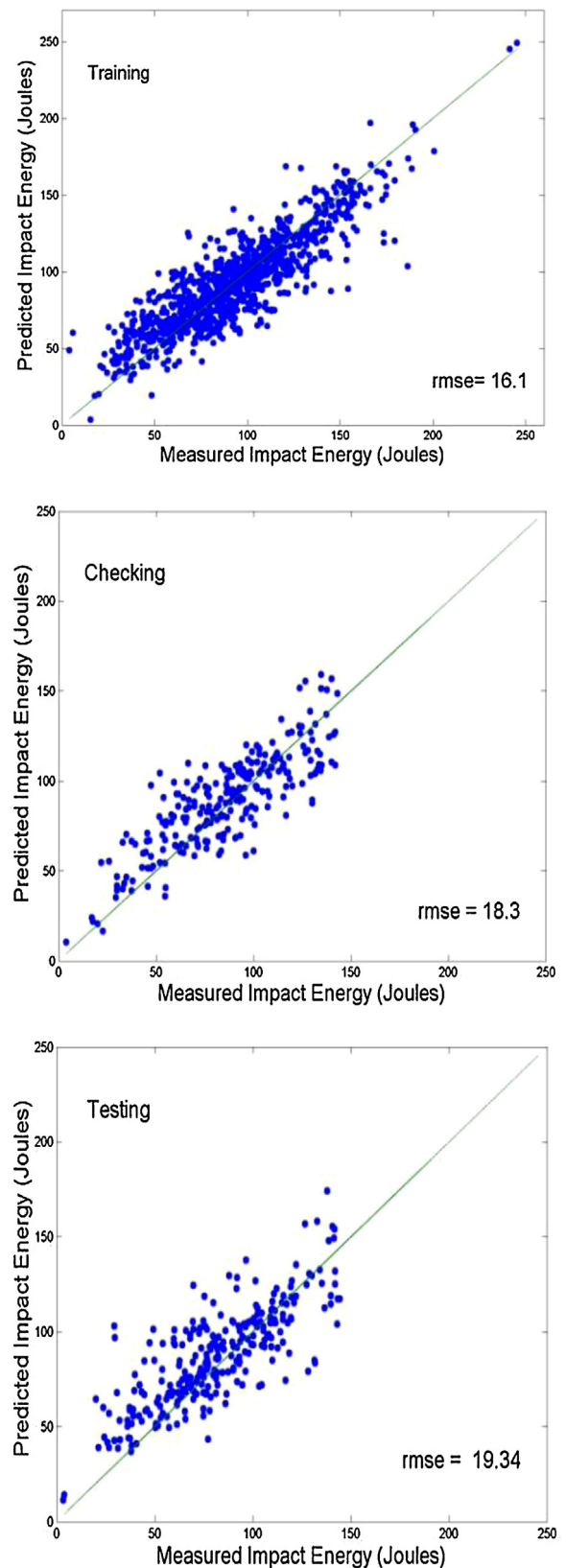

Fig. 12. Charpy Toughness model fit.

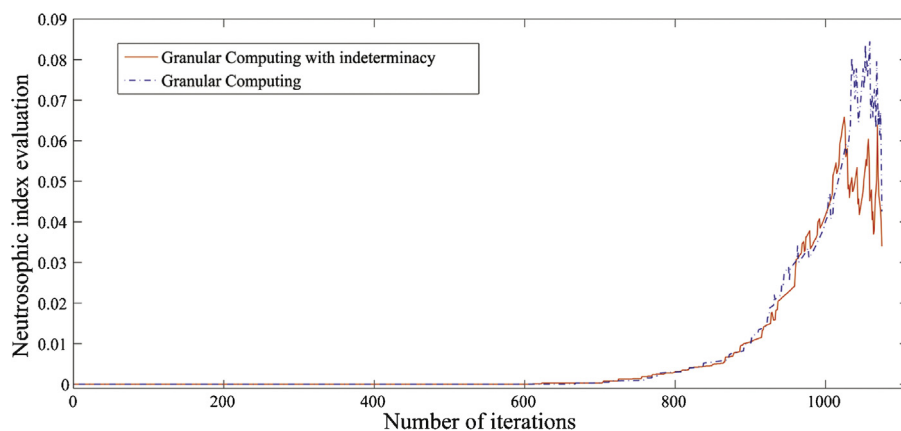

Fig. 13. Average Neutrosophic performance of overlap of granules.

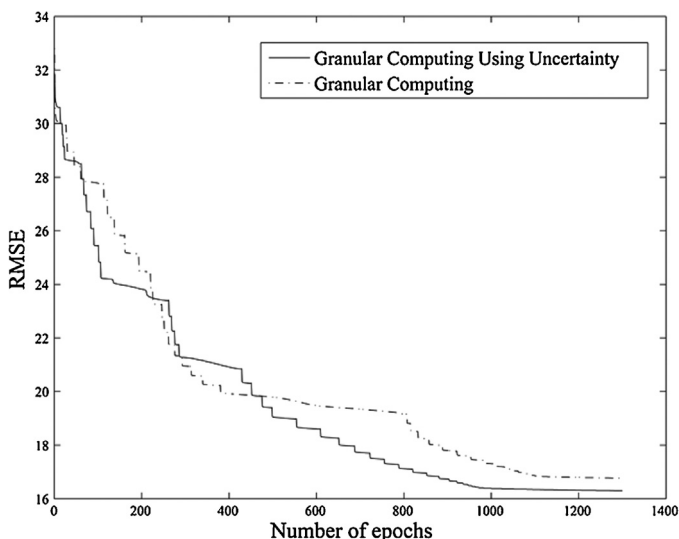

Fig. 14. Root mean square error performance using $\langle t, i, f \rangle$.

This index reflects the behaviour of the compatibility expression in terms of $\langle t, i, f \rangle$ and the final distribution of the resulting granules.

5. Conclusions

In this paper, a systematic modelling framework based on Granular Computing, Neural-Fuzzy modelling and Neutrosophic Logic is proposed. The presented approach mimics the human cognition in terms of grouping similar information (granules) together based on a number of similarity measures (in the computational case: proximity, cardinality, length). Furthermore, the proposed approach uses a Neutrosophic Logic concept to estimate inherent information uncertainty/indeterminacy due to the merging operation during the information granulation process. The uncertainty/indeterminacy index, calculated via a Shannon entropy criterion, is iteratively calculated during the granulation process and this results in a final GrC-NF inference system with a more robust rule-base with better representation of the raw data/information. This approach is applied to a real industrial dataset, based on the measurement of the Charpy Toughness of heat-treated steel, a process that is particularly known for the production of sparse and uncertain data. The proposed methodology is successfully applied to the industrial dataset and the results show an improved generalisation and model interpretability performance as compared with similar previous modelling attempts

based on the exact same dataset. However, further investigations need to be performed with different datasets and synthetic benchmarks to establish the overall performance of the proposed approach under different information granulation conditions. It would also be interesting to use this new framework presented in this paper and try to introduce different levels and measures of information uncertainty, for instance that uncertainty caused by conflict, congruency, discord, and ambiguity in terms of nonspecificity, particularly variety and diversity in the creation of granules.

Acknowledgements

The authors would like to thank TATA Steel, Yorkshire UK for their help and in providing the heat treatment data. The first author would like to also thank CONACYT, Mexico City, for the financial support for this project.

References

- [1] R. Paiva, A. Dourado, Interpretability and learning in neuro-fuzzy systems, *Science Direct* 147 (2003) 17–38.
- [2] L.A. Zadeh, in: M.M. Gupta, R.K. Ragade, R.R. Yager (Eds.), *Fuzzy Sets and information granularity*, *Advances in Fuzzy Set Theory and Applications*, 1979, pp. 3–18.
- [3] Y.Y. Yao, Granular Computing: Basic issues and possible solutions, in: *Proceedings of the Joint Conference on Information Sciences*, vol. 5, no. 1, 2000, pp. 186–189.
- [4] A. Bargiela, W. Pedrycz, *Granular Computing an Introduction*, Kluwer Academic Publishers, 2004.
- [5] W. Pedrycz, G. Vukovich, Granular neural networks, *Neurocomputing* 36 (2001) 205–224.
- [6] Y. Yao, A partition model of granular computing, *Lecture Notes in Computer Science* 3100 (2004) 232–253.
- [7] S.K. Pal, S.K. Meher, S. Dutta, Pattern classification using class-dependent rough-fuzzy granular space, *Lecture Notes in Computer Science* 6401 (2010) 54–61.
- [8] G. Panoutsos, M. Mahfouf, A neural-fuzzy framework based on Granular Computing: Concepts and applications, *Fuzzy Sets and Systems (Elsevier)* 161 (21) (2010) 2808–2830.
- [9] J. Tenner, *Optimisation of the Heat Treatment of Steel using Neural Networks*, in ACSE, The University of Sheffield, Sheffield, 1999.
- [10] M.-Y. Chen, D.A. Linkens, D.J. Howarth, J.H. Beynon, Fuzzy model-based Charpy impact toughness assessment for ship steels, *ISIJ International* 44 (6) (2004) 1108–1113.
- [11] Shang-Ming Zhou, John Q. Gan, Constructing accurate and parsimonious fuzzy models with distinguishable fuzzy sets based on an entropy measure, *Fuzzy Sets and Systems* 157 (2006) 1057–1074.
- [12] J.S. Roger Jang, C.T. Sun, Functional equivalence between radial basis function networks and fuzzy inference systems, *IEEE Transactions on Neural Networks* 4 (1) (1993) 156–159.
- [13] P. Liu, H.-X. Li, Efficient learning algorithms for three-layer regular feedforward fuzzy neural networks, *IEEE Transactions on Neural Networks* 15 (3) (2004) 545–558.
- [14] M.-Y. Chen, D. Linkens, A systematic Neural-Fuzzy modeling framework with application to material property prediction, *IEEE Transactions on Systems, Man and Cybernetics—Part B: Cybernetics* 31 (5) (2001) 781–790.

- [15] M.-Y. Chen, D. Linkens, A fast fuzzy modelling approach using clustering neural networks, *IEEE International Conference on Fuzzy Systems* 2 (1998) 1088–1093.
- [16] N.K. Kasabov, Q. Song, DENFIS: Dynamic evolving neural-fuzzy inference system and its application for time-series prediction, *IEEE Transactions on Fuzzy Systems* 10 (2) (2002) 144–154.
- [17] M.H. Fazel Zarandi, I.B. Türksen, J. Sobhani, A.A. Ramezani-pour, Fuzzy polynomial neural networks for approximation of the compressive strength of concrete, *Applied Soft Computing* 8 (1) (2008) 488–498.
- [18] S.-K. Oh, W. Pedrycz, T.-C. Ahn, Self-organizing neural networks with fuzzy polynomial neurons, *Applied Soft Computing* 2 (1) (2002) 1–10.
- [19] R.B. Bhatt, M. Gopal, On the structure and initial parameter identification of Gaussian RBF networks, *International Journal of Neural Networks* 14 (6) (2004) 373–380.
- [20] F. Smarandache, Definition of neutrosophic logic, A generalization of the intuitionistic fuzzy logic, in: *Proceeding of the Third Conference of the European Society for Fuzzy Logic and Technology, EUSFLAT*, 2003.
- [21] K.T. Atanassov, *Intuitionistic Fuzzy Sets*, Physica-Verlag, Heidelberg, NY, 1999.
- [22] C.E. Shannon, A mathematical theory of communication, *Bell System Technical Journal* 27 (1948) 379–423.
- [23] N.R. Pal, S.K. Pal, Object-Background segmentation using new definitions of entropy, *Computers and Digital Techniques, IEEE* 136 (4) (1989) 284–295.
- [24] P. Kraipeerapun, C.C. Fun, W. Brown, K.W. Wong, Mineral prospectivity prediction using interval neutrosophic sets, in: V. Devedzic (Ed.), *Artificial Intelligence and Applications*, IASTED/ACTA Press, 2006, pp. 235–239.
- [25] T. Moody, C.J. Darken, Fast learning in networks of locally-tuned processing units, in: *Neural Computation*, MIT Press, 1989.
- [26] F. Smarandache, *A Unifying Field in Logics: Neutrosophic Logic. Neutrosophy, Neutrosophic Set, Neutrosophic Probability and Statistics*, American Research Press, 1998.
- [27] F. Smarandache, *Interval Neutrosophic Sets and Logic: Theory and Applications in Computing*, Hexis, Neutrosophic Book Series, 5, 2005.
- [28] G.J. Klir, M.J. Wierman, *Uncertainty-Based Information: Elements of Generalized Information Theory*, Physica Verlag, Heidelberg, 1999, p. 15.
- [29] G. Panoutsos, Mahdi Mafouf, Modelling Steel heat treatment using granular compression and multiple granularity modelling, *International Journal in Granular Computing, Rough Sets and Intelligent Systems* 1 (4) (2010) 382–392.
- [30] A. Deluca, S. Termini, Entropy of L-fuzzy sets, *Inform and Control* 2 (1974) 55–73.
- [31] L. Xuecheng, Entropy, distance measure and similarity measure of fuzzy sets and their relations, *Fuzzy Sets and Systems (Elsevier)* 52 (3) (1990) 305–318.
- [32] N.R. Pal, J.C. Bezdek, Measuring Fuzzy uncertainty, *IEEE* 2 (2) (1984) 107–118.
- [33] W.D.J. Callister, *Materials Science and Engineering an Introduction*, sixth ed., John Wiley & Sons, Inc, 2003.
- [34] G. Panoutsos, M. Mahfouf, Modelling imprecise and scattered multidimensional data using granular data compression and multiple granularity modelling, *IEEE International Conference on Granular Computing* (2008) 512–517.
- [35] J.C. Bezdek, *Pattern Recognition with Fuzzy Objective Function Algorithms*, Plenum Press, New York, 1981.
- [36] J.C. Bezdek, *Fuzzy Models for Pattern Recognition*, IEEE Press, 1992.