

Dezert- Smarandache Theory based Classification of EMG Signals

Preeti Meena¹ Malti Bansal²

Department of ECE, Delhi Technological University, Delhi, India^{1,2}

Abstract: This research paper proposes an intellectual method for the classification of different types of Electromyography (EMG) signals like normal, myopathy and neuropathy signals. Inside the human body, contraction of muscles and nerves occur at every second. And, EMG is a technique used to measure this electrical activity. For the analysis of EMG signals, so many methods have been already used. With this research, a new method is proposed in which Dezert-Smarandache Theory (DSmT) based classification technique is utilized for the EMG signals analysis. In this, discrete wavelet transform with some features like energy, mean and standard deviation are exploited for the features extraction of the EMG signals. After that, classifiers are used in the analysis for the modelling purpose. Then, using these classifiers, DSmT based technique helps in improving the accuracy of the results. It can be seen in the results that DSmT based classification gives the best accuracy (approximately 97%) in comparison to the other classifiers used during this research.

Keyword: DSmT, Electromyography, Wavelet Transform, SVM, SVM-kNN.

I. INTRODUCTION

For the analysis of Electromyography (EMG), it should be a well-known fact that muscles and nerves exist in the human body and contraction of these two may cause pain in the body. EMG is utilized to record these changes in the form of a graph occurred due to contraction of muscles. Early diagnosis is required for dealing with such diseases. Classification of EMG signals is a vital exploration. A systematized study on their classification is required for the proper analysis of the diseases. Hence, a number of methods, most of them were computer based, have been proposed. Amongst these EMG analysis algorithms, features of the EMG were extracted using the techniques like Discrete wavelet transform (Daubechies-6) [2], AR modelling [3], autoregressive cepstral analysis [4], PSO [5], wavelet packet energy [6] etc. With these feature extraction techniques, training of different classifiers are done for their modeling.

Classifiers already utilized in the classification of EMG signals are as follows: Fuzzy [6], Artificial neural networks (ANN) [7], Fuzzy-genetic [8], Neuro-fuzzy [9], Deep fuzzy neural network [2], SVM [10], SVM-kNN [1] etc. Using these methods of features extraction and classifiers for classification, good results were obtained in the EMG classification. Nevertheless, performance of these results can be enhanced using a technique called as Dezert-Smarandache Theory (DSmT) [14] for the much better accuracy in terms of results.

In the research paper, a new method for the classification of EMG signals is proposed. The brief outline for the method is represented in the block diagram in Fig.1. From the block diagram, it is seen that firstly, EMG signals are taken as the dataset. Then wavelet transform for these signals are computed as Detail coefficients. For the D_4 coefficient only, features like energy, mean and standard

deviation are found out. Later, classification of these signals is performed based on the calculated feature values.

This research paper is organized in different sections which are as follows: Section II gives an overview for the method proposed as a block diagram. Section III gives a detailed view of the dataset used and explanations for the methods and classifiers used. Section IV provides the idea about the overall simulation technique explained using the block diagram for the proposed method. Section V comprises of the classification results trailed by conclusion in Section VI.

II. BLOCK DIAGRAM

The brief outline for the method is represented in the block diagram in Fig.1. In this, a novel method is proposed for the classification of EMG signals.

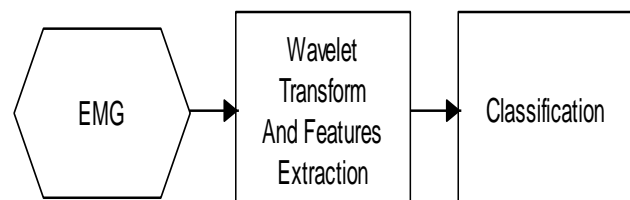

FIG.1.EMG SIGNALS CLASSIFICATION

From the block diagram, it is seen that firstly, EMG signals are taken as the dataset. Then wavelet transform for these signals are computed as Detail coefficients. For the D_4 coefficient only, features like energy, mean and standard deviation are found out. Later, classification of these signals is performed based on the calculated feature values.

III. PROPOSED METHOD

A. Data Set Used

MIT-BIH database is used to load the Data set of EMG signals. A description of the data set is shown in the Table I.

TABLE I
DESCRIPTION OF DATASET USED

EMG Signals	Total
Normal	500
Myopathy	500
Neuropathy	500

From the sample of dataset used, waveforms of three types of EMG signals are taken and shown in the Fig. 2. These waveforms represent the normal, myopathy and neuropathy signals.

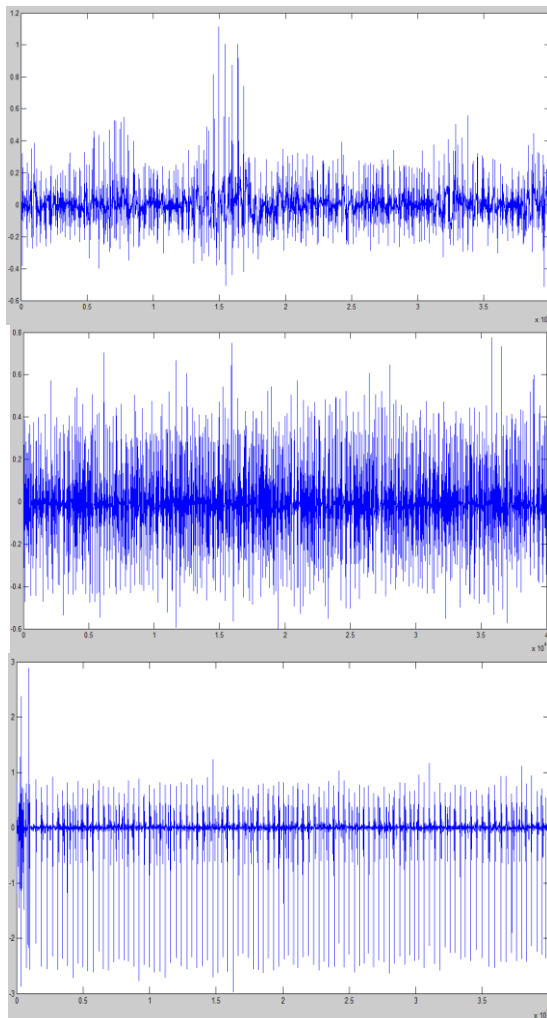

FIG.2. EMG SIGNALS – NORMAL, MYOPATHY AND NEUROPATHY

B. Wavelet Transform

Wavelet transform is the simultaneous representation of the signal in real-time and frequency domain [10]. Hence, it can give time and frequency information of the signal at the same point of time. Hence, the wavelet transform can be defined as:

$$T(m, n) = \int_{-\infty}^{\infty} x(\tau) \frac{1}{\sqrt{m}} \psi\left(\frac{\tau - n}{m}\right) d\tau \quad (1)$$

Here, ψ represents the transforming function known as the mother wavelet function. It can be observed from the equation that the transformation is a function of the variables, m and n , where m is the translation parameter and n is the scale parameter.

For such transformation, signal is distributed from various high-pass $h[p]$ and low-pass $l[p]$ filters. For the proper decomposition of the signal, process is made repetitive for the either $h[p]$ output or $l[p]$ output or for both of the outputs. Such decomposition's first level establishes one level of decomposition and it can be given as:

$$y_{hi}(r) = \sum_p x(p) \cdot h(2r - p) \quad (2)$$

$$y_{lo}(r) = \sum_p x(p) \cdot l(2r - p) \quad (3)$$

Here, $y_{hi}[r]$ is the output from the high-pass filter and $y_{lo}[r]$ is the output from the low-pass filter after sub-sampling by 2. It is shown in the Fig.3.

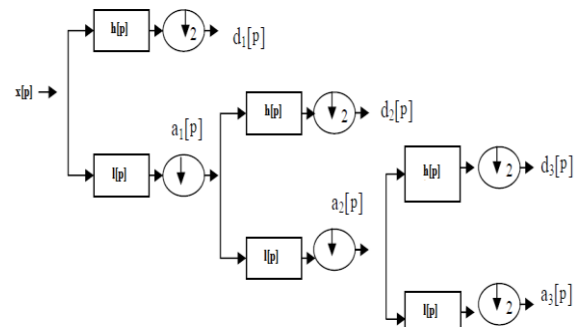

FIG. 3. SUB-BAND DECOMPOSITION OF DWT IMPLEMENTATION;

$H[p]$ IS THE HIGH PASS FILTER, $L[p]$ THE LOW PASS FILTER.

In the Fig.3 shown is the Sub-band decomposition of DWT in which $x[p]$ is the original signal that needs to be decomposed, $l[p]$ and $h[p]$ are low-pass and high-pass filters, respectively. This decomposition of the $x[p]$ will result in the detail and the approximation coefficients. The approximation or the detail coefficients may further be decomposed by sub-level of decomposition as shown in the process Fig.4.

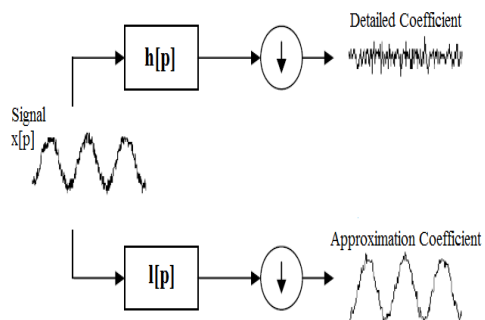

FIG. 4. EMG SIGNAL AND ITS WAVELET DECOMPOSITION INTO APPROXIMATION AND DETAILED COEFFICIENTS.

For the EMG signal, Coiflet 5 (coif5) wavelet transform is utilized to compute the approximation and detail coefficients. These wavelet coefficients computed gives the EMG signal's representation in time and frequency domain simultaneously.

Now, from the computed detail coefficients of the EMG signals, the coefficient which highly in resemblance with its original signal is selected. From the results, it will be shown that this coefficient is the D_4 coefficient. And in the Fig. 5, it can be observed that D_4 coefficient resembles its original signal.

C. Features Extraction

Now, features are extracted for the EMG signals. As from the wavelet transform of the EMG signal, D_4 coefficient is already computed and it contains the maximum information of the original signal. Hence, D_4 coefficient is utilized to extract the features for the EMG signals and that are energy, mean and standard deviation [13]. These feature are briefly discussed:

(a) Mean of the absolute values of the D_4 coefficient in each sub-band.

$$Mean = \frac{\sum_q y_q}{q} = \mu \tag{4}$$

(b) Energy of the wavelet coefficient 4 in each sub-band. Energy of the sub-signal $y_q(\tau)$ is calculated by

$$Energy = \sum_q \sum_k |D_k^q|^2 \tag{5}$$

(c) Standard deviation of the D_4 coefficient in each sub-band of the signal.

$$Standard_Deviation = \sqrt{\frac{\sum_q (y_q - \mu)^2}{q}} \tag{6}$$

The features extracted as energy, mean and standard deviation are now exploited to train and test on the classifiers.

D. SVM

Now, the Classifiers are used which are trained using the computed features. In the previous sub-section that coiflet wavelet transform's D_4 coefficient of the EMG signals and features like energy, mean and standard deviation were collected. Here, the SVM model is trained using these features and then the same trained model is utilized to test for the classification of the EMG signals. Support Vector Machine is a classifier in which supervised learning technique is used which includes training is provided to the model and then samples are tested on that model. This technique provides much efficient results compared to the unsupervised learning based classifiers. This classifier is modest and informal to recognize. This is because it builds a hyperplane between the different classes which need to be classified using the classifier. In this, after

plotting the samples in a space, a hyperplane is drawn according to the condition that margin between the support vectors and the hyperplane need to be maximized. It can be seen in [10]. For this, the classifier used may be linear or non-linear. Samples which are able to classify only using a straight line are the linearly separable or linear SVM. But in practical situations, it is very difficult for a straight line hyperplane to classify each and every sample. For such cases, non-linear classifier is used. In this, a non-linear operator maps the inputs to the classifier into a higher dimensional space so that samples can be classified easily. If a linear function is given by the equation

$$h(y) = cy + d \tag{7}$$

Then its dimensionality can be increased by using the equation as

$$h(y) = c.\psi(y) + d \tag{8}$$

In (8), kernel function is used to raise the dimensionality of the mapping. If the samples are not distinguishable in lower dimensional space, then kernel functions are used. Though, the classification using SVM faces some complications in the complex applications which lowers its classification accuracy. It is also difficult to choose the kernel function parameters. So, for better classification results, SVM-kNN is used.

E. SVM-kNN

SVM-kNN is a hybrid classifier. It is the hybrid of Support Vector Machine and k-Nearest Neighbour classifiers. In the previous section studies, it was observed that SVM is a 1NN classifier [10] because SVM utilizes only a single representative point for each class according to the nearest neighbour approach. Nevertheless in the combination of the SVM and kNN, more than one vector points are preferred from the sample points. Say k-points are chosen and hence, the class is decided for the tested samples.

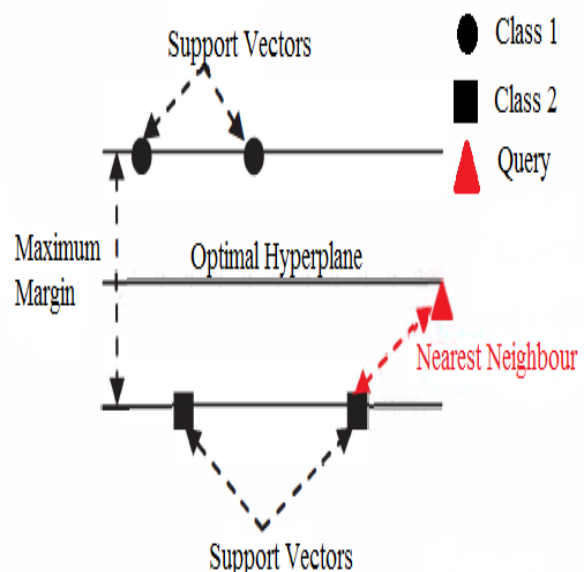

FIG.5. SVM-kNN CLASSIFICATION

In the Fig.5 it can be observed that this hybrid algorithm of SVM-KNN considers more than one support vectors as the representative vector points for a class. This is a much better classifier than the SVM as in that only sample point that is present nearest to the hyperplane represents the support vector. In SVM-kNN, all support vectors are considered as representative vector points for the class and hence, maximum of information of a class is utilized in the classification process. During this model approach of the signals, nearest neighbour (that is, support vector) is computed as the query point using k-nearest neighbour algorithm. In the next sub-section, DSMT is explained.

F. DSMT

For the classification purpose, more than two classes classification problem is formulated as a m-class problem in which classes are associated to pattern classes such as $\psi_0, \psi_2, \psi_3, \dots, \psi_m$. In this, parallel combination of two classifiers, which will be treated as the information sources, are formulated through Dezert-Smarandache Theory (DSMT) using the PCR6 combination rule.

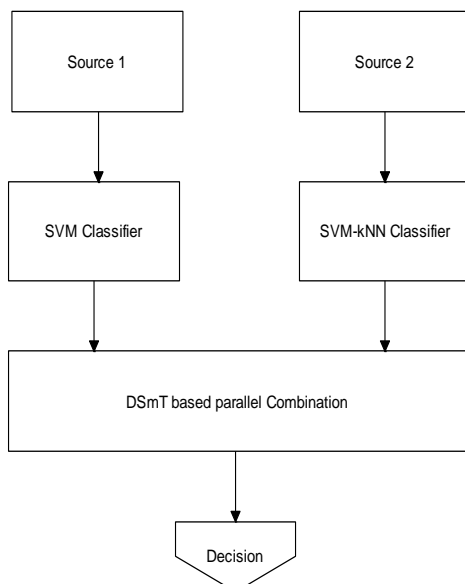

FIG.6. STRUCTURE OF THE COMBINATION SCHEME USING DSMT

DSMT is a fusion process of which allows to combine independent sources of information which are formulated as the belief functions. It is able to solve complex and multi-class problems with efficient results.

IV. EXPERIMENTAL VIEW

EMG Dataset: MIT-BIH Database is loaded as the Data set of EMG signals. It is shown in the table shown in Table II.

TABLE II
DESCRIPTION OF DATASET USED

EMG Signals	Training	Testing	Total
Normal	350	150	500
Myopathy	350	150	500
Neuropathy	350	150	500

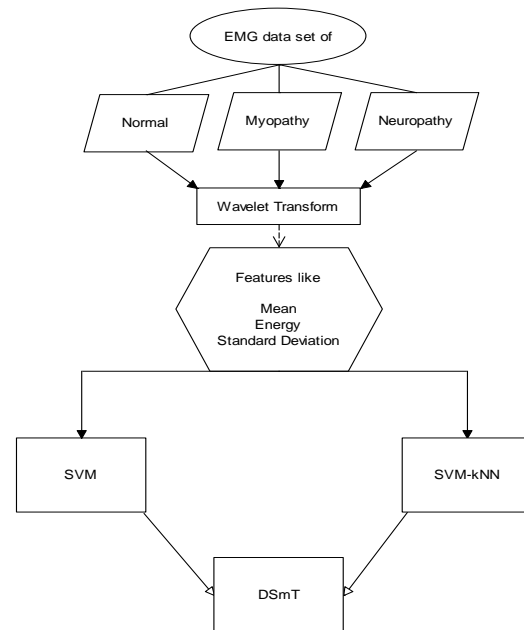

FIG.7. BLOCK DIAGRAM OF EMG SIGNALS CLASSIFICATION

Computing the wavelet transform and their features: Discrete wavelet transform (DWT) of the EMG signals are computed using the coiflet wavelet transform of the order of 5. Then, Features such as Energy, Mean and Standard Deviation for the D_4 coefficient are computed for each and every sample of data set of the different types of EMG signals used during the research. These calculated features in the form of energy, mean and standard deviation serve as an input to train and test the various classifiers.

Classification: During the classification, computed features of the EMG signals in the second stage are exploited by the classifiers like SVM, SVM-kNN and DSMT to determine the corresponding class of the samples. This feature set consists of mean, energy and standard deviation of the D_4 coefficient of the coiflet wavelet transform that should efficiently characterize the variations in the input signals for accurate detection and classification of the EMG signals. The calculated features will be applied to the classifiers like SVM, SVM-kNN and DSMT classifiers as training and testing data to classify the EMG signals in their corresponding classes.

V. RESULTS

In this study, SVM, SVM-kNN and DSMT classifiers are used for the classification of the different types of EMG (Normal, Myopathy and Neuropathy) signals. As the features required to train the classifiers, D_4 coefficient of the coiflet wavelet transform is used. Then, as the features, energy, mean and standard deviation is used.

Now, data set utilized for this research is shown in the Table II. Firstly, on this data set of the EMG signals, wavelet transform is applied. Coiflet family of order 5 is used in the wavelet transform. The results for the wavelet transform of each type of data set used is represented in the figures 8, 9 and 10.

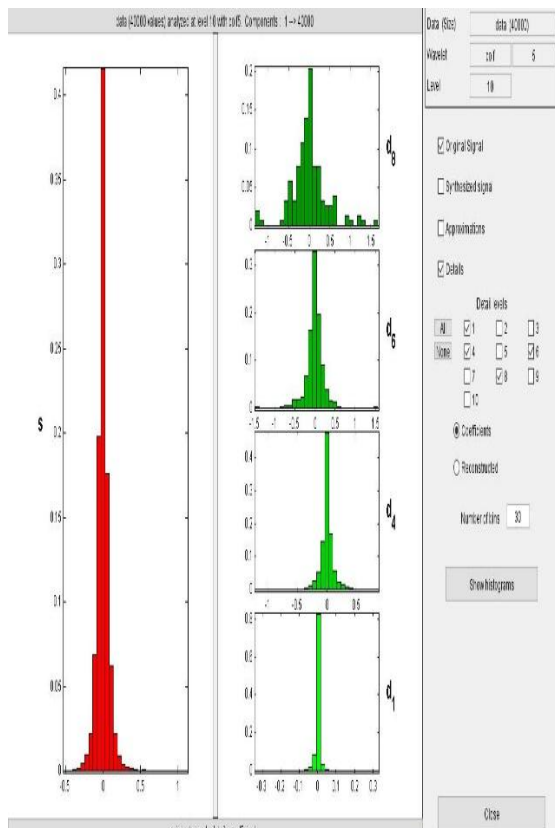

FIG.8. HISTOGRAM OF WAVELET TRANSFORM OF NORMAL PERSON EMG

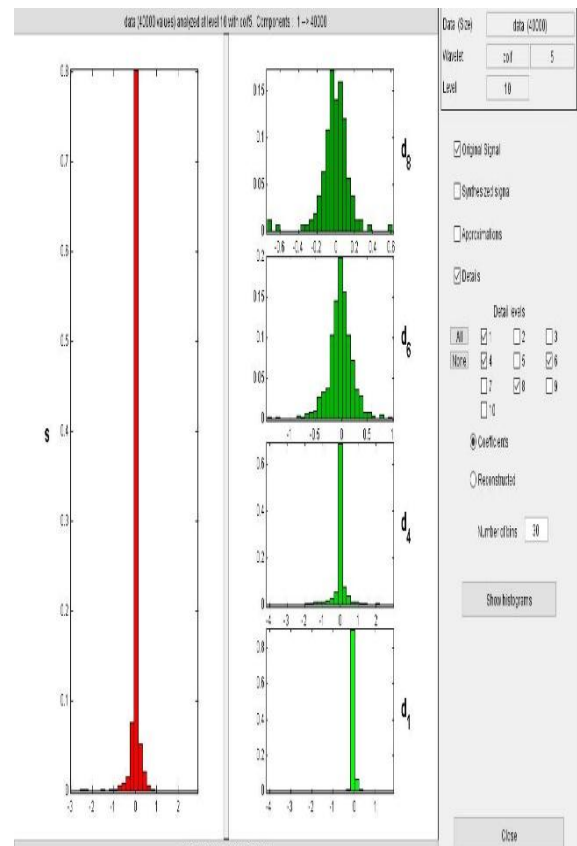

FIG 10. HISTOGRAM OF WAVELET TRANSFORM OF MYOPATHY PERSON EMG

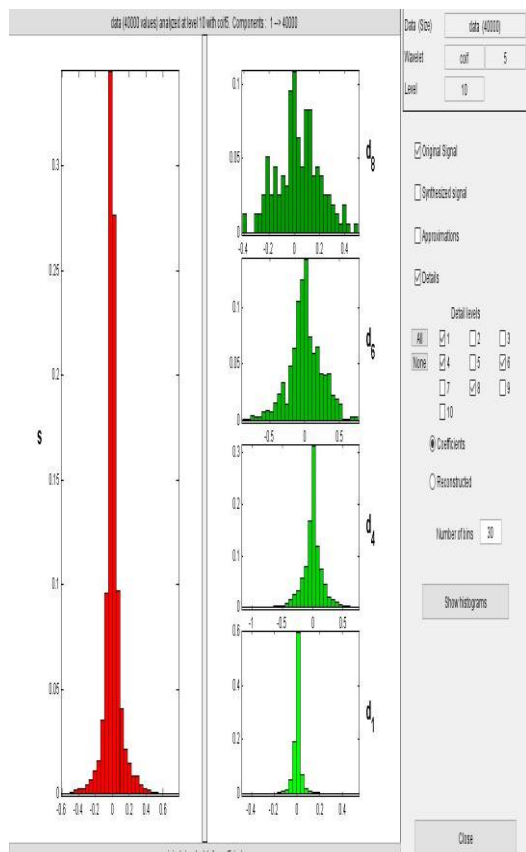

FIG.9. HISTOGRAM OF WAVELET TRANSFORM OF MYOPATHY PERSON EMG

In these figures, wavelet transform of the EMG signals is represented in the form of histograms. And it can be seen from the figures that histogram of D_4 coefficient greatly resembles its original signal's histogram. This implies D_4 coefficient is sufficient to give the maximum features alone. Therefore, energy, mean and standard deviation is computed for D_4 coefficient only. Sample values for these features are shown in the Table III.

TABLE III
SAMPLE VALUES OF FEATURES FOR EMG SIGNALS

EMG Signal	Mean	Energy	Standard Deviation
Normal	6.85	46.55	2.173
Myopathy	4.97	24.49	0.574
Neuropathy	8.85	75.35	5.546

Table III shows the sample values for the EMG signals as the features computed (like energy, mean and standard deviation) for the D_4 coefficients of the coiflet of order 5. These features are computed for each and every sample of data set for the three types of EMG signals exploited. Hence, from these EMG features computed, features of 1050 samples (Normal-350, Myopathy-350 and Neuropathy-350) are chosen from each class and utilized to train the SVM. After that, remaining 450 samples (Normal-150, Myopathy-150 and Neuropathy-150) are tested on the same trained SVM. Its classification results are shown in the Table IV in the form of a confusion matrix.

TABLE IV
CONFUSION MATRIX OF SVM CLASSIFICATION

Targets → Outputs ↓	Normal	Myopathy	Neuropathy	Accuracy
Normal	141/150	3/150	6/150	94%
Myopathy	11/150	134/150	5/150	89.33%
Neuropathy	7/150	4/150	139/150	92.67%

The confusion matrix shown in the Table IV shows a good result in terms of classifying the EMG signals into their respective classes. SVM gives 92% of accuracy in classifying these signals. This is quite good but SVM-kNN is utilized further to increase this percent of accuracy in classification of EMG signals.

Next, SVM-kNN classifier is used for the EMG signals classification. In this also, features of 1050 samples (Normal-350, Myopathy-350 and Neuropathy-350) are utilized to train the SVM-kNN. Then, the remaining samples are used to test on the same trained SVM-kNN.

TABLE V
CONFUSION MATRIX OF SVM-kNN CLASSIFICATION

Targets → Outputs ↓	Normal	Myopathy	Neuropathy	Accuracy
Normal	147/150	2/150	1/150	98%
Myopathy	8/150	137/150	5/150	91.33%
Neuropathy	3/150	5/150	142/150	94.67%

And, this can be observed from the Table V that increase in the accuracy of classification is observed. Table V shows the confusion matrix of SVM-kNN classification and from this classifier an accuracy of approximately 95% is observed.

However, these results are improved using a technique known as DSMT technique. This technique utilizes features of both the classifiers used i.e. SVM and SVM-kNN. And, raise the accuracy of classifying the EMG signals.

TABLE VI
CONFUSION MATRIX OF DSMT BASED CLASSIFICATION

Targets → Outputs ↓	Normal	Myopathy	Neuropathy	Accuracy
Normal	148/150	2/150	0/150	98.67%
Myopathy	3/150	144/150	4/150	96%
Neuropathy	2/150	3/150	146/150	97.33%

Here also, it can be clearly seen in the confusion matrix shown in the Table VI that an accuracy of 97.33% is reached using the DSMT in this classification compared to the other classifiers results.

VI. CONCLUSION

It can be concluded from the research that the method presented is a novel and very efficient method for the classification of the three different types of EMG signals (i.e. Normal, Myopathy and Neuropathy) using the DSMT based classifier. In this method, the extraction of

features like energy, mean and standard deviation is done for the coiflet family of wavelet transform of the order of 5 for the EMG signals. Results achieved from the classification shows an alternative approach, which when compared to the other methods, for extracting relevant features and classification for EMG signals shows results with higher accuracy.

Classification results with accuracy of 97.33% with only a small number of features is only possible because of the use of DSMT based technique. Therefore, now, it can be concluded that the costly tests of diagnosing the EMG diseases can be switched by this automatic technique of classifying EMG signals.

REFERENCES

1. Preeti Meena, Malti Bansal, "Classification of EMG Signals using SVM-kNN", Int Journal of Advanced Research in Electronics and Communication Engineering", vol. 5, issue 6, pp. 1718-1724, 2016.
2. Subasi, A., "Classification of EMG signals using combined features and soft computing techniques," Applied Soft Computing, vol. 12, pp 2188-2198, 2012.
3. Kaur, G. Shatru-Aurora, A., Kumar-Jain, Vijendra., "EMG Diagnosis via AR Modeling and Binary Support Vector Machine Classification," Int Journal Of Eng. Science and Tech., vol. 2, pp. 1767-1772. 2010
4. C.S. Pattichis, A.G. Elia, Autoregressive cepstral analyses of motor unit action potentials, Medical Engineering & Physics 21 (1999) 405-419.
5. Subasi, A., "Classification of EMG signals using PSO optimized SVM for diagnosis of neuromuscular disorders," Computers in Biology and Medicine, vol. 43, pp 576-586, 2013.
6. Khushaba RN, Al-Jumaily A, Al-Ani, "A. Novel feature extraction method based on fuzzy entropy and wavelet packet transform for myoelectric Control," 2007 IntSympCommunInf Technol., pp. 352- 357, 2007.
7. Y. Becerikli, On three intelligent systems: dynamic neural, fuzzy and wavelet networks for training trajectory, Neural Computing & Applications 13 (4) (2004) 339-351.
8. C.A. Pena-Reyes, M. Siper, A fuzzy-genetic approach to breast cancer diagnosis, Artificial Intelligence in Medicine 17 (1999) 131-155.
9. S.E. Hussein, M.H. Granat, Intention detection using a neuro-fuzzy EMG classifier, IEEE Engineering in Medicine and Biology November/December (2002) 123-129.
10. Subasi, A., "Classification of EMG signals using PSO optimized SVM for diagnosis of neuromuscular disorders," Computers in Biology and Medicine, vol. 43, pp 576-586, 2013.
11. C. Parameswariah, S. Member, M. Cox, and S. Member, "Frequency Characteristics of Wavelets," vol. 17, no. 3, pp. 800-804, 2002
12. Sepulveda-Cano LM, Acosta-Medina CD, Castellanos-Dominguez G "Relevance Analysis of Stochastic Biosignals for Identification of Pathologies," 2011 EURASIP J. Adv. Sig. Proc. 2011.
13. Phinyomark, a. Quaine, F., Charbonnier, S., Serviere, C., Tarpin-Bernard, F., Laurillau, Y., "EMG feature evaluation for improving myoelectric pattern recognition robustness", Expert systems with applications, vol. 40, pp. 4832-4840, 2013.
14. Nassim Abbas et. al., "The effective use of the DSMT for multi-class classification", Proceedings of the 5th International Symposium on Signal Processing, 2012.