

Vol. 11, 2016

Neutrosophic Sets and Systems

An International Journal in Information Science
and Engineering

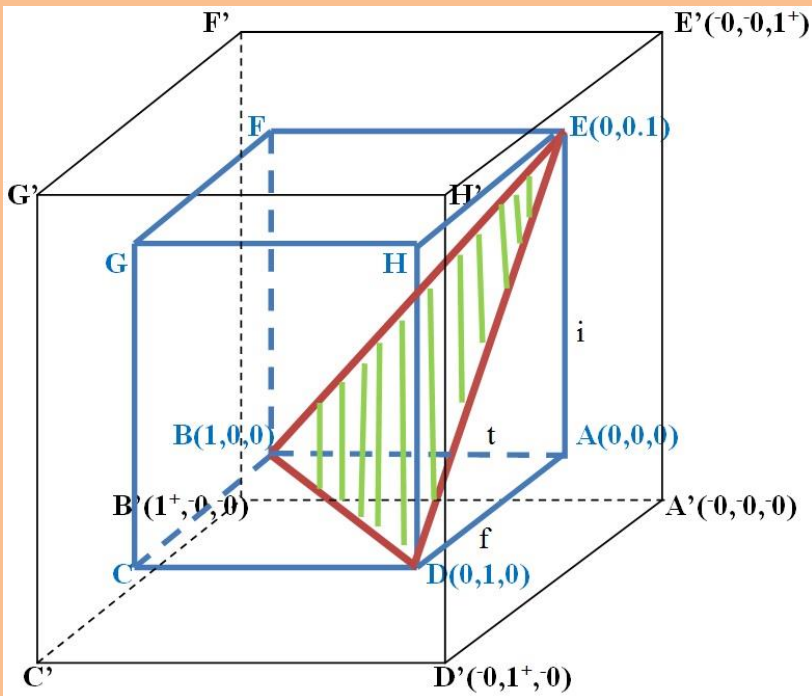

ISSN 2331-6055 (print)

ISSN 2331-608X (online)

Neutrosophic Sets and Systems

An International Journal in Information Science and Engineering

Quarterly

Editor-in-Chief:

Prof. Florentin Smarandache

Address:

Department of Mathematics and Science
University of New Mexico
705 Gurley Avenue
Gallup, NM 87301, USA
E-mail: smarand@unm.edu
Home page: <http://fs.gallup.unm.edu/NSS>

Associate Editor-in-Chief:

Mumtaz Ali

Address:

Department of Mathematics, Quaid-eazam
University Islamabad, Pakistan.

Associate Editors:

W. B. Vasantha Kandasamy, IIT, Chennai, Tamil Nadu, India.
Said Broumi, Univ. of Hassan II Mohammedia, Casablanca, Morocco.
A. A. Salama, Faculty of Science, Port Said University, Egypt.
Yanhui Guo, School of Science, St. Thomas University, Miami, USA.
Francisco Gallego Lupiañez, Universidad Complutense, Madrid, Spain.
Peide Liu, Shandong University of Finance and Economics, China.
Dmitri Rabounski and Larissa Borissova, independent researchers.
A. A. Agboola, Federal University of Agriculture, Abeokuta, Nigeria.
S. A. Albolwi, King Abdulaziz Univ., Jeddah, Saudi Arabia.
Luige Vladareanu, Romanian Academy, Bucharest, Romania.
Jun Ye, Shaoxing University, China.
Ştefan Vlăduţescu, University of Craiova, Romania.
Valeri Kroumov, Okayama University of Science, Japan.
Surapati Pramanik, Nandalal Ghosh B.T. College, India.
Panpur, PO-Narayanpur, West Bengal, India.
Irfan Deli, Kilis 7 Aralık University, 79000 Kilis, Turkey.
Rıdvan Şahin, Ataturk University, Erzurum, 25240, Turkey.
Le Hoang Son, VNU Univ. of Science, Vietnam National Univ., Hanoi, Vietnam.
Luu Quoc Dat, Univ. of Economics and Business, Vietnam National Univ., Hanoi, Vietnam.
Mohamed Abdel-Baset, Zagazig University, Sharqiyah, Egypt.

Volume 11

Contents

2016

N. Radwan, M. Badr Senousy, and A. E. D. M. Riad, Neutrosophic Logic Approach for Evaluating Learning Management Systems	3	F. Yuhua, Point Solution, Line Solution, Plane Solution etc —Expanding Concepts of Equation and Solution with Neutrosophy and Quad-stage Method	67
Chunfang Liu, and YueSheng Luo, A new method to construct entropy of interval-valued Neutrosophic Set.....	8	Broumi, A. Bakali, M. Talea, and F. Smarandache, Isolated Single Valued Neutrosophic Graphs	74
J. M. Jency and I. Arockiarani, Adjustable and Mean Potentiality Approach on Decision Making	12	M. Khan, F. Smarandache and S. Afzal, Neutrosophic Set Approach for Characterizations of Left Almost Semigroups.....	79
P. P. Dey, S. Pramanik, and B. C. Giri, An extended grey relational analysis based multiple attribute decision making in interval neutrosophic uncertain linguistic setting.....	21	F. Smarandache, Degree of Dependence and Independence of the (Sub)Components of Fuzzy Set and Neutrosophic Set.....	95
N. Shah and A. Hussain, Neutrosophic Soft Graphs.....	31	P. P. Dey, S. Pramanik, and B. C. Giri, Neutrosophic Soft Multi Attribute Decision Making Based on Grey Relational Projection Method.....	98
Gaurav, M. Kumar, K. Bhutani and S. Aggarwal, Mapping Causes and Implications of India’s Skewed Sex Ratio and Poverty problem using Fuzzy & Neutrosophic Relational Maps	45	H. E. Khalid, The Novel Attempt for Finding Minimum Solution in Fuzzy Neutrosophic Relational Geometric Programming (FNRGP) with (max,min) Composition....	107
V. Pătraşcu, Refined Neutrosophic Information Based on Truth, Falsity, Ignorance, Contradiction and Hesitation ...	57	M. A. Baset ,I. M. Hezam and F. Smarandache, Neutrosophic Goal Programming	112

Neutrosophic Sets and Systems

An International Journal in Information Science and Engineering

Copyright Notice

Copyright © Neutrosophic Sets and Systems

All rights reserved. The authors of the articles do hereby grant Neutrosophic Sets and Systems non-exclusive, worldwide, royalty-free license to publish and distribute the articles in accordance with the Budapest Open Initiative: this means that electronic copying, distribution and printing of both full-size version of the journal and the individual papers published therein for non-commercial, ac-

ademic or individual use can be made by any user without permission or charge. The authors of the articles published in Neutrosophic Sets and Systems retain their rights to use this journal as a whole or any part of it in any other publications and in any way they see fit. Any part of Neutrosophic Sets and Systems howsoever used in other publications must include an appropriate citation of this journal.

Information for Authors and Subscribers

“Neutrosophic Sets and Systems” has been created for publications on advanced studies in neutrosophy, neutrosophic set, neutrosophic logic, neutrosophic probability, neutrosophic statistics that started in 1995 and their applications in any field, such as the neutrosophic structures developed in algebra, geometry, topology, etc.

The submitted papers should be professional, in good English, containing a brief review of a problem and obtained results.

Neutrosophy is a new branch of philosophy that studies the origin, nature, and scope of neutralities, as well as their interactions with different ideational spectra.

This theory considers every notion or idea $\langle A \rangle$ together with its opposite or negation $\langle \text{anti}A \rangle$ and with their spectrum of neutralities $\langle \text{neut}A \rangle$ in between them (i.e. notions or ideas supporting neither $\langle A \rangle$ nor $\langle \text{anti}A \rangle$). The $\langle \text{neut}A \rangle$ and $\langle \text{anti}A \rangle$ ideas together are referred to as $\langle \text{non}A \rangle$.

Neutrosophy is a generalization of Hegel's dialectics (the last one is based on $\langle A \rangle$ and $\langle \text{anti}A \rangle$ only).

According to this theory every idea $\langle A \rangle$ tends to be neutralized and balanced by $\langle \text{anti}A \rangle$ and $\langle \text{non}A \rangle$ ideas - as a state of equilibrium.

In a classical way $\langle A \rangle$, $\langle \text{neut}A \rangle$, $\langle \text{anti}A \rangle$ are disjoint two by two. But, since in many cases the borders between notions are vague, imprecise, Sorites, it is possible that $\langle A \rangle$, $\langle \text{neut}A \rangle$, $\langle \text{anti}A \rangle$ (and $\langle \text{non}A \rangle$ of course) have common parts two by two, or even all three of them as well.

Neutrosophic Set and *Neutrosophic Logic* are generalizations of the fuzzy set and respectively fuzzy logic (especially of intuitionistic fuzzy set and respectively intuitionistic fuzzy logic). In neutrosophic logic a proposition has a degree of truth (T), a degree of indeterminacy (I), and a degree of falsity (F), where T, I, F are standard

or non-standard subsets of $[0, 1]^+$.

Neutrosophic Probability is a generalization of the classical probability and imprecise probability.

Neutrosophic Statistics is a generalization of the classical statistics.

What distinguishes the neutrosophics from other fields is the $\langle \text{neut}A \rangle$, which means neither $\langle A \rangle$ nor $\langle \text{anti}A \rangle$.

$\langle \text{neut}A \rangle$, which of course depends on $\langle A \rangle$, can be indeterminacy, neutrality, tie game, unknown, contradiction, ignorance, imprecision, etc.

All submissions should be designed in MS Word format using our template file:

<http://fs.gallup.unm.edu/NSS/NSS-paper-template.doc>

A variety of scientific books in many languages can be downloaded freely from the Digital Library of Science:

<http://fs.gallup.unm.edu/eBooks-otherformats.htm>

To submit a paper, mail the file to the Editor-in-Chief. To order printed issues, contact the Editor-in-Chief. This journal is non-commercial, academic edition. It is printed from private donations.

Information about the neutrosophics you get from the UNM website:

<http://fs.gallup.unm.edu/neutrosophy.htm>

The home page of the journal is accessed on

<http://fs.gallup.unm.edu/NSS>



Neutrosophic Logic Approach for Evaluating Learning Management Systems

Nouran Radwan¹, M. Badr Senousy², and Alaa El Din M. Riad³

¹ Faculty of Computer & Information Sciences, Mansoura, Egypt. radwannouran@yahoo.com

² Sadat Academy for Management Sciences, Cairo, Egypt. badr_senousy_arcoit@yahoo.com

³ Faculty of Computer & Information Sciences, Mansoura, Egypt. amriad2000@yahoo.com

Abstract. Uncertainty in expert systems is an essential research point in the artificial intelligence domain. Uncertain knowledge representation and analysis in expert systems is one of the challenges that takes researchers concern, as different uncertainty types which are imprecision, vagueness, ambiguity, and inconsistency need different handling models. This paper reviews some of the multi-valued logic models which are fuzzy set, intuitionistic fuzzy set, and suggests a new approach which is neutrosophic set for handling uncertainty in expert sys-

tems to derive decisions. The paper highlights, compares and clarifies the differences of these models in terms of the application area of problem solving. The results show that neutrosophic expert system for learning management systems evaluation as a better option to simulate human thinking than fuzzy and intuitionistic fuzzy logic because fuzzy logic can't express false membership and intuitionistic fuzzy logic is not able to handle indeterminacy of information.

Keywords: Uncertainty; Expert System; Fuzzy Set; Intuitionistic Fuzzy Set; Neutrosophic Set, Learning Management Systems.

1 Introduction

Uncertainty is the shortage of knowledge regardless of what is the reason of this deficient data [1]. Modeling uncertainty for solving real life situations is one of the crucial problems of artificial intelligence [2]. Previous researches presented various models that handle uncertainty by simulating the process of human thinking in expert systems, but these models are not enough to express uncertainty in problems [3,4]. Decision making includes ill-defined situations where it is not true or false; therefore it needs novel models to increase understanding of the realization outcome better than crisp [5].

Learning Management Systems (LMSs) are e-learning applications which help instructors in course administration. In higher education, the use of these applications has been rising as it supports universities in spreading educational resources to the learners [6,7]. System quality is an essential determinant of user satisfaction. It includes the usability, availability, stability, response time, and reliability of the system [8,9]. Previous studies [10] in learning management system evaluation are implemented under complete information, while the real environment has uncertainty aspects.

This leads to emerging new approaches such as fuzzy, intuitionistic fuzzy and neutrosophic models all of which give better attribute explications. The fuzzy theory which

considers the degree of the membership of elements in a set was introduced by Professor Lotfi Zadeh in 1965 [11]. Intuitionistic fuzzy set theory presented as an extension of the fuzzy sets by Attanssov in 1983 [12]. A novel approach proposed by Smarandache to handle indeterminacy information in 1999 called neutrosophic logic [13].

Expert systems simulate human expert reasoning to solve issues in a particular domain, such as diagnosis, repair, decision support, monitoring and control, and evaluation [14,15]. Expert system in uncertainty environment needs to draw conclusions as would a human expert do [14]. Uncertainties types that can emerge include: vagueness when information is gradually in natural, imprecision when information is not determined, ambiguity when available information leads to several feasible explications, and inconsistency when the conflicts and paradoxes in obtaining information is found [16,17]. This uncertainty types need models that handle different types of uncertainties [18].

This paper discusses multivalued logic models including fuzzy set, intuitionistic fuzzy set, and neutrosophic set for managing uncertainty in expert systems. The paper is organized as following: Section 1 provides an introduction to the paper; Section 2 presents multivalued logic models differences for managing uncertainty in expert systems; Then Section 3 presents the proposed neutrosophic expert systems for evaluating learning management systems, Sec-

tion 4 presents the discussion and finally Section 5 which presents conclusions and future work.

2 Multivalued Logic Models for Managing Uncertainty in Expert System

This section explores the basic properties and differences of multivalued logic models for handling uncertainty in expert systems.

2.1 Fuzzy Inference System

Crisp set deals with objects belonging to a set or is excluded from it. The fuzzy set theory discusses an aspect in which each object has a related value in the interval between 0 and 1; This indicates the degree of its membership in the set. The basic types of fuzzy logic membership function are triangular, trapezoidal, Gaussian, and bell. In Fuzzy Set Theory, each element $x \in U$ (Universe of discourse) is assigned a single membership value. A fuzzy set $A = \{ \langle x, \mu_A(x) \rangle | x \in U \}$ in a universe of discourse U is characterized by a membership function, μ_A , as follows [11]: $\mu_A: U \rightarrow [0, 1]$. (1)

Fuzzy inference systems responsible for indicating the mapping from a given an input to an output as shown in Figure 1. It consists of fuzzification of input, knowledge based system, and defuzzification of output as shown in Figure 1 [19] [20]. The fuzzy knowledge base contains the membership functions of the fuzzy sets and set of fuzzy production rules. In fuzzification, the crisp input is converted to a fuzzy output using the membership functions stored in the fuzzy knowledge base. In defuzzification, the fuzzy output is converted to a crisp output using common techniques : centroid, bisector, and maximum methods.

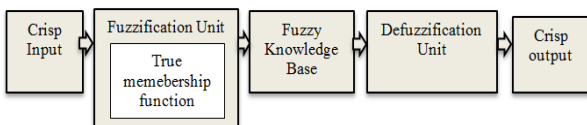

Figure 1: Block Diagram of Fuzzy Inference System

2.2 Intuitionistic Fuzzy Inference System

Atanassov said that the idea of the intuitionistic fuzzy set was a coincidence as he added to the fuzzy set definition a degree of non-membership. The intuitionistic idea incorporates the degree of hesitation [21]. An intuitionistic fuzzy set describes the membership of an element to a set, so that the sum of these degrees is always less or equal to 1. An intuitionistic fuzzy set $A = \{ \langle u, \mu_A(u), \nu_A(u) \rangle | u \in U \}$ in a universe of discourse U is characterized by a membership function μ_A , and a non-membership function ν_A , as follows [22] [23]:

$$\mu_A: U \rightarrow [0, 1], \quad \nu_A : U \rightarrow [0,1],$$

and $0 \leq \mu_A(u) + \nu_A(u) \leq 1$. (2)

The membership of an element to a fuzzy set is a single value between zero and one. However, it is not true that the degree of non-membership of an element is equal to 1 minus the membership degree as there is a hesitation degree. Intuitionistic fuzzy set is suitable in simulating the human imprecise decision making [24]. Figure 2 shows the intuitionistic fuzzy inference system. The fuzzy knowledge base contains the true and false membership functions of the intuitionistic fuzzy sets and set of intuitionistic fuzzy production rules.

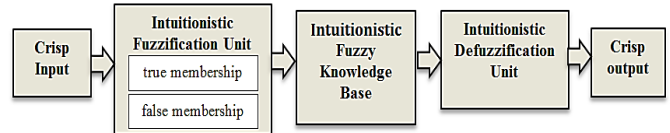

Figure 2: Block Diagram of Intuitionistic Fuzzy Inference System

2.3 Neutrosophic Inference System

Smarandache [13] proposed a novel approach called neutrosophic logic as an extension of fuzzy logic. Neutrosophic logic is an extension of the fuzzy logic, intuitionistic logic, and the three-valued, all of which variable x is described by triple values $x = (t, i, f)$ where t for the degree of truth, f for the degree of false and i for the degree of indeterminacy [20]. Current expert systems are constrained with strict conditions while futuristic expert systems do not depend only on truth value, but also on falsity and indeterminacy membership. So at neutrosophic logic approach, experts are asked about a certain statement to give a degree that the statement is true, degree the statement is false; and degree of indeterminate. In neutrosophic logic $t, i,$ and f are independent from each other and there is not restriction on their sum where [25]:

$$0 \leq t + i + f \leq 3$$
 (3)

Neutrosophic inference system consists of neutrosophication unit that accepts the crisp input and assigns the appropriate membership functions, neutrosophic knowledge base that maps input to output variable, and deneutrosophication unit that maps neutrosophic value to crisp value as shown in Figure 3 [20].

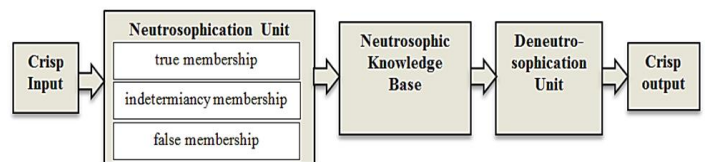

Figure 3: Block Diagram of Neutrosophic Inference System

2.4 Multivalued Logic Models for Handling Uncertainty

A better understanding of the differences and use between the uncertainty models is presented in this section.

The selection of the appropriate uncertainty model for a problem is essential to get the desirable results. As mentioned in the introduction section, the primary uncertainties types are imprecision, vagueness, ambiguity, and inconsistency. An example of vague information: "the color of the flower is nearly red", this type of uncertainty can be handled by Fuzzy set. An example of imprecise: "the temperature of the machine is between 88-92 °C", this type of uncertainty can be handled by intuitionistic fuzzy set. An example of ambiguity information: "votes for this candidate is about 60%", and an example of inconsistency: "the chance of raining tomorrow is 70%, it does not mean that the chance of not raining is 30%, since there might be hidden weather factors that is not aware of", these types of uncertainties can be handled by neutrosophic set. Table 1 is concluded from [26-28] that shows multivalued logic models and their ability to express various uncertainty data types.

Table 1: Multivalued Logic Models and Uncertainty Data Types

Uncertainty Models	Uncertainty Data Types				
	Vague-ness	Impre-cision	Ambi-guity	Incon-sistent	Incon-sistent
Fuzzy	✓				
Intuitionistic Fuzzy	✓	✓			
Neutrosophic	✓	✓	✓		✓

3 Neutrosophic Expert System for Evaluation of Learning Management System

3.1 Neutrosophic Expert System Algorithm

Developing neutrosophic expert system is shown in Figure 4:

- 1- Determine the system requirements represented in inputs, rules and outputs.
- 2- Experts define the neutrosophic memberships of inputs variables of the system, rules of neutrosophic knowledge base of the system and output membership of the system quality.
- 3- Inputs are expressed in neutrosophic sets using truth, falsity and indeterminacy membership functions. This step is called as neutrosophication step.
- 4- Creating neutrosophic set rules for three knowledge bases for true, false and indeterminacy.
- 5- Neutrosophic sets are converted into a single crisp value which has triplet format truth, indeterminacy and false. This process is called as deneutrosophication.

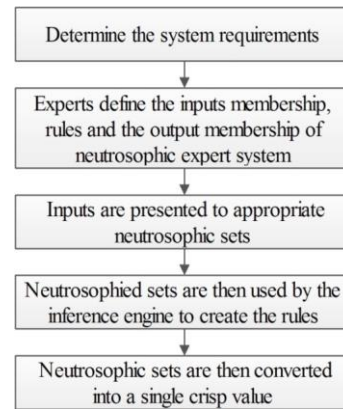

Figure 4: Steps for Developing Neutrosophic Expert System

3.2 Membership Functions for Input Attributes

LMS system quality is described by higher education organizations with uncertainty terms which are imprecise, vague, ambiguity and inconsistency. That is why conventional evaluation methods may not be virtuous. System can be defined as the stability, reliability, usability, availability, response time and adaptability attributes of the system. It quality is an important determinant of user satisfaction and system performance [29-31]. Previous studies in learning management system evaluation are implemented under complete information, while real world has uncertainty aspects. This leads us to illustrate the multivalued logic approaches differences such as fuzzy, intuitionistic fuzzy, and suggest a new one which is neutrosophic model to evaluate LMSs. In Table 2, a representation for each input attribute in usability using fuzzy, intuitionistic fuzzy and neutrosophic expert system for evaluating LMSs usability.

Table 2: Multivalued Logic Models Input Memberships

Type1 Fuzzy	Intuitionistic Fuzzy	Neutrosophic
$\mu_{Low}(x)$ in $[0,1]$, $\mu_{Medium}(x)$ in $[0,1]$, $\mu_{High}(x)$ in $[0,1]$, Where $\mu(X)$ is membership function.	$\mu_{Low}(x)$ in $[0,1]$, V_{Low} in $[0,1]$, $\mu_{Medium}(x)$ in $[0,1]$, V_{Medium} in $[0,1]$, $\mu_{High}(x)$ in $[0,1]$, $V_{High}(x)$ in $[0,1]$, Where $\mu(X)$ is membership function, $V(x)$ is a non-membership function and $0 \leq \mu(x) + V(x) \leq 1$.	$T_{Low}(x)$, $I_{Low}(x)$, $F_{Low}(x)$, $T_{Medium}(x)$, $I_{Medium}(x)$, $F_{Medium}(x)$, $T_{High}(x)$, $I_{High}(x)$, $F_{High}(x)$, Where $T(x)$ is membership/truth value, $I(x)$ is indeterminacy value, $F(x)$ is a non-membership/False value.

3.3 Knowledgebase and Evaluation Process

The proposed neutrosophic model evaluates system LMSs system quality considering one main criterion: usability. A usability criterion is derived into several attributes

as following: usability can be evaluated by efficiency, learnability, memorability, error tolerance and user satisfaction attributes. In the proposed neutrosophic model, five inputs for usability are considered; each consisting of three terms, then each true, indeterminacy, and false usability knowledge base consists of $3^5 = 243$ rules after considering all the possible combinations of inputs. In fuzzy expert system depend on true knowledge base; while in intuitionistic fuzzy set expert rely on true and false knowledge base. A sample of the rules for true, false, indeterminacy are listed in Figure 5, 6, and 7.

No. of Rules	Efficiency	Error Tolerance	Learnability	Memorability	User Satisfaction	Usability
1	low	low	low	low	low	v. low
2	med	low	low	low	low	v.low
3	high	low	low	low	low	low
...						
243	high	high	high	high	high	v.high

Figure 5: True Usability Knowledge Base

No. of Rules	Efficiency	Error Tolerance	Learnability	Memorability	User Satisfaction	Usability
1	low	low	low	low	low	low
2	med	low	low	low	low	low
3	high	low	low	low	low	low
...						
243	high	high	high	high	high	high

Figure 6: False Usability Knowledge Base

No. of Rules	Efficiency	Error Tolerance	Learnability	Memorability	User Satisfaction	Usability
1	low	low	low	low	low	low
2	med	low	low	low	low	low
3	high	low	low	low	low	low
...						
243	high	high	high	high	high	med

Figure 7: Indeterminacy Usability Knowledge Base

4 Discussion

The authors presented fuzzy, intuitionistic fuzzy, neutrosophic expert system for evaluating LMSs quality. The

neutrosophic expert system represents three components of truth, indeterminacy, and falsity unlike in fuzzy expert system which expresses the true membership value only and has no solution when experts have a hesitancy to define membership. Fuzzy system handles vagueness; while intuitionistic fuzzy system deals with vagueness and imprecision.

Neutrosophic system handles vagueness, imprecision, ambiguity, and inconsistent uncertainties types. For example; a vote with two symbols which are: A and B is occurred, in which some votes can't be determined if it's written A or B.

Table 1 shows the comparison of fuzzy, intuitionistic fuzzy, and neutrosophic expert system and their ability to represent different uncertainty data types. In Table 2, a representation for input attributes for usability using fuzzy, intuitionistic fuzzy and neutrosophic expert system for evaluating LMSs usability. The results show that fuzzy and intuitionistic fuzzy system is limited as it cannot represent paradoxes which are a feature of human thinking.

Conclusion and Future Work

Artificial intelligence disciplines like decision support systems and experts systems depend on true and indeterminate information which is the unawareness value between true and false. For example, if an opinion of an expert is asked about certain statement, then he may say that that the statement is true, false and indeterminacy are 0.6, 0.3 and 0.4 respectively. This can be appropriately handled by neutrosophic logic.

In this paper, a proposal for neutrosophic expert system for LMSs quality evaluation based on efficiency, learnability, memorability, error tolerance and user satisfaction for usability. Though, neutrosophic systems using varies according to the problem and available knowledge.

Future work will deal with the implementation of the neutrosophic expert system for LMSs system quality evaluation. Neutrosophic Logic is a new approach for evaluating the system quality attributes of various systems that can adapt variations and changes. This is an assertion to use neutrosophic logic approach for assessing the system quality of LMSs.

ACKNOWLEDGMENTS

We thank Prof. Dr. Florentine Smarandache [Department of Mathematics, University of New Mexico, USA] , Prof. Dr. Ahmed Salama [Department of Mathematics and Computer Science, Faculty of Sciences, Port Said University, Egypt] for helping us to understand neutrosophic approach. We would also like to show gratitude to Dr. Assem Alsawy [Institute of Statistical Studies & Research, Cairo University, Egypt] for his comments during the research.

References

- [1] Uusitalo, Lehtikoinen A, Helle I, Myrberg K.. "An overview of methods to evaluate uncertainty of deterministic models in decision support". *Environmental Modelling & Software* 63 (2015): 24-31.
- [2] Motro, Amihai, and Philippe Smets, eds. "Uncertainty management in information systems: from needs to solutions". Springer Science & Business Media, 2012..
- [3] Booker, J. M., and T. J. Ross. "An evolution of uncertainty assessment and quantification". *Scientia Iranica* 18.3 (2011): 669-676.
- [4] Liu, Sifeng, Keqin Sheng, and Jeffrey Forrest. "On uncertain systems and uncertain models". *Kybernetes* 41.5/6 (2012): 548-558.
- [5] Olson, David L., and Desheng Wu. "Decision making with uncertainty and data mining". *Advanced Data Mining and Applications*. Springer Berlin Heidelberg, (2005): 1-9.
- [6] Chung, Chih-Hung, Laura A. Pasquini, and Chang E. Koh. "Web-based learning management system considerations for higher education". *Learning and Performance Quarterly* 1.4 (2013): 24-37.
- [7] Aggarwal, Anil, Veena Adlakha, and Terry Ross. "A Hybrid approach for selecting a course management system: A case study". *Journal of Information Technology Education: Innovations in Practice* 11.1 (2012): 283-300.
- [8] Almarashdeh, Ibrahim Abood, et al. "The Success of Learning Management System among Distance Learners in Malaysian Universities". *Journal of Theoretical & Applied Information Technology* 21.2 (2010):80–91.
- [9] Lwoga, Edda Tandi. "Critical success factors for adoption of web-based learning management systems in Tanzania". *International Journal of Education and Development using Information and Communication Technology* 10.1 (2014): 4-21.
- [10] Yigit, Tuncay, Ali Hakan Isik, and Murat Ince. "Web-based learning object selection software using analytical hierarchy process". *Software, IET* 8.4 (2014): 174-183.
- [11] Zadeh, Lotfi A. "Fuzzy sets". *Information and control* 8.3 (1965): 338-353.
- [12] Atanassov, Krassimir T. "Intuitionistic fuzzy sets". *Fuzzy sets and Systems* 20.1 (1986): 87-96.
- [13] Smarandache, Florentin. "A Unifying Field in Logics: Neutrosophic Logic". *Philosophy* (1999): 1-141.
- [14] Anuradha, Sachin Kumar, and Anubhav Kumar. "Analysis of Information Uncertainty Management in Expert Systems". *International Journal of Advanced Research in Computer Science and Software engineering* 3.9 (2013):899-903.
- [15] Kaur, Er Navjot, Er Navleen Singh Rekhi, and Anand Nayyar. "Review of Expert Systems based on Fuzzy logic". *International Journal of Advanced Research in Computer and Communication Engineering* 2 (2013): 1334-1339.
- [16] Maitra, Sandhya, and Nidhi Gupta. "A Hybrid Approach for Handling Uncertainty-Probabilistic Theory, Certainty Factor and Fuzzy Logic". *International Journal of Computer Science and Mobile Computing* 2.11 (2013):70-78.
- [17] Dubey, Sonal, R. K. Pandey, and S. S. Gautam. "Dealing with Uncertainty in Expert Systems". *International Journal of Soft Computing and Engineering* 4.3 (2014): 105-111.
- [18] Yamaguchi, Daisuke, et al. "Reviewing crisp, fuzzy, grey and rough mathematical models". *Grey Systems and Intelligent Services, 2007. GSIS 2007*. IEEE International Conference on. IEEE, (2007): 547-552
- [19] Letichevsky, Ana Carolina, Marley Maria Bernardes Rebuszi Vellasco, and Ricardo Tanscheit. "A fuzzy decision support system for meta-evaluation a new approach and a case study performed in Brazil". *Ensaio: Avaliação e Políticas Públicas em Educação* 15.56 (2007): 447-462.
- [20] Raheja, Supriya, and Reena Dhadich. "Many valued logics for modeling vagueness". *International Journal of Computer Applications* 61.7 (2013): 35-39.
- [21] Atanassov, Krassimir T., "Intuitionistic fuzzy sets: past, present and future". *EUSFLAT Conf.* (2003):12-19.
- [22] A. Lu, and W. Ng, "Vague sets or intuitionistic fuzzy sets for handling vague data: which one is better?". *Conceptual Modeling–ER 2005*. Springer Berlin Heidelberg, (2005): 401-416.
- [23] Ejegwa, P. A., et al. "An overview on intuitionistic fuzzy sets". *Int. J. of Scientific & Tech. Research* 3.3 (2014): 142-145.
- [24] Husain, Sadia, Yasir Ahmad, and M. Afshar Alam. "A study on the Role of Intuitionistic Fuzzy Set in Decision making problems". *International Journal of Computer Applications (0975-888)* 48.19 (2012): 35-41.
- [25] Aggarwal, Swati, Ranjit Biswas, and A. Q. Ansari. "Neutrosophic modeling and control". *Computer and Communication Technology (ICCCCT), 2010 International Conference on*. IEEE, (2010):718-723.
- [26] Ashu, Ashu. "Intuitionistic Fuzzy Approach to handle Imprecise Humanistic Queries in Databases". *International Journal of Computer Applications* 43.20 (2012): 6-9.
- [27] Wen, Xiaoqiang, et al. "Study on the state of slag on coal-fired boilers based on symmetric fuzzy cross entropy and vague sets". *Information and Automation (ICIA), 2010 IEEE International Conference on*. IEEE, (2010): 1769-1774.
- [28] Broumi, Said, Ridvan Sahin, and Florentin Smarandache. "Generalized interval neutrosophic soft set and its decision making problem". *Journal of New Results in Science* 7.7 (2014): 29-47.

Received: Jan. 25, 2016. Accepted: Feb. 27, 2016



A new method to construct entropy of interval-valued Neutrosophic Set

Chunfang Liu^{1,2}, YueSheng Luo^{2,3}

¹ College of Science, Northeast Forestry University, Hexing Road 26, Harbin 150040, China. E-mail: liuchunfang1112@163.com

² College of Automation, Harbin Engineering University, Nantong Road 145, Harbin 150001, China

³ College of Science, Harbin Engineering University, Nantong Road 145, Harbin 150001, China. E-mail: luoyuesheng@hrbeu.edu.cn

Abstract Interval-valued neutrosophic set (INS) is a generalization of fuzzy set (FS) that is designed for some practical situations in which each element has different truth membership function, indeterminacy membership function and falsity membership function and permits the membership degrees to be expressed by interval values. In this paper, we first introduce the similarity measure between single valued

neutrosophic sets, then propose a new method to construct entropy of interval-valued neutrosophic sets based on the similarity measure between the two single valued neutrosophic sets, finally we give an example to show that our method is effective and reasonable.

Keywords: Interval-valued neutrosophic set (INS), Entropy, Similarity measure

1. Introduction

In 1965, Zadeh first introduced Fuzzy set, which has been widely used in decision making, artificial intelligence, pattern recognition, information fusion, etc [1,2]. Later, several high-order fuzzy sets have been proposed as an extension of fuzzy sets, including interval-valued fuzzy set, type-2 fuzzy set, type-n fuzzy set, soft set, rough set, intuitionistic fuzzy set, interval-valued intuitionistic fuzzy set, hesitant fuzzy set and neutrosophic set (NS) [2,3,4,5].

As a generalization of fuzzy set, the NS was proposed by Smarandache [5] not only to deal with the decision information which is often incomplete, indeterminate and inconsistent but also include the truth membership degree, the falsity membership degree and the indeterminacy membership degree. Since NS contains both non-standard and standard intervals in its theory and related operations which restricts its application in many fields. For simplicity and practical application, Wang proposed the interval NS (INS) and the single valued NS (SVNS) which are the instances of NS and gave some operations on these sets [9,10]. Ye proposed the similarity measure of interval valued neutrosophic set and applied them to decision making [11], he also proposed the vector similarity measures of simplified neutrosophic sets [12]. Ali proposed the entropy and similarity measure of interval valued neutrosophic set [13]. Zhang proposed the cross-entropy of interval neutrosophic set and applied it to multi-criteria decision making [14]. All these papers have enriched the theory of neutrosophic set.

Consistently with axiomatic definition of entropy of INS, we introduce the similarity measure between single valued neutrosophic sets, and propose a new method to construct entropy of interval-valued neutrosophic sets based on the similarity measure between single valued neutrosophic sets, then we give an example to show that our method is effective and reasonable.

The structure of this paper is organized as follows. Section 2 introduces some basic definitions of the interval-valued neutrosophic sets and the single valued neutrosophic sets (SVNSs). Section 3 presents a new similarity measure of SVNSs. Section 4 gives entropy of INS. Section 5 concludes our work.

2. Preliminaries

Definition1 [9] Let X be a space of points (objects), and its element is denoted by x . A NS A in X , if the functions $T_A(x), I_A(x), F_A(x)$ are singleton subsets in the real standard $[0,1]$. Then, a single valued NS A is denoted by

$$A = \{ \langle x; T_A(x), I_A(x), F_A(x) \rangle | x \in X \}$$

which is called a single valued neutrosophic set (SVNS).

Definition2 [9] For two SVNSs A and B , A is contained in B , if and only if

$$T_A(x) \leq T_B(x), I_A(x) \geq I_B(x), F_A(x) \geq F_B(x)$$

for every x in X .

Definition3 [9] The complement of SVNS A is defined by

$$A^c = \{ \langle x; F_A(x), 1 - I_A(x), T_A(x) \rangle | x \in X \}$$

Interval-valued neutrosophic set (INS) improves the ability of NS expressing the uncertainty of information whose membership functions take the form of interval values.

Definition 4 [10] Assume X be a universe of discourse, with a generic element in X denoted by x . An interval-valued neutrosophic set A in X is

$$A = \{ \langle x, T_A(x), I_A(x), F_A(x) \rangle \mid x \in X \}$$

where $T_A(x)$, $I_A(x)$ and $F_A(x)$ are the truth membership function, indeterminacy membership function and falsity membership function, respectively. For each point x in X , we have

$$T_A(x) = [\inf T_A(x), \sup T_A(x)] \subseteq [0, 1],$$

$$I_A(x) = [\inf I_A(x), \sup I_A(x)] \subseteq [0, 1],$$

$$F_A(x) = [\inf F_A(x), \sup F_A(x)] \subseteq [0, 1]$$

$$\text{and } 0 \leq \text{Sup}T_A(x) + \text{Sup}I_A(x) + \text{Sup}F_A(x) \leq 3.$$

Definition5 [10] For two INSs A and B , A is contained in B , if and only if

$$\inf T_A(x) \leq \inf T_B(x), \sup T_A(x) \leq \sup T_B(x),$$

$$\inf I_A(x) \geq \inf I_B(x), \sup I_A(x) \geq \sup I_B(x),$$

$$\inf F_A(x) \geq \inf F_B(x), \sup F_A(x) \geq \sup F_B(x),$$

for every x in X .

Definition6 [10] The complement of INS A is defined by

$$A^c = \{ \langle x; T_{A^c}(x), I_{A^c}(x), F_{A^c}(x) \rangle \mid x \in X \}$$

where

$$T_{A^c}(x) = F_A(x) = [\inf F_A(x), \sup F_A(x)],$$

$$I_{A^c}(x) = [1 - \sup I_A(x), 1 - \inf I_A(x)],$$

$$F_{A^c}(x) = T_A(x) = [\inf T_A(x), \sup T_A(x)]$$

3. Similarity measure of single valued neutrosophic sets

Definition7 [11] Let A and B be two SVNSs, a function S is the similarity measure between A and B , if S satisfies the following properties:

$$(N1) S(A, A^c) = 0 \text{ if } A \text{ is a crisp set;}$$

$$(N2) S(A, B) = 1 \Leftrightarrow A = B;$$

$$(N3) S(A, B) = S(B, A);$$

$$(N4) \text{ for all SVNSs } A, B, C, \text{ if } A \subseteq B \subseteq C, \text{ then } S(A, C) \leq S(A, B), S(A, C) \leq S(B, C).$$

Let

$$A = \{ T_A(x), I_A(x), F_A(x) \},$$

$B = \{ T_B(x), I_B(x), F_B(x) \}$ be two SVNSs, we will use the Hamming distance to define the similarity measure of single valued neutrosophic sets.

$$S(A, B) = 1 - \frac{1}{3} \sum_{j=1}^n \left(\begin{matrix} |T_A(x_j) - T_B(x_j)| + \\ |I_A(x_j) - I_B(x_j)| + \\ |F_A(x_j) - F_B(x_j)| \end{matrix} \right) \quad (1)$$

It is easy to prove the similarity measure satisfies the Definition 7.

4. Entropy of interval-valued neutrosophic set

Based on [15], we give the definition of entropy of INS as follows:

Definition8 A real valued function $E : \text{INSs} \rightarrow [0, 1]$ is called an entropy of INS, if E satisfies the following properties:

$$(P1) E(A) = 0 \text{ if } A \text{ is a crisp set;}$$

$$(P2) E(A) = 1 \text{ iff } \inf I_A(x) = \sup I_A(x),$$

$$[\inf T_A(x), \sup T_A(x)] = [\inf F_A(x), \sup F_A(x)];$$

$$(P3) E(A) = E(A^c);$$

$$(P4) E(A) \leq E(B)$$

if $A \subseteq B$ when

$$\inf T_B \leq \inf F_B \quad \text{and} \quad \sup T_B \leq \sup F_B$$

$$\inf I_B \geq 1 - \sup I_B;$$

or $B \subseteq A$ when

$$\inf F_B \leq \inf T_B \quad \text{and} \quad \sup F_B \leq \sup T_B$$

$$\inf I_B \geq 1 - \sup I_B.$$

Let

$$A = \left\{ \begin{matrix} [\inf T_A(x), \sup T_A(x)], [\inf I_A(x), \sup I_A(x)] \\ [\inf F_A(x), \sup F_A(x)] \end{matrix} \right\}$$

be an INS, we construct the new SVNSs based on A .

$$A_1 = \{ \inf T_A(x), \inf I_A(x), \inf F_A(x) \} \quad (2)$$

$$A_2 = \{ \sup T_A(x), \sup I_A(x), \sup F_A(x) \} \quad (3)$$

$$A_2^C = \{ \sup F_A(x), 1 - \sup I_A(x), \sup T_A(x) \} \quad (4)$$

Theorem1 Suppose S is the similarity measure of SVNSSs , E is the entropy of INS, $S(A_1, A_2^C)$ is the similarity measure of SVNSSs A_1 and A_2^C , then $E(A) = S(A_1, A_2^C)$.

Proof. (P1) If A is a crisp set, then for every $x \in X$, we have

$$\inf T_A(x) = \sup T_A(x) = 1$$

$$\inf I_A(x) = \sup I_A(x) = 0$$

$$\inf F_A(x) = \sup F_A(x) = 0$$

or

$$\inf T_A(x) = \sup T_A(x) = 0$$

$$\inf I_A(x) = \sup I_A(x) = 0$$

$$\inf F_A(x) = \sup F_A(x) = 1$$

which means that

$$A_1 = \{1, 0, 0\}, A_2 = \{1, 0, 0\}, A_2^C = \{0, 1, 1\}. \text{ It is}$$

obvious that $E(A) = S(A_1, A_2^C) = 0$.

(P2) By the definition of similarity measure of fuzzy sets, we have

$$E(A) = S(A_1, A_2^C) = 1$$

$$\Leftrightarrow A_1 = A_2^C$$

$$\Leftrightarrow \inf T_A(x) = \sup F_A(x),$$

$$\inf I_A(x) = 1 - \sup I_A(x),$$

$$\inf F_A(x) = \sup T_A(x) .$$

$$\Leftrightarrow A = \left\{ \begin{array}{l} [0.5, 0.5], [\inf I_A(x), \sup I_A(x)] \\ [1 - \inf I_A(x)], [0.5, 0.5] \end{array} \right\}$$

$$\Leftrightarrow E(A) = 1$$

(P3) Because $(A^C)_2 = A_2^C, (A^C)_1^C = A_1$,

we have

$$E(A) = S(A_1, A_2^C) = S(A_2^C, A_1)$$

$$= S((A^C)_1^C, (A^C)_2) = S((A^C)_2, (A^C)_1^C)$$

$$= E(A^C)$$

(P4) Since $A \subseteq B$ it means that

$$\inf T_A(x) \leq \inf T_B(x), \sup T_A(x) \leq \sup T_B(x)$$

$$\inf I_A(x) \geq \inf I_B(x), \sup I_A(x) \geq \sup I_B(x)$$

$$\inf F_A(x) \geq \inf F_B(x), \sup F_A(x) \geq \sup F_B(x).$$

when

$$\inf T_B(x) \leq \inf F_B(x) , \sup T_B(x) \leq \sup F_B(x) ,$$

$$\inf I_B(x) \geq 1 - \sup I_B(x)$$

then we get

$$\inf T_A(x) \leq \inf T_B(x) \leq \inf F_B(x) \leq \inf F_A(x)$$

$$, \sup T_A(x) \leq \sup T_B(x) \leq \sup F_B(x) \leq \sup F_A(x)$$

, By computing, we can get

$$A_1 \subseteq B_1 \subseteq B_2^C \subseteq A_2^C ,$$

and using the definition of similarity measure, we get

$$E(A) = S(A_1, A_2^C) \leq S(A_1, B_2^C) \leq S(B_1, B_2^C) = E(B)$$

, With the same reason, if $B \subseteq A$ when

$$\inf F_B \leq \inf T_B \quad \text{and} \quad \sup F_B \leq \sup T_B ,$$

$$\inf I_B \geq 1 - \sup I_B , \text{ we conclude } E(A) \leq E(B) .$$

Hence, we complete the proof of Theorem 1.

We can define entropy of INS by similarity measure between two SVNSSs, which constructed by A , it satisfied the definition of entropy.

Example .

Let $X = \{x_1, x_2, \dots, x_n\}$ be a universe of discourse.

Let $A = \{ \langle x_i, [0.7, 0.8], [0.5, 0.7], [0.1, 0.2] \rangle | x_i \in X \}$.

$B = \{ \langle x_i, [0.6, 0.8], [0.4, 0.6], [0.1, 0.3] \rangle | x_i \in X \}$ be two INSs.

Now we will obtain the entropy $E(A)$, $E(B)$ as follows.

For A , from (1), (2) , (3) , (4), we obtain

$$A_1 = \{0.7, 0.5, 0.1\}, A_2 = \{0.8, 0.7, 0.2\} \text{ and}$$

$$A_2^C = \{0.2, 0.3, 0.8\};$$

$$E(A) = S(A_1, A_2^C) = 1 - \frac{1}{3}(0.5 + 0.2 + 0.7) = 0.5333$$

For B , $B_1 = \{0.6, 0.4, 0.1\}$, $B_2 = \{0.8, 0.6, 0.3\}$ and

$$B_2^C = \{0.3, 0.4, 0.8\};$$

$$E(B) = S(B_1, B_2^C) = 1 - \frac{1}{3}(0.3 + 0.7) = 0.6667 .$$

$E(A) < E(B)$ is consistent with our intuition.

5. Conclusion

Neutrosophic set is a necessary tool to deal with the uncertain information. In this paper, we commented on the

axiomatic definitions of similarity measure of SVNNSs and entropy of INNSs, respectively. We first introduced the similarity measure between SVNNSs, and proposed a new method to construct entropy of INNS based on the similarity measure between SVNNSs, then we gave an example to show that our method is effective and reasonable. In the future, we want to give the entropy of INNSs based on similarity measure of INNSs.

References

- [1] L.A. Zadeh. Fuzzy sets, *Information and Control*, 8 (1965), 338-353.
- [2] L.A. Zadeh. In there a need for fuzzy logic?, *Information Sciences*, 178(2008), 2751-2779.
- [3] K. Atanassov. Intuitionistic fuzzy sets, *Fuzzy sets and systems*, 20(1986), 87-96.
- [4] V. Torra. Hesitant fuzzy sets, *International Journal of Intelligent Systems*, 25(2010), 529-539.
- [5] F. Smarandache. A unifying field in logics. *Neutrosophy: Neutrosophic probability, set and logic*, Rehoboth, DE: American Research Press.1999.
- [6] J. Ye. A multi-criteria decision-making method using aggregation operators for simplified neutrosophic set, *Journal of Intelligent and Fuzzy Systems*, 26(2014), 2459-2466.
- [7] S. Broumi and F. Smarandache. Several Similarity Measures of neutrosophic set, *Neutrosophic Sets and Systems*, 1(2013), 54-62.
- [9] H. Wang, F. Smarandache, Y.Q. Zhang, R. Sunderraman. Single valued neutrosophic sets, *Multispace Multistructno*, 4(2010), 410-413,.
- [10] H. Wang, F. Smarandache, Y.Q. Zhang, R. Sunderraman. Interval neutrosophic sets and logic: theory and applications in computing, Hexis, Phoenix, AZ, 2005.
- [11]J. Ye. Similarity measures between interval valued neutrosophic sets and their applications in multi-criteria decision making, *Journal of Intelligent and Fuzzy Systems*, 26(2014), 2459-2466.
- [12] J. Ye. Vector similarity measures of simplified neutrosophic sets their applications in multi-criteria decision making, *International Journal of Fuzzy Systems*, 16(2014), 204-210.
- [13]Ali Aydogdu. On entropy and similarity measure of interval valued neutrosophic sets, *Neutrosophic Sets and Systems*, 9(2015), 47-19.
- [14]Z. Tian, H. Zhang, J. Wang, X. Chen. Multi-criteria decision making method based on a cross-entropy with interval neutrosophic sets, *International Journal of Systems Science*, 2015, 1-11.
- [15]H.Bustince, P. Burillo, Entropy on intuitionistic fuzzy sets and on interval-valued fuzzy sets, *Fuzzy sets and Systems* 78(1996), 305-316.

Received: Feb. 12, 2016. Accepted: Mar. 27, 2016



Adjustable and Mean Potentiality Approach on Decision Making

J. Martina Jency¹ and I. Arockiarani²

^{1,2}Nirmala College for Women, Coimbatore- 641018, Tamilnadu, India. E-mail: martinajency@gmail.com

Abstract. In this paper, we design a model based on *adjustable and mean potentiality approach* to single valued neutrosophic level soft sets. Further, we introduce the notion of *weighted single valued neutrosophic soft set* and investigate its application in decision making.

Keywords: Soft sets, single valued neutrosophic soft sets, weighted single valued neutrosophic soft sets.

1 Introduction

The classical methods are not always successful, because the uncertainties appearing in these domains may be of various types. While a wide range of theories, such as probability theory, fuzzy set theory, intuitionistic fuzzy set theory, rough set theory, vague set theory, and interval mathematics, are well-known mathematical approaches to modelling uncertainty, each of these theories has its inherent difficulties, as pointed out by Molodtsov [21]. The possible reason for their inconveniences is the inadequacy of the parameterization tool. Consequently, Molodtsov initiated the soft set theory as a completely new approach for modelling vagueness and uncertainty, free from the ponderosity affecting existing methods [20]. This theory has been useful in many different fields, such as decision making [7, 8, 10, 13, 15, 23] or data analysis [32].

Up to date, the research on soft sets has been very active and many important results have been achieved in theory. The concept and basic properties of soft set theory were presented in [14, 21]. Practically, Maji et al. introduced several algebraic operations in soft set theory and published a detailed theoretical study. Firstly, Maji et al. [15] applied soft sets to solve the decision making problem with the help of rough approach. Arockiarani et al. [4] extended the (classical) soft sets to single valued neutrosophic (fuzzy neutrosophic) soft sets. Zadeh introduced the degree of membership/truth (t), in 1965, and defined the fuzzy set. Atanassov introduced the degree of nonmembership/falsehood (f), in 1986, and defined the intuitionistic fuzzy set. Smarandache introduced the degree of indeterminacy / neutrality (i) as an independent component, in 1995 (published in 1998), and he defined the neutrosophic set on three independent components $(t, i, f) = (\text{truth, inde-}$

terminacy, falsehood). He coined/invented the words “neutrosophy”, and its derivative - “neutrosophic”, whose etymology is: *Neutrosophy* (from Latin “neuter” - neutral, Greek “sophia” – skill / wisdom), as a branch of philosophy, studying the origin, nature, and scope of neutralities, as well as their interactions with different ideational spectra. Neutrosophy considers a proposition, theory, event, concept, or entity “A” in relation to its opposite, “Anti-A”, and that which is not “A”, “Non-A”, and that which is neither “A”, nor “Anti-A”, denoted by “Neut-A”. Neutrosophy is thus a generalization of dialectics. Neutrosophy is the basis of neutrosophic logic, neutrosophic set, neutrosophic set, neutrosophic probability and neutrosophic statistics. In 2013, Smarandache refined the single valued neutrosophic set to n components: $t_1, t_2, \dots; i_1, i_2, \dots; f_1, f_2, \dots$.

In this paper, we present an adjustable approach and mean potentiality approach to single valued neutrosophic soft sets by using single valued neutrosophic level soft sets, and give some illustrative examples. The properties of level soft sets are as well discussed. Also, we introduce the weighted single valued neutrosophic soft sets and investigate its application in decision making.

2 Preliminaries

Definition 2.1 [11]

Let X be a space of points (objects), with a generic element in X denoted by x . A single valued neutrosophic set (SVNS) A in X is characterized by truth-membership function T_A , indeterminacy-membership function I_A and falsity-membership function F_A .

For each point x in X , $T_A(x), I_A(x), F_A(x) \in [0,1]$. When X is continuous, a SVNS A can be written as A ,

$$\int_X \langle T_A(x), I_A(x), F_A(x) \rangle / x, x \in X.$$

When X is discrete, a SVNS A can be written as

$$A = \sum_{i=1}^n \langle T(x_i), I(x_i), F(x_i) \rangle / x_i, x_i \in X$$

Definition 2.2 [20]

Let U be the initial universe set and E be a set of parameters. Let $P(U)$ denote the power set of U . Consider a non-empty set $A, A \subset E$. A pair (F, A) is called a soft set over U , where F is a mapping given by $F: A \rightarrow P(U)$.

Definition 2.3 [4]

Let U be the initial universe set and E be a set of parameters. Consider a non-empty set $A, A \subset E$. Let $P(U)$ denote the set of all single valued neutrosophic (fuzzy neutrosophic) sets of U . The collection (F, A) is termed to be the (fuzzy neutrosophic) single valued neutrosophic soft set over U , where F is a mapping given by $F: A \rightarrow P(U)$.

3 An adjustable approach to single valued neutrosophic soft sets based decision making

Definition 3.1

Let $\varpi = \langle F, A \rangle$ be a single valued neutrosophic soft set over U , where $A \subseteq E$ and E is a set of parameters. For $r, s, t \in [0,1]$, the (r, s, t) - level soft set of ϖ is a crisp soft set $L(\varpi; r, s, t) = \langle F_{(r,s,t)}, A \rangle$ defined by $F_{(r,s,t)}(e) = L(F(e); r, s, t) = \{x \in U / T_{F(e)}(x) \geq r, I_{F(e)}(x) \leq s, F_{F(e)}(x) \leq t\}$, for all $e \in A$.

Here $r \in [0,1]$ can be viewed as a given least threshold on membership values, $s \in [0,1]$ can be viewed as a given least threshold on indeterministic values, and $t \in [0,1]$ can be viewed as a given greatest threshold on non-membership values.

For real-life applications of single valued neutrosophic soft sets based decision making, usually the thresholds r, s, t are chosen in advance by decision makers and represent their requirements on “membership levels”, “indeterministic levels” and “non-membership levels” respectively.

To illustrate this idea, let us consider the following example.

Example 3.2

Let us consider a single valued neutrosophic soft set $\varpi = \langle F, A \rangle$ which describes the “features of the air conditioners” that Mr. X is considering for purchase. Suppose that there are five air conditioners produced by different companies in the domain $U = \{x_1, x_2, x_3, x_4, x_5\}$ under con-

sideration, and that $A = \{e_1, e_2, e_3, e_4\}$ is a set of decision parameters. The $e_i (i = 1,2,3,4)$ stands for the parameters “branded”, “expensive”, “cooling speed” and “after sale product service”, respectively.

Suppose that $F(e_1) = \{\langle X_1, 0.7, 0.3, 0.1 \rangle, \langle X_2, 0.8, 0.3, 0.1 \rangle, \langle X_3, 0.9, 0.4, 0.05 \rangle, \langle X_4, 0.6, 0.3, 0.2 \rangle, \langle X_5, 0.5, 0.4, 0.2 \rangle\}$, $F(e_2) = \{\langle X_1, 0.6, 0.25, 0.1 \rangle, \langle X_2, 0.9, 0.3, 0.05 \rangle, \langle X_3, 0.8, 0.3, 0.05 \rangle, \langle X_4, 0.6, 0.2, 0.4 \rangle, \langle X_5, 0.7, 0.2, 0.3 \rangle\}$, $F(e_3) = \{\langle X_1, 0.75, 0.35, 0.1 \rangle, \langle X_2, 0.7, 0.4, 0.15 \rangle, \langle X_3, 0.85, 0.5, 0.1 \rangle, \langle X_4, 0.5, 0.4, 0.3 \rangle, \langle X_5, 0.6, 0.45, 0.2 \rangle\}$, $F(e_4) = \{\langle X_1, 0.65, 0.3, 0.2 \rangle, \langle X_2, 0.85, 0.5, 0.15 \rangle, \langle X_3, 0.9, 0.6, 0.1 \rangle, \langle X_4, 0.7, 0.4, 0.2 \rangle, \langle X_5, 0.6, 0.3, 0.1 \rangle\}$.

The single valued neutrosophic soft set $\varpi = \langle F, A \rangle$ is a parameterized family $\{F(e_i), i=1,2,3,4\}$ of single valued neutrosophic sets on U and $\langle F, A \rangle = \{\text{branded air conditioners} = F(e_1), \text{expensive air conditioners} = F(e_2), \text{High cooling speed air conditioners} = F(e_3), \text{Good after sale product service} = F(e_4)\}$. Table 1 gives the tabular representation of the single valued neutrosophic soft set $\varpi = \langle F, A \rangle$.

U	e_1	e_2	e_3	e_4
X_1	(0.7,0.3,0.1)	(0.6,0.25,0.1)	(0.75,0.35,0.1)	(0.65,0.3,0.2)
X_2	(0.8,0.3,0.1)	(0.9,0.3,0.05)	(0.7,0.4,0.15)	(0.85,0.5,0.15)
X_3	(0.9,0.4,0.05)	(0.8,0.3,0.05)	(0.85,0.5,0.1)	(0.9,0.6,0.1)
X_4	(0.6,0.3,0.2)	(0.6,0.2,0.4)	(0.5,0.4,0.3)	(0.7,0.4,0.2)
X_5	(0.5,0.4,0.2)	(0.7,0.2,0.3)	(0.6,0.45,0.2)	(0.6,0.3,0.1)

Table 1: Tabular representation of the single valued neutrosophic soft set

$$\varpi = \langle F, A \rangle.$$

Now we take $r = 0.7, s = 0.3, t = 0.2$, then we have the following:

$$\begin{aligned} L(F(e_1); 0.7, 0.3, 0.2) &= \{X_1, X_2, X_3\}, \\ L(F(e_2); 0.7, 0.3, 0.2) &= \{X_2, X_3\}, \\ L(F(e_3); 0.7, 0.3, 0.2) &= \{X_1, X_2, X_3\}, \\ L(F(e_4); 0.7, 0.3, 0.2) &= \{X_2, X_3, X_4\}. \end{aligned}$$

Hence, the $(0.7, 0.3, 0.2)$ -level soft set of $\varpi = \langle F, A \rangle$ is $L(\varpi; 0.7, 0.3, 0.2) = \langle F_{(0.7,0.3,0.2)}, A \rangle$, where the set-valued mapping $F_{(0.7,0.3,0.2)}: A \rightarrow P(U)$ is defined by $F_{(0.7,0.3,0.2)}(e_i) = L(F(e_i); 0.7, 0.3, 0.2)$, for $i=1,2,3,4$. Table 2 gives the tabular representation of the $(0.7, 0.3, 0.2)$ -level soft set of $L(\varpi; 0.7, 0.3, 0.2)$.

U	e_1	e_2	e_3	e_4
X_1	1	0	1	0
X_2	1	1	1	1
X_3	1	1	1	1
X_4	0	0	0	1
X_5	0	0	0	0

Table 2: Tabular representation of the (0.7,0.3,0.2)-level soft set of $L(\varpi;0.7,0.3,0.2)$

Now, we show some properties of the (r, s, t) - level soft sets.

Theorem 3.3

Let $\varpi = \langle F, A \rangle$ be a single valued neutrosophic soft set over U , where $A \subseteq E$ and E is a set of parameters. Let $L(\varpi; r_1, s_1, t_1)$ and $L(\varpi; r_2, s_2, t_2)$ be (r_1, s_1, t_1) - level soft set, and (r_2, s_2, t_2) - level soft set of ϖ respectively, where $r_1, s_1, t_1, r_2, s_2, t_2 \in [0,1]$. If $r_2 \leq r_1, s_2 \leq s_1$ and $t_2 \geq t_1$, then we have $L(\varpi; r_1, s_1, t_1) \tilde{\subseteq} L(\varpi; r_2, s_2, t_2)$.

Proof

Let $L(\varpi; r_1, s_1, t_1) = \langle F_{(r_1, s_1, t_1)}, A \rangle$, where $F_{(r_1, s_1, t_1)}(e) = L(F(e); r_1, s_1, t_1) = \{x \in U / T_{F(e)}(x) \geq r_1, I_{F(e)}(x) \geq s_1, F_{F(e)}(x) \leq t_1\}$ for all $e \in A$.

Let $L(\varpi; r_2, s_2, t_2) = \langle F_{(r_2, s_2, t_2)}, A \rangle$ where $F_{(r_2, s_2, t_2)}(e) = L(F(e); r_2, s_2, t_2) = \{x \in U / T_{F(e)}(x) \geq r_2, I_{F(e)}(x) \geq s_2, F_{F(e)}(x) \leq t_2\}$ for all $e \in A$. Obviously, $A \subseteq A$.

In the following, we will prove that for all $e \in A$, $F_{(r_1, s_1, t_1)}(e) \subseteq F_{(r_2, s_2, t_2)}(e)$. Since $r_2 \leq r_1, s_2 \leq s_1$ and $t_2 \geq t_1$, then, for all $e \in A$, we have the following $\{x \in U / T_{F(e)}(x) \geq r_1, I_{F(e)}(x) \geq s_1, F_{F(e)}(x) \leq t_1\} \subseteq \{x \in U / T_{F(e)}(x) \geq r_2, I_{F(e)}(x) \geq s_2, F_{F(e)}(x) \leq t_2\}$. Since $F_{(r_1, s_1, t_1)}(e) = \{x \in U / T_{F(e)}(x) \geq r_1, I_{F(e)}(x) \geq s_1, F_{F(e)}(x) \leq t_1\}$ and $F_{(r_2, s_2, t_2)}(e) = \{x \in U / T_{F(e)}(x) \geq r_2, I_{F(e)}(x) \geq s_2, F_{F(e)}(x) \leq t_2\}$, thus we have $F_{(r_1, s_1, t_1)}(e) \subseteq F_{(r_2, s_2, t_2)}(e)$. Therefore, $L(\varpi; r_1, s_1, t_1) \tilde{\subseteq} L(\varpi; r_2, s_2, t_2)$.

Theorem 3.4

Let $\varpi = \langle F, A \rangle$ and $\zeta = \langle G, A \rangle$ be a single valued neutrosophic soft sets over U , where $A \subseteq E$ and E is a set of parameters. $L(\varpi; r, s, t)$ and $L(\zeta; r, s, t)$ are (r, s, t) - level soft sets of ϖ and ζ , respectively, where $r, s, t \in [0,1]$. If $\varpi \tilde{\subseteq} \zeta$ then we have $L(\varpi; r, s, t) \tilde{\subseteq} L(\zeta; r, s, t)$.

Proof

$L(\varpi; r, s, t) = \langle F_{(r, s, t)}, A \rangle$, where $F_{(r, s, t)}(e) = L(F(e); r, s, t) = \{x \in U / T_{F(e)}(x) \geq r, I_{F(e)}(x) \geq s, F_{F(e)}(x) \leq t\}$, for all $e \in A$. Let $L(\zeta; r, s, t) = \langle G_{(r, s, t)}, A \rangle$ where $G_{(r, s, t)}(e) = L(G(e); r, s, t) = \{x \in U / T_{G(e)}(x) \geq r, I_{G(e)}(x) \geq s, F_{G(e)}(x) \leq t\}$, for all $e \in A$. Obviously, $A \subseteq A$.

In the following, we will prove that, for all $e \in A$, $F_{(r, s, t)}(e) \subseteq G_{(r, s, t)}(e)$. Since $\varpi \tilde{\subseteq} \zeta$, then we have the following $T_{F(e)}(x) \leq T_{G(e)}(x), I_{F(e)}(x) \leq I_{G(e)}(x), F_{F(e)}(x) \geq F_{G(e)}(x)$ for all $x \in U$ and $e \in A$. Assume that $x \in F_{(r, s, t)}(e)$. Since $F_{(r, s, t)}(e) = \{x \in U / T_{F(e)}(x) \geq r, I_{F(e)}(x) \geq s, F_{F(e)}(x) \leq t\}$, then we have that $T_{F(e)}(x) \geq r, I_{F(e)}(x) \geq s, F_{F(e)}(x) \leq t$. Since $T_{F(e)}(x) \leq T_{G(e)}(x), I_{F(e)}(x) \leq I_{G(e)}(x), F_{F(e)}(x) \geq F_{G(e)}(x)$, thus $T_{G(e)}(x) \geq r, I_{G(e)}(x) \geq s, F_{G(e)}(x) \leq t$. Hence, $x \in \{x \in U / T_{G(e)}(x) \geq r, I_{G(e)}(x) \geq s, F_{G(e)}(x) \leq t\}$. Since $G_{(r, s, t)}(e) = \{x \in U / T_{G(e)}(x) \geq r, I_{G(e)}(x) \geq s, F_{G(e)}(x) \leq t\}$, then we have $x \in G_{(r, s, t)}(e)$. Thus, we have that $F_{(r, s, t)}(e) \subseteq G_{(r, s, t)}(e)$. Consequently, $L(\varpi; r, s, t) \tilde{\subseteq} L(\zeta; r, s, t)$.

Note 3.5

In the definition of (r, s, t) - level soft sets of single valued neutrosophic soft sets, the level triplet (or threshold triplet) assigned to each parameter has always constant values $r, s, t \in [0,1]$. However, in some decision making problems, it may happen that decision makers would like to improve different threshold triplets on different parameters. To cope with such problems, we need to use a function instead of a constant value triplet as the thresholds on membership values, indeterministic values and non-membership values respectively.

Definition 3.6

Let $\varpi = \langle F, A \rangle$ be a single valued neutrosophic soft set over U , where $A \subseteq E$ and E is a set of parameters. Let $\lambda: A \rightarrow I^3$ ($I = [0,1]$) be a single valued neutrosophic set in A which is called a threshold single valued neutrosophic set. The level soft set of ϖ with respect to λ is a crisp soft set $L(\varpi; \lambda) = \langle F_\lambda, A \rangle$ defined by $F_\lambda(e) = L(F(e); \lambda(e)) = \{x \in U / T_{F(e)}(x) \geq T_\lambda(e), I_{F(e)}(x) \geq I_\lambda(e), F_{F(e)}(x) \leq F_\lambda(e)\}$, for all $e \in A$. To illustrate this idea, let us consider the following examples.

Example 3.7

Based on the single valued neutrosophic soft set $\varpi = \langle F, A \rangle$, we can define a single valued neutrosophic set $mid_\varpi: A \rightarrow [0,1]^3$, by

$$T_{mid_{\varpi}}(e) = \frac{1}{|U|} \sum_{x \in U} T_{F(e)}(x),$$

$$I_{mid_{\varpi}}(e) = \frac{1}{|U|} \sum_{x \in U} I_{F(e)}(x),$$

$$F_{mid_{\varpi}}(e) = \frac{1}{|U|} \sum_{x \in U} F_{F(e)}(x)$$

for all $e \in A$.

The single valued neutrosophic set mid_{ϖ} is called the mid-threshold single valued neutrosophic soft set ϖ . Further, the level soft set of ϖ with respect to the mid-threshold single valued neutrosophic set mid_{ϖ} , namely $L(\varpi; mid_{\varpi})$ is called the mid-level soft set of ϖ and simply denoted by $L(\varpi; mid)$.

Consider the problem in Example 3.2 with its tabular representation given by Table 1. It is clear that the mid-threshold of $\langle F, A \rangle$ is a single valued neutrosophic set

$$mid_{\langle F, A \rangle} = \{ \langle e_1, 0.7, 0.34, 0.13 \rangle, \langle e_2, 0.72, 0.25, 0.18 \rangle, \langle e_3, 0.68, 0.42, 0.17 \rangle, \langle e_4, 0.74, 0.42, 0.15 \rangle \}.$$

The mid-level soft set of $\langle F, A \rangle$ is a soft set $L(\langle F, A \rangle; mid)$ and its tabular representation is given by Table 3.

U	e_1	e_2	e_3	e_4
X ₁	0	0	0	0
X ₂	0	1	0	1
X ₃	1	1	1	1
X ₄	0	0	0	0
X ₅	0	0	0	0

Table 3: Tabular representation of mid-level soft set $L(\langle F, A \rangle; mid)$

Example 3.8

Let $\varpi = \langle F, A \rangle$ be a single valued neutrosophic soft set over U , where $A \subseteq E$ and E is a set of parameters. Then, we can define:

(i) a single valued neutrosophic set $topbottom_{\varpi} : A \rightarrow \mathbb{I}^3$

$$T_{topbottom_{\varpi}}(e) = \max_{x \in U} T_{F(e)}(x), I_{topbottom_{\varpi}}(e) = \max_{x \in U} I_{F(e)}(x),$$

$$F_{topbottom_{\varpi}}(e) = \min_{x \in U} F_{F(e)}(x) \text{ for all } e \in A.$$

(ii) a single valued neutrosophic set $toptop_{\varpi} : A \rightarrow \mathbb{I}^3$

$$T_{toptop_{\varpi}}(e) = \max_{x \in U} T_{F(e)}(x), I_{toptop_{\varpi}}(e) = \max_{x \in U} I_{F(e)}(x),$$

$$F_{toptop_{\varpi}}(e) = \max_{x \in U} F_{F(e)}(x) \text{ for all } e \in A.$$

(iii) a single valued neutrosophic set $bottombottom_{\varpi} : A \rightarrow \mathbb{I}^3$

$$T_{bottombottom_{\varpi}}(e) = \min_{x \in U} T_{F(e)}(x), I_{bottombottom_{\varpi}}(e) = \min_{x \in U} I_{F(e)}(x),$$

$$F_{bottombottom_{\varpi}}(e) = \min_{x \in U} F_{F(e)}(x) \text{ for all } e \in A, \text{ where } \mathbb{I} = [0, 1]$$

The single valued neutrosophic set $topbottom_{\varpi}$ is called the top-bottom-threshold of the single valued neutrosophic soft set ϖ , the single valued neutrosophic set $toptop_{\varpi}$ is called the top-top-threshold of the single valued neutrosophic soft set ϖ , the single valued neutrosophic set $bottombottom_{\varpi}$ is called the bottom-bottom-threshold of the single valued neutrosophic soft set ϖ .

In addition, the level soft set of ϖ with respect to the top-bottom-threshold of the single valued neutrosophic soft set ϖ , namely $L(\varpi; topbottom_{\varpi})$ is called the top-bottom-level soft set of ϖ and simply denoted by $L(\varpi; topbottom)$.

Similarly, the top-top-level soft set of ϖ is denoted by $L(\varpi; toptop)$ and the bottom-bottom-level soft set of ϖ is denoted by $L(\varpi; bottombottom)$.

Let us consider the problem in Example 3.2 with its tabular representation given by Table 1. Here,

$$topbottom_{\langle F, A \rangle} = \{ \langle e_1, 0.9, 0.4, 0.05 \rangle, \langle e_2, 0.9, 0.3, 0.05 \rangle, \langle e_3, 0.85, 0.5, 0.1 \rangle, \langle e_4, 0.9, 0.6, 0.1 \rangle \}$$

is a single valued neutrosophic set and the top-bottom-level soft set of $\langle F, A \rangle$ is $L(\langle F, A \rangle; topbottom)$, see below.

U	e_1	e_2	e_3	e_4
X ₁	0	0	0	0
X ₂	0	1	0	0
X ₃	1	0	1	1
X ₄	0	0	0	0
X ₅	0	0	0	0

Table 4: Tabular representation of top-bottom-level soft set $L(\langle F, A \rangle; topbottom)$

Also, the top-top-threshold of $\langle F, A \rangle$ is a single valued neutrosophic set $toptop_{\langle F, A \rangle} = \{ \langle e_1, 0.9, 0.4, 0.2 \rangle, \langle e_2, 0.9, 0.3, 0.4 \rangle, \langle e_3, 0.85, 0.5, 0.3 \rangle, \langle e_4, 0.9, 0.6, 0.2 \rangle \}$ and the top-top-level soft set of $\langle F, A \rangle$ is $L(\langle F, A \rangle; toptop)$.

Its tabular representation is given by Table 5.

U	e_1	e_2	e_3	e_4
X ₁	0	0	0	0
X ₂	0	1	0	0
X ₃	1	0	1	1
X ₄	0	0	0	0
X ₅	0	0	0	0

Table 5: Tabular representation of top-top-level soft set $L(\langle F, A \rangle; toptop)$

It is clear that the bottom-bottom-threshold of $\langle F, A \rangle$ is a single valued neutrosophic set *bottombottom* $\langle F, A \rangle = \{ \langle e_1, 0.5, 0.3, 0.05 \rangle, \langle e_2, 0.6, 0.2, 0.05 \rangle, \langle e_3, 0.5, 0.35, 0.1 \rangle, \langle e_4, 0.6, 0.3, 0.1 \rangle \}$ and the bottom-bottom level soft set of $\langle F, A \rangle$ is $L(\langle F, A \rangle; \text{bottombottom})$.

Its tabular representation is given by Table 6.

U	e_1	e_2	e_3	e_4
X ₁	0	0	1	0
X ₂	0	1	0	0
X ₃	1	1	1	1
X ₄	0	0	0	0
X ₅	0	0	0	1

Table 6: Tabular representation of bottom-bottom-level soft set $L(\langle F, A \rangle; \text{bottombottom})$

Remark 3.9

In Example 3.8, we do not define the bottom-top-level soft set of a single valued neutrosophic soft set, that is, we do not define the following single valued neutrosophic set *bottomtop* $\varpi: A \rightarrow I^3$,

$$T_{\text{bottomtop}\varpi}(e) = \min_{x \in U} T_{F(e)}(x), I_{\text{bottomtop}\varpi}(e) = \min_{x \in U} I_{F(e)}(x),$$

$$F_{\text{bottomtop}\varpi}(e) = \max_{x \in U} F_{F(e)}(x) \text{ for all } e \in A.$$

The reason is the following: The bottom-top threshold is dispensable since it indeed consists of a lower bound of the degree of membership and indeterministic values and together with an upperbound of the degree of non-membership values. Thus, the bottom-top-threshold can always be satisfied.

Let us consider the Example 3.2, where the bottom-top-threshold of $\langle F, A \rangle$ is a single valued neutrosophic set *bottomtop* $\langle F, A \rangle = \{ \langle e_1, 0.5, 0.3, 0.2 \rangle, \langle e_2, 0.6, 0.2, 0.4 \rangle, \langle e_3, 0.5, 0.35, 0.3 \rangle, \langle e_4, 0.6, 0.3, 0.2 \rangle \}$ and the bottom-top-level soft set of $\langle F, A \rangle$ is a soft set $L(\langle F, A \rangle; \text{bottomtop})$ with its tabular representation given by Table 7.

U	e_1	e_2	e_3	e_4
X ₁	1	1	1	1
X ₂	1	1	1	1
X ₃	1	1	1	1
X ₄	1	1	1	1
X ₅	1	1	1	1

Table 7: Tabular representation of bottom-top-level soft set $L(\langle F, A \rangle; \text{bottomtop})$

From Table 7, we can see that all the tabular entries are equal to 1. In other words, the bottom-top-threshold can always be satisfied.

Now, we show some properties of level soft sets with respect to a single valued neutrosophic soft set.

Theorem 3.10

Let $\varpi = \langle F, A \rangle$ be a single valued neutrosophic soft set over U , where $A \subseteq E$ and E is a set of parameters. Let $\lambda_1: A \rightarrow I^3$ ($I=[0,1]$) and $\lambda_2: A \rightarrow I^3$ ($I=[0,1]$) be two threshold single valued neutrosophic sets. $L(\varpi; \lambda_1) = \langle F_{\lambda_1}, A \rangle$ and $L(\varpi; \lambda_2) = \langle F_{\lambda_2}, A \rangle$ are the level soft sets of ϖ with respect to λ_1 and λ_2 , respectively. If $T_{\lambda_2}(e) \leq T_{\lambda_1}(e)$, $I_{\lambda_2}(e) \leq I_{\lambda_1}(e)$ and $F_{\lambda_2}(e) \geq F_{\lambda_1}(e)$, for all $e \in A$, then we have $L(\varpi; \lambda_1) \tilde{\subset} L(\varpi; \lambda_2)$.

Proof

The proof is similar to Theorem 3.3.

Theorem 3.11

Let $\varpi = \langle F, A \rangle$ and $\zeta = \langle G, A \rangle$ be two single valued neutrosophic soft sets over U , where $A \subseteq E$ and E is a set of parameters.

Let $\lambda: A \rightarrow I^3$ ($I=[0,1]$) be a threshold single valued neutrosophic set. $L(\varpi; \lambda) = \langle F_{\lambda}, A \rangle$ and $L(\zeta; \lambda) = \langle G_{\lambda}, A \rangle$ are the level soft sets of ϖ and ζ with respect to λ respectively. If $\varpi \tilde{\subset} \zeta$, then we have $L(\varpi; \lambda) \tilde{\subset} L(\zeta; \lambda)$.

Proof

The proof is similar to Theorem 3.4.

Theorem 3.12

Let $\varpi = \langle G, A \rangle$ be a single valued neutrosophic soft set over U , where $A \subseteq E$ and E be a set of parameters.

$$L(\varpi; \text{mid}), L(\varpi; \text{topbottom}), L(\varpi; \text{toptop}),$$

$L(\varpi; \text{bottombottom})$ are the mid-level soft set, the top-bottom-level soft set, the top-top-level soft set and the bottom-bottom-level soft set of ϖ , respectively. Then, we have the following properties:

- (i) $L(\varpi; \text{topbottom}) \tilde{\subset} L(\varpi; \text{mid})$.
- (ii) $L(\varpi; \text{topbottom}) \tilde{\subset} L(\varpi; \text{toptop})$.
- (iii) $L(\varpi; \text{topbottom}) \tilde{\subset} L(\varpi; \text{bottombottom})$.

Proof

(i) Let $L(\varpi; \text{topbottom}) = \langle G_{\text{topbottom}}, A \rangle$, where

$$T_{\text{topbottom}\varpi}(e) = \max_{x \in U} T_{G(e)}(x), I_{\text{topbottom}\varpi}(e) = \max_{x \in U} I_{G(e)}(x),$$

$$F_{\text{topbottom}\varpi}(e) = \min_{x \in U} F_{G(e)}(x) \text{ for all } e \in A.$$

Let $L(\varpi; \text{mid}) = \langle G_{\text{mid}}, A \rangle$, where

$$T_{mid_{\overline{\omega}}}(e) = \frac{1}{|U|} \sum_{x \in U} T_{G(e)}(x),$$

$$I_{mid_{\overline{\omega}}}(e) = \frac{1}{|U|} \sum_{x \in U} I_{G(e)}(x),$$

$$F_{mid_{\overline{\omega}}}(e) = \frac{1}{|U|} \sum_{x \in U} F_{G(e)}(x)$$

for all $e \in A$. Obviously, $A \subseteq A$.

In the following we will prove that for all $e \in A$.

$$G_{topbottom}(e) \subseteq G_{mid}(e).$$

Since $\max_{x \in U} T_{G(e)}(x) \geq \frac{1}{|U|} \sum_{x \in U} T_{G(e)}(x)$, $\max_{x \in U} I_{G(e)}(x) \geq$

$$\frac{1}{|U|} \sum_{x \in U} I_{G(e)}(x), F_{G(e)}(x) \leq \frac{1}{|U|} \sum_{x \in U} F_{G(e)}(x),$$

then for all $e \in A$ we have $T_{topbottom}(e) \geq T_{mid}(e)$, $I_{topbottom}(e) \geq I_{mid}(e)$, $F_{topbottom}(e) \leq F_{mid}(e)$. Thus, we have the following $\{x \in U \mid T_{G(e)}(x) \geq T_{topbottom}(e), I_{G(e)}(x) \geq I_{topbottom}(e), F_{G(e)}(x) \leq F_{topbottom}(e)\} \subseteq \{x \in U \mid T_{G(e)}(x) \geq T_{mid}(e), I_{G(e)}(x) \geq I_{mid}(e), F_{G(e)}(x) \leq F_{mid}(e)\}$. Since $G_{topbottom}(e) = \{x \in U \mid T_{G(e)}(x) \geq T_{topbottom}(e), I_{G(e)}(x) \geq I_{topbottom}(e), F_{G(e)}(x) \leq F_{topbottom}(e)\}$ and $G_{mid}(e) = \{x \in U \mid T_{G(e)}(x) \geq T_{mid}(e), I_{G(e)}(x) \geq I_{mid}(e), F_{G(e)}(x) \leq F_{mid}(e)\}$, then we have the following $G_{topbottom}(e) \subseteq G_{mid}(e)$. Therefore $L(\overline{\omega}; topbottom) \tilde{\subseteq} L(\overline{\omega}; mid)$.

Proof of (ii) and (iii) are analogous to proof (i).

Now, we show the adjustable approach to single valued neutrosophic soft sets based decision making by using level soft sets.

Algorithm 3.13

Step 1: Input the (resultant) single valued neutrosophic soft set $\overline{\omega} = \langle F, A \rangle$.

Step 2: Input the threshold single valued neutrosophic set $\lambda: A \rightarrow I^3$ ($I = [0, 1]$) (or give a threshold value triplet $(r, s, t) \in I^3$ ($I = [0, 1]$); or choose the mid-level decision rule; or choose the top-bottom-level decision rule; or choose the top-top-level decision rule; or choose the bottom-bottom-level decision rule) for decision making.

Step 3: Compute the level soft set $L(\overline{\omega}; \lambda)$ with the threshold single valued neutrosophic set λ (or the (r, s, t) -level soft set $L(\overline{\omega}; r, s, t)$; or the mid-level soft set $L(\overline{\omega}; mid)$; or choose the top-bottom-level soft set $L(\overline{\omega}; topbottom)$; or choose the top-top-level soft set $L(\overline{\omega}; toptop)$; or choose the bottom-bottom-level soft set $L(\overline{\omega}; bottombottom)$)

Step 4: Present the level soft $L(\overline{\omega}; \lambda)$ (or $L(\overline{\omega}; r, s, t)$; $L(\overline{\omega}; mid)$; $L(\overline{\omega}; topbottom)$, $L(\overline{\omega}; bottombottom)$) in tabular form and compute the choice value c_i of o_i , for all i .

Step 5: The optimal decision is to select o_k if $c_k = \max_i c_i$.

Step 6: If k has more than one value, then any of o_k may be chosen.

Note 3.14

In the last step of Algorithm 3.13, one may go back to the second step and change the previously used threshold (or decision rule), as to adjust the final optimal decision, especially when there are too many ‘‘optimal choices’’ to be chosen.

To illustrate the basic idea of Algorithm 3.13, let us consider the following example.

Example 3.15

Let us consider the decision making problem (Example 3.2) involving the single valued neutrosophic soft set $\overline{\omega} = \langle F, A \rangle$ with its tabular representation given by Table 1.

If we deal with this problem by mid-level decision rule, we shall use the mid-threshold $mid_{\langle F, A \rangle}$ and thus obtain the mid-level soft set $L(\langle F, A \rangle, mid)$ with choice values having their tabular representation in Table 8.

U	e_1	e_2	e_3	e_4	Choice values
X ₁	0	0	0	0	$c_1=0$
X ₂	0	1	0	1	$c_2=2$
X ₃	1	1	1	1	$c_3=4$
X ₄	0	0	0	0	$c_4=0$
X ₅	0	0	0	0	$c_5=0$

Table 8: Tabular representation of mid-level soft set $L(\langle F, A \rangle, mid)$ with choice values

From Table 8, it follows that the maximum choice value is $c_3=4$, so the optimal decision is to select X_3 .

At the same time, if we deal with this problem by top-bottom-level soft set $L(\langle F, A \rangle, topbottom)$ we obtain the choice values given by Table 9.

U	e_1	e_2	e_3	e_4	Choice values
X ₁	0	0	0	0	$c_1=0$
X ₂	0	1	0	0	$c_2=1$
X ₃	1	0	1	1	$c_3=3$
X ₄	0	0	0	0	$c_4=0$
X ₅	0	0	0	0	$c_5=0$

Table 9: Tabular representation of top-bottom-level soft set $L(\langle F, A \rangle, topbottom)$ with choice values

From Table 9, it is clear that the maximum choice value is $c_3=3$, so the optimal decision is to select X_3 .

4 Weighted single valued neutrosophic soft sets based decision making

In this section, we will present an adjustable approach to weighted single valued neutrosophic soft sets based decision making problems.

Definition 4.1

Let $FN(U)$ be the set of all single valued neutrosophic sets in the universe U . Let $A \subseteq E$ and E be a set of parameters. A weighted single valued neutrosophic soft set is a triple $\xi = \langle F, A, \omega \rangle$, where $\langle F, A \rangle$ is a single valued neutrosophic soft set over U , $\omega: A \rightarrow [0,1]$ is a weight function specifying the weight $w_j = \omega(e_j)$ for each attribute $e_j \in A$.

By definition, every single valued neutrosophic soft set can be considered as a weighted fuzzy soft set. The notion of weighted single valued neutrosophic soft sets provides a mathematical framework for modelling and analyzing the decision making problems in which all the choice parameters may not be of equal importance. These differences between the importance of parameters are characterized by the weight function in a weighted single valued neutrosophic soft set.

Algorithm 4.2 (an adjustable approach to weighted single valued neutrosophic soft sets based decision making problems)

Step 1: Input the weighted single valued neutrosophic soft set $\xi = \langle F, A, \omega \rangle$.

Step 2: Input the threshold single valued neutrosophic set $\lambda: A \rightarrow I^3$ (or give a threshold value triplet $(r, s, t) \in I^3$; or choose the mid-level decision rule; or choose the top-bottom-level decision rule; or choose the top-top-level decision rule; or choose the bottom-bottom-level decision rule) for decision making.

Step 3: Compute the level soft set $L(\langle F, A \rangle; \lambda)$ of ξ with respect to the threshold single valued neutrosophic set λ (or the (r, s, t) -level soft set $L(\langle F, A \rangle; r, s, t)$; or the mid-level soft set $L(\langle F, A \rangle; mid)$; or choose the top-bottom-level soft set $L(\langle F, A \rangle; topbottom)$; or choose the top-top-level soft set $L(\langle F, A \rangle; toptop)$; or choose the bottom-bottom-level soft set $L(\langle F, A \rangle; bottombottom)$).

Step 4: Present the level soft $L(\langle F, A \rangle; \lambda)$ (or $L(\langle F, A \rangle; r, s, t)$; $L(\langle F, A \rangle; mid)$; $L(\langle F, A \rangle; topbottom)$, $L(\langle F, A \rangle; bottombottom)$) in tabular form and compute the choice value c'_i of o_i , for all i .

Step 5: The optimal decision is to select o_k if $c'_k = \max_i c'_i$.

Step 6: If k has more than one value then any of o_k may be chosen.

Note 4.3

In the last step of Algorithm 4.2, one may go back to the second step and change the previously used threshold (or decision rule), as to adjust the final optimal decision, especially when there are too many “optimal choices” to be chosen.

To illustrate the basic idea of Algorithm 4.2, let us consider the following example.

Example 4.3

Let us consider the decision making problem (Example 3.2). Suppose that Mr. X has imposed the following weights for the parameters in A : for the parameter “branded”, $w_1=0.8$, for the parameter “expensive”, $w_2=0.6$, for the parameter “cooling speed”, $w_3=0.9$, and for the parameter “after sale product service”, $w_4=0.7$. Thus, we have a weight function $\omega: A \rightarrow [0,1]$, and the single valued neutrosophic soft set $\varpi = \langle F, A \rangle$ in Example 3.2 is changed into a weighted single valued neutrosophic soft set $\xi = \langle F, A, \omega \rangle$. Its tabular representation is given by Table 10.

U	$e_1, w_1=0.8$	$e_2, w_2=0.6$	$e_3, w_3=0.9$	$e_4, w_4=0.7$
X ₁	(0.7,0.3,0.1)	(0.6,0.25,0.1)	(0.75,0.35,0.1)	(0.65,0.3,0.2)
X ₂	(0.8,0.3,0.1)	(0.9,0.3,0.05)	(0.7,0.4,0.15)	(0.85,0.5,0.15)
X ₃	(0.9,0.4,0.05)	(0.8,0.3,0.05)	(0.85,0.5,0.1)	(0.9,0.6,0.1)
X ₄	(0.6,0.3,0.2)	(0.6,0.2,0.4)	(0.5,0.4,0.3)	(0.7,0.4,0.2)
X ₅	(0.5,0.4,0.2)	(0.7,0.2,0.3)	(0.6,0.45,0.2)	(0.6,0.3,0.1)

Table 10: Tabular representation of weighted single valued neutrosophic soft set $\xi = \langle F, A, \omega \rangle$.

As an adjustable approach, one can use different rules in decision making problem. For example, if we deal with this problem by mid-level decision rule, we shall use the mid-threshold $mid_{\langle F, A \rangle}$ and thus obtain the mid-level soft set $L(\langle F, A \rangle, mid)$ with weighted choice values having tabular representation in Table 11.

U	$e_1, w_1=0.8$	$e_2, w_2=0.6$	$e_3, w_3=0.9$	$e_4, w_4=0.7$	weighted choice value
X ₁	0	0	0	0	$c'_1=0$
X ₂	0	1	0	1	$c'_2=1.3$
X ₃	1	1	1	1	$c'_3=3.2$
X ₄	0	0	0	0	$c'_4=0$
X ₅	0	0	0	0	$c'_5=0$

Table 11: Tabular representation of mid-level soft set $L(\langle F, A \rangle; mid)$ with weighted choice values

It follows that the maximum weighted choice value is $c'_3=3.2$, so the optimal decision is to select X_3 .

5 Mean potentiality approach

Definition 5.1

The potentiality of a single valued neutrosophic soft set (p_{fns}) is defined as the sum of all membership, indeterministic and non-membership values of all objects with respect to all parameters. Mathematically, it is defined as

$$p_{fns} = \left(\sum_{i=1}^m \sum_{j=1}^n T_{ij}, \sum_{i=1}^m \sum_{j=1}^n I_{ij}, \sum_{i=1}^m \sum_{j=1}^n F_{ij} \right)$$

where T_{ij} , I_{ij} , F_{ij} are the membership, indeterministic and non-membership values of the i^{th} object with respect to the j^{th} parameter respectively, m is the number of objects and n is the number of parameters.

Definition 5.2

The mean potentiality (m_p) of the single valued neutrosophic soft set is defined as its average weight among the total potentiality. Mathematically, it is defined as

$$m_p = \frac{p_{fns}}{m \times n}$$

Algorithm 5.3

Step 1: Input the (resultant) single valued neutrosophic soft set $\varpi = \langle F, A \rangle$.

Step 2: Compute the potentiality (p_{fns}) of the single valued neutrosophic soft set.

Step 3: Find out the mean potentiality (m_p) of the single valued neutrosophic soft set.

Step 4: Form m_p -level soft set of the single valued neutrosophic soft set in tabular form, then compute the choice value c_i of o_i , for all i .

Step 5: The optimal decision is to select o_k if $c_k = \max_i c_i$.

Step 6: If k has more than one value, then any of o_k may be chosen.

Example 5.4

Let us consider the problem in Example 3.2 with its tabular representation in Table 1.

U	e_1	e_2	e_3	e_4	Choice value
X ₁	(0.7,0.3,0.1)	(0.6,0.25,0.1)	(0.75,0.35,0.1)	(0.65,0.3,0.2)	(2.7,1.2,0.5)
X ₂	(0.8,0.3,0.1)	(0.9,0.3,0.05)	(0.7,0.4,0.15)	(0.85,0.5,0.15)	(3.25,1.5,0.45)
X ₃	(0.9,0.4,0.05)	(0.8,0.3,0.05)	(0.85,0.5,0.1)	(0.9,0.6,0.1)	(3.45,1.8,0.3)
X ₄	(0.6,0.3,0.2)	(0.6,0.2,0.4)	(0.5,0.4,0.3)	(0.7,0.4,0.2)	(2.4,1.3,1.1)
X ₅	(0.5,0.4,0.2)	(0.7,0.2,0.3)	(0.6,0.45,0.2)	(0.6,0.3,0.1)	(2.4,1.35,0.8)

Table 12: Tabular representation of single valued neutrosophic soft set with choice values.

So, the potentiality is $p_{fns} = (14.2, 7.15, 3.15)$.

The Mean potentiality $m_p = \frac{p_{fns}}{m \times n}$ is:

$$m_p = \left(\frac{14.2}{5 \times 4}, \frac{7.15}{5 \times 4}, \frac{3.15}{5 \times 4} \right) = (0.71, 0.36, 0.16).$$

Using this triplet, we can form the m_p -level soft set, which is shown by Table 13.

U	e_1	e_2	e_3	e_4	Choice values
X ₁	0	0	0	0	$c_1=0$
X ₂	0	0	0	1	$c_2=1$
X ₃	1	0	1	1	$c_3=3$
X ₄	0	0	0	0	$c_4=0$
X ₅	0	0	0	0	$c_5=0$

Table 13: Tabular representation of m_p -level soft set with choice values.

From Table 13, it is clear that the maximum choice value is $c_3=3$, so the optimal decision is to select X_3 .

Conclusion

In this paper, we introduced an adjustable and mean potentiality approach by means of neutrosophic level soft sets. Different level soft sets were derived by considering different types of thresholds, namely, *mid*, *topbottom*, *top-top*, *bottombottom*. In general, the final optimal decisions based on different level soft sets could be different. Thus, the approach discussed in this paper captures an important feature for decision making in an imprecise environment. Some of these problems are essentially humanistic, and thus, subjective in nature; there actually isn't a unique or uniform criterion for evaluating the alternatives. Hence, the decision making models presented in this paper make the approaches to single valued neutrosophic level soft sets based decision making more appropriate for many real world applications.

References

- [1] H. Aktas, N. Cagman. Soft sets and soft groups. Inform. Sci. 177 (13), (2007), pp. 2726–2735.
- [2] Anjan Mukherjee, Ajoy Kanti Das, Abhijit Saha. Interval valued intuitionistic fuzzy soft topological spaces. In: Annals of Fuzzy Mathematics and Informatics, Volume 6, No. 3, (November 2013), pp. 689-70.
- [3] I. Arockiarani, J. Martina Jency. More on Fuzzy Neutrosophic Sets and Fuzzy Neutrosophic Topological Spaces. International journal of innovative research and studies, May (2014), vol. 3, Issue 5, pp. 643-652.

- [4] I. Arockiarani, I.R. Sumathi, J. Martina Jency. Fuzzy Neutrosophic Soft Topological Spaces. *IJMA*, 4(10), 2013, pp. 225-238.
- [5] K. Atanassov. Intuitionistic fuzzy sets. *Fuzzy Sets Syst.* 20 (1) (1986), pp. 87–96.
- [6] K. Atanassov. *Intuitionistic Fuzzy Sets*. Physica Verlag, Heidelberg/New York, 1999.
- [7] N. Cagman, S. Enginoglu. Soft matrix theory and its decision making. *Comp. Math. Appl.* 59 (10), (2010), pp. 3308–3314.
- [8] N. Cagman, S. Enginoglu. Soft set theory and uni–int decision making. *Eur. J. Oper. Res.* 207 (2), (2010), pp. 848–855.
- [9] F. Feng, Y.B. Jun, X. Liu, L. Li. An adjustable approach to fuzzy soft set based decision making. *J. Comput. Appl. Math.* 234 (1), (2010), pp. 10–20.
- [10] F. Feng, C. Li, B. Davvaz, M.I. Ali. Soft sets combined with fuzzy sets and rough sets: a tentative approach. *Soft Comput.* 14 (9), (2010), pp. 899–911.
- [11] Haibin Wang, Florentin Smarandache, Yanqing Zhang, Rajshekhar Sunderraman. Single valued neutrosophic sets. *Technical sciences and applied Mathematics*. October 2012, pp. 10-14.
- [12] Y. Jiang, Y. Tang, Q. Chen, H. Liu, J. Tang. Interval-valued intuitionistic fuzzy soft sets and their properties. *Comput. Math. Appl.* 60 (3), (2010), pp. 906–918.
- [13] Z. Kong, L. Gao, L. Wang. Comment on “A fuzzy soft set theoretic approach to decision making problems”. *J. Comput. Appl. Math.* 223 (2), (2009), pp. 540–542.
- [14] P.K. Maji, R. Biswas, A.R. Roy. Soft set theory. *Comput. Math. Appl.* 45 (4–5), (2003), pp. 555–562.
- [15] P.K. Maji, A.R. Roy, R. Biswas. An application of soft sets in a decision making problem. *Comput. Math. Appl.* 44 (8–9), (2002), pp. 1077–1083.
- [16] P.K. Maji, R. Biswas, A.R. Roy. Fuzzy soft sets. *J. Fuzzy Math.* 9 (3), (2001), pp. 589–602.
- [17] P.K. Maji, R. Biswas, A.R. Roy. Intuitionistic fuzzy soft sets. *J. Fuzzy Math.* 9 (3), (2001), pp. 677–692.
- [18] P.K. Maji, A.R. Roy, R. Biswas. On intuitionistic fuzzy soft sets. *J. Fuzzy Math.* 12 (3), (2004), pp. 669–683.
- [19] P.K. Maji. More on intuitionistic fuzzy soft sets. In: *Proceedings of the 12th International Conference on Rough Sets, Fuzzy Sets, Data Mining and Granular Computing (RSFD-GrC 2009)*. In: H. Sakai, M.K. Chakraborty, A.E. Hassanien, D. Slezak, W. Zhu (Eds.), *Lecture Notes in Computer Science*, 5908, Springer, 2009, pp. 231–240.
- [20] P. Majumdar, S.K. Samanta. Generalized fuzzy soft sets. *Comput. Math. Appl.* 59 (4), (2010), pp. 1425–1432.
- [21] D. Molodtsov. Soft set theory – first results. *Comput. Math. Appl.* 37 (4–5), (1999), pp. 19–31.
- [22] Pabitra Kumar Maji. Neutrosophic soft set. In: *Annals of Fuzzy Mathematics and Informatics*, Volume 5, No.1, (2013), pp. 157-168.
- [23] A.R. Roy, P.K. Maji. A fuzzy soft set theoretic approach to decision making problems. *J. Comput. Appl. Math.* 203 (2), (2007), pp. 412–418.
- [24] M. Shabir and M. Naz. On soft topological spaces. *Comput. Math. Appl.* 61 (2011), pp. 1786-1799.
- [25] T. Simsekler and S. Yuksel. Fuzzy soft topological spaces, *Ann. Fuzzy Math. Inform.* 5 (1), (2013), pp. 87-96.
- [26] B. Tanay and M. B. Kandemir. Topological structure of fuzzy soft sets. *Comput. Math. Appl.* 61 (2011), pp. 2952-2957.
- [27] F. Smarandache. *A Unifying Field in Logics. Neutrosophy: Neutrosophic Probability, Set and Logic*. Rehoboth: American Research Press (Fourth edition), 1998.
- [28] F. Smarandache. *Neutrosophy and Neutrosophic Logic*. First International Conference on Neutrosophy, Neutrosophic Logic, Set, Probability and Statistics. University of New Mexico, Gallup, NM 87301, USA (2002).
- [29] F. Smarandache. Neutrosophic set, a generalization of the intuitionistic fuzzy sets. *Inter. J. Pure Appl. Math.*, 24 (2005), 287 – 297.
- [30] X.B. Yang, D.J. Yu, J.Y. Yang, C. Wu. Generalization of soft set theory: from crisp to fuzzy case. In: *Proceedings of the Second International Conference on Fuzzy Information and Engineering*. In: B.Y. Cao (Ed.), *Advance on Soft Computing*, 40, Springer Verlag, 2007, pp. 345–354.
- [31] L.A. Zadeh. Fuzzy sets. *Inform. Control* 8 (3), (1965), pp. 338–353.
- [32] Y. Zou, Z. Xiao. Data analysis approaches of soft sets under incomplete information. *Knowledge-based syst.* 21 (8), (2008), pp. 941-945.

Received: Feb. 10, 2016. Accepted: Mar. 22, 2016



An extended grey relational analysis based multiple attribute decision making in interval neutrosophic uncertain linguistic setting

Partha Pratim Dey¹, Surapati Pramanik^{2*}, and Bibhas C. Giri³

¹ Department of Mathematics, Jadavpur University, Kolkata – 700032, India. E-mail: parsur.fuzz@gmail.com

^{2*} Department of Mathematics, Nandalal Ghosh B.T. College, Panpur, P.O. –Narayanpur, District – North 24 Parganas, West Bengal, PIN – 743126, India. E-mail: sura_pati@yahoo.co.in

³ Department of Mathematics, Jadavpur University, Kolkata – 700032, India. E-mail: bcgiri.jumath@gmail.com

*Corresponding author's email ²:sura_pati@yahoo.co.in

Abstract. This paper investigates an extended grey relational analysis method for multiple attribute decision making problems under interval neutrosophic uncertain linguistic environment. Interval neutrosophic uncertain linguistic variables are hybridization of uncertain linguistic variables and interval neutrosophic sets and they can easily express the imprecise, indeterminate and inconsistent information which normally exist in real life situations. The rating of performance values of the alternatives with respect to the attributes is provided by the decision maker in terms of interval neutrosophic uncertain

linguistic variables in the decision making situation. The weights of the attributes have been assumed to be incompletely known or completely unknown to the decision maker and the weights have been calculated by employing different optimization models. Then, an extended grey relational analysis method has been proposed to determine the ranking order of all alternatives and select the best one. Finally, a numerical example has been solved to check the validity and applicability of the proposed method and compared with other existing methods in the literature.

Keywords: Multiple attribute decision making, Interval neutrosophic set, Interval neutrosophic uncertain linguistic variables, Grey relational analysis.

1 Introduction

Multiple attribute decision making (MADM) is a procedure for a decision maker (DM) to get the most desirable alternative from a set of feasible alternatives with respect to some predefined attributes. MADM, an important decision making apparatus have been applied in many kinds of practical fields such as engineering technology, economics, operations research, management science, military, urban planning, etc. However, in real decision making, due to time pressure, complexity of knowledge or data, ambiguity of people's thinking, the performance values of the alternatives regarding the attributes cannot always be represented by crisp values and it is reasonable to describe them by fuzzy information. Zadeh [1] proposed the notion of fuzzy set theory by incorporating the degree of membership to deal with impreciseness. Atanassov [2] extended the concept of Zadeh [1] and defined intuitionistic fuzzy set by introducing the degree of non-membership in dealing with vagueness and uncertainty. However, in many real world

decisions making, we often encounter with indeterminate and inconsistent information about alternatives with respect to attributes. In order to handle indeterminate and inconsistent information, the theory of neutrosophic set was incorporated by Smarandache [3-6] by introducing the degree of indeterminacy or neutrality as an independent component. After the ground-breaking work of Smarandache [3-6], Wang et al. [7] proposed single valued neutrosophic set (SVNS) from real scientific and engineering point of view. Wang et al. [8] introduced interval neutrosophic set (INS) which is more realistic and flexible than neutrosophic set and it is characterized by the degree of membership, degree of non-membership and a degree of indeterminacy, and they are intervals rather than real numbers.

In interval neutrosophic decision making environment, Chi and Liu [9] proposed extended technique for order preference by similarity to ideal solution (TOPSIS) method for solving MADM problems in which the attribute weights are unknown and attribute values are expressed in

terms of INSs. Ye [10] defined Hamming and Euclidean distances between INSs and proposed a multi-criteria decision making (MCDM) method based on the distance based similarity measures. Broumi and Smarandache [11] defined a new cosine similarity between two INSs based on Bhattacharya's distance [12] and applied the concept to a pattern recognition problem. Zhang et al. [13] developed two interval neutrosophic number aggregation operators for solving MCDM problems. Liu and Shi [14] defined some aggregation operators for interval neutrosophic hesitant fuzzy information and developed a decision making method for MADM problems. Zhang et al. [15] further proposed several outranking relations on interval neutrosophic numbers (INNs) based on ELETRE IV and established an outranking approach for MCDM problems using INNs. Ye [16] investigated an improved cross entropy measures for SVNNS and extended it to INSs. Then, the proposed cross entropy measures of SVNNS and INSs are employed to MCDM problems. Şahin and Liu [17] developed a maximizing deviation method for MADM problems with interval-valued neutrosophic informations. Tian et al. [18] explored a novel and comprehensive approach for MCDM problems based on a cross entropy with INSs. Mondal and Pramanik [19] developed cosine, Dice and Jaccard similarity measures based on interval rough neutrosophic sets and developed MADM methods based on the proposed similarity measures. Ye [20] defined a credibly-induced interval neutrosophic weighted arithmetic averaging operator and a credibly-induced interval neutrosophic weighted geometric averaging operator and established their properties. In the same study, Ye [20] also presented the projection measure between INNs the projection measure based ranking method for solving MADM problems with interval neutrosophic information and credibility information.

Deng [21] initiated grey relational analysis (GRA) method which has been applied widely for solving many MADM problems [22-34] in diverse decision making environments. GRA has been identified as an important decision making device for dealing with the problems with complex interrelationship between various aspects and variables [25-27]. Biswas et al. [28] first studied GRA technique to MADM problems with single valued neutrosophic assessments in which weights of the attributes are completely unknown. Biswas et al. [29] further proposed an improved GRA method for MADM problems under neutrosophic environment. They formulated a deviation based optimization model to find incompletely known attribute weights. They also established an optimization model by using Lagrange functions to compute completely unknown attribute weights. Mondal and Pramanik [30] studied rough neutrosophic MADM through GRA method. Pramanik and Mondal [32] proposed a GRA method for interval neutro-

sophic MADM problems where the unknown attribute weights are obtained by using information entropy method. Recently, Dey et al. [34] developed an extended GRA based interval neutrosophic MADM for weaver selection in Khadi institution.

Ye [35] introduced interval neutrosophic linguistic variables by combining linguistic variables and the idea of INSs. In the same study Ye [35] proposed aggregation operators for interval neutrosophic linguistic information and presented a decision making method for MADM problems. Broumi et al. [36] studied an extended TOPSIS method for MADM problems where the attribute values are described in terms of interval neutrosophic uncertain linguistic information and attribute weights are unknown. However, literature review reveals that there has been no work on extending GRA with interval neutrosophic uncertain linguistic information. In this study, we have developed a new GRA method for MADM problems under interval neutrosophic uncertain linguistic assessments where the information about attribute weights are partially known or completely unknown to the DM.

Rest of the paper is designed as follows; In Section 2, we have summarized some basic concepts which are essential for the presentation of the paper. Section 3 has been devoted to develop an extended GRA method for solving MADM problems under interval neutrosophic uncertain linguistic information where the information about attribute weights is partially known or completely unknown. In Section 4, an algorithm of the proposed method has been presented. In Section 5, we have solved a MADM problem to validate the developed method and compared the results with the results of other accessible methods in the literature. Finally, the last Section 6 concludes the paper with future scope of research.

2 Preliminaries

In the Section, we present several concepts regarding neutrosophic sets, single-valued neutrosophic sets, interval neutrosophic sets, uncertain linguistic variable, interval linguistic neutrosophic set, and interval neutrosophic uncertain linguistic set.

2.1 Neutrosophic set

Definition 2.1 [3-6]: Let U be a space of objects, then a neutrosophic set N is defined as follows:

$$N = \{x, \langle T_N(x), I_N(x), F_N(x) \rangle \mid x \in U\} \quad (1)$$

where, $T_N(x) : U \rightarrow]0, 1^+[$; $I_N(x) : U \rightarrow]0, 1^+[$; $F_N(x) : U \rightarrow]0, 1^+[$ are the truth-membership function, indeterminacy-membership function, and falsity-membership function, respectively with the condition

$$0 \leq \sup T_N(x) + \sup I_N(x) + \sup F_N(x) \leq 3^+.$$

2.2 Single – valued neutrosophic set

Definition 2.2 [7]: Assume U be a universal space of objects with generic element in U represented by x , then a SVNS $S \subset U$ is defined as follows:

$$S = \{x, \langle T_S(x), I_S(x), F_S(x) \rangle \mid x \in U\} \quad (2)$$

where, $T_S(x); I_S(x); F_S(x) : U \rightarrow [0, 1]$ are the degree of truth-membership, the degree of indeterminacy-membership, and the degree of falsity-membership respectively of the element $x \in U$ to the set S with the condition $0 \leq T_S(x) + I_S(x) + F_S(x) \leq 3$.

2.3 Interval neutrosophic set

Definition 2.3 [8]: Assume that U be a universal space of points with generic element in U denoted by x . Then an INS A is defined as follows:

$$A = \{x, \langle T_A(x), I_A(x), F_A(x) \rangle \mid x \in U\} \quad (3)$$

where, $T_A(x), I_A(x), F_A(x)$ are the truth-membership function, indeterminacy-membership function, and falsity-membership function, respectively with $T_A(x), I_A(x), F_A(x) \subseteq [0, 1]$ for each point $x \in U$ and $0 \leq \sup T_A(x) + \sup I_A(x) + \sup F_A(x) \leq 3$. For convenience, an INN is represented by $\tilde{a} = ([T^-, T^+], [I^-, I^+], [F^-, F^+])$.

2.4 Uncertain linguistic variable

A linguistic set $P = (p_0, p_1, p_2, \dots, p_{u-1})$ is a finite and completely ordered discrete term set, where u is odd. For example, when $u = 7$, the linguistic term set P can be defined as given below [36].

$P = \{p_0$ (extremely low); p_1 (very low); p_2 (low); p_3 (medium); p_4 (high); p_5 (very high); p_6 (extremely high)}.

Definition 2.4 [36]: Let $\tilde{p} = [p_\alpha, p_\beta]$, where $p_\alpha, p_\beta \in \tilde{P}$ with $\alpha \leq \beta$ be respectively the lower and upper limits of P , then, \tilde{p} is said to be an uncertain linguistic variable.

Definition 2.5 [36]: Consider $\tilde{p}_1 = [p_{\alpha_1}, p_{\beta_1}]$ and $\tilde{p}_2 = [p_{\alpha_2}, p_{\beta_2}]$ be two uncertain linguistic variables, then the distance between \tilde{p}_1 and \tilde{p}_2 is defined as given below.

$$D(\tilde{p}_1, \tilde{p}_2) = \frac{1}{2(u-1)} (|\alpha_2 - \alpha_1| + |\beta_2 - \beta_1|) \quad (4)$$

2.5 Interval neutrosophic linguistic set

Ye [35] proposed interval neutrosophic linguistic set based on interval neutrosophic set and linguistic variables.

Definition 2.6 [35]: An interval neutrosophic linguistic set L in U is defined as follows:

$$L = \{x, \langle p_{\varphi(x)}, \langle T_L(x), I_L(x), F_L(x) \rangle \mid x \in U\} \quad (5)$$

where $T_L(x) = [T_L^-(x), T_L^+(x)] \subseteq [0, 1]$, $I_L(x) = [I_L^-(x), I_L^+(x)] \subseteq [0, 1]$, $F_L(x) = [F_L^-(x), F_L^+(x)] \subseteq [0, 1]$ denote respectively, truth-membership degree, indeterminacy-membership degree, and falsity-membership degree of the element x in U to the linguistic variable $p_{\varphi(x)} \in \hat{p}$ with the condition

$$0 \leq T_L^+(x) + I_L^+(x) + F_L^+(x) \leq 3.$$

2.6 Interval neutrosophic uncertain linguistic set

Broumi et al. [36] extended the concept of interval neutrosophic linguistic set [35] and proposed interval neutrosophic uncertain linguistic set based on interval neutrosophic set and uncertain linguistic variables.

Definition 2.7 [36]: An interval neutrosophic uncertain linguistic set C in U is defined as follows:

$$C = \{x, [p_{\varphi(x)}, p_{\psi(x)}], \langle T_C(x), I_C(x), F_C(x) \rangle \mid x \in U\} \quad (6)$$

where $T_C(x) = [T_C^-(x), T_C^+(x)] \subseteq [0, 1]$, $I_C(x) = [I_C^-(x), I_C^+(x)] \subseteq [0, 1]$, $F_C(x) = [F_C^-(x), F_C^+(x)] \subseteq [0, 1]$ represent respectively, truth-membership degree, indeterminacy-membership degree, and falsity-membership degree of the element x in U to the uncertain linguistic variable $[p_{\varphi(x)}, p_{\psi(x)}]$ with the condition

$$0 \leq T_C^+(x) + I_C^+(x) + F_C^+(x) \leq 3.$$

Definition 2.8 [36]: Consider $\tilde{a}_1 = \langle [p_{\varphi(\tilde{a}_1)}, p_{\psi(\tilde{a}_1)}], ([T^-(\tilde{a}_1), T^+(\tilde{a}_1)], [I^-(\tilde{a}_1), I^+(\tilde{a}_1)], [F^-(\tilde{a}_1), F^+(\tilde{a}_1)]) \rangle$ and $\tilde{a}_2 = \langle [p_{\varphi(\tilde{a}_2)}, p_{\psi(\tilde{a}_2)}], ([T^-(\tilde{a}_2), T^+(\tilde{a}_2)], [I^-(\tilde{a}_2), I^+(\tilde{a}_2)], [F^-(\tilde{a}_2), F^+(\tilde{a}_2)]) \rangle$ be two interval neutrosophic uncertain linguistic variables (INULVs) and $\mu \geq 0$, then the operational laws of INULVs are defined as given below.

- $\tilde{a}_1 \oplus \tilde{a}_2 = \langle [p_{\varphi(\tilde{a}_1)+\varphi(\tilde{a}_2)}, p_{\psi(\tilde{a}_1)+\psi(\tilde{a}_2)}], ([T^-(\tilde{a}_1) + T^-(\tilde{a}_2) - T^-(\tilde{a}_1) \cdot T^-(\tilde{a}_2), T^+(\tilde{a}_1) + T^+(\tilde{a}_2) - T^+(\tilde{a}_1) \cdot T^+(\tilde{a}_2)], [I^-(\tilde{a}_1) \cdot I^-(\tilde{a}_2), I^+(\tilde{a}_1) \cdot I^+(\tilde{a}_2)], [F^-(\tilde{a}_1) \cdot F^-(\tilde{a}_2), F^+(\tilde{a}_1) \cdot F^+(\tilde{a}_2)]) \rangle$
- $\tilde{a}_1 \otimes \tilde{a}_2 = \langle [p_{\varphi(\tilde{a}_1) \times \varphi(\tilde{a}_2)}, p_{\psi(\tilde{a}_1) \times \psi(\tilde{a}_2)}], ([T^-(\tilde{a}_1) \cdot T^-(\tilde{a}_2), T^+(\tilde{a}_1) \cdot T^+(\tilde{a}_2)], [I^-(\tilde{a}_1) + I^-(\tilde{a}_2) - I^-(\tilde{a}_1) \cdot I^-(\tilde{a}_2), I^+(\tilde{a}_1) + I^+(\tilde{a}_2) - I^+(\tilde{a}_1) \cdot I^+(\tilde{a}_2)], [F^-(\tilde{a}_1) + F^-(\tilde{a}_2) - F^-(\tilde{a}_1) \cdot F^-(\tilde{a}_2), F^+(\tilde{a}_1) + F^+(\tilde{a}_2) - F^+(\tilde{a}_1) \cdot F^+(\tilde{a}_2)]) \rangle$
- $\mu \cdot \tilde{a}_1 = \langle [p_{\mu \varphi(\tilde{a}_1)}, p_{\mu \psi(\tilde{a}_1)}], ((1 - (1 - T^-(\tilde{a}_1))^\mu), 1 - (1 - T^+(\tilde{a}_1))^\mu), [(I^-(\tilde{a}_1))^\mu, (I^+(\tilde{a}_1))^\mu], [(F^-(\tilde{a}_1))^\mu, (F^+(\tilde{a}_1))^\mu] \rangle$

$$4. \tilde{a}_1^\mu = \langle [p_{\phi^\mu(\tilde{a}_1)}, p_{\psi^\mu(\tilde{a}_1)}], ((T^-(\tilde{a}_1))^\mu, (T^+(\tilde{a}_1))^\mu), [1 - (1 - I^-(\tilde{a}_1))^\mu, 1 - (1 - I^+(\tilde{a}_1))^\mu], [1 - (1 - F^-(\tilde{a}_1))^\mu, 1 - (1 - F^+(\tilde{a}_1))^\mu] \rangle.$$

Definition 2.9 [36]: Consider $\tilde{p}_1 = \langle [p_{\alpha_1}, p_{\beta_1}], ((T_A^-, T_A^+), [I_A^-, I_A^+], [F_A^-, F_A^+]) \rangle$ and $\tilde{p}_2 = \langle [p_{\alpha_2}, p_{\beta_2}], ((T_B^-, T_B^+), [I_B^-, I_B^+], [F_B^-, F_B^+]) \rangle$ be two INULVs, then the Hamming distance between them is defined as follows:

$$D_{Ham}(\tilde{p}_1, \tilde{p}_2) = \frac{1}{12(u-1)} (|\alpha_1 \times T_A^- - \alpha_2 \times T_B^-| + |\alpha_1 \times T_A^+ - \alpha_2 \times T_B^+| + |\alpha_1 \times I_A^- - \alpha_2 \times I_B^-| + |\alpha_1 \times I_A^+ - \alpha_2 \times I_B^+| + |\alpha_1 \times F_A^- - \alpha_2 \times F_B^-| + |\alpha_1 \times F_A^+ - \alpha_2 \times F_B^+| + |\beta_1 \times T_A^- - \beta_2 \times T_B^-| + |\beta_1 \times T_A^+ - \beta_2 \times T_B^+| + |\beta_1 \times I_A^- - \beta_2 \times I_B^-| + |\beta_1 \times I_A^+ - \beta_2 \times I_B^+| + |\beta_1 \times F_A^- - \beta_2 \times F_B^-| + |\beta_1 \times F_A^+ - \beta_2 \times F_B^+|) \quad (7)$$

Definition 2.10: Let $\tilde{p}_1 = \langle [p_{\alpha_1}, p_{\beta_1}], ((T_A^-, T_A^+), [I_A^-, I_A^+], [F_A^-, F_A^+]) \rangle$ and $\tilde{p}_2 = \langle [p_{\alpha_2}, p_{\beta_2}], ((T_B^-, T_B^+), [I_B^-, I_B^+], [F_B^-, F_B^+]) \rangle$ be two INULVs, then we define the Euclidean distance between them as follows:

$$D_{Euc}(\tilde{p}_1, \tilde{p}_2) = \frac{1}{12(u-1)} [(\alpha_1 \times T_A^- - \alpha_2 \times T_B^-)^2 + (\alpha_1 \times T_A^+ - \alpha_2 \times T_B^+)^2 + (\alpha_1 \times I_A^- - \alpha_2 \times I_B^-)^2 + (\alpha_1 \times I_A^+ - \alpha_2 \times I_B^+)^2 + (\alpha_1 \times F_A^- - \alpha_2 \times F_B^-)^2 + (\alpha_1 \times F_A^+ - \alpha_2 \times F_B^+)^2 + (\beta_1 \times T_A^- - \beta_2 \times T_B^-)^2 + (\beta_1 \times T_A^+ - \beta_2 \times T_B^+)^2 + (\beta_1 \times I_A^- - \beta_2 \times I_B^-)^2 + (\beta_1 \times I_A^+ - \beta_2 \times I_B^+)^2 + (\beta_1 \times F_A^- - \beta_2 \times F_B^-)^2 + (\beta_1 \times F_A^+ - \beta_2 \times F_B^+)^2]^{1/2} \quad (8)$$

3 Extended GRA for MADM problems with interval neutrosophic uncertain linguistic information

Let $G = \{G_1, G_2, \dots, G_m\}$, ($m \geq 2$) be a discrete set of alternatives and $H = \{H_1, H_2, \dots, H_n\}$, ($n \geq 2$) be the set of attributes in a MADM problem with interval neutrosophic uncertain linguistic information. Also consider $\omega = \{ \omega_1, \omega_2, \dots, \omega_n \}$ be the weighting vector of the attributes with $0 \leq \omega_j \leq 1$ and $\sum_{j=1}^n \omega_j = 1$. Suppose the performance values of alternatives with respect to the attributes are represented by INULV $v_{ij} = \langle [x_{ij}^-, x_{ij}^+], ((T_{ij}^-, T_{ij}^+), [I_{ij}^-, I_{ij}^+], [F_{ij}^-, F_{ij}^+]) \rangle$; ($i = 1, 2, \dots, m$; $j = 1, 2, \dots, n$). Here, $[x_{ij}^-, x_{ij}^+]$ repre-

sents uncertain linguistic variable and $x_{ij}^-, x_{ij}^+ \in P = (p_0, p_1, p_2, \dots, p_{u-1})$, $T_{ij}^-, T_{ij}^+, I_{ij}^-, I_{ij}^+, F_{ij}^-, F_{ij}^+ \in [0, 1]$ with the condition $0 \leq T_{ij}^+(x) + I_{ij}^+(x) + F_{ij}^+(x) \leq 3$. Now, the steps for ranking the alternatives based on extended GRA method are described as follows:

Step 1. Normalize the decision matrix

Benefit type and cost type attributes are two types of attributes which exist in real world decision making problems. In order to eradicate the impact of the attribute types, we normalize [36] the decision matrix. Suppose $Q = (q_{ij})$ be the normalized decision matrix, where $q_{ij} = \langle [q_{ij}^-, q_{ij}^+], ((\dot{T}_{ij}^-, \dot{T}_{ij}^+), [\dot{I}_{ij}^-, \dot{I}_{ij}^+], [\dot{F}_{ij}^-, \dot{F}_{ij}^+]) \rangle$; ($i = 1, 2, \dots, m$; $j = 1, 2, \dots, n$), then

For benefit type attribute

$$q_{ij}^- = x_{ij}^-, q_{ij}^+ = x_{ij}^+ \text{ for } (i = 1, 2, \dots, m; j = 1, 2, \dots, n)$$

$$\dot{T}_{ij}^- = T_{ij}^-, \dot{T}_{ij}^+ = T_{ij}^+, \dot{I}_{ij}^- = I_{ij}^-, \dot{I}_{ij}^+ = I_{ij}^+, \dot{F}_{ij}^- = F_{ij}^-, \dot{F}_{ij}^+ = F_{ij}^+ \quad (9)$$

For cost type attribute

$$q_{ij}^- = \text{neg}(x_{ij}^+), q_{ij}^+ = \text{neg}(x_{ij}^-) \text{ for } (i = 1, 2, \dots, m; j = 1, 2, \dots, n)$$

$$\dot{T}_{ij}^- = T_{ij}^-, \dot{T}_{ij}^+ = T_{ij}^+, \dot{I}_{ij}^- = I_{ij}^-, \dot{I}_{ij}^+ = I_{ij}^+, \dot{F}_{ij}^- = F_{ij}^-, \dot{F}_{ij}^+ = F_{ij}^+ \quad (10)$$

Step 2. Identify the positive ideal solution (PIS) $Q^B = (q_1^B, q_2^B, \dots, q_n^B)$ and negative ideal solution $Q^W = (q_1^W, q_2^W, \dots, q_n^W)$

Broumi et al. [36] defined PIS (Q^B) and NIS (Q^W) in interval neutrosophic uncertain linguistic environment as follows:

$$Q^B = (q_1^B, q_2^B, \dots, q_n^B) = \langle [q_1^{B-}, q_1^{B+}], ((\dot{T}_1^{B-}, \dot{T}_1^{B+}), [\dot{I}_1^{B-}, \dot{I}_1^{B+}], [\dot{F}_1^{B-}, \dot{F}_1^{B+}]) \rangle; \langle [q_2^{B-}, q_2^{B+}], ((\dot{T}_2^{B-}, \dot{T}_2^{B+}), [\dot{I}_2^{B-}, \dot{I}_2^{B+}], [\dot{F}_2^{B-}, \dot{F}_2^{B+}]) \rangle; \dots; \langle [q_n^{B-}, q_n^{B+}], ((\dot{T}_n^{B-}, \dot{T}_n^{B+}), [\dot{I}_n^{B-}, \dot{I}_n^{B+}], [\dot{F}_n^{B-}, \dot{F}_n^{B+}]) \rangle \quad (11)$$

$$Q^W = (q_1^W, q_2^W, \dots, q_n^W) = \langle [q_1^{W-}, q_1^{W+}], ((\dot{T}_1^{W-}, \dot{T}_1^{W+}), [\dot{I}_1^{W-}, \dot{I}_1^{W+}], [\dot{F}_1^{W-}, \dot{F}_1^{W+}]) \rangle; \langle [q_2^{W-}, q_2^{W+}], ((\dot{T}_2^{W-}, \dot{T}_2^{W+}), [\dot{I}_2^{W-}, \dot{I}_2^{W+}], [\dot{F}_2^{W-}, \dot{F}_2^{W+}]) \rangle; \dots; \langle [q_n^{W-}, q_n^{W+}], ((\dot{T}_n^{W-}, \dot{T}_n^{W+}), [\dot{I}_n^{W-}, \dot{I}_n^{W+}], [\dot{F}_n^{W-}, \dot{F}_n^{W+}]) \rangle \quad (12)$$

where $q_j^{B-} = \text{Max}_i q_{ij}^-, q_j^{B+} = \text{Max}_i q_{ij}^+, \dot{T}_j^{B-} = \text{Max}_i \dot{T}_{ij}^-, \dot{T}_j^{B+} = \text{Max}_i \dot{T}_{ij}^+, \dot{I}_j^{B-} = \text{Min}_i \dot{I}_{ij}^-, \dot{I}_j^{B+} = \text{Min}_i \dot{I}_{ij}^+, \dot{F}_j^{B-} = \text{Min}_i \dot{F}_{ij}^-, \dot{F}_j^{B+} = \text{Min}_i \dot{F}_{ij}^+$;

$$q_j^{W^-} = \text{Min}_i q_{ij}^-, q_j^{W^+} = \text{Min}_i q_{ij}^+, \dot{T}_j^{W^-} = \text{Min}_i \dot{T}_{ij}^-, \dot{T}_j^{W^+} = \text{Min}_i \dot{T}_{ij}^+, \dot{I}_j^{W^-} = \text{Max}_i \dot{I}_{ij}^-, \dot{I}_j^{W^+} = \text{Max}_i \dot{I}_{ij}^+, \dot{F}_j^{W^-} = \text{Max}_i \dot{F}_{ij}^-, \dot{F}_j^{W^+} = \text{Max}_i \dot{F}_{ij}^+.$$

Step 3. Determine the neutrosophic grey relational coefficient of each alternative from PIS and NIS

The grey relational coefficient of each alternative from PIS is defined as follows:

$$\Omega_{ij}^+ = \frac{\text{Min}_i \text{Min}_j \rho_{ij}^+ + \sigma \text{Max}_i \text{Max}_j \rho_{ij}^+}{\rho_{ij}^+ + \sigma \text{Max}_i \text{Max}_j \rho_{ij}^+}, \tag{13}$$

where $\rho_{ij}^+ = D(q_{ij}, q_{ij}^B)$, ($i = 1, 2, \dots, m$; $j = 1, 2, \dots, n$)

and the grey relational coefficient of each alternative from NIS is defined as given below

$$\Omega_{ij}^- = \frac{\text{Min}_i \text{Min}_j \rho_{ij}^- + \sigma \text{Max}_i \text{Max}_j \rho_{ij}^-}{\rho_{ij}^- + \sigma \text{Max}_i \text{Max}_j \rho_{ij}^-}, \tag{14}$$

where $\rho_{ij}^- = D(q_{ij}, q_{ij}^W)$, ($i = 1, 2, \dots, m$; $j = 1, 2, \dots, n$).

Here, $\sigma \in [0, 1]$ represents the distinguishing coefficient and generally, $\sigma = 0.5$ is considered in the decision making context.

Step 4. Determination of weights of the attributes

The main idea of GRA method is that the chosen alternative should have the maximal degree of grey relation from the PIS. So, the maximal grey relational coefficient presents the most suitable alternative for the given weight vector. Here, we assume that the weight vector of the attributes is partially known to the DM. Now, the grey relational coefficient between PIS and itself is $(1, 1, \dots, 1)$, similarly, grey relational coefficient between NIS and itself is also $(1, 1, \dots, 1)$. The corresponding comprehensive deviations are given below.

$$D_i^+(\omega) = \sum_{j=1}^n (1 - \Omega_{ij}^+) \omega_j \tag{15}$$

$$D_i^-(\omega) = \sum_{j=1}^n (1 - \Omega_{ij}^-) \omega_j \tag{16}$$

Smaller values of $D_i^+(\omega)$ and $D_i^-(\omega)$ represent the better alternative. Now we use the max-min operator of Zimmermann and Zysco [37] to integrate all the distances $D_i^+(\omega)$ and $D_i^-(\omega)$, $i = 1, 2, \dots, m$ separately. Then, we construct the following programming model [29] for incompletely known weight information as:

$$(M-1A) \begin{cases} \text{Min } \alpha^+ \\ \text{subject to} \\ \sum_{j=1}^n (1 - \Omega_{ij}^+) \omega_j \leq \alpha^+, i=1, 2, \dots, m \\ \omega \in X. \end{cases} \tag{17}$$

$$(M-1B) \begin{cases} \text{Min } \alpha^- \\ \text{subject to} \\ \sum_{j=1}^n (1 - \Omega_{ij}^-) \omega_j \leq \alpha^-, i=1, 2, \dots, m \\ \omega \in X. \end{cases} \tag{18}$$

where $\alpha^+ = \text{Max}_i \sum_{j=1}^n (1 - \Omega_{ij}^+) \omega_j$; $\alpha^- = \text{Max}_i \sum_{j=1}^n (1 - \Omega_{ij}^-) \omega_j$, $i = 1, 2, \dots, m$.

By solving the model (M-1A) and model (M-1B), we get the optimal solutions $\omega^+ = (\omega_1^+, \omega_2^+, \dots, \omega_n^+)$ and $\omega^- = (\omega_1^-, \omega_2^-, \dots, \omega_n^-)$ respectively.

Finally, we obtain the weight vector (ω) by combining the above two optimal solutions as follows:

$$\omega = \tau \omega^+ + (1 - \tau) \omega^-; \tau \in [0, 1] \tag{19}$$

However, if the information about weights of the attributes are completely unknown, we can formulate another programming model [29] as follows:

$$(M-2) \begin{cases} \text{Min } D_i^+(\omega) = \sum_{j=1}^n (1 - \rho_{ij}^+) \omega_j^2 \\ \text{subject to} \\ \sum_{j=1}^n \omega_j = 1, i=1, 2, \dots, m. \end{cases} \tag{20}$$

Now we can aggregate the above multiple objective optimization models with same weights into the single objective optimization model as follows:

$$(M-3) \begin{cases} \text{Min } D_i^+(\omega) = \sum_{i=1}^m D_i^+(\omega) = \sum_{i=1}^m \sum_{j=1}^n \{(1 - \Omega_{ij}^+) \omega_j\}^2 \\ \text{subject to} \\ \sum_{j=1}^n \omega_j = 1. \end{cases} \tag{21}$$

In order to solve the above model, we formulate the Lagrange function as given below.

$$L(\omega, \zeta) = \sum_{i=1}^m \sum_{j=1}^n \{(1 - \Omega_{ij}^+) \omega_j\}^2 + 2\zeta (\sum_{j=1}^n \omega_j - 1) \tag{22}$$

Here, ζ is the Lagrange multiplier.

Now we differentiate the Eq. (22) with respect to ω_j ($j = 1, 2, \dots, n$) and ζ . Then, by equating the partial derivatives to zero, we obtain the set of equations as follows:

$$\frac{\partial L(\omega_j, \zeta)}{\partial \omega_j} = 2 \sum_{i=1}^m (1 - \Omega_{ij}^+) \omega_j + 2\zeta = 0,$$

$$\frac{\partial L(\omega_j, \zeta)}{\partial \zeta} = \sum_{j=1}^n \omega_j - 1 = 0$$

By solving the above equations, we obtain

$$\omega^+ = \frac{\left[\sum_{j=1}^n \left(\sum_{i=1}^m (1 - \Omega_{ij}^+) \right)^{-1} \right]^{-1}}{\sum_{i=1}^m \left\{ 1 - \Omega_{ij}^+ \right\}^2} \tag{23}$$

Similarly, we can get the attribute weight ω^- by considering NIS as follows:

$$\omega^- = \frac{\left[\sum_{j=1}^n \left(\sum_{i=1}^m \{1 - \Omega_{ij}^-\} \right)^2 \right]^{-1}}{\sum_{i=1}^m \{1 - \Omega_{ij}^-\}^2} \quad (24)$$

Finally, we can calculate the j -th attribute weight by using the Eq. (19).

Step 5. Determine the degree of neutrosophic grey relational coefficient

The degree of neutrosophic grey relational coefficient of each alternative from PIS and NIS are obtained by the equations (25) and (26) respectively.

$$\Omega_i^+ = \frac{\sum_{j=1}^n \omega_j}{\sum_{j=1}^n \Omega_{ij}^+}; i = 1, 2, \dots, m \quad (25)$$

$$\Omega_i^- = \frac{\sum_{j=1}^n \omega_j}{\sum_{j=1}^n \Omega_{ij}^-}; i = 1, 2, \dots, m \quad (26)$$

Step 6. Determine the neutrosophic relative relational degree

We compute the neutrosophic relative relational degree of each alternative from PIS by using the following Eq.

$$\mathfrak{R}_i = \frac{\Omega_i^+}{\Omega_i^+ + \Omega_i^-}, i = 1, 2, \dots, m. \quad (27)$$

Step 7. Rank the alternatives

The ranking order of the alternatives is obtained according to the decreasing order of the neutrosophic relative relational degree. The maximal value of $\mathfrak{R}_i, i = 1, 2, \dots, m$ reflects the most desirable alternative.

4 Proposed GRA based algorithm for MADM problems with interval neutrosophic uncertain linguistic information

In the following steps, we develop a new GRA based algorithm for solving MADM problems under interval neutrosophic uncertain linguistic information

Step 1. Assume $v_{ij} = \langle [x_{ij}^-, x_{ij}^+], ([T_{ij}^-, T_{ij}^+], [I_{ij}^-, I_{ij}^+], [F_{ij}^-, F_{ij}^+]) \rangle; (i = 1, 2, \dots, m; j = 1, 2, \dots, n)$ be an interval neutrosophic uncertain linguistic decision matrix provided by the DM, for the alternative G_i with respect to the attribute H_j , where $[x_{ij}^-, x_{ij}^+]$ denotes uncertain linguistic variable.

Step 2. If the attributes are benefit-type, then we normalize the decision matrix by using the Eq. (9), or we utilize the Eq. (10) in case of cost-type attributes.

Step 3. Identify PIS (Q^B) and NIS (Q^W) from the decision matrix by using Eqs (11) and (12) respectively.

Step 4. Use the distance measures to determine the distances of all alternatives from PIS and NIS.

Step 5. Compute neutrosophic grey relational coefficient of each alternative from PIS and NIS by using the equations. (13) and (14) respectively.

Step 6. If the attribute weights are partially known to the DM, then we solve the models (M-1A) and (M-1B) to find the optimal solutions $\omega^+ = (\omega_1^+, \omega_2^+, \dots, \omega_n^+)$ and $\omega^- =$

$(\omega_1^-, \omega_2^-, \dots, \omega_n^-)$ respectively. Then, weight vector (ω) is obtained by utilizing the Eq. (19). If the information about attribute weights are completely unknown, we solve the model (M-3) to determine ω^+ and ω^- . Finally the weight vector (ω) is calculated by employing the Eq. (19).

Step 7. Find the degree of neutrosophic grey relational coefficient of each alternative from PIS and NIS by employing the equations (25) and (26) respectively.

Step 8. Determine the neutrosophic relative relational degree (\mathfrak{R}_i) of each alternative from PIS by using the Eq. (27).

Step 9. Rank all the alternatives $G_i (i = 1, 2, \dots, m)$ based on \mathfrak{R}_i and choose the best alternative.

Step 10. End.

5 Numerical example

A MADM problem with interval neutrosophic uncertain linguistic information studied by Broumi et al. [36] has been considered in this Section to show the applicability and the effectiveness of the proposed extended GRA approach. Assume that an investment company desires to invest a sum of money in the best option. Suppose there are four possible alternatives to invest the money: (1) G_1 is a car company; (2) G_2 is a food company; (3) G_3 is a computer company; (4) G_4 is an arm company. The company must take a decision based on the following attributes: (1) H_1 is the risk; (2) H_2 is the growth analysis; (3) H_3 is the environmental impact analysis. The rating of performance values of the four alternatives with respect to the three attributes are presented by the DM in terms of INULVs under the linguistic term set $P = \{p_0 = \text{extremely poor}; p_1 = \text{very poor}; p_2 = \text{poor}; p_3 = \text{medium}; p_4 = \text{good}; p_5 = \text{very good}; p_6 = \text{extremely good}\}$ [36]. The decision matrix with interval neutrosophic uncertain linguistic variables is presented in Table 1 as follows:

Table 1. The decision matrix in terms of interval neutrosophic uncertain linguistic variables [36]

$$\begin{aligned}
 & \langle [p_4, p_3], ([0.4, 0.5], [0.2, 0.3], [0.3, 0.4]) \rangle & \langle [p_5, p_6], ([0.4, 0.6], [0.1, 0.2], [0.2, 0.4]) \rangle \\
 & \langle [p_5, p_6], ([0.5, 0.7], [0.1, 0.2], [0.2, 0.3]) \rangle & \langle [p_4, p_3], ([0.6, 0.7], [0.1, 0.2], [0.2, 0.3]) \rangle \\
 & \langle [p_5, p_6], ([0.3, 0.5], [0.1, 0.2], [0.3, 0.4]) \rangle & \langle [p_5, p_6], ([0.5, 0.6], [0.1, 0.3], [0.3, 0.4]) \rangle \\
 & \langle [p_3, p_4], ([0.7, 0.8], [0.0, 0.1], [0.1, 0.2]) \rangle & \langle [p_3, p_4], ([0.5, 0.7], [0.1, 0.2], [0.2, 0.3]) \rangle \\
 & \langle [p_4, p_3], ([0.2, 0.3], [0.1, 0.2], [0.5, 0.6]) \rangle \\
 & \langle [p_4, p_3], ([0.5, 0.7], [0.2, 0.2], [0.1, 0.2]) \rangle \\
 & \langle [p_4, p_4], ([0.5, 0.6], [0.1, 0.3], [0.1, 0.3]) \rangle \\
 & \langle [p_3, p_6], ([0.3, 0.4], [0.1, 0.2], [0.1, 0.2]) \rangle
 \end{aligned}$$

Now the proposed approach is described in the following steps.

Step 1. Normalization

The attributes of the given MADM problem are considered as benefit types. Therefore, we don't require the normalization of the decision matrix.

Step 2. Identify the PIS and NIS from the given decision matrix

The PIS (Q^B) is obtained from the decision matrix as follows:

$$Q^B = (\langle [p_5, p_6], [0.7, 0.8], [0.0, 0.1], [0.1, 0.2] \rangle; \langle [p_5, p_6], [0.6, 0.7], [0.1, 0.2], [0.2, 0.3] \rangle; \langle [p_5, p_6], [0.5, 0.7], [0.1, 0.2], [0.1, 0.2] \rangle)$$

The NIS (Q^W) is obtained from the decision matrix as follows:

$$Q^W = (\langle [p_3, p_4], [0.3, 0.5], [0.2, 0.3], [0.3, 0.4] \rangle; \langle [p_3, p_4], [0.4, 0.6], [0.1, 0.3], [0.3, 0.4] \rangle; \langle [p_4, p_4], [0.2, 0.3], [0.2, 0.3], [0.5, 0.6] \rangle)$$

Step 3. Determination of neutrosophic grey relational coefficient of each alternative from PIS and NIS

We calculate the Hamming distance between each alternative and PIS by utilizing the Eq. (7). Then, the neutrosophic grey relational coefficient of each alternative from PIS can be obtained by using the Eq. (13) as follows:

$$\Omega_{ij}^+ = \begin{bmatrix} 0.5294 & 0.9755 & 0.5051 \\ 0.7699 & 0.9917 & 1.0000 \\ 0.5414 & 0.8956 & 0.9024 \\ 0.7745 & 0.7065 & 0.8956 \end{bmatrix}$$

We also evaluate the Hamming distance between each alternative and NIS by using the Eq. (7). Then, the neutrosophic grey relational coefficient of each alternative

from NIS can be determined with the help of the Eq. (14) as follows:

$$\Omega_{ij}^- = \begin{bmatrix} 0.8314 & 0.7103 & 0.9333 \\ 0.6000 & 0.7444 & 0.4510 \\ 0.6995 & 0.5670 & 0.5134 \\ 0.5343 & 1.0000 & 0.5534 \end{bmatrix}$$

Step 4. Determination of the weights of the attributes

Case 1. The partially known weight information is presented as follows:

$$0.25 \leq \omega_1 \leq 0.4, 0.2 \leq \omega_2 \leq 0.35, 0.4 \leq \omega_3 \leq 0.5 \text{ such that } \sum_{j=1}^3 \omega_j = 1 \text{ and } \omega_j \geq 0, j = 1, 2, 3.$$

Now we construct the single objective programming model by using the model (M-1A) and model (M-1B) as given below.

Model (M-1A).

Min α^+
subject to

$$\begin{aligned}
 & 0.4706 \omega_1 + 0.0245 \omega_2 + 0.4949 \omega_3 \leq \alpha^+ , \\
 & 0.2301 \omega_1 + 0.0083 \omega_2 \leq \alpha^+ , \\
 & 0.4586 \omega_1 + 0.1044 \omega_2 + 0.0976 \omega_3 \leq \alpha^+ , \\
 & 0.2255 \omega_1 + 0.2935 \omega_2 + 0.1044 \omega_3 \leq \alpha^+ , \\
 & 0.25 \leq \omega_1 \leq 0.4, 0.2 \leq \omega_2 \leq 0.35, 0.4 \leq \omega_3 \leq 0.5,
 \end{aligned}$$

$$\sum_{j=1}^3 \omega_j = 1 \text{ and } \omega_j \geq 0, j = 1, 2, 3.$$

Model (M-1B).

Min α^-
subject to

$$\begin{aligned}
 & 0.1686 \omega_1 + 0.2897 \omega_2 + 0.0667 \omega_3 \leq \alpha^- , \\
 & 0.4 \omega_1 + 0.2556 \omega_2 + 0.549 \omega_3 \leq \alpha^- , \\
 & 0.3005 \omega_1 + 0.433 \omega_2 + 0.4866 \omega_3 \leq \alpha^- , \\
 & 0.4657 \omega_1 + 0.4466 \omega_3 \leq \alpha^- , \\
 & 0.25 \leq \omega_1 \leq 0.4, 0.2 \leq \omega_2 \leq 0.35, 0.4 \leq \omega_3 \leq 0.5,
 \end{aligned}$$

$$\sum_{j=1}^3 \omega_j = 1 \text{ and } \omega_j \geq 0, j = 1, 2, 3.$$

Solving the above two models (M-1A and M-1B), we get the weight vectors respectively as given below.

$$\omega^+ = (0.25, 0.35, 0.40) \text{ and } \omega^- = (0.294, 0.306, 0.40)$$

For $\tau = 0.5$, the combined weight vector of the attributes is obtained as $\omega = (0.272, 0.328, 0.4)$.

Case 2. Consider the information about the attribute weights be completely unknown to the DM. Then, we can get the unknown weights of the attributes by using the rela-

tions (23) and (24). The weights of the attributes are obtained respectively as follows:

$$\omega^+ = (0.118, 0.645, 0.237) \text{ and } \omega^- = (0.318, 0.468, 0.213)$$

Therefore, the resulting weight vector of the attributes by taking $\tau = 0.5$ is $\omega = (0.218, 0.557, 0.225)$.

Step 5. Calculate the degree of neutrosophic grey relational coefficient

The degree of neutrosophic grey relational coefficient of each alternative from PIS for Case 1 and Case 2 are presented as follows:

Case 1: $\Omega_1^+ = 0.6660, \Omega_2^+ = 0.9347, \Omega_3^+ = 0.8020, \Omega_4^+ = 0.8000$

Case 2: $\Omega_1^+ = 0.7724, \Omega_2^+ = 0.9452, \Omega_3^+ = 0.8199, \Omega_4^+ = 0.7639$.

Similarly, the degree of neutrosophic grey relational coefficient of each alternative from NIS for Case 1 and Case 2 are demonstrated as follows:

Case 1: $\Omega_1^+ = 0.8324, \Omega_2^+ = 0.5878, \Omega_3^+ = 0.5816, \Omega_4^+ = 0.6947$

Case 2: $\Omega_1^+ = 0.7869, \Omega_2^+ = 0.6469, \Omega_3^+ = 0.5838, \Omega_4^+ = 0.7980$.

Step 6. Evaluate the neutrosophic relative relational degree

We calculate the neutrosophic relative relational degree of each alternative from PIS for Case 1 and Case 2 are presented as follows:

Case 1: $\mathfrak{R}_1 = 0.4448, \mathfrak{R}_2 = 0.6139, \mathfrak{R}_3 = 0.5796, \mathfrak{R}_4 = 0.5354$

Case 2: $\mathfrak{R}_1 = 0.4954, \mathfrak{R}_2 = 0.5937, \mathfrak{R}_3 = 0.5841, \mathfrak{R}_4 = 4891$.

Step 7. Rank the alternatives

The ranking order of the alternatives for Case 1 and Case 2 are presented according to the values of the neutrosophic relative relational degrees as given below.

Case 1: $\mathfrak{R}_2 > \mathfrak{R}_3 > \mathfrak{R}_4 > \mathfrak{R}_1$

Case 2: $\mathfrak{R}_2 > \mathfrak{R}_3 > \mathfrak{R}_1 > \mathfrak{R}_4$

We observe that the Arms Company is the best alternative for investment purpose for both the cases (see Table 2).

Note 1. Broumi et al. [36] consider the weight vector $\omega = (0.35, 0.25, 0.4)$ and use TOPSIS method to rank the alternatives. If we consider the same weight structure i.e. $\omega = (0.35, 0.25, 0.4)$, then the ranking order of the alternatives based on the proposed GRA method is obtained as follows:

$G_2 > G_3 > G_4 > G_1$ and obviously, G_2 would be the best choice.

Note 2. If we consider the proposed Euclidean measure to calculate the distance between two INULVs, then $(0.25, 0.35, 0.4)$ and $(0.232, 0.559, 0.209)$ would be the obtained weight vectors for Case 1 and Case 2 respectively. If we follow the same procedure as described above, the neutrosophic relative relational degree of each alternative from PIS for Case 1 and Case 2 are computed as follows:

Case 1: $\mathfrak{R}_1 = 0.4213, \mathfrak{R}_2 = 0.6174, \mathfrak{R}_3 = 0.5508, \mathfrak{R}_4 = 0.496$;

Case 2: $\mathfrak{R}_1 = 0.4657, \mathfrak{R}_2 = 0.599, \mathfrak{R}_3 = 0.5556, \mathfrak{R}_4 = 4686$.

Therefore, the ranking order of the alternatives for Case 1 and Case 2 are shown as given below.

Case 1: $\mathfrak{R}_2 > \mathfrak{R}_3 > \mathfrak{R}_4 > \mathfrak{R}_1$

Case 2: $\mathfrak{R}_2 > \mathfrak{R}_3 > \mathfrak{R}_4 > \mathfrak{R}_1$

So, the Arms Company G_2 would be the best choice for investment purpose.

6 Conclusion

In the paper we have presented a solution method for MADM problems with interval neutrosophic uncertain linguistic information through extended GRA method. Interval neutrosophic uncertain linguistic variables are suitable for dealing with incomplete and inconsistent information which exist in real world problems. In this paper, we have proposed Euclidean distance between two INULVs. Also, we have addressed the incomplete or completely unknown weights of the attributes to the decision maker.

Table 2. Comparison of the proposed method with other existing method

Method	weight vector	ranking results	best option
Proposed method (Case 1) (using Hamming distance)	(0.272, 0.328, 0.4)	$G_2 > G_3 > G_4 > G_1$	G_2
Proposed method (Case 2) (using Hamming distance)	(0.218, 0.557, 0.225)	$G_2 > G_3 > G_1 > G_4$	G_2
Proposed method (Case 1) (using Euclidean distance)	(0.25, 0.35, 0.4)	$G_2 > G_3 > G_4 > G_1$	G_2
Proposed method	(0.232, 0.559, 0.209)	$G_2 > G_3 > G_4 > G_1$	G_2

(Case 2)
(using Euclidean distance)

Broumi et al. [36] (0.35, 0.25, 0.4) $G_2 > G_4 > G_3 > G_1 > G_2$

We have developed two different optimization models to recognize the weights of the attributes in two different cases. Then, extended GRA method has been developed to identify the ranking order of the alternatives. Finally, a numerical example has been solved to demonstrate the feasibility and applicability of the proposed method and compared with other existing methods in the literature. We hope that the proposed method can be helpful in the field of practical decision making problems such as school selection, teacher selection, medical diagnosis, pattern recognition, supplier selection, etc.

References

- [1] L. A. Zadeh. Fuzzy Sets. *Information and Control*, 8 (1965), 338-353.
- [2] K. T. Atanassov. Intuitionistic Fuzzy sets. *Fuzzy Sets and Systems*, 20 (1986), 87-96.
- [3] F. Smarandache. A unifying field of logics: Neutrosophy: neutrosophic probability, set and logic. American Research Press, Rehoboth, 1998.
- [4] F. Smarandache. A unifying field in logics: neutrosophic logics. *Multiple Valued Logic*, 8 (3) (2002), 385-438.
- [5] F. Smarandache. Neutrosophic set-a generalization of intuitionistic fuzzy sets. *International Journal of Pure and Applied Mathematics*, 24 (3) (2005), 287-297.
- [6] F. Smarandache. Neutrosophic set – a generalization of intuitionistic fuzzy set. *Journal of Defense Resources Management*, 1 (1) (2010), 107-116.
- [7] H. Wang, F. Smarandache, Y. Q. Zhang, and R. Sundaraman. Single valued neutrosophic sets. *Multispace and Multistructure*, 4 (2010), 410-413.
- [8] H. Wang, F. Smarandache, Y. Q. Zhang, and R. Sundaraman. *Interval neutrosophic sets and logic*. Hexis, Arizona, 2005.
- [9] P. Chi, and P. Liu. An extended TOPSIS method for the multiple attribute decision making problems based on interval neutrosophic set. *Neutrosophic Sets and Systems*, 1 (2013), 63-70.
- [10] J. Ye. Similarity measures between interval neutrosophic sets and their applications in multicriteria decision-making. *Journal of Intelligent & Fuzzy Systems*, 26 (2014), 165-172.
- [11] S. Broumi, and F. Smarandache. Cosine similarity measure of interval valued neutrosophic sets. *Neutrosophic Sets and Systems*, 5 (2014), 15-20.
- [12] A. Bhattacharya. On a measure of divergence of two multinomial population. *Sankhya Ser A*, 7 (1946), 401-406.
- [13] H. Zhang, J. Wang, and X. Chen. Interval neutrosophic sets and their application in multicriteria decision making problems. *The Scientific World Journal*, Article ID 645953 (2014), 1-15.
- [14] P. Liu, and L. Shi. The generalized hybrid weighted average operator based on interval neutrosophic hesitant set and its application to multiple attribute decision making. *Neural Computing and Applications*, 26 (2015), 457-471.
- [15] H. Zhang, J. Wang, and X. Chen. An outranking approach for multi-criteria decision-making problems with interval-valued neutrosophic sets. *Neural Computing and Applications*, (2015). DOI: 10.1007/s00521-015-1882-3.
- [16] J. Ye. Improved cross entropy measures of single valued neutrosophic sets and interval neutrosophic sets and their multicriteria decision making methods. *Cybernetics and Information Technologies*, 15 (4) (2015), 13-26.
- [17] R. Şahin, and P. Liu. Maximizing deviation method for neutrosophic multiple attribute decision making with incomplete weight information. *Neural Computing and Applications*, (2015). DOI: 10.1007/s00521-015-1995-8.
- [18] Z. Tian, H. Zhang, J. Wang, J. Wang, and X. Chen. Multi-criteria decision-making method based on a cross-entropy with interval neutrosophic sets. *International Journal of Systems Science*, (2015). DOI: 10.1080/00207721.2015.1102359.
- [19] S. Pramanik, and K. Mondal. Decision making based on some similarity measures under interval rough neutrosophic environment. *Neutrosophic Sets and Systems*, 10 (2015), 46-57.
- [20] J. Ye. Interval neutrosophic multiple attribute decision-making method with credibility information. *International Journal of Fuzzy Systems*, (2016). DOI 10.1007/s40815-015-0122-4.
- [21] J. L. Deng. Introduction to grey system theory. *The Journal of Grey System*, 1 (1989), 1-24.
- [22] J. J. Zhang, D. S. Wu, and D. L. Olson. The method of grey related analysis to multiple attribute decision making problems with interval numbers. *Mathematical and Computer Modelling*, 42 (2005), 991-998.
- [23] J. Hou. Grey relational analysis method for multiple attribute decision making in intuitionistic fuzzy setting. *Journal of Convergence Information Technology*, 5 (10) (2010), 194-199.
- [24] R. V. Rao, and D. Singh. An improved grey relational analysis as a decision making method for manufacturing situations. *International Journal of Decision Science, Risk and Management*, 2 (2010), 1-23.
- [25] S. Pramanik, and D. Mukhopadhyaya. Grey relational analysis based intuitionistic fuzzy multi criteria group decision-making approach for teacher selection in higher education. *International Journal of Computer Applications*, 34 (10) (2011), 21-29.
- [26] G. W. Wei. GRA method for multiple attribute decision making with incomplete weight information in intuitionistic fuzzy setting. *Knowledge Based Systems*, 23 (3) (2011), 243-247.
- [27] M. S. Kuo, and G. S. Liang. Combining VIKOR with GRA techniques to evaluate service quality of airports under fuzzy environment. *Expert Systems with Applications*, 38 (3) (2011), 1304-1312.
- [28] P. Biswas, S. Pramanik, and B. C. Giri. Entropy based grey relational analysis method for multi-attribute decision mak-

- ing under single valued neutrosophic assessment. *Neutrosophic Sets and Systems*, 2 (2014), 102-110.
- [29] P. Biswas, S. Pramanik, and B. C. Giri. A new methodology for neutrosophic multi-attribute decision making with unknown weight information. *Neutrosophic Sets and Systems*, 3 (2014), 42-50.
- [30] K. Mondal, and S. Pramanik. Rough neutrosophic multi-attribute decision making based on grey relational analysis. *Neutrosophic Sets and Systems*, 7 (2015), 8-17.
- [31] K. Mondal, and S. Pramanik. Neutrosophic decision making model of school choice. *Neutrosophic Sets and Systems*, 7 (2015), 62-68.
- [32] S. Pramanik, and K. Mondal. Interval neutrosophic multi-attribute decision-making based on grey relational analysis. *Neutrosophic Sets and Systems*, 9 (2015), 13-22.
- [33] K. Mondal, and S. Pramanik. Neutrosophic decision making model for clay-brick selection in construction field based on grey relational analysis. *Neutrosophic Sets and Systems*, 9 (2015), 71-78.
- [34] P. P. Dey, S. Pramanik, and B. C. Giri. An extended grey relational analysis based interval neutrosophic multi attribute decision making for weaver selection. *Journal of New Theory*, (9) (2015), 82-93.
- [35] J. Ye. Some aggregation operators of interval neutrosophic linguistic numbers for multiple attribute decision making. *Journal of Intelligent & Fuzzy Systems*, (2014). DOI: 10.3233/IFS-141187.
- [36] S. Broumi, J. Ye, and F. Smarandache. An extended TOPSIS method for multiple attribute decision making based on interval neutrosophic uncertain linguistic variables. *Neutrosophic Sets and Systems*, 8 (2015), 23-32.
- [37] H. Z. Zimmermann, and P. Zysco. Latent connectives in human decision-making. *Fuzzy Sets and Systems*, 4 (1980), 37-51.

Received: Dec. 12, 2015. Accepted: Jan. 20, 2016



Neutrosophic Soft Graphs

Nasir Shah¹ and Asim Hussain²

¹ Department of Mathematics, Riphah International University, I-14, Islamabad, Pakistan. Email: memaths@yahoo.com

² Department of Mathematics, Barani Institute of Management Sciences(BIMS), Rawalpindi, Pakistan. Email: sh.asim.hussain@gmail.com

Abstract. The aim of this paper is to propose a new type of graph called neutrosophic soft graphs. We have established a link between graphs and neutrosophic soft sets. Basic operations of

neutrosophic soft graphs such as union, intersection and complement are defined here. The concept of strong neutrosophic soft graphs is also discussed in this paper.

Keywords: Soft Sets, Graphs, Neutrosophic soft sets, Neutrosophic soft graphs. Strong neutrosophic soft graphs

1 Introduction

Graph theory is a nice tool to depict information in a very nice way. Usually graphs are represented pictorially, algebraically in the form of relations or by matrices. Their representation depends on application for which a graph is being employed. Graph theory has its origins in a 1736 paper by the celebrated mathematician Leonhard Euler [13] known as the father of graph theory, when he settled a famous unsolved problem known as Ko'nigsburg Bridge problem. Subject of graph theory may be considered a part of combinatorial mathematics. The theory has greatly contributed to our understanding of programming, communication theory, switching circuits, architecture, operational research, civil engineering anthropology, economics linguistic and psychology. From the standpoint of applications it is safe to say that graph theory has become the most important part of combinatorial mathematics. A graph is also used to create a relationship between a given set of elements. Each element can be represented by a vertex and the relationship between them can be represented by an edge.

L.A. Zadeh [26] introduced the notion of fuzzy subset of a set in 1965 which is an extension of classical set theory. His work proved to be a mathematical tool for explaining the concept of uncertainty in real life problems. A fuzzy set can be defined mathematically by assigning to each possible individual in the universe of discourse a value representing its grade of membership in the fuzzy set. This grade corresponds to the degree to which that individual is similar or compatible with the concept represented by the fuzzy set. In 1975 Azriel Rosenfeld [20] considered fuzzy relations on fuzzy sets and developed the theory of fuzzy graphs which have many applications in modeling, Environmental science, Social science, Geography and Linguistics etc. which deals with problems in these areas that can be better studied using the concept of fuzzy graph structures. Many researchers contributed a lot and gave

some more generalized forms of fuzzy graphs which have been studied in [8] and [10]. These contributions show a new dimension of graph theory.

Molodstov introduced the theory of soft sets [18] which is generally used to deal with uncertainty and vagueness. He introduced the concept as a mathematical tool free from difficulties and presented the fundamental results of the new theory and successfully applied it to several directions. During recent past soft set theory has gained popularity among researchers, scholars practitioners and academicians. The theory of neutrosophic set is introduced by Smarandache [21] which is useful for dealing real life problems having imprecise, indeterminacy and inconsistent data. The theory is generalization of classical sets and fuzzy sets and is applied in decision making problems, control theory, medicines, topology and in many more real life problems. Maji [17] first time proposed the definition of neutrosophic soft sets and discussed many operations such as union, intersection and complement etc of such sets. Some new theories and ideas about neutrosophic sets can be studied in [6], [7] and [12]. In the present paper neutrosophic soft sets are employed to study graphs and give rise to a new class of graphs called neutrosophic soft graphs. We have discussed different operations defined on neutrosophic soft graphs using examples to make the concept easier. The concept of strong neutrosophic soft graphs and the complement of strong neutrosophic soft graphs is also discussed. Neutrosophic soft graphs are pictorial representation in which each vertex and each edge is an element of neutrosophic soft sets. This paper has been arranged as the following;

In section 2, some basic concepts about graphs and neutrosophic soft sets are presented which will be employed in later sections. In section 3, concept of neutrosophic soft graphs is given and some of their fundamental properties have been studied. In section 4, the concept of strong neutrosophic soft graphs and its complement is studied. Conclusion are also given at the

end of section 4.

2 PRELIMINARIES

In this section, we have given some definitions about graphs and neutrosophic soft sets. These will be helpful in later sections.

2.1 Definition [25]: A graph G^* consists of set of finite objects $V = \{v_1, v_2, v_3, \dots, v_n\}$ called vertices (also called points or nodes) and other set $E = \{e_1, e_2, e_3, \dots, e_n\}$ whose elements are called edges (also called lines or arcs). Usually a graph is denoted as $G^* = (V, E)$. Let G^* be a graph and $\{u, v\}$ an edge of G^* . Since $\{u, v\}$ is 2-element set, we may write $\{v, u\}$ instead of $\{u, v\}$. It is often more convenient to represent this edge by uv or vu . If $e = uv$ is an edges of a graph G^* , then we say that u and v are adjacent in G^* and that e joins u and v . A vertex which is not adjacent to any other node is called isolated vertex.

2.2 Definition [25]: An edge of a graph that joins a node to itself is called loop or self loop.

2.3 Definition [25]: In a multigraph no loops are allowed but more than one edge can join two vertices, these edges are called multiple edges or parallel edges and a graph is called multigraph.

2.4 Definition [25]: A graph which has neither loops nor multiple edges is called a simple graph.

2.5 Definition [25]: A sub graph H^* of G^* is a graph having all of its vertices and edges in G^* . If H^* is a sub graph of G^* , then G^* is a super graph of H^* .

2.6 Definition [25]: Let $G_1^* = (V_1, E_1)$ and $G_2^* = (V_2, E_2)$ be two graphs. A function $f : V_1 \rightarrow V_2$ is called isomorphism if

- i) f is one to one and onto.
- ii) for all $a, b \in V_1, \{a, b\} \in E_1$ if and only if $\{f(a), f(b)\} \in E_2$ when such a function exists, G_1^* and G_2^* are called isomorphic graphs and is written as $G_1^* \cong G_2^*$.

In other words, two graph G_1^* and G_2^* are said to be isomorphic to each other if there is a one to one correspondence between their vertices and between edges such that incidence relationship is preserved.

2.7 Definition [25]: The union of two simple graphs $G_1^* = (V_1, E_1)$ and $G_2^* = (V_2, E_2)$ is the simple graph with the vertex set $V_1 \cup V_2$ and edge set $E_1 \cup E_2$. The union of G_1^* and G_2^* is denoted by $G^* = G_1^* \cup G_2^* = (V_1 \cup V_2, E_1 \cup E_2)$.

2.8 Definition [25]: The join of two simple graphs $G_1^* = (V_1, E_1)$ and $G_2^* = (V_2, E_2)$ is the simple graph with the vertex set $V_1 \cup V_2$ and edge set $E_1 \cup E_2 \cup E'$ where E' is the set of all edges joining the nodes of V_1 and V_2 assume that $V_1 \cap V_2 \neq \emptyset$. The join of G_1^* and G_2^* is denoted by $G^* = G_1^* + G_2^* = (V_1 \cup V_2, E_1 \cup E_2 \cup E')$.

2.9 Definition [18]: Let U be an initial universe and E be the set of all possible parameters under consideration with respect to U . The power set of U is denoted by $P(U)$ and A is a subset of E . Usually parameters are attributes, characteristics, or properties of objects in U . A pair (F, A) is called a soft set over U , where F is a mapping $F : A \rightarrow P(U)$. In other words, a soft set over U is a parameterized family of subsets of the universe U . For $e \in A, F(e)$ may be considered as the set of e -approximate elements of the soft set (F, A) .

2.10 Definition [21]: A neutrosophic set A on the universe of discourse X is defined as $A = \{ \langle x, T_A(x), I_A(x), F_A(x) \rangle, x \in X \}$, where

$$T, I, F : X \rightarrow]\bar{0}, 1^+[\text{ and } \bar{0} \leq T_A(x) + I_A(x) + F_A(x) \leq 3^+ .$$

From philosophical point of view, the neutrosophic set takes the value from real standard or non-standard subsets of $] \bar{0}, 1^+[$. But in real life application in scientific and engineering problems it is difficult to use neutrosophic set with value from real standard or non-standard subset of $] \bar{0}, 1^+[$. Hence we consider the neutrosophic set which takes the value from the subset of $[0, 1]$.

2.11 Definition [17]: Let $N(U)$ be the set of all neutrosophic sets on universal set U, E be the set of parameters that describes the elements of U and $A \subseteq E$. A pair (F, A) is called a neutrosophic soft set NSS over U , where F is a mapping given by $F : A \rightarrow N(U)$. A neutrosophic soft set is a mapping from parameters to $N(U)$. It is a parameterized family of neutrosophic subsets of U . For $e \in A, F(e)$ may be considered as the set of e-approximate elements of the neutrosophic soft set (F, A) . The neutrosophic soft set (F, A) is parameterized family $\{F(e), i = 1, 2, 3, e \in A\}$.

2.12 Definition [17]: Let $E_1, E_2 \in E$ and $(F, E_1), (G, E_2)$ be two neutrosophic soft sets over U then (F, E_1) is said to be a neutrosophic soft subset of (G, E_2) if

- (1) $E_1 \subseteq E_2$
 (2) $\begin{cases} T_{F(e)}(x) \leq T_{G(e)}(x), I_{F(e)}(x) \leq I_{G(e)}(x), \\ F_{F(e)}(x) \geq F_{G(e)}(x) \end{cases}$

for all $e \in E_1, x \in U$.

In this case, we write $(F, E_1) \subseteq (G, E_2)$.

2.13 Definition [17]: Two neutrosophic soft sets (F, E_1) and (G, E_2) are said to be neutrosophic soft equal if (F, E_1) is a neutrosophic soft subset of (G, E_2) and (G, E_2) is a neutrosophic soft subset of (F, E_1) . In this case, we write $(F, E_1) = (G, E_2)$.

2.14 Definition [14]: Let U be an initial universe, E be the set of parameters, and $A \subseteq E$.

(a) (H, A) is called a relative whole neutrosophic soft set (with respect to the parameter set A), denoted by ϕ_A , if $T_{H(e)}(x) = 1, I_{H(e)}(x) = 1, F_{H(e)}(x) = 0$, for all $e \in A, x \in U$.

(b) (G, A) is called a relative null neutrosophic soft set (with respect to the parameter set A), denoted by ϕ_A , if $T_{H(e)}(x) = 0, I_{H(e)}(x) = 0, F_{H(e)}(x) = 1$, for all $e \in A, x \in U$.

The relative whole neutrosophic soft set with respect to the set of parameters E is called the absolute neutrosophic soft set over U and simply denoted by U_E . In a similar way, the relative null neutrosophic soft set with respect to E is called the null neutrosophic soft set over U and is denoted by ϕ_E .

2.15 Definition [17]: The complement of a NSS (G, A) is denoted by $(G, A)^c$ and is defined by $(G, A)^c = (G^c, \neg A)$ where $G^c: \neg A \rightarrow N(U)$ is a mapping given by $G^c(\neg e) =$ neutrosophic soft complement with $T_{G^c(\neg e)} = F_{G(e)}, I_{G^c(\neg e)} = I_{G(e)}, F_{G^c(\neg e)} = T_{G(e)}$.

2.16 Definition [14](1): Extended union of two NSS (H, A) and (G, B) over the common universe U is denoted by $(H, A) \cup_E (G, B)$ and is define as $(H, A) \cup_E (G, B) = (K, C)$, where $C = A \cup B$ and the truth-membership, indeterminacy-membership and falsity-membership of (K, C) are as follows

$$T_{k(e)}(x) = \begin{cases} T_{H(e)}(x) & \text{if } e \in A - B, \\ T_{G(e)}(x) & \text{if } e \in B - A, \\ \max\{T_{H(e)}(x), T_{G(e)}(x)\} & \text{if } e \in A \cap B \end{cases}$$

$$I_{k(e)}(x) = \begin{cases} I_{H(e)}(x) & \text{if } e \in A - B, \\ I_{G(e)}(x) & \text{if } e \in B - A, \\ \max\{I_{H(e)}(x), I_{G(e)}(x)\} & \text{if } e \in A \cap B \end{cases}$$

$$F_{k(e)}(x) = \begin{cases} F_{H(e)}(x) & \text{if } e \in A - B, \\ F_{G(e)}(x) & \text{if } e \in B - A, \\ \min\{F_{H(e)}(x), F_{G(e)}(x)\} & \text{if } e \in A \cap B \end{cases}$$

2.17 Definition [14]: The restricted union of two NSS (H, A) and (G, B) over the common universe U is denoted by $(H, A) \cup_R (G, B)$ and is define as $(H, A) \cup_R (G, B) = (K, C)$, where $C = A \cap B$ and the truth-membership, indeterminacy-membership and falsity-membership of (K, C) are as follows

$$T_{K(e)}(x) = \max\{T_{H(e)}(x), T_{G(e)}(x)\} \text{ if } e \in A \cap B,$$

$$I_{K(e)}(x) = \max\{I_{H(e)}(x), I_{G(e)}(x)\} \text{ if } e \in A \cap B,$$

$$F_{K(e)}(x) = \min\{F_{H(e)}(x), F_{G(e)}(x)\} \text{ if } e \in A \cap B.$$

2.18 Definition [14]: Extended intersection of two NSS (H, A) and (G, B) over the common universe U is denoted by $(H, A) \cap_E (G, B)$ and is define as $(H, A) \cap_E (G, B) = (K, C)$, where $C = A \cup B$ and the truth-membership, indeterminacy-membership and falsity-membership of (K, C) are as follows

$$T_{k(e)}(x) = \begin{cases} T_{H(e)}(x) & \text{if } e \in A - B, \\ T_{G(e)}(x) & \text{if } e \in B - A, \\ \min\{T_{H(e)}(x), T_{G(e)}(x)\} & \text{if } e \in A \cap B \end{cases}$$

$$I_{k(e)}(x) = \begin{cases} I_{H(e)}(x) & \text{if } e \in A - B, \\ I_{G(e)}(x) & \text{if } e \in B - A, \\ \min\{I_{H(e)}(x), I_{G(e)}(x)\} & \text{if } e \in A \cap B \end{cases}$$

$$F_{k(e)}(x) = \begin{cases} F_{H(e)}(x) & \text{if } e \in A - B, \\ F_{G(e)}(x) & \text{if } e \in B - A, \\ \max\{F_{H(e)}(x), F_{G(e)}(x)\} & \text{if } e \in A \cap B \end{cases}$$

2.19 Definition [14]: The restricted intersection of two NSS (H, A) and (G, B) over the common universe U is denoted by $(H, A) \cap_R (G, B)$ and is define as $(H, A) \cap_R (G, B) = (K, C)$, where $C = A \cap B$ and the truth-membership, indeterminacy-membership and falsity-membership of (K, C) are as follows

$$T_{K(e)}(x) = \min\{T_{H(e)}(x), T_{G(e)}(x)\} \text{ if } e \in A \cap B,$$

$$I_{K(e)}(x) = \min\{I_{H(e)}(x), I_{G(e)}(x)\} \text{ if } e \in A \cap B,$$

$$F_{K(e)}(x) = \max\{F_{H(e)}(x), F_{G(e)}(x)\} \text{ if } e \in A \cap B.$$

3 Neutrosophic soft graphs

3.1 Definition Let $G^* = (V, E)$ be a simple graph and A

be the set of parameters. Let $N(V)$ be the set of all neutrosophic sets in V . By a neutrosophic soft graph NSG, we mean a 4-tuple $G = (G^*, A, f, g)$ where

$$f : A \rightarrow N(V), g : A \rightarrow N(V \times V) \text{ defined as}$$

$$f(e) = f_e = \{\langle x, T_{f_e}(x), I_{f_e}(x), F_{f_e}(x) \rangle, x \in V\} \text{ and}$$

$$g(e) = g_e = \{\langle (x, y), T_{g_e}(x, y), I_{g_e}(x, y), F_{g_e}(x, y) \rangle, (x, y) \in V \times V\}$$

are neutrosophic sets over V and $V \times V$ respectively, such that

$$T_{g_e}(x, y) \leq \min\{T_{f_e}(x), T_{f_e}(y)\},$$

$$I_{g_e}(x, y) \leq \min\{I_{f_e}(x), I_{f_e}(y)\},$$

$$F_{g_e}(x, y) \geq \max\{F_{f_e}(x), F_{f_e}(y)\}.$$

for all $(x, y) \in V \times V$ and $e \in A$. We can also denote a NSG by $G = (G^*, A, f, g) = \{N(e) : e \in A\}$ which is a parameterized family of graphs $N(e)$ we call them Neutrosophic graphs.

3.2 Example

Let $G^* = (V, E)$ be a simple graph with $V = \{x_1, x_2, x_3\}$, $A = \{e_1, e_2, e_3\}$ be a set of parameters. A NSG is given in Table 1 below and $T_{g_e}(x_i, x_j) = 0, I_{g_e}(x_i, x_j) = 0$ and $F_{g_e}(x_i, x_j) = 1$, for all $(x_i, x_j) \in V \times V \setminus \{(x_1, x_2), (x_2, x_3), (x_3, x_1)\}$ and for all $e \in A$.

Table 1

f	x_1	x_2	x_3
e_1	(0.4,0.5,0.6)	(0.4,0.5,0.7)	(0,0,1)
e_2	(0.3,0.4,0.5)	(0.1,0.3,0.4)	(0.1,0.3,0.6)
e_3	(0.2,0.3,0.5)	(0.1,0.2,0.4)	(0.1,0.5,0.7)
g	(x_1, x_2)	(x_2, x_3)	(x_1, x_3)
e_1	(0.2,0.3,0.8)	(0,0,1)	(0,0,1)
e_2	(0.1,0.3,0.6)	(0,0,1)	(0.1,0.3,0.8)
e_3	(0.1,0.1,0.9)	(0.1,0.2,0.7)	(0.1,0.3,0.8)

$N(e_1)$ Corresponding to e_1

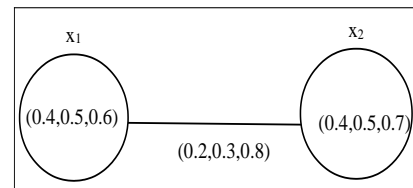

figure 1

$N(e_2)$ Corresponding to e_2

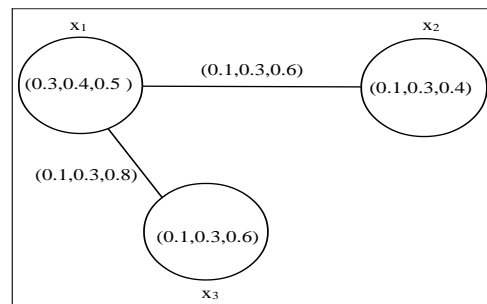

figure 2

$N(e_3)$ Corresponding to e_3

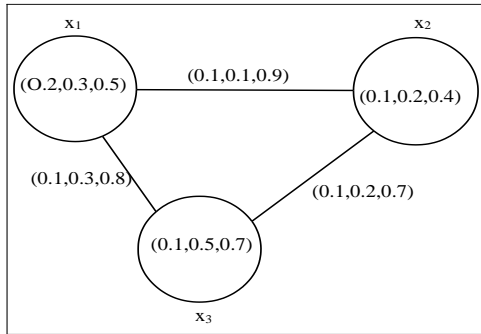

figure 3

3.3 Definition A neutrosophic soft graph

$G = (G^*, A^1, f^1, g^1)$ is called a neutrosophic soft subgraph

of $G = (G^*, A, f, g)$ if

(i) $A^1 \subseteq A$

(ii) $f_e^1 \subseteq f$, that is,

$$T_{f_e^1}(x) \leq T_{f_e}(x), I_{f_e^1}(x) \leq I_{f_e}(x), F_{f_e^1}(x) \geq F_{f_e}(x).$$

(iii) $g_e^1 \subseteq g$, that is,

$$T_{g_e^1}(x, y) \leq T_{g_e}(x, y), I_{g_e^1}(x, y) \leq I_{g_e}(x, y), F_{g_e^1}(x, y) \geq F_{g_e}(x, y).$$

for all $e \in A^1$.

3.4 Example

Let $G^* = (V, E)$ be a simple graph with $V = \{x_1, x_2, x_3\}$ and set of parameters $A = \{e_1, e_2\}$. A neutrosophic soft subgraph of example 3.2 is given in Table 2 below and $T_{g_e}(x_i, x_j) = 0, I_{g_e}(x_i, x_j) = 0$ and $F_{g_e}(x_i, x_j) = 1$, for all $(x_i, x_j) \in V \times V \setminus \{(x_1, x_2), (x_2, x_3), (x_3, x_1)\}$ and for all $e \in A$.

Table 2.

f^1	x_1	x_2	x_3
e_1	(0.3,0.2,0.5)	(0.3,0.2,0.6)	(0,0,1)
e_2	(0.1,0.1,0.5)	(0.1,0.2,0.4)	(0.1,0.2,0.6)
g^1	(x_1, x_2)	(x_2, x_3)	(x_1, x_3)
e_1	(0.2,0.2,0.7)	(0,0,1)	(0,0,1)
e_2	(0.1,0.1,0.6)	(0,0,1)	(0.1,0.2,0.8)

$N(e_1)$ Corresponding to e_1

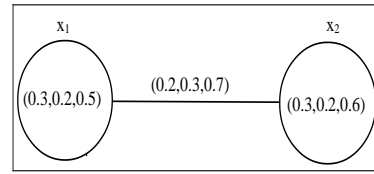

figure 4

$N(e_2)$ Corresponding to e_2

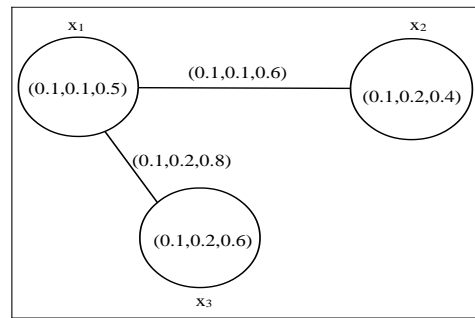

figure 5

3.5 Definition A neutrosophic soft subgraph

$G = (G^*, A^1, f^1, g^1)$ is said to be spanning neutrosophic

soft subgraph of $G = (G^*, A, f, g)$ if $f_e^1(x) = f(x)$, for all

$x \in V, e \in A^1$.

(Here two neutrosophic soft graphs have the same neutrosophic soft vertex set, But have opposite edge sets.

3.6 Definition The union of two neutrosophic soft graphs

$G_1 = (G_1^*, A_1, f^1, g^1)$ and $G_2 = (G_2^*, A_2, f^2, g^2)$ is denoted

by $G = (G^*, A, f, g)$, with $A = A_1 \cup A_2$ where the truth-

membership, indeterminacy-membership and falsity-membership of union are as follows

$$T_{f_e}(x) = \begin{cases} T_{f_e^1}(x) & \left\{ \begin{array}{l} \text{if } e \in A_1 - A_2 \text{ and } x \in V_1 - V_2 \text{ or} \\ \text{if } e \in A_1 - A_2 \text{ and } x \in V_1 \cap V_2 \text{ or} \\ \text{if } e \in A_1 \cap A_2 \text{ and } x \in V_1 - V_2. \end{array} \right. \\ T_{f_e^2}(x) & \left\{ \begin{array}{l} \text{if } e \in A_2 - A_1 \text{ and } x \in V_2 - V_1 \text{ or} \\ \text{if } e \in A_2 - A_1 \text{ and } x \in V_1 \cap V_2 \text{ or} \\ \text{if } e \in A_1 \cap A_2 \text{ and } x \in V_2 - V_1. \end{array} \right. \\ \max\{T_{f_e^1}(x), T_{f_e^2}(x)\} & \left\{ \begin{array}{l} \text{if } e \in A_1 \cap A_2 \text{ and } x \in V_1 \cap V_2 \\ 0, \text{ otherwise} \end{array} \right. \end{cases}$$

$$I_{fe}(x) = \begin{cases} I_{f_e^1}(x) & \left\{ \begin{array}{l} \text{if } e \in A_1 - A_2 \text{ and } x \in V_1 - V_2 \text{ or} \\ \text{if } e \in A_1 - A_2 \text{ and } x \in V_1 \cap V_2 \text{ or} \\ \text{if } e \in A_1 \cap A_2 \text{ and } x \in V_1 - V_2. \end{array} \right. \\ I_{f_e^2}(x) & \left\{ \begin{array}{l} \text{if } e \in A_2 - A_1 \text{ and } x \in V_2 - V_1 \text{ or} \\ \text{if } e \in A_2 - A_1 \text{ and } x \in V_1 \cap V_2 \text{ or} \\ \text{if } e \in A_1 \cap A_2 \text{ and } x \in V_2 - V_1. \end{array} \right. \\ \max \left\{ I_{f_e^1}(x), I_{f_e^2}(x) \right\} & \left\{ \begin{array}{l} \text{if } e \in A_1 \cap A_2 \text{ and} \\ x \in V_1 \cap V_2 \end{array} \right. \\ 0, & \text{otherwise} \end{cases}$$

$$F_{fe}(x) = \begin{cases} F_{f_e^1}(x) & \left\{ \begin{array}{l} \text{if } e \in A_1 - A_2 \text{ and } x \in V_1 - V_2 \text{ or} \\ \text{if } e \in A_1 - A_2 \text{ and } x \in V_1 \cap V_2 \text{ or} \\ \text{if } e \in A_1 \cap A_2 \text{ and } x \in V_1 - V_2. \end{array} \right. \\ F_{f_e^2}(x) & \left\{ \begin{array}{l} \text{if } e \in A_2 - A_1 \text{ and } x \in V_2 - V_1 \text{ or} \\ \text{if } e \in A_2 - A_1 \text{ and } x \in V_1 \cap V_2 \text{ or} \\ \text{if } e \in A_1 \cap A_2 \text{ and } x \in V_2 - V_1. \end{array} \right. \\ \min \left\{ F_{f_e^1}(x), F_{f_e^2}(x) \right\} & \left\{ \begin{array}{l} \text{if } e \in A_1 \cap A_2 \text{ and} \\ x \in V_1 \cap V_2 \end{array} \right. \\ 0, & \text{otherwise} \end{cases}$$

Also

$$T_{ge}(x, y) = \begin{cases} T_{g_e^1}(x, y) & \left\{ \begin{array}{l} \text{if } e \in A_1 - A_2 \text{ and } (x, y) \in (V_1 \times V_1) - (V_2 \times V_2) \text{ or} \\ \text{if } e \in A_1 - A_2 \text{ and } (x, y) \in (V_1 \times V_1) \cap (V_2 \times V_2) \text{ or} \\ \text{if } e \in A_1 \cap A_2 \text{ and } (x, y) \in (V_1 \times V_1) - (V_2 \times V_2). \end{array} \right. \\ T_{g_e^2}(x, y) & \left\{ \begin{array}{l} \text{if } e \in A_2 - A_1 \text{ and } (x, y) \in (V_2 \times V_2) - (V_1 \times V_1) \text{ or} \\ \text{if } e \in A_2 - A_1 \text{ and } (x, y) \in (V_1 \times V_1) \cap (V_2 \times V_2) \text{ or} \\ \text{if } e \in A_1 \cap A_2 \text{ and } (x, y) \in (V_2 \times V_2) - (V_1 \times V_1). \end{array} \right. \\ \max \left\{ T_{g_e^1}(x, y), T_{g_e^2}(x, y) \right\} & \left\{ \begin{array}{l} \text{if } e \in A_1 \cap A_2 \text{ and} \\ (x, y) \in (V_1 \times V_1) \cap (V_2 \times V_2) \end{array} \right. \\ 0, & \text{otherwise} \end{cases}$$

$$I_{ge}(x, y) = \begin{cases} I_{g_e^1}(x, y) & \left\{ \begin{array}{l} \text{if } e \in A_1 - A_2 \text{ and } (x, y) \in (V_1 \times V_1) - (V_2 \times V_2) \text{ or} \\ \text{if } e \in A_1 - A_2 \text{ and } (x, y) \in (V_1 \times V_1) \cap (V_2 \times V_2) \text{ or} \\ \text{if } e \in A_1 \cap A_2 \text{ and } (x, y) \in (V_1 \times V_1) - (V_2 \times V_2). \end{array} \right. \\ I_{g_e^2}(x, y) & \left\{ \begin{array}{l} \text{if } e \in A_2 - A_1 \text{ and } (x, y) \in (V_2 \times V_2) - (V_1 \times V_1) \text{ or} \\ \text{if } e \in A_2 - A_1 \text{ and } (x, y) \in (V_1 \times V_1) \cap (V_2 \times V_2) \text{ or} \\ \text{if } e \in A_1 \cap A_2 \text{ and } (x, y) \in (V_2 \times V_2) - (V_1 \times V_1). \end{array} \right. \\ \max \left\{ I_{g_e^1}(x, y), I_{g_e^2}(x, y) \right\} & \left\{ \begin{array}{l} \text{if } e \in A_1 \cap A_2 \text{ and} \\ (x, y) \in (V_1 \times V_1) \cap (V_2 \times V_2) \end{array} \right. \\ 0, & \text{otherwise} \end{cases}$$

$$F_{ge}(x, y) = \begin{cases} F_{g_e^1}(x, y) & \left\{ \begin{array}{l} \text{if } e \in A_1 - A_2 \text{ and } (x, y) \in (V_1 \times V_1) - (V_2 \times V_2) \text{ or} \\ \text{if } e \in A_1 - A_2 \text{ and } (x, y) \in (V_1 \times V_1) \cap (V_2 \times V_2) \text{ or} \\ \text{if } e \in A_1 \cap A_2 \text{ and } (x, y) \in (V_1 \times V_1) - (V_2 \times V_2). \end{array} \right. \\ F_{g_e^2}(x, y) & \left\{ \begin{array}{l} \text{if } e \in A_2 - A_1 \text{ and } (x, y) \in (V_2 \times V_2) - (V_1 \times V_1) \text{ or} \\ \text{if } e \in A_2 - A_1 \text{ and } (x, y) \in (V_1 \times V_1) \cap (V_2 \times V_2) \text{ or} \\ \text{if } e \in A_1 \cap A_2 \text{ and } (x, y) \in (V_2 \times V_2) - (V_1 \times V_1). \end{array} \right. \\ \min \left\{ F_{g_e^1}(x, y), F_{g_e^2}(x, y) \right\} & \left\{ \begin{array}{l} \text{if } e \in A_1 \cap A_2 \text{ and} \\ (x, y) \in (V_1 \times V_1) \cap (V_2 \times V_2) \end{array} \right. \\ 0, & \text{otherwise} \end{cases}$$

3.7 Example

Let $G_1^* = (V_1, E_1)$ be a simple graph with $V_1 = \{x_1, x_2, x_3\}$ and set of parameters $A_1 = \{e_1, e_2, e_3\}$. Let $G_2^* = (V_2, E_2)$ be a simple graph with $V_2 = \{x_2, x_3, x_5\}$ and set of parameters $A_2 = \{e_2, e_4\}$. A NSG $G_1 = (G_1^*, A, f^1, g^1)$ is given in Table 3 below and $T_{ge}(x_i, x_j) = 0, I_{ge}(x_i, x_j) = 0$ and $F_{ge}(x_i, x_j) = 1$, for all $(x_i, x_j) \in V_1 \times V_1 \setminus \{(x_1, x_4), (x_3, x_4), (x_1, x_3)\}$ and for all

Table 3

f^1	x_1	x_3	x_4
e_1	(0.1,0.2,0.3)	(0.2,0.3,0.4)	(0.2,0.5,0.7)
e_2	(0.1,0.3,0.7)	(0.4,0.6,0.7)	(0.1,0.2,0.3)
e_3	(0.5,0.6,0.7)	(0.6,0.8,0.9)	(0.3,0.4,0.6)
g^1	(x_1, x_4)	(x_3, x_4)	(x_1, x_3)
e_1	(0.1,0.2,0.7)	(0.1,0.3,0.8)	(0.1,0.2,0.5)
e_2	(0.1,0.2,0.7)	(0.1,0.1,0.9)	(0.1,0.2,0.8)
e_3	(0.1,0.3,0.8)	(0.2,0.3,0.9)	(0,0,1)

$N(e_1)$ Corresponding to e_1

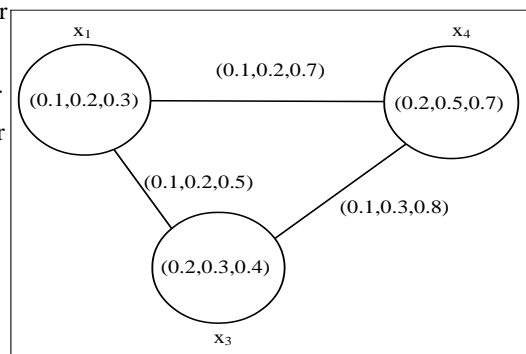

figure 6

$N(e_2)$ Corresponding to e_2

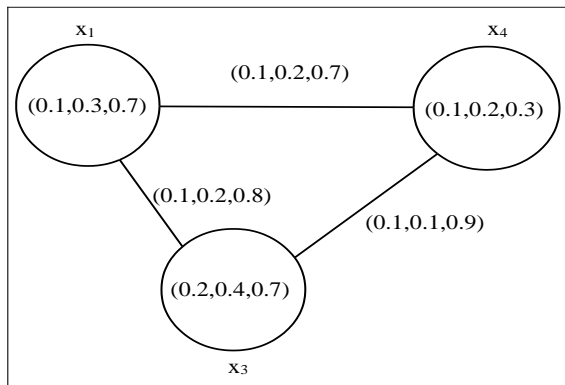

figure 7

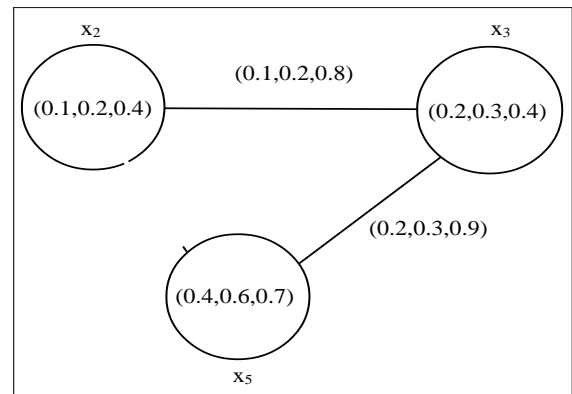

figure 9

$N(e_3)$ Corresponding to e_3

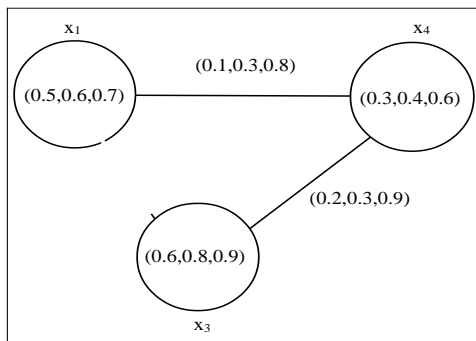

figure 8

$N(e_4)$ Corresponding to e_4

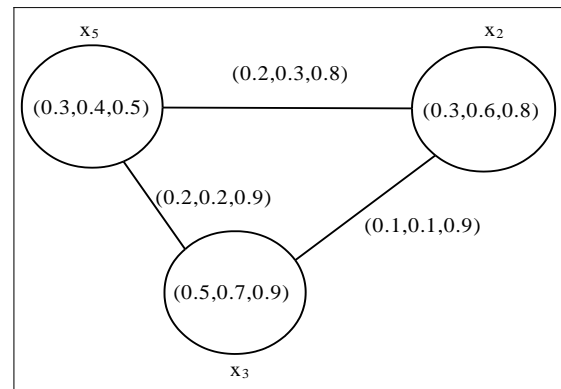

figure 10

A NSG $G_2 = (G_2^*, A_2, f^2, g^2)$ is given in Table 4 below and $T_{ge}(x_i, x_j) = 0, I_{ge}(x_i, x_j) = 0$ and $F_{ge}(x_i, x_j) = 1$, for all $(x_i, x_j) \in V_2 \times V_2 \setminus \{(x_2, x_3), (x_3, x_5), (x_2, x_5)\}$ and for all $e \in A_2$.

Table 4

f^2	x_2	x_3	x_5
e_1	(0.1,0.2,0.4)	(0.2,0.3,0.4)	(0.4,0.6,0.7)
e_2	(0.3,0.6,0.8)	(0.5,0.7,0.9)	(0.3,0.4,0.5)
g^2	(x_2, x_3)	(x_3, x_5)	(x_2, x_5)
e_1	(0.1,0.2,0.8)	(0.2,0.3,0.9)	(0,0,1)
e_2	(0.1,0.1,0.9)	(0.2,0.2,0.9)	(0.2,0.3,0.8)

$N(e_2)$ Corresponding to e_2

The union $G = (G^*, A, f, g)$ is given in Table 5 below and $T_{ge}(x_i, x_j) = 0, I_{ge}(x_i, x_j) = 0$ and $F_{ge}(x_i, x_j) = 1$, for all $(x_i, x_j) \in V \times V \setminus \{(x_1, x_4), (x_3, x_4), (x_1, x_3), (x_2, x_3), (x_3, x_5), (x_2, x_5)\}$ and for all $e \in A$.

Table 5

f	x_1	x_2	x_3	x_4	x_5
e_1	(0.1,0.2,0.3)	(0,0,1)	(0.2,0.5,0.7)	(0.2,0.3,0.4)	(0,0,1)
e_2	(0.1,0.3,0.7)	(0.1,0.2,0.3)	(0.2,0.4,0.4)	(0.1,0.2,0.3)	(0.4,0.6,0.7)
e_3	(0.5,0.6,0.7)	(0,0,1)	(0.6,0.8,0.9)	(0.3,0.4,0.6)	(0,0,1)
e_4	(0,0,1)	(0.3,0.6,0.8)	(0.5,0.7,0.9)	(0,0,1)	(0.3,0.4,0.5)

g	(x_1, x_2)	(x_2, x_3)	(x_3, x_4)	(x_4, x_5)	(x_5, x_1)
e_1	(0.1,0.2,0.7)	(0.1,0.3,0.8)	(0.1,0.2,0.8)	(0,0,1)	(0,0,1)
e_2	(0.1,0.2,0.7)	(0.1,0.1,0.9)	(0.1,0.2,0.8)	(0.1,0.2,0.8)	(0.2,0.3,0.9)
e_3	(0.1,0.3,0.8)	(0.2,0.3,0.9)	(0,0,1)	(0,0,1)	(0,0,1)
e_4	(0,0,1)	(0,0,1)	(0,0,1)	(0.1,0.1,0.9)	(0.2,0.2,0.9)

$N(e_3)$ Corresponding to e_3

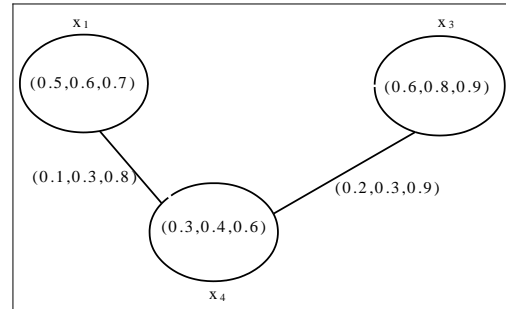

figure 13

$N(e_4)$ Corresponding to e_4

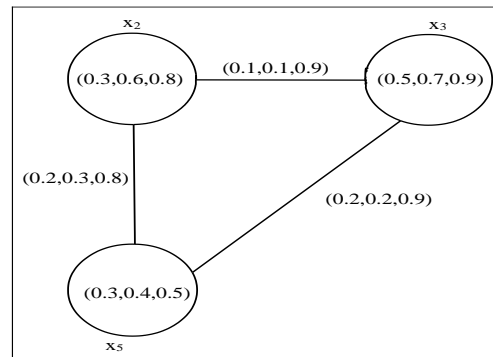

figure 14

$N(e_1)$ Corresponding to e_1

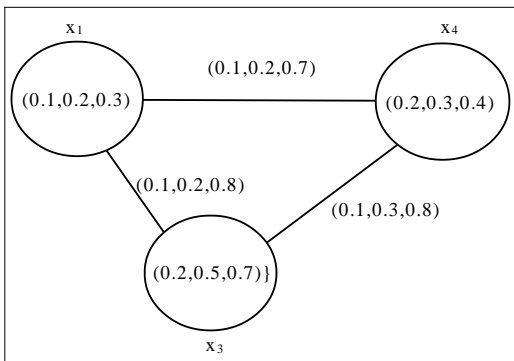

figure 11

$N(e_2)$ Corresponding to e_2

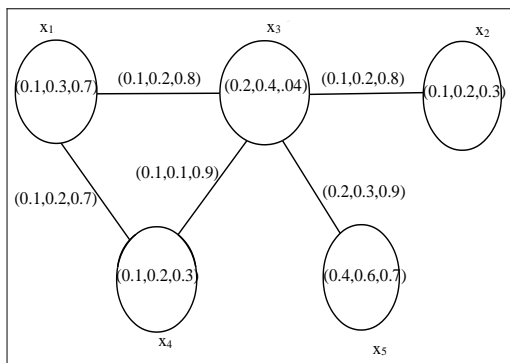

figure 12

3.8 Proposition

The union $G^* = (V, A, f, g)$ of two neutrosophic soft graph $G_1 = (G^*, A_1, f^1, g^1)$ and $G_2 = (G^*, A_2, f^2, g^2)$ is a neutrosophic soft graph.

Proof

Case i) If $e \in A_1 - A_2$ and $(x, y) \in (V_1 \times V_1) - (V_2 \times V_2)$, then

$$T_{g_e}(x, y) = T_{s_e}(x, y) \leq \min\{T_{f_e}^1(x), T_{f_e}^1(y)\}$$

$$= \min\{T_{f_e}(x), T_{f_e}(y)\}$$

so $T_{g_e}(x, y) \leq \min\{T_{f_e}(x), T_{f_e}(y)\}$

Also $I_{g_e}(x, y) = I_{s_e}(x, y) \leq \min\{I_{f_e}^1(x), I_{f_e}^1(y)\}$

$$= \min\{I_{f_e}(x), I_{f_e}(y)\}$$

so $I_{g_e}(x, y) \leq \min\{I_{f_e}(x), I_{f_e}(y)\}$

Now $F_{g_e}(x, y) = F_{s_e}(x, y) \geq \max\{F_{f_e}^1(x), F_{f_e}^1(y)\}$

$$= \max\{F_{f_e}(x), F_{f_e}(y)\}$$

Similarly If $\{e \in A_1 - A_2$ and $(x, y) \in (V_1 \times V_1) \cap (V_2 \times V_2)\}$, or

If $\{e \in A_1 \cap A_2$ and $(x, y) \in (V_1 \times V_1) - (V_2 \times V_2)\}$, we can show the same as done above.

Case ii) If $e \in A_1 \cap A_2$ and $(x, y) \in (V_1 \times V_1) \cap (V_2 \times V_2)$, then

$$T_{g_e}(x, y) = \max\{T_{g_e^1}(x, y), T_{g_e^2}(x, y)\}$$

$$\leq \max\{\min\{T_{f_e^1}^1(x), T_{f_e^1}^1(y)\}, \min\{T_{f_e^2}^1(x), T_{f_e^2}^1(y)\}\}$$

$$\leq \min\{\max\{T_{f_e^1}^1(x), T_{f_e^2}^1(x)\}, \max\{T_{f_e^1}^1(y), T_{f_e^2}^1(y)\}\}$$

$$= \min\{T_{f_e}(x), T_{f_e}(y)\}$$

Also $I_{g_e}(x, y) = \max\{I_{g_e^1}(x, y), I_{g_e^2}(x, y)\}$

$$\leq \max\{\min\{I_{f_e^1}^1(x), I_{f_e^1}^1(y)\}, \min\{I_{f_e^2}^1(x), I_{f_e^2}^1(y)\}\}$$

$$\leq \min\{\max\{I_{f_e^1}^1(x), I_{f_e^2}^1(x)\}, \max\{I_{f_e^1}^1(y), I_{f_e^2}^1(y)\}\}$$

$$= \min\{I_{f_e}(x), I_{f_e}(y)\}$$

Now $F_{g_e}(x, y) = \min\{F_{g_e^1}(x, y), F_{g_e^2}(x, y)\}$

$$\geq \min\{\max\{F_{f_e^1}^1(x), F_{f_e^1}^1(y)\}, \max\{F_{f_e^2}^1(x), F_{f_e^2}^1(y)\}\}$$

$$\geq \max\{\min\{F_{f_e^1}^1(x), F_{f_e^2}^1(x)\}, \min\{F_{f_e^1}^1(y), F_{f_e^2}^1(y)\}\}$$

$$= \max\{F_{f_e}(x), F_{f_e}(y)\}$$

Hence the union $G = G_1 \cup G_2$ is a neutrosophic soft graph.

3.9 Definition The intersection of two neutrosophic soft graphs $G_1 = (G_1^*, A_1, f^1, g^1)$ and $G_2 = (G_2^*, A_2, f^2, g^2)$ is denoted by $G = (G^*, A, f, g)$ where $A = A_1 \cap A_2, V = V_1 \cap V_2$ and the truth-membership, indeterminacy-membership and falsity-membership of intersection are as follows

$$T_{f_e}(x) = \begin{cases} T_{f_e}^1(x) & \text{if } e \in A_1 - A_2 \\ T_{f_e}^2(x) & \text{if } e \in A_2 - A_1 \\ \min\{T_{f_e}^1(x), T_{f_e}^2(x)\} & \text{if } e \in A_1 \cap A_2 \end{cases},$$

$$I_{f_e}(x) = \begin{cases} I_{f_e}^1(x) & \text{if } e \in A_1 - A_2 \\ I_{f_e}^2(x) & \text{if } e \in A_2 - A_1 \\ \min\{I_{f_e}^1(x), I_{f_e}^2(x)\} & \text{if } e \in A_1 \cap A_2 \end{cases}$$

$$F_{f_e}(x) = \begin{cases} F_{f_e}^1(x) & \text{if } e \in A_1 - A_2 \\ F_{f_e}^2(x) & \text{if } e \in A_2 - A_1 \\ \max\{F_{f_e}^1(x), F_{f_e}^2(x)\} & \text{if } e \in A_1 \cap A_2 \end{cases}$$

$$T_{g_e}(x, y) = \begin{cases} T_{g_e^1}(x, y) & \text{if } e \in A_1 - A_2 \\ T_{g_e^2}(x, y) & \text{if } e \in A_2 - A_1 \\ \min\{T_{g_e^1}(x, y), T_{g_e^2}(x, y)\} & \text{if } e \in A_1 \cap A_2 \end{cases}$$

$$I_{g_e}(x, y) = \begin{cases} I_{g_e^1}(x, y) & \text{if } e \in A_1 - A_2 \\ I_{g_e^2}(x, y) & \text{if } e \in A_2 - A_1 \\ \min\{I_{g_e^1}(x, y), I_{g_e^2}(x, y)\} & \text{if } e \in A_1 \cap A_2 \end{cases},$$

$$F_{g_e}(x, y) = \begin{cases} F_{g_e^1}(x, y) & \text{if } e \in A_1 - A_2 \\ F_{g_e^2}(x, y) & \text{if } e \in A_2 - A_1 \\ \max\{F_{g_e^1}(x, y), F_{g_e^2}(x, y)\} & \text{if } e \in A_1 \cap A_2 \end{cases} \quad \mathbf{3.10}$$

3.10 Example

Let $G_1^* = (V_1, E_1)$ be a simple graph with $V_1 = \{x_1, x_2, x_3\}$ and set of parameters $A_1 = \{e_1, e_2\}$. A NSG $G_1 = (V_1, A_1, f^1, g^1)$ is given in Table 6 below and $T_{g_e}(x_i, x_j) = 0, I_{g_e}(x_i, x_j) = 0$ and $F_{g_e}(x_i, x_j) = 1$, for all $(x_i, x_j) \in V_1 \times V_1 \setminus \{(x_1, x_5), (x_1, x_2), (x_2, x_5)\}$ and for all $e \in A_1$.

Table 6

f^1	x_1	x_2	x_5
e_1	(0.1,0.2,0.3)	(0.2,0.4,0.5)	(0.1,0.5,0.7)
e_2	(0.2,0.3,0.7)	(0.4,0.6,0.7)	(0.3,0.4,0.6)
g^1	(x_1, x_5)	(x_2, x_5)	(x_1, x_2)
e_1	(0.1,0.1,0.8)	(0.1,0.3,0.8)	(0.1,0.1,0.6)
e_2	(0.2,0.3,0.7)	(0.3,0.4,0.8)	(0.2,0.3,0.7)

$N(e_1)$ Corresponding to e_1

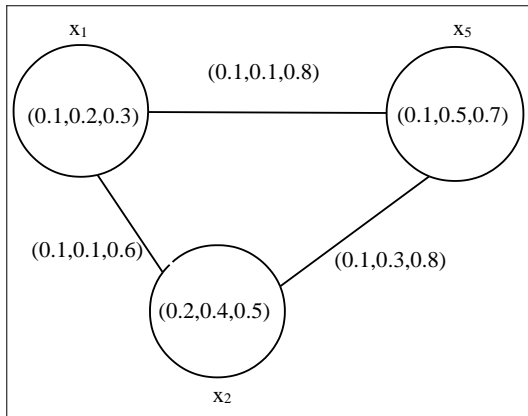

figure 15

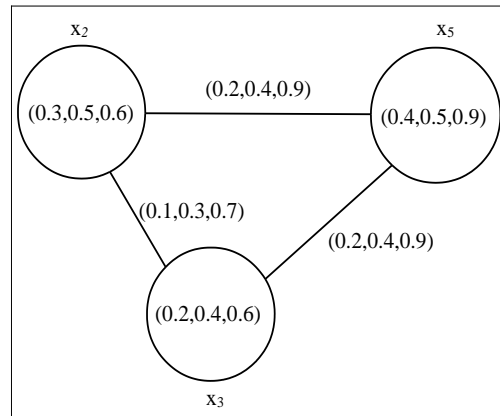

figure 17

$N(e_2)$ Corresponding to e_2

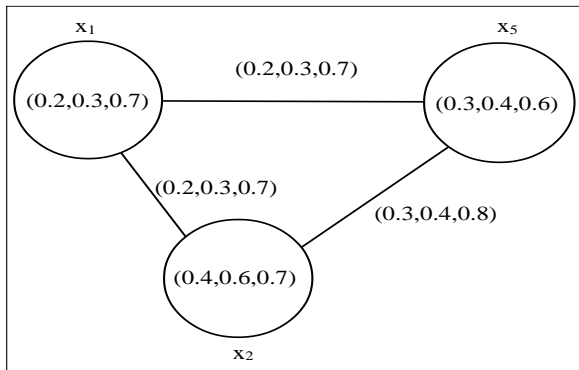

figure 16

$N(e_3)$ Corresponding to e_3

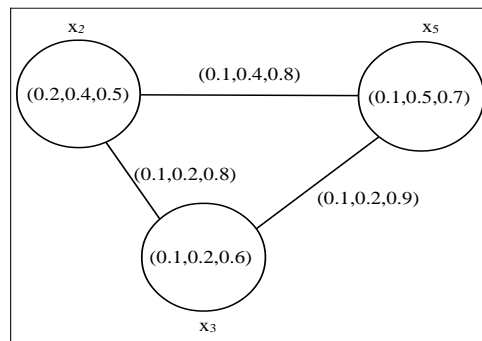

figure 18

Let $G_1^* = (V_1, E_1)$ be a simple graph with $V_1 = \{x_1, x_2, x_3\}$ and set of parameters $A_1 = \{e_1, e_2, e_3\}$. A NSG $G_1 = (V_1, A_1, f^1, g^1)$ is given in Table 7 below and $T_{ge}(x_i, x_j) = 0, I_{ge}(x_i, x_j) = 0$ and $F_{ge}(x_i, x_j) = 1$, for all $(x_i, x_j) \in V_1 \times V_1 \setminus \{(x_2, x_3), (x_3, x_5), (x_2, x_5)\}$ and for all $e \in A_1$.

Table 7.

f^2	x_2	x_3	x_5
e_2	(0.3,0.5,0.6)	(0.2,0.4,0.6)	(0.4,0.5,0.9)
e_3	(0.2,0.4,0.5)	(0.1,0.2,0.6)	(0.1,0.5,0.7)
g^2	(x_2, x_3)	(x_3, x_5)	(x_2, x_5)
e_2	(0.1,0.3,0.7)	(0.2,0.4,0.9)	(0.2,0.4,0.9)
e_3	(0.1,0.2,0.8)	(0.1,0.2,0.9)	(0.1,0.4,0.8)

Let $V = V_1 \cap V_2 = \{x_2, x_5\}, A = A_1 \cup A_2 = \{e_1, e_2, e_3\}$

The intersection of two neutrosophic soft graphs $G_1 = (G_1^*, A_1, f^1, g^1)$ and $G_2 = (G_2^*, A_2, f^2, g^2)$ is given in Table 8.

Table 8.

f	x_2	x_5	g	(x_2, x_5)
e_1	(0.2,0.4,0.5)	(0.1,0.5,0.7)	e_1	(0.1,0.3,0.8)
e_2	(0.3,0.5,0.7)	(0.3,0.4,0.9)	e_2	(0.2,0.4,0.9)
e_3	(0.2,0.4,0.5)	(0.1,0.5,0.7)	e_3	(0.1,0.4,0.8)

$N(e_1)$ corresponding to e_1

$N(e_2)$ corresponding to e_2

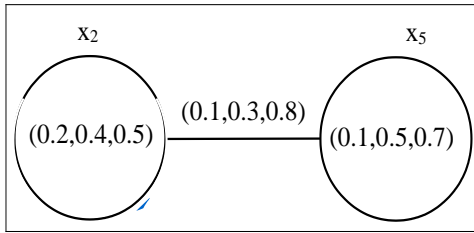

figure 19

$N(e_2)$ corresponding to e_2

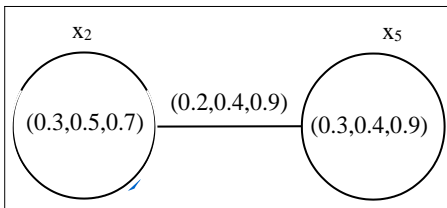

figure 20

$N(e_3)$ Corresponding to e_3

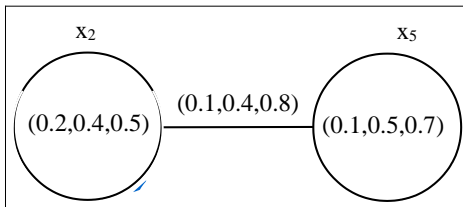

figure 21

3.11 Proposition

The intersection $G=(G^*,A,f,g)$ of two neutrosophic soft graphs $G_1=(G^*,A_1,f^1,g^1)$ and $G_2=(G^*,A_2,f^2,g^2)$ is a neutrosophic soft graph where , $A=A_1 \cup A_2$ and $V=V_1 \cap V_2$.

Proof

Case i) If $e \in A_1 - A_2$ then $T_{g_e}(x, y) = T_{g_1}(x, y)$
 $\leq \min\{T_{f_1^1}(x), T_{f_1^1}(y)\} = \min\{T_{f_e}(x), T_{f_e}(y)\}$
 so $T_{g_e}(x, y) \leq \min\{T_{f_e}(x), T_{f_e}(y)\}$

Also $I_{g_e}(x, y) = I_{g_1}(x, y) \leq \min\{I_{f_1^1}(x), I_{f_1^1}(y)\}$
 $= \min\{I_{f_e}(x), I_{f_e}(y)\}$

so $I_{g_e}(x, y) \leq \min\{I_{f_e}(x), I_{f_e}(y)\}$

Now $F_{g_e}(x, y) = F_{g_1}(x, y) \geq \max\{F_{f_1^1}(x), F_{f_1^1}(y)\}$
 $= \max\{F_{f_e}(x), F_{f_e}(y)\}$

Similarly If $e \in A_2 - A_1$ we can show the same as done above.

Case ii) If $e \in A_1 \cap A_2$ then $T_{g_e}(x, y) = \min\{T_{g_1}(x, y), T_{g_2}(x, y)\}$
 $\leq \min\{\min\{T_{f_1}(x), T_{f_1}(y)\}, \min\{T_{f_2}(x), T_{f_2}(y)\}\}$
 $\leq \min\{\min\{T_{f_1}(x), T_{f_2}(x)\}, \min\{T_{f_1}(y), T_{f_2}(y)\}\}$
 $= \min\{T_{f_e}(x), T_{f_e}(y)\}$

Also $I_{g_e}(x, y) = \min\{I_{g_1}(x, y), I_{g_2}(x, y)\}$
 $\leq \min\{\min\{I_{f_1}(x), I_{f_1}(y)\}, \min\{I_{f_2}(x), I_{f_2}(y)\}\}$
 $\leq \min\{\min\{I_{f_1}(x), I_{f_2}(x)\}, \min\{I_{f_1}(y), I_{f_2}(y)\}\}$
 $= \min\{I_{f_e}(x), I_{f_e}(y)\}$

Now $F_{g_e}(x, y) = \max\{F_{g_1}(x, y), F_{g_2}(x, y)\}$
 $\geq \max\{\max\{F_{f_1}(x), F_{f_1}(y)\}, \max\{F_{f_2}(x), F_{f_2}(y)\}\}$
 $\geq \max\{\max\{F_{f_1}(x), F_{f_2}(x)\}, \max\{F_{f_1}(y), F_{f_2}(y)\}\}$
 $= \max\{F_{f_e}(x), F_{f_e}(y)\}$

Hence the intersection $G = G_1 \cap G_2$ is a neutrosophic soft graph.

4 Strong Neutrosophic Soft Graph

4.1 Definition A neutrosophic soft graph $G=(G^*,A,f,g)$, is called strong if $g_e(x,y)=f_e(x) \cap f_e(y)$, for all $x, y \in V, e \in A$. That is if

$$T_{g_e}(x, y) = \min\{T_{f_e}(x), T_{f_e}(y)\},$$

$$I_{g_e}(x, y) = \min\{I_{f_e}(x), I_{f_e}(y)\},$$

$$F_{g_e}(x, y) = \max\{F_{f_e}(x), F_{f_e}(y)\}.$$

for all $(x, y) \in E$.

4.2 Example

Let $V = \{x_1, x_2, x_3\}, A = \{e_1, e_2\}$. A strong NSG $G=(G^*,A,f,g)$ is given in Table 9 below and $T_{g_e}(x_i, x_j) = 0, I_{g_e}(x_i, x_j) = 0$ and $F_{g_e}(x_i, x_j) = 1$, for all $(x_i, x_j) \in V \times V \setminus \{(x_1, x_2), (x_2, x_3), (x_1, x_3)\}$ and for all $e \in A$.

Table 9.

f	x_1	x_2	x_3
e_1	(0.1,0.2,0.4)	(0.2,0.3,0.5)	(0.3,0.4,0.7)
e_2	(0.3,0.6,0.8)	(0.4,0.5,0.9)	(0.3,0.4,0.5)
g	(x_1, x_2)	(x_2, x_3)	(x_1, x_3)
e_1	(0.1,0.2,0.5)	(0.2,0.3,0.7)	(0,0,1)
e_2	(0.3,0.5,0.9)	(0.3,0.4,0.9)	(0.3,0.4,0.8)

$N(e_1)$ Corresponding to e_1

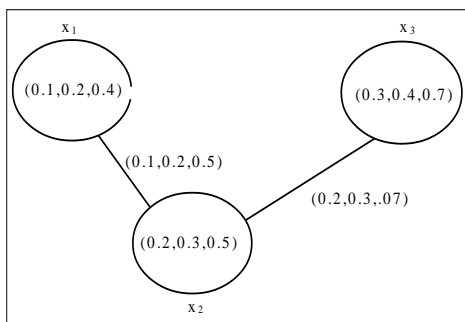

figure 22

$N(e_2)$ Corresponding to e_2

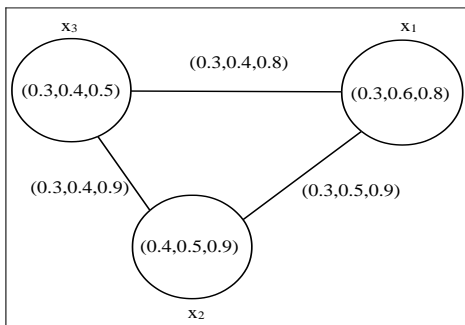

figure 23

4.3 Definition Let $G=(G^*,A,f,g)$ be a strong neutrosophic soft graph that is $g_e(x,y)=f_e(x)\cap f_e(y)$, for all for all $x,y\in V,e\in A$. The complement $\bar{G}=(\bar{G}^*,\bar{A},\bar{f},\bar{g})$ of strong neutrosophic soft graph $G=(G^*,A,f,g)$ is neutrosophic soft graph where

(i) $\bar{A} = A$

(ii) $T_{f_e}(x) = \bar{T}_{f_e}(x), I_{f_e}(x) = \bar{I}_{f_e}(x), F_{f_e}(x) = \bar{F}_{f_e}(x)$ for all $x \in V$

(iii) $\bar{T}_{f_e}(x,y) = \begin{cases} \min\{T_{f_e}(x), T_{f_e}(y)\} & \text{if } T_{g_e}(x,y) = 0 \\ 0 & \text{otherwise} \end{cases}$

$\bar{I}_{g_e}(x,y) = \begin{cases} \min\{I_{f_e}(x), I_{f_e}(y)\} & \text{if } I_{g_e}(x,y) = 0 \\ 0 & \text{otherwise} \end{cases}$

$\bar{F}_{g_e}(x,y) = \begin{cases} \max\{F_{f_e}(x), F_{f_e}(y)\} & \text{if } F_{g_e}(x,y) = 0 \\ 0 & \text{otherwise} \end{cases}$

4.4 Example

For the strong neutrosophic soft graph in previous example, the complements are given below for e_1 and e_2 .

Corresponding to e_1 , the complement of

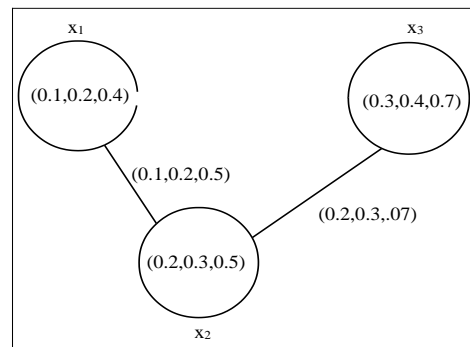

figure 24

is given by

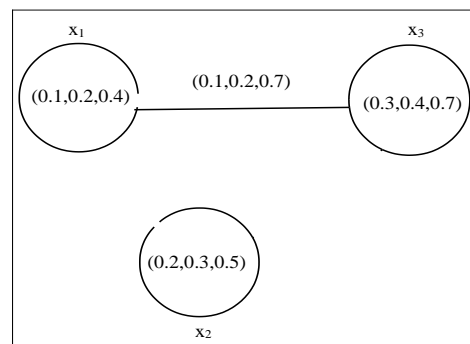

figure 25

Corresponding to e_2 , the complement of

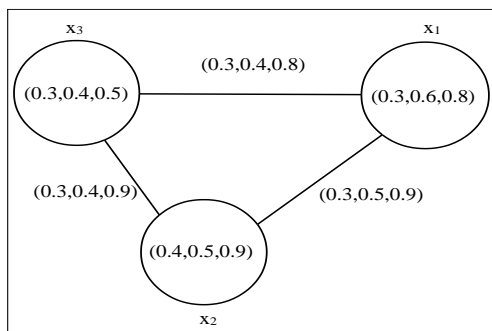

figure 26

is given by

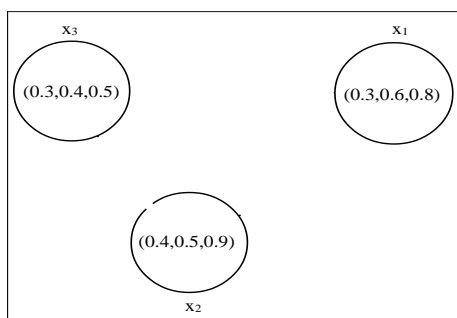

figure 27

Conclusion: Neutrosophic soft set theory is an approach to deal with uncertainty having enough parameters so that it is free from those difficulties which are associated with other contemporary theories dealing with study of uncertainty. A graph is a convenient way of representing information involving relationship between objects. In this paper we have combined both the theories and introduced and discussed neutrosophic soft graphs which are representatives of neutrosophic soft sets.

References

[1] M. Akram, Bipolar fuzzy graphs. information Sciences 181 (2011) 5548--5564 .
 [2] M. Akram, W. A. Dudek, Interval-valued fuzzy graphs. Computers and Mathematics with Applications 61(2011)289--299.
 [3] H. Aktas, Naim Cagman, Soft sets and soft groups, Information Sciences 177 (2007) 2726--2735.
 [4] M. I. Ali, F. Feng, X. Y. Liu, W. K. Min, M. Shabir, On some new operations in soft set theory, Computers and Mathematics with Applications 57 (2009) 1547--1553.1
 [5] M. I. Ali, M. Shabir, M. Nazz, Algebraic structures of

soft sets associated with new operations, Computers and Mathematics with Applications 61(9)(2011) 2647-2654.
 [6] M. Ali, and F. Smarandache, Complex Neutrosophic Set, Neural Computing and Applications, Vol. 27, no. 01. DOI: 10.1007/s00521-015-2154-y.
 [7] M. Ali, I. Deli, F. Smarandache, The Theory of Neutrosophic Cubic Sets and Their Applications in Pattern Recognition, Journal of Intelligent and Fuzzy Systems, (In press), DOI:10.3233/IFS-151906
 [8] P. Bhattacharya, Some remarks on fuzzy graphs. Pattern Recognition Letters 6 (1987) 297--302.
 [9] K. R. Bhutani, On automorphism of fuzzy graphs. Pattern Recognition Letters 9 (1989) 159--162.
 [10] K. R. Bhutani, A. Rosenfeld, Strong arcs in fuzzy graphs. Information Sciences 152 (2003) 319--322.
 [11] K. R. Bhutani, A. Rosenfeld, Fuzzy end nodes in fuzzy graphs. Information Sciences 152 (2003)323--326.
 [12] I. Deli, M. Ali, and F. Smarandache, Bipolar Neutrosophic Sets And Their Application Based On Multi-Criteria Decision Making Problems. (Proceeding of the 2015 International Conference on Advanced Mechatronic Systems, Beijing, China, August 22-24, 2015. IEEE Xplore, DOI: 10.1109/ICAMEchS.2015.7287068
 [13] L. Euler, Solutio problematis ad geometriam situs pertinentis, Commentarii Academiae Scientiarum Imperialis Petropolitanae 8 (1736) 128--140
 [14] A. Hussain, M. Shabir, Algebraic Structures Of Neutrosophic Soft Sets, Neutrosophic Sets and Systems, 7,(2015) 53-61.
 [15] P.K. Maji, R. Biswas, R. Roy, An application of soft sets in decision making problems, Computers and Mathematics with Applications 44 (2002) 1077--1083.
 [16] P. K. Maji, R. Biswas, R. Roy, Soft set theory, Computers and Mathematics with Applications 45 (2003) 555--562.
 [17] P.K. Maji, Neutrosophic soft set, Annals of Fuzzy Mathematics and Informatics, 5(1) (2013) 157-168.
 [18] D. Molodtsov, Soft set theory-first results, Computers and Mathematics with Applications 37 (1999) 19--31.
 [19] K. H. Rosen, Discrete Mathematics and its Applications, McGraw-Hill, Washington, 1995.
 [20] A. Rosenfeld, Fuzzy Graphs, Fuzzy Sets and their Applications to Cognitive and Decision Process, M.Eds. Academic Press, New York, 77-95, 1975.
 [21] F. Smarandache, Neutrosophic Set, a generalisation of the intuitionistic fuzzy sets, Inter. J. Pure Appl. Math. 24 (2005) 287{297.
 [22] F. Smarandache, Neutrosophy. *Neutrosophic Probability, Set, and Logic*, Amer. Res. Press, Rehoboth, USA, 105 p., 1998 ; <http://fs.gallup.unm.edu/eBook-neutrosophics4.pdf> (4th edition).
 [23] F. Smarandache, Neutrosophic Graphs, in his book Symbolic Neutrosophic Theory, EuropaNova,

Brussels, 2015.

- [24] G. S. Singh, Graph theory, PHI Learning limited, New Delhi-110001 (2010).
- [25] C. Vasudev, Graph theory with applications, New age international publishers (2006) .
- [26] L.A. Zadeh, Fuzzy sets, Information and Control 8 (1965) 338--353.

Received: Feb. 20, 2016. Accepted: Mar. 30, 2016



Mapping Causes and Implications of India's Skewed Sex Ratio and Poverty problem using Fuzzy & Neutrosophic Relational Maps

Gaurav¹, Megha Kumar², Kanika Bhutani³ and Swati Aggarwal^{4*}

¹ TCS, India. E-mail: gauravgarg2209@gmail.com

² Delhi Technical Campus, Greater noida, India. E-mail: meghakumar245@gmail.com

³ NIT Kurukshetra, Kurukshetra, India. E-mail: kanikabhutani91@gmail.com

⁴ NSIT Dwarka, India. E-mail: swati1178@gmail.com, *Corresponding author

Abstract. Numerous studies by different researchers have confirmed that skewed sex ratio is a critical social problem in India. This enduring problem of gender imbalance is the collective result of factors like sex selective abortion, gender discrimination, son preference for the preservation of tribe, emergence of new technologies in medical field and many more factors. Another severe problem to be addressed in India is poverty. Many factors contribute to the perpetuation of poverty such as illiteracy, bad governance, under employment and various other reasons. Despite of India's accelerated growth rate, poverty in India is still prevalent.

This paper employs a new soft computing based methodology for identifying and analyzing the relationships among the causes and implications of the two challenging problems in India: unbalanced sex

ratio and poverty. The methodology proposed by authors is based on Linked Fuzzy Relational Maps which is a variation to Fuzzy Relational Maps and Linked Neutrosophic Relational Maps which is a variation to Neutrosophic Relational Maps. The relationships among the causes and consequences can be easily drawn through the given methodologies. The authors have implemented two models for the two social problems under study, one using Fuzzy Relational Maps and the other using Neutrosophic Relational Maps. Neutrosophic Relational Maps can support decision making on uncertain and indeterminate data. Authors have demonstrated that the model implemented using Neutrosophic Relational Maps presents more realistic and sensitive results as compared to the model using Fuzzy Relational Maps.

Keywords: Skewed Sex Ratio; Poverty; Fuzzy Relational Maps; Linked Fuzzy Relational Maps; Neutrosophic Relational Maps; Linked Neutrosophic Relational Maps.

1 Introduction

1.1 Sex ratio

India has significantly enhanced against multiple socio-economic indicators over the last few decades including level of economic growth, health related services, level of nutrition, level of education and status of women, but it has not been as victorious at achieving gender equality. One significant measure of this inequality in India is the country's sex ratio, defined as the number of females per 1000 males in the population, whereas internationally, sex ratio is defined as number of males per 100 females [4]. In this paper, authors follow the first definition. Son preference over daughter is an issue in many parts of the world. But with social and economic changes and rise in women's status, the preference for a son over daughter has declined in many countries. However it is still observed in some

parts of the world mainly from East Asia to South Asia, particularly in China and India [12].

COUNTRY	CENSUS 2011		CENSUS 2001	
	SEX RA-TIO	CHILD SEX RA-TIO	SEX RA-TIO	CHILD SEX RA-TIO
India	943	919	933	927

Table 1 Sex Ratio of India, (Census data Sex ratio 2011)

The attributes associated with causes and consequences that result in deteriorating or improving the status of skewed sex ratio in India are described in Table 2.

Causes	Gender Equality in education and employment	This attribute helps in balancing the sex ratio as equal rights are given to boys as well as girls.	[5]	Consequences		sexual slavery etc.	
					Surplus men	Imbalance of sex ratio leads to more number of males than females.	[11]
	Literacy rate	If parents are educated then there are minor chances of discrimination between a boy and a girl.	[27]		Geographical spread in marriage market.	The females are traveled from one part of country to another for the purpose of marriage.	[8]
	Emergence of new technologies	With the emerging technology like ultrasound, there are more chances of sex abortions which leads to decline in sex ratio.	[9]		Inter-generational relationships	These are the relationships between persons of different generations.	[6]
	Sons preferred, preservation of the clan	Parents always prefer a boy child as they think boys earn more, have more rights and carry the family name.	[2]		Polyandrous relationships	Due to shortage of brides, a female is married to number of males leading to polyandry.	[26]
	Government and NGOs awareness campaigns	They conduct various awareness campaigns regarding no discrimination between male and female, equal rights to both male and female.	[19]		Homosexual relationships	These are the relationships between same sex of people due to decline in sex ratio.	[18]
	Government support for girl child	They are taking some steps to decrease the sex ratio like beti bachao beti padhao yojana, ladli scheme etc.	[14]		Cross class and cross caste marriages	Due to shortage of females, inter-caste marriages are encouraged in India.	[1]
					Economic condition of the country	The economic condition of the country is improved by providing equal opportunity in education and employment to both boys and girls.	[3]
	Female sex abuse	India is a male dominating country, every parent prefers a boy child which leads to sex selective abortions.	[13,15]		Women empowerment	Women are given equal rights and opportunities to increase their power so as to balance the sex ratio.	[16]
	Women trafficking	Due to decline in sex ratio, girls are more exploited and moved from one place to another for the purpose of forced labor,	[22]				

Table 2: Causes and consequences of sex ratio

1.2 Poverty

Poverty is multidimensional deprivation in income, illiteracy, malnutrition, mortality, morbidity and vulnerabil-

ity to economic shocks[17].Overcoming poverty in India is a key challenge; one third of the world's poor live in India. According to World Bank estimation,68% of the population live on less than **US\$ 2** a day [29]. UNICEF latest report shows that one in three Indian children is malnourished or underweight [30].

According to 2011 poverty Development Goals Report, around 320 million people in India and China are expected to be no more part of poverty in the next four years, with the estimation that India's poverty rate will fall from **51% in 1990** to about **22% in 2015** [28].

	Poverty Ratio (%)			Number of Poor (million)		
	Rural	Urban	Total	Rural	Urban	Total
1993-94	50.1	31.8	45.3	328.6	74.5	403.7
2004-05	41.8	25.7	37.2	326.3	80.8	407.1
2011-12	25.7	13.7	21.9	216.5	52.8	269.3
Annual Average Decline 1993-94 to 2004-05(percentage points per annum)	.75	.55	.74			
Annual Average Decline 2004-05 to 2011-12(percentage points per annum)	2.32	1.69	2.18			

Table 3:Percentage and number of poor estimated in India, (Census 2011)

The attributes associated with causes and consequences that result in deteriorating or improving the status of poverty in India are described in Table 4.

Causes	Literacy rate	Literacy rate directly affects poverty as with increased literacy, more opportunities of employment is available.	[7]
	Emergence	Due to	[9]

Consequences	of new technologies	emergence of new technology millions of jobs have been created in private and public enterprises.	
	Overpopulation	With limited jobs and resources overpopulation tends to increase poverty.	[21]
	Government support for girl child	Due to government support to the girl child, numerous job opportunities have been provided to female candidates.	[23]
	Female sex abuse	Poverty would lead to poor conditions for women and female sex abuse being one of them.	[13]
	Women trafficking	Poor jobless people will get drawn to unethical jobs and may be willing to do anything for money.	[22]
	Inter-generational relationships	Poverty will directly affect the living conditions of a family and will affect the mindset of	[6]

		all the generations in the family.	
Economic condition of the country	With increase in poverty, the economic condition of a country would worsen.		[3]
Mass emigration	People will tend to immigrate to other countries in search of jobs.		[10]
Terrorism	Poverty will lead people to take steps in favor of terrorism when money will be promised to them in return for their services.		[20]
Malnutrition	Due to poverty, a family will not be able to get adequate food or nutrition leading to malnutrition.		[24]

Table 4 : Causes and consequences of poverty

This paper uses the relational maps to map relations among different factors. Authors proposed two soft computing based methodologies Fuzzy relational maps (FRM) and Neutrosophic relational maps (NRM), for highlighting the causes and implications of skewed sex ratio and poverty problem pervasive in India. FRMs divides problem space into domain and range space, thereby represent the relationship between the elements of domain and range space. When the data under analysis is indeterminate, there

is no definite relation between concepts but interrelation between concepts exists in a hidden way. In real life situations indeterminate relations can be seen everywhere i.e. Consider a situation where it is difficult to decide whether a relation between two concepts exists or not. The probability that a person wins an election is 35% true, 25% false and 40% indeterminate i.e. percentage of people giving a blank vote or not giving a vote. FRM cannot handle such data. NRM is an innovative technique for processing data uncertainty and indeterminacy while observing impacts among various factors to obtain more sensitive results.

The remaining of the paper is organized as follows. Section 2 presents Relational Maps. Section 3 presents basics of FRMs, Linked FRMs and gives a model based on FRM for studying India’s skewed sex ratio and poverty problem. Section 4 introduces the NRM and Linked NRM methodology developed. This section gives a model based on NRM for studying India’s skewed sex ratio and poverty problem. Section 5 details discussion of results. Finally, section 6 outlines the conclusion.

2 Relational Maps

A relational map is related to cognitive map, which is also known as mental map. It is a representation and reasoning model on causal knowledge [32]. It is a labeled, directed and cyclic graph with disjoint set of nodes and edges represent causal relations between these set of nodes . A relational map represents knowledge (useful information) which further helps to find hidden patterns and support in decision making. Fuzzy Relational Maps are relational maps which use fuzzy values in domain $\{0, 1\}$. This represent the cases of existence and nonexistence of relations between nodes but indeterminacy between the relations are not represented. F. Smarandache proposed Neutrosophic Relational Maps which is an extension of fuzzy relational maps that can represent and handle indeterminate relations [31].

3 Fuzzy Relational Maps

W.B.Vasanth et.al(2000) introduced a new methodology called Fuzzy Relational Maps which is an extension of Fuzzy Cognitive Maps (FCM) and is used in applications like banking [33], IT expert systems [25] etc. In FRM, the problem space is divided into a domain space D and a range space R . There are relationships that exist between the domain space and range space concepts. No intermediate relations exist between the concepts within the domain or range space.

3.1 Basics of FRM

A FRM is a directed graph from Domain D (dimension m) to Range R (dimension n) such that $D \cap R = \varphi$, with concepts as nodes. The concepts represented as variables describe the behavior of system and the edges repre-

sent the relationships among the concepts which can be either positive or negative. The positive relationship shows that the effect variable undergoes a change in the same direction and negative relationship shows that the effect variable undergoes a change in the opposite direction [32].

Let x denote concepts of the range space or the domain space, where $x = \{0 \text{ or } 1\}$

If $x = 1$, represents the on state of the node.

If $x = 0$, represents the off state of the node.

Let D_i and R_j denote the two concepts of FRM. The directed edge from D_i to R_j denote the relation or effect of D_i on R_j . The edge has the value which lies in the range $\{0, +1, -1\}$.

Let e_{ij} be the edge $D_i R_j$ weight and $e_{ij} \in \{0, +1, -1\}$.

If $e_{ij} = 1$ decrease in D_i implies decrease in R_j or increase in D_i implies increase in R_j .

If $e_{ij} = 0$, then there is no effect of D_i on R_j .

If $e_{ij} = -1$, then decrease in D_i infers increase in R_j or increase in D_i implies decrease in R_j .

3.2 Linked FRM methodology

W.B. Vasantha et.al [31] also introduced yet another new technique to help in decision making using FRMs called Linked FRMs which is not feasible in case of FCMs. This methodology is more adaptable in those cases of data where two or more systems are inter-related in some way but we are not in a position to inter-relate them directly. Assume we have 3 disjoint sets of concepts, say space P (m set of nodes), Q (n set of nodes) and R (r set of nodes). We can directly find FRMs relating P and Q , FRMs relating Q and R but we are not in a position to link or get a direct relation between P and R but in fact there exists a hidden link between them which cannot be easily weighted.

The linked FRM methodology developed uses FRMs connecting three distinct spaces P (m nodes), Q (n nodes) and R (r nodes) in such a way that by using the pairs of FRMs between P & Q and Q & R we obtain FRM relating P & R .

Let E_1 be the causal matrix between P and Q of order $m \times n$ and E_2 be the causal matrix between Q and R of order $n \times r$. Now cross product of E_1 & E_2 gives a matrix which is the causal matrix relating P and R .

3.3 Hidden pattern for FRM

Let $D_i R_j$ (or $R_j D_i$) be an edge from D_i to R_j . D_i is the i th node in domain space and R_j is the j th node in range space where $1 \leq j \leq m$ and $1 \leq i \leq n$. When R_i (or D_j) is switched on and if causality flows through edges of the cycle and if it again causes R_i (or D_j), we say that the dynamical system goes round and round. This is true for any node R_j (or D_i) for $1 \leq i \leq n$, or

$(1 \leq j \leq m)$. The equilibrium state of this dynamical system is called the hidden pattern [30].

If the equilibrium state of a dynamical system is a unique state vector, then it is called a fixed point.

Consider an FRM with $(R1, R2, \dots, Rm)$ and $(D1, D2, \dots, Dn)$ as nodes.

For example, let us start the dynamical system by switching on $R1$ (or $D1$).

If the FRM settles down with $R1$ and Rm (or $D1$ and Dn) on, eg. the state vector remains as $(1, 0, \dots, 0, 1)$ in R or $(1, 0, \dots, 0, 1)$ in D . This state vector is called the fixed point.

If the FRM settles down with a state vector repeating in the form

$(A1 \rightarrow A2 \rightarrow A3 \rightarrow \dots \rightarrow Ai \rightarrow A1)$ Or $(B1 \rightarrow B2 \rightarrow B3 \rightarrow \dots \rightarrow Bi \rightarrow B1)$ this equilibrium is called a limit cycle.

3.4 MODEL: Implementation of linked FRM model in study of skewed sex ratio and poverty problem

The sex ratio and poverty problem in India are two of the major problems which are discussed in this section. There are three sets of conceptual nodes in three spaces. The spaces under study are P , Q and R where

P - The attributes associated with causes that result in deteriorating or improving the status of poverty and skewed sex ratio in India,

Q - Attributes representing the two problems, and

R - Attributes associated with resultant implications of the two problems under study.

The attributes / concepts used in the model are given below:

P - The attributes associated with various causes of poverty and unbalanced sex ratio. Though there could be many such attributes but here the authors have prominently categorized 7 important causes in P .

$P1$ - Gender Equality in education and employment

$P2$ - Literacy rate

$P3$ - Emergence of new technologies

$P4$ - Overpopulation

$P5$ - Sons preferred, preservation of the clan

$P6$ - Government and NGOs awareness campaigns, which aim to change the people's mindset and attitude towards girls

$P7$ - Government's support to families that have girl child for example direct subsidies at the time of birth, female quotas, scholarships and old age pensions

Q - The attributes representing the problems under study.

Q1 – Skewed sex ratio

Q2 – Poverty

R – The attributes associated with the various implications. Here the authors have basically taken 13 important possible such consequences. Though there could be many more.

R1 – Female sex abuse

R2 – Women trafficking

R3 – Surplus men, more unmarried men still in marriage market

R4 – Geographical spread in marriage market

R5 – Inter-generational relationships, young girls getting married with much older men

R6 – Polyandrous relationships, where one women is married to multiple men

R7 – Homosexual relationships

R8 – Cross class and cross caste marriages

R9 – Economic condition of the country

R10 – Women empowerment

R11 – Mass emigration

R12 – Terrorism

R13 – Malnutrition

Subsequent to the deliberations with the researchers working in this domain, the authors generated the relational directed graph of the model for spaces P & Q and Q & R as shown in Fig. 1a and 1b.

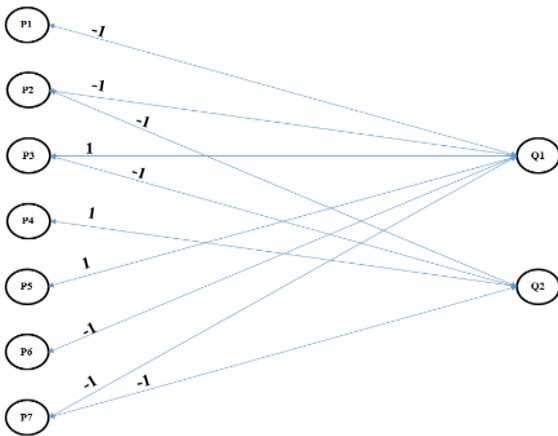

Figure. 1a FRM for spaces P and Q

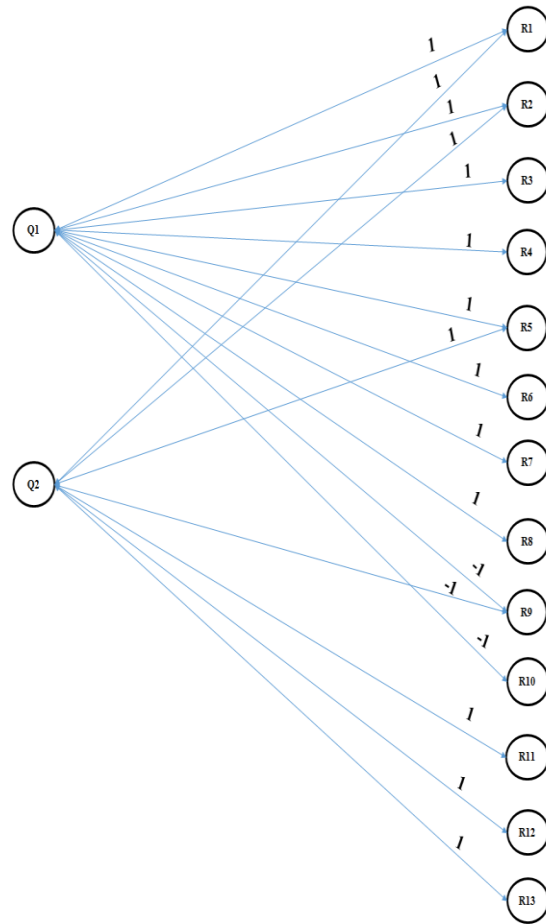

Figure. 1b FRM for spaces Q and R

The relational or connection matrix for spaces P & Q and Q & R can be constructed as given by table 5a and table 5b.

CAUSES	Q1	Q2
P1	-1	0
P2	-1	-1
P3	1	-1
P4	0	1
P5	1	0
P6	-1	0
P7	-1	-1

Table 5a FRM Matrix (E1) for **P** and **Q**

IM-PLI CA TIO NS	R1	R2	R3	R4	R5	R6	R7	R8	R9	R10	R11	R12	R13
										0	1	1	3
Q1	1	1	1	1	1	1	1	1	-1	-1	0	0	0
Q2	1	1	0	0	1	0	0	0	-1	0	1	1	1

Table 5b FRM Matrix (E2) for Q and R

Thus E1 is a 7 × 2 matrix and E2 is a 2 × 13 matrix. E1 × E2 gives the relational matrix which is a 7 × 13 matrix say E, known as the hidden connection matrix, as shown in Table 6.

Caus- es\Implic ations	R1	R2	R3	R4	R5	R6	R7	R8	R9	R10	R11	R12	R13
P1	-1	-1	-1	-1	-1	-1	-1	-1	1	1	0	0	0
P2	-1	-1	-1	-1	-1	-1	-1	-1	1	1	-1	-1	-1
P3	0	0	1	1	0	1	1	1	0	-1	-1	-1	-1
P4	1	1	0	0	1	0	0	0	-1	0	1	1	1
P5	1	1	1	1	1	1	1	1	-1	-1	0	0	0
P6	-1	-1	-1	-1	-1	-1	-1	-1	1	1	0	0	0
P7	-1	-1	-1	-1	-1	-1	-1	-1	1	1	-1	-1	-1

Table 6 Hidden FRM Matrix (E) for P and R

Thus, by this method even if the authors were not in a position to get directed graph, authors could indirectly obtain the FRMs relating them. Now using these three FRMs and their related matrices, conclusion is derived by studying the effect of each state vector.

For the given model,

First take initial vector A1 by keeping P2 i.e. literacy rate in ON state.

Let E = Hidden connection matrix for P and R

Initial state vector A1 should pass through the relational matrix E.

This is done by multiplying A1 with the relational matrix E.

Let $A1E = (r1, r2, \dots, rm)$

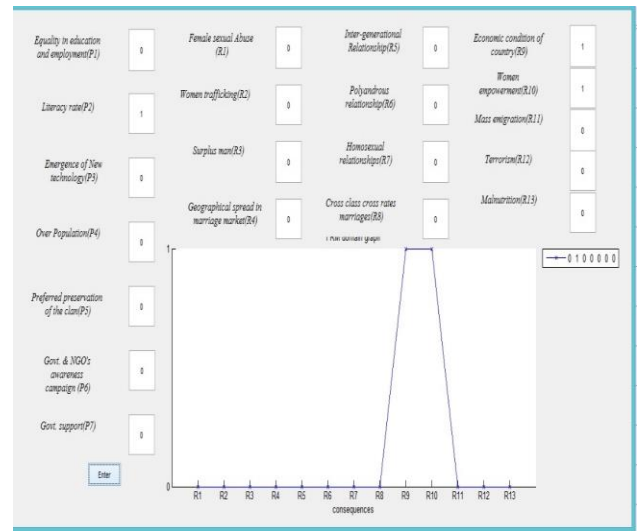

Figure. 2 Problem simulation using MATLAB for FRM when 'Literacy Rate' is ON

After thresholding and updating the resultant vector we get $A2 = A1E \in R$. Now pass A2 into ET and calculate $A2ET$.

Update and threshold the vector A2ET such that vector A3 is obtained and $A3 \in D$.

This procedure is repeated till we get a limit cycle or a fixed point.

$A1 = (0\ 1\ 0\ 0\ 0\ 0\ 0)$
 $A1E = (0\ 0\ 0\ 0\ 0\ 0\ 0\ 0\ 1\ 1\ 0\ 0\ 0) = A2$
 $A2E = (1\ 1\ 0\ 0\ 0\ 1\ 1) = A3$
 $A3E = (0\ 0\ 0\ 0\ 0\ 0\ 0\ 1\ 1\ 0\ 0\ 0) = A4$
 Hence, $A4 = A2$ we got a fixed point.
 Problem simulation using MATLAB

The authors have created a graphical user interface using MATLAB as shown in Fig. 2

The GUI takes input from the user which can be either 0 or 1, where 1 represents the concept is in ON state and 0 represents the OFF state. The GUI contains a graph which shows the impact on various concepts based on the initial state vector taken as input.

Resultant vector can have two outputs:

'1' represents the existence of relation among the concepts, whereas '0' represents that there is no causal relationship.

3.5 Limitations of FRM

The concepts for which the experts are not in a position to draw any relations, i.e. concepts may or may not have causal effects, cannot be associated in FRMs. The edges can take either of the values **0,1** or **-1** as shown in Table 5a and Table 6. An expert may not always be able to make certain decisions on the relation between two nodes. This drawback can be overcome by using Neutrosophic Relational Maps which support decision-making under uncertainty in dynamic systems as shown in Table 7 and Table 8.

In FRMs, either a relation exists or do not exist, but this will not always be true in case of real world problems. When the data under analysis is unsupervised data, the relation can be indeterminate like considering a relation where skewed sex ratio may or may not lead to homosexual relations as it depends upon the mindset of the individuals. In such cases only NRMs are better applied than FRMs. Thus NRMs play a better role and give a sensitive result than the FRMs as shown in Table 10.

Fuzzy world is about fuzzy data and fuzzy membership but it has no capacity to deal with indeterminate concepts.

Thus with the help of NRM, whenever in the resultant data indeterminacy is observed i.e. the symbol **I**, the person who analyze the data can deal with more caution thereby getting sensitive results rather than treating the nonexistence or associating **0** to that co-ordinate.

4 Neutrosophic Relational Maps

NRM is an extension of FRM where indeterminacy is included [32]. The concept of fuzzy relational maps fails to deal with the indeterminate relation. Neutrosophic logic is the soft computing technique which is able to support incomplete information i.e. it deals with the notions of indeterminacy.

The input state vectors are always taken as the real state vectors i.e. the node or the concept is in the on state or in the off state but when we are indeterminate about any concept then it is represented as indeterminate, with the symbol **I**.

4.1 Basics of NRM

Let **D** be the domain space with nodes **D1, ..., Di** and **R** be the range space with the conceptual nodes **R1, ..., Rj, i ∈ 1 ... n** and **j ∈ 1 ... m** such that they form a disjoint class i.e. **D ∩ R = φ**. Suppose there is a FRM relating **D** and **R** and if any edge relating

Di Rj is indeterminate then we call the FRM as the Neutrosophic Relational Maps (NRMs).

Every edge in the NRM is weighted with a number in the set **{0, +1, -1, I}**.

Let e_{ij} be the edge $D_i R_j$ weight and $e_{ij} \in \{0, +1, -1, I\}$.

If $e_{ij} = 1$ decrease in D_i implies decrease in R_j or increase in D_i implies increase in R_j .

If $e_{ij} = 0$, then there is no effect of D_i on R_j .

If $e_{ij} = -1$, then decrease in D_i infers increase in R_j or increase in D_i implies decrease in R_j .

If $e_{ij} = I$ it implies that the effect of D_i on R_j is indeterminate so we denote it by **I**.

4.2 NRM hidden patterns

Let $D_i R_j$ (or $R_j D_i$) $1 \leq j \leq m$, $1 \leq i \leq n$, when R_j (or D_i) is switched on and if causality flows through edges of a cycle and if it again causes R_j (or D_i) we say that the Neutrosophical dynamical system goes round and round. This is true for any node R_j (or D_i) for $1 \leq j \leq m$ (or $1 \leq i \leq n$). The equilibrium state of this Neutrosophical dynamical system is called the Neutrosophic hidden pattern.

Fixed point and Limit cycle in an NRM

If the equilibrium state of a Neutrosophical dynamical system is a unique Neutrosophic state vector, then it is called the fixed point.

Consider an NRM with R_1, R_2, \dots, R_m and D_1, D_2, \dots, D_n as nodes.

For example let us start the dynamical system by switching on R_1 (or D_1). Let us assume that the NRM settles down with R_1 and R_m (or D_1 and D_n) on, or indeterminate, eg. the Neutrosophic state vector remains as $(1, 0, 0, \dots, 1)$ or $(1, 0, 0, \dots, I)$ in R or $(1, 0, 0, \dots, 1)$ or $(1, 0, 0, \dots, I)$ in D , this state vector is called the fixed point.

If the NRM settles down with a state vector repeating in the form

$(A_1 \rightarrow A_2 \rightarrow A_3 \rightarrow \dots \rightarrow A_i \rightarrow A_1)$ or $(B_1 \rightarrow B_2 \rightarrow B_3 \rightarrow \dots \rightarrow B_i \rightarrow B_1)$ then this equilibrium is called a limit cycle.

Now we proceed on to define the notion of linked NRM as in the case of FRM.

This methodology is more adaptable in those cases of data where two or more systems are inter-related in some way but we are not in a position to inter-relate them directly i.e. cases where related conceptual nodes can be parti-

tioned into disjoint sets. Such study is possible only by using linked NRMs.

Assume we have 3 disjoint sets of concepts, say spaces P (m set of nodes), Q (n set of nodes) and R (r set of nodes). We can directly find NRMs relating P and Q , NRMs relating Q and R but we are not in a position to link or get a direct relation between P and R but in fact there exists a hidden link between them which cannot be easily weighted; in such cases we use linked NRMs where using the pair of NRMs we obtain a resultant NRM.

4.3 Linked NRM Methodology

The methodology developed uses NRMs connecting three distinct spaces namely, P (m nodes), Q (n nodes) and R (r nodes) in such a way that using the pairs of FRMs between P & Q and Q & R we obtain FRM relating P & R (VasanthaKandasamy & Sultana, 2000).

If $E1$ is the connection matrix relating P and Q then $E1$ is a $m \times n$ matrix and $E2$ is the connection matrix relating Q and R which is a $n \times r$ matrix. Now $E1E2$ is a $m \times r$ matrix which is the connection matrix relating P and R and $E2^T E1^T$ matrix relating R and P , when we have such a situation we call it the pair wise linked NRMs.

4.4 MODEL: Implementation of linked NRM model in study of skewed sex ratio and poverty problem

Recall the model in section 3.4 where the study of sex ratio and poverty is carried out using linked FRM where no indeterminacy is considered.

Now instead of FRM we instruct the expert that they need not always state the presence or absence of relation between any two concepts but they can also spell out the missing relations between two concepts, with these additional instruction to the expert, the opinions are taken.

In order to implement our model using linked NRM, we take the same three sets of conceptual nodes in three spaces as taken in section 3.4 i.e. the spaces under study are P , Q and R .

The attributes / concepts used in the model can be referred from section 3.4.

In our model the relations where indeterminacy can be represented are:

$P1$ (Gender Equality in education and employment) \rightarrow $Q2$ (Poverty)

If there is equality in education and employment i.e. women are given equal opportunity to study and earn for their families then there may be a possibility that there might be a decline in poverty, but we cannot conclude this for sure(refer Table 5a).

$Q1$ (Skewed sex ratio) \rightarrow $R7$ (homosexual relationships)

If there exists imbalance in male to female ratio then there would be surplus men. There is a possibility that the situation would lead to more homosexual relations in shortage of women(refer Table 5b).

Other indeterminacies between nodes introduced in this model are highlighted in the Table 7 and Table 8.

Taking the expert opinion, the authors give the Neutrosophic Relational maps as shown in Fig. 3a and Fig. 3b.

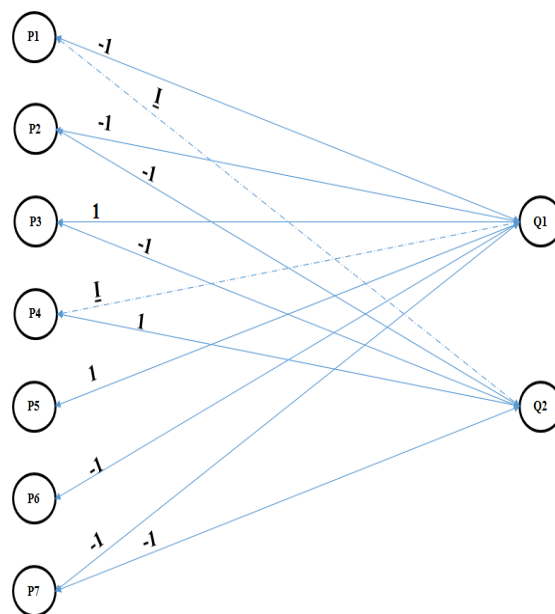

Figure. 3a NRM for spaces P and Q

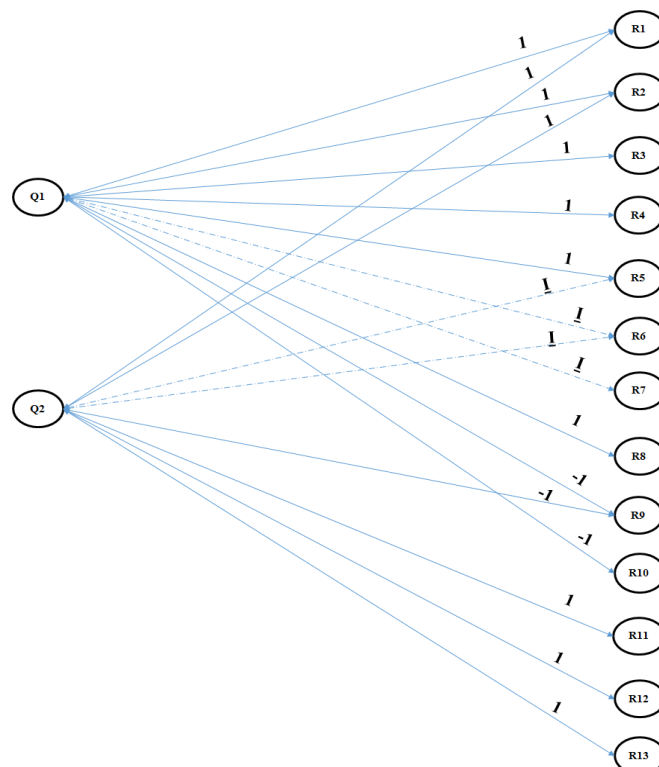

Figure. 3b NRM for spaces Q and R

The matrices for the three NRMs formulated which can contain the values from set $\{0, 1, -1, I\}$ are given by:

CAUSES	Q1	Q2
P1	-1	I
P2	-1	-1
P3	1	-1
P4	I	1
P5	1	0
P6	-1	0
P7	-1	-1

Table 7 NRM Matrix for **P** and **Q**

IMPLI-CATI-ONS	R 1	R 2	R 3	R 4	R 5	R 6	R 7	R 8	R 9	R 10	R 11	R 12	R 13
Q1	1	1	1	1	1	I	I	1	-1	-1	0	0	0
Q2	1	1	0	0	I	I	0	0	-1	0	1	1	1

Table 8 NRM Matrix for **Q** and **R**

Cau ses/I mpli cati- ons	R 1	R 2	R 3	R 4	R 5	R 6	R 7	R 8	R 9	R 10	R 11	R 12	R 13
P1	-1	-1	-1	-1	-1	0	I	-1	1	1	I	I	I
P2	-1	-1	-1	-1	-1	I	I	-1	1	1	-1	-1	-1
P3	0	0	1	1	1	0	I	1	0	-1	-1	-1	-1
P4	1	1	I	I	I	I	I	I	-1	I	1	1	1
P5	1	1	1	1	1	I	I	1	-1	-1	0	0	0
P6	-1	-1	-1	-1	-1	I	I	-1	1	1	0	0	0
P7	-1	-1	-1	-1	-1	I	I	-1	1	1	-1	-1	-1

Table 9 Hidden NRM Matrix for **P** and **R**

The 'I' factor was introduced in the NRM matrix. The hidden pattern using Linked NRM was calculated as, $N(E)$ Hidden connection matrix with indeterminacy added. (Table 9)

I =Indeterminacy

The hidden pattern for Linked NRM is calculated as follows:

We first take same initial vector (as in section 3.4)

A1 by keeping **P2**, literacy rate in ON state

If **A1** = (0 1 0 0 0 0),

$$A1N(E) = (0 0 0 0 0 1 1 0 1 1 0 0 0) = A2$$

$$A2N(E) = (1 1 0 0 0 1 1) = A3$$

$$A3N(E) = (0 0 0 0 0 1 1 0 1 1 0 0 0) = A4$$

Problem simulation using MATLAB

The authors have created a graphical user interface using MATLAB as shown in Fig. 4.

The GUI takes input from the user which can be either 0 or 1 where 1 represents the concept is in ON state and 0 represents is in OFF state. The GUI contains a graph which shows the impact on various concepts based on the initial state vector taken as input.

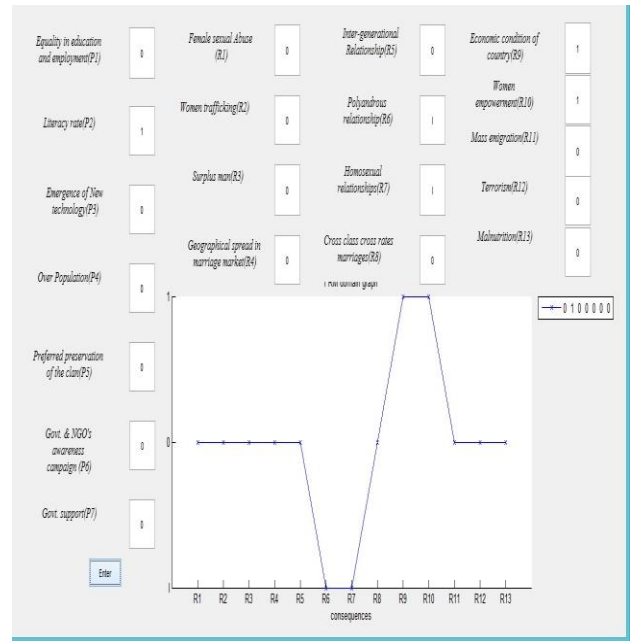

Figure. 4 Problem simulation using MATLAB for NRM when 'Literacy Rate' is ON

Resultant vector can have three outputs: '1' represents the existence of relation among the concepts ,

'0' represents that there is no causal relationship, whereas

'I' represents that there might be a causal relationship among the concepts i.e. the existence of the relationship is indeterminate.

5 Discussion of results

The development of the models to support decision making in this research is to identify and analyze the indirect relations among the factors responsible in the distorted sex ratio and poverty of India and their implications, have been proved as reliable and valid.

Values achieved in the Fig. 2 and Fig. 4 shows impacts of various causes and their consequences. FRMs and NRMs are modeled in section 3.4 and 4.4 to show how the various spaces are related.

The perceptions of the expert could not be 100% accurate. In addition, different experts may have different perceptions working with the same data, which will lead to different conclusions.

The results show that due to emergence of new technologies available in medical field like ultrasound, the factors like female abuse, crime rate, surplus men in marriage market, geographical marriage spread and women trafficking are indirectly influenced. However, the author is not in a position to surely say anything about the implications like polyandrous relationships and homosexual relationships because these depend on the mindset of the individuals. There is one positive outcome; greater acceptance towards inter-caste and inter religious marriages. Problems such as terrorism, mass emigration and malnutrition are a result of poverty pervasive in India which in turn is a result of overpopulation.

6 Conclusion

This paper discusses two major problems existing in India—namely, skewed sex ratio and poverty. The authors use the methodologies which help in decision-making when the information is incomplete and dynamic in nature. The paper highlights the various factors leading to these problems in India and show in what ways these causes relate to their positive as well as negative implications. The data concludes the explanation that due to the sources contributing in female deficit in India, there is a tremendous impact on the country's economic growth and the status of women in society. Authors also show that prevalence of the problems discussed in the paper depends heavily on the literacy rate of the population.

The model used here is NRM which has significant advantages over FRM. As discussed in the cases above, in the FRM model, the literacy rate has effect only on two factors but the NRM model along with two previous factors has drawn our attention to two other factors which may have indeterminate effect on polyandrous and homosexual relation hence depicting that increase in literacy rate may or may not lead to polyandrous or homosexual relation. The other factor discussed using both the models is the effect of sons preferred preservation of clan and its effect on other factors, here the NRM model suggests that affect on polyandrous and homosexual relations is indeterminate.

Literacy has a direct impact in the growth of a country eradicating problems like mass emigration of labor by providing employment opportunities in the country, directly or indirectly affecting poverty. Also, literacy has a direct relation with the attitude of the society towards females. There is a need for enlightened mindset towards females.

In India, different schemes encouraging the parents to have a girl child have been launched by the National and State Governments. Some of the schemes are the Ladli

Scheme in Delhi and Haryana, the Rajlakshmi Scheme in Rajasthan, Rakshak Yojna in Punjab, Bhagyalakshmi Scheme in Karnataka. As discussed by the authors, if such schemes are put in place females will no longer be considered as economic burden on their families.

References

- [1] Bao, H. (2013). A Jihad for Love, by Parvez Sharma. *Journal of homosexuality* , 60(5):796-800.
- [2] Bhalla, S. S., Kaur, R., & Agrawal, M. (2013). Son Preference, Fertility Decline and the Future of the Sex Ratio at Birth. *Fertility Decline and the Future of the Sex Ratio at Birth* .
- [3] Bhattacharya, P. C. (2013). Gender inequality and the sex ratio in three emerging economies. *Progress in Development Studies* , 13(2):117-133.
- [4] Census 2011. (n.d.). Retrieved July 20, 2014, from Government of India: censusindia.gov.in/Census_Data_2001/India_at_glance/fsex.aspx
- [5] Connell, R. W. (2014). Change among the gatekeepers: Men, masculinities, and gender equality in the global arena. *Signs* , 40(1).
- [6] Drakes, N., Perks, C., Kumar, A., Quimby, K., Clarke, C., Patel, R., et al. (2013). Prevalence and risk factors for inter-generational Sex: a cross-sectional cluster survey of Barbadian females aged 15–19. *BMC women's health* , 13(1):53.
- [7] Fitzgerald, H. E. (1995). *Children of Poverty: Research, Health, and Policy Issues*. In *Garland Reference Library of Social Science* (Vol. 968). 1000A Sherman Avenue, Hamden, CT 06514: Garland Publishing, Inc., .
- [8] Forbes, R. (2010). *The Effect of Skewed Sex Ratio On Marriage Markets in India*. Stanford university .
- [9] Gammeltoft, T. M., & Wahlberg, A. (2014). Selective Reproductive Technologies. *Annual Review of Anthropology* , 43,201-216.
- [10] Hatton, J. G. (2005). *Global Migration and the World Economy: Two Centuries of Policy and Performance* . Cambridge, Massachusetts: MIT Press.
- [11] Hudson, V. M., & Den Boer, A. (2002). A surplus of men, a deficit of peace: Security and sex ratios in Asia's largest states. *International Security* , 26(4):5-38.
- [12] Jr, P., D. L., M. H., & McKibben, S. L. (2014). Son Preference and Fertility in China, South Korea, and the United States. In *The Family and Social Change in Chinese Societies*, Springer Netherlands , 229-247.
- [13] Khan, S. U., & KHAN, S. (2014). FEMALE FOETICIDE ON RISE IN INDIA: CAUSES, EFFECTS AND THE ROLE OF MEDIA TO OVERCOME THIS PROBLEM. *International Journal of Multifaceted and Multilingual Studies* , 1(2).
- [14] Launch of Beti Bachao and Beti Padhao Campaign. (2015). Retrieved March 2, 2015, from Government of India : <http://wcd.nic.in/BBBPscheme/launch/workshop/main.htm>

- [15] Lin, M. J., Liu, J. T., & Qian, N. (2014). MORE MISSING WOMEN, FEWER DYING GIRLS: THE IMPACT OF SEX SELECTIVE ABORTION ON SEX AT BIRTH AND RELATIVE FEMALE MORTALITY IN TAIWAN. *Journal of the European Economic Association* , 12(4):899-926.
- [16] Mayer, P. (1999). India's falling sex ratios. *Population and development review* , 25(2):323-343.
- [17] Minujin, A., Delamonica, E., Davidziuk, A., & Gonzalez, E. D. (2006). The definition of child poverty: a discussion of concepts and measurements. *Environment and Urbanization* , 18(2):481-500.
- [18] Nanda, S. (2014). *Gender diversity: Crosscultural variations*. Waveland Press .
- [19] Nidadavolu, V., & Bracken, H. (2006). Abortion and sex determination: conflicting messages in information materials in a District of Rajasthan, India. *Reproductive Health Matters* , 14(27):160-171.
- [20] Piazza, J. A. (2006). Rooted in Poverty? Terrorism, Poor Economic Development, and Social Cleavages, Terrorism and political Violence. 18:159-177.
- [21] Pisani, L. F. (1956). Overpopulation and Poverty. *The Social Studies* , 47(7):247-250.
- [22] Prakash, N., & Vadlamannati, K. C. (2014). Girls for Sale? Child Sex Ratio and Girls Trafficking in India.
- [23] Rashtriya Swasthya Bima Yojana. (2008). Retrieved March 15, 2015, from Ministry of Labour and Employment, Government of India: <http://india.gov.in/spotlight/rashtriya-swasthya-bima-yojana>
- [24] Study, T. (2012). Poverty leading to malnutrition in kids. Retrieved July 15, 2015, from <http://timesofindia.indiatimes.com/india/Poverty-leading-to-malnutrition-in-kids-Study/articleshow/11456531.cms>
- [25] Stylios, C. D., Georgopoulos, V. C., Malandraki, G. A., & Chouliara, S. (2008). Fuzzy cognitive map architectures for medical decision support systems. *Applied Soft Computing* , 8(3):1243-1251.
- [26] Thobejane, T. D., & Flora, T. (2014). An Exploration of Polygamous Marriages: A Worldview. *Mediterranean Journal of Social Sciences* , 5(27),1058.
- [27] Thomas, B., & Adhikary, S. (2014). Gender Differentials in Sex ratio, Literacy rate and Work Participation rate: Trends, Issues and Concerns. *International Journal of Social and Economic Research* , 4(2):77-83.
- [28] UN Report. (2011). Retrieved July 15, 2014, from "India's poverty will fall from 51% to 22% by 2015: `UN report – Times of India": [Timesofindia.indiatimes.com](http://timesofindia.indiatimes.com)
- [29] UN Reports, 2. (2014). United Nations Development Programme, Human Development Reports. Retrieved July 15, 2014, from <http://hdr.undp.org/en/content/human-development-report-2009>
- [30] UNICEF. (2014). India, The children, Nutrition. Retrieved July 15, 2014, from http://www.unicef.org/india/children_2356.htm
- [31] Vasantha Kandasamy, W., & Smarandache, F. (2003). *Fuzzy Cognitive Maps and Neutrosophic Cognitive Maps* .
- [32] Vasantha Kandasamy, W., & Sultana, Y. (2000). *Knowledge Processing Using Fuzzy Relational Maps* , *Ultra Sci.*, 12 :242-245.
- [33] Xirogiannis, G., Glykas, M., & Staikouras, C. (2010). *Fuzzy cognitive maps in banking business process performance measurement*. Springer Berlin Heidelberg , 161-200.

Received: Jan. 10, 2016. Accepted: Mar. 20, 2016



Refined Neutrosophic Information Based on Truth, Falsity, Ignorance, Contradiction and Hesitation

Vasile Pătrașcu

Tarom Information Technology, Bucharest, Romania. E-mail: patrascu.v@gmail.com

Abstract. In this article, starting from primary representation of neutrosophic information, namely the triplet (μ, ω, ν) made up of the degree of truth μ , degree of indeterminacy ω and degree of falsity ν , we define a refined representation in a penta-valued fuzzy space, described by the index of truth t , index of falsity f , index of ignorance u , index of contradiction c and index of hesitation h . In the proposed penta-valued refined representation the indeterminacy was split into three sub-indeterminacies

such as ignorance, contradiction and hesitation. The set of the proposed five indexes represents the similarities of the neutrosophic information (μ, ω, ν) with these particular values: $T=(1,0,0)$, $F=(0,0,1)$, $U=(0,0,0)$, $C=(1,0,1)$ and $H=(0.5,1,0.5)$. This representation can be useful when the neutrosophic information is obtained from bipolar information which is defined by the degree of truth and the degree of falsity to which is added the third parameter, its cumulative degree of imprecision.

Keywords: Neutrosophic information, refined representation, hesitation, contradiction, ignorance, falsity, truth, ambiguity.

1 Introduction

The neutrosophic representation of information was proposed by Florentin Smarandache [6], [13-22] and it is a generalisation of intuitionistic fuzzy representation proposed by Krassimir Atanassov [1-4] and also for fuzzy representation proposed by Lotfi Zadeh [23]. The neutrosophic representation is described by three parameters: degree of truth μ , degree of indeterminacy ω and degree of falsity ν . In this paper we assume that the parameters $\mu, \omega, \nu \in [0,1]$.

The representation space (μ, ω, ν) is a primary space for neutrosophic information. Starting from primary space, it can be derived other more nuanced representations belonging to multi-valued fuzzy spaces where the set of parameters defines fuzzy partitions of unity. In these multi-valued fuzzy spaces, at most four parameters of representation are different from zero while all the others are zero [7], [8], [9], [10].

In the following, the paper has the structure: Section 2 presents previous works: two penta-valued representations. In the first representation, the indeterminacy was split in neutrality, ignorance and saturation while in the second the indeterminacy was split into neutrality, under-definedness and over-definedness; Section 3 presents the construction of two multi-valued representation for bipolar information.

The first is based on Belnap logical values, namely true, false, unknown and contradictory while the second is based on a new logic that was obtained by adding to the Belnap logic the fifth value: ambiguity; Section 4 presents two

variants for penta-valued representation of neutrosophic information based on truth, falsity, ignorance, contradiction and hesitation; Section 5 presents a penta-valued logic that uses the following values: true, false, unknown, contradictory and hesitant; Section 6 presents five operators for the penta-valued structures constructed in section 4. Firstly, it was defined two binary operators namely union and intersection, and secondly, three unary operators, namely complement, negation and dual. All these five operators were defined in concordance with the logic presented in the section 5; The last section outlines some conclusions.

2 Previous works

It was constructed two representations using penta-valued fuzzy spaces [7], [8], [9]. One that is based on truth, falsity, neutrality, ignorance and saturation and the other that is based on truth, falsity, neutrality, under-definedness and over-definedness.

Below is a brief overview of these variants.

2.1 Penta-valued representation of neutrosophic information based on truth, falsity, neutrality, ignorance and saturation

We can define a penta-valued partition with five indexes: index of truth, index of falsity, index of neutrality, index of ignorance and index of saturation by:

$$t = \mu - \frac{\min(\mu, \omega) + \min(\mu, \nu)}{2} \quad (2.1.1)$$

$$f = \nu - \frac{\min(\nu, \omega) + \min(\mu, \nu)}{2} \quad (2.1.2)$$

$$n = \omega - \frac{\min(\mu, \omega) + \min(\nu, \omega)}{2} \quad (2.1.3)$$

$$u = 1 - \max(\mu, \omega, \nu) \quad (2.1.4)$$

$$s = \min(\mu, \omega, \nu) \quad (2.1.5)$$

These five indexes verify the condition of partition of unity, namely:

$$t + f + n + u + s = 1 \quad (2.1.6)$$

Also, there exists the equality:

$$t \cdot f \cdot n = 0 \quad (2.1.7)$$

Having this representation, the neutrosophic information could be *true*, *false*, *neutral*, *unknown*, and *saturated*.

These five information features have the following prototypes: $T = (1,0,0)$; $F = (0,0,1)$; $N = (0,1,0)$; $S = (1,1,1)$; $U = (0,0,0)$. The geometrical representation of this construction can be seen in the figure 1.

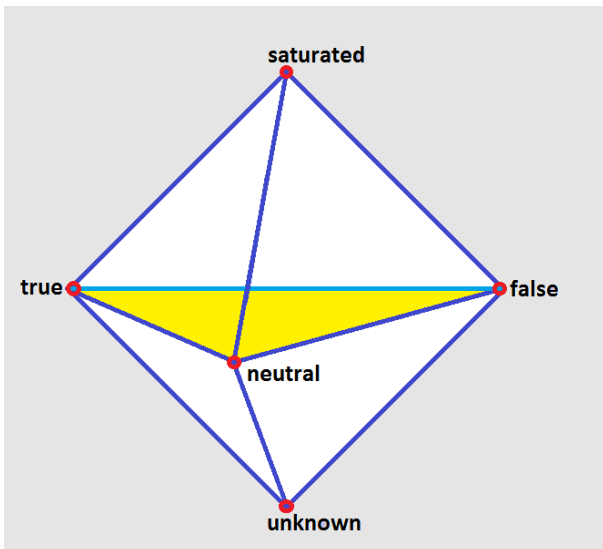

Fig.1. The geometrical representation for the penta-valued space based on true, false, neutral, unknown and saturated.

Also, we can define the inverse transform from the penta-valued space (t, f, n, u, s) to the primary three-valued space (μ, ω, ν) using the next formulae:

$$\mu = t + \min(t, f) + \min(t, n) + s$$

$$\omega = n + \min(t, n) + \min(f, n) + s$$

$$\nu = f + \min(t, f) + \min(f, n) + s$$

2.2 Penta-valued representation of neutrosophic information based on truth, falsity, neutrality, under-definedness and over-definedness

Firstly, we will define the neutrosophic definedness. Before the definedness construction, we will denote the mean of neutrosophic components:

$$\lambda = \frac{\mu + \nu + \omega}{3} \quad (2.2.1)$$

The neutrosophic definedness is described by a function: $\delta : [0,1] \rightarrow [-1,1]$ having the following properties:

- i) $\delta(0) = -1$
- ii) $\delta\left(\frac{1}{3}\right) = 0$
- iii) $\delta(1) = 1$
- iv) δ increases with its argument

Here are some examples:

$$\delta(\lambda) = \frac{3\lambda - 1}{1 + \lambda} \quad (2.2.2)$$

$$\delta(\lambda) = 2 \sin\left(\lambda \frac{\pi}{2}\right) - 1 \quad (2.2.3)$$

$$\delta(\lambda) = \frac{7\lambda - 3\lambda^2}{2} - 1 \quad (2.2.4)$$

$$\delta(\lambda) = \frac{9\lambda - 3 - |3\lambda - 1|}{4} \quad (2.2.5)$$

$$\delta(\lambda) = \frac{\sqrt{2\lambda} - \sqrt{1-\lambda}}{\sqrt{2\lambda} + \sqrt{1-\lambda}} \quad (2.2.6)$$

If the neutrosophic definedness is positive, the information is inconsistent or over-defined, if it is zero, the neutrosophic information is consistent or complete and if it

is negative, the information is incomplete or under-defined. We denote by:

$$\delta^+ = \max(\delta, 0) \tag{2.2.7}$$

$$\delta^- = \max(-\delta, 0) \tag{2.2.8}$$

Using the neutrosophic definedness we define index of *truth*, index of *falsity*, index of *neutrality*, index of *over-definedness* and index of *under-definedness* by:

$$t = \frac{1 - \delta^+}{3\lambda + \delta^-} \cdot \mu \tag{2.2.9}$$

$$n = \frac{1 - \delta^+}{3\lambda + \delta^-} \cdot \omega \tag{2.2.10}$$

$$f = \frac{1 - \delta^+}{3\lambda + \delta^-} \cdot \nu \tag{2.2.11}$$

$$o = \delta^+ \tag{2.2.12}$$

$$u = \frac{\delta^-}{3\lambda + \delta^-} \tag{2.2.13}$$

These five parameters verify the condition of fuzzy partition of unity, namely:

$$t + n + f + o + u = 1 \tag{2.2.14}$$

with $u \cdot o = 0$.

Having this representation, the neutrosophic information could be *true*, *false*, *neutral*, *over-defined* and *under-defined*.

For this penta-valued representation the *indeterminacy* has three components: *neutrality*, *over-definedness* and *under-definedness*, namely:

$$i = n + o + u \tag{2.2.15}$$

We must draw attention to the difference between *saturation* that represents the similarity to the vector (1,1,1) and the *over-definedness* that is related to the inequality $\mu + \omega + \nu > 1$. In the same time, for both parameters, the maximum is obtained for $\mu = \omega = \nu = 1$.

Also, the *ignorance* supplies a similarity to the vector (0,0,0) while the *under-definedness* represents a measure of the inequality $\mu + \omega + \nu < 1$ and the maximum is obtained for $\mu = \omega = \nu = 0$.

In figure 2 we can see the geometrical representation of this construction.

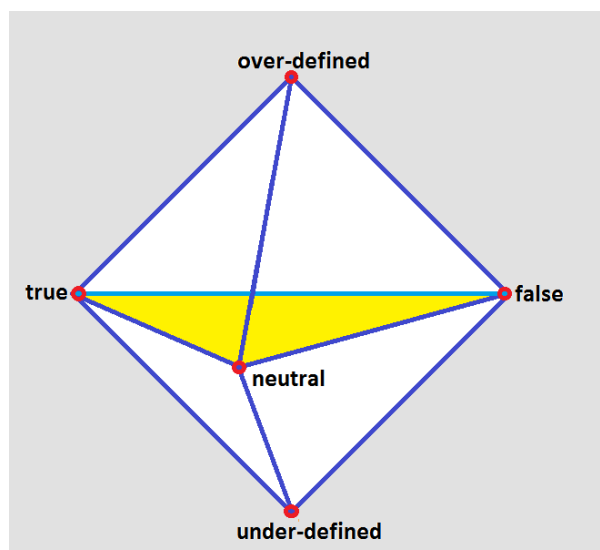

Fig.2. The geometrical representation for the penta-valued space based on true, false, neutral, under-defined and over-defined.

3 Tetra and penta-valued representation of bipolar information

The bipolar information is defined by the degree of truth μ and the degree of falsity ν . Also, it is associated with a degree of certainty and a degree of uncertainty. The bipolar uncertainty can have three features well outlined: ambiguity, ignorance and contradiction. All these three features have implicit values that can be calculated using the bipolar pair (μ, ν) .

In the same time, ambiguity, ignorance and contradiction can be considered features belonging to indeterminacy but to an implicit indeterminacy. We can compute the values of these implicit features of indeterminacy. First we calculate the index of ignorance π and index of contradiction κ :

$$\pi = 1 - \min(1, \mu + \nu) \tag{3.1}$$

$$\kappa = \max(1, \mu + \nu) - 1 \tag{3.2}$$

There is the following equality:

$$\mu + \nu + \pi - \kappa = 1 \tag{3.3}$$

which turns into the next tetra valued partition of unity:

$$(\mu - \kappa) + (\nu - \kappa) + \pi + \kappa = 1 \tag{3.4}$$

The four terms form (3.4) are related to the four logical values of Belnap logic: true, false, unknown and contradictory [5]. Further, we extract from the first two terms the bipolar ambiguity α :

$$\alpha = 2 \cdot \min(\mu - \kappa, \nu - \kappa) \tag{3.5}$$

The formula (3.5) has the following equivalent forms:

$$\alpha = 2 \min(\mu, \nu) - 2\kappa \tag{3.6}$$

$$\alpha = 1 - |\mu - \nu| - |\mu + \nu - 1| \tag{3.7}$$

$$\alpha = 1 - \max(|2\mu - 1|, |2\nu - 1|) \tag{3.8}$$

Moreover, on this way, we get the two components of bipolar certainty: index of truth τ^+ and index of falsity τ^- :

$$\tau^+ = \mu - \kappa - \frac{\alpha}{2} \tag{3.9}$$

$$\tau^- = \nu - \kappa - \frac{\alpha}{2} \tag{3.10}$$

having the following equivalent forms:

$$\tau^+ = \mu - \min(\mu, \nu) \tag{3.11}$$

$$\tau^- = \nu - \min(\mu, \nu) \tag{3.12}$$

So, we obtained a penta-valued representation of bipolar information by $(\tau^+, \tau^-, \alpha, \pi, \kappa)$. The vector components verify the partition of unity condition, namely:

$$\tau^+ + \tau^- + \alpha + \pi + \kappa = 1 \tag{3.13}$$

The bipolar entropy is achieved by adding the components of the uncertainty, namely:

$$e = \alpha + \pi + \kappa \tag{3.14}$$

Any triplet of the form (μ, ν, i) where i is a combination of the entropy components (α, π, κ) does not define a neutrosophic information, it is only a ternary description of bipolar information.

In the following sections, the two representations defined by (3.4) and (3.13) will be used to represent the neutrosophic information in two penta-valued structures.

4 Penta-valued representation of neutrosophic information based on truth, falsity, ignorance, contradiction and hesitation

In this section we present two options for this type of penta-valued representation of neutrosophic information.

4.1 Option (I)

Using the penta-valued partition (3.13), described in Section 3, first, we construct a partition with ten terms for

neutrosophic information and then a penta-valued one, thus:

$$(\tau^+ + \tau^- + \alpha + \pi + \kappa)(\omega + 1 - \omega) = 1 \tag{4.1.1}$$

By multiplying, we obtain ten terms that describe the following ten logical values: weak true, weak false, neutral, saturated, hesitant, true, false, unknown, contradictory and ambiguous.

$$t_w = \omega\tau^+$$

$$f_w = \omega\tau^-$$

$$n = \omega\pi$$

$$s = \omega\kappa$$

$$h = \omega\alpha$$

$$t = (1 - \omega)\tau^+$$

$$f = (1 - \omega)\tau^-$$

$$u = (1 - \omega)\pi$$

$$c = (1 - \omega)\kappa$$

$$a = (1 - \omega)\alpha$$

The first five terms refer to the upper square of the neutrosophic cube (fig. 3) while the next five refer to the bottom square of the neutrosophic cube (fig. 4).

We distribute equally the first four terms between the fifth and the next four and then the tenth, namely the ambiguity, equally, between true and false and we obtain:

$$t = (1 - \omega)\tau^+ + \frac{\omega\tau^+}{2} + \frac{(1 - \omega)\alpha}{2}$$

$$f = (1 - \omega)\tau^- + \frac{\omega\tau^-}{2} + \frac{(1 - \omega)\alpha}{2}$$

$$u = (1 - \omega)\pi + \frac{\omega\pi}{2}$$

$$c = (1 - \omega)\kappa + \frac{\omega\kappa}{2}$$

$$h = \omega\alpha + \frac{\omega\tau^+}{2} + \frac{\omega\tau^-}{2} + \frac{\omega\pi}{2} + \frac{\omega\kappa}{2}$$

then, we get the following equivalent form for the five final parameters:

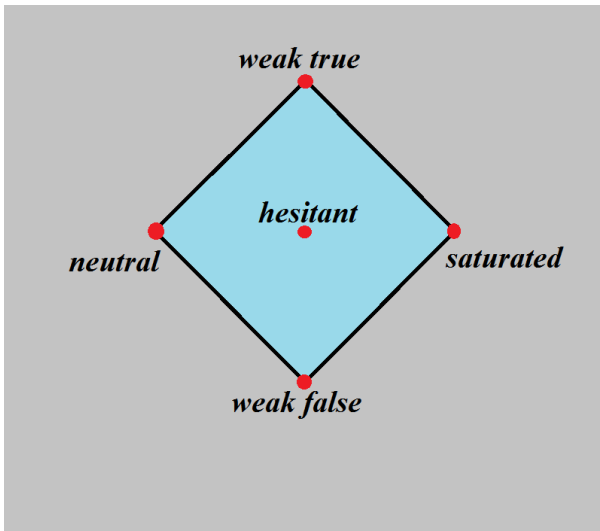

Fig. 3. The upper square of neutrosophic cube and its five logical values.

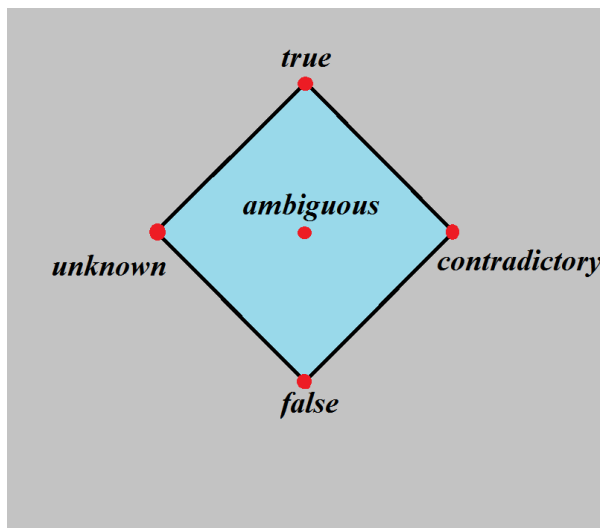

Fig. 4 The bottom square of neutrosophic cube and its five logical values.

The five parameters defined by relations (4.1.2-4.1.6) define a partition of unity:

$$t + f + h + c + u = 1 \quad (4.1.7)$$

Thus, we obtained a penta-valued representation of neutrosophic information based on logical values: true, false, unknown, contradictory and hesitant.

Since $\pi \cdot \kappa = 0$, it results that $u \cdot c = 0$ and hence the conclusion that only four of the five terms from the partition can be distinguished from zero.

Geometric representation of this construction can be seen in figures 5 and 6.

The inverse transform.

Below, we present the inverse transform calculation, namely the transition from penta-valued representation (t, f, h, c, u) to the primary representation (μ, ω, ν) .

From formulas (4.1.2) and (4.1.3), it results by subtraction:

$$t - f = \left(1 - \frac{\omega}{2}\right)(\mu - \nu) \quad (4.1.8)$$

From formulas (4.1.4) and (4.1.5), it results by subtraction:

$$c - u = \left(1 - \frac{\omega}{2}\right)(\mu + \nu - 1) \quad (4.1.9)$$

Then from (4.1.2), (4.1.3) and (3.5) it results:

$$2 \min(t, f) = (1 - \omega)\alpha \quad (4.1.10)$$

Formula (4.1.6) is equivalent to the following:

$$\frac{2h - \omega}{\omega} = \alpha \quad (4.1.11)$$

Eliminating parameter α between equations (4.1.10) and (4.1.11), we obtained the equation for determining parameter ω :

$$\omega^2 - \omega(1 + 2h + 2\min(t, f)) + 2h = 0 \quad (4.1.12)$$

Note that the second-degree polynomial:

$$p(\omega) = \omega^2 - \omega(1 + 2h + 2\min(t, f)) + 2h \quad (4.1.13)$$

has negative values for $\omega = 1$ and $\omega = 2h$, namely

$$p(1) = p(2h) = -2\min(t, f)$$

So, it has a root greater than $\max(1, 2h)$ and one less than $\min(1, 2h)$. Also, for $\omega = 0$, it has a positive value, namely $p(0) = 2h$. Therefore, the root belongs to the interval $[0, \min(1, 2h)]$ and it is defined by formula:

$$t = \left(1 - \frac{\omega}{2}\right)(\mu - \kappa) - \frac{\omega\alpha}{4} \quad (4.1.2)$$

$$f = \left(1 - \frac{\omega}{2}\right)(\nu - \kappa) - \frac{\omega\alpha}{4} \quad (4.1.3)$$

$$u = \left(1 - \frac{\omega}{2}\right)\pi \quad (4.1.4)$$

$$c = \left(1 - \frac{\omega}{2}\right)\kappa \quad (4.1.5)$$

$$h = \frac{(1 + \alpha)\omega}{2} \quad (4.1.6)$$

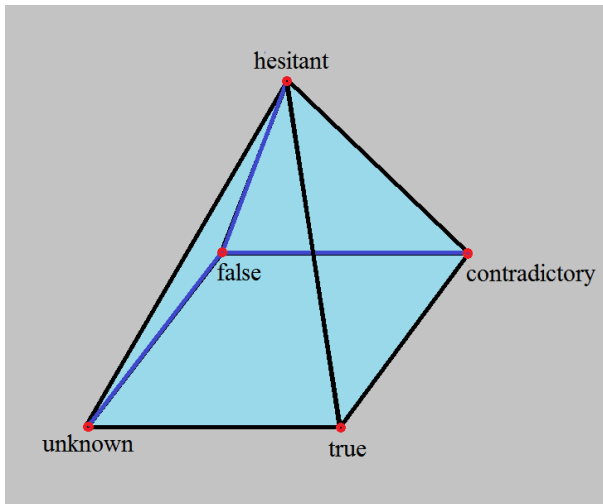

Fig. 5. The geometrical representation of the penta-valued space, based on true, false, unknown, contradictory and hesitant.

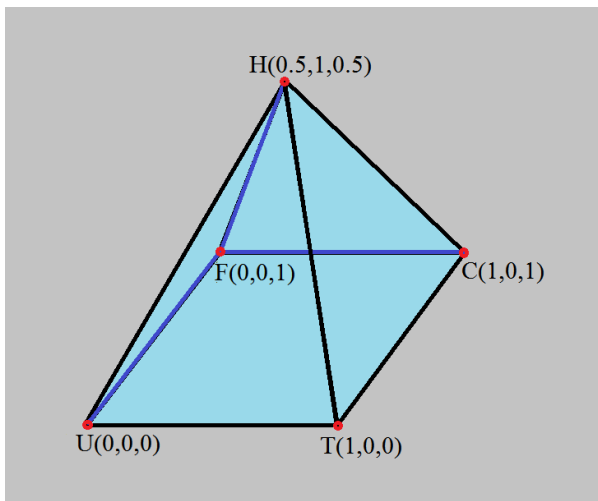

Fig. 6. Geometric representation of prototypes for features: truth, falsity, ignorance, contradiction and hesitation.

$$\omega = \beta - \sqrt{\beta^2 - 2h} \tag{4.1.14}$$

where:

$$\beta = \frac{1}{2} + h + \min(t, f) \tag{4.1.15}$$

We must observe that

$$\beta^2 - 2h \geq \left(\frac{1}{2} + h\right)^2 - 2h = \left(\frac{1}{2} - h\right)^2 \geq 0$$

and hence formula (4.1.14) provides a real value for ω .

Then, from (4.1.8) and (4.1.9), it results the system:

$$\mu - \nu = \frac{t - f}{1 - \frac{\omega}{2}}$$

$$\mu + \nu - 1 = \frac{c - u}{1 - \frac{\omega}{2}}$$

Finally, we obtain formulas for μ and ν .

$$\mu = \frac{1}{2} + \frac{t - f + c - u}{2 - \beta + \sqrt{\beta^2 - 2h}} \tag{4.1.16}$$

$$\nu = \frac{1}{2} + \frac{f - t + c - u}{2 - \beta + \sqrt{\beta^2 - 2h}} \tag{4.1.17}$$

Formulas (4.1.14), (4.1.16) and (4.1.17) represent the recalculating formulas for the primary space components (μ, ω, ν) namely inverse transformation formulas.

4.2 Option (II)

Using the tetra-valued partition defined by formula (3.4) we obtain:

$$\mu - \kappa - \frac{\alpha\omega}{2} + \nu - \kappa - \frac{\alpha\omega}{2} + \pi + \kappa + \omega = 1 + \omega - \alpha\omega$$

$$\frac{(\mu - \kappa - \frac{\alpha\omega}{2}) + (\nu - \kappa - \frac{\alpha\omega}{2}) + \pi + \kappa + \omega}{1 + \omega - \alpha\omega} = 1 \tag{4.2.1}$$

We obtained a penta-valued partition of unity for neutrosophic information. These five terms are related to the following logical values: true, false, unknown, contradictory, hesitation:

$$t = \frac{\mu - \kappa - \frac{\alpha\omega}{2}}{1 + (1 - \alpha)\omega} \tag{4.2.2}$$

$$f = \frac{\nu - \kappa - \frac{\alpha\omega}{2}}{1 + (1 - \alpha)\omega} \tag{4.2.3}$$

$$u = \frac{\pi}{1 + (1 - \alpha)\omega} \tag{4.2.4}$$

$$c = \frac{\kappa}{1 + (1 - \alpha)\omega} \tag{4.2.5}$$

$$h = \frac{\omega}{1 + (1 - \alpha)\omega} \tag{4.2.6}$$

Formula (4.2.1) becomes:

$$t + f + h + c + u = 1 \tag{4.2.7}$$

The inverse transform

From (4.2.2) and (4.2.3) it results:

$$t - f = \frac{\mu - \nu}{1 + (1 - \alpha)\omega} \tag{4.2.8}$$

From (4.2.4) and (4.2.5) it results:

$$c - u = \frac{\mu + \nu - 1}{1 + (1 - \alpha)\omega} \tag{4.2.9}$$

From (4.2.8) and (4.2.9) it results:

$$\alpha = 1 - \frac{(|t - f| + |c - u|)}{1 - \omega(|t - f| + |c - u|)} \tag{4.2.10}$$

from (4.2.6) it results:

$$\frac{1}{\omega} + 1 - \frac{1}{h} = \alpha \tag{4.2.11}$$

Finally, from (4.2.10) and (4.2.11) it results the following equation:

$$(|t - f| + |c - u|)\omega^2 - \omega + h = 0 \tag{4.2.12}$$

Note that the second-degree polynomial defined by:

$$p(\omega) = (|t - f| + |c - u|)\omega^2 - \omega + h$$

has a negative value for $\omega = 1$, namely:

$$p(1) = -2\min(t, f)$$

Hence, it has a root greater than 1 and another smaller than 1. Also for $\omega = h$ it has a positive value, namely:

$$p(h) = (|t - f| + |c - u|)h^2$$

So the solution belongs to the interval : $[h, 1]$

The value of the parameter ω is given by:

$$\omega = \frac{2h}{1 + \sqrt{1 - 4h(|t - f| + |c - u|)}} \tag{4.2.13}$$

From (4.2.11) it results:

$$\alpha = 1 - \frac{2(|t - f| + |c - u|)}{1 + \sqrt{1 - 4h(|t - f| + |c - u|)}} \tag{4.2.14}$$

from (4.2.13) and (4.2.14) it results:

$$1 + (1 - \alpha)\omega = \frac{2}{1 + \sqrt{1 - 4h(|t - f| + |c - u|)}}$$

Then, from (4.2.8) and (4.2.9) it results:

$$\mu - \nu = \frac{2(t - f)}{1 + \sqrt{1 - 4h(|t - f| + |c - u|)}}$$

$$\mu + \nu - 1 = \frac{2(c - u)}{1 + \sqrt{1 - 4h(|t - f| + |c - u|)}}$$

Finally, it results for the degree of truth and degree of falsity, the following formulas:

$$\mu = \frac{1}{2} + \frac{t - f + c - u}{1 + \sqrt{1 - 4h(|t - f| + |c - u|)}} \tag{4.2.15}$$

$$\nu = \frac{1}{2} + \frac{f - t + c - u}{1 + \sqrt{1 - 4h(|t - f| + |c - u|)}} \tag{4.2.16}$$

The formulae (4.2.15), (4.2.16) and (4.2.13) represent the formulae for recalculating of the primary space components (μ, ω, ν) , namely the inverse transformation formulas.

5 Penta-valued logic based on truth, falsity, ignorance, contradiction and hesitation

This five-valued logic is a new one, but is related to our previous works presented in [11], [12].

In the framework of this logic we will consider the following five logical values: *true t*, *false f*, *unknown u*, *contradictory c*, and *hesitant h*. We have obtained these five logical values, adding to the four Belnap logical values the fifth: *hesitant*.

Tables 1, 2, 3, 4, 5, 6 and 7 show the basic operators in this logic.

Table 1. The Union

∪	t	c	h	u	f
t	t	t	t	t	t
c	t	c	h	h	c
h	t	h	h	h	h
u	t	h	h	u	u
f	t	c	h	u	f

Table 2. The intersection.

∩	t	c	h	u	f
t	t	c	h	u	f
c	c	c	h	h	f
h	h	h	h	h	f
u	u	h	h	u	f
f	f	f	f	f	f

The main differences between the proposed logic and the Belnap logic are related to the logical values u and c . We have defined $c \cap u = h$ and $c \cup u = h$ while in the Belnap logic there were defined $c \cap u = f$ and $c \cup u = t$.

Table 3. The complement.

	\neg
t	f
c	c
h	h
u	u
f	t

Table 4. The negation.

	$-$
t	f
c	u
h	h
u	c
f	t

Table 5. The dual.

	\approx
t	t
c	u
h	h
u	c
f	f

The complement, the negation and the dual are interrelated and there exists the following equalities:

$$\approx x = \neg\neg x \tag{5.1}$$

$$\neg x = -\approx x \tag{5.2}$$

$$\neg x = \neg \approx x \tag{5.3}$$

Table 6. The equivalence

\leftrightarrow	t	c	h	u	f
t	t	c	h	u	f
c	c	c	h	h	c
h	h	h	h	h	h
u	u	h	h	u	u
f	f	c	h	u	t

The *equivalence* is calculated by:

$$x \leftrightarrow y = (\neg x \cup y) \cap (x \cup \neg y) \tag{5.4}$$

Table 7. The S-implication

\rightarrow	t	c	h	u	f
t	t	c	h	u	f
c	t	c	h	h	c
h	t	h	h	h	h
u	t	h	h	u	u
f	t	t	t	t	t

The *S-implication* is calculated by:

$$x \rightarrow y = \neg x \cup y \tag{5.5}$$

6 New operators defined on the penta-valued structure

There be $x = (t, c, h, u, f) \in [0,1]^5$. For this kind of vectors, one defines the union, the intersection, the complement, the negation and the dual operators. The operators are related to those define in [12].

The Union: For two vectors $a, b \in [0,1]^5$, where $a = (t_a, c_a, h_a, u_a, f_a)$, $b = (t_b, c_b, h_b, u_b, f_b)$, one defines the union (disjunction) $d = a \cup b$ by the formula:

$$\begin{aligned} t_d &= t_a \vee t_b \\ c_d &= (c_a + f_a) \wedge (c_b + f_b) - f_a \wedge f_b \\ u_d &= (u_a + f_a) \wedge (u_b + f_b) - f_a \wedge f_b \\ f_d &= f_a \wedge f_b \end{aligned} \tag{6.1}$$

with $h_d = 1 - (t_d + c_d + u_d + f_d)$

The Intersection: For two vectors $a, b \in [0,1]^5$ one defines the intersection (conjunction) $c = a \cap b$ by the formula:

$$\begin{aligned} t_c &= t_a \wedge t_b \\ c_c &= (c_a + t_a) \wedge (c_b + t_b) - t_a \wedge t_b \\ u_c &= (u_a + t_a) \wedge (u_b + t_b) - t_a \wedge t_b \\ f_c &= f_a \vee f_b \end{aligned} \tag{6.2}$$

with $h_c = 1 - (t_c + c_c + u_c + f_c)$

In formulae (6.1) and (6.2), the symbols “ \vee ” and “ \wedge ” represent the maximum and the minimum operators, namely:

$$\forall x, y \in [0,1],$$

$$x \vee y = \max(x, y)$$

$$x \wedge y = \min(x, y)$$

The union “ \cup ” and intersection “ \cap ” operators preserve de properties $t + c + u + f \leq 1$ and $u \cdot c = 0$, namely:

$$t_{a \cup b} + c_{a \cup b} + u_{a \cup b} + f_{a \cup b} \leq 1$$

$$c_{a \cup b} \cdot u_{a \cup b} = 0$$

$$t_{a \cap b} + c_{a \cap b} + u_{a \cap b} + f_{a \cap b} \leq 1$$

$$c_{a \cap b} \cdot u_{a \cap b} = 0$$

The Complement: For $x = (t, c, h, u, f) \in [0,1]^5$ one defines the complement x^c by formula:

$$x^c = (f, c, h, u, t) \tag{6.3}$$

The Negation: For $x = (t, c, h, u, f) \in [0,1]^5$ one defines the negation x^n by formula:

$$x^n = (f, u, h, c, t) \tag{6.4}$$

The Dual: For $x = (t, c, h, u, f) \in [0,1]^5$ one defines the dual x^d by formula:

$$x^d = (t, u, h, c, f) \tag{6.5}$$

In the set $\{0,1\}^5$ there are five vectors having the form $x = (t, c, h, u, f)$, which verify the condition $t + f + c + h + u = 1$:

$T = (1,0,0,0,0)$ (*True*), $F = (0,0,0,0,1)$ (*False*),
 $C = (0,1,0,0,0)$ (*Contradictory*), $U = (0,0,0,1,0)$ (*Unknown*)
 and $H = (0,0,1,0,0)$ (*Hesitant*).

Using the operators defined by (6.1), (6.2), (6.3), (6.4) and (6.5), the same truth table results as seen in Tables 1, 2, 3, 4, 5, 6 and 7.

Using the complement, the negation and the dual operators defined in the penta-valued space and returning in the primary three-valued space, we find the following equivalent unary operators:

$$(\mu, \omega, \nu)^c = (\nu, \omega, \mu) \tag{6.6}$$

$$(\mu, \omega, \nu)^n = (1 - \mu, \omega, 1 - \nu) \tag{6.7}$$

$$(\mu, \omega, \nu)^d = (1 - \nu, \omega, 1 - \mu) \tag{6.8}$$

Conclusion

In this paper it was presented two new penta-valued structures for neutrosophic information. These structures are based on Belnap logical values, namely true, false, unknown, contradictory plus a fifth, hesitant.

It defines the direct conversion from ternary space to the penta-valued one and also the inverse transform from penta-valued space to the primary one.

There were defined the logical operators for the penta-valued structures: union, intersection, complement, dual and negation.

References

- [1] K. T. Atanassov. Intuitionistic Fuzzy Sets, Springer-Verlag, Heidelberg, 1999.
- [2] K. T. Atanassov. Intuitionistic fuzzy sets, VII ITKR's Session, Sofia, June 1983.
- [3] K. T. Atanassov. Intuitionistic fuzzy sets, Fuzzy sets and Systems Vol. 20, 1986, No. 1, p. 87-96.
- [4] K. T. Atanassov. Remarks on the intuitionistic fuzzy sets - III, Fuzzy sets and Systems Vol. 75, 1995, No. 3, p. 401-402.
- [5] N. Belnap. A Useful Four-valued Logic, Modern Uses of Multiple-valued Logics (D. Reidel, Ed), Dordrecht - Boston pp. 8-37, 1977.
- [6] G. Albeanu. Neutrosophic Computational Models – (I), Annals of Spiru Haret University, Mathematics - Informatics Series, Vol IX /, Issue 2, p. 13-22, 2013.
- [7] V. Patrascu. Neutrosophic information in the framework of multivalued representation, The 21th Conference on Applied and Industrial Mathematics, CAIM 2013, Bucharest, Romania, September 19-22, 2013.
- [8] V. Patrascu. Multi-valued representation of Neutrosophic Information, Proceedings of the 14th International Conference on Information Processing and Management of Uncertainty in Knowledge-Based Systems (IPMU'14), Montpellier, France, Volume Part I, CCIS 442, Springer International Publishing Switzerland, 2014, p. 304-316.
- [9] V. Patrascu. Multi-Valued Fuzzy Spaces for Color Representation, Proceedings of the 14th International Conference on Information Processing and Management of Uncertainty in Knowledge-Based Systems (IPMU'14), Montpellier, France, Volume Part II, CCIS 443, Springer International Publishing Switzerland, 2014, p. 174-183.
- [10] V. Patrascu. Neutrosophic Entropy and its Five Components, Neutrosophic Sets and Systems, Vol. 7, p. 40-46, 2015.
- [11] V. Patrascu. A New Penta-valued Logic Based Knowledge Representation, Proc. of the 12th Inter. Conf. on Information Processing and Management of Uncertainty in Knowledge-Based Systems (IPMU'08), pp. 17-22, Malaga, Spain, 2008.
- [12] V. Patrascu. Bi-fuzziness, Incompleteness, Inconsistency, Truth and Falsity Based on Saturation and Ignorance Functions. A New Approach of Penta-Valued Knowledge Repre-

- sentation, The 23rd Midwest Artificial Intelligence and Cognitive Science Conference MAICS 2012, pp. 112-118 Cincinnati, OH, USA, 21-22 April, 2012.
- [13] U. Riviuccio. Neutrosophic Logics: Prospects and Problems, University of Genoa, Italy, 2007.
- [14] F. Smarandache. A Unifying Field in Logics: Neutrosophic Logic. Neutrosophy, Neutrosophic Set, Probability, and Statistics, "American Research Press", Rehoboth, 1999.
- [15] F. Smarandache. A Unifying Field in Logics: Neutrosophic Logic, "Multiple-valued logic, An international journal" 8, no. 3, p. 385-438, 2002.
- [16] F. Smarandache. Neutrosophic Set - A Generalization of the Intuitionistic Fuzzy Set, "International Journal of Pure and Applied Mathematics", 24, no. 3, p. 287-297, 2005.
- [17] F. Smarandache, S. Osman. Neutrosophy in Arabic Philosophy, Renaissance High Press, 2007.
- [18] F. Smarandache, V. Christianto. n-ary Fuzzy Logic and Neutrosophic Logic Operators, "Studies in Logic, Grammar and Rethoric", 17, no. 30, p. 127-143, 2009.
- [19] F. Smarandache. N-Norm and N-Conorm in Neutrosophic Logic and Set, and the Neutrosophic Topologies, "Technical Sciences and Applied Mathematics", AFA journal, p. 5-11, 2009.
- [20] F. Smarandache. Neutrosophic Set - A Generalization of the Intuitionistic Fuzzy Set, "Journal of Defence Resources Management", 1, no. 1, p. 107-116, 2010.
- [21] F. Smarandache. n-Valued Refined Neutrosophic Logic and Its Applications to Physics, "Progress in Physics", 4, p. 143-146, 2013.
- [22] F. Smarandache. Neutrosophic Measure and Neutrosophic Integral, Neutrosophic Sets and Systems, Vol 1, p.3-7, 2013.
- [23] L. Zadeh. Fuzzy sets, "Inform. and Control", 8, p. 338-353, 1965.

Received: January 27, 2016. Accepted: February 15, 2016



Point Equation, Line Equation, Plane Equation etc and Point Solution, Line Solution, Plane Solution etc —Expanding Concepts of Equation and Solution with Neutrosophy and Quad-stage Method

Fu Yuhua

CNOOC Research Institute, China. E-mail: fuyh1945@sina.com

Abstract. The concepts of equations and solutions are constantly developed and expanded. With Neutrosophy and Quad-stage method, this paper attempts to expand the concepts of equations and solutions in the way of referring to the concepts of domain of function, the geometry elements included in domain of function, and the like; and discusses point equation, line equation, plane equation, solid equation, sub-domain equation, whole-domain equation, and the like; as well as point solution, line solu-

tion, plane solution, solid solution, sub-domain solution, whole-domain solution, and the like. Where: the point solutions may be the solutions of point equation, line equation, plane equation, and the like; similarly, the line solutions may be the solutions of point equation, line equation, plane equation, and the like; and so on. This paper focuses on discussing the single point method to determine "point solution".

Keywords: Neutrosophy, Quad-stage, point equation, line equation, plane equation, point solution, line solution, plane solution, single point method

1 Introduction

As well-known, equations are equalities that contain unknown.

Also, the concepts of equations and solutions are constantly developed and expanded. From the historical perspective, these developments and expansions are mainly processed for the complexity of variables, functional relationships, operation methods, and the like. For example, from elementary mathematical equations develop and expand into secondary mathematical equations, and advanced mathematical equations. Again, from algebra equations develop and expand into geometry equations, trigonometric equations, differential equations, integral equations, and the like.

With Neutrosophy and Quad-stage method, this paper considers another thought, and attempts to expand the concepts of equations and solutions in the way of referring to the concepts of domain of function, the geometry elements included in domain of function, and the like; and discusses point equation, line equation, plane equation, solid equation, sub-domain equation, whole-domain equation, and the like; as well as point solution, line solution, plane solu-

tion, solid solution, sub-domain solution, whole-domain solution, and the like. Where: the point solutions may be the solutions of point equation, line equation, plane equation, and the like; similarly, the line solutions may be the solutions of point equation, line equation, plane equation, and the like; and so on.

2 Basic Contents of Neutrosophy

Neutrosophy is proposed by Prof. Florentin Smarandache in 1995.

Neutrosophy is a new branch of philosophy that studies the origin, nature, and scope of neutralities, as well as their interactions with different ideational spectra.

This theory considers every notion or idea $\langle A \rangle$ together with its opposite or negation $\langle \text{Anti-}A \rangle$ and the spectrum of "neutralities" $\langle \text{Neut-}A \rangle$ (i.e. notions or ideas located between the two extremes, supporting neither $\langle A \rangle$ nor $\langle \text{Anti-}A \rangle$). The $\langle \text{Neut-}A \rangle$ and $\langle \text{Anti-}A \rangle$ ideas together are referred to as $\langle \text{Non-}A \rangle$.

Neutrosophy is the base of neutrosophic logic, neutrosophic set, neutrosophic probability and statistics used in engineering applications (especially for software and in-

formation fusion), medicine, military, cybernetics, and physics.

Neutrosophic Logic is a general framework for unification of many existing logics, such as fuzzy logic (especially intuitionistic fuzzy logic), paraconsistent logic, intuitionistic logic, etc. The main idea of NL is to characterize each logical statement in a 3D Neutrosophic Space, where each dimension of the space represents respectively the truth (T), the falsehood (F), and the indeterminacy (I) of the statement under consideration, where T, I, F are standard or non-standard real subsets of $] -0, 1+[$ without necessarily connection between them.

More information about Neutrosophy can be found in references [1, 2].

3 Basic Contents of Quad-stage

The first kind of "four stages" is presented in reference [3], and is named as "Quad-stage". It is the expansion of Hegel's triad-stage (triad thesis, antithesis, synthesis of development). The four stages are "general theses", "general antitheses", "the most important and the most complicated universal relations", and "general syntheses". They can be stated as follows.

The first stage, for the beginning of development (thesis), the thesis should be widely, deeply, carefully and repeatedly contacted, explored, analyzed, perfected and so on; this is the stage of general theses. It should be noted that, here the thesis will be evolved into two or three, even more theses step by step. In addition, if in other stage we find that the first stage's work is not yet completed, then we may come back to do some additional work for the first stage.

The second stage, for the appearance of opposite (antithesis), the antithesis should be also widely, deeply, carefully and repeatedly contacted, explored, analyzed, perfected and so on; this is the stage of general antitheses. It should be also noted that, here the antithesis will be evolved into two or three, even more antitheses step by step.

The third stage is the one that the most important and the most complicated universal relations, namely the seed-time inherited from the past and carried on for the future. Its purpose is to establish the universal relations in the widest scope. This widest scope contains all the regions related and non-related to the "general theses", "general antitheses", and the like. This stage's foundational works are to contact, grasp, discover, dig, and even create the opportunities, pieces of information, and so on as many as possible. The degree of the universal relations may be different, theoretically its upper limit is to connect all the existences, pieces of information and so on related to matters, spirits and so on in the universe; for the cases such as to create science fiction, even may connect all the existences, pieces of information and so on in the virtual world. Obviously,

this stage provides all possibilities to fully use the complete achievements of nature and society, as well as all the humanity's wisdoms in the past, present and future. Therefore this stage is shortened as "universal relations" (for other stages, the universal relations are also existed, but their importance and complexity cannot be compared with the ones in this stage).

The fourth stage, to carry on the unification and synthesis regarding various opposites and the suitable pieces of information, factors, and so on; and reach one or more results which are the best or agreed with some conditions; this is the stage of "general syntheses". The results of this stage are called "synthesized second generation theses", all or partial of them may become the beginning of the next quad-stage.

4 Expanding concepts of equations and solutions with Neutrosophy and Quad-stage method

For realizing the innovations in the areas such as science and technology, literature and art, and the like, it is a very useful tool to combine neutrosophy with quad-stage method. For example, in reference [4], expanding Newton mechanics with neutrosophy and quad-stage method, and establishing New Newton Mechanics taking law of conservation of energy as unique source law; in reference [5], negating four color theorem with neutrosophy and quad-stage method, and "the two color theorem" and "the five color theorem" are derived to replace "the four color theorem"; in reference [6], expanding Hegelian triad thesis, antithesis, synthesis with Neutrosophy and Quad-stage Method; in reference [7], interpreting and expanding Laozi's governing a large country is like cooking a small fish with Neutrosophy and Quad-stage Method; in reference [8], interpreting and expanding the meaning of "Yi" with Neutrosophy and Quad-stage Method; and in reference [9], creating generalized and hybrid set and library with Neutrosophy and Quad-stage Method.

Now we briefly describe the general application of neutrosophy to quad-stage method.

In quad-stage method, "general theses" may be considered as the notion or idea $\langle A \rangle$; "general antitheses" may be considered as the notion or idea $\langle \text{Anti-A} \rangle$; "the most important and the most complicated universal relations" may be considered as the notion or idea $\langle \text{Neut-A} \rangle$; and "general syntheses" are the final results.

The different kinds of results in the above mentioned four stages can also be classified and induced with the viewpoints of neutrosophy. Thus, the theory and achievement of neutrosophy can be applied as many as possible, and the method of quad-stage will be more effective.

The process of expanding concepts of equations and solutions can be divided into four stages.

The first stage (stage of "general theses"), for the beginning of development, the thesis (namely "traditional concepts of equations and solutions") should be widely, deeply, carefully and repeatedly contacted, explored, analyzed, perfected and so on.

The concepts of equations and solutions have been continuously developed and expanded. From the historical perspective, in this process of development and expansion, for equations, the linear equation, dual linear equation, quadratic equation, multiple equation, geometry equation, trigonometric equation, ordinary differential equation, partial differential equation, integral equation, and the like are appeared step by step; for solutions, the approximate solution, accurate solution, analytical solution, numerical solution, and the like are also appeared step by step. Obviously, these developments and expansions are mainly processed for the complexity of variables, functional relationships, operation methods, and the like.

In the second stage (the stage of "general antitheses"), the opposites (antitheses) should be discussed carefully. Obviously, there are more than one opposites (antitheses) here.

For example, according to the viewpoint of Neutrosophy, if "traditional concepts of equations and solutions" are considered as the concept <A>, the opposite <Anti-A> may be: "non-traditional concepts of equations and solutions"; while the neutral (middle state) fields <Neut-A> including: "undetermined concepts of equations and solutions" (neither "traditional concepts of equations and solutions", nor "non-traditional concepts of equations and solutions"; or, sometimes they are "traditional concepts of equations and solutions", and sometimes they are "non-traditional concepts of equations and solutions"; and the like).

In the third stage, considering the most important and the most complicated universal relations to link with "concepts of equations and solutions". The purpose of this provision stage is to establish the universal relations in the widest scope.

Here, differ with traditional thought, we consider a new thought, and attempt to expand the concepts of equations and solutions in the way of referring to the concepts of domain of function, the geometry elements included in domain of function, and the like.

Obviously, considering other thought, different result may be reached; but this situation will not be discussed in this paper.

In the fourth stage, we will carry on the unification and synthesis regarding various opposites and the suitable pieces of information, factors, and the like that are related to the concepts of equations and solutions; and reach one or more results for expanding the concepts of equations and solutions, which are the best or agreed with some conditions.

It should be noted that, in this stage, various methods can also be applied. Here, we will seek the results according to Neutrosophy and Quad-stage method.

Firstly, analyzing the concept of "domain of function". According to the viewpoint of Neutrosophy, the two extreme elements of "domain of function" are "point domain" and "whole-domain", and in the middle there are: "line domain", "plane domain", "solid domain", "sub-domain", and the like; therefore, we can discuss the concepts of point equation, line equation, plane equation, solid equation, sub-domain equation, whole-domain equation, and the like; as well as the concepts of point solution, line solution, plane solution, solid solution, sub-domain solution, whole-domain solution, and the like.

4.1 Point equation and point solution, line equation and line solution, and the like

We already know that, "point equation" is the one suitable for a certain solitary point only. For example, when considering the gravity between the Sun (coordinates: 0,0,0) and a planet located at a certain solitary point (coordinates: x_0, y_0, z_0), then according to the law of gravity, the following "point equation" can be reached.

$$F = -\frac{GM_{\text{sun}}m}{x_0^2 + y_0^2 + z_0^2} \quad (1)$$

where, M_{sun} is the mass of the Sun; the unknown in the equation is the mass of the planet only.

When considering the gravity between the Sun and a planet located at its elliptical orbit, substituting the polar equation of the ellipse into the law of gravity, then the following "line equation" can be reached, and it is suitable for the entire elliptical orbit.

$$F = -\frac{GM_{\text{sun}}m(1+e\cos\varphi)^2}{a^2(1-e^2)^2} \quad (2)$$

When considering the gravity between the Sun and a planet located at the inner surface of the sphere ($r = r_0$), substituting $r = r_0$ into the law of gravity, then the following "plane (inner surface) equation" can be reached, and it is suitable for the entire inner surface of the sphere.

$$F = -\frac{GM_{\text{sun}}m}{r_0^2} \quad (3)$$

When considering the gravity between the Sun and a point located in a hollow ball ($r_1 \leq r \leq r_2$), substituting $r_1 \leq r \leq r_2$ into the law of gravity, then the following "solid equation" can be reached, and it is suitable for the entire hollow ball.

$$F = -\frac{GM_{\text{sun}}m}{r^2}, \quad r_1 \leq r \leq r_2 \quad (4)$$

When considering the gravity between the Sun and a point located in the sub-domain ($x \geq x_0$), substituting $x \geq x_0$ into the law of gravity, then the following "sub-domain equation" can be reached, and it is suitable for the entire sub-domain.

$$F = -\frac{GM_{\text{sun}}m}{x^2 + y^2 + z^2}, \quad x \geq x_0 \quad (5)$$

When considering the gravity between any two objects, according to the law of gravity, the following "whole-domain equation" can be reached, it is suitable for the entire three-dimensional space, and the two objects may not include the Sun.

$$F = -\frac{GMm}{x^2 + y^2 + z^2} \quad (6)$$

Accordingly, when considering the gravity between the Sun (coordinates: 0,0,0) and a planet located at a certain solitary point (coordinates: x_0, y_0, z_0), and if the mass of the planet is given (equals to m_0), then according to the law of gravity, the following "point solution" can be reached.

$$F = -\frac{GM_{\text{sun}}m_0}{x_0^2 + y_0^2 + z_0^2} \quad (7)$$

where, M_{sun} is the mass of the Sun; m_0 is the mass of the planet.

When considering the gravity between the Sun and a planet located at its elliptical orbit, substituting the polar equation of the ellipse into the law of gravity, if the planet's parameters are given (equal to e_0 and a_0), and the mass of the planet is also given (equals to m_0), then the following "line solution" can be reached, and it is suitable for the entire elliptical orbit.

$$F = -\frac{GM_{\text{sun}}m_0(1 + e_0 \cos \varphi)^2}{a_0^2(1 - e_0^2)^2} \quad (8)$$

When considering the gravity between the Sun and a planet located at the inner surface of the sphere ($r = r_0$), substituting $r = r_0$ into the law of gravity, and if the mass of the planet is given (equals to m_0), then the following "plane (inner surface) solution" can be reached, and it is suitable for the entire inner surface of the sphere.

$$F = -\frac{GM_{\text{sun}}m_0}{r_0^2} \quad (9)$$

When considering the gravity between the Sun and a point located in a hollow ball ($r_1 \leq r \leq r_2$), substituting

$r_1 \leq r \leq r_2$ into the law of gravity, and if the mass of the point is given (equals to m_0), then the following "solid solution" can be reached, and it is suitable for the entire hollow ball.

$$F = -\frac{GM_{\text{sun}}m_0}{r^2}, \quad r_1 \leq r \leq r_2 \quad (10)$$

When considering the gravity between the Sun and a point located in the sub-domain ($x \geq x_0$), substituting $x \geq x_0$ into the law of gravity, and if the mass of the point is given (equals to m_0), then the following "sub-domain solution" can be reached, and it is suitable for the entire sub-domain.

$$F = -\frac{GM_{\text{sun}}m_0}{x^2 + y^2 + z^2}, \quad x \geq x_0 \quad (11)$$

When considering the gravity between any two objects, if both the masses of the two objects are given (equal to M_0 and m_0), then according to the law of gravity, the following "whole-domain solution" can be reached, it is suitable for the entire three-dimensional space, and the two objects may not include the Sun.

$$F = -\frac{GM_0m_0}{x^2 + y^2 + z^2} \quad (12)$$

4.2 Determining point solution with single point method

In the existing methods for solving ordinary differential equations, there are already the examples for seeking the solution (point solution) suitable for one solitary point.

For example, consider the following differential equation

$$y' = y, \quad y(0) = 1 \quad (13)$$

It gives

$$y'(0) = y''(0) = y'''(0) = y^{(n)}(0) = 1$$

According to the power series formula for $x = x_0$

$$y = y(x_0) + y'(x_0)x/1! + y''(x_0)x^2/2! + \dots$$

It gives the "point solution" for $x_0 = 0$ as follows

$$y = 1 + x/1! + x^2/2! + \dots$$

However, this "point solution" is applicable to the "whole-domain", while in this paper we will consider the "point solution" suitable for one solitary point only.

For example, the single point method can be used to find the “point solution” of hydraulic problem that is suitable for one solitary point only. This kind of “point solution” is finding independently, namely the effect of other points may not be considered. As finding “point solution” for a certain point, the point collocation method should be used; that means that the “point solution” will satisfy the boundary condition on some selected boundary points; and on this certain point satisfy the hydraulic equation and the derived equations that are formed by running the derivative operations to the hydraulic equation. Finally all the undetermined constants for the “point solution” will be determined by solving the equations that are formed by above mentioned point collocation method.

In reference [10], the single point method was used to determine the “point solution” on a certain solitary point for the problem of potential flow around a cylinder between two parallel plates.

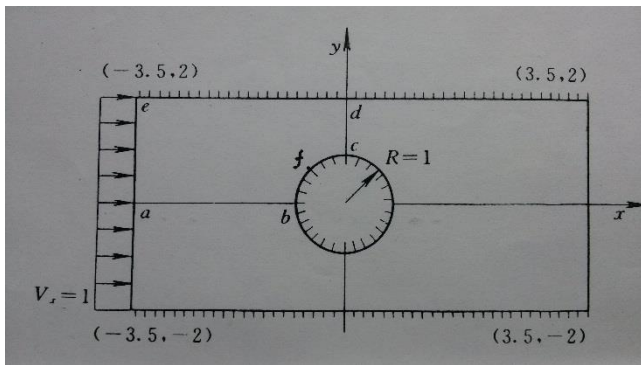

Fig. 1. Potential flow around a cylinder between two parallel plates

As shown in Figure 1, due to symmetry, one-fourth flow field in the second quadrant can be considered only.

The differential equation is as follows

$$F = \partial^2 \varphi / \partial x^2 + \partial^2 \varphi / \partial y^2 = 0 \quad (14)$$

On boundary *ab*

$$\varphi = 0, \quad v_y = 0$$

On cylinder boundary *bc*

$$\varphi = 0, \quad v_r = 0$$

On boundary *cd*

$$v_y = 0$$

On plate boundary *ed*

$$\varphi = 2, \quad v_y = 0$$

On entrance boundary *ae*

$$\varphi = y, \quad v_x = 1$$

Taking “point solution” as the following form containing *n* undetermined constants

$$\varphi = y + y(x^2 - 12.25)(y^2 - 4)(K_1 + K_2x^2 + K_3y^2 + K_4x^4 + K_5y^4 + K_6x^2y^2 + \dots + K_nx^p y^q) \quad (15)$$

Other 4 boundary equations are as follows

On point *b*

$$v_r(-1, 0) = 0 \quad (16)$$

On point *c*

$$\varphi(0, 1) = 0 \quad (17)$$

On point *f*

$$\varphi(-0.7071, 0.7071) = 0 \quad (18)$$

$$v_r(-0.7071, 0.7071) = 0 \quad (19)$$

For a certain solitary point (x_0, y_0) , as $n = 6$, only 2 boundary equations Eq.(16) and Eq.(17) are considered; and the following 4 single point equations are considered.

The first single point equation is reached by Eq.(14)

$$F(x_0, y_0) = 0 \quad (20)$$

Other 3 single point equations are reached as follows by running the derivative operations to Eq.(14).

$$\partial F(x_0, y_0) / \partial x = 0 \quad (21)$$

$$\partial F(x_0, y_0) / \partial y = 0 \quad (22)$$

$$\partial^2 F(x_0, y_0) / \partial x \partial y = 0 \quad (23)$$

Substituting the coordinates values (x_0, y_0) into Eq.(16) and Eq.(17), and Eq.(20) to Eq.(23); after solving these 6 equations, the 6 undetermined constants K_1 to K_6 can be determined, namely the “point solution” for $n = 6$ is reached.

As $n > 8$, the 4 boundary equations Eq.(16) to Eq.(19) are considered; and besides the 4 single point equations Eq.(20) to Eq.(23), the following single point equations derived by running the derivative operations to Eq.(14) are also considered.

$$\partial^2 F(x_0, y_0) / \partial x^2 = 0 \quad (24)$$

$$\partial^2 F(x_0, y_0) / \partial y^2 = 0 \quad (25)$$

$$\partial^3 F(x_0, y_0) / \partial x^3 = 0 \quad (26)$$

$$\partial^3 F(x_0, y_0) / \partial x^2 \partial y = 0 \quad (27)$$

$$\partial^3 F(x_0, y_0) / \partial x \partial y^2 = 0 \quad (28)$$

$$\partial^3 F(x_0, y_0) / \partial y^3 = 0 \quad (29)$$

.....

Substituting the coordinates values (x_0, y_0) into Eq.(16) to Eq.(19), as well as Eq.(20) to Eq.(24), and the like; after solving these *n* equations, the *n* undetermined

constants K_1 to K_n can be determined, namely the “point solution” as the form of Eq.(15) is reached.

For 8 solitary points, the comparisons between accurate analytical solution (AS) and point solution (PS) for the values of φ are shown in table 1.

Table 1. Comparisons between accurate analytical solution (AS) and point solution (PS) for the values of φ

x_0	y_0	AS	$n = 6$	$n = 10$	$n = 14$	$n = 19$
-3.4	1.75	1.747	1.744	1.743	1.746	1.746
-3.0	1.75	1.744	1.729	1.735	1.736	1.738
-2.5	1.75	1.736	1.694	1.751	1.713	1.732
-2.0	1.75	1.721	1.609	1.782	1.631	1.766
-3.4	1.50	1.494	1.489	1.483	1.492	1.493
-3.0	1.50	1.488	1.459	1.452	1.473	1.474
-2.5	1.50	1.474	1.397	1.450	1.439	1.460
-2.0	1.50	1.445	1.248	1.518	1.272	1.563

For more information about single point method, see references [11-13].

The single point method can also be used for prediction.

For example, the sea surface temperature distribution of a given region, is a special two-dimensional problem influenced by many factors, and it is very difficult to be changed into 2 one-dimensional problems. However, this problem can be predicted for a certain solitary point by single point method.

The following example is predicting the monthly average sea surface temperature.

Based on sectional variable dimension fractals, the concept of weighted fractals is presented, i.e., for the data points in an interval, their r coordinates multiply by different weighted coefficients, and making these data points locate at a straight-line in the double logarithmic coordinates. By using weighted fractals, the monthly average sea surface temperature (MASST) data on the point 30°N, 125°E of Northwest Pacific Ocean are analyzed. According to the MASST from January to August in a certain year (eight-point-method), the MASST from September to December of that year has been predicted. Also, according to the MASST of August merely in a certain year (one-point-method), the MASST from September to December of that year has been predicted.

The MASST prediction results are as follows.

Table 2. MASST prediction results (unit: ™) by using eight-point-method (8PM) and one-point-method(1PM)

Year	Notes	Sep.	Oct.	Nov.	Dec.
1958	8PM	28.21	25.51	22.67	20.17
	1PM	28.24	25.55	22.72	20.22

	Real value	27.7	25.5	21.2	20
1959	8PM	28.20	25.56	22.75	20.28
	1PM	28.19	25.54	22.73	20.26
	Real value	27.6	24.7	22.9	20
1960	8PM	27.95	25.36	22.60	20.16
	1PM	28.05	25.51	22.78	20.36
	Real value	28	26	21.8	20
1961	8PM	28.70	26.14	23.37	20.91
	1PM	28.34	25.57	22.69	20.16
	Real value	28.4	26.2	22.8	22
1962	8PM	28.30	26.00	23.46	21.17
	1PM	27.90	25.48	22.83	20.47
	Real value	28	25	21	20
1963	8PM	29.36	27.86	25.78	23.80
	1PM	27.86	25.47	22.85	20.50
	Real value	27.5	24.5	21	18
1964	8PM	28.04	25.83	23.32	21.05
	1PM	27.80	25.46	22.86	20.54
	Real value	28	24.5	22	19

In addition, according to the phenomenon of fractal interrelation and the fractal coefficients of this point’s MASST and the monthly average air temperature of August of some points, the monthly average air temperatures of these points from September to December have also been predicted. For detailed information, see reference [14].

4.3 Relationship between various equations and various solutions

According to Neutrosophy and Quad-stage method; and contacting the concepts of domain of function, the geometry elements included in domain of function, and the like; the concept of equation can be expanded into the concepts of point equation, line equation, plane equation, solid equation, sub-domain equation, whole-domain equation, and the like; and the concept of solution can be expanded into the concepts of point solution, line solution, plane solution, solid solution, sub-domain solution, whole-domain solution, and the like. However, the relationships between them are not the one by one corresponding relationships. Where: the point solutions may be the solutions of point equation, line equation, plane equation, and the like; similarly, the line solutions may be the solutions of point equation, line equation, plane equation, and the like; and so on.

5 Conclusions

The combination of neutrosophy and quad-stage method can be applied to effectively realize the expansion of “traditional concepts of equations and solutions”. The results of expansion are not fixed and immutable, but the

results are changeable depending on the times, places and specific conditions. This paper deals only with a limited number of situations and instances as an initial attempt, and we hope that it will play a valuable role.

References

- [1] Florentin Smarandache, A Unifying Field in Logics: Neutrosophic Logic. Neutrosophy, Neutrosophic Set, Neutrosophic Probability and Statistics, third edition, Xiquan, Phoenix, 2003
- [2] Fu Yuhua, Neutrosophic Examples in Physics, Neutrosophic Sets and Systems, Vol. 1, 2013
- [3] Fu Yuhua, Quad general theses, general antitheses, universal relations, general syntheses in development — Expansion of Hegelian triad thesis, antithesis, synthesis, Matter Regularity, No.1, 2011, 61-64
- [4] Fu Yuhua, Expanding Newton Mechanics with Neutrosophy and Quad-stage Method—New Newton Mechanics Taking Law of Conservation of Energy as Unique Source Law, Neutrosophic Sets and Systems, Vol.3, 2014
- [5] Fu Yuhua, Negating Four Color Theorem with Neutrosophy and Quad-stage Method, Neutrosophic Sets and Systems, Vol.8, 2015
- [6] Fu Yuhua, Expanding Hegelian Triad Thesis, Antithesis, Synthesis with Neutrosophy and Quad-stage Method, China Preprint Service System (in Chinese)
<http://www.nstl.gov.cn/preprint/main.html?action=showFile&id=2c9282824a765e950150e9b4a3930677>
- [7] Fu Yuhua, Interpreting and Expanding Laozi's Governing A Large Country Is Like Cooking A Small Fish with Neutrosophy and Quad-stage Method, China Preprint Service System (in Chinese)
<http://www.nstl.gov.cn/preprint/main.html?action=showFile&id=2c9282824a765e95014fef149c610588>
- [8] Fu Yuhua, Interpreting and Expanding the Meaning of “Yi” with Neutrosophy and Quad-stage Method, China Preprint Service System (in Chinese)
<http://prep.istic.ac.cn/main.html?action=showFile&id=2c928282510e4d730151799c24a40070>
- [9] Fu Yuhua, Creating Generalized and Hybrid Set and Library with Neutrosophy and Quad-stage Method, Chapter 15, Handbook of Research on Generalized and Hybrid Set Structures and Applications for Soft Computing, Sunil Jacob John. © 2016. 480 pages.
- [10] Fu Yuhua. Analysed and fractal single point method for solving hydraulic problems in ocean engineering[R](i.e., SPE(Society of Petroleum Engineers) 29986). International meeting on petroleum engineering, Beijing, Nov 1995. 347~356
- [11] Fu Yuhua, Single point method for solving thin plate problem, '94 International Symposium on Petroleum and Petrochemical Technologies, 1994, Beijing. (in Chinese)
- [12] Fu Yuhua. Analysed and fractal single point method for solving hydraulic equation in ocean engineering, China Offshore Platform, No. Z1, 1994, 371~379. (in Chinese)
- [13] Fu Yuhua, Single point method for solving hydraulic equation, Chinese Journal of Hydrodynamics, Ser. A, Vol. 11, No. 1, 1996.
- [14] Fu Yuhua. Weighted fractals analysis and forecast of monthly average sea surface temperature [J]. Marine science bulletin,. 1996, 15(2): 69~76. (in Chinese)

Received: Jan 12, 2016. Accepted: Feb. 28, 2016.



Isolated Single Valued Neutrosophic Graphs

Said Broumi,¹ Assia Bakali,² Mohamed Talea,³ Florentin Smarandache⁴

^{1,3} Laboratory of Information processing, Faculty of Science Ben M'Sik, University Hassan II, B.P 7955, Sidi Othman, Casablanca, Morocco.
broumisaid78@gmail.com, taleamohamed@yahoo.fr

²Ecole Royale Navale-Boulevard Sour Jdid, B.P 16303 Casablanca, Morocco.
assiabakali@yahoo.fr

³Department of Mathematics, University of New Mexico, 705 Gurley Avenue, Gallup, NM 87301, USA.
fsmarandache@gmail.com

Abstract: Many results have been obtained on isolated graphs and complete graphs. In this paper, a necessary and sufficient condition will be proved for a single valued

neutrosophic graph to be an isolated single valued neutrosophic graph.

Keywords: Single valued neutrosophic graphs, complete single valued neutrosophic graphs, isolated single valued neutrosophic graphs.

1. Introduction

The notion of neutrosophic sets (NSs) was proposed by Smarandache [8] as a generalization of the fuzzy sets [14], intuitionistic fuzzy sets [12], interval valued fuzzy set [11] and interval-valued intuitionistic fuzzy sets [13] theories. The neutrosophic set is a powerful mathematical tool for dealing with incomplete, indeterminate and inconsistent information in real world. The neutrosophic sets are characterized by a truth-membership function (t), an indeterminacy-membership function (i) and a falsity-membership function (f) independently, which are within the real standard or nonstandard unit interval $]-0, 1+[$. In order to conveniently use NS in real life applications, Wang et al. [9] introduced the concept of the single-valued neutrosophic set (SVNS), a subclass of the neutrosophic sets. The same authors [10] introduced the concept of the interval valued neutrosophic set (IVNS), which is more precise and flexible than the single valued neutrosophic set. The IVNS is a generalization of the single valued neutrosophic set, in which the three membership functions are independent and their value belong to the unit interval $[0, 1]$. More works on single valued neutrosophic sets, interval valued neutrosophic sets and their applications can be found on <http://fs.gallup.unm.edu/NSS/> [38].

Graph theory has now become a major branch of applied mathematics and it is generally regarded as a branch of combinatorics. Graph is a widely used tool for solving combinatorial problems in different areas such as geometry, algebra, number theory, topology, optimization and computer science.

If one has uncertainty regarding either the set of vertices or edges, or both, the model becomes a fuzzy

graph. The extension of fuzzy graph [2, 4, 25] theory have been developed by several researchers, e.g. vague graphs [27], considering the vertex sets and edge sets as vague sets; intuitionistic fuzzy graphs [3, 15, 26], considering the vertex sets and edge sets as intuitionistic fuzzy sets; interval valued fuzzy graphs [16, 17, 23, 24], considering the vertex sets and edge sets as interval valued fuzzy sets; interval valued intuitionistic fuzzy graphs [35], considering the vertex sets and edge sets as interval valued intuitionistic fuzzy sets; bipolar fuzzy graphs [18, 19, 21, 22], considering the vertex sets and edge sets as bipolar fuzzy sets; m-polar fuzzy graphs [20], considering the vertex sets and edge sets as m-polar fuzzy sets.

But, if the relations between nodes (or vertices) in problems are indeterminate, the fuzzy graphs and their extensions fail. For this purpose, Smarandache [5, 6, 7, 37] defined four main categories of neutrosophic graphs; two are based on literal indeterminacy (I), called: I -edge neutrosophic graph and I -vertex neutrosophic graph, deeply studied and gaining popularity among the researchers due to their applications via real world problems [1, 38]; the two others are based on (t, i, f) components, called: (t, i, f) -edge neutrosophic graph and (t, i, f) -vertex neutrosophic graph, concepts not developed at all by now.

Later on, Broumi et al. [29] introduced a third neutrosophic graph model, which allows the attachment of truth-membership (t), indeterminacy-membership (i) and falsity-membership degrees (f) both to vertices and edges, and investigated some of their properties. The third neutrosophic graph model is called the single valued neutrosophic graph (SVNG for short). The single valued

neutrosophic graph is a generalization of fuzzy graph and intuitionistic fuzzy graph. Also, the same authors [28] introduced neighborhood degree of a vertex and closed neighborhood degree of a vertex in single valued neutrosophic graph as a generalization of neighborhood degree of a vertex and closed neighborhood degree of a vertex in fuzzy graph and intuitionistic fuzzy graph. Recently, Broumi et al. [31, 33, 34] introduced the concept of interval valued neutrosophic graph as a generalization of fuzzy graph, intuitionistic fuzzy graph and single valued neutrosophic graph and discussed some of their properties with proof and examples.

The aim of this paper is to prove a necessary and sufficient condition for a single valued neutrosophic graph to be a single valued neutrosophic graph.

2. Preliminaries

In this section, we mainly recall some notions related to neutrosophic sets, single valued neutrosophic sets, single valued neutrosophic graphs, relevant to the present article. See [8, 9] for further details and background.

Definition 2.1 [8]

Let X be a space of points (objects) with generic elements in X denoted by x ; then, the neutrosophic set A (NS A) is an object having the form $A = \{ \langle x: T_A(x), I_A(x), F_A(x) \rangle, x \in X \}$, where the functions $T, I, F: X \rightarrow]0,1^+[$ define respectively a truth-membership function, an indeterminacy-membership function and a falsity-membership function of the element $x \in X$ to the set A with the condition:

$$0 \leq T_A(x) + I_A(x) + F_A(x) \leq 3^+ \tag{1}$$

The functions $T_A(x), I_A(x)$ and $F_A(x)$ are real standard or nonstandard subsets of $]0,1^+[$.

Since it is difficult to apply NSs to practical problems, Wang et al. [9] introduced the concept of SVN, which is an instance of a NS, and can be used in real scientific and engineering applications.

Definition 2.2 [9]

Let X be a space of points (objects) with generic elements in X denoted by x . A single valued neutrosophic set A (SVNS A) is characterized by a truth-membership function $T_A(x)$, an indeterminacy-membership function $I_A(x)$, and a falsity-membership function $F_A(x)$. For each point x in X $T_A(x), I_A(x), F_A(x) \in [0, 1]$. A SVN A can be written as

$$A = \{ \langle x: T_A(x), I_A(x), F_A(x) \rangle, x \in X \}. \tag{2}$$

Definition 2.3 [29]

A single valued neutrosophic graph (SVN-graph) with underlying set V is defined to be a pair $G = (A, B)$, where:

1. The functions $T_A: V \rightarrow [0, 1], I_A: V \rightarrow [0, 1]$ and $F_A: V \rightarrow [0, 1]$ denote the degree of truth-membership,

degree of indeterminacy-membership and falsity-membership of the element $v_i \in V$, respectively, and:

$$0 \leq T_A(v_i) + I_A(v_i) + F_A(v_i) \leq 3,$$

for all $v_i \in V$.

2. The functions $T_B: E \subseteq V \times V \rightarrow [0, 1], I_B: E \subseteq V \times V \rightarrow [0, 1]$ and $F_B: E \subseteq V \times V \rightarrow [0, 1]$ are defined by $T_B(v_i, v_j) \leq \min [T_A(v_i), T_A(v_j)], I_B(v_i, v_j) \geq \max [I_A(v_i), I_A(v_j)]$ and $F_B(v_i, v_j) \geq \max [F_A(v_i), F_A(v_j)]$, denoting the degree of truth-membership, indeterminacy-membership and falsity-membership of the edge $(v_i, v_j) \in E$ respectively, where:

$$0 \leq T_B(v_i, v_j) + I_B(v_i, v_j) + F_B(v_i, v_j) \leq 3,$$

for all $(v_i, v_j) \in E$ ($i, j = 1, 2, \dots, n$)

We call A the single valued neutrosophic vertex set of V , and B the single valued neutrosophic edge set of E , respectively.

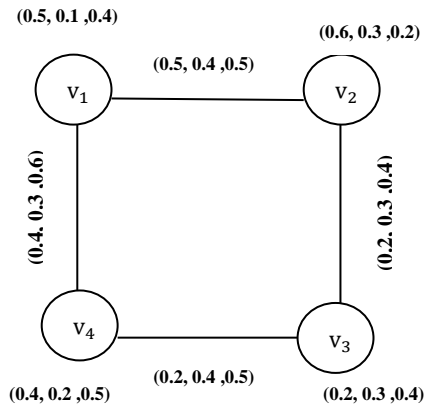

Figure 1: Single valued neutrosophic graph.

Definition 2.4 [29]

A partial SVN-subgraph of SVN-graph $G = (A, B)$ is a SVN-graph $H = (V', E')$, such that:

$$- V' \subseteq V,$$

where $T'_A(v_i) \leq T_A(v_i), I'_A(v_i) \geq I_A(v_i), F'_A(v_i) \geq F_A(v_i)$, for all $v_i \in V$;

$$- E' \subseteq E,$$

where $T'_B(v_i, v_j) \leq T_B(v_i, v_j), I'_{Bij} \geq I_B(v_i, v_j), F'_B(v_i, v_j) \geq F_B(v_i, v_j)$, for all $(v_i, v_j) \in E$.

Definition 2.8 [29]

A single valued neutrosophic graph $G = (A, B)$ of $G^* = (V, E)$ is called complete single valued neutrosophic graph, if:

$$\begin{aligned} T_B(v_i, v_j) &= \min [T_A(v_i), T_A(v_j)], \\ I_B(v_i, v_j) &= \max [I_A(v_i), I_A(v_j)], \\ F_B(v_i, v_j) &= \max [F_A(v_i), F_A(v_j)], \end{aligned}$$

for all $v_i, v_j \in V$.

Definition 2.9 [29]

The complement of a single valued neutrosophic graph $G(A, B)$ on G^* is a single valued neutrosophic graph \bar{G} on G^* , where:

1. $\bar{A} = A = (T_A, I_A, F_A)$;
2. $\bar{T}_A(v_i) = T_A(v_i)$, $\bar{I}_A(v_i) = I_A(v_i)$, $\bar{F}_A(v_i) = F_A(v_i)$,

for all $v_j \in V$.

3. $\bar{T}_B(v_i, v_j) = \min [T_A(v_i), T_A(v_j)] - T_B(v_i, v_j)$,
 $\bar{I}_B(v_i, v_j) = \max [I_A(v_i), I_A(v_j)] - I_B(v_i, v_j)$

and

$$\bar{F}_B(v_i, v_j) = \max [F_A(v_i), F_A(v_j)] - F_B(v_i, v_j),$$

for all $(v_i, v_j) \in E$.

3. Main Result

Theorem 3.1

A single valued neutrosophic graph $G = (A, B)$ is an isolated single valued graph if and only if its complement is a complete single valued neutrosophic graph.

Proof

Let $G : (A, B)$ be a single valued neutrosophic graph, $\bar{G} = (A, \bar{B})$ be its complement, and $G : (A, B)$ be an isolated single valued neutrosophic graph.

Then,

$$T_B(u, v) = 0,$$

$$I_B(u, v) = 0$$

and

$$F_B(u, v) = 0,$$

for all $(u, v) \in V \times V$.

Since

$$\bar{T}_B(u, v) = \min (T_A(u), T_A(v)) - T_B(u, v),$$

for all $(u, v) \in V \times V$,

$$\bar{T}_B(u, v) = \min(T_A(u), T_A(v))$$

and

$$\bar{I}_B(u, v) = \max(I_A(u), I_A(v)) - I_B(u, v),$$

for all $(u, v) \in V \times V$,

$$\bar{I}_B(u, v) = \max(I_A(u), I_A(v))$$

and

$$\bar{F}_B(u, v) = \max(F_A(u), F_A(v)) - F_B(u, v),$$

for all $(u, v) \in V \times V$,

$$\bar{F}_B(u, v) = \max(F_A(u), F_A(v)),$$

hence $\bar{G} = (A, \bar{B})$ is a complete single valued neutrosophic graph.

Conversely, let $\bar{G} = (A, \bar{B})$ be a complete single valued neutrosophic graph

$$\bar{T}_B(u, v) = \min(T_A(u), T_A(v)),$$

for all $(u, v) \in V \times V$.

Since

$$\bar{T}_B(u, v) = \min(T_A(u), T_A(v)) - \bar{T}_B(u, v),$$

for all $(u, v) \in V \times V$,

$$= \bar{T}_B(u, v) - \bar{T}_B(u, v),$$

for all $(u, v) \in V \times V$,

$$= 0,$$

for all $(u, v) \in V \times V$,

$$T_B(u, v) = 0,$$

for all $(u, v) \in V \times V$.

$$\bar{I}_B(u, v) = \max(I_A(u), I_A(v)),$$

for all $(u, v) \in V \times V$.

Since

$$\bar{I}_B(u, v) = \max(I_A(u), I_A(v)) - \bar{I}_B(u, v),$$

for all $(u, v) \in V \times V$

$$= \bar{I}_B(u, v) - \bar{I}_B(u, v),$$

for all $(u, v) \in V \times V$

$$= 0,$$

for all $(u, v) \in V \times V$,

$$I_B(u, v) = 0,$$

for all $(u, v) \in V \times V$.

Also,

$$\bar{F}_B(u, v) = \max(F_A(u), F_A(v)),$$

for all $(u, v) \in V \times V$.

Since

$$\bar{F}_B(u, v) = \max(F_A(u), F_A(v)) - \bar{F}_B(u, v),$$

for all $(u, v) \in V \times V$,

$$= \bar{F}_B(u, v) - \bar{F}_B(u, v),$$

for all $(u, v) \in V \times V$

$$= 0,$$

for all $(u, v) \in V \times V$

$$F_B(u, v) = 0 \text{ for all } (u, v) \in V \times V,$$

hence $G = (A, B)$ is an isolated single valued neutrosophic graph.

4. Conclusion

Many problems of practical interest can be represented by graphs. In general, graph theory has a wide range of applications in various fields. In this paper, we defined for the first time the notion of an isolated single valued neutrosophic graph. In future works, we plan to study the concept of an isolated interval valued neutrosophic graph.

References

- [1] A. V. Devadoss, A. Rajkumar & N. J. P. Praveena. A Study on Miracles through Holy Bible using Neutrosophic Cognitive Maps (NCMS). In: International Journal of Computer Applications, 69(3) (2013).
- [2] A. Nagoor Gani and M. B. Ahamed. Order and Size in Fuzzy Graphs. In: Bulletin of Pure and Applied Sciences, Vol 22E (No.1) (2003) 145-148.
- [3] A. N. Gani. A. and S. Shajitha Begum. Degree, Order and Size in Intuitionistic Fuzzy Graphs. In: Intl. Journal of Algorithms, Computing and Mathematics, (3)3 (2010).
- [4] A. Nagoor Gani and S.R Latha. On Irregular Fuzzy Graphs. In: Applied Mathematical Sciences, Vol. 6, no.11 (2012) 517-523.
- [5] F. Smarandache. Refined Literal Indeterminacy and the Multiplication Law of Sub-Indeterminacies. In: Neutrosophic Sets and Systems, Vol. 9 (2015) 58- 63.
- [6] F. Smarandache. Types of Neutrosophic Graphs and Neutrosophic Algebraic Structures together with their Applications in Technology, Seminar, Universitatea Transilvania din Brasov, Facultatea de Design de Produs si Mediu, Brasov, Romania 06 June 2015.
- [7] F. Smarandache. Symbolic Neutrosophic Theory. Brussels: Europeanova, 2015, 195 p.
- [8] F. Smarandache. Neutrosophic set - a generalization of the intuitionistic fuzzy set. In: Granular Computing, 2006 IEEE Intl. Conference, (2006) 38 – 42, DOI: 10.1109/GRC.2006.1635754.
- [9] H. Wang, F. Smarandache, Y. Zhang, and R. Sunderraman. Single Valued Neutrosophic Sets. In: Multispace and Multistructure, 4 (2010) 410-413.
- [10] H. Wang, F. Smarandache, Zhang, Y.-Q. and R. Sunder-raman. Interval Neutrosophic Sets and Logic: Theory and Applications in Computing. Phoenix: Hexis, 2005.
- [11] I. Turksen. Interval valued fuzzy sets based on normal forms. In: Fuzzy Sets and Systems, vol. 20 (1986) 191-210.
- [12] K. Atanassov. Intuitionistic fuzzy sets. In: Fuzzy Sets and Systems. vol. 20 (1986) 87-96.
- [13] K. Atanassov and G. Gargov. Interval valued intuitionistic fuzzy sets. In: Fuzzy Sets and Systems, vol. 31 (1989) 343-349.
- [14] L. Zadeh. Fuzzy sets. In: Information and Control, 8 (1965) 338-353.
- [15] M. Akram and B. Davvaz. Strong intuitionistic fuzzy graphs. In: Filomat, vol. 26, no. 1 (2012) 177–196.
- [16] M. Akram and W. A. Dudek. Interval-valued fuzzy graphs. In: Computers & Mathematics with Applications, vol. 61, no. 2 (2011) 289–299.
- [17] M. Akram. Interval-valued fuzzy line graphs. In: Neural Comp. and Applications, vol. 21 (2012) 145–150.
- [18] M. Akram. Bipolar fuzzy graphs. In: Information Sciences, vol. 181, no. 24 (2011) 5548–5564.
- [19] M. Akram. Bipolar fuzzy graphs with applications. In: Knowledge Based Systems, vol. 39 (2013) 1–8.
- [20] M. Akram and A. Adeel. m-polar fuzzy graphs and m-polar fuzzy line graphs. In: Journal of Discrete Mathematical Sciences and Cryptography, 2015.
- [21] M. Akram, W. A. Dudek. Regular bipolar fuzzy graphs. In: Neural Computing and Applications, vol. 21, pp. 97-205 (2012).
- [22] M. Akram, W.A. Dudek, S. Sarwar. Properties of Bipolar Fuzzy Hypergraphs. In: Italian Journal of Pure and Applied Mathematics, no. 31 (2013), 141–160.
- [23] M. Akram, N. O. Alshehri, and W. A. Dudek. Certain Types of Interval-Valued Fuzzy Graphs. In: Journal of Appl. Mathematics, 2013, 11 pages, <http://dx.doi.org/10.1155/2013/857070>.
- [24] M. Akram, M. M. Yousaf, W. A. Dudek. Self-centered interval-valued fuzzy graphs. In: Afrika Matematika, vol. 26, Issue 5, pp 887-898, 2015.
- [25] P. Bhattacharya. Some remarks on fuzzy graphs. In: Pattern Recognition Letters 6 (1987) 297-302.
- [26] R. Parvathi and M. G. Karunambigai. Intuitionistic Fuzzy Graphs. In: Computational Intelligence. In: Theory and applications, International Conference in Germany, Sept 18 -20, 2006.
- [27] R. A. Borzooei, H. Rashmanlou. More Results On Vague Graphs, U.P.B. Sci. Bull., Series A, Vol. 78, Issue 1, 2016, 109-122.
- [28] S. Broumi, M. Talea, F. Smarandache, A. Bakali. Single Valued Neutrosophic Graphs: Degree, Order and Size, FUZZ IEEE Conference (2016), 8 page.
- [29] S.Broumi, M. Talea, A. Bakali, F. Smarandache. Single Valued Neutrosophic Graphs. In: Journal of New Theory, no. 10, 68-101 (2016).
- [30] S. Broumi, M. Talea, A. Bakali, F. Smarandache. On Bipolar Single Valued Neutrosophic Graphs. In: Journal of New Theory, no. 11, 84-102 (2016).
- [31] S. Broumi, M. Talea, A.Bakali, F. Smarandache. Interval Valued Neutrosophic Graphs. SISOM Conference (2016), in press.
- [32] S. Broumi, F. Smarandache, M. Talea, A. Bakali. An Introduction to Bipolar Single Valued Neutrosophic Graph Theory. OPTIROB conference, 2016.
- [33] S. Broumi, M. Talea, A.Bakali, F. Smarandache. Operations on Interval Valued Neutrosophic Graphs (2016), submitted.
- [34] S. Broumi, M. Talea, A.Bakali, F. Smarandache, Strong Interval Valued Neutrosophic Graphs, (2016), submitted.
- [35] S. N. Mishra and A. Pal. Product of Interval Valued Intuitionistic fuzzy graph. In: Annals of Pure and Applied Mathematics, Vol. 5, No.1 (2013) 37-46.
- [36] S. Raurikar. On Isolated Fuzzy Graph. In: Intl. Journal of Research in Engineering Technology and Management, 3 pages.
- [37] W. B. Vasantha Kandasamy, K. Ilanthenral and F. Smarandache. Neutrosophic Graphs: A New Dimension

to Graph Theory. Kindle Edition, 2015.

[38] More information, on <http://fs.gallup.unm.edu/NSS/>.

Received: Mar. 05, 2016. Accepted: Mar. 28, 2016



Neutrosophic Set Approach for Characterizations of Left Almost Semigroups

Madad Khan¹, Florentin Smarandache² and Sania Afzal³

¹ Department of Mathematics, COMSATS Institute of Information Technology, Abbottabad, Pakistan . E-mail: madadmath@yahoo.com

² Department of Mathematics & Science, University of New Mexico, Gallup, New Mexico, USA. E-mail: fsmarandache@gmail.com

³ Department of Mathematics, COMSATS Institute of Information Technology, Abbottabad, Pakistan . E-mail: saniaafzal1991@gmail.com

Abstract. In this paper we have defined neutrosophic ideals, neutrosophic interior ideals, neutrosophic quasi-ideals and neutrosophic bi-ideals (neutrosophic generalized bi-ideals) and proved some results related to them. Furthermore, we have done some characterization of a neutrosophic LA-semigroup by the properties of its neutrosophic ideals. It has been proved that in a

neutrosophic intra-regular LA-semigroup neutrosophic left, right, two-sided, interior, bi-ideal, generalized bi-ideal and quasi-ideals coincide and we have also proved that the set of neutrosophic ideals of a neutrosophic intra-regular LA-semigroup forms a semilattice structure.

Keywords: Neutrosophic LA-semigroup; neutrosophic intra-regular LA-semigroup; neutrosophic left invertive law; neutrosophic ideal.

Introduction

It is well known fact that common models with their limited and restricted boundaries of truth and falsehood are insufficient to detect the reality so there is a need to discover and introduce some other phenomenon that address the daily life problems in a more appropriate way. In different fields of life many problems arise which are full of uncertainties and classical methods are not enough to deal and solve them. In fact, reality of real life problems cannot be represented by models with just crisp assumptions with only yes or no because of such certain assumptions may lead us to completely wrong solutions. To overcome this problem, Lotfi A.Zadeh in 1965 introduced the idea of a fuzzy set which help to describe the behaviour of systems that are too complex or are ill-defined to admit precise mathematical analysis by classical methods. He discovered the relationships of probability and fuzzy set theory which has appropriate approach to deal with uncertainties. According to him every set is not crisp and fuzzy set is one of the example that is not crisp. This fuzzy set help us to reduce the chances of failures in modelling.. Many authors have applied the fuzzy set theory to generalize the basic theories of Algebra. Mordeson et al. has discovered the grand exploration of fuzzy semigroups, where theory of fuzzy semigroups is explored along with the applications of fuzzy semigroups in fuzzy coding, fuzzy finite state mechanics and fuzzy languages etc.

Zadeh introduced the degree of membership/truth (t) in 1965 and defined the fuzzy set. Atanassov introduced the degree of nonmembership/falsehood (f) in 1986 and defined the intuitionistic fuzzy set. Smarandache introduced the degree of indeterminacy/neutrality (i) as

independent component in 1995 (published in 1998) and defined the neutrosophic set. He has coined the words neutrosophy and neutrosophic. In 2013 he refined the neutrosophic set to n components: $t_1, t_2, \dots ; i_1, i_2, \dots ;$

f_1, f_2, \dots . The words neutrosophy and neutrosophic were coined/invented by F. Smarandache in his 1998 book. Etymologically, neutro-sophy (noun) [French neutre <Latin neuter, neutral, and Greek sophia, skill/wisdom] means knowledge of neutral thought. While neutrosophic (adjective), means having the nature of, or having the characteristic of Neutrosophy.

Recently, several theories have been presented to dispute with uncertainty, vagueness and imprecision. Theory of probability, fuzzy set theory, intuitionistic fuzzy sets, rough set theory etc., are consistently being used as actively operative tools to deal with multiform uncertainties and imprecision enclosed in a system. But all these above theories failed to deal with indeterminate and inconsistent information. Therefore, due to the existence of indeterminacy in various world problems, neutrosophy finds its way into the modern research. Neutrosophy was developed in attempt to generalize fuzzy logic. Neutrosophy is a Latin word "neuter" - neutral, Greek "sophia" - skill/wisdom). Neutrosophy is a branch of philosophy, introduced by Florentin Smarandache which studies the origin, nature, and scope of neutralities, as well as their interactions with different ideational spectra. Neutrosophy considers a proposition, theory, event, concept, or entity, "A" in relation to its opposite, "Anti-A" and that which is not A, "Non-A", and that which is neither "A" nor "Anti-A", denoted by "Neut-A". Neutrosophy is

the basis of neutrosophic logic, neutrosophic probability, neutrosophic set, and neutrosophic statistics.

Inspiring from the realities of real life phenomenons like sport games (winning/ tie/ defeating), votes (yes/ NA/ no) and decision making (making a decision/ hesitating/ not making), F. Smrandache introduced a new concept of a neutrosophic set (NS in short) in 1995, which is the generalization of a fuzzy sets and intuitionistic fuzzy set. NS is described by membership degree, indeterminate degree and non-membership degree. The idea of NS generates the theory of neutrosophic sets by giving representation to indeterminates. This theory is considered as complete representation of almost every model of all real-world problems. Therefore, if uncertainty is involved in a problem we use fuzzy theory while dealing indeterminacy, we need neutrosophic theory. In fact this theory has several applications in many different fields like control theory, databases, medical diagnosis problem and decision making problems.

Using Neutrosophic theory, Vasantha Kandasmy and Florentin Smarandache introduced the concept of neutrosophic algebraic structures in 2003. Some of the neutrosophic algebraic structures introduced and studied including neutrosophic fields, neutrosophic vector spaces, neutrosophic groups, neutrosophic bigroups, neutrosophic N-groups, neutrosophic bisemigroups, neutrosophic N-semigroup, neutrosophic loops, neutrosophic biloops, neutrosophic N-loop, neutrosophic groupoids, neutrosophic bigroupoids and neutrosophic AG-groupoids. Madad Khan et al., for the first time introduced the idea of a neutrosophic AG-groupoid in [13].

1 Preliminaries

Abel-Grassmann's Groupoid (abbreviated as an AG-groupoid or LA-semigroup) was first introduced by Naseeruddin and Kazim in 1972. LA-semigroup is a groupoid S whose elements satisfy the left invertive law $(ab)c = (cb)a$ for all $a, b, c \in S$. LA-semigroup generalizes the concept of commutative semigroups and have an important application within the theory of flocks. In addition to applications, a variety of properties have been studied for AG-groupoids and related structures. An LA-semigroup is a non-associative algebraic structure that is generally considered as a midway between a groupoid and a commutative semigroup but is very close to commutative semigroup because most of their properties are similar to commutative semigroup. Every commutative semigroup is an AG-groupoid but not vice versa. Thus AG-groupoids can also be non-associative, however, they do not necessarily have the Latin square property. An LA-semigroup S can have left identity e (unique) i.e $ea = a$ for all $a \in S$ but it cannot have a right identity because if it has, then S becomes a commutative semigroup. An

element s of LA-semigroup S is called idempotent if $s^2 = s$ and if holds for all elements of S then S is called idempotent LA-semigroup.

Since the world is full of indeterminacy, the neutrosophics found their place into contemporary research. In 1995, Florentin Smarandache introduced the idea of neutrosophy. Neutrosophic logic is an extension of fuzzy logic. In 2003 W.B Vasantha Kandasamy and Florentin Smarandache introduced algebraic structures (such as neutrosophic semigroup, neutrosophic ring, etc.). Madad Khan et al., for the first time introduced the idea of a neutrosophic LA-semigroup in [Madad Saima]. Moreover $SUI = \{a + bI : a, b \in S \text{ and } I \text{ is literal indeterminacy such that } I^2 = I\}$ becomes neutrosophic LA-semigroup under the operation defined as:

$(a + bI) * (c + dI) = ac + bdI$ for all $(a + bI), (c + dI) \in SUI$. That is $(SUI, *)$ becomes neutrosophic LA-semigroup. They represented it by $N(S)$.

$[(a_1 + a_2I)(b_1 + b_2I)](c_1 + c_2I) = [(c_1 + c_2I)(b_1 + b_2I)](a_1 + a_2I)$, holds for all $(a_1 + a_2I), (b_1 + b_2I), (c_1 + c_2I) \in N(S)$.

It is since then called the neutrosophic left invertive law. A neutrosophic groupoid satisfying the left invertive law is called a neutrosophic left almost semigroup and is abbreviated as neutrosophic LA-semigroup.

In a neutrosophic LA-semigroup $N(S)$ medial law holds i.e

$[(a_1 + a_2I)(b_1 + b_2I)][(c_1 + c_2I)(d_1 + d_2I)] = [(a_1 + a_2I)(c_1 + c_2I)][(b_1 + b_2I)(d_1 + d_2I)]$, holds

for all $(a_1 + a_2I), (b_1 + b_2I), (c_1 + c_2I), (d_1 + d_2I) \in N(S)$.

There can be a unique left identity in a neutrosophic LA-semigroup. In a neutrosophic LA-semigroup $N(S)$ with left identity $(e + eI)$ the following laws hold for all $(a_1 + a_2I), (b_1 + b_2I), (c_1 + c_2I), (d_1 + d_2I) \in N(S)$.

$[(a_1 + a_2I)(b_1 + b_2I)][(c_1 + c_2I)(d_1 + d_2I)] = [(d_1 + d_2I)(b_1 + b_2I)][(c_1 + c_2I)(a_1 + a_2I)]$,
 $[(a_1 + a_2I)(b_1 + b_2I)][(c_1 + c_2I)(d_1 + d_2I)] = [(d_1 + d_2I)(c_1 + c_2I)][(b_1 + b_2I)(a_1 + a_2I)]$, and

$(a_1 + a_2I)[(b_1 + b_2I)(c_1 + c_2I)] = (b_1 + b_2I)[(a_1 + a_2I)(c_1 + c_2I)]$.

(3) is called neutrosophic paramedial law and a neutrosophic LA semigroup satisfies (5) is called

neutrosophic AG^{**}-groupoid.

Now, $(a + bI)^2 = a + bI$ implies $a + bI$ is idempotent and if holds for all $a + bI \in N(S)$ then $N(S)$ is called idempotent neutrosophic LA-semigroup.

2 Neutrosophic LA-semigroups

Example 2.1 Let $S = \{1, 2, 3\}$ with binary operation " \cdot " is an LA-semigroup with left identity 3 and has the following Calley's table:

\cdot	1	2	3
1	3	1	2
2	2	3	1
3	1	2	3

then

$N(S) = \{1+1I, 1+2I, 1+3I, 2+1I, 2+2I, 2+3I, 3+1I, 3+2I, 3+3I\}$ is an example of neutrosophic LA-semigroup under the operation " $*$ " and has the following Callay's table:

$*$	1+1I	1+2I	1+3I	2+1I	2+2I	2+3I	3+1I	3+2I	3+3I
1+1I	3+3I	3+1I	3+2I	1+3I	1+1I	1+2I	2+3I	2+1I	2+2I
1+2I	3+2I	3+3I	3+1I	1+2I	1+3I	1+1I	2+2I	2+3I	2+1I
1+3I	3+1I	3+2I	3+3I	1+1I	1+2I	1+3I	2+1I	2+2I	2+3I
2+1I	2+3I	2+1I	2+2I	3+3I	3+1I	3+2I	1+3I	1+1I	1+2I
2+2I	2+2I	2+3I	2+1I	3+2I	3+3I	3+1I	1+2I	1+3I	1+1I
2+3I	2+1I	2+2I	2+3I	3+1I	3+2I	3+3I	1+1I	1+2I	1+3I
3+1I	1+3I	1+1I	1+2I	2+3I	2+1I	2+2I	3+3I	3+1I	3+2I
3+2I	1+2I	1+3I	1+1I	2+2I	2+3I	2+1I	3+2I	3+3I	3+1I
3+3I	1+1I	1+2I	1+3I	2+1I	2+2I	2+3I	3+1I	3+2I	3+3I

It is important to note that if $N(S)$ contains left identity $3+3I$ then $(N(S))^2 = N(S)$.

Lemma 2.1: If a neutrosophic LA-semigroup $N(S)$ contains left identity $e + Ie$ then the following conditions hold.

- (i) $N(S)N(L) = N(L)$ for every neutrosophic left ideal $N(L)$ of $N(S)$.
- (ii) $N(R)N(S) = N(R)$ for every neutrosophic right ideal $N(R)$ of $N(S)$.

Proof (i) Let $N(L)$ be the neutrosophic left ideal of $N(S)$ implies that $N(S)N(L) \subseteq N(L)$. Let $a + bI \in N(L)$ and since $a + bI = (e + eI)(a + bI) \in N(S)N(L)$ which implies that $N(L) \subseteq N(S)N(L)$. Thus $N(L) = N(S)N(L)$.

(ii) Let $N(R)$ be the neutrosophic right ideal of $N(S)$.

Then $N(R)N(S) \subseteq N(R)$. Now, let $a + bI \in N(R)$. Then

$$\begin{aligned} a + bI &= (e + eI)(a + bI) \\ &= [(e + eI)(e + eI)](a + bI) \\ &= [(a + bI)(e + eI)](e + eI) \\ &\in (N(R)N(S))N(S) \\ &\subseteq N(R)N(S). \end{aligned}$$

Thus $N(R) \subseteq N(R)N(S)$. Hence $N(R)N(S) = N(R)$.

A subset $N(Q)$ of an neutrosophic LA-semigroup is called neutrosophic quasi-ideal if $N(Q)N(S) \cap N(S)N(Q) \subseteq N(Q)$. A subset $N(I)$ of an LA-semigroup $N(S)$ is called idempotent if $(N(I))^2 = N(I)$.

Lemma 2.2: The intersection of a neutrosophic left ideal $N(L)$ and a neutrosophic right ideal $N(R)$ of a neutrosophic LA-semigroup $N(S)$ is a neutrosophic quasi-ideal of $N(S)$.

Proof Let $N(L)$ and $N(R)$ be the neutrosophic left and right ideals of neutrosophic LA-semigroup $N(S)$ resp.

Since $N(L) \cap N(R) \subseteq N(R)$ and $N(L) \cap N(R) \subseteq N(L)$ and $N(S)N(L) \subseteq N(L)$ and $N(R)N(S) \subseteq N(R)$. Thus

$$\begin{aligned} &(N(L) \cap N(R))N(S) \cap N(S)(N(L) \cap N(R)) \\ &\subseteq N(R)N(S) \cap N(S)N(L) \\ &\subseteq N(R) \cap N(L) \\ &= N(L) \cap N(R). \end{aligned}$$

Hence, $N(L) \cap N(R)$ is a neutrosophic quasi-ideal of $N(S)$.

A subset (neutrosophic LA-subsemigroup) $N(B)$ of a neutrosophic LA-semigroup $N(S)$ is called neutrosophic generalized bi-ideal (neutrosophic bi-ideal) of $N(S)$ if $(N(B)N(S))N(B) \subseteq N(B)$.

Lemma 2.3: If $N(B)$ is a neutrosophic bi-ideal of a neutrosophic LA-semigroup $N(S)$ with left identity $e + eI$, then $((x_1 + Iy_1)N(B))(x_2 + Iy_2)$ is also a neutrosophic bi-ideal of $N(S)$, for any $x_1 + Iy_1$ and $x_2 + Iy_2$ in $N(S)$.

Proof Let $N(B)$ be a neutrosophic bi-ideal of $N(S)$, $(x_2 + y_2I) \in N(M)$, we have now using (1), (2), (3) and (4), we get

$$\begin{aligned} & [\{(x_1 + y_1I)N(B)\}(x_2 + y_2I)\}N(S)][\{(x_1 + y_1I)N(B)\}(x_2 + y_2I)] \\ &= [\{N(S)(x_2 + y_2I)\}\{(x_1 + y_1I)N(B)\}][\{(x_1 + y_1I)N(B)\}(x_2 + y_2I)] \\ &= [\{(x_1 + y_1I)N(B)\}(x_2 + y_2I)\}\{(x_1 + y_1I)N(B)\}][N(S)(x_2 + y_2I)] \\ &= [\{(x_1 + y_1I)N(B)\}(x_1 + y_1I)\}\{(x_2 + y_2I)N(B)\}][N(S)(x_2 + y_2I)] \\ &= [\{(x_1 + y_1I)N(B)\}(x_1 + y_1I)\}N(S)][\{(x_2 + y_2I)N(B)\}(x_2 + y_2I)] \\ &= [\{N(S)(x_1 + y_1I)\}\{(x_1 + y_1I)N(B)\}][\{(x_2 + y_2I)N(B)\}(x_2 + y_2I)] \\ &= [\{N(B)(x_1 + y_1I)\}\{(x_1 + y_1I)N(S)\}][\{(x_2 + y_2I)N(B)\}(x_2 + y_2I)] \\ &= [\{N(B)(x_1 + y_1I)\}\{(x_2 + y_2I)N(B)\}][\{(x_1 + y_1I)N(S)\}(x_2 + y_2I)] \\ &\subseteq [\{N(B)(x_1 + y_1I)\}\{(x_2 + y_2I)N(B)\}]N(S) \\ &= [\{N(B)(x_1 + y_1I)\}\{(x_2 + y_2I)N(B)\}][e + eI]N(S) \\ &= [\{N(B)(x_1 + y_1I)\}(e + eI)][\{(x_2 + y_2I)N(B)\}N(S)] \\ &= [\{(e + eI)(x_1 + y_1I)\}N(B)][\{N(S)N(B)\}(x_2 + y_2I)] \\ &= [(x_2 + y_2I)\{N(S)N(B)\}][N(B)(x_1 + y_1I)] \\ &= [\{(e + eI)(x_2 + y_2I)\}(N(S)N(B))][N(B)(x_1 + y_1I)] \\ &= [\{N(B)N(S)\}\{(x_2 + y_2I)(e + eI)\}][N(B)(x_1 + y_1I)] \\ &= [(N(B)N(S))N(B)][\{(x_2 + y_2I)(e + eI)\}(x_1 + y_1I)] \\ &\subseteq N(B)[\{(x_2 + y_2I)(e + eI)\}(x_1 + y_1I)] \\ &= [(x_2 + y_2I)(e + eI)][N(B)(x_1 + y_1I)] \\ &= [(x_1 + y_1I)N(B)][(e + eI)(x_2 + y_2I)] \\ &= [(x_1 + y_1I)N(B)](x_2 + y_2I). \end{aligned}$$

A subset $N(I)$ of a neutrosophic LA-semigroup $N(S)$ is called a neutrosophic interior ideal if $(N(S)N(I))N(S) \subseteq N(I)$.

A subset $N(M)$ of a neutrosophic LA-semigroup $N(S)$ is called a neutrosophic minimal left (right, two sided, interior, quasi- or bi-) ideal if it does not contains any other neutrosophic left (right, two sided, interior, quasi- or bi-) ideal of $N(S)$ other than itself.

Lemma 2.4: If $N(M)$ is a minimal bi-ideal of $N(S)$ with left identity and $N(B)$ is any arbitrary neutrosophic bi-ideal of $N(S)$, then $N(M) = ((x_1 + Iy_1)N(B))(x_2 + Iy_2)$, for every $(x_1 + y_1I), (x_2 + y_2I) \in N(M)$.

Proof Let $N(M)$ be a neutrosophic minimal bi-ideal and $N(B)$ be any neutrosophic bi-ideal of $N(S)$, then by Lemma 2.3, $[(x_1 + y_1I)N(B)](x_2 + y_2I)$ is a neutrosophic bi-ideal of $N(S)$ for every $(x_1 + y_1I), (x_2 + y_2I) \in N(S)$. Let $(x_1 + y_1I) \in N(M)$,

$$\begin{aligned} [(x_1 + y_1I)N(B)](x_2 + y_2I) &\subseteq [N(M)N(B)]N(M) \\ &\subseteq [N(M)N(S)]N(M) \\ &\subseteq N(M). \end{aligned}$$

But $N(M)$ is a neutrosophic minimal bi-ideal, so $[(x_1 + y_1I)N(B)](x_2 + y_2I) = N(M)$.

Lemma 2.5: In a neutrosophic LA-semigroup $N(S)$ with left identity, every idempotent neutrosophic quasi-ideal is a neutrosophic bi-ideal of $N(S)$.

Proof Let $N(Q)$ be an idempotent neutrosophic quasi-ideal of $N(S)$, then clearly $N(Q)$ is a neutrosophic LA-subsemigroup too.

$$\begin{aligned} (N(Q)N(S))N(Q) &\subseteq (N(Q)N(S))N(S) \\ &= (N(S)N(S))N(Q) \\ &= N(S)N(Q), \text{ and} \\ (N(Q)N(S))N(Q) &\subseteq (N(S)N(S))N(Q) \\ &= (N(S)N(S))(N(Q)N(Q)) \\ &= (N(Q)N(Q))(N(S)N(S)) \\ &= N(Q)N(S). \end{aligned}$$

Thus

$$(N(Q)N(S))N(Q) \subseteq (N(Q)N(S)) \cap (N(S)N(Q)) \subseteq N(Q).$$

Hence, $N(Q)$ is a neutrosophic bi-ideal of $N(S)$.

Lemma 2.6: If $N(A)$ is an idempotent neutrosophic quasi-ideal of a neutrosophic LA-semigroup $N(S)$ with left identity $e + eI$, then $N(A)N(B)$ is a neutrosophic bi-ideal of $N(S)$, where $N(B)$ is any neutrosophic subset of $N(S)$.

Proof Let $N(A)$ be the neutrosophic quasi-ideal of $N(S)$ and $N(B)$ be any subset of $N(S)$.

$$\begin{aligned} & ((N(A)N(B))N(S))(N(A)N(B)) \\ &= ((N(S)N(B))N(A))(N(A)N(B)) \\ &\subseteq ((N(S)N(S))N(A))(N(A)N(B)) \\ &= (N(S)N(A))(N(A)N(B)) \\ &= (N(B)N(A))(N(A)N(S)) \\ &= ((N(A)N(S))N(A))N(B) \\ &\subseteq N(A)N(B) \end{aligned}$$

Hence $N(A)N(B)$ is neutrosophic bi-ideal of $N(S)$.

Lemma 2.7: If $N(L)$ is a neutrosophic left ideal and $N(R)$ is a neutrosophic right ideal of a neutrosophic LA-semigroup $N(S)$ with left identity $e + eI$ then $N(L) \cup N(L)N(S)$ and $N(R) \cup N(S)N(R)$ are neutrosophic two sided ideals of $N(S)$.

Proof Let $N(R)$ be a neutrosophic right ideal of $N(S)$ then by using (3) and (4), we have

$$\begin{aligned} & [N(R) \cup N(S)N(R)]N(S) \\ &= N(R)N(S) \cup [N(S)N(R)]N(S) \\ &\subseteq N(R) \cup [N(S)N(R)][N(S)N(S)] \\ &= N(R) \cup [N(S)N(S)][N(R)N(S)] \\ &= N(R) \cup N(S)[N(R)N(S)] \\ &= N(R) \cup N(R)[N(S)N(S)] \\ &= N(R) \cup N(R)N(S) \\ &= N(R) \subseteq N(R) \cup N(S)N(R). \end{aligned}$$

and

$$\begin{aligned} & N(S)[N(R) \cup N(S)N(R)] \\ &= N(S)N(R) \cup N(S)[N(S)N(R)] \\ &= N(S)N(R) \cup [N(S)N(S)][N(S)N(R)] \\ &= N(S)N(R) \cup [N(R)N(S)][N(S)N(S)] \\ &\subseteq N(S)N(R) \cup N(R)[N(S)N(S)] \\ &= N(S)N(R) \cup N(R)N(S) \\ &\subseteq N(S)N(R) \cup N(R) \\ &= N(R) \cup N(S)N(R). \end{aligned}$$

Hence $[N(R) \cup N(S)N(R)]$ is a neutrosophic two sided ideal of $N(S)$. Similarly we can show that $[N(L) \cup N(S)N(L)]$ is a neutrosophic two-sided ideal of $N(S)$.

Lemma 2.8: A subset $N(I)$ of a neutrosophic LA-semigroup $N(S)$ with left identity $e + eI$ is a neutrosophic right ideal of $N(S)$ if and only if it is a neutrosophic interior ideal of $N(S)$.

Proof Let $N(I)$ be a neutrosophic right ideal of $N(S)$

$$\begin{aligned} N(S)N(I) &= [N(S)N(S)]N(I) \\ &= [N(I)N(S)]N(S) \\ &\subseteq N(I)N(S) \\ &\subseteq N(I). \end{aligned}$$

So $N(I)$ is a neutrosophic two-sided ideal of $N(S)$, so

is a neutrosophic interior ideal of $N(S)$.

Conversely, assume that $N(I)$ is a neutrosophic interior ideal of $N(S)$, then by using (4) and (3), we have

$$\begin{aligned} N(I)N(S) &= N(I)[N(S)N(S)] \\ &= N(S)[N(I)N(S)] \\ &= [N(S)N(S)][N(I)N(S)] \\ &= [N(S)N(I)][N(S)N(S)] \\ &= [N(S)N(I)]N(S) \\ &\subseteq N(I). \end{aligned}$$

If $N(A)$ and $N(M)$ are neutrosophic two-sided ideals of a neutrosophic LA-semigroup $N(S)$, such that $(N(A))^2 \subseteq N(M)$ implies $N(A) \subseteq N(M)$, then $N(M)$ is called neutrosophic semiprime.

Theorem 2.1: In a neutrosophic LA-semigroup $N(S)$ with left identity $e + eI$, the following conditions are equivalent.

(i) If $N(A)$ and $N(M)$ are neutrosophic two-sided ideals of $N(S)$, then $(N(A))^2 \subseteq N(M)$ implies $N(A) \subseteq N(M)$.

(ii) If $N(R)$ is a neutrosophic right ideal of $N(S)$ and $N(M)$ is a neutrosophic two-sided ideal of $N(S)$ then $(N(R))^2 \subseteq N(M)$ implies $N(R) \subseteq N(M)$.

(iii) If $N(L)$ is a neutrosophic left ideal of $N(S)$ and $N(M)$ is a neutrosophic two-sided ideal of $N(S)$ then $(N(L))^2 \subseteq N(M)$ implies $N(L) \subseteq N(M)$.

Proof (i) \Rightarrow (iii)

Let $N(L)$ be a left ideal of $N(S)$ and $[N(L)]^2 \subseteq N(M)$, then by Lemma ref: slrs, $N(L) \cup N(L)N(S)$ is a neutrosophic two sided ideal of $N(S)$, therefore by assumption (i), we have $[N(L) \cup N(L)N(S)]^2 \subseteq N(M)$ which implies $[N(L) \cup N(L)N(S)] \subseteq N(M)$ which further implies that $N(L) \subseteq N(M)$.

(iii) \Rightarrow (ii) and (ii) \Rightarrow (i) are obvious.

Theorem 2.2: A neutrosophic left ideal $N(M)$ of a neutrosophic LA-semigroup $N(S)$ with left identity $e + eI$ is neutrosophic quasi semiprime if and only if $(a_1 + b_1I)^2 \in N(M)$ implies $a_1 + b_1I \in N(M)$.

Proof Let $N(M)$ be a neutrosophic semiprime left ideal of $N(S)$ and $(a_1 + b_1I)^2 \in N(M)$. Since $N(S)(a_1 + b_1I)^2$ is a neutrosophic left ideal of $N(S)$ containing $(a_1 + b_1I)^2$, also $(a_1 + b_1I)^2 \in N(M)$, therefore we have $(a_1 + b_1I)^2 \in N(S)(a_1 + b_1I)^2 \subseteq N(M)$. But by using (2), we have

$$\begin{aligned} N(S)[a_1 + b_1I]^2 &= N(S)[(a_1 + b_1I)(a_1 + b_1I)] \\ &= [N(S)N(S)][(a_1 + b_1I)(a_1 + b_1I)] \\ &= [N(S)(a_1 + b_1I)][N(S)(a_1 + b_1I)] \\ &= [N(S)(a_1 + b_1I)]^2. \end{aligned}$$

Therefore, $[N(S)(a_1 + b_1I)]^2 \subseteq N(M)$, but $N(M)$ is neutrosophic semiprime ideal so $N(S)(a_1 + b_1I) \subseteq N(M)$. Since $(a_1 + b_1I) \in N(S)(a_1 + b_1I)$, therefore $(a_1 + b_1I) \in N(M)$.

Conversely, assume that $N(I)$ is an ideal of $N(S)$ and let $(N(I))^2 \subseteq N(M)$ and $(a_1 + b_1I) \in N(I)$ implies that $(a_1 + b_1I)^2 \in (N(I))^2$, which implies that $(a_1 + b_1I)^2 \in N(M)$ which further implies that $(a_1 + b_1I) \in N(M)$. Therefore, $(N(I))^2 \subseteq N(M)$ implies $N(I) \subseteq N(M)$. Hence $N(M)$ is a neutrosophic semiprime ideal.

A neutrosophic LA-semigroup $N(S)$ is called neutrosophic left (right) quasi-regular if every neutrosophic left (right) ideal of $N(S)$ is idempotent.

Theorem 2.3: A neutrosophic LA-semigroup $N(S)$ with left identity is neutrosophic left quasi-regular if and only if $a + bI \in [N(S)(a + bI)][N(S)(a + bI)]$.

Proof Let $N(L)$ be any left ideal of $N(S)$ and $a + bI \in [N(S)(a + bI)][N(S)(a + bI)]$. Now for each $l_1 + l_2I \in N(L)$, we have

$$\begin{aligned} l_1 + l_2I &\in [N(S)(l_1 + l_2I)][N(S)(l_1 + l_2I)] \\ &\subseteq [N(S)N(L)][N(S)N(L)] \\ &\subseteq N(L)N(L) = (N(L))^2. \end{aligned}$$

Therefore, $N(L) = (N(L))^2$.

Conversely, assume that $N(A) = (N(A))^2$ for every neutrosophic left ideal $N(A)$ of $N(S)$. Since $N(S)(a + bI)$ is a neutrosophic left ideal of $N(S)$. So, $a + bI \in N(S)(a + bI) = [N(S)(a + bI)][N(S)(a + bI)]$. Theorem 2.4: The subset $N(I)$ of a neutrosophic left quasi-regular LA-semigroup $N(S)$ is a neutrosophic left ideal of $N(S)$ if and only if it is a neutrosophic right ideal of $N(S)$.

Proof Let $N(L)$ be a neutrosophic left ideal of $N(S)$ and $s_1 + s_2I \in N(S)$ therefore, by Theorem 2.3 and (1), we have

$$\begin{aligned} &(l_1 + l_2I)(s_1 + s_2I) \\ &= [\{(x_1 + x_2I)(l_1 + l_2I)\}\{(y_1 + y_2I)(l_1 + l_2I)\}](s_1 + s_2I) \\ &= [\{(s_1 + s_2I)\{(y_1 + y_2I)(l_1 + l_2I)\}\}][\{(x_1 + x_2I)(l_1 + l_2I)\}] \\ &\in [\{N(S)\{N(S)N(L)\}\}][\{N(S)N(L)\}] \\ &= [N(S)N(L)][N(S)N(L)] \\ &\subseteq N(L)N(L) = N(L). \end{aligned}$$

Conversely, assume that $N(I)$ is a neutrosophic right ideal of $N(S)$, as $N(S)$ is itself a neutrosophic left ideal and by assumption $N(S)$ is idempotent, therefore by using (2), we have

$$\begin{aligned} N(S)N(I) &= [N(S)N(S)]N(I) \\ &= [N(I)N(S)]N(S) \\ &\subseteq N(I)N(S) \subseteq N(I). \end{aligned}$$

This implies $N(I)$ is neutrosophic left bideal too.

Lemma 2.9: The intersection of any number of neutrosophic quasi-ideals of $N(S)$ is either empty or quasi-ideal of $N(S)$.

Proof Let $N(Q_1)$ and $N(Q_2)$ be two neutrosophic quasi-ideals of neutrosophic LA-semigroup $N(S)$. If $N(Q_1)$ and $N(Q_2)$ are distinct then their intersection must be empty but if not then

$$\begin{aligned} &N(S)[N(Q_1) \cap N(Q_2)] \cap [N(Q_1) \cap N(Q_2)]N(S) \\ &= [N(S)N(Q_1) \cap N(S)N(Q_2)] \cap [N(Q_1)N(S) \cap N(Q_2)N(S)] \\ &= [N(S)N(Q_1) \cap N(Q_1)N(S)] \cap [N(S)N(Q_2) \cap N(Q_2)N(S)] \\ &\subseteq N(Q_1) \cap N(Q_2). \end{aligned}$$

Therefore, $N(Q_1) \cap N(Q_2)$ is a neutrosophic quasi-ideal.

Now, generalizing the result and let

$N(Q_1), N(Q_2), \dots, N(Q_n)$ be the n-number of neutrosophic quasi ideals of neutrosophic quasi-ideals of $N(S)$ and assume that their intersection is not empty then

$$\begin{aligned} & N(S)[N(Q_1) \cap N(Q_2) \cap \dots \cap N(Q_n)] \cap [N(Q_1) \cap N(Q_2) \cap \dots \cap N(Q_n)]N(S) \\ &= [N(S)N(Q_1) \cap N(S)N(Q_2) \cap \dots \cap N(S)N(Q_n)] \cap \\ & [N(Q_1)N(S) \cap N(Q_2)N(S) \cap \dots \cap N(Q_n)N(S)] \\ &= [N(S)N(Q_1) \cap N(Q_2)N(S)] \cap [N(S)N(Q_2) \cap \\ & N(Q_3)N(S)] \dots [N(S)N(Q_n) \cap N(Q_n)N(S)] \\ &\subseteq N(Q_1) \cap N(Q_2) \cap \dots \cap N(Q_n). \end{aligned}$$

Hence $N(Q_1) \cap N(Q_2) \cap \dots \cap N(Q_n)$ is a neutrosophic quasi-ideal. Therefore, the intersection of any number of neutrosophic quasi-ideals of $N(S)$ is either empty or quasi-ideal of $N(S)$.

3 Neutrosophic Regular LA-semigroups

An element $a + bI$ of a neutrosophic LA-semigroup $N(S)$ is called regular if there exists $x + yI \in N(S)$ such that $a + bI = [(a + bI)(x + yI)](a + bI)$, and $N(S)$ is called neutrosophic regular LA-semigroup if every element of $N(S)$ is regular.

Example Let $S = \{1, 2, 3\}$ with binary operation " \cdot " given in the following Callay's table, is a regular LA-semigroup with left identity 4

\cdot	1	2	3	4
1	3	4	1	2
2	2	1	4	3
3	4	3	2	1
4	1	2	3	4

then

$$N(S) = \{1 + 1I, 1 + 2I, 1 + 3I, 2 + 1I, 2 + 2I, 2 + 3I, 3 + 1I, 3 + 2I, 3 + 3I, 4 + 1I, 4 + 2I, 4 + 3I, 4 + 4I\}$$

is an example of neutrosophic regular LA-semigroup under the operation " $*$ " and has the following Callay's table:

$*$	1+1I	1+2I	1+3I	1+4I	2+1I	2+2I	2+3I	2+4I	3+1I	3+2I	3+3I	3+4I	4+1I	4+2I	4+3I	4+4I
1+1I	3+3I	3+4I	3+1I	3+2I	4+3I	4+4I	4+1I	4+2I	1+3I	1+4I	1+1I	1+2I	2+3I	2+4I	2+1I	2+2I
1+2I	3+2I	3+1I	3+4I	3+3I	4+2I	4+1I	4+4I	4+3I	1+2I	1+1I	1+4I	1+3I	2+2I	2+1I	2+4I	2+3I
1+3I	3+4I	3+3I	3+2I	3+1I	4+4I	4+3I	4+2I	4+1I	1+4I	1+3I	1+2I	1+1I	2+4I	2+3I	2+2I	2+1I
1+4I	3+1I	3+2I	3+3I	3+4I	4+1I	4+2I	4+3I	4+4I	1+1I	1+2I	1+3I	1+4I	2+1I	2+2I	2+3I	2+4I
2+1I	2+3I	2+4I	2+1I	2+2I	1+3I	1+4I	1+1I	1+2I	4+3I	4+4I	4+1I	4+2I	3+3I	3+4I	3+1I	3+2I
2+2I	2+2I	2+1I	2+4I	2+3I	1+2I	1+1I	1+4I	1+3I	4+2I	4+1I	4+4I	4+3I	3+2I	3+1I	3+4I	3+3I
2+3I	2+4I	2+3I	2+2I	2+1I	1+4I	1+3I	1+2I	1+1I	4+4I	4+3I	4+2I	4+1I	3+4I	3+3I	3+2I	3+1I
2+4I	2+1I	2+2I	2+3I	2+4I	1+1I	1+2I	1+3I	1+4I	4+1I	4+2I	4+3I	4+4I	3+1I	3+2I	3+3I	3+4I
3+1I	4+3I	4+4I	4+1I	4+2I	3+3I	3+4I	3+1I	3+2I	2+3I	2+4I	2+1I	2+2I	1+3I	1+4I	1+1I	1+2I
3+2I	4+2I	4+1I	4+4I	4+3I	3+2I	3+1I	3+4I	3+3I	2+2I	2+1I	2+4I	2+3I	1+2I	1+1I	1+4I	1+3I
3+3I	4+4I	4+3I	4+2I	4+1I	3+4I	3+3I	3+2I	3+1I	2+4I	2+3I	2+2I	2+1I	1+4I	1+3I	1+2I	1+1I
3+4I	4+1I	4+2I	4+3I	4+4I	3+1I	3+2I	3+3I	3+4I	2+1I	2+2I	2+3I	2+4I	1+1I	1+2I	1+3I	1+4I
4+1I	1+3I	1+4I	1+1I	1+2I	2+3I	2+4I	2+1I	2+2I	3+3I	3+4I	3+1I	3+2I	4+3I	4+4I	4+1I	4+2I
4+2I	1+2I	1+1I	1+4I	1+3I	2+2I	2+1I	2+4I	2+3I	3+2I	3+1I	3+4I	3+3I	4+2I	4+1I	4+4I	4+3I
4+3I	1+4I	1+3I	1+2I	1+1I	2+4I	2+3I	2+2I	2+1I	3+4I	3+3I	3+2I	3+1I	4+4I	4+3I	4+2I	4+1I
4+4I	1+1I	1+2I	1+3I	1+4I	2+1I	2+2I	2+3I	2+4I	3+1I	3+2I	3+3I	3+4I	4+1I	4+2I	4+3I	4+4I

Clearly $N(S)$ is a neutrosophic LA-semigroup also $[(1 + 1I)(4 + 4I)](2 + 3I) \neq (1 + 1I)[(4 + 4I)(2 + 3I)]$

, so $N(S)$ is non-associative and is regular because $(1 + 1I) = [(1 + 1I)(2 + 2I)](1 + 1I)$, $(2 + 2I) = [(2 + 2I)(3 + 3I)](2 + 2I)$, $(3 + 2I) = [(3 + 2I)(1 + 3I)](3 + 2I)$, $(4 + 1I) = [(4 + 1I)(4 + 2I)](4 + 1I)$, $(4 + 4I) = [(4 + 4I)(4 + 4I)](4 + 4I)$ etc.

Note that in a neutrosophic regular LA-semigroup, $[N(S)]^2 = N(S)$.

Lemma 3.1: If $N(A)$ is a neutrosophic bi-ideal (generalized bi-ideal) of a regular neutrosophic LA-semigroup $N(S)$ then $[N(A)N(S)]N(A) = N(A)$.

Proof Let $N(A)$ be a bi-ideal (generalized bi-ideal) of $N(S)$, then $[N(A)N(S)]N(A) \subseteq N(A)$.

Let $a + bI \in N(A)$, since $N(S)$ is neutrosophic regular LA-semigroup so there exists an element $x + yI \in N(S)$ such that

$$a + bI = [(a + bI)(x + yI)](a + bI), \text{ therefore, } a + bI = [(a + bI)(x + yI)](a + bI) \in [N(A)N(S)]N(A).$$

This implies that $N(A) \subseteq [N(A)N(S)]N(A)$. Hence

$$[N(A)N(S)]N(A) = N(A)$$

Lemma 3.2: If $N(A)$ and $N(B)$ are any neutrosophic ideals of a neutrosophic regular LA-semigroup $N(S)$, then $N(A) \cap N(B) = N(A)N(B)$.

Proof Assume that $N(A)$ and $N(B)$ are any neutrosophic ideals of $N(S)$ so $N(A)N(B) \subseteq N(A)N(S) \subseteq N(A)$ and $N(A)N(B) \subseteq N(S)N(B) \subseteq N(B)$. This implies that $N(A)N(B) \subseteq N(A) \cap N(B)$. Let $a + bI \in N(A) \cap N(B)$, then $a + bI \in N(A)$ and

$a + bI \in N(B)$. Since $N(S)$ is a neutrosophic regular AG-groupoid, so there exist $x + yI$ such that $a + bI = [(a + bI)(x + yI)](a + bI) \in [N(A)N(S)N(B) \subseteq N(A)N(B)$, which implies that $N(A) \cap N(B) \subseteq N(A)N(B)$. Hence $N(A)N(B) = N(A) \cap N(B)$.

Lemma 3.3: If $N(A)$ and $N(B)$ are any neutrosophic ideals of a neutrosophic regular LA-semigroup $N(S)$, then $N(A)N(B) = N(B)N(A)$.

Proof Let $N(A)$ and $N(B)$ be any neutrosophic ideals of a neutrosophic regular LA-semigroup $N(S)$. Now, let $a_1 + a_2I \in N(A)$ and $b_1 + b_2I \in N(B)$. Since, $N(A) \subseteq N(S)$ and $N(B) \subseteq N(S)$ and $N(S)$ is a neutrosophic regular LA-semigroup so there exist $x_1 + x_2I, y_1 + y_2I \in N(S)$ such that $a_1 + a_2I = [(a_1 + a_2I)(x_1 + x_2I)](a_1 + a_2I)$ and $b_1 + b_2I = [(b_1 + b_2I)(y_1 + y_2I)](b_1 + b_2I)$.

Now, let $(a_1 + a_2I)(b_1 + b_2I) \in N(A)N(B)$ but

$$\begin{aligned} & (a_1 + a_2I)(b_1 + b_2I) \\ &= [\{ (a_1 + a_2I)(x_1 + x_2I) \} (a_1 + a_2I)] \\ & \quad [\{ (b_1 + b_2I)(y_1 + y_2I) \} (b_1 + b_2I)] \\ & \in [\{ N(A)N(S) \} N(A)] [\{ N(B)N(S) \} N(B)] \\ & \subseteq [N(A)N(A)] [N(B)N(B)] \\ &= [N(B)N(B)] [N(A)N(A)] \\ & \subseteq N(B)N(A) \end{aligned}$$

$$N(A)N(B) \subseteq N(B)N(A).$$

Now, let $(b_1 + b_2I)(a_1 + a_2I) \in N(B)N(A)$ but

$$\begin{aligned} (b_1 + b_2I)(a_1 + a_2I) &= [\{ (b_1 + b_2I)(y_1 + y_2I) \} (b_1 + b_2I)] \\ & \quad [\{ (a_1 + a_2I)(x_1 + x_2I) \} (a_1 + a_2I)] \\ & \in [\{ N(B)N(S) \} N(B)] [\{ N(A)N(S) \} N(A)] \\ & \subseteq [N(B)N(B)] [N(A)N(A)] \\ &= [N(A)N(A)] [N(B)N(B)] \\ & \subseteq N(A)N(B). \end{aligned}$$

Since $N(B)N(A) \subseteq N(A)N(B)$. Hence $N(A)N(B) = N(B)N(A)$.

Lemma 3.4; Every neutrosophic bi-ideal of a regular neutrosophic LA-semigroup $N(S)$ with left identity

$e + eI$ is a neutrosophic quasi-ideal of $N(S)$.

Proof Let $N(B)$ be a bi-ideal of $N(S)$ and $(s_1 + s_2I)(b_1 + b_2I) \in N(S)N(B)$, for $s_1 + s_2I \in N(S)$ and $b_1 + b_2I \in N(B)$. Since $N(S)$ is a neutrosophic regular LA-semigroup, so there exists $x_1 + x_2I$

in $N(S)$ such that $b_1 + b_2I = [(b_1 + b_2I)(x_1 + x_2I)](b_1 + b_2I)$, then by using (4) and (1), we have

$$\begin{aligned} & (s_1 + s_2I)(b_1 + b_2I) \\ &= (s_1 + s_2I)[\{ (b_1 + b_2I)(x_1 + x_2I) \} (b_1 + b_2I)] \\ &= [\{ (b_1 + b_2I)(x_1 + x_2I) \}] [(s_1 + s_2I)(b_1 + b_2I)] \\ &= [\{ (s_1 + s_2I)(b_1 + b_2I) \} (x_1 + x_2I)] (b_1 + b_2I) \\ &= [(s_1 + s_2I) \{ \{ (b_1 + b_2I)(x_1 + x_2I) \} (b_1 + b_2I) \} (x_1 + x_2I)] (b_1 + b_2I) \\ &= [\{ \{ (b_1 + b_2I)(x_1 + x_2I) \} \{ (s_1 + s_2I)(b_1 + b_2I) \} \} (x_1 + x_2I)] (b_1 + b_2I) \\ &= [\{ (x_1 + x_2I) \{ (s_1 + s_2I)(b_1 + b_2I) \} \} \{ (b_1 + b_2I)(x_1 + x_2I) \}] (b_1 + b_2I) \\ &= [(b_1 + b_2I) \{ \{ (x_1 + x_2I) \{ (s_1 + s_2I)(b_1 + b_2I) \} \} \} (x_1 + x_2I)] (b_1 + b_2I) \\ & \in [N(B)N(S)] N(B) \\ & \subseteq N(B). \end{aligned}$$

Therefore,

$$N(B)N(S) \cap N(S)N(B) \subseteq N(S)N(B) \subseteq N(B).$$

Lemma 3.5. In a neutrosophic regular LA-semigroup $N(S)$, every neutrosophic ideal is idempotent.

Proof. Let $N(I)$ be any neutrosophic ideal of neutrosophic regular LA-semigroup $N(S)$. As we know, $(N(I))^2 \subseteq N(I)$ and let $a + bI \in N(I)$, since $N(S)$ is regular so there exists an element $x + yI \in N(S)$ such that

$$\begin{aligned} a + bI &= [(a + bI)(x + yI)] (a + bI) \\ & \in [N(I)N(S)] N(I) \\ & \subseteq N(I)N(I) = (N(I))^2. \end{aligned}$$

This implies $N(I) \subseteq (N(I))^2$. Hence, $(N(I))^2 = N(I)$.

As $N(I)$ is the arbitrary neutrosophic ideal of $N(S)$. So every ideal of neutrosophic regular AG-groupoid is idempotent.

Corollary 3.1. In a neutrosophic regular LA-semigroup $N(S)$, every neutrosophic right ideal is idempotent.

Proof. Let $N(R)$ be any neutrosophic right ideal of neutrosophic regular LA-semigroup $N(S)$ then $N(R)N(S) \subseteq N(R)$ and $(N(R))^2 \subseteq N(R)$. Now, let

$$a + bI \in N(R),$$

as $N(S)$ is regular implies for $a + bI \in N(R)$, there exists $x + yI \in N(S)$ such that

$$\begin{aligned} a + bI &= [(a + bI)(x + yI)](a + bI) \\ &\in [N(R)N(S)]N(I) \\ &\subseteq N(R)N(R) \\ &= (N(R))^2. \end{aligned}$$

Thus $(N(R))^2 = N(R)$. Hence, $(N(R))^2 = N(R)$. So every neutrosophic right ideal of neutrosophic regular LA-semigroup $N(S)$ is idempotent.

Corollary 3.2: In a neutrosophic regular LA-semigroup $N(S)$, every neutrosophic ideal is semiprime.

Proof: Let $N(P)$ be any neutrosophic ideal of neutrosophic regular LA-semigroup $N(S)$ and let $N(I)$ be any other neutrosophic ideal such that $[N(I)]^2 \subseteq N(P)$.

Now as every ideal of $N(S)$ is idempotent by lemma 3.5. So, $[N(I)]^2 = N(I)$ implies $N(I) \subseteq N(P)$. Hence, every neutrosophic ideal of $N(S)$ is semiprime.

4 Neutrosophic Intra-regular LA-semigroups

An LA-semigroup $N(S)$ is called neutrosophic intra-regular if for each element $a_1 + a_2I \in N(S)$ there exist elements $(x_1 + x_2I), (y_1 + y_2I) \in N(S)$ such that $a_1 + a_2I = [(x_1 + x_2I)(a_1 + a_2I)^2](y_1 + y_2I)$.

Example Let $S = \{1, 2, 3\}$ with binary operation " \cdot " given in the following Callay's table, is an intra-regular LA-semigroup with left identity 2.

\cdot	1	2	3
1	2	3	1
2	1	2	3
3	3	1	2

then

$$N(S) = \{1+1I, 1+2I, 1+3I, 2+1I, 2+2I, 2+3I, 3+1I, 3+2I, 3+3I\} [N(I)]^2.$$

is an example of neutrosophic intraregular LA-semigroup under the operation " \cdot " and has the following Callay's table:

*	1+1I	1+2I	1+3I	2+1I
---	------	------	------	------

*	1+1I	1+2I	1+3I	2+1I	2+2I	2+3I	3+1I	3+2I	3+3I
1+1I	2+2I	2+3I	2+1I	3+2I	3+3I	3+1I	1+2I	1+3I	1+1I
1+2I	2+1I	2+2I	2+3I	3+1I	3+2I	3+3I	1+1I	1+2I	1+3I
1+3I	2+3I	2+1I	2+2I	3+3I	3+1I	3+2I	1+3I	1+1I	1+2I
2+1I	1+2I	1+3I	1+1I	2+2I	2+3I	2+1I	3+2I	3+3I	3+1I
2+2I	1+1I	1+2I	1+3I	2+1I	2+2I	2+3I	3+1I	3+2I	3+3I
2+3I	1+3I	1+1I	1+2I	2+3I	2+1I	2+2I	3+3I	3+1I	3+2I
3+1I	3+2I	3+3I	3+1I	1+2I	1+3I	1+1I	2+2I	2+3I	2+1I
3+2I	3+1I	3+2I	3+3I	1+1I	1+2I	1+3I	2+1I	2+2I	2+3I
3+3I	3+3I	3+1I	3+2I	1+3I	1+1I	1+2I	2+3I	2+1I	2+2I

Clearly $N(S)$ is a neutrosophic LA-semigroup and is non-associative because

$$[(1+1I) * (2+2I)] * (2+3I) \neq (1+1I) * [(2+2I) * (2+3I)]$$

and $N(S)$ is intra-regular as

$$\begin{aligned} (1+1I) &= [(1+3I)(1+1I)^2](2+3I) \\ (2+3I) &= [(1+1I)(2+3I)^2](3+1I) \\ (3+1I) &= [(2+3I)(3+1I)^2](3+3I) \text{ etc.} \end{aligned}$$

Note that if $N(S)$ is a neutrosophic intra-regular LA-semigroup then $[N(S)]^2 = N(S)$.

Lemma 4.1: In a neutrosophic intra-regular LA-semigroup $N(S)$ with left identity $e + eI$, every neutrosophic ideal is idempotent.

Proof Let $N(I)$ be any neutrosophic ideal of a neutrosophic intraregular LA-semigroup $N(S)$ implies $[N(I)]^2 \subseteq N(I)$. Now, let $a_1 + a_2I \in N(I)$ and since $N(I) \subseteq N(S)$ implies $a_1 + a_2I \in N(S)$. Since $N(S)$ is a neutrosophic intra-regular LA-semigroup, so there exist $(x_1 + x_2I), (y_1 + y_2I) \in N(S)$ such that

$$\begin{aligned} (a_1 + a_2I) &= [(x_1 + x_2I)(a_1 + a_2I)^2](y_1 + y_2I) \\ &\in [N(S)(N(I))^2]N(S) \\ &= [N(S)(N(I)N(I))]N(S) \\ &= (N(I)(N(S)N(I)))N(S) \\ &\subseteq (N(I)N(I))N(S) \\ &= (N(S)N(I))N(I) \\ &\subseteq N(I)N(I) \end{aligned}$$

Hence $[N(I)]^2 = N(I)$. As, $N(I)$ is arbitrary so every neutrosophic ideal of is idempotent in a neutrosophic intra-regular LA-semigroup $N(S)$ with left identity.

Lemma 4.2: In a neutrosophic intra-regular LA-semigroup $N(S)$ with left identity $e + eI$,

$N(I)N(J) = N(I) \cap N(J)$, for every neutrosophic ideals $N(I)$ and $N(J)$ in $N(S)$.

Proof: Let $N(I)$ and $N(J)$ be any neutrosophic ideals of $N(S)$, then obviously $N(I)N(J) \subseteq N(I)N(S)$ and $N(I)N(J) \subseteq N(S)N(J)$ implies $N(I)N(J) \subseteq N(I) \cap N(J)$. Since $N(I) \cap N(J) \subseteq N(I)$ and $N(I) \cap N(J) \subseteq N(J)$, then $[N(I) \cap N(J)]^2 \subseteq N(I)N(J)$. Also $N(I) \cap N(J)$ is a neutrosophic ideal of $N(S)$, so using Lemma 4.1, we have $N(I) \cap N(J) = [N(I) \cap N(J)]^2 \subseteq N(I)N(J)$. Hence $N(I)N(J) = N(I) \cap N(J)$.

Theorem 4.1. For neutrosophic intra-regular AG-groupoid with left identity $e + eI$, the following statements are equivalent.

- (i) $N(A)$ is a neutrosophic left ideal of $N(S)$.
- (ii) $N(A)$ is a neutrosophic right ideal of $N(S)$.
- (iii) $N(A)$ is a neutrosophic ideal of $N(S)$.
- (iv) $N(A)$ is a neutrosophic bi-ideal of $N(S)$.
- (v) $N(A)$ is a neutrosophic generalized bi-ideal of $N(S)$.
- (vi) $N(A)$ is a neutrosophic interior ideal of $N(S)$.
- (vii) $N(A)$ is a neutrosophic quasi-ideal of $N(S)$.
- (viii) $N(A)N(S) = N(A)$ and $N(S)N(A) = N(A)$.

Proof: (i) \Rightarrow (viii)

Let $N(A)$ be a neutrosophic left ideal of $N(S)$. By Lemma first, $N(S)N(A) = N(A)$. Now let $(a_1 + a_2I) \in N(A)$ and $(s_1 + s_2I) \in N(S)$, since $N(S)$ is a neutrosophic intra-regular LA-semigroup, so there exist $(x_1 + x_2I), (y_1 + y_2I) \in N(S)$ such that $(a_1 + a_2I) = [(x_1 + x_2I)(a_1 + a_2I)^2](y_1 + y_2I)$, therefore by (1), we have

$$\begin{aligned} (a_1 + a_2I)(s_1 + s_2I) &= [(x_1 + x_2I)(a_1 + a_2I)^2](y_1 + y_2I)(s_1 + s_2I) \\ &= [(x_1 + x_2I)\{(a_1 + a_2I)(a_1 + a_2I)\}](y_1 + y_2I)(s_1 + s_2I) \\ &\in \{[N(S)\{N(A)N(A)\}]N(S)\}N(S) \\ &\subseteq \{[N(S)\{N(S)N(A)\}]N(S)\}N(S) \\ &\subseteq \{[N(S)N(A)]N(S)\}N(S) \\ &= [N(S)N(S)][N(S)N(A)] \\ &= N(S)[N(S)N(A)] \subseteq N(S)N(A) = N(A). \end{aligned}$$

which implies that $N(A)$ is a neutrosophic right ideal of

$N(S)$, again by Lemma first, $N(A)N(S) = N(A)$.

(viii) \Rightarrow (vii)

Let $N(A)N(S) = N(A)$ and $N(S)N(A) = N(A)$ then $N(A)N(S) \cap N(S)N(A) = N(A)$, which clearly implies that $N(A)$ is a neutrosophic quasi-ideal of $N(S)$.

(vii) \Rightarrow (vi)

Let $N(A)$ be a quasi-ideal of $N(S)$. Now let $[(s_1 + s_2I)(a_1 + a_2I)](s_1 + s_2I) \in [N(S)N(A)]N(S)$, since $N(S)$ is neutrosophic intra-regular LA-semigroup so there exist $(x_1 + x_2I), (y_1 + y_2I), (p_1 + p_2I), (q_1 + q_2I) \in N(S)$ such that $(s_1 + s_2I) = [(x_1 + x_2I)(s_1 + s_2I)^2](y_1 + y_2I)$ and $(a_1 + a_2I) = [(p_1 + p_2I)(a_1 + a_2I)^2](q_1 + q_2I)$. Therefore using (2), (4), (3) and (1), we have

$$\begin{aligned} &[(s_1 + s_2I)(a_1 + a_2I)](s_1 + s_2I) \\ &= [(s_1 + s_2I)(a_1 + a_2I)][\{(x_1 + x_2I)(s_1 + s_2I)^2\}(y_1 + y_2I)] \\ &= [\{(s_1 + s_2I)\{(x_1 + x_2I)(s_1 + s_2I)^2\}\}][\{(a_1 + a_2I)(y_1 + y_2I)\}] \\ &= (a_1 + a_2I)[\{(s_1 + s_2I)\{(x_1 + x_2I)(s_1 + s_2I)^2\}\}(y_1 + y_2I)] \\ &\in N(A)N(S). \end{aligned}$$

and

$$\begin{aligned} &[(s_1 + s_2I)(a_1 + a_2I)](s_1 + s_2I) \\ &= [(s_1 + s_2I)\{(p_1 + p_2I)(a_1 + a_2I)^2\}(q_1 + q_2I)](s_1 + s_2I) \\ &= [(p_1 + p_2I)(a_1 + a_2I)^2]\{(s_1 + s_2I)(q_1 + q_2I)\}(s_1 + s_2I) \\ &= [(p_1 + p_2I)\{(a_1 + a_2I)(a_1 + a_2I)\}]\{(s_1 + s_2I)(q_1 + q_2I)\}(s_1 + s_2I) \\ &= [(a_1 + a_2I)\{(p_1 + p_2I)(a_1 + a_2I)\}]\{(s_1 + s_2I)(q_1 + q_2I)\}(s_1 + s_2I) \\ &= [(q_1 + q_2I)(s_1 + s_2I)]\{(p_1 + p_2I)(a_1 + a_2I)\}(a_1 + a_2I)(s_1 + s_2I) \\ &= [(p_1 + p_2I)(a_1 + a_2I)]\{(q_1 + q_2I)(s_1 + s_2I)\}(a_1 + a_2I)(s_1 + s_2I) \\ &= [(a_1 + a_2I)\{(q_1 + q_2I)(s_1 + s_2I)\}]\{(a_1 + a_2I)(p_1 + p_2I)\}(s_1 + s_2I) \\ &= [(a_1 + a_2I)\{(a_1 + a_2I)\{(q_1 + q_2I)(s_1 + s_2I)\}\}(p_1 + p_2I)](s_1 + s_2I) \\ &= [(s_1 + s_2I)\{(a_1 + a_2I)\{(q_1 + q_2I)(s_1 + s_2I)\}\}(p_1 + p_2I)](a_1 + a_2I) \\ &\in N(S)N(A) \subseteq N(A). \end{aligned}$$

which shows that $N(A)$ is a neutrosophic interior ideal of $N(S)$.

(vi) \Rightarrow (v)

Let $N(A)$ be a neutrosophic interior ideal of a neutrosophic intraregular LA-semigroup $N(S)$

and

$$[(a_1 + a_2I)(s_1 + s_2I)](a_1 + a_2I) \in [N(A)N(S)]N(A)$$

. Now using (4) and (1), we get

$$\begin{aligned} & [(a_1 + a_2I)(s_1 + s_2I)](a_1 + a_2I) \\ &= [(a_1 + a_2I)(s_1 + s_2I)][(x_1 + x_2I)(a_1 + a_2I)^2](y_1 + y_2I) \\ &= [(x_1 + x_2I)(a_1 + a_2I)^2][(a_1 + a_2I)(s_1 + s_2I)](y_1 + y_2I) \\ &= [(x_1 + x_2I)\{(a_1 + a_2I)(a_1 + a_2I)\}][(a_1 + a_2I)(s_1 + s_2I)](y_1 + y_2I) \\ &= [\{(a_1 + a_2I)(s_1 + s_2I)\}(y_1 + y_2I)\}\{(a_1 + a_2I)(a_1 + a_2I)\}](x_1 + x_2I) \\ &= [(a_1 + a_2I)\{\{(a_1 + a_2I)(s_1 + s_2I)\}(y_1 + y_2I)\}(a_1 + a_2I)\}](x_1 + x_2I) \\ &= [(a_1 + a_2I)\{\{(a_1 + a_2I)(y_1 + y_2I)\}(a_1 + a_2I)(s_1 + s_2I)\}\}](x_1 + x_2I) \\ &= [\{(a_1 + a_2I)(y_1 + y_2I)\}\{(a_1 + a_2I)\{(a_1 + a_2I)(s_1 + s_2I)\}\}\}](x_1 + x_2I) \\ &= [\{\{(a_1 + a_2I)\{(a_1 + a_2I)(s_1 + s_2I)\}\}(y_1 + y_2I)\}(a_1 + a_2I)\}](x_1 + x_2I) \\ &\in [N(S)N(A)]N(S) \subseteq N(A). \end{aligned}$$

(v) ⇒ (iv)

Let $N(A)$ be a neutrosophic generalized bi-ideal of $N(S)$. Let $a_1 + a_2I \in N(A)$, and since $N(S)$ is neutrosophic intra-regular LA-semigroup so there exist $(x_1 + x_2I)$, $(y_1 + y_2I)$ in $N(S)$ such that $a_1 + a_2I = [(x_1 + x_2I)(a_1 + a_2I)^2](y_1 + y_2I)$, then using (3) and (4), we have

$$\begin{aligned} & (a_1 + a_2I)(a_1 + a_2I) \\ &= [\{(x_1 + x_2I)(a_1 + a_2I)^2\}(y_1 + y_2I)](a_1 + a_2I) \\ &= [\{(x_1 + x_2I)(a_1 + a_2I)^2\}\{(e_1 + e_2I)(y_1 + y_2I)\}](a_1 + a_2I) \\ &= [\{(y_1 + y_2I)(e_1 + e_2I)\}\{(a_1 + a_2I)^2(x_1 + x_2I)\}](a_1 + a_2I) \\ &= [(a_1 + a_2I)^2\{\{(y_1 + y_2I)(e_1 + e_2I)\}(x_1 + x_2I)\}](a_1 + a_2I) \\ &= [\{(a_1 + a_2I)(a_1 + a_2I)\}\{\{(y_1 + y_2I)(e_1 + e_2I)\}(x_1 + x_2I)\}](a_1 + a_2I) \\ &= [\{(x_1 + x_2I)\{(y_1 + y_2I)(e_1 + e_2I)\}\}\{(a_1 + a_2I)(a_1 + a_2I)\}](a_1 + a_2I) \\ &= [(a_1 + a_2I)\{\{(x_1 + x_2I)\{(y_1 + y_2I)(e_1 + e_2I)\}\}(a_1 + a_2I)\}](a_1 + a_2I) \\ &\in [N(A)N(S)]N(A) \subseteq N(A). \end{aligned}$$

Hence $N(A)$ is a neutrosophic bi-ideal of $N(S)$.

(iv) ⇒ (iii)

Let $N(A)$ be any neutrosophic bi-ideal of $N(S)$ and let $(a_1 + a_2I)(s_1 + s_2I) \in N(A)N(S)$. Since $N(S)$ is neutrosophic intra-regular LA-semigroup, so there exist $(x_1 + x_2I)$, $(y_1 + y_2I) \in N(S)$ such that $(a_1 + a_2I) = [(x_1 + x_2I)(a_1 + a_2I)^2](y_1 + y_2I)$.

Therefore, using (1), (3), (4) and (2), we have

$$\begin{aligned} & (a_1 + a_2I)(s_1 + s_2I) \\ &= [\{(x_1 + x_2I)(a_1 + a_2I)^2\}(y_1 + y_2I)](s_1 + s_2I) \\ &= [(s_1 + s_2I)(y_1 + y_2I)][(x_1 + x_2I)(a_1 + a_2I)^2] \\ &= [(a_1 + a_2I)^2(x_1 + x_2I)][(y_1 + y_2I)(s_1 + s_2I)] \\ &= [\{\{(y_1 + y_2I)(s_1 + s_2I)\}(x_1 + x_2I)\}(a_1 + a_2I)^2] \\ &= [\{(y_1 + y_2I)(s_1 + s_2I)\}(x_1 + x_2I)][(a_1 + a_2I)(a_1 + a_2I)] \\ &= [(a_1 + a_2I)(a_1 + a_2I)][(x_1 + x_2I)\{(y_1 + y_2I)(s_1 + s_2I)\}] \\ &= [\{(x_1 + x_2I)\{(y_1 + y_2I)(s_1 + s_2I)\}\}(a_1 + a_2I)](a_1 + a_2I) \\ &= \{(x_1 + x_2I)\{(y_1 + y_2I)(s_1 + s_2I)\}\} \\ &\quad \{\{(x_1 + x_2I)(a_1 + a_2I)^2\}(y_1 + y_2I)\}(a_1 + a_2I) \\ &= [\{(x_1 + x_2I)(a_1 + a_2I)^2\}\{\{(x_1 + x_2I)\{(y_1 + y_2I)(s_1 + s_2I)\}\}\} \\ &\quad (y_1 + y_2I)](a_1 + a_2I) \\ &= [\{(y_1 + y_2I)\{(x_1 + x_2I)\{(y_1 + y_2I)(s_1 + s_2I)\}\}\} \\ &\quad \{(a_1 + a_2I)^2(x_1 + x_2I)\}](a_1 + a_2I) \\ &= [(a_1 + a_2I)^2\{\{(y_1 + y_2I)\{(x_1 + x_2I)\{(y_1 + y_2I)(s_1 + s_2I)\}\}\} \\ &\quad (x_1 + x_2I)\}](a_1 + a_2I) \\ &= [\{(a_1 + a_2I)(a_1 + a_2I)\}\{\{(y_1 + y_2I)\{(x_1 + x_2I) \\ &\quad \{(y_1 + y_2I)(s_1 + s_2I)\}\}\}\}(x_1 + x_2I)](a_1 + a_2I) \\ &= [\{(x_1 + x_2I)\{(y_1 + y_2I)\{(x_1 + x_2I)\{(y_1 + y_2I)(s_1 + s_2I)\}\}\}\} \\ &\quad \{(a_1 + a_2I)(a_1 + a_2I)\}](a_1 + a_2I) \\ &\in [N(A)N(S)]N(A) \subseteq N(A). \end{aligned}$$

$$\begin{aligned} & (s_1 + s_2I)(a_1 + a_2I) \\ &= (s_1 + s_2I)[\{(x_1 + x_2I)(a_1 + a_2I)^2\}(y_1 + y_2I)] \\ &= [(x_1 + x_2I)(a_1 + a_2I)^2][(s_1 + s_2I)(y_1 + y_2I)] \\ &= [(x_1 + x_2I)\{(a_1 + a_2I)(a_1 + a_2I)\}][(s_1 + s_2I)(y_1 + y_2I)] \\ &= [(a_1 + a_2I)\{(x_1 + x_2I)(a_1 + a_2I)\}][(s_1 + s_2I)(y_1 + y_2I)] \\ &= [\{(s_1 + s_2I)(y_1 + y_2I)\}\{(x_1 + x_2I)(a_1 + a_2I)\}](a_1 + a_2I) \\ &= [\{(a_1 + a_2I)(x_1 + x_2I)\}\{(y_1 + y_2I)(s_1 + s_2I)\}](a_1 + a_2I) \\ &= [\{\{(y_1 + y_2I)(s_1 + s_2I)\}(x_1 + x_2I)\}(a_1 + a_2I)](a_1 + a_2I) \\ &= [\{\{(y_1 + y_2I)(s_1 + s_2I)\}(x_1 + x_2I)\} \\ &\quad \{\{(x_1 + x_2I)(a_1 + a_2I)^2\}(y_1 + y_2I)\}](a_1 + a_2I) \\ &= [\{\{(y_1 + y_2I)(s_1 + s_2I)\}\{(x_1 + x_2I)(a_1 + a_2I)^2\}\} \\ &\quad \{(x_1 + x_2I)(y_1 + y_2I)\}](a_1 + a_2I) \\ &= [\{\{(a_1 + a_2I)^2(x_1 + x_2I)\}\{(s_1 + s_2I)(y_1 + y_2I)\}\} \\ &\quad \{(x_1 + x_2I)(y_1 + y_2I)\}](a_1 + a_2I) \\ &= [\{\{(a_1 + a_2I)(a_1 + a_2I)\}(x_1 + x_2I)\}\{(s_1 + s_2I)(y_1 + y_2I)\}\} \\ &\quad \{(x_1 + x_2I)(y_1 + y_2I)\}](a_1 + a_2I) \end{aligned}$$

$$\begin{aligned}
 &= [\{ \{ (x_1 + x_2I)(y_1 + y_2I) \} \{ (s_1 + s_2I)(y_1 + y_2I) \} \\
 &\quad \{ \{ (a_1 + a_2I)(a_1 + a_2I) \} (x_1 + x_2I) \} \} (a_1 + a_2I) \\
 &= [(a_1 + a_2I) \{ \{ \{ (s_1 + s_2I)(y_1 + y_2I) \} (x_1 + x_2I) \} \\
 &\quad \{ (y_1 + y_2I)(x_1 + x_2I) \} \} (a_1 + a_2I) \} (a_1 + a_2I) \\
 &\in [N(A)N(S)]N(A) \\
 &\subseteq N(A).
 \end{aligned}$$

Therefore, $N(A)$ is a neutrosophic ideal of $N(S)$.

(iii) \Rightarrow (ii) and (ii) \Rightarrow (i) are obvious.

Lemma 4.4. A neutrosophic LA-semigroup $N(S)$ with left identity $(e + eI)$ is intra-regular if and only if every neutrosophic bi-ideal of $N(S)$ is idempotent.

Proof. Assume that $N(S)$ is a neutrosophic intra-regular LA-semigroup with left identity $(e + eI)$ and $N(B)$ is a neutrosophic bi-ideal of $N(S)$. Let $(b + bI) \in N(B)$, and since $N(S)$ is intra-regular so there exist $(c_1 + c_2I)$, $(d_1 + d_2I)$ in $N(S)$ such that $(b_1 + b_2I) = [(c_1 + c_2I)(b_1 + b_2I)^2](d_1 + d_2I)$, then by using (3), (4) and (1), we have

$$\begin{aligned}
 &(b_1 + b_2I) \\
 &= [(c_1 + c_2I)(b_1 + b_2I)^2](d_1 + d_2I) \\
 &= [\{ (c_1 + c_2I)(b_1 + b_2I)^2 \} \{ (e + eI)(d_1 + d_2I) \}] \\
 &= [\{ (d_1 + d_2I)(e + eI) \} \{ (b_1 + b_2I)^2(c_1 + c_2I) \}] \\
 &= [(b_1 + b_2I)^2 \{ \{ (d_1 + d_2I)(e + eI) \} (c_1 + c_2I) \}] \\
 &= [\{ (b_1 + b_2I)(b_1 + b_2I) \} \{ \{ (d_1 + d_2I)(e + eI) \} (c_1 + c_2I) \}] \\
 &= [\{ \{ (d_1 + d_2I)(e + eI) \} (c_1 + c_2I) \} (b_1 + b_2I) \} (b_1 + b_2I) \\
 &= [\{ \{ (d_1 + d_2I)(e + eI) \} (c_1 + c_2I) \} \\
 &\quad \{ \{ (c_1 + c_2I)(b_1 + b_2I)^2 \} (d_1 + d_2I) \} \} (b_1 + b_2I) \\
 &= [\{ \{ (c_1 + c_2I)(b_1 + b_2I)^2 \} \{ \{ (d_1 + d_2I)(e + eI) \} (c_1 + c_2I) \} \\
 &\quad (d_1 + d_2I) \} \} (b_1 + b_2I) \\
 &= [\{ (c_1 + c_2I) \{ (b_1 + b_2I)(b_1 + b_2I) \} \} \{ \{ (d_1 + d_2I)(e + eI) \} \\
 &\quad (c_1 + c_2I) \} (d_1 + d_2I) \} (b_1 + b_2I) \\
 &= [\{ (b_1 + b_2I) \{ (c_1 + c_2I)(b_1 + b_2I) \} \} \{ \{ (d_1 + d_2I)(e + eI) \} \\
 &\quad (c_1 + c_2I) \} (d_1 + d_2I) \} (b_1 + b_2I) \\
 &= [\{ \{ \{ (d_1 + d_2I)(e + eI) \} (c_1 + c_2I) \} (d_1 + d_2I) \} \\
 &\quad \{ (c_1 + c_2I)(b_1 + b_2I) \} (b_1 + b_2I) \} (b_1 + b_2I)
 \end{aligned}$$

$$\begin{aligned}
 &= [\{ \{ \{ (d_1 + d_2I)(e + eI) \} (c_1 + c_2I) \} (d_1 + d_2I) \} \\
 &\quad \{ \{ (c_1 + c_2I) \{ (c_1 + c_2I)(b_1 + b_2I)^2 \} \\
 &\quad (d_1 + d_2I) \} \} (b_1 + b_2I) \} (b_1 + b_2I) \\
 &= [\{ \{ \{ (d_1 + d_2I)(e + eI) \} (c_1 + c_2I) \} (d_1 + d_2I) \} \{ (c_1 + c_2I) \\
 &\quad \{ (c_1 + c_2I) \{ (b_1 + b_2I)(b_1 + b_2I) \} \} (d_1 + d_2I) \} \} \\
 &\quad (b_1 + b_2I) \} (b_1 + b_2I) \\
 &= [\{ \{ \{ (d_1 + d_2I)(e + eI) \} (c_1 + c_2I) \} (d_1 + d_2I) \} \{ (c_1 + c_2I) \{ (b_1 + b_2I) \\
 &\quad \{ (c_1 + c_2I)(b_1 + b_2I) \} \} (d_1 + d_2I) \} \} (b_1 + b_2I) \} (b_1 + b_2I) \\
 &= [\{ \{ \{ (d_1 + d_2I)(e + eI) \} (c_1 + c_2I) \} (d_1 + d_2I) \} \{ (b_1 + b_2I) \\
 &\quad \{ (c_1 + c_2I) \{ (c_1 + c_2I)(b_1 + b_2I) \} \} (d_1 + d_2I) \} \} (b_1 + b_2I) \} (b_1 + b_2I) \\
 &= [(b_1 + b_2I) \{ \{ \{ (d_1 + d_2I)(e + eI) \} (c_1 + c_2I) \} (d_1 + d_2I) \} \\
 &\quad \{ \{ (c_1 + c_2I) \{ (c_1 + c_2I)(b_1 + b_2I) \} \} (d_1 + d_2I) \} \} (b_1 + b_2I) \} (b_1 + b_2I) \\
 &\in [\{ N(B)N(S) \} N(B)] N(B) \subseteq N(B)N(B).
 \end{aligned}$$

Hence $[N(B)]^2 = N(B)$.

Conversely, since $N(S)(a + bI)$ is a neutrosophic bi-ideal of $N(S)$, and by assumption $N(S)(a + bI)$ is idempotent, so by using (2), we have

Hence $N(S)$ is neutrosophic intra-regular LA-semigroup. Theorem 4.2. In a neutrosophic LA-semigroup $N(S)$ with left identity $e + eI$, the following statements are equivalent.

- (i) $N(S)$ is intra-regular.
- (ii) Every neutrosophic two sided ideal of $N(S)$ is semiprime.
- (iii) Every neutrosophic right ideal of $N(S)$ is semiprime.
- (iv) Every neutrosophic left ideal of $N(S)$ is semiprime.

Proof: (i) \Rightarrow (iv)

Let $N(S)$ is intra-regular, then by Theorem equalient and Lemma 4.1, every neutrosophic left ideal of $N(S)$ is semiprime.

(iv) \Rightarrow (iii)

Let $N(R)$ be a neutrosophic right ideal and $N(I)$ be any neutrosophic ideal of $N(S)$ such that $[N(I)]^2 \subseteq N(R)$. Then clearly $[N(I)]^2 \subseteq N(R) \cup N(S)N(R)$. Now by Lemma 2.7, $N(R) \cup N(S)N(R)$ is a neutrosophic two-sided ideal of $N(S)$, so is neutrosophic left. Then by (iv) we have $N(I) \subseteq N(R) \cup N(S)N(R)$. Now using (1) we have

$$\begin{aligned} N(S)N(R) &= [N(S)N(S)]N(R) \\ &= [N(R)N(S)]N(S) \\ &\subseteq N(R)N(S) \subseteq N(R). \end{aligned}$$

This implies that $N(I) \subseteq N(R) \cup N(S)N(R) \subseteq N(R)$. Hence $N(R)$ is semiprime.

It is clear that $(iii) \Rightarrow (ii)$.

Now $(ii) \Rightarrow (i)$

Since $(a + bI)^2 N(S)$ is a neutrosophic right ideal of $N(S)$ containing $(a + bI)^2$ and clearly it is a neutrosophic two sided ideal so by assumption (ii) , it is semiprime, therefore by Theorem 2.2, $(a + bI) \in (a + bI)^2 N(S)$. Thus using (4) and (3), we have

$$\begin{aligned} a + bI &\in (a + bI)^2 N(S) \\ &= (a + bI)^2 [N(S)N(S)] \\ &= N(S)[(a + bI)^2 N(S)] \\ &= [N(S)N(S)][(a + bI)^2 N(S)] \\ &= [N(S)(a + bI)^2][N(S)N(S)] \\ &= [N(S)(a + bI)^2]N(S). \end{aligned}$$

Hence $N(S)$ is intra-regular.

Theorem 4.3. An LA-semigroup $N(S)$ with left identity $e + eI$ is intra-regular if and only if every neutrosophic left ideal of $N(S)$ is idempotent.

Proof. Let $N(S)$ be a neutrosophic intra-regular LA-semigroup then by Theorem equalient and Lemma 4.1, every neutrosophic ideal of $N(S)$ is idempotent.

Conversely, assume that every neutrosophic left ideal of $N(S)$ is idempotent. Since $N(S)(a + bI)$ is a neutrosophic left ideal of $N(S)$, so by using (2), we have

$$\begin{aligned} a + bI &\in N(S)(a + bI) \\ &= [N(S)(a + bI)][N(S)(a + bI)] \\ &= [\{N(S)(a + bI)\}\{N(S)(a + bI)\}]\{N(S)(a + bI)\} \\ &= [\{N(S)N(S)\}\{(a + bI)(a + bI)\}]\{N(S)(a + bI)\} \\ &\subseteq [N(S)(a + bI)^2][N(S)N(S)] \\ &= [N(S)(a + bI)^2]N(S). \end{aligned}$$

Theorem 4.4. A neutrosophic LA-semigroup $N(S)$ with left identity $e + eI$ is intra-regular if and only if

$N(R) \cap N(L) \subseteq N(R)N(L)$, for every neutrosophic semiprime right ideal $N(R)$ and every neutrosophic left ideal $N(L)$ of $N(S)$.

Proof. Let $N(S)$ be an intra-regular LA-semigroup, so by Theorem equalient $N(R)$ and $N(L)$ become neutrosophic ideals of $N(S)$, therefore by Lemma 4.2, $N(R) \cap N(L) \subseteq N(L)N(R)$, for every neutrosophic ideal $N(R)$ and $N(L)$ and by Theorem every ideal semiprime, $N(R)$ is semiprime.

Conversely, assume that $N(R) \cap N(L) \subseteq N(R)N(L)$ for every neutrosophic right ideal $N(R)$, which is semiprime and every neutrosophic left ideal $N(L)$ of $N(S)$. Since $(a + bI)^2 \in (a + bI)^2 N(S)$, which is a neutrosophic right ideal of $N(S)$ so is semiprime which implies that $(a + bI) \in (a + bI)^2 N(S)$. Now clearly $N(S)(a + bI)$ is a neutrosophic left ideal of $N(S)$ and $(a + bI) \in N(S)(a + bI)$. Therefore, using (3), we have

$$\begin{aligned} a + bI &\in [(a + bI)^2 N(S)] \cap [N(S)(a + bI)] \\ &\subseteq [(a + bI)^2 N(S)][N(S)(a + bI)] \\ &\subseteq [(a + bI)^2 N(S)][N(S)N(S)] \\ &= [(a + bI)^2 N(S)]N(S) \\ &= [\{(a + bI)(a + bI)\}N(S)]N(S) \\ &= [\{(a + bI)(a + bI)\}\{N(S)N(S)\}]N(S) \\ &= [\{N(S)N(S)\}\{(a + bI)(a + bI)\}]N(S) \\ &= [N(S)\{(a + bI)(a + bI)\}]N(S) \\ &= [N(S)(a + bI)^2]N(S). \end{aligned}$$

Therefore, $N(S)$ is a neutrosophic intra-regular LA-semigroup.

Theorem 4.5. For a neutrosophic LA-semigroup $N(S)$ with left identity $e + eI$, the following statements are equivalent.

- (i) $N(S)$ is intra-regular.
- (ii) $N(L) \cap N(R) \subseteq N(L)N(R)$, for every right ideal $N(R)$, which is neutrosophic semiprime and every neutrosophic left ideal $N(L)$ of $N(S)$.
- (iii) $N(L) \cap N(R) \subseteq [N(L)N(R)]N(L)$, for every neutrosophic semiprime right ideal $N(R)$ and every neutrosophic left ideal $N(L)$.

Proof (i) \Rightarrow (iii)

Let $N(S)$ be intra-regular and $N(L), N(R)$ be any neutrosophic left and right ideals of $N(S)$ and let $a_1 + a_2I \in N(L) \cap N(R)$, which implies that $a_1 + a_2I \in N(L)$ and $a_1 + a_2I \in N(R)$. Since $N(S)$ is intra-regular so there exist $(x_1 + x_2I), (y_1 + y_2I)$ in $N(S)$ such that

$a_1 + a_2I = [(x_1 + x_2I)(a_1 + a_2I)^2](y_1 + y_2I)$, then by using (4), (1) and (3), we have

$$\begin{aligned} a_1 + a_2I &= [(x_1 + x_2I)(a_1 + a_2I)^2](y_1 + y_2I) \\ &= [(x_1 + x_2I)\{(a_1 + a_2I)(a_1 + a_2I)\}](y_1 + y_2I) \\ &= [(a_1 + a_2I)\{(x_1 + x_2I)(a_1 + a_2I)\}](y_1 + y_2I) \\ &= [(y_1 + y_2I)\{(x_1 + x_2I)(a_1 + a_2I)\}](a_1 + a_2I) \\ &= [(y_1 + y_2I)\{(x_1 + x_2I)\{(x_1 + x_2I)(a_1 + a_2I)^2\} \\ &\quad (y_1 + y_2I)\}](a_1 + a_2I) \\ &= [(y_1 + y_2I)\{(x_1 + x_2I)(a_1 + a_2I)^2\}\{(x_1 + x_2I)(y_1 + y_2I)\}](a_1 + a_2I) \\ &= [\{(x_1 + x_2I)(a_1 + a_2I)^2\}(y_1 + y_2I) \\ &\quad \{(x_1 + x_2I)(y_1 + y_2I)\}](a_1 + a_2I) \\ &= [\{(x_1 + x_2I)\{(a_1 + a_2I)(a_1 + a_2I)\}\}(y_1 + y_2I) \\ &\quad \{(x_1 + x_2I)(y_1 + y_2I)\}](a_1 + a_2I) \\ &= [\{(a_1 + a_2I)\{(x_1 + x_2I)(a_1 + a_2I)\}\}(y_1 + y_2I) \\ &\quad \{(x_1 + x_2I)(y_1 + y_2I)\}](a_1 + a_2I) \\ &\in [\{N(R)\{N(S)N(L)\}\}N(S)]N(L) \\ &\subseteq [\{N(R)N(L)\}N(S)]N(L) \\ &= [N(L)N(S)][N(R)N(L)] \\ &= [N(L)N(R)][N(S)N(L)] \\ &\subseteq [N(L)N(R)]N(L), \end{aligned}$$

which implies that $N(L) \cap N(R) \subseteq [N(L)N(R)]N(L)$. Also by Theorem every ideal semiprime, $N(L)$ is semiprime.

(iii) \Rightarrow (ii)

Let $N(R)$ and $N(L)$ be neutrosophic left and right ideals of $N(S)$ and $N(R)$ is semiprime, then by assumption (iii) and by (3), (4) and (1), we have

$$\begin{aligned} N(R) \cap N(L) &\subseteq [N(R)N(L)]N(R) \\ &\subseteq [N(R)N(L)]N(S) \\ &= [N(R)N(L)][N(S)N(S)] \\ &= [N(S)N(S)][N(L)N(R)] \\ &= N(L)\{[N(S)N(S)]N(R)\} \\ &= N(L)\{[N(R)N(S)]N(S)\} \\ &\subseteq N(L)[N(R)N(S)] \\ &\subseteq N(L)N(R). \end{aligned}$$

(ii) \Rightarrow (i)

Since $e + eI \in N(S)$ implies $a + bI \in N(S)(a + bI)$, which is a neutrosophic left ideal of $N(S)$, and $(a + bI)^2 \in (a + bI)^2 N(S)$, which is a semiprime neutrosophic right ideal of $N(S)$, therefore by Theorem 2.2 $a + bI \in (a + bI)^2 N(S)$. Now using (3) we have

$$\begin{aligned} a + bI &\in [N(S)(a + bI)] \cap [(a + bI)^2 N(S)] \\ &\subseteq [N(S)(a + bI)][(a + bI)^2 N(S)] \\ &\subseteq [N(S)N(S)][(a + bI)^2 N(S)] \\ &= [N(S)(a + bI)^2][N(S)N(S)] \\ &= [N(S)(a + bI)^2]N(S). \end{aligned}$$

Hence $N(S)$ is intra-regular

A neutrosophic LA-semigroup $N(S)$ is called totally ordered under inclusion if $N(P)$ and $N(Q)$ are any neutrosophic ideals of $N(S)$ such that either $N(P) \subseteq N(Q)$ or $N(Q) \subseteq N(P)$.

A neutrosophic ideal $N(P)$ of a neutrosophic LA-semigroup $N(S)$ is called strongly irreducible if $N(A) \cap N(B) \subseteq N(P)$ implies either $N(A) \subseteq N(P)$ or $N(B) \subseteq N(P)$, for all neutrosophic ideals $N(A), N(B)$ and $N(P)$ of $N(S)$.

Lemma 4.4. Every neutrosophic ideal of a neutrosophic intra-regular LA-semigroup $N(S)$ is prime if and only if it is strongly irreducible.

Proof. Assume that every ideal of $N(S)$ is neutrosophic prime. Let $N(A)$ and $N(B)$ be any neutrosophic ideals of $N(S)$ so by Lemma 4.2, $N(A)N(B) = N(A) \cap N(B)$, where $N(A) \cap N(B)$ is neutrosophic ideal of $N(S)$. Now, let $N(A) \cap N(B) \subseteq N(P)$ where $N(P)$ is a neutrosophic ideal of $N(S)$ too. But by assumption every neutrosophic ideal of a neutrosophic intra-regular LA-semigroup $N(S)$ is prime so is neutrosophic prime, therefore, $N(A)N(B) = N(A) \cap N(B) \subseteq N(P)$ implies $N(A) \subseteq N(P)$ or $N(B) \subseteq N(P)$. Hence $N(S)$ is strongly irreducible.

Conversely, assume that $N(S)$ is strongly irreducible. Let

$N(A)$, $N(B)$ and $N(P)$ be any neutrosophic ideals of $N(S)$ such that $N(A) \cap N(B) \subseteq N(P)$ implies $N(A) \subseteq N(P)$ or $N(B) \subseteq N(P)$. Now, let $N(A) \cap N(B) \subseteq N(P)$ but $N(A)N(B) = N(A) \cap N(B)$ by lemma ij, $N(A)N(B) \subseteq N(P)$ implies $N(A) \subseteq N(P)$ or $N(B) \subseteq N(P)$. Since $N(P)$ is arbitrary neutrosophic ideal of $N(S)$ so very neutrosophic ideal of a neutrosophic intra-regular LA-semigroup $N(S)$ is prime. Theorem 4.6. Every neutrosophic ideal of a neutrosophic intra-regular LA-semigroup $N(S)$ is neutrosophic prime if and only if $N(S)$ is totally ordered under inclusion.

Proof. Assume that every ideal of $N(S)$ is neutrosophic prime. Let $N(P)$ and $N(Q)$ be any neutrosophic ideals of $N(S)$, so by Lemma 4.2, $N(P)N(Q) = N(P) \cap N(Q)$, where $N(P) \cap N(Q)$ is neutrosophic ideal of $N(S)$, so is neutrosophic prime, therefore, $N(P)N(Q) \subseteq N(P) \cap N(Q)$, which implies that $N(P) \subseteq N(P) \cap N(Q)$ or $N(Q) \subseteq N(P) \cap N(Q)$, which implies that $N(P) \subseteq N(Q)$ or $N(Q) \subseteq N(P)$. Hence $N(S)$ is totally ordered under inclusion.

Conversely, assume that $N(S)$ is totally ordered under inclusion. Let $N(I)$, $N(J)$ and $N(P)$ be any neutrosophic ideals of $N(S)$ such that $N(I)N(J) \subseteq N(P)$. Now without loss of generality assume that $N(I) \subseteq N(J)$ then

$$N(I) = [N(I)]^2 = N(I)N(I) \subseteq N(I)N(J) \subseteq N(P).$$

Therefore, either $N(I) \subseteq N(P)$ or $N(J) \subseteq N(P)$, which implies that $N(P)$ is neutrosophic prime.

Theorem 4.7. The set of all neutrosophic ideals $N(I)_s$ of a neutrosophic intra-regular $N(S)$ with left identity $e + eI$ forms a semilattice structure.

Proof. Let $N(A)$, $N(B) \in N(I)_s$, since $N(A)$ and $N(B)$ are neutrosophic ideals of $N(S)$ so we have

$$[N(A)N(B)]N(S) = [N(A)N(B)][N(S)N(S)] = [N(A)N(S)][N(B)N(S)] \subseteq N(A)N(B).$$

$$\text{Also } N(S)[N(A)N(B)] = [N(S)N(S)][N(A)N(B)] = [N(S)N(A)][N(S)N(B)] \subseteq N(A)N(B).$$

Thus $N(A)N(B)$ is a neutrosophic ideal of $N(S)$. Hence $N(I)_s$ is closed. Also using Lemma ij, we have, $N(A)N(B) = N(A) \cap N(B) = N(B) \cap N(A) = N(B)N(A)$ which implies that $N(I)_s$ is commutative, so is associative. Now by using Lemma ii, $[N(A)]^2 = N(A)$, for all $N(A) \in N(I)_s$. Hence $N(I)_s$ is semilattice.

References

- [1] M. Ali, and F. Smarandache, A New Type of Group Action through the Applications of Fuzzy Sets and Neutrosophic Sets, International Journal of Mathematical Combinatorics, Vol. 04, no. 04, (2015), 33-40.
- [2] M. Ali, F. Smarandache, M. Naz, and M. Shabir, Neutrosophic Code, Critical Review, A Publication of Society for Mathematics of Uncertainty, Vol. IX, (2015), 44-54.
- [3] M. Ali, M. Shabir, M. Naz, and F. Smarandache, Neutrosophic Left Almost Semigroup, Neutrosophic Sets and Systems, Vol. 03, (2014), 18-28.
- [4] M. Ali, F. Smarandache, M. Naz, and M. Shabir, G-Neutrosophic Space, Critical Review, A Publication of Society for Mathematics of Uncertainty, Vol. VIII, (2014), 37-49.
- [5] M. Ali, F. Smarandache, M. Shabir and M. Naz, Neutrosophic Bi-LA-Semigroup and Neutrosophic N-LA-Semigroup, Neutrosophic Sets and Systems, Vol. 04, (2014), 19-24.
- [6] M. Ali, F. Smarandache, and M. Shabir, New Research on Neutrosophic Algebraic Structures, EuropaNova ASBL. 3E clos du Pannasse, Brussels 1000, Belgium.
- [7] A. H. Clifford and G. B. Preston, *The algebraic theory of semigroups*, John Wiley & Sons, (vol. 1)1961.
- [8] P. Holgate, Groupoids satisfying a simple invertive law, The Math. Stud., 1 – 4, 61(1992), 101 – 106.
- [9] J. Ježek and T. Kepka, A note on medial division groupoids, Proc. Amer. Math. Soc., 2, 119(1993), 423 – 426.
- [10] M. A. Kazim and M. Naseeruddin, On almost semigroups, The Alig. Bull. Math.,

- 2(1972), 1 – 7.
- [11] S. Milić, V. Pavlović, Semigroups in which some ideal is completely simple semigroup, Publ. Inst. Math., 30,44(1981), 123 – 130 .
- [12] Madad Khan, Some studies in AG^* -groupoids, Ph. D., thesis, Quaid-i-Azam University, Islamabad, Paksitan, 2008.
- [13] Madad Khan, F. Smarandache and Saima Anis, Theory of Abel Grassmann's groupoids, The Educationa Publiusher, Inc., Ohio, USA, 2015.
- [14] Q. Mushtaq and S. M. Yousuf, On LA-semigroups, The Alig. Bull. Math., 8(1978), 65 – 70.
- [15] Q. Mushtaq and S. M. Yousuf, On LA-semigroup defined by a commutative inverse semigroup, Math. Bech., 40(1988) , 59 – 62 .
- [16] Q. Mushtaq and M. Khan, Ideals in left almost semigroups, Proceedings of 4th International Pure Mathematics Conference 2003, 65 – 77.
- [17] Q. Mushtaq and M. Khan, Semilattice decomposition of locally associative AG^{**} -groupoids, Algeb. Colloq., 16, 1(2009), 17 – 22 .
- [18] N. Naseeruddin, Some studies in almost semigroups and flocks, Ph.D., thesis, Aligarh Muslim University, Aligarh, India, 1970 .
- [19] P. V. Protić and N. Stevanović, AG -test and some general properties of Abel-Grassmann's groupoids, PU. M. A., 4. , 6 (1995) , 371 – 383 .
- [20] P. V. Protić and M. Božinovic, Some congruences on an AG^{**} -groupoid, Algebra Logic and Discrete Mathematics, Ni, 3,9(1995), 879 – 886 .
- [21] Florentin Smarandache, Neutrosophy. Neutrosophic Probability, Set, and Logic, Amer. Res. Press, Rehoboth, USA, 105 p., 1998 (4th edition)
- [22] O. Steinfield, *Quasi-ideals in ring and semigroups*, Akademiaikiado, Budapest, 1978 .
- [23] N. Stevanović and P. V. Protić, Composition of Abel-Grassmann's 3-bands, Novi Sad, J. Math., 2 , 34(2004) .

Received: Feb. 10, 2016. Accepted: Mar. 20, 2016



Degree of Dependence and Independence of the (Sub)Components of Fuzzy Set and Neutrosophic Set

Florentin Smarandache¹

¹University of New Mexico, Mathematics & Science Department, 705 Gurley Ave., Gallup, NM 87301, USA, E-mail: smarand@unm.edu

Abstract. We have introduced for the first time the *degree of dependence* (and consequently the *degree of independence*) between the components of the fuzzy set, and also between the components of the neutrosophic set

in our 2006 book's fifth edition [1]. Now we extend it for the first time to the refined neutrosophic set considering the *degree of dependence or independence of subcomponents*.

Keywords: neutrosophy, neutrosophic set, fuzzy set, degree of dependence of (sub)components, degree of independence of (sub)components.

1 Refined Neutrosophic Set.

We start with the most general definition, that of a *n-valued refined neutrosophic set A*. An element *x* from *A* belongs to the set in the following way:

$$x(T_1, T_2, \dots, T_p; I_1, I_2, \dots, I_r; F_1, F_2, \dots, F_s) \in A, \quad (1)$$

where $p, r, s \geq 1$ are integers, and $p + r + s = n \geq 3$, where

$$T_1, T_2, \dots, T_p; I_1, I_2, \dots, I_r; F_1, F_2, \dots, F_s \quad (2)$$

are respectively sub-membership degrees, sub-indeterminacy degrees, and sub-nonmembership degrees of element *x* with respect to the *n-valued refined neutrosophic set A*.

Therefore, one has *n* (sub)components.

Let's consider all of them being crisp numbers in the interval $[0, 1]$.

2 General case.

Now, in general, let's consider *n* crisp-components (variables):

$$y_1, y_2, \dots, y_n \in [0, 1]. \quad (3)$$

If all of them are 100% independent two by two, then their sum:

$$0 \leq y_1 + y_2 + \dots + y_n \leq n. \quad (4)$$

But if all of them are 100% dependent (totally interconnected), then

$$0 \leq y_1 + y_2 + \dots + y_n \leq 1. \quad (5)$$

When some of them are partially dependent and partially independent, then

$$y_1 + y_2 + \dots + y_n \in (1, n). \quad (6)$$

For example, if y_1 and y_2 are 100% dependent, then

$$0 \leq y_1 + y_2 \leq 1, \quad (7)$$

while other variables y_3, \dots, y_n are 100% independent of each other and also with respect to y_1 and y_2 , then

$$0 \leq y_3 + \dots + y_n \leq n - 2, \quad (8)$$

thus

$$0 \leq y_1 + y_2 + y_3 + \dots + y_n \leq n - 1. \quad (9)$$

3 Fuzzy Set.

Let *T* and *F* be the membership and respectively the nonmembership of an element $x(T, F)$ with respect to a fuzzy set *A*, where *T, F* are crisp numbers in $[0, 1]$.

If *T* and *F* are 100% dependent of each other, then one has as in classical fuzzy set theory

$$0 \leq T + F \leq 1. \quad (10)$$

But if *T* and *F* are 100% independent of each other (that we define now for the first time in the domain of fuzzy set and logic), then

$$0 \leq T + F \leq 2. \quad (11)$$

We consider that the sum $T + F = 1$ if the information about the components is complete, and $T + F < 1$ if the information about the components is incomplete.

Similarly, $T + F = 2$ for complete information, and $T + F < 2$ for incomplete information.

For complete information on *T* and *F*, one has $T + F \in [1, 2]$.

4 Degree of Dependence and Degree of Independence for two Components.

In general (see [1], 2006, pp. 91-92), the sum of two components x and y that vary in the unitary interval $[0, 1]$ is:

$$0 \leq x + y \leq 2 - d^\circ(x, y), \quad (12)$$

where $d^\circ(x, y)$ is the *degree of dependence* between x and y .

Therefore $2 - d^\circ(x, y)$ is the *degree of independence* between x and y .

Of course, $d^\circ(x, y) \in [0, 1]$, and it is zero when x and y are 100% independent, and 1 when x and y are 100% dependent.

In general, if T and F are $d\%$ dependent [and consequently $(100 - d)\%$ independent], then

$$0 \leq T + F \leq 2 - d/100. \quad (13)$$

5 Example of Fuzzy Set with Partially Dependent and Partially Independent Components.

As an example, if T and F are 75% (= 0.75) dependent, then

$$0 \leq T + F \leq 2 - 0.75 = 1.25. \quad (14)$$

6 Neutrosophic Set

Neutrosophic set is a general framework for unification of many existing sets, such as fuzzy set (especially intuitionistic fuzzy set), paraconsistent set, intuitionistic set, etc. The main idea of NS is to characterize each value statement in a 3D-Neutrosophic Space, where each dimension of the space represents respectively the membership/truth (T), the nonmembership/falsehood (F), and the indeterminacy with respect to membership/nonmembership (I) of the statement under consideration, where T, I, F are standard or non-standard real subsets of $]0, 1^+[$ with not necessarily any connection between them.

For software engineering proposals the classical unit interval $[0, 1]$ is used.

For single valued neutrosophic set, the sum of the components ($T+I+F$) is (see [1], p. 91):

$$0 \leq T+I+F \leq 3, \quad (15)$$

when all three components are independent;

$$0 \leq T+I+F \leq 2, \quad (16)$$

when two components are dependent, while the third one is independent from them;

$$0 \leq T+I+F \leq 1, \quad (17)$$

when all three components are dependent.

When three or two of the components T, I, F are independent, one leaves room for incomplete information ($\text{sum} < 1$), paraconsistent and contradictory

information ($\text{sum} > 1$), or complete information ($\text{sum} = 1$).

If all three components T, I, F are dependent, then similarly one leaves room for incomplete information ($\text{sum} < 1$), or complete information ($\text{sum} = 1$).

The dependent components are tied together.

Three sources that provide information on $T, I,$ and F respectively are independent if they do not communicate with each other and do not influence each other.

Therefore, $\max\{T+I+F\}$ is in between 1 (when the degree of independence is zero) and 3 (when the degree of independence is 1).

7 Examples of Neutrosophic Set with Partially Dependent and Partially Independent Components.

The $\max\{T+I+F\}$ may also get any value in $(1, 3)$.

a) For example, suppose that T and F are 30% dependent and 70% independent (hence $T + F \leq 2 - 0.3 = 1.7$), while I and F are 60% dependent and 40% independent (hence $I + F \leq 2 - 0.6 = 1.4$). Then $\max\{T + I + F\} = 2.4$ and occurs for $T = 1, I = 0.7, F = 0.7$.

b) Second example: suppose T and I are 100% dependent, but I and F are 100% independent. Therefore $T + I \leq 1$ and $I + F \leq 2$, then $T + I + F \leq 2$.

8 More on Refined Neutrosophic Set

The Refined Neutrosophic Set [4], introduced for the first time in 2013. In this set the neutrosophic component (T) is split into the subcomponents (T_1, T_2, \dots, T_p) which represent types of truths (or sub-truths), the neutrosophic component (I) is split into the subcomponents (I_1, I_2, \dots, I_r) which represents types of indeterminacies (or sub-indeterminacies), and the neutrosophic components (F) is split into the subcomponents (F_1, F_2, \dots, F_s) which represent types of falsehoods (or sub-falsehoods), such that p, r, s are integers ≥ 1 and $p + r + s = n \geq 4$. (18)

When $n = 3$, one gets the non-refined neutrosophic set. All $T_j, I_k,$ and F_l subcomponents are subsets of $[0, 1]$.

Let's consider the case of refined single-valued neutrosophic set, i.e. when all n subcomponents are crisp numbers in $[0, 1]$.

Let the sum of all subcomponents be:

$$S = \sum_1^p T_j + \sum_1^r I_k + \sum_1^s F_l \quad (19)$$

When all subcomponents are independent two by two, then

$$0 \leq S \leq n. \quad (20)$$

If m subcomponents are 100% dependent, $2 \leq m \leq n$, no matter if they are among T_j, I_k, F_l or mixed, then

$$0 \leq S \leq n - m + 1 \quad (21)$$

and one has $S = n - m + 1$ when the information is complete, while $S < n - m + 1$ when the information is incomplete.

9 Examples of Refined Neutrosophic Set with Partially Dependent and Partially Independent Components.

Suppose T is split into T_1, T_2, T_3 , and I is not split, while F is split into F_1, F_2 . Hence one has:

$$\{T_1, T_2, T_3; I; F_1, F_2\}. \quad (22)$$

Therefore a total of 6 (sub)components.

a) If all 6 components are 100% independent two by two, then:

$$0 \leq T_1 + T_2 + T_3 + I + F_1 + F_2 \leq 6 \quad (23)$$

b) Suppose the subcomponents T_1, T_2 , and F_1 are 100% dependent all together, while the others are totally independent two by two and independent from T_1, T_2, F_1 , therefore:

$$0 \leq T_1 + T_2 + F_1 \leq 1 \quad (24)$$

whence

$$0 \leq T_1 + T_2 + T_3 + I + F_1 + F_2 \leq 6 - 3 + 1 = 4. \quad (25)$$

One gets equality to 4 when the information is complete, or strictly less than 4 when the information is incomplete.

c) Suppose in another case that T_1 and I are 20% dependent, or $d^\circ(T_1, I) = 20\%$, while the others similarly totally independent two by two and independent from T_1 and I , hence

$$0 \leq T_1 + I \leq 2 - 0.2 = 1.8 \quad (26)$$

whence

$$0 \leq T_1 + T_2 + T_3 + I + F_1 + F_2 \leq 1.8 + 4 = 5.8, \quad (27)$$

$$\text{since } 0 \leq T_2 + T_3 + F_1 + F_2 \leq 4. \quad (28)$$

Similarly, to the right one has equality for complete information, and strict inequality for incomplete information.

Conclusion.

We have introduced for the first time the degree of dependence/independence between the components of fuzzy set and neutrosophic set. We have given easy examples about the range of the sum of components, and how to represent the degrees of dependence and independence of the components. Then we extended it to the refined neutrosophic set considering the degree of dependence or independence of subcomponents.

References.

- [1] Florentin Smarandache, *Neutrosophy. Neutrosophic Probability, Set, and Logic*, ProQuest Information & Learning, Ann Arbor, Michigan, USA, 105 p., 1998, 2000, 2003, 2005, 2006; <http://fs.gallup.unm.edu/eBook-neutrosophics5.pdf> (fifth edition).
- [2] Florentin Smarandache, *Degree of Dependence and Independence of Neutrosophic Logic Components Applied in Physics*, 2016 Annual Spring Meeting of the American Physical Society (APS) Ohio-Region Section, Dayton, Ohio, USA, 08-09 April 08 2016.
- [3] Vasile Pătrașcu, *Penta and Hexa Valued Representation of Neutrosophic Information*, Technical Report TI.1.3.2016 10 March 2016, DOI: 10.13140/RG.2.1.2667.1762.
- [4] Florentin Smarandache, *Refined Literal Indeterminacy and the Multiplication Law of Sub-Indeterminacies*, *Neutrosophic Sets and Systems*, 58-63, Vol. 9, 2015.
- [5] Florentin Smarandache, *n-Valued Refined Neutrosophic Logic and Its Applications in Physics*, *Progress in Physics*, 143-146, Vol. 4, 2013. <http://fs.gallup.unm.edu/n-valuedNeutrosophicLogic-PiP.pdf>

Received: January 15, 2016. Accepted: March 25, 2016



NEUTROSOPHIC SOFT MULTI-ATTRIBUTE DECISION MAKING BASED ON GREY RELATIONAL PROJECTION METHOD

Partha Pratim Dey¹, Surapati Pramanik², and Bibhas C. Giri³

¹Department of Mathematics, Jadavpur University, Kolkata-700032, West Bengal, India. E-mail: parsur.fuzz@gmail.com

²Department of Mathematics, Nandalal Ghosh B.T. College, Panpur, P.O.-Narayanpur, District –North 24 Parganas, Pin code-743126, West Bengal, India. E-mail: sura_pati@yahoo.co.in

³Department of Mathematics, Jadavpur University, Kolkata-700032, West Bengal, India. E-mail: bcgiri.jumath@gmail.com

Abstract. The present paper proposes neutrosophic soft multi-attribute decision making based on grey relational projection method. Neutrosophic soft sets is a combination of neutrosophic sets and soft sets and it is a new mathematical apparatus to deal with realistic problems in the fields of medical sciences, economics, engineering, etc. The rating of alternatives with respect to choice parameters is represented in terms of neutrosophic soft sets.

The weights of the choice parameters are completely unknown to the decision maker and information entropy method is used to determine unknown weights. Then, grey relational projection method is applied in order to obtain the ranking order of all alternatives. Finally, an illustrative numerical example is solved to demonstrate the practicality and effectiveness of the proposed approach.

Keywords: Neutrosophic sets; Neutrosophic soft sets; Grey relational projection method; Multi-attribute decision making.

1 Introduction

In real life, we often encounter many multi-attribute decision making (MADM) problems that cannot be described in terms of crisp numbers due to indeterminacy and inconsistency of the problems. Zadeh [1] incorporated the degree of membership and proposed the notion of fuzzy set to handle uncertainty. Atanassov [2] introduced the degree of non-membership and defined intuitionistic fuzzy set to deal with imprecise or uncertain decision information. Smarandache [3, 4, 5, 6] initiated the idea of neutrosophic sets (NSs) by using the degree of indeterminacy as independent component to deal with problems involving imprecise, indeterminate and inconsistent information which usually exist in real situations. In NSs, indeterminacy is quantified and the truth-membership, indeterminacy-membership, falsity-membership functions are independent and they assume the value from $]^{-0}, 1^{+}[$. However, from scientific and realistic point of view Wang et al. [7] proposed single valued NSs (SVNSs) and then presented the set theoretic operators and various properties of SVNSs.

Molodtsov [8] introduced the soft set theory for dealing with uncertain, fuzzy, not clearly described objects in 1999. Maji et al. [9] applied the soft set theory for solving decision making problem. Maji et al. [10] also

defined the operations AND, OR, union, intersection of two soft sets and also proved several propositions on soft set operations. However, Ali et al. [11] and Yang [12] pointed out that some assertions of Maji et al. [10] are not true in general, by counterexamples. The soft set theory have received a great deal of attention from the researchers and many researchers have combined soft sets with other sets to make different hybrid structures like fuzzy soft sets [13], intuitionistic fuzzy soft sets [14], vague soft sets [15] generalized fuzzy soft sets [16], generalized intuitionistic fuzzy soft [17], possibility vague soft set [18], etc. The different hybrid systems have had quite impact on solving different practical decision making problems such as medical diagnosis [16, 18], plot selection, object recognition [19], etc where data set are imprecise and uncertain. Maji et al. [13, 14] incorporated fuzzy soft sets and intuitionistic soft sets based on the nature of the parameters involved in the soft sets. Çağman et al. [20] redefined fuzzy soft sets and their properties and then developed fuzzy soft aggregation operator for decision problems. Recently, Maji [21] introduced the concept of neutrosophic soft sets (NSSs) which is a combination of neutrosophic sets [3, 4, 5, 6] and soft sets [8], where the parameters are neutrosophic sets. He also introduced several definitions and operations on NSSs and presented an application of NSSs in house selection problem. Maji

[22] further studied weighted NSSs by imposing some weights on the parameters. Based on the concept of weighted NSSs, Maji [23] solved a multi-criteria decision making problem.

MADM problem generally comprises of selecting the most suitable alternative from a set of alternatives with respect to their attributes and it has received much attention to the researchers in the field of decision science, management, economics, investment [24, 25], school choice [26], etc. Grey relational analysis (GRA) [27] is an effective tool for modeling MADM problems with complicated interrelationships between numerous factors and variables. GRA is applied in a range of MADM problems such as agriculture, economics, hiring distribution [28], marketing, power distribution systems [29], personal selection, teacher selection [30], etc. Biswas et al. [24] investigated entropy based GRA method for solving MADM problems under single valued neutrosophic assessments. Biswas et al. [25] also studied GRA based single valued neutrosophic MADM problems with incomplete weight information. Mondal and Pramanik [26] presented a methodological approach to select the best elementary school for children using neutrosophic MADM with interval weight information based on GRA. Mondal and Pramanik [31] also developed rough neutrosophic MADM based on modified GRA.

Zhang et al. [32] developed a new grey relational projection (GRP) method for solving MADM problems in which the attribute value takes the form of intuitionistic trapezoidal fuzzy number, and the attribute weights are unknown. In this paper, we have extended the concept of Zhang et al. [32] to develop a methodology for solving neutrosophic soft MADM problems based on grey relational projection method with unknown weight information.

Rest of the paper is organized as follows. Section 2 presents some definitions concerning NS, SVNS, soft sets, and neutrosophic soft sets. A neutrosophic soft MADM based on GRP method is discussed in Section 3. In Section 4, we have solved a numerical example in order to demonstrate the proposed procedure. Finally, Section 5 concludes the paper.

2 Preliminaries

In this section we briefly present some basic definitions regarding NSs, SVNSs, soft sets, and NSSs.

2.1 Neutrosophic set

Definition 1 [3, 4, 5, 6] Consider X be a universal space of objects (points) with generic element in X denoted by x . Then a NS is defined as follows:

$$A = \{x, \langle T_A(x), I_A(x), F_A(x) \rangle \mid x \in X\}.$$

where, $T_A(x), I_A(x), F_A(x) : X \rightarrow]0, 1^+[$ are the truth-membership, indeterminacy-membership, and falsity-membership functions, respectively and $0 \leq \sup T_A(x) + \sup I_A(x) + \sup F_A(x) \leq 3^+$. We consider the NS which assumes the value from the subset of $[0, 1]$ because $]0, 1^+[$ will be hard to apply in real world science and engineering problems.

Definition 2 [7] Let X be a universal space of points with generic element in X represented by x . Then a SVNS $\tilde{N} \subset X$ is characterized by a truth-membership function $T_{\tilde{N}}(x)$, an indeterminacy-membership function $I_{\tilde{N}}(x)$, and a falsity-membership function $F_{\tilde{N}}(x)$ with $T_{\tilde{N}}(x), I_{\tilde{N}}(x), F_{\tilde{N}}(x) : X \rightarrow [0, 1]$ for each point $x \in X$ and we have, $0 \leq \sup T_{\tilde{N}}(x) + \sup I_{\tilde{N}}(x) + \sup F_{\tilde{N}}(x) \leq 3$.

Definition 3 [7] The complement of a SVNS \tilde{N} is represented by \tilde{N}^c and is defined by

$$T_{\tilde{N}^c}(x) = F_{\tilde{N}}(x); I_{\tilde{N}^c}(x) = 1 - I_{\tilde{N}}(x); F_{\tilde{N}^c}(x) = T_{\tilde{N}}(x)$$

Definition 4 [7] For two SVNSs \tilde{N}_A and \tilde{N}_B

$$\tilde{N}_A = \{x, \langle T_{\tilde{N}_A}(x), I_{\tilde{N}_A}(x), F_{\tilde{N}_A}(x) \rangle \mid x \in X\}$$

and

$$\tilde{N}_B = \{x, \langle T_{\tilde{N}_B}(x), I_{\tilde{N}_B}(x), F_{\tilde{N}_B}(x) \rangle \mid x \in X\}$$

1. $\tilde{N}_A \subseteq \tilde{N}_B$ if and only if

$$T_{\tilde{N}_A}(x) \leq T_{\tilde{N}_B}(x); I_{\tilde{N}_A}(x) \geq I_{\tilde{N}_B}(x); F_{\tilde{N}_A}(x) \geq F_{\tilde{N}_B}(x)$$

2. $\tilde{N}_A = \tilde{N}_B$ if and only if

$$T_{\tilde{N}_A}(x) = T_{\tilde{N}_B}(x); I_{\tilde{N}_A}(x) = I_{\tilde{N}_B}(x); F_{\tilde{N}_A}(x) = F_{\tilde{N}_B}(x); \forall x \in X.$$

3. $\tilde{N}_A \cup \tilde{N}_B$

$$= \left\langle x, \max\{T_{\tilde{N}_A}(x), T_{\tilde{N}_B}(x)\}, \min\{I_{\tilde{N}_A}(x), I_{\tilde{N}_B}(x)\}, \min\{F_{\tilde{N}_A}(x), F_{\tilde{N}_B}(x)\} \mid x \in X \right\rangle$$

4. $\tilde{N}_A \cap \tilde{N}_B$

$$= \left\langle x, \min\{T_{\tilde{N}_A}(x), T_{\tilde{N}_B}(x)\}, \max\{I_{\tilde{N}_A}(x), I_{\tilde{N}_B}(x)\}, \max\{F_{\tilde{N}_A}(x), F_{\tilde{N}_B}(x)\} \mid x \in X \right\rangle$$

Definition 5 [7] The Hamming distance between $\tilde{N}_A = \{x_i, \langle T_{\tilde{N}_A}(x_i), I_{\tilde{N}_A}(x_i), F_{\tilde{N}_A}(x_i) \rangle \mid x_i \in X\}$ and $\tilde{N}_B = \{x_i, \langle T_{\tilde{N}_B}(x_i), I_{\tilde{N}_B}(x_i), F_{\tilde{N}_B}(x_i) \rangle \mid x_i \in X\}$ is defined as given below.

$$H(\tilde{N}_A, \tilde{N}_B) = \frac{1}{3} \sum_{i=1}^n |T_{\tilde{N}_A}(x_i) - T_{\tilde{N}_B}(x_i)| + |I_{\tilde{N}_A}(x_i) - I_{\tilde{N}_B}(x_i)| + |F_{\tilde{N}_A}(x_i) - F_{\tilde{N}_B}(x_i)| \tag{1}$$

with the property: $0 \leq H(\tilde{N}_A, \tilde{N}_B) \leq 1$.

2.2 Soft sets and Neutrosophic soft sets

Definition 6 [8] Suppose U is a universal set, F is a set of parameters and P(U) is a power set of U. Consider a non-empty set A, where $A \subset F$. A pair (M, A) is called a soft set over U, where M is a mapping given by $M: A \rightarrow P(U)$.

Definition 7 [21] Let U be an initial universal set. Let F be a set of parameters and A be a non-empty set such that $A \subset F$. P(U) represents the set of all neutrosophic subsets of U. A pair (M, A) is called a NSS over U, where M is a mapping given by $M: A \rightarrow P(U)$.

In other words, (M, A) over U is a parameterized family f of all neutrosophic sets over U.

Example: Let U be the universal set of objects or points. $F = \{\text{very large, large, medium large, medium low, low, very low, attractive, cheap, expensive}\}$ is the set of parameters and each parameter is a neutrosophic word or sentence concerning neutrosophic word. To define neutrosophic soft set means to find out very large objects, large objects, medium large objects, attractive objects, and so on. Let $U = (u_1, u_2, u_3, u_4, u_5, u_6)$ be the universal set consisting of six

objects and $F = \{f_1, f_2, f_3, f_4\}$ be a set of parameters. Here, f_1, f_2, f_3, f_4 stand for the parameters ‘very large’, ‘large’, ‘attractive’, ‘expensive’ respectively. Suppose that,

M (very large) = $\{\langle u_1, 0.8, 0.3, 0.4 \rangle, \langle u_2, 0.7, 0.3, 0.5 \rangle, \langle u_3, 0.8, 0.2, 0.3 \rangle, \langle u_4, 0.6, 0.4, 0.5 \rangle, \langle u_5, 0.9, 0.3, 0.3 \rangle, \langle u_6, 0.8, 0.4, 0.5 \rangle\}$,

M (large) = $\{\langle u_1, 0.7, 0.3, 0.2 \rangle, \langle u_2, 0.6, 0.3, 0.4 \rangle, \langle u_3, 0.6, 0.4, 0.4 \rangle, \langle u_4, 0.6, 0.3, 0.2 \rangle, \langle u_5, 0.7, 0.5, 0.4 \rangle, \langle u_6, 0.6, 0.5, 0.6 \rangle\}$,

M (attractive) = $\{\langle u_1, 0.9, 0.2, 0.2 \rangle, \langle u_2, 0.8, 0.3, 0.2 \rangle, \langle u_3, 0.8, 0.2, 0.3 \rangle, \langle u_4, 0.9, 0.4, 0.2 \rangle, \langle u_5, 0.8, 0.5, 0.4 \rangle, \langle u_6, 0.7, 0.4, 0.6 \rangle\}$,

M (expensive) = $\{\langle u_1, 0.8, 0.2, 0.3 \rangle, \langle u_2, 0.9, 0.1, 0.2 \rangle, \langle u_3, 0.8, 0.3, 0.5 \rangle, \langle u_4, 0.9, 0.3, 0.3 \rangle, \langle u_5, 0.8, 0.4, 0.5 \rangle, \langle u_6, 0.8, 0.2, 0.5 \rangle\}$

Therefore, M (very large) means very large objects, M (attractive) means attractive objects, etc. Now we can represent the above NSS (M, A) over U in the form of a table (See the Table 1).

Table 1. Tabular form of the NSSs (M, A)

U	f ₁ = very large	f ₂ = large	f ₃ = attractive	f ₄ = expensive
u ₁	(0.8, 0.3, 0.4)	(0.7, 0.3, 0.2)	(0.9, 0.2, 0.2)	(0.8, 0.2, 0.3)
u ₂	(0.7, 0.3, 0.5)	(0.6, 0.3, 0.4)	(0.8, 0.3, 0.2)	(0.9, 0.1, 0.2)
u ₃	(0.8, 0.2, 0.3)	(0.6, 0.4, 0.4)	(0.8, 0.2, 0.3)	(0.8, 0.3, 0.5)
u ₄	(0.6, 0.4, 0.5)	(0.6, 0.3, 0.2)	(0.9, 0.4, 0.2)	(0.9, 0.3, 0.3)
u ₅	(0.9, 0.3, 0.3)	(0.7, 0.5, 0.4)	(0.8, 0.5, 0.4)	(0.8, 0.4, 0.5)
u ₆	(0.8, 0.4, 0.5)	(0.6, 0.5, 0.6)	(0.7, 0.4, 0.6)	(0.8, 0.2, 0.5)

Definition 8 [21]: Consider two NSSs (M₁, A) and (M₂, B) over a common universe U. (M₁, A) is said to be neutrosophic soft subset of (M₂, B) if $M_1 \subset M_2$, and $T_{M_1(f)}(x) \leq T_{M_2(f)}(x), I_{M_1(f)}(x) \leq I_{M_2(f)}(x), F_{M_1(f)}(x) \leq F_{M_2(f)}(x), \forall f \in A, x \in U$. We represent it by $(M_1, A) \subseteq (M_2, B)$.

Definition 9 [21]: Let (M_1, A) and (M_2, B) be two NSSs over a common universe U . They are said to be equal i.e. $(M_1, A) = (M_2, B)$ if $(M_1, A) \subseteq (M_2, B)$ and $(M_2, B) \subseteq (M_1, A)$.

Definition 10 [21]: Consider $F = \{f_1, f_2, \dots, f_q\}$ be a set of parameters. Then, the NOT of F is defined by $NOT F = \{not f_1, not f_2, \dots, not f_q\}$, where it is to be noted that NOT and not are different operators.

Definition 11 [21]: The complement of a neutrosophic soft set (M, A) is denoted by $(M, A)^C$ and is represented as $(M, A)^C = (M^C, NOT A)$ with $T_{M^C(\theta)}(x) = F_{M(\theta)}(x)$; $I_{M^C(\theta)}(x) = I_{M(\theta)}(x)$; $F_{M^C(\theta)}(x) = T_{M(\theta)}(x)$, where $M^C: NOT A \rightarrow P(U)$.

Definition 12 [21]: A NSS (M, A) over a universe U is called a null NSS with respect to the parameter A if $T_{M(\theta)}(m) = I_{M(\theta)}(m) = F_{M(\theta)}(m) = 0, \forall f \in A, \forall m \in U$.

Definition 13 [21]: Let (M_1, A) and (M_2, B) be two NSSs over a common universe U . The union (M_1, A) and (M_2, B) is defined by $(M_1, A) \cup (M_2, B) = (M, C)$, where $C = A \cup B$ and the truth-membership, indeterminacy-membership and falsity-membership functions are defined as follows:

$$\begin{aligned}
 T_{M(\theta)}(m) &= T_{M_1(\theta)}(m), \text{ if } f \in M_1 - M_2, \\
 &= T_{M_2(\theta)}(m), \text{ if } f \in M_2 - M_1, \\
 &= \max(T_{M_1(\theta)}(m), T_{M_2(\theta)}(m)), \text{ if } f \in M_1 \cap M_2. \\
 I_{M(\theta)}(m) &= I_{M_1(\theta)}(m), \text{ if } f \in M_1 - M_2, \\
 &= I_{M_2(\theta)}(m), \text{ if } f \in M_2 - M_1, \\
 &= \frac{I_{M_1(\theta)}(m) + I_{M_2(\theta)}(m)}{2} \text{ if } f \in M_1 \cap M_2. \\
 F_{M(\theta)}(m) &= F_{M_1(\theta)}(m), \text{ if } f \in M_1 - M_2, \\
 &= F_{M_2(\theta)}(m), \text{ if } f \in M_2 - M_1, \\
 &= \min(F_{M_1(\theta)}(m), F_{M_2(\theta)}(m)), \text{ if } f \in M_1 \cap M_2.
 \end{aligned}$$

Definition 14 [21]: Suppose (M_1, A) and (M_2, B) are two NSSs over a common universe U . The intersection (M_1, A) and (M_2, B) is defined by $(M_1, A) \cap (M_2, B) = (N, D)$,

where $D = A \cap B$ and the truth-membership, indeterminacy-membership and falsity-membership functions of (N, D) are as follows:

$$\begin{aligned}
 T_{N(\theta)}(m) &= \min(T_{M_1(\theta)}(m), T_{M_2(\theta)}(m)); I_{N(\theta)}(m) \\
 &= \frac{I_{M_1(\theta)}(m) + I_{M_2(\theta)}(m)}{2}; F_{N(\theta)}(m) = \max(F_{M_1(\theta)}(m), \\
 &F_{M_2(\theta)}(m)).
 \end{aligned}$$

3 A neutrosophic soft MADM based on grey relational projection method

Assume $G = \{g_1, g_2, \dots, g_p\}$, ($p \geq 2$) be a discrete set of alternatives and $A = \{a_1, a_2, \dots, a_q\}$, ($q \geq 2$) be a set of choice parameters under consideration in a MADM problem. The rating of performance value of alternative g_i , $i = 1, 2, \dots, p$ with respect to the choice parameter a_j , $j = 1, 2, \dots, q$ is represented by a tuple $t_{ij} = (T_{M(a_j)}(g_i), I_{M(a_j)}(g_i), F_{M(a_j)}(g_i))$, where for a fixed i the value t_{ij} ($i = 1, 2, \dots, p; j = 1, 2, \dots, q$) denotes NSS of all the p objects. Let $w = \{w_1, w_2, \dots, w_q\}$ be the weight vector assigned for the choice parameters, where $0 \leq w_j \leq 1$ with $\sum_{j=1}^q w_j = 1$, but specific value of w_j is unknown. Now the steps of decision making based on neutrosophic soft information are described as given below.

Step 1. Construction of criterion matrix with SVNSS

GRA method is appropriate for dealing with quantitative attributes. However, in the case of qualitative attribute, the performance values are taken as SVNSSs. The performance values $t_{\tilde{N}_{ij}}$ ($i = 1, 2, \dots, p; j = 1, 2, \dots, q$) could be arranged in the matrix called criterion matrix and whose rows are labeled by the alternatives and columns are labeled by the choice parameters. The criterion matrix is presented as follows:

$$D_{\tilde{N}} = \left\langle t_{\tilde{N}_{ij}} \right\rangle_{p \times q} = \begin{bmatrix} t_{11} & t_{12} & \dots & t_{1q} \\ t_{21} & t_{22} & \dots & t_{2q} \\ \dots & \dots & \dots & \dots \\ t_{p1} & t_{p2} & \dots & t_{pq} \end{bmatrix}$$

where $t_{ij} = (T_{ij}, I_{ij}, F_{ij})$ where $T_{ij}, I_{ij}, F_{ij} \in [0, 1]$ and $0 \leq T_{ij} + I_{ij} + F_{ij} \leq 3, i = 1, 2, \dots, p; j = 1, 2, \dots, q$.

Step 2. Determination of weights of the attributes

In the decision making situation, the decision maker encounters problem of identifying the unknown attributes

weights, where it may happen that the weights of attributes are different. In this paper, we use information entropy method in order to obtain unknown attribute weight. The entropy measure can be used when weights of attributes are dissimilar and completely unknown to the decision maker. The entropy measure [33] of a SVNS $\tilde{N} = \{x, \langle T_{\tilde{N}}(x), I_{\tilde{N}}(x), F_{\tilde{N}}(x) \rangle\}$ is defined as given below.

$$E_i(\tilde{N}) = 1 - \frac{1}{n} \sum_{i=1}^p (T_{\tilde{N}}(x_i) + F_{\tilde{N}}(x_i)) \left| I_{\tilde{N}}(x_i) - I_{\tilde{N}}^C(x_i) \right| \quad (2)$$

which has the following properties:

(i). $E_i(\tilde{N}) = 0$ if \tilde{N} is a crisp set and $I_{\tilde{N}}(x_i) = 0, \forall x \in X$.

(ii). $E_i(\tilde{N}) = 0$ if $\langle T_{\tilde{N}}(x_i), I_{\tilde{N}}(x_i), F_{\tilde{N}}(x_i) \rangle = \langle 0.5, 0.5, 0.5 \rangle, \forall x \in X$.

(iii). $E_i(\tilde{N}_1) \leq E_i(\tilde{N}_2)$ if \tilde{N}_1 is more uncertain than \tilde{N}_2 i.e.

$$T_{\tilde{N}_1}(x_i) + F_{\tilde{N}_1}(x_i) \leq T_{\tilde{N}_2}(x_i) + F_{\tilde{N}_2}(x_i)$$

$$\text{and } \left| I_{\tilde{N}_1}(x_i) - I_{\tilde{N}_1}^C(x_i) \right| \leq \left| I_{\tilde{N}_2}(x_i) - I_{\tilde{N}_2}^C(x_i) \right|.$$

(iv). $E_i(\tilde{N}) = E_i(\tilde{N}^C), \forall x \in X$.

Therefore, the entropy value E_j of the j -th attribute can be obtained as follows:

$$E_j = 1 - \frac{1}{q} \sum_{i=1}^p (T_{ij}(x_i) + F_{ij}(x_i)) \left| I_{ij}(x_i) - I_{ij}^C(x_i) \right|, \quad (j = 1, 2, \dots, q) \quad (3)$$

Here, $0 \leq E_j \leq 1$ and according to Hwang and Yoon [34] and Wang and Zhang [35] the entropy weight of the j -th attribute is defined as follows:

$$w_j = \frac{1 - E_j}{\sum_{j=1}^q 1 - E_j}, \text{ with } 0 \leq w_j \leq 1 \text{ and } \sum_{j=1}^q w_j = 1 \quad (4)$$

Step 3. Determination of ideal neutrosophic estimates reliability solution (INERS) and ideal neutrosophic estimates un-reliability solution (INEURS)

Dezart [36] proposed the idea of single valued neutrosophic cube. From this cube one can easily obtain ideal neutrosophic estimates reliability solution (INERS)

and ideal neutrosophic estimates un-reliability solution (INEURS). An INERS $P_{\tilde{N}}^+ = [p_{\tilde{N}_1}^+, p_{\tilde{N}_2}^+, \dots, p_{\tilde{N}_q}^+]$ is a solution in which every element $p_{\tilde{N}_j}^+ = \langle T_j^+, I_j^+, F_j^+ \rangle$, where $T_j^+ = \max_i \{T_{ij}\}, I_j^+ = \min_i \{I_{ij}\}, F_j^+ = \min_i \{F_{ij}\}$ in the criteria matrix $D_{\tilde{N}} = \langle T_{ij}, I_{ij}, F_{ij} \rangle_{p \times q}$ for $i = 1, 2, \dots, p; j = 1, 2, \dots, q$. Also, an INEURS $P_{\tilde{N}}^- = [p_{\tilde{N}_1}^-, p_{\tilde{N}_2}^-, \dots, p_{\tilde{N}_q}^-]$ is a solution in which every element $p_{\tilde{N}_j}^- = \langle T_j^-, I_j^-, F_j^- \rangle_{p \times q}$, where $T_j^- = \min_i \{T_{ij}\}, I_j^- = \max_i \{I_{ij}\}, F_j^- = \max_i \{F_{ij}\}$ in the criterion matrix $D_{\tilde{N}} = \langle T_{ij}, I_{ij}, F_{ij} \rangle_{p \times q}$ for $i = 1, 2, \dots, p; j = 1, 2, \dots, q$.

Step 4. Grey relational projection method

3.1 Projection method

Definition 15 [37, 38]: Consider $a = (a_1, a_2, \dots, a_q)$ and $b = (b_1, b_2, \dots, b_q)$ are two vectors, then cosine of included angle between vectors a and b is defined as follows:

$$\text{Cos}(a, b) = \frac{\sum_{j=1}^q (a_j b_j)}{\sqrt{\sum_{j=1}^q a_j^2} \times \sqrt{\sum_{j=1}^q b_j^2}} \quad (5)$$

Obviously, $0 < \text{Cos}(a, b) \leq 1$, and the direction of a and b is more accordant according to the bigger value of $\text{Cos}(a, b)$.

Definition 16 [37, 38]: Let $a = (a_1, a_2, \dots, a_q)$ be a vector, then norm of a is given by

$$\|a\| = \sqrt{\sum_{j=1}^q a_j^2} \quad (6)$$

The direction and norm are two important parts of a vector. However, $\text{Cos}(a, b)$ can only compute whether their directions are accordant, but cannot determine the magnitude of norm. Therefore, the closeness degree of two vectors can be defined by the projection value in order to take the norm magnitude and cosine of included angle together.

Definition 17 [37, 38]: Let $a = (a_1, a_2, \dots, a_q)$ and $b = (b_1, b_2, \dots, b_q)$ be two vectors, then the projection of vector a onto vector b is defined as follows:

$$Pr(a) = \|a\| \cos(a, b) = \sqrt{\sum_{j=1}^q a_j^2} \times \frac{\sum_{j=1}^q (a_j b_j)}{\sqrt{\sum_{j=1}^q a_j^2} \times \sqrt{\sum_{j=1}^q b_j^2}} = \frac{\sum_{j=1}^q (a_j b_j)}{\sqrt{\sum_{j=1}^q b_j^2}} \quad (7)$$

The bigger the value of $Pr(a)$ is, the more close the vector b to the vector a is.

3.2 Grey correlation projection method

The grey correlation projection method is a combination of grey correlation method and projection method. The method is presented in the following steps.

Step-1. The grey relational coefficient of each alternative from INERS is obtained from the following formula:

$$\zeta_{ij}^+ = \frac{\min_i \min_j \Omega_{ij}^+ + \sigma \max_i \max_j \Omega_{ij}^+}{\Omega_{ij}^+ + \sigma \max_i \max_j \Omega_{ij}^+} \quad (8)$$

where $\Omega_{ij}^+ = d(t_{\tilde{N}_i}, p_{\tilde{N}_j}^+) =$ Hamming distance between $t_{\tilde{N}_i}$ and $p_{\tilde{N}_j}^+$, ($i = 1, 2, \dots, p; j = 1, 2, \dots, q$).

Also, the grey relational coefficient of each alternative from INEURS is obtained from the formula given below:

$$\zeta_{ij}^- = \frac{\min_i \min_j \Omega_{ij}^- + \sigma \max_i \max_j \Omega_{ij}^-}{\Omega_{ij}^- + \sigma \max_i \max_j \Omega_{ij}^-} \quad (9)$$

where $\Omega_{ij}^- = d(t_{\tilde{N}_i}, p_{\tilde{N}_j}^-) =$ Hamming distance between $t_{\tilde{N}_i}$ and $p_{\tilde{N}_j}^-$, ($i = 1, 2, \dots, p; j = 1, 2, \dots, q$).

Here, $\sigma \in [0, 1]$ represents the environmental or resolution coefficient and it is used to adjust the difference of the relation coefficient. Generally, we set $\sigma = 0.5$.

Step-2. Grey correlation coefficient matrix ζ^+ between every alternative and INERS is formulated as given below.

$$\zeta^+ = \begin{bmatrix} \zeta_{11}^+ & \zeta_{12}^+ & \dots & \zeta_{1q}^+ \\ \zeta_{21}^+ & \zeta_{22}^+ & \dots & \zeta_{2q}^+ \\ \dots & \dots & \dots & \dots \\ \zeta_{p1}^+ & \zeta_{p2}^+ & \dots & \zeta_{pq}^+ \end{bmatrix}$$

and correlation coefficient between INERS and INERS is:

$$\zeta_0^+ = (\zeta_{01}^+, \zeta_{02}^+, \dots, \zeta_{0q}^+) = (1, 1, \dots, 1)$$

Grey correlation coefficient matrix ζ^- between every alternative and INEURS is constructed as follows.

$$\zeta^- = \begin{bmatrix} \zeta_{11}^- & \zeta_{12}^- & \dots & \zeta_{1q}^- \\ \zeta_{21}^- & \zeta_{22}^- & \dots & \zeta_{2q}^- \\ \dots & \dots & \dots & \dots \\ \zeta_{p1}^- & \zeta_{p2}^- & \dots & \zeta_{pq}^- \end{bmatrix}$$

Similarly, the correlation coefficient between INEURS and INEURS is:

$$\zeta_0^- = (\zeta_{01}^-, \zeta_{02}^-, \dots, \zeta_{0q}^-) = (1, 1, \dots, 1)$$

Step-3. Weighted neutrosophic grey correlation coefficient matrix G between every alternative and INERS is formulated as given below.

$$G^+ = \begin{bmatrix} w_1 \zeta_{11}^+ & w_2 \zeta_{12}^+ & \dots & w_q \zeta_{1q}^+ \\ w_1 \zeta_{21}^+ & w_2 \zeta_{22}^+ & \dots & w_q \zeta_{2q}^+ \\ \dots & \dots & \dots & \dots \\ w_1 \zeta_{p1}^+ & w_2 \zeta_{p2}^+ & \dots & w_q \zeta_{pq}^+ \end{bmatrix}$$

The weighted correlation coefficient between INERS and INERS is:

$$G_0^+ = (w_1 \zeta_{01}^+, w_2 \zeta_{02}^+, \dots, w_q \zeta_{0q}^+) = (w_1, w_2, \dots, w_q)$$

Weighted neutrosophic grey correlation coefficient matrix G^- between every alternative and INEURS is presented as follows:

$$G^- = \begin{bmatrix} w_1 \zeta_{11}^- & w_2 \zeta_{12}^- & \dots & w_q \zeta_{1q}^- \\ w_1 \zeta_{21}^- & w_2 \zeta_{22}^- & \dots & w_q \zeta_{2q}^- \\ \dots & \dots & \dots & \dots \\ w_1 \zeta_{p1}^- & w_2 \zeta_{p2}^- & \dots & w_q \zeta_{pq}^- \end{bmatrix}$$

and similarly, weighted correlation coefficient between INEURS and INEURS is presented as follows:

$$G_0^- = (w_1 \zeta_{01}^-, w_2 \zeta_{02}^-, \dots, w_q \zeta_{0q}^-) = (w_1, w_2, \dots, w_q)$$

Step-4. Calculation of the weighted grey correlation of alternative g_i onto the INERS can be obtained as:

$$Pr_i^+ = \frac{\| G_i \| \text{Cos} (G_i, G_0^+)}{\sqrt{\sum_{j=1}^q (w_j \zeta_{ij}^+)^2} \times \frac{\sum_{j=1}^q ((w_j \zeta_{ij}^+) \times w_j)}{\sqrt{\sum_{j=1}^q (w_j \zeta_{ij}^+)^2} \times \sqrt{\sum_{j=1}^q w_j^2}} = \frac{\sum_{j=1}^q ((w_j \zeta_{ij}^+) \times w_j)}{\sqrt{\sum_{j=1}^q w_j^2}} \quad (10)$$

Similarly, the weighted grey correlation of alternative g_i onto the INEURS can be obtained as follows:

$$Pr_i^- = \frac{\| G_i \| \text{Cos} (G_i, G_0^-)}{\sqrt{\sum_{j=1}^q (w_j \zeta_{ij}^-)^2} \times \frac{\sum_{j=1}^q ((w_j \zeta_{ij}^-) \times w_j)}{\sqrt{\sum_{j=1}^q (w_j \zeta_{ij}^-)^2} \times \sqrt{\sum_{j=1}^q w_j^2}} = \frac{\sum_{j=1}^q ((w_j \zeta_{ij}^-) \times w_j)}{\sqrt{\sum_{j=1}^q w_j^2}} \quad (11)$$

Step-5. Calculation of the neutrosophic relative relational degree

The ranking order of all alternatives can be obtained according to the value of the neutrosophic relative relational degree. We calculate the neutrosophic relative relational degree by using the following equation

$$C_i = \frac{Pr_i^+}{Pr_i^+ + Pr_i^-}, i = 1, 2, \dots, p. \quad (12)$$

Rank the alternatives according to the values of C_i , $i = 1, 2, \dots, p$ in descending order and choose the alternative with biggest C_i .

4 A numerical example

We consider the decision making problem for selecting the most suitable house for Mr. X [21]. Let Mr. X desires to select the most suitable house out of p houses on the basis of q parameters. Also let, the rating of or performance value of the house g_i , $i = 1, 2, \dots, p$ with respect to parameter a_j , $j = 1, 2, \dots, q$ is represented by $t_{N_{ij}} = (T_{G(a_j)}(g_i), I_{G(a_j)}(g_i), F_{G(a_j)}(g_i))$ such that for a fixed i , $t_{N_{ij}}$ denotes neutrosophic soft set of all the q objects. Let, $A = \{\text{beautiful, cheap, in good repairing, moderate, wooden}\}$ be the set of choice parameters. The criterion decision matrix (see Table 2) is presented as follows:

Table 2. Tabular form of criterion decision matrix

U	beautiful	cheap	in good repairing	moderate	wooden
g_1	(0.6,0.3, 0.8)	(0.5, 0.2, 0.6)	(0.7, 0.3, .4)	(0.8, 0.5, 0.6)	(0.6, 0.7, 0.2)
g_2	(0.7, 0.2, 0.6)	(0.6, 0.3, 0.7)	(0.7, 0.5, .6)	(0.6, 0.8, 0.3)	(0.8, 0.1, 0.8)
g_3	(0.8, 0.3, 0.4)	(0.8, 0.5, 0.1)	(0.3, 0.5, 0.6)	(0.7, 0.2, 0.1)	(0.7, 0.2, 0.6)
g_4	(0.7, 0.5, 0.6)	(0.6, 0.8, 0.7)	(0.7, 0.6, 0.8)	(0.8, 0.3, 0.6)	(0.8, 0.3, 0.8)
g_5	(0.8, 0.6, 0.7)	(0.5, 0.6, 0.8)	(0.8, 0.7,0.6)	(0.7, 0.8, 0.3)	(0.7, 0.2, 0.6)

The proposed procedure is presented in the following steps.

Step 1. Calculation of the weights of the attribute

Entropy value E_j ($j = 1, 2, \dots, 5$) of the j -th attribute can be obtained from the equation (3) as follows:

$$E_1 = 0.576, E_2 = 0.556, E_3 = 0.74, E_4 = 0.564, E_5 = 0.24.$$

Then the corresponding normalized entropy weights are obtained as given below.

$$w_1 = 0.2155, w_2 = 0.2076, w_3 = 0.2763, w_4 = 0.2111, w_5 = 0.0895, \text{ where } \sum_{j=1}^5 w_j = 1.$$

Step 2. Calculation of INERS and INEURS

The INERS (P_N^+) and INEURS (P_N^-) of the decision matrix are shown as follows:

$$P_N^+ = \langle (0.8, 0.2, 0.4); (0.8, 0.2, 0.1); (0.8, 0.3, 0.4); (0.8, 0.2, 0.1); (0.8, 0.1, 0.2) \rangle$$

$$P_N^- = \langle (0.6, 0.6, 0.8); (0.5, 0.8, 0.8); (0.3, 0.7, 0.8); (0.6, 0.8, 0.6); (0.6, 0.7, 0.8) \rangle$$

Step 3. Determine the grey relational coefficient of each alternative from INERS and INEURS

The grey relational coefficient of each alternative from INERS can be determined as follows:

$$\zeta_{ij}^+ = \begin{bmatrix} 0.571 & 0.532 & 1.000 & 0.532 & 0.532 \\ 0.799 & 0.500 & 0.665 & 0.470 & 0.615 \\ 1.000 & 0.799 & 0.500 & 1.000 & 0.615 \\ 0.615 & 0.380 & 0.532 & 0.615 & 0.532 \\ 0.571 & 0.380 & 0.615 & 0.500 & 0.615 \end{bmatrix}$$

Similarly, the neutrosophic grey relational coefficient of each alternative from INEURS can be obtained as given below.

$$\zeta_{ij}^- = \begin{bmatrix} 1.000 & 0.516 & 0.405 & 0.650 & 0.599 \\ 0.555 & 0.555 & 0.516 & 0.788 & 0.516 \\ 0.483 & 0.384 & 0.714 & 0.405 & 0.516 \\ 0.714 & 0.880 & 0.650 & 0.555 & 0.599 \\ 1.000 & 0.880 & 0.555 & 0.714 & 0.516 \end{bmatrix}$$

Step 4. Calculation of the weighted grey correlation projection

Calculation of the weighted grey correlation projection of alternative g_i onto the INERS and INEURS can be obtained from the equations (10) and (11) respectively as follows:

$$\begin{aligned} Pr_1^+ &= 0.1538, Pr_2^+ = 0.1353, Pr_3^+ = 0.1686, Pr_4^+ = 0.1172, \\ Pr_5^+ &= 0.117; \\ Pr_1^- &= 0.1333, Pr_2^- = 0.1283, Pr_3^- = 0.1157, Pr_4^- = 0.1502, \\ Pr_5^- &= 0.1627. \end{aligned}$$

Step 5. Calculate the grey relative relational degree

We compute the grey relative relational degree by using equation (12) as follows:

$$C_1 = 0.5357, C_2 = 0.5133, C_3 = 0.5930, C_4 = 0.4188, C_5 = 0.4183.$$

Step 6. The ranking order of the houses can be obtained according to the value of grey relative relational degree. It is observed that $C_3 > C_1 > C_2 > C_4 > C_5$ and so the highest value of grey relative relational degree is C_3 . Therefore, the house g_3 is the best alternative for Mr. X.

Note: We now compare our proposed method with the method discussed by Maji [21]. Maji [21] first constructed the comparison matrix and then computed the score S_i of g_i , $\forall i$. The preferable alternative is selected based on the maximum score of S_i . The ranking order of the houses is given by $g_5 > g_3 > g_4 > g_1 > g_2$. In the present paper, a neutrosophic soft MADM problem through grey correlation projection method is proposed with unknown weights information. The ranking of alternatives are determined by the relative closeness to INERS which combines grey relational projection values from INERS and INEURS to each alternative. The ranking order of the houses is presented as $g_3 > g_1 > g_2 > g_4 > g_5$. However, if he rejects the house h_3 for any reason, his next preference will be g_1 .

5 Conclusion

In this paper, we have presented a new approach for solving neutrosophic soft MADM problem based on GRP method with unknown weight information of the choice parameters. The proposed approach is a hybrid model of neutrosophic soft sets and GRP method where the choice parameters are represented in terms of single valued neutrosophic information. The weights of the parameters are determined by using information entropy method. In

the proposed approach, grey relative relational degrees of all alternatives are calculated in order to rank the alternatives and then the most suitable option is selected. An illustrative example for house selection is provided in order to verify the practicality and effectiveness of the proposed approach. We hope that that the proposed approach can be effective in dealing with different MADM problems such as cluster analysis, image processing, medical diagnosis, pattern recognition, object selection.

In the future, we shall investigate generalized neutrosophic soft GRP, interval neutrosophic soft GRP, intuitionistic soft GRP methods for practical MADM problems.

References

- [1] L. A. Zadeh. Fuzzy sets. Information and Control, 8 (1965), 338-353.
- [2] K. T. Atanassov. Intuitionistic fuzzy sets. Fuzzy Sets and Systems, 20 (1986), 87-96.
- [3] F. Smarandache. A unifying field of logics. Neutrosophy: Neutrosophic probability, set and logic. American Research Press, Rehoboth, 1998.
- [4] F. Smarandache. Linguistic paradoxes and tautologies. Libertas Mathematica, University of Texas at Arlington, IX (1999), 143-154.
- [5] F. Smarandache. Neutrosophic set – a generalization of intuitionistic fuzzy sets. International Journal of Pure and Applied Mathematics, 24 (3) (2005), 287-297.
- [6] F. Smarandache. Neutrosophic set – a generalization of intuitionistic fuzzy set. Journal of Defence Resources Management, 1 (1) (2010), 107-116.
- [7] H. Wang, F. Smarandache, Y. Q. Zhang, and R. Sundaraman. Single valued neutrosophic sets. Multispace and Multistructure, 4 (2010), 410-413.
- [8] D. Molodtsov. Soft set theory – first results. Computers and Mathematics with Applications, 37 (1999), 19-31.
- [9] P. K. Maji, A. R. Roy, and R. Biswas. An application in soft sets in a decision making problem. Computers and Mathematics with Applications, 44 (2002), 1077-1083.
- [10] P. K. Maji, R. Biswas, and A. R. Roy. Soft set theory. Computers and Mathematics with Applications, 45 (2003), 555-562.
- [11] M. I. Ali, F. Feng, X. Liu, W. K. Min, and M. Shabir. On some new operations in soft set theory. Computers and Mathematics with Applications, 57 (2009), 1547-1553.
- [12] C. F. Yang. A note on “Soft Set Theory” [Comput. Math. Appl. 45 (4–5) (2003) 555–562]. Computers and Mathematics with Applications, 56 (2008), 1899-1900.
- [13] P. K. Maji, R. Biswas, and A. R. Roy. Fuzzy soft sets. The Journal of Fuzzy Mathematics, 9 (2001), 589-602.
- [14] P. K. Maji, R. Biswas, and A. R. Roy. Intuitionistic fuzzy soft sets. The Journal of Fuzzy Mathematics, 9 (3) (2001), 677-692.
- [15] W. Xu, J. Ma, S. Wang, and G. Hao. Vague soft sets and their properties. Computers and Mathematics with Applications, 59 (2010), 787-794.

- [16] P. Majumdar, and S. K. Samanta. Generalized fuzzy soft sets. *Computers and Mathematics with Applications*, 59 (2010), 1425-1432.
- [17] K. V. Babitha, and J. J. Sunil. Generalized intuitionistic fuzzy soft sets and its applications. *Gen. Math. Notes*, 7 (2) (2011), 1-14.
- [18] K. Alhazaymeh, and N. Hassan. Possibility vague soft set and its application in decision making. *International Journal of Pure and Applied Mathematics*, 77 (4) (2012), 549-563.
- [19] A. R. Roy, and P. K. Maji. A fuzzy soft set theoretic approach to decision making problems. *Journal of Computational and Applied Mathematics*, 203 (2007), 412-418.
- [20] N. Çağman, S. Enginoğlu, and F. Çıtak. Fuzzy soft set theory and its applications. *Iranian Journal of Fuzzy System*, 8 (3) (2011), 137-147.
- [21] P. K. Maji. Neutrosophic soft set. *Annals of Fuzzy Mathematics and Informatics*, 5 (1) (2013), 157-168.
- [22] P. K. Maji. Weighted neutrosophic soft sets. *Neutrosophic Sets and Systems*, 6 (2014), 6-12.
- [23] P. K. Maji. Weighted neutrosophic soft sets approach in a multi-criteria decision making problem. *Journal of New Theory*, (5) (2015), 1-12.
- [24] P. Biswas, S. Pramanik, and B. C. Giri. Entropy based grey relational analysis method for multi-attribute decision making under single valued neutrosophic assessment. *Neutrosophic Sets and Systems*, 2 (2014), 102-110.
- [25] P. Biswas, S. Pramanik, and B. C. Giri. A new methodology for neutrosophic multi-attribute decision making with unknown weight information. *Neutrosophic Sets and Systems*, 3 (2014), 42-50.
- [26] K. Mondal and S. Pramanik. Neutrosophic decision making model of school choice. *Neutrosophic Sets and Systems*, 7 (2015), 62-68.
- [27] J. L. Deng. Introduction to grey system theory. *The Journal of Grey System*, 1 (1989), 1-24.
- [28] D. L. Olson, and D. Wu. Simulation of fuzzy multi attribute models for grey relationships. *European Journal of Operational Research*, 175 (2006), 111-120.
- [29] W. H. Chen. Distribution system restoration using the hybrid fuzzy-grey method. *IEEE Transactions on Power Systems*, 20 (2005), 199-205.
- [30] S. Pramanik, and D. Mukhopadhyaya. Grey relational analysis based intuitionistic fuzzy multi criteria group decisionmaking approach for teacher selection in higher education. *International Journal of Computer Applications*, 34 (10) (2011), 21-29.
- [31] K. Mondal and S. Pramanik. Rough neutrosophic multi-attribute decision – making based on grey relational analysis. *Neutrosophic Sets and Systems*, 7 (2015), 8-17.
- [32] Xin Zhang, Fang Jin, and Peide Liu. A grey relational projection method for multi-attribute decision making based on intuitionistic trapezoidal fuzzy number. *Applied Mathematical Modelling*, 37 (5) (2013), 3467-3477.
- [33] P. Majumder, and S. K. Samanta. On similarity and entropy of neutrosophic sets. *Journal of Intelligent and Fuzzy Systems*, (2013). DOI: 10.3233/IFS-130810.
- [34] C. L. Hwang, and K. Yoon. Multiple attribute decision making: methods and applications: a state-of-the-art survey. Springer, London, 1981.
- [35] J. Q. Wang, and Z. H. Zhang. Multi-criteria decisionmaking method with incomplete certain information based on intuitionistic fuzzy number. *Control and decision*, 24 (2009), 226-230.
- [36] J. Dezert. Open questions in neutrosophic inferences. *Multiple-Valued Logic: An International Journal*, 8 (2002), 439-472.
- [37] Z. S. Xu. Theory Method and Applications for Multiple Attribute Decision-Making with Uncertainty. Tsinghua University Press, Beijing, 2004.
- [38] Z. S. Xu, and Q. L. Da. Projection method for uncertain multi-attribute decision making with preference information on alternatives. *International Journal of Information Technology & Decision Making*, 3 (2004), 429-434.

Received: Feb., 02, 2015. Accepted: Mar. 27, 2016



The Novel Attempt for Finding Minimum Solution in Fuzzy Neutrosophic Relational Geometric Programming (FNRGP) with (max,min) Composition

Huda E. Khalid

University of Telafer, Head; Mathematics Department, College of Basic Education, Telafer - Mosul -Iraq, hodaesmail@yahoo.com

Abstract. This article sheds light on the possibility of finding the minimum solution set of neutrosophic relational geometric programming with (max, min) composition. This work examines the privacy enjoyed by both neutrosophic logic and geometric programming, and how it affects the minimum solutions. It is the first attempt to solve this

type of problems. Neutrosophic relation equations are important branches of neutrosophic mathematics. At present they have been widely applied in chemical plants, transportation problem, study of bonded labor problem [5].

Keyword:- Geometric Programming, Neutrosophic Relational Equations, Fuzzy Integral Neutrosophic Matrices, Minimum Solution, Fuzzy Neutrosophic Relational Geometric Programming (FNRGP).

Introduction

The notion of neutrosophic relational equations which are abundant with the concept of indeterminacy, was first introduced by Florentin Smarandache [5]. We call

$$x \circ A = b \quad (1)$$

a neutrosophic relational equations, where $A = (a_{ij})_{m \times n}$ is fuzzy integral neutrosophic matrix with entries from $[0,1] \cup I$, $b = (b_1, \dots, b_n)$, $b_j \in [0,1] \cup I$ and 'o' is the (max - min) composition operator. The pioneering contribution for the theory of geometric programming (GP) problems goes to Zener, Duffin and Peterson in 1961. A large number of applications for GP and fuzzy relation GP can be found in business administration, technological economic analysis, resource allocation, environmental engineering, engineering optimization designment and modernization of management, therefore it is significant to solve such a programming. B.Y. Cao proposed the fuzzy GP problems in 1987. He was the first to deal with fuzzy relation equations with GP at 2007. In a similar way to fuzzy relational equations, when the solution set of problem (1) is not empty, it's in general

a non-convex set that can be completely determined by one maximum solution and a finite number of minimal solutions. H.E. Khalid presented in details and for the first time the structure of maximum solution for FNRGP at 2015. Recently there is not an effective method to confirm whether the solution set has a minimal solution, which makes the solving problem more difficult. In the consideration of the importance of the GP and the neutrosophic relation equation in theory and applications, we propose a fuzzy neutrosophic relation GP, discussed optimal solutions.

1. Fundamentals Concepts

Definition 1.1 [5]

Let $N = [0,1] \cup I$ where I is the indeterminacy. The $m \times n$ matrices $A = \{(a_{ij}) \mid a_{ij} \in N\}$ are called fuzzy integral neutrosophic matrices. Clearly the class of $m \times n$ matrices is contained in the class of fuzzy integral neutrosophic matrices.

Definition 1.2

The optimization problem

$$\left. \begin{aligned} \min f(x) &= (c_1 \Lambda x_1^{\gamma_1}) V, \dots, V(c_m \Lambda x_m^{\gamma_m}) \\ \text{s. t.} \\ x \circ A &= b \\ (x_i \in N) &(1 \leq i \leq m) \end{aligned} \right\} (2)$$

is called (V, Λ) (max-min) fuzzy neutrosophic relational GP. Where $A = (a_{ij}) (a_{ij} \in N, 1 \leq i \leq m, 1 \leq j \leq n)$ is an $(m \times n)$ -dimensional fuzzy integral neutrosophic matrix, $x = (x_1, x_2, \dots, x_m)$ an m -dimensional variable vector, $c = (c_1, c_2, \dots, c_m) (c_i \geq 0)$ and $b = (b_1, b_2, \dots, b_n) (b_j \in N)$ are $(m \& n)$ -dimensional constant vectors respectively, γ_i is an arbitrary real number.

Without loss of generality, the elements of b must be rearranged in decreasing order and the elements of the matrix A is correspondingly rearranged.

Definition 1.3 [3]:

The neutrosophic algebraic structures are algebraic structures based on sets of neutrosophic numbers of the form $Z = a + bI$, where a, b are real (or complex) numbers, and a is called the determinate part of Z and b is called the indeterminate part of Z , while $I = \text{indeterminacy}$, with $mI + nI = (m + n)I, 0 \cdot I = 0, I^n = I$ for integer $n \geq 1$, and $I/I = \text{undefined}$. When a, b are real numbers, then $a + bI$ is called a neutrosophic real number. While if a, b are complex numbers, then $a + bI$ is called a neutrosophic complex number.

Definition 1.4: [partial ordered relation of integral fuzzy neutrosophic numbers]

Depending upon the definition of integral neutrosophic lattice [5], the author propose the following axioms:

a- decreasing partial order

1-The greatest element in $[0,1] \cup I$ is I ,

$$\max(I, x) = I \quad \forall x \in [0,1]$$

2- The fuzzy values in a decreasing order will be rearranged as follows :

$$1 > x_1 > x_2 > x_3 > \dots > x_m \geq 0$$

3- One is the greatest element in $[0,1] \cup I$,

$$\max(I, 1) = 1$$

b- Increasing partial order

1- the smallest element in $(0,1] \cup I$ is I ,

$$\min(I, x) = I \quad \forall x \in (0,1]$$

2- The fuzzy values in increasing order will be rearranged as follows :

$$0 < x_1 < x_2 < x_3 < \dots < x_m \leq 1$$

3- Zero is the smallest element in $[0,1] \cup I$,

$$\min(I, 0) = 0$$

Example :- To rearrange the following matrices:-

$$b = [I \quad .5 \quad I \quad .85]^T$$

$$c = [1 \quad I \quad 0 \quad I \quad .4 \quad .1 \quad .85]^T$$

in

1- decreasing order

$$b^T = [I \quad I \quad 0.85 \quad 0.5]$$

$$c^T = [1 \quad I \quad I \quad 0.85 \quad 0.4 \quad 0.1 \quad 0]$$

2- increasing order

$$b^T = [I \quad I \quad 0.5 \quad 0.85]$$

$$c^T = [0 \quad I \quad I \quad 0.1 \quad 0.4 \quad 0.85 \quad 1]$$

Definition 1.5

If there exists a solution to Eq.(1) it's called compatible.

Suppose $X(A, b) = \{(x_1, x_2, \dots, x_m)^T \in [0,1]^n \cup I, I^n = I | x \circ A = b, x_i \in N\}$ is a solution set of Eq.(1) we define $x^1 \leq x^2 \iff x_i^1 \leq x_i^2 (1 \leq i \leq m), \forall x^1, x^2 \in X(A, b)$. Where " \leq " is a partial order relation on $X(A, b)$.

Definition 1.6 [4]:

If $\exists \hat{x} \in X(A, b)$, such that $x \leq \hat{x}, \forall x \in X(A, b)$, then \hat{x} is called the greatest solution to Eq.(1) and

$$\hat{x}_i = \left\{ \begin{array}{ll} 1 & a_{ij} \leq b_j \text{ or } a_{ij} = b_j = 1 \\ b_j & a_{ij} > b_j \\ 0 & a_{ij} = 1 \text{ and } b_j = [0,1] \\ 1 & b_j = 1 \text{ and } a_{ij} = (0,1] \\ \text{not comp. } a_{ij} = 0 \text{ and } b_j = 1 \end{array} \right\} \quad (3)$$

Corollary 1.7 [2]:

If $X(A, b) \neq \emptyset$. then $\hat{x} \in X(A, b)$.

Similar to fuzzy relation equations , the above corollary works on fuzzy neutrosophic relation equations.

Notes 1.8:

1- Every fuzzy variable is always a neutrosophic variable, but all neutrosophic variables in general are not fuzzy variables. [5]

2- The set of all minimal solutions to Eq.(1) are denoted by $\check{X}(A, b)$.

3- $X(A, b)$ is non-convex, but it is composed of several n-dimensional rectangular regions with each rectangular region being a closed convex set [2].

2. The theory concept for exponents of variables in the geometric programming via fuzzy neutrosophic relation equations:-

B.Y Cao (2010) [1] had discussed optimization for fuzzy relation GP by considering the following three cases:

1- if $\gamma_i < 0$ ($1 \leq i \leq m$), then the greatest solution \hat{x} to Eq.(1) is an optimal solution for problem (2).

2- if $\gamma_i \geq 0$, then a minimal solution \check{x} to Eq.(1) is an optimal solution to (2).

3- the optimal solution to optimization problem (2) must exist in $\check{X}(A, b)$. Let $f(\check{x}^*) = \min\{f(\check{x})|\check{x} \in \check{X}(A, b)\}$, where $\check{x}^* \in \check{X}(A, b)$, then $\forall x \in X(A, b) f(x) \geq f(\check{x}^*)$. Therefore , \check{x}^* is an optimal solution to optimization problem (2).

Note that, in a more general case \check{x}^* may not be unique.

As for the general situation, the exponent γ_i of x_i is either a positive number or a negative one . B.Y.Cao proposed

$$R_1 = \{i|\gamma_i < 0, 1 \leq i \leq m\},$$

$$R_2 = \{i|\gamma_i \geq 0, 1 \leq i \leq m\}.$$

Then $R_1 \cap R_2 = \emptyset, R_1 \cup R_2 = i$, where $i = \{1,2, \dots, m\}$.

$$\text{Let } f_1(x) = \prod_{i \in R_1} x_i^{\gamma_i}, \quad f_2(x) = \prod_{i \in R_2} x_i^{\gamma_i}.$$

Then $f(x) = f_1(x)f_2(x)$. Therefore, if some exponent γ_i of x_i are positive numbers while others are negative, then x^* is an optimal solution to optimization problem (2) where

$$x_i^* = \begin{cases} \hat{x}_i, & i \in R_1 \\ \check{x}_i^* & i \in R_2 \end{cases} \quad (4)$$

Really the above work can be coincided for our fuzzy neutrosophic relation in GP because the variables exponents (γ_i) are still real numbers in problem (2), note that there is trouble in case of $\gamma_i < 0$ and corollary 3.3 handled it.

3. An adaptive procedure to find the minimal solution for fuzzy neutrosophic geometric programming with (max, min) relation composition.

Definition 3.1 [5]:

Matrix $M = (m_{ij})_{m \times n}$ is called "matrix pattern" where $m_{ij} = (\hat{x}_i, a_{ij})$, this matrix is important element in the process of finding minimal solutions.

3.2 Algorithm:

Step 1- Rank the elements of b with decreasing order (definition 1.4) and find the maximum solution \hat{x} (see Eq.(3)).

Step 2- If \hat{x} is not a solution to Eq.(1), then go to step 15, otherwise go to step 3.

Step 3- Find the "matrix pattern" (definition 3.1).

Step 4- Mark m_{ij} , which satisfies $\min(\hat{x}_i, a_{ij}) = b_j$.

Step 5- Let the marked m_{ij} be denoted by \tilde{m}_{ij}

Step 6- If j_1 is the smallest j in all marked \tilde{m}_{ij} , then set $\tilde{x}_{i_1}^*$ to be the smaller one of the two elements in $\tilde{m}_{i_1 j_1}$.

Step 7- Delete the i_1 th row and the j_1 th column of M and then delete all the columns that contain marked $\tilde{m}_{i_1 j}$, where $j \neq j_1$.

Step 8- In all remained and marked \tilde{m}_{ij} , find the smallest j and set it to be j_2 , then let $\tilde{x}_{i_2}^*$ be the smaller of the two elements in $\tilde{m}_{i_2 j_2}$.

Step 9- Delete the i_2 th row and the j_2 th column of M and then delete all the columns that contain marked $\tilde{m}_{i_2 j}$, where $j \neq j_2$.

Step 10- Repeat step 7 and 8 until no marked \tilde{m}_{ij} is remained.

Step 11- The other \tilde{x}_i^* , which are not set in 5-9, are set to be zero.

Step 12- Let $\tilde{x}^* = (\tilde{x}_1^*, \tilde{x}_2^*, \dots, \tilde{x}_m^*)$ be the quasi minimum for problem (2).

Step 13- Check the sign of γ_i if $\gamma_i < 0$, then put \hat{x}_i instead of \tilde{x}_i^* unless $\hat{x}_i = I$ (see Eq.(5))

Step 14- Print $x^* = \tilde{x}^*$, $f(x^*)$ and stop.

Step 15- Print "have no solution" and stop.

Corollary 3.3:

If $\gamma_i < 0$ and the component $(\hat{x}_i = I) \in \hat{x}$, then the component $\tilde{x}_i^* \in \tilde{x}^*$ will be optimal for problem (2).

So the Eq.(4) must be improved to appropriate problem (2) as follow:-

$$x_i^* = \begin{cases} \hat{x}_i, & i \in R_1 \text{ and } \hat{x}_i \neq I \\ \tilde{x}_i^* & i \in R_2 \text{ or } (i \in R_1 \text{ and } \hat{x}_i = I) \end{cases} \quad (5)$$

□

4. Numerical Example:-

Consider the following fuzzy neutrosophic relation GP problem :-

$$\text{Min}f(x) = (1.5Ax_1^5)V(IAx_2)V(.8Ax_3^5)$$

$$V(.9Ax_4^{-2})V(.7Ax_5^{-4})V(IAx_6^{-1})$$

s. t.

$$x \circ A = b \text{ where}$$

$$A = \begin{bmatrix} I & .2 & .8 & .1 \\ .8 & .2 & .8 & .1 \\ .9 & .1 & .4 & .1 \\ .3 & .95 & .1 & .1 \\ .85 & I & .1 & .1 \\ .4 & .8 & .1 & 0 \end{bmatrix}_{6 \times 4}$$

$$b = (.85, .6, .5, .1)$$

It is clear that b is arranged in decreasing order.

The maximum solution is

$$\hat{x} = (0, .5, .5, .6, 0, .6)$$

$$M = \begin{bmatrix} (0, I) & (0, .2) & (0, .8) & (0, .1) \\ (.5, .8) & (.5, .2) & (.5, .8) & (.5, .1) \\ (.5, .9) & (.5, .1) & (.5, .4) & (.5, .1) \\ (.6, .3) & (.6, .95) & (.6, .1) & (.6, .1) \\ (0, .85) & (0, I) & (0, .1) & (0, .1) \\ (.6, .4) & (.6, .8) & (.6, .1) & (.6, 0) \end{bmatrix}_{6 \times 4}$$

The elements satisfying $\min(\hat{x}_i, a_{ij}) = b_i$ are:

$$m_{42}, m_{62}, m_{23}, m_{24}, m_{34}, m_{44}$$

$$\tilde{m}_{42}, \tilde{m}_{62}, \tilde{m}_{23}, \tilde{m}_{24}, \tilde{m}_{34}, \tilde{m}_{44}$$

The element \tilde{m}_{42} is of least column number, therefore $\tilde{x}_{i_1} = \min(.6, .95) = .6$

At the same time, the fourth row and the second column will be deleted.

As well as, the column included the element \tilde{m}_{44} must be deleted.

All remained elements of the matrix M are

$$\begin{bmatrix} (0, I) & (0, .8) \\ (.5, .8) & (.5, .8) \\ (.5, .9) & (.5, .4) \\ (0, .85) & (0, .1) \\ (.6, .5) & (.6, .1) \end{bmatrix}$$

$$\tilde{x}_{i_2} = \min(.5, .8) = .5$$

$$\therefore \tilde{x}_{i_2} = .5$$

Set $\check{x}_{i_3} = \check{x}_{i_4} = \check{x}_{i_5} = \check{x}_{i_6} = 0$

So the quasi minimum is

$$\check{x}^* = (.6, .5, 0, 0, 0, 0)$$

The exponents of x_4, x_5, x_6 in objective function $f(x)$ are negative, therefore

$$x^* = (\underbrace{.6, .5, 0}_{\text{from quasi}}, \underbrace{.6, 0, .6}_{\text{from maximum}})$$

$$f(x^*) = (1.5 \wedge 0.6^{-5})V(I \wedge 0.5)V(.8 \wedge 0^{-5})$$

$$V(0.9 \wedge 0.6^{-2})V(.7 \wedge 0^{-4})V(I \wedge 0.6^{-1})$$

$$f(x^*) = I.$$

5 Open problems:-

1- It will be a good project to search the optimal solution for fuzzy neutrosophic relation GP when the variables exponents (γ_i) in the objective function contain indeterminacy value.

2- More specifically if the variables exponents are negative and containing indeterminacy value.

3- Search for optimal solution in case of fuzzy neutrosophic relation GP if the composition 'o' be (max-product).

Conclusion

This essay, contains novel work to find optimal solution for an important branch of nonlinear programming named GP subject to a system of fuzzy neutrosophic relational equation with (*max – min*) composition. In 1976, Sanchez gave the formula of the maximal solution for fuzzy relation equation concept and described in details its structure. H.E. Khalid introduced the structure of maximal solution for fuzzy neutrosophic relation GP problems at 2015. There is a debuted numerical example which shows that the proposed method is an effective to search for an optimum solution .

Acknowledgements

My deep thank to Prof. Dr. Florentin Smarandache for his encouragement. I would like to thank Ahmed K. Essa for his help.

Reference

[1] B. Y. Cao "Optimal models and methods with fuzzy quantities". Springer-Verlag, Berlin ,(2010).
 [2] B.Y. Cao and J. Yang "Monomial geometric programming with fuzzy relation equation constraints". Fuzzy Optimization and Decision Making 6: 337-349,(2007).
 [3] F. Smarandache,. (T, I, F)-Neutrosophic Structures, NSS journal 8 : 3-10 ,(2015).
 [4] H. E. Khalid. An Original Notion to Find Maximal Solution in the Fuzzy Neutrosophic Relation Equations (FNRE) with Geometric Programming (GP), NSS journal 7 : 3-7,(2015).
 [5] V. Kandasamy & F. Smarandache, Fuzzy Relational Maps and Neutrosophic Relational Maps. American Research Press, Rehoboth, (2004).

Received: Oct. 22, 2015. Accepted: Jan. 10, 2016



Neutrosophic Goal Programming

Mohamed Abdel-Baset¹, Ibrahim M. Hezam² and Florentin Smarandache³

¹ Department of Operations Research, Faculty of Computers and Informatics, Zagazig University, Sharqiyah, Egypt.
E-mail: analyst_mohamed@yahoo.com

² Department of computer, Faculty of Education, Ibb University, Ibb city, Yemen.
E-mail: Ibrahimam.math@gmail.com

³ Math & Science Department, University of New Mexico, Gallup, NM 87301, USA. E-mail: smarand@unm.edu

Abstract. In this paper, we introduce the goal programming in neutrosophic environment. The degrees of acceptance, indeterminacy and rejection of objectives are simultaneously considered. We propose two models for solving Neutrosophic Goal Programming Problem (NGPP), at one hand aiming to minimize the sum of the deviation (the Ist model), and at the

other hand, transforming NGPP into a crisp programming model, using truth membership, indeterminacy membership, and falsity membership functions (the IInd model). Finally, an industrial design problem is given to illustrate the efficiency of the proposed models. The obtained results of the Ist model and of the IInd model are compared with other methods.

Keywords: Neutrosophic optimization; Goal programming problem.

1 Introduction

Goal Programming (GP) Models was originally introduced by Charnes and Cooper in early 1961 for a linear model. Multiple and conflicting goals can be used in goal programming. Also, GP allows simultaneous solution of a system of complex objectives, and the solution of the problem requires ascertaining among these multiple objectives. In this case, the model must be solved in such way, that each of the objectives to be achieved. Therefore, the sum of the deviations from the ideal should be minimized in the objective function. It is important that measure deviations from the ideal should have a single scale, because deviations with different scales cannot be collected. However, the target value associated with each goal could be of neutrosophic type in the real-world application.

In 1995, Smarandache [17] starting from philosophy (fretted to distinguish [8] between *absolute truth* and *relative truth* or between *absolute falsehood* and *relative falsehood* in logics, and respectively between *absolute membership* and *relative membership* or *absolute non-membership* and *relative non-membership* in set theory) began to use the non-standard analysis. Also, inspired from the sport games (winning, defeating, or tie scores), from votes (pro, contra, null/black votes), from positive/negative/zero numbers, from yes/no/NA, from decision making and control theory (making a decision, not making, or hesitating), from accepted/rejected/pending, etc. and guided by the fact that the law of excluded middle did not work any longer in the modern logics, Smarandache [12] combined the non-standard analysis with a tri-

component logic/set/probability theory and with philosophy. How to deal with all of them at once? Is it possible to unite them? [12].

Neutrosophic Theory means Neutrosophy applied in many fields of sciences, in order to solve problems related to indeterminacy. Neutrosophy is a new branch of philosophy that studies the origin, nature, and scope of neutralities, as well as their interactions with different ideational spectra. This theory considers every entity $\langle A \rangle$ together with its opposite or negation $\langle \text{anti}A \rangle$, and with their spectrum of neutralities $\langle \text{neut}A \rangle$ in between them (i.e. entities supporting neither $\langle A \rangle$ nor $\langle \text{anti}A \rangle$). The $\langle \text{neut}A \rangle$ and $\langle \text{anti}A \rangle$ ideas together are referred to as $\langle \text{non}A \rangle$.

Neutrosophy is a generalization of Hegel's dialectics (which is based on $\langle A \rangle$ and $\langle \text{anti}A \rangle$ only). According to this new theory, every entity $\langle A \rangle$ tends to be neutralized and balanced by $\langle \text{anti}A \rangle$ and $\langle \text{non}A \rangle$ entities - as a state of equilibrium. In a classical way, $\langle A \rangle$, $\langle \text{neut}A \rangle$, $\langle \text{anti}A \rangle$ are disjointed two by two. But, since in many cases the borders between notions are vague, imprecise, Sorites, it is possible that $\langle A \rangle$, $\langle \text{neut}A \rangle$, $\langle \text{anti}A \rangle$ (and $\langle \text{non}A \rangle$, of course) have common parts two by two, or even all three of them as well. Whilst the Neutrosophic Theory is based on the triad $\langle A \rangle$, $\langle \text{neut}A \rangle$, and $\langle \text{anti}A \rangle$, it also studies the indeterminacy, labeled as I , with $In = I$ for $n \geq 1$, and $mI + nI = (m+n)I$ in neutrosophic structures developed in algebra, geometry, topology etc.

The most advanced fields of Neutrosophic Theory are Neutrosophic Set, Neutrosophic Logic, Neutrosophic Probability, and Neutrosophic Statistics - that started in 1995, and recently Neutrosophic Precalculus and

Neutrosophic Calculus, together with their applications in practice. Neutrosophic Set and Neutrosophic Logic are generalizations of the fuzzy set and respectively of the fuzzy logic (especially of intuitionistic fuzzy set and of intuitionistic fuzzy logic). In neutrosophic logic, a proposition has a degree of truth (T), a degree of indeterminacy (I), and a degree of falsity (F), where T, I, F are standard or non-standard subsets of $]0, 1+[$.

An important method for multi-objective decision making is the goal programming approach in practical decision making of real life. In a standard GP formulation, goals and constraints are precisely defined, but sometimes the system's aim and conditions include some vague and undetermined situations. In particular, mathematically expressing the decision maker's unclear target levels for the goals, and the need to optimize all goals at the same level, leads to complicated calculations.

The neutrosophic approach for goal programming tries to solve this kind of unclear difficulties.

The structure of the paper is as follows: the next section is a preliminary discussion; the third section describes the formation of the problem, by developing two models for neutrosophic goal programming; the fourth section presents an industrial design problem, to put on view how the approach can be applied; finally, the fifth section provides the conclusion.

2 Some preliminaries

Definition 1. [17] A real fuzzy number \tilde{J} is a continuous fuzzy subset from the real line R whose triangular membership function $\mu_{\tilde{J}}(J)$ is defined by a continuous mapping from R to the closed interval $[0,1]$, where

- (1) $\mu_{\tilde{J}}(J) = 0$ for all $J \in (-\infty, a_1]$,
- (2) $\mu_{\tilde{J}}(J)$ is strictly increasing on $J \in [a_1, m]$,
- (3) $\mu_{\tilde{J}}(J) = 1$ for $J = m$,
- (4) $\mu_{\tilde{J}}(J)$ is strictly decreasing on $J \in [m, a_2]$,
- (5) $\mu_{\tilde{J}}(J) = 0$ for all $J \in [a_2, +\infty)$.

This will be prompted by:

$$\mu_{\tilde{J}}(J) = \begin{cases} \frac{J - a_1}{m - a_1}, & a_1 \leq J \leq m, \\ \frac{a_2 - J}{a_2 - m}, & m \leq J \leq a_2, \\ 0, & \text{otherwise.} \end{cases} \quad (1)$$

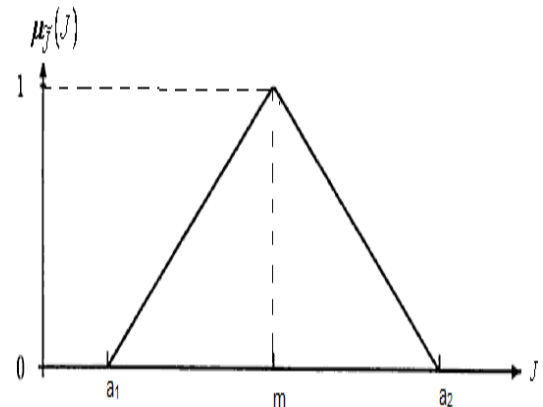

Figure 1: Membership Function of Fuzzy Number J .

where m is a given value a_1 and a_2 denoting the lower and upper bounds. Sometimes, it is more convenient to use the notation explicitly highlighting the membership function parameters. In this case, we obtain

$$\mu(J; a_1, m, a_2) = \text{Max} \left\{ \text{Min} \left[\frac{J - a_1}{m - a_1}, \frac{a_2 - J}{a_2 - m} \right], 0 \right\} \quad (2)$$

In what follows, the definition of the α -level set or α -cut of the fuzzy number \tilde{J} is introduced.

Definition 2. [1] Let $X = \{x_1, x_2, \dots, x_n\}$ be a fixed non-empty universe; an intuitionistic fuzzy set IFS A in X is defined as

$$A = \left\{ \langle x, \mu_A(x), \nu_A(x) \rangle \mid x \in X \right\}, \quad (3)$$

which is characterized by a membership function

$$\mu_A : X \rightarrow [0,1]$$

and a non-membership function

$$\nu_A : X \rightarrow [0,1]$$

with the condition $0 \leq \mu_A(x) + \nu_A(x) \leq 1$ for all $x \in X$ where μ_A and ν_A represent, respectively, the degree of membership and non-membership of the element x to the set A . In addition, for each IFS A in X , $\pi_A(x) = 1 - \mu_A(x) - \nu_A(x)$ for all $x \in X$ is called the degree of hesitation of the element x to the set A . Especially, if $\pi_A(x) = 0$, then the IFS A is degraded to a fuzzy set.

Definition 3. [4] The α -level set of the fuzzy parameters \tilde{J} in problem (1) is defined as the ordinary set $L_\alpha(\tilde{J})$ for which the degree of membership function exceeds the level, α , $\alpha \in [0,1]$, where:

$$L_\alpha(\tilde{J}) = \left\{ J \in R \mid \mu_{\tilde{J}}(J) \geq \alpha \right\}, \quad (4)$$

for certain values α_j^* to be in the unit interval.

Definition 4. [10] Let X be a space of points (objects) and $x \in X$. A neutrosophic set A in X is defined by a truth-membership function $T_A(x)$, an indeterminacy-membership function $I_A(x)$ and a falsity-membership function $F_A(x)$, as shown in Figure 2. $T_A(x)$, $I_A(x)$ and $F_A(x)$ are real standard or real nonstandard subsets of $]0-,1+[$. That is $T_A(x):X \rightarrow]0-,1+[$, $I_A(x):X \rightarrow]0-,1+[$ and $F_A(x):X \rightarrow]0-,1+[$. There is no restriction on the sum of $T_A(x)$, $I_A(x)$ and $F_A(x)$, so

$$0-\leq \sup T_A(x) \leq \sup I_A(x) \leq F_A(x) \leq 3+.$$

In the following, we adopt the notations $\mu_A(x)$, $\sigma_A(x)$ and $\nu_A(x)$ instead of $T_A(x)$, $I_A(x)$ and $F_A(x)$, respectively. Also we write SVN numbers instead of single valued neutrosophic numbers.

Definition 5. [10] Let X be a universe of discourse. A single valued neutrosophic set A over X is an object having the form

$$A = \{ \langle x, \mu_A(x), \sigma_A(x), \nu_A(x) \rangle : x \in X \}$$

where $\mu_A(x):X \rightarrow [0,1]$, $\sigma_A(x):X \rightarrow [0,1]$ and $\nu_A(x):X \rightarrow [0,1]$ with $0 \leq \mu_A(x) + \sigma_A(x) + \nu_A(x) \leq 3$ for all $x \in X$. The intervals $\mu_A(x)$, $\sigma_A(x)$ and $\nu_A(x)$ denote the truth-membership degree, the indeterminacy-membership degree and the falsity membership degree of x to A , respectively.

For convenience, a SVN number is denoted by $A = (a, b, c)$, where $a, b, c \in [0,1]$ and $a + b + c \leq 3$.

Definition 6 Let \tilde{J} be a neutrosophic number in the set of real numbers R , then its truth-membership function is defined as

$$T_{\tilde{J}}(J) = \begin{cases} \frac{J - a_1}{a_2 - a_1}, & a_1 \leq J \leq a_2, \\ \frac{a_2 - J}{a_3 - a_2}, & a_2 \leq J \leq a_3, \\ 0, & \text{otherwise.} \end{cases} \quad (5)$$

its indeterminacy-membership function is defined as

$$I_{\tilde{J}}(J) = \begin{cases} \frac{J - b_1}{b_2 - b_1}, & b_1 \leq J \leq b_2, \\ \frac{b_2 - J}{b_3 - b_2}, & b_2 \leq J \leq b_3, \\ 0, & \text{otherwise.} \end{cases} \quad (6)$$

and its falsity-membership function is defined as

$$F_{\tilde{J}}(J) = \begin{cases} \frac{J - c_1}{c_2 - c_1}, & c_1 \leq J \leq c_2, \\ \frac{c_2 - J}{c_3 - c_2}, & c_2 \leq J \leq c_3, \\ 1, & \text{otherwise.} \end{cases} \quad (7)$$

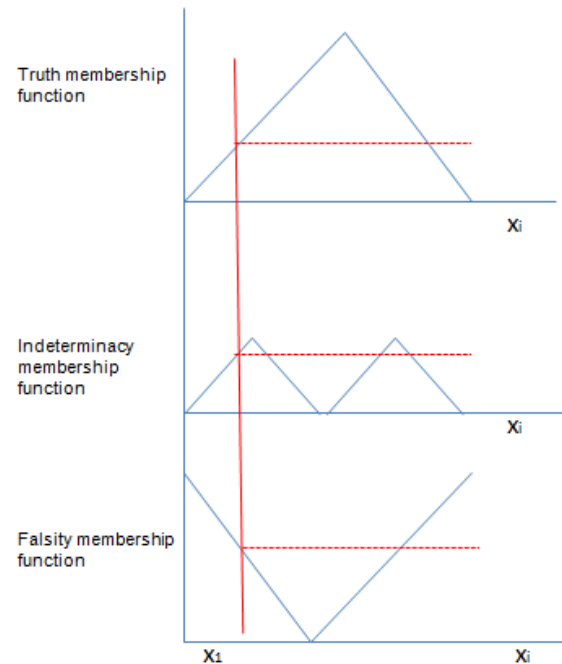

Figure 2: Neutrosophication process [11].

3 Neutrosophic Goal Programming Problem

Goal programming can be written as:

$$\text{Find } x = (x_1, x_2, \dots, x_n)^T$$

To achieve:

$$z_i = t_i, \quad i = 1, 2, \dots, k \quad (8)$$

subject to $x \in X$

where t_i are scalars and represent the target achievement levels of the objective functions that the decision maker wishes to attain provided, X is feasible set of the constraints.

The achievement function of the (8) model is the following:

$$\text{Min } \sum_{i=1}^k (w_{1i} n_i + w_{2i} p_i) \quad (9)$$

Goal and constraints:

$$z_i + n_i - p_i = t_i, \quad i \in \{1, 2, \dots, k\}$$

$$x \in X, \quad n, p \geq 0, \quad n \cdot p = 0$$

n_i, p_i are negative and positive deviations from t_i target.

The NGPP can be written as:

$$\text{Find } x = (x_1, x_2, \dots, x_n)^T$$

So as to:

Minimize z_i with target value t_i , acceptance tolerance a_i , indeterminacy tolerance d_i , rejection tolerance c_i , subject to

$x \in X$
 $g_j(x) \leq b_j, j = 1, 2, \dots, m$
 $x_i \geq 0, i = 1, 2, \dots, n$
 with truth-membership, indeterminacy-membership and falsity-membership functions

$$\mu_i^I(z_i) = \begin{cases} 1, & \text{if } z_i \leq t_i, \\ 1 - \frac{z_i - t_i}{a_i}, & \text{if } t_i \leq z_i \leq t_i + a_i, \\ 0, & \text{if } z_i \geq t_i + a_i \end{cases} \quad (10)$$

$$\sigma_i^I(z_i) = \begin{cases} 0, & \text{if } z_i \leq t_i, \\ \frac{z_i - t_i}{d_i}, & \text{if } t_i \leq z_i \leq t_i + d_i, \\ 1 - \frac{z_i - t_i}{a_i - d_i}, & \text{if } t_i + d_i \leq z_i \leq t_i + a_i, \\ 0, & \text{if } z_i \geq t_i + a_i \end{cases} \quad (11)$$

$$\nu_i^I(z_i) = \begin{cases} 0, & \text{if } z_i \leq t_i, \\ \frac{z_i - t_i}{C_i}, & \text{if } t_i \leq z_i \leq t_i + C_i, \\ 1, & \text{if } z_i \geq t_i + C_i \end{cases} \quad (12)$$

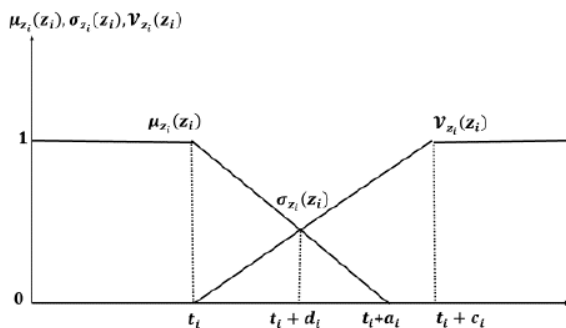

Figure 3: truth-membership, indeterminacy-membership and falsity-membership functions for z_i .

To maximize the degree the acceptance and indeterminacy of NGP objectives and constraints, also to minimize the degree of rejection of NGP objectives and constraints,

$$\begin{aligned} & \text{Max } \mu_{z_i}(z_i), i = 1, 2, \dots, k \\ & \text{Max } \sigma_{z_i}(z_i), i = 1, 2, \dots, k \\ & \text{Min } \nu_{z_i}(z_i), i = 1, 2, \dots, k \end{aligned} \quad (13)$$

subject to

$$\begin{aligned} 0 \leq \mu_{z_i}(z_i) + \sigma_{z_i}(z_i) + \nu_{z_i}(z_i) \leq 3, i = 1, 2, \dots, k \\ \nu_{z_i}(z_i) \geq 0, i = 1, 2, \dots, k \\ \mu_{z_i}(z_i) \geq \nu_{z_i}(z_i), i = 1, 2, \dots, k \end{aligned}$$

$$\mu_{z_i}(z_i) \geq \sigma_{z_i}(z_i), i = 1, 2, \dots, k$$

$$g_j(x) \leq b_j, j = 1, 2, \dots, m$$

$$x \in X$$

$$x_j \geq 0, j = 1, 2, \dots, n$$

where $\mu_{z_i}(z_i)$, $\sigma_{z_i}(z_i)$, $\nu_{z_i}(z_i)$ are truth membership function, indeterminacy membership function, falsity membership function of neutrosophic decision set respectively.

The highest degree of truth membership function is unity. So, for the defined truth membership function $\mu_{z_i}(z_i)$, the flexible membership goals having the aspired level unity can be presented as

$$\mu_{z_i}(z_i) + n_{i1} - p_{i1} = 1$$

For the case of indeterminacy membership function, it can be written as:

$$\sigma_{z_i}(z_i) + n_{i2} - p_{i2} = 0.5$$

For the case of rejection (falsity membership function), it can be written as:

$$\nu_{z_i}(z_i) + n_{i3} - p_{i3} = 0$$

Here $n_{i1}, p_{i1}, n_{i2}, p_{i2}, n_{i3}$ and p_{i3} are under-deviational and over-deviational variables.

Our goals are to maximize the degree of the acceptance and indeterminacy of NGP objectives and constraints, and minimize the degree of rejection of NGP objectives and constraints.

Model (I). The minimization of the sum of the deviation can be formulated as:

$$\text{Min } \lambda = \sum_{i=1}^k w_{i1}n_{i1} + \sum_{i=1}^k w_{i2}n_{i2} + \sum_{i=1}^k w_{i3}p_{i3} \quad (14)$$

subject to

$$\mu_{z_i}(z_i) + n_{i1} \geq 1, i = 1, 2, \dots, k$$

$$\sigma_{z_i}(z_i) + n_{i2} \geq 0.5, i = 1, 2, \dots, k$$

$$\nu_{z_i}(z_i) - p_{i3} \leq 0, i = 1, 2, \dots, k$$

$$\nu_{z_i}(z_i) \geq 0, i = 1, 2, \dots, k$$

$$\mu_{z_i}(z_i) \geq \nu_{z_i}(z_i), i = 1, 2, \dots, k$$

$$\mu_{z_i}(z_i) \geq \sigma_{z_i}(z_i), i = 1, 2, \dots, k$$

$$0 \leq \mu_{z_i}(z_i) + \sigma_{z_i}(z_i) + \nu_{z_i}(z_i) \leq 3, i = 1, 2, \dots, k$$

$$g_j(x) \leq b_j, j = 1, 2, \dots, m$$

$$n_{i1}, n_{i2}, p_{i3} \geq 0, i = 1, 2, \dots, k$$

$$x \in X$$

$$x_j \geq 0, j = 1, 2, \dots, n$$

On the other hand, neutrosophic goal programming NGP in Model (13) can be represented by crisp programming model using truth membership,

indeterminacy membership, and falsity membership functions as:

$$\begin{aligned}
 &Max \alpha, Max \gamma, Min \beta && (15) \\
 &\mu_{z_i}(z_i) \geq \alpha, \quad i = 1, 2, \dots, k \\
 &\sigma_{z_i}(z_i) \geq \gamma, \quad i = 1, 2, \dots, k \\
 &\nu_{z_i}(z_i) \leq \beta, \quad i = 1, 2, \dots, k \\
 &z_i \leq t_i, \quad i = 1, 2, \dots, k \\
 &0 \leq \alpha + \gamma + \beta \leq 3 \\
 &\alpha, \gamma \geq 0, \quad \beta \leq 1 \\
 &g_j(x) \leq b_j, \quad j = 1, 2, \dots, m \\
 &x_j \geq 0, \quad j = 1, 2, \dots, n
 \end{aligned}$$

In the model (15) the *Max* α , *Max* γ are equivalent to *Min*($1-\alpha$), *Min*($1-\gamma$) respectively where $0 \leq \alpha, \gamma \leq 1$

$$\begin{aligned}
 &Min \beta(1-\alpha)(1-\gamma) && (16) \\
 &\text{subject to}
 \end{aligned}$$

$$\begin{aligned}
 &z_i \leq t_i + a_i(a_i - d_i)\beta(1-\alpha)(1-\gamma), \quad i = 1, 2, \dots, k \\
 &z_i \leq t_i, \quad i = 1, 2, \dots, k \\
 &0 \leq \alpha + \gamma + \beta \leq 3 \\
 &\alpha, \gamma \geq 0, \quad \beta \leq 1 \\
 &g_j(x) \leq b_j, \quad j = 1, 2, \dots, m \\
 &x_j \geq 0, \quad j = 1, 2, \dots, n
 \end{aligned}$$

If we take $\beta(1-\alpha)(1-\gamma) = v$ the model (16) becomes:

Model (II).

$$\begin{aligned}
 &Minimize \quad v && (17) \\
 &\text{subject to} \\
 &z_i \leq t_i + a_i(a_i - d_i)v, \quad i = 1, 2, \dots, k \\
 &z_i \leq t_i, \quad i = 1, 2, \dots, k \\
 &0 \leq \alpha + \gamma + \beta \leq 3 \\
 &\alpha, \gamma \geq 0, \quad \beta \leq 1 \\
 &g_j(x) \leq b_j, \quad j = 1, 2, \dots, m \\
 &x_j \geq 0, \quad j = 1, 2, \dots, n
 \end{aligned}$$

The crisp model (17) is solved by using any mathematical programming technique with v as parameter to get optimal solution of objective functions.

4 Illustrative Example

This industrial application is selected from [15]. Suppose the decision maker wanting to remove about 98.5% biological oxygen demand (BOD) and the tolerances of acceptance, indeterminacy and rejection on this goal are 0.1, 0.2 and 0.3 respectively. Also, the

decision maker wants to remove the amount of BODS₅ within 300 (thousand \$) tolerances of acceptance, indeterminacy and rejection 200, 250, 300 (thousand \$) respectively. Then the neutrosophic goal programming problem is:

$$\begin{aligned}
 \min z_1(x_1, x_2, x_3, x_4) = &19.4x_1^{-1.47} + 16.8x_2^{-1.66} \\
 &+ 91.5x_3^{-0.3} + 120x_4^{-0.33},
 \end{aligned}$$

$$\min z_2(x_1, x_2, x_3, x_4) = x_1x_2x_3x_4,$$

s.t.:

$$x_i \geq 0, \quad i = 1, 2, 3, 4,$$

with target 300, acceptance tolerance 200, indeterminacy tolerance 100, and rejection tolerance 300 for the first objective z_1 , and also with target 0.015, acceptance tolerance 0.1, indeterminacy tolerance 0.05, and rejection tolerance 0.2 for the second objective z_2 , where x_i is the percentage BOD5 (to remove 5 days BOD) after each step. Then, after four processes, the remaining percentage of BOD5 will be $x_i, i=1,2,3,4$. The aim is to minimize the remaining percentage of BOD5 with minimum annual cost as much as possible. The annual cost of BOD5 removal by various treatments is primary clarifier, trickling filter, activated sludge, carbon adsorption. z_1 represent the annual cost, while z_2 represent the cost removed from the wastewater.

The truth membership, indeterminacy membership, falsity membership functions were considered to be neutrosophic triangular.

The truth membership functions of the goals are obtained as follows:

$$\mu_1^I(z_1) = \begin{cases} 1, & \text{if } z_1 \leq 300, \\ 1 - \frac{z_1 - 300}{200}, & \text{if } 300 \leq z_1 \leq 500, \\ 0, & \text{if } z_1 \geq 500 \end{cases}$$

$$\mu_2^I(z_2) = \begin{cases} 1, & \text{if } z_2 \leq 0.015, \\ 1 - \frac{z_2 - 0.015}{0.1}, & \text{if } 0.015 \leq z_2 \leq 0.115, \\ 0, & \text{if } z_2 \geq 0.115. \end{cases}$$

The indeterminacy membership functions of the goals are given:

$$\sigma_1^I(z_1) = \begin{cases} 0, & \text{if } z_1 \leq 300, \\ \frac{z_1 - 300}{100}, & \text{if } 300 \leq z_1 \leq 400, \\ 1 - \frac{z_1 - 300}{100}, & \text{if } 400 \leq z_1 \leq 600, \\ 0, & \text{if } z_1 \geq 600 \end{cases}$$

$$\sigma_2^I(z_2) = \begin{cases} 0, & \text{if } z_2 \leq 0.015, \\ \frac{z_2 - 0.015}{0.05}, & \text{if } 0.015 \leq z_2 \leq 0.065, \\ 1 - \frac{z_2 - 0.015}{0.05}, & \text{if } 0.065 \leq z_2 \leq 0.215, \\ 0, & \text{if } z_2 \geq 0.215 \end{cases}$$

The falsity membership functions of the goals are obtained as follows:

$$\nu_1^I(z_1) = \begin{cases} 0, & \text{if } z_1 \leq 300, \\ \frac{z_1 - 300}{300}, & \text{if } 300 \leq z_1 \leq 600, \\ 1, & \text{if } z_1 \geq 600 \end{cases}$$

$$\nu_2^I(z_2) = \begin{cases} 0, & \text{if } z_2 \leq 0.015, \\ \frac{z_2 - 0.015}{0.2}, & \text{if } 0.015 \leq z_2 \leq 0.215, \\ 1, & \text{if } z_2 \geq 0.215 \end{cases}$$

Methods	z_1	z_2	x_1	x_2	x_3	x_4
FG ² P ² Ref[15]	363.8048	0.046924	0.7059559	0.7248393	0.1598653	0.5733523
IFG ² P ² Ref[15]	422.1483	0.01504	0.6380199	0.662717	0.09737155	0.3653206
Model (I)	317.666	0.1323	0.7741823	0.7865418	0.2512332	0.8647621
Model (II)	417.6666	0.2150	2.628853	3.087266	0.181976E-01	1.455760

Table 1: Comparison of optimal solution based on different methods

The software LINGO 15.0 is used to solve this problem. Table 1 shows the comparison results with the proposed models and the others methods.

It is to be noted that model (I) offers a better solution than the other methods.

5 Conclusion and Future Work

The main purpose of this paper was to introduce goal programming in neutrosophic environment, simultaneously considering the degrees of acceptance, indeterminacy and rejection of objectives, by two models for solving neutrosophic goal programming problem (NGPP). In the first model, our aim was to minimize the sum of the deviation, while in the second model, NGPP was transformed into a crisp programming model using truth membership, indeterminacy membership, and falsity membership functions. Finally, a numerical experiment is given to illustrate the efficiency of the proposed methods. Moreover, a comparative study between other methods and our results is discussed. In the future studies, the proposed algorithm can be solved by metaheuristic algorithms.

Reference

[1] O.M. Saad, B.M.A. Hassan, and I.M. Hizam, "Optimizing the underground water confined steady flow using a fuzzy approach," International Journal of Mathematical Archive (IJMA) ISSN 2229-5046, vol. 2, 2011.

[2] X. XU, Y. LEI, and W. DAI, "Intuitionistic fuzzy integer programming based on improved particle swarm optimization [J]," Journal of Computer Applications, vol. 9, 2008, p. 062.

[3] A. Yücel, and Ali Fuat Güneri. "A weighted additive fuzzy programming approach for multi-criteria supplier selection." *Expert Systems with Applications* 38, no. 5 (2011): 6281-6286.

[4] I.M. Hizam, O. A. Raouf, M. M. Hadhoud, "Solving Fractional Programming Problems Using Metaheuristic Algorithms Under Uncertainty", *International Journal of Advanced Computing*, vol. 46, 3, 2013, p. 1261--1270.

[5] L. Yi, L. Wei-min, and X. Xiao-lai, "Intuitionistic Fuzzy Bilevel Programming by Particle Swarm Optimization," *Computational Intelligence and Industrial Application*, 2008. PACIIA'08. Pacific-Asia Workshop on, IEEE, 2008, pp. 95-99.

[6] Abdel-Baset, Mohamed, and Ibrahim M. Hezam. "An Improved Flower Pollination Algorithm for Ratios Optimization Problems." *Applied Mathematics & Information Sciences Letters An International Journal* 3, no. 2 (2015): 83-91.

[7] R. Irene Hepzibah, R and Vidhya. "Intuitionistic Fuzzy Multi-Objective linear Programming Problem(IFMOLPP) using Taylor Series" *International Journal of Scientific and Engineering Research (IJSER)*, Vol. 3, Issue 6, June 2014.

[8] A. Amid, S. H. Ghodsypour, and Ch O'Brien. "Fuzzy multiobjective linear model for supplier selection in a supply chain." *International Journal of Production Economics* 104, no. 2 (2006): 394-407.

[9] D. Pintu, Tapan K. R. "Multi-objective non-linear programming problem based on Neutrosophic Optimization Technique and its

- application in Riser Design Problem” Neutrosophic Sets and Systems, Vol. 9, 2015: 88-95.
- [10] R. Şahin, and Muhammed Y. "A Multi-criteria neutrosophic group decision making metod based TOPSIS for supplier selection." *arXiv preprint arXiv:1412.5077* (2014).
- [11] S. Aggarwal, Ranjit B., and A. Q. Ansari. "Neutrosophic modeling and control." In *Computer and Communication Technology (ICCT), 2010 International Conference on*, pp. 718-723. IEEE, 2010.
- [12] Smarandache, F. "A Geometric Interpretation of the Neutrosophic Set-A Generalization of the Intuitionistic Fuzzy Set." *arXiv preprint math/0404520*(2004).
- [13] Dey, S., & Roy, T. K. "Intuitionistic Fuzzy Goal Programming Technique for Solving Non-Linear Multi-objective Structural Problem." *Journal of Fuzzy Set Valued Analysis* 2015, no. 3 (2015): 179-193.
- [14] Pramanik, P., & Roy, T. K. "An intuitionistic fuzzy goal programming approach to vector optimization problem." *Notes on Intuitionistic Fuzzy Sets* 11, no. 1 (2005): 1-14.
- [15] Ghosh, P., & Roy, T. K. "Intuitionistic Fuzzy Goal Geometric Programming Problem (IF G2 P2) based on Geometric Mean Method." In *International Journal of Engineering Research and Technology*, vol. 2, no. 11 (November-2013). ESRSA Publications, 2013.
- [16] IM Hezam, M Abdel-Baset, F. Smarandache, "Taylor Series Approximation to Solve Neutrosophic Multiobjective Programming Problem." Neutrosophic Sets and Systems, Vol. 10, 2015:39-46.
- [17] Smarandache, F. "A Unifying Field in Logics: Neutrosophic Logic. Neutrosophy, Neutrosophic Set, Neutrosophic Probability: Neutrosophic Logic. Neutrosophy, Neutrosophic Set, Neutrosophic Probability. Infinite Study, 2005.

Received: Mar. !5, 2016, Accepted 18 Apr. 2016.

Information about the journal:

Neutrosophic Sets and Systems has been created for publications on advanced studies in neutrosophy, neutrosophic set, neutrosophic logic, neutrosophic probability, neutrosophic statistics, and their applications in any field.

The papers should be professional, in good English, containing a brief review of a problem and obtained results.

All submissions should be designed in MS Word format using our template file:
<http://fs.gallup.unm.edu/NSS/NSS-paper-template.doc>

To submit a paper, mail the file to the Editor-in-Chief. To order printed issues, contact the Editor-in-Chief. This journal is non-commercial, academic edition. It is printed from private donations.

The neutrosophics website at UNM is: <http://fs.gallup.unm.edu/neutrosophy.htm>

The home page of the journal is accessed on <http://fs.gallup.unm.edu/NSS>

Editor-in-Chief:

Prof. Florentin Smarandache
Department of Mathematics and Science
University of New Mexico
705 Gurley Avenue
Gallup, NM 87301, USA

E-mails: fsmarandache@gmail.com, smarand@unm.edu

Associate Editor-in-Chief:

Mumtaz Ali
Department of Mathematics,
Quaid-i-Azam University,
Islamabad, Pakistan

E-mail: mumtazali7288@gmail.com



\$39.95