

Florentin Smarandache, Surapati Pramanik
(Editors)

New Trends
in Neutrosophic Theory
and Applications
Volume II



Florentin Smarandache, Surapati Pramanik (Editors)
New Trends in Neutrosophic Theory and Applications
Volume II

Peer Reviewers

Prof. **Young Bae Jun**, Department of Mathematics Education, Gyeongsang National University, Jinju 52828, Korea; skywine@gmail.com.

Prof. **W.B. Vasantha Kandasamy**, Department of Mathematics, Indian Institute of Technology (Madras), Chennai, 600036, India; vasantha@iitm.ac.in.

Dr. **Jaiyeola Temitope Gbolahan**, Department of Mathematics, Faculty of Science, Obafemi Awolowo University, Ile-Ife, 220005, Nigeria; jaiyeolatemitope@yahoo.com.

Neutrosophic Science International Association

President: Florentin Smarandache

Pons asbl

5, Quai du Batelage, Brussels, Belgium, European Union

President: Georgiana Antonescu

DTP: George Lukacs

ISBN 978-1-59973-559-7

Florentin Smarandache, Surapati Pramanik
(Editors)

New Trends in Neutrosophic Theory and Applications

Volume II



Pons Editions
Brussels, Belgium, EU
2018

Aims and Scope

Neutrosophic theory and applications have been expanding in all directions at an astonishing rate especially after the introduction the journal entitled “Neutrosophic Sets and Systems”. New theories, techniques, algorithms have been rapidly developed. One of the most striking trends in the neutrosophic theory is the hybridization of neutrosophic set with other potential sets such as rough set, bipolar set, soft set, hesitant fuzzy set, etc. The different hybrid structure such as rough neutrosophic set, single valued neutrosophic rough set, bipolar neutrosophic set, single valued neutrosophic hesitant fuzzy set, etc. are proposed in the literature in a short period of time. Neutrosophic set has been a very important tool in all various areas of data mining, decision making, e-learning, engineering, medicine, social science, and some more.

The second volume of “New Trends in Neutrosophic Theories and Applications” focuses on theories, methods, algorithms for decision making and also applications involving neutrosophic information. Some topics deal with data mining, decision making, e-learning, graph theory, medical diagnosis, probability theory, topology, and some more.

Florentin Smarandache, Surapati Pramanik

TABLE OF CONTENTS

Aims and Scope	4
Preface.....	7
DECISION MAKING	
Pu Ji, Peng-fei Cheng, Hongyu Zhang, Jianqiang Wang. Interval valued neutrosophic Bonferroni mean operators and the application in the selection of renewable energy	12
Dragisa Stanujkic, Florentin Smarandache, Edmundas Kazimieras Zavadskas, Darjan Karabasevic. An approach to measuring the website quality based on neutrosophic sets	40
Mehmet Şahin, Abdullah Kargın, Florentin Smarandache. Generalized Single Valued Triangular Neutrosophic Numbers and Aggregation Operators for Application to Multi-attribute Group Decision Making	51
Mehmet Şahin, Vakkas Uluçay, Hatice Acıoğlu. Some weighted arithmetic operators and geometric operators with SVNPs and their application to multi-criteria decision making problems	85
Pranab Biswas, Surapati Pramanik, Bibhas C. Giri. Multi-attribute group decision making based on expected value of neutrosophic trapezoidal numbers	105
Kalyan Mondal, Surapati Pramanik, Bibhas C. Giri. Multi-criteria group decision making based on linguistic refined neutrosophic strategy	125
Surapati Pramanik, Shyamal Dalapati, Shariful Alam, Tapan Kumar Roy. TODIM Method for Group Decision Making under Bipolar Neutrosophic Set Environment	140
Surapati Pramanik, Partha Pratim Dey, Bibhas C. Giri. Hybrid vector similarity measure of single valued refined neutrosophic sets to multi-attribute decision making problems	156
Surapati Pramanik, Rumi Roy, Tapan Kumar Roy. Multi criteria decision making based on projection and bidirectional projection measures of rough neutrosophic sets	175
NEUTROSOPHIC GRAPH THEORY	
Said Broumi, Assia Bakali, Mohamed Talea, Florentin Smarandache, V. Venkateswara Rao. Bipolar complex neutrosophic graphs of type 1	189
Chalapathi, R. V. M. S. S. Kiran Kumar, Florentin Smarandache. Neutrosophic invertible graphs of neutrosophic rings	209
Said Broumi, Assia Bakali, Mohamed Talea, Florentin Smarandache, Faruk Karaaslan. Interval valued neutrosophic soft graphs	218

IMAGE PROCESSING

A.A. Salama, Mohamed Eisa, Hewayda ElGhawalby, A. E. Fawzy. **Neutrosophic image retrieval with hesitancy degree** 253

ALGEBRA AND OTHER PAPERS

R. Dhavaseelan & S. Jafari. **Generalized neutrosophic closed sets**..... 261

Mehmet Şahin, Vakkas Uluçay, Said Broumi. **Bipolar neutrosophic soft expert set theory** . 275

R. Dhavaseelan, M. Ganster, S. Jafari and M. Parimala. **On neutrosophic α -supra open sets and neutrosophic α -supra continuous functions** 289

S. Jafari & N. Rajesh. **Neutrosophic contra-continuous multi-functions** 299

Seok-Zun Song, Madad Khan, Florentin Smarandache, and Young Bae Jun. **A novel extension of neutrosophic sets and its application in BCK=BCI-algebras** 308

M. Caldas, R. Dhavaseelan, M. Ganster, S. Jafari. **Neutrosophic resolvable and neutrosophic irresolvable spaces** 327

R. Dhavaseelan, S. Jafari, R. M. Latif, F. Smarandache. **Neutrosophic rare α -continuity** 336

R. Dhavaseelan, S. Jafari, N. Rajesh, F. Smarandache. **Neutrosophic semi-continuous multifunctions**..... 345

R. Dhavaseelan, S. Jafari, C. Ozel and M. A. Al-Shumrani. **Generalized neutrosophic contra-continuity** 355

M. Parimala, M. Karthika, R. Dhavaseelan, S. Jafari. **On neutrosophic supra pre-continuous functions in neutrosophic topological spaces**..... 371

Tahir Mahmood, Qaisar Khan, Kifayat Ullah, Naeem Jan. **Single valued neutrosophic finite state machine and switchboard state machine** 384

Said Broumi, Assia Bakali, Mohamed Talea, Florentin Smarandache, Vakkas Uluçay, Mehmet Sahin, Arindam Dey, Mamouni Dhar, Rui-Pu Tan, Ayoub Bahnasse, Surapati Pramanik. **Neutrosophic Sets: An Overview** 403

Vasile Patrascu. **Entropy, neutro-entropy and anti-entropy for neutrosophic information**435

Selçuk Topal, Florentin Smarandache. **A lattice theoretic look: a negated approach to adjectival (intersective, neutrosophic and private) phrases and more** 449

Preface

Neutrosophic set has been derived from a new branch of philosophy, namely Neutrosophy. Neutrosophic set is capable of dealing with uncertainty, indeterminacy and inconsistent information. Neutrosophic set approaches are suitable to modeling problems with uncertainty, indeterminacy and inconsistent information in which human knowledge is necessary, and human evaluation is needed.

Neutrosophic set theory was proposed in 1998 by Florentin Smarandache, who also developed the concept of single valued neutrosophic set, oriented towards real world scientific and engineering applications. Since then, the single valued neutrosophic set theory has been extensively studied in books and monographs introducing neutrosophic sets and its applications, by many authors around the world. Also, an international journal - Neutrosophic Sets and Systems started its journey in 2013.

Single valued neutrosophic sets have found their way into several hybrid systems, such as neutrosophic soft set, rough neutrosophic set, neutrosophic bipolar set, neutrosophic expert set, rough bipolar neutrosophic set, neutrosophic hesitant fuzzy set, etc. Successful applications of single valued neutrosophic sets have been developed in multiple criteria and multiple attribute decision making.

This second volume collects original research and application papers from different perspectives covering different areas of neutrosophic studies, such as decision making, graph theory, image processing, probability theory, topology, and some theoretical papers.

This volume contains four sections: DECISION MAKING, NEUTROSOPHIC GRAPH THEORY, IMAGE PROCESSING, ALGEBRA AND OTHER PAPERS.

First paper (*Pu Ji, Peng-fei Cheng, Hongyu Zhang, Jianqiang Wang. Interval valued neutrosophic Bonferroni mean operators and the application in the selection of renewable energy*) aims to construct selection approaches for renewable energy considering the interrelationships among criteria. To do that, Bonferroni mean (BM) and geometric BM (GBM) are employed.

Gathering the attitudes of the examined respondents would be very significant in some evaluation models. Therefore, an approach to the evaluation of websites based on the use of the neutrosophic set is proposed in the second paper (*Dragisa Stanujkic, Florentin Smarandache, Edmundas Kazimieras Zavadskas, Darjan Karabasevic. An approach to measuring the website quality based on neutrosophic sets*). An example of websites evaluation is considered at the end of the paper with the aim to present in detail the proposed approach.

In the third paper (*Generalized Single Valued Triangular Neutrosophic Numbers and Aggregation Operators for Application to Multi-attribute Group Decision Making*), the authors (*Mehmet Şahin, Abdullah Kargın, Florentin Smarandache*) define the generalizing single valued triangular neutrosophic number. In addition, single valued neutrosophic numbers are transformed into single valued triangular neutrosophic numbers according to the values of truth, indeterminacy and falsity.

The fourth paper (*Some weighted arithmetic operators and geometric operators with SVNSSs and their application to multi-criteria decision making problems*, by *Mehmet Şahin*,

Vakkas Uluçay, Hatice Acioğlu) introduces an approach to handle multi-criteria decision making (MCDM) problems under the SVNSSs.

Pranab Biswas, Surapati Pramanik, Bibhas C. Giri present in the fifth paper (*Multi-attribute group decision making based on expected value of neutrosophic trapezoidal numbers*) an expected value based method for multiple attribute group decision making (MAGDM), where the preference values of alternatives and the importance of attributes are expressed in terms of neutrosophic trapezoidal numbers (NTrNs).

Multi-criteria group decision making (MCGDM) strategy, which consists of a group of experts acting collectively for best selection among all possible alternatives with respect to some criteria, is focused on in the sixth paper (*Multi-criteria group decision making based on linguistic refined neutrosophic strategy*, by *Kalyan Mondal, Surapati Pramanik, Bibhas C. Giri*).

Classical TODIM method works on crisp numbers to solve multi-attribute group decision making problems. In the seventh paper (*TODIM Method for Group Decision Making under Bipolar Neutrosophic Set Environment*), the authors (*Surapati Pramanik, Shyamal Dalapati, Shariful Alam, Tapan Kumar Roy*) define TODIM method in bipolar neutrosophic set environment to handle multi-attribute group decision making problems, which means they combine the TODIM with bipolar neutrosophic number to deal with multi-attribute group decision making problems.

The next paper (*Surapati Pramanik, Partha Pratim Dey, Bibhas C. Giri. Hybrid vector similarity measure of single valued refined neutrosophic sets to multi-attribute decision making problems*) proposes hybrid vector similarity measures under single valued refined neutrosophic sets and proves some of its basic properties. The proposed similarity measure is then applied for solving multiple attribute decision making problems.

In the ninth paper (*Multi criteria decision making based on projection and bidirectional projection measures of rough neutrosophic sets*), the authors (*Surapati Pramanik, Rumi Roy, Tapan Kumar Roy*) define projection and bidirectional projection measures between rough neutrosophic sets. Then two new multi criteria decision making methods are proposed based on neutrosophic projection and bidirectional projection measures respectively.

In the tenth paper (*Bipolar complex neutrosophic graphs of type 1*), the authors (*Said Broumi, Assia Bakali, Mohamed Talea, Florentin Smarandache, V. Venkateswara Rao*) introduce a new neutrosophic graphs called bipolar complex neutrosophic graphs of type1 (BCNG1) and present a matrix representation, studying some properties of this new concept.

The eleventh paper (*Chalapathi, R. V. M. S. S. Kiran Kumar, Florentin Smarandache. Neutrosophic invertible graphs of neutrosophic rings*) begins by considering some properties of the self and mutual additive inverse elements of finite Neutrosophic rings, then proceeding to determine several properties of Neutrosophic invertible graphs and obtaining an interrelation between classical rings, Neutrosophic rings and their Neutrosophic invertible graphs.

In the next article (*Interval valued neutrosophic soft graphs*), the authors (*Said Broumi, Assia Bakali, Mohamed Talea, Florentin Smarandache, Faruk Karaaslan*) combine the interval valued neutrosophic soft set and graph theory. They introduce the notions of interval valued neutrosophic soft graphs, strong interval valued neutrosophic graphs, complete interval valued neutrosophic graphs, and investigate some of their related properties.

The aim of the following paper (*A.A. Salama, Mohamed Eisa, Hewayda ElGhawalby, A. E. Fawzy. Neutrosophic image retrieval with hesitancy degree*) is to present texture features for images embedded in the neutrosophic domain with Hesitancy degree. The goal is to extract a set of features to represent the content of each image in the training database to be used for the purpose of retrieving images from the database similar to the image under consideration.

Furthermore, in the Algebra section, *R. Dhavaseelan* and *S. Jafari* introduce the concept of *Generalized neutrosophic closed set* (also the title of the paper), and from there other concepts, such as: generalized neutrosophic continuous mapping, generalized neutrosophic irresolute mapping, strongly neutrosophic continuous mapping, perfectly neutrosophic continuous mapping, strongly generalized neutrosophic continuous mapping and perfectly generalized neutrosophic continuous mapping.

In the paper *Bipolar neutrosophic soft expert set theory*, *Mehmet Şahin, Vakkas Uluçay*, and *Said Broumi* introduce for the first time the concept of bipolar neutrosophic soft expert set and its operations; also, the concept of bipolar neutrosophic soft expert set and its basic operations, namely complement, union and intersection.

In the paper *On neutrosophic α -supra open sets and neutrosophic α -supra continuous functions*, *R. Dhavaseelan, M. Ganster, S. Jafari* and *M. Parimala* introduce and investigate a new class of sets and functions between supra topological spaces called neutrosophic α -supra open set and neutrosophic α -supra continuous function.

The paper *Neutrosophic contra-continuous multi-functions*, by *S. Jafari* and *N. Rajesh*, is devoted to the concepts of neutrosophic upper and neutrosophic lower contra-continuous multifunctions; some of their characterizations are considered.

Generalized neutrosophic set is introduced and applied to BCK/BCI-algebras in the paper *A novel extension of neutrosophic sets and its application in BCK/BCI-algebras*, by *Seok-Zun Song, Madad Khan, Florentin Smarandache*, and *Young Bae Jun*. Characterizations of generalized neutrosophic subalgebra/ideal are considered. Relation between generalized neutrosophic subalgebra and generalized neutrosophic ideal is discussed.

In the following paper (*Neutrosophic resolvable and neutrosophic irresolvable spaces*), the concepts of neutrosophic resolvable, neutrosophic irresolvable, neutrosophic open hereditarily irresolvable spaces and maximally neutrosophic irresolvable spaces are introduced. Also, the authors *M. Caldas, R. Dhavaseelan, M. Ganster, S. Jafari* study several properties of the neutrosophic open hereditarily irresolvable spaces besides giving characterization of these spaces by means of somewhat neutrosophic continuous functions and somewhat neutrosophic open functions.

R. Dhavaseelan, S. Jafari, R. M. Latif, F. Smarandache introduce in another paper (*Neutrosophic rare α -continuity*) the concepts of neutrosophic rare α -continuous, neutrosophic rarely continuous, neutrosophic rarely pre-continuous, neutrosophic rarely semi-continuous, and study them in light of the concept of rare set in neutrosophic setting.

In the next paper (*Neutrosophic semi-continuous multifunctions*), the authors *R. Dhavaseelan, S. Jafari, N. Rajesh, F. Smarandache* introduce the concepts of neutrosophic upper and neutrosophic lower semi-continuous multifunctions and study some of their basic properties.

The concepts of generalized neutrosophic contra-continuous function, generalized neutrosophic contra-irresolute function and strongly generalized neutrosophic contra-continuous function are introduced, and some interesting properties are also studied in the paper *Generalized neutrosophic contra-continuity*, by R. Dhavaseelan, S. Jafari, C. Ozel and M. A. Al-Shumrani.

In the paper *On neutrosophic supra pre-continuous functions in neutrosophic topological spaces*, M. Parimala, M. Karthika, R. Dhavaseelan, S. Jafari introduce and investigate a new class of sets and functions between topological space called neutrosophic supra pre-continuous functions. Furthermore, the concepts of neutrosophic supra pre-open maps and neutrosophic supra pre-closed maps in terms of neutrosophic supra pre-open sets and neutrosophic supra pre-closed sets, respectively, are introduced and several properties of them are investigated.

Using single valued neutrosophic set, Tahir Mahmood, Qaisar Khan, Kifayat Ullah, Naeem Jan introduce in the following paper, *Single valued neutrosophic finite state machine and switchboard state machine*, the notions of single valued neutrosophic finite state machine, single valued neutrosophic successor, single valued neutrosophic subsystem and single valued submachine, single valued neutrosophic switchboard state machine, homomorphism and strong homomorphism between single valued neutrosophic switchboard state machine, and discuss some related results and properties.

In an extensive study, *Neutrosophic Sets: An Overview*, by Said Broumi, Assia Bakali, Mohamed Talea, Florentin Smarandache, Vakkas Uluçay, Mehmet Sahin, Arindam Dey, Mamouni Dhar, Rui-Pu Tan, Ayoub Bahnasse, and Surapati Pramanik give some concepts concerning the neutrosophic sets, single valued neutrosophic sets, interval-valued neutrosophic sets, bipolar neutrosophic sets, neutrosophic hesitant fuzzy sets, interval-valued neutrosophic hesitant fuzzy sets, refined neutrosophic sets, bipolar neutrosophic refined sets, multi-valued neutrosophic sets, simplified neutrosophic linguistic sets, neutrosophic over/off/under sets, rough neutrosophic sets, rough bipolar neutrosophic sets, rough neutrosophic hyper-complex set, and their basic operations. Then, they introduce triangular neutrosophic numbers, trapezoidal neutrosophic fuzzy number and their basic operations. Also some comparative studies between the existing neutrosophic sets and neutrosophic number are provided.

In the article *Entropy, neutro-entropy and anti-entropy for neutrosophic information*, Vasile Patrascu shows a deca-valued representation of neutrosophic information. For this representation the following neutrosophic features were defined and used: truth, falsity, weak truth, weak falsity, ignorance, contradiction, saturation, neutrality, ambiguity and hesitation.

In the final article (*A lattice theoretic look: a negated approach to adjectival (intersective, neutrosophic and private) phrases and more*), authored by Selçuk Topal and Florentin Smarandache, some new negations of intersective adjectival phrases and their set-theoretic semantics such as non-red non-cars and red non-cars are presented. A lattice structure is built on positive and negative nouns and their positive and negative intersective adjectival phrases. These lattice classes are called Neutrosophic Linguistic Lattices (NLL).

Florentin Smarandache, Surapati Pramanik

Decision Making

Interval-Valued Neutrosophic Bonferroni Mean Operators and the Application in the Selection of Renewable Energy

Pu Ji¹, Peng-fei Cheng², Hong-yu Zhang^{3*}, and Jian-qiang Wang⁴

¹ School of Business, Central South University, Changsha 410083, China. E-mail: jipu90@csu.edu.cn

² School of Business, Hunan University of Science and Technology, Xiangtan 411201, China. E-mail: 1180033@hnust.edu.cn

³ School of Business, Central South University, Changsha 410083, China. E-mail: hyzhang@csu.edu.cn

⁴ School of Business, Central South University, Changsha 410083, China. E-mail: jqwang@csu.edu.cn

Corresponding author's email^{3*}: hyzhang@csu.edu.cn

ABSTRACT

Renewable energy selection, which is a multi-criteria decision-making (MCDM) problem, is crucial for the sustainable development of economy. Criteria are interdependent in the selection problem of renewable energy. Moreover, fuzzy and uncertain information exist during the selection processes, and information can be comprehensively reflected by interval-valued neutrosophic sets. This chapter aims to construct selection approaches for renewable energy considering the interrelationships among criteria. To do that, Bonferroni mean (BM) and geometric BM (GBM) are employed. Firstly, the interval-valued neutrosophic BM (IVNBM) and the interval-valued neutrosophic GBM (IVNGBM) are proposed as extensions of BM and GBM, respectively. Then, to take into consideration the relative importance of each element, the interval-valued neutrosophic weighted BM (IVNWBM) and the interval-valued neutrosophic weighted GBM (IVNWGBM) are further defined. Subsequently, the novel MCDM approaches for the selection of renewable energy, which are in view of the interrelationships among elements, are explored based on the IVNWBM and IVNWGBM operator. Furthermore, the applicability of the proposed approaches is demonstrated by a numerical example about the selection of renewable energy. In addition, the influence of the parameters is investigated and discussed. Finally, a comparative analysis composed of two cases verifies the feasibility of the proposed MCDM approaches.

KEYWORDS: multi-criteria decision-making; interval-valued neutrosophic set; weighted Bonferroni mean; weighted geometric Bonferroni mean; renewable energy selection

1. INTRODUCTION

Renewable energy has been replacing traditional non-renewable energy owing to the limitation of the latter and environmental protection. Renewable energy is energy that can be circularly regenerated in nature. It mainly includes solar energy, wind energy, biomass energy, tidal energy and ocean thermal energy, just name a few. Many researchers have been studying the selection problem of renewable energy (Mardani, Jusoh, Zavadskas, Cavallaro, & Khalifah, 2015; Troldborg, Heslop, & Hough, 2014). Some of them pointed out that the selection of renewable energy is a multi-criteria decision-making (MCDM) problem (Cristóbal, 2011; Yazdani-Chamzini, Fouladgar, Zavadskas, & Moini, 2013). Experts assess renewable energy with regard to several criteria including power of energy, investment ratio and emissions of carbon dioxide (CO₂) avoided per year and so forth. The most proper renewable energy can be selected on the basis of the assessment information provided by experts. Because it becomes difficult for decision-makers to identify an optimal alternative that maximizes all decision criteria, a multi-objective approach is required to examine tradeoffs considering each criterion. Kaya and Kahraman (Kaya & Kahraman, 2010) proposed a modified fuzzy VIKOR methodology to make a multi-criteria selection among alternative renewable energy options and production sites for Istanbul area using an integrated VIKOR-AHP methodology.

Fuzziness and uncertainty may exist in the assessment information due to the complexity and limitation of human cognition and sometimes the criteria are interdependent. For example, an expert may be uncertain about the upper bound of the power of an individual renewable energy. However, fuzzy and uncertain information do not be fully utilized in extant approaches of the selection of renewable energy. Especially, the interrelationships among criteria are not considered in the extant approaches. Therefore, novel MCDM approaches are required. In this paper, we propose selection approaches for renewable energy considering the interrelationships among criteria. To do that, Bonferroni mean (BM) and geometric BM (GBM) are employed. To take into consideration the relative importance of each element, we further define the interval-valued neutrosophic weighted BM (IVNWBM) and the interval-valued neutrosophic weighted GBM (IVNWGBM). Subsequently, the novel MCDM approaches for the selection of renewable energy, which are in view of the interrelationships among elements, are explored based on the IVNWBM and IVNWGBM operator.

The remainder of this paper is organized as follows. In Section 2, we review the applications of MCDM in renewable energy selection. What's more, neutrosophic set (NS) and BM are reviewed in this section. In Section 3, the definition and some properties of IVNGBM and IVNWGBM are investigated, based on which, novel MCDM approaches for the selection of renewable energy with interval-valued neutrosophic numbers (IVNNs) are presented. In order to demonstrate the application and verify the feasibility of the proposed MCDM approaches, a numerical example and a comparative analysis are conducted and discussed in Section 4. In addition, it also discusses the influence of parameters in IVNGBM and IVNWGBM on the proposed MCDM approaches. Finally, Section 5 concludes this paper and suggests several directions for future research.

2. LITERATURE REVIEW

Since FS was proposed by Zadeh (L. A. Zadeh, 1965) in 1965, it has become a vital tool to construct MCDM approaches (Aghdaie, Zolfani, & Zavadskas, 2013; Bellman & Zadeh, 1970; Yager, 1977). After that, many researchers have been devoting themselves to handling with the imprecise, incomplete and uncertain information and have put forward numerous extensions of FS (Cao, Zhou, & Wang, 2016; H.-g. Peng & Wang, 2016; Turksen, 1986; Lotfi Asker Zadeh, 1968). Particularly, Florentin Smarandache (Smarandache, 1998, 1999) introduced the neutrosophic logic and the NS.

2.1 NEUTROSOPHIC SET (NS)

NS makes use of the functions of truth, indeterminacy and falsity to depict the fuzzy information. And the values of these three functions lie in $]0^-, 1^+[$, the non-standard unit interval (Rivieccio, 2008), which is the extension to the standard interval $[0, 1]$ of IFS. The indeterminacy factor here is impervious to truth and falsity values while the incorporated uncertainty in IFS rests with the degrees of belongingness and non-belongingness (Majumdar & Samanta, 2014). Nevertheless, it is difficult to apply NS in realistic problems. Hence, Wang *et al.* (H. B. Wang, Smarandache, Zhang, & Sunderraman, 2010) defined the single-valued neutrosophic set (SVNS) and Ye (Ye, 2014) put forward the notion of the simplified neutrosophic set (SNS), which are both instances of NS. In addition, manifold MCDM approaches have been developed under single-valued neutrosophic environments and simplified neutrosophic environments (Ji, Wang, & Zhang, 2016; Liu & Wang, 2014; J. J. Peng, Wang, Wang, Zhang, & Chen, 2016; J. J. Peng, Wang, Zhang, & Chen, 2014; Şahin & Liu, 2016; Wu, Wang, Peng, & Chen, 2016; Ye, 2013).

In the light of that it is more practicable to utilize interval numbers to describe the degrees of truth, falsity and indeterminacy about a certain statement in some circumstances rather than exact numbers, Wang *et al.* (H. B. Wang, Smarandache, Zhang, & Sunderraman, 2005) put forward the concept of the interval-valued neutrosophic set (IVNS) and presented the set-theoretic operators of IVNS. Other than NSs, the degrees of truth, indeterminacy and falsity of IVNSs are interval numbers. Up to now, plenty of MCDM approaches utilizing IVNS have been put forward (Chi & Liu, 2013; Şahin & Karabacak, 2015; Z. Tian, Zhang, Wang, Wang, & Chen, 2016; H. Zhang, Ji, Wang, & Chen, 2015; H. Zhang, Wang, & Chen, 2016) and IVNSs have been applied in addressing practical problems (H. Ma, Hu, Li, & Zhang, 2016). Furthermore, studies about other extensions of NSs have been investigated (Z. P. Tian, Wang, Zhang, &

Wang, 2016; Hong Yu Zhang, Ji, Wang, & Chen, 2016), like multi-valued neutrosophic sets (Ji, Zhang, & Wang, 2016; J.-j. Peng, Wang, Wu, Wang, & Chen, 2015; J. Peng, Wang, & Yang, 2017), single valued trapezoidal neutrosophic sets (Liang, Wang, & Li, 2016), n-valued refined neutrosophic sets (Smarandache, 2013) and neutrosophic linguistic sets (Y. X. Ma, Wang, Wang, & Wu, 2016; Z. P. Tian, Wang, Wang, & Zhang, 2016a, 2016b; J. Q. Wang, Yang, & Li, 2016).

The score function and accuracy function of IVNNs have been given as well as the comparative method of two IVNNs, which make it practical.

Definition 1 (Şahin, 2014). Let $A = \langle [\inf T_A, \sup T_A], [\inf I_A, \sup I_A], [\inf F_A, \sup F_A] \rangle$ be an IVNN, a score function L of A can be defined by

$$L(A) = \frac{2 + \inf T_A + \sup T_A - 2\inf I_A - 2\sup I_A - \inf F_A - \sup F_A}{4} \quad (1)$$

where $L(A) \in [-1, 1]$.

Definition 2 (Şahin, 2014). Let $A = \langle [\inf T_A, \sup T_A], [\inf I_A, \sup I_A], [\inf F_A, \sup F_A] \rangle$ be an IVNN, an accuracy function N of A can be defined by

$$N(A) = \frac{1}{2} \left[\inf T_A + \sup T_A - \inf I_A \times (1 - \inf T_A) - \sup I_A \times (1 - \sup T_A) - \inf F_A \times (1 - \inf I_A) - \sup F_A \times (1 - \sup I_A) \right], \quad (2)$$

where $N(A) \in [-1, 1]$.

Definition 3 (Şahin, 2014). Suppose that $A = \langle [\inf T_A, \sup T_A], [\inf I_A, \sup I_A], [\inf F_A, \sup F_A] \rangle$ and $B = \langle [\inf T_B, \sup T_B], [\inf I_B, \sup I_B], [\inf F_B, \sup F_B] \rangle$ be two IVNNs. The comparative method of A and B can be defined as follows:

- (i). When $L(A) > L(B)$, $A \succ B$; and
- (ii). When $L(A) = L(B)$ and $N(A) > N(B)$, $A \succ B$.

Definition 4 (H. Y. Zhang, Wang, & Chen, 2014). Let $A = \langle [\inf T_A, \sup T_A], [\inf I_A, \sup I_A], [\inf F_A, \sup F_A] \rangle$ and $B = \langle [\inf T_B, \sup T_B], [\inf I_B, \sup I_B], [\inf F_B, \sup F_B] \rangle$ be any two IVNNs and $\lambda > 0$. The operations are defined as follows:

- (1) $A + B = \langle [\inf T_A + \inf T_B - \inf T_A \cdot \inf T_B, \sup T_A + \sup T_B - \sup T_A \cdot \sup T_B], [\inf I_A \cdot \inf I_B, \sup I_A \cdot \sup I_B], [\inf F_A \cdot \inf F_B, \sup F_A \cdot \sup F_B] \rangle$;
 - (2) $A \cdot B = \langle [\inf T_A \cdot \inf T_B, \sup T_A \cdot \sup T_B], [\inf I_A + \inf I_B - \inf I_A \cdot \inf I_B, \sup I_A + \sup I_B - \sup I_A \cdot \sup I_B], [\inf F_A + \inf F_B - \inf F_A \cdot \inf F_B, \sup F_A + \sup F_B - \sup F_A \cdot \sup F_B] \rangle$;
 - (3) $\lambda A = \langle [1 - (1 - \inf T_A)^\lambda, 1 - (1 - \sup T_A)^\lambda], [(\inf I_A)^\lambda, (\sup I_A)^\lambda], [(\inf F_A)^\lambda, (\sup F_A)^\lambda] \rangle$;
 - (4) $A^\lambda = \langle [(\inf T_A)^\lambda, (\sup T_A)^\lambda], [1 - (1 - \inf I_A)^\lambda, 1 - (1 - \sup I_A)^\lambda], [1 - (1 - \inf F_A)^\lambda, 1 - (1 - \sup F_A)^\lambda] \rangle$;
- and
- (5) $neg(A) = \langle [\inf F_A, \sup F_A], [1 - \sup I_A, 1 - \inf I_A], [\inf T_A, \sup T_A] \rangle$.

2.2 Multi-criteria decision-making (MCDM)

The applications of the extensions of FSs have attracted considerable researchers' attention (Joshi & Kumar, 2012; J. J. Peng, Wang, Wang, Yang, & Chen, 2015; Shinoj & Sunil, 2012; J. Q. Wang, Han, & Zhang, 2014; J. Q. Wang, Wu, Wang, Zhang, & Chen, 2016; X.-Z. Wang et al., 2015), not excepting the researchers in energy. Wang *et al.* (B. Wang, Nistor, Murty, & Wei, 2014) using the TOPSIS (the

Technique for Order Preference by Similarity to Ideal Solution) approach, one of the branches of MCDM models, assessed the efficiency of hydropower generation in Canada. Khalili-Damghani *et al.* (Khalili-Damghani, M., Santos-Arteaga, & Mohtasham, 2015) proposed a dynamic multi-stage approach to evaluate the efficiency of cotton production energy consumption by utilizing data envelopment analysis, a tool of MCDM. Additionally, critical reviews of MCDM approaches have been done to survey MCDM models, techniques and their empirical applications in various fields (Ananda & Herath, 2009; Govindan, Rajendran, Sarkis, & Murugesan, 2015; Ho, Xu, & Dey, 2010).

As an important tool in constructing MCDM approaches, the aggregation operator captures widespread attention and some researches about the aggregation operator have been done under interval-valued neutrosophic environments. Zhang *et al.* (H. Y. Zhang *et al.*, 2014) proposed the interval-valued neutrosophic weighted average (IVNWA) operator and the interval-valued neutrosophic weighted geometric average (IVNWG) operator. Based on these two aggregation operators, Ye (Ye, 2014) defined the ordered weighted average operator and the ordered weighted geometric averaging operator for IVNSs.

All the aggregation operators mentioned above suppose that the elements integrated are mutually independent. In theory, the criteria in a MCDM problem should satisfy the requirement of independence. However, in some realistic MCDM problems like the selection of renewable energy, the criteria are correlative, in which the aggregation operators illustrated above become inapplicable. For instance, power, investment ratio, operation and maintenance cost and operating hours are four of the criteria in the selection of renewable energy and they are not independent. In the example, as known to all, investment ratio may be affected by power, and operation and maintenance cost may be bound up with operating hours. In order to overcome this deficiency and take into account the interrelationships among criteria, the Bonferroni mean (BM) is introduced.

2.3 Bonferroni mean (BM)

BM, firstly put forward by Bonferroni in Ref. (Bonferroni, 1950), has been extended to several kinds of FSs. For instance, Xu and Yager (Xu & Yager, 2011) defined the intuitionistic fuzzy BM (IFBM) and the intuitionistic fuzzy weighted BM (IFWBM) according to previous studies about BM and the weighted BM (WBM). Moreover, Xia *et al.* (Xia, Xu, & Zhu, 2012) investigated the generalized BM, which is proposed by Beliakov (Beliakov, James, Mordelová, Rückschlossová, & Yager, 2010), under intuitionistic fuzzy environments and developed the generalized WBM and the generalized intuitionistic fuzzy WBM. Furthermore, Zhou and He (Zhou & He, 2012) pointed out some drawbacks of WBM. To conquer these drawbacks, they proposed a novel WBM operator, which is called the normal WBM (NWBM). Based on BM, Xia *et al.* (Xia, Xu, & Zhu, 2013) defined geometric BM (GBM) and introduced the intuitionistic fuzzy GBM (IFGBM) and the weighted IFGBM (WIFGBM). And they also discussed some properties of IFGBM. On the basis of GBM in Ref. (Xia *et al.*, 2013), Zhu *et al.* (Zhu & Xu, 2013) explored the GBM under hesitant fuzzy environments and put forward the hesitant fuzzy GBM (HFGBM) and the hesitant fuzzy Choquet GBM (HFCGBM). In addition, Liu and Wang (Liu & Wang, 2014) extended NWBM to aggregate single-valued neutrosophic numbers (SVNNs) and defined the single-valued neutrosophic BM (SVNBM) and the single-valued neutrosophic NWBM. Besides, many other extensions of BM have been developed (Z. P. Tian, Wang, Wang, & Chen, 2015; Z. P. Tian, Wang, Zhang, Chen, & Wang, 2015) and applied to tackle practical problems (Hong Yu Zhang, Ji, Wang, & Chen, 2017).

IVNSs can more comprehensively express fuzzy and uncertain information during the processes of selecting renewable energy than other extensions of NSs like SVNSs. Moreover, criteria may be correlative in the selection problems of renewable energy. For solving such problems in selecting renewable energy, we intend to introduce BM. Nevertheless, to the best of our knowledge, BM has not been studied under interval-valued neutrosophic environments. To overcome this deficiency, in the first place, we propose the interval-valued neutrosophic BM (IVNBM) and the interval-valued neutrosophic GBM (IVNGBM). Considering that IVNBM and IVNGBM do not take into account the relative importance of each element, the interval-valued neutrosophic WBM (IVNWBM) and the interval-valued neutrosophic weighted GBM (IVNWGBM) are also put forward in this study. Additionally, novel MCDM approaches for the selection of renewable energy are constructed based on the proposed aggregation operators.

3. MCDM APPROACHES FOR THE SELECTION OF RENEWABLE ENERGY

In this section, based on SVNBM in Ref. (Liu & Wang, 2014), the definition of IVNBM and IVNGBM are put forward based on previous studies about IVIFBM and SVNBM. However, IVNBM and IVNGBM do not take into consideration the relative importance of each IVNN. IVNWBM and IVNWGBM are proposed in order to conquer this disadvantage. In addition, some properties of IVNBM and IVNGBM are investigated. Based on the proposed aggregation operators, novel MCDM approaches for the selection of renewable energy are constructed and the procedures are discussed in this section.

3.1 IVNBM

Definition 5. Let $p, q \geq 0$ and $x_i = \langle [T_i^-, T_i^+], [I_i^-, I_i^+], [F_i^-, F_i^+] \rangle$ ($i=1,2,\dots,n$) be a collection of IVNNs. IVNBM can be defined as:

$$IVNBM^{p,q}(x_1, x_2, \dots, x_n) = \left(\frac{1}{n(n-1)} \bigoplus_{\substack{i,j=1 \\ i \neq j}}^n (x_i^p \otimes x_j^q) \right)^{\frac{1}{p+q}}. \quad (3)$$

Theorem 1. Let $p, q \geq 0$ and $x_i = \langle [T_i^-, T_i^+], [I_i^-, I_i^+], [F_i^-, F_i^+] \rangle$ ($i=1,2,\dots,n$) be a collection of IVNNs. The aggregated value by IVNBM in (3) is also an IVNN, and

$$IVNBM^{p,q}(x_1, x_2, \dots, x_n) = \left\langle \left[\left(1 - \prod_{\substack{i,j=1 \\ i \neq j}}^n \left(1 - (T_i^-)^p (T_j^-)^q \right)^{\frac{1}{n(n-1)}} \right)^{\frac{1}{p+q}}, \left(1 - \prod_{\substack{i,j=1 \\ i \neq j}}^n \left(1 - (T_i^+)^p (T_j^+)^q \right)^{\frac{1}{n(n-1)}} \right)^{\frac{1}{p+q}} \right], \right. \\ \left. \left[1 - \left(1 - \prod_{\substack{i,j=1 \\ i \neq j}}^n \left(1 - (1 - I_i^-)^p (1 - I_j^-)^q \right)^{\frac{1}{n(n-1)}} \right)^{\frac{1}{p+q}}, 1 - \left(1 - \prod_{\substack{i,j=1 \\ i \neq j}}^n \left(1 - (1 - I_i^+)^p (1 - I_j^+)^q \right)^{\frac{1}{n(n-1)}} \right)^{\frac{1}{p+q}} \right], \right. \\ \left. \left[1 - \left(1 - \prod_{\substack{i,j=1 \\ i \neq j}}^n \left(1 - (1 - F_i^-)^p (1 - F_j^-)^q \right)^{\frac{1}{n(n-1)}} \right)^{\frac{1}{p+q}}, 1 - \left(1 - \prod_{\substack{i,j=1 \\ i \neq j}}^n \left(1 - (1 - F_i^+)^p (1 - F_j^+)^q \right)^{\frac{1}{n(n-1)}} \right)^{\frac{1}{p+q}} \right] \right\rangle. \quad (4)$$

Proof.

According to the operations (2) and (4) in Definition 4, we have $x_i^p = \langle [(T_i^-)^p, (T_i^+)^p], [1 - (1 - I_i^-)^p, 1 - (1 - I_i^+)^p], [1 - (1 - F_i^-)^p, 1 - (1 - F_i^+)^p] \rangle$, $x_j^q = \langle [(T_j^-)^q, (T_j^+)^q], [1 - (1 - I_j^-)^q, 1 - (1 - I_j^+)^q], [1 - (1 - F_j^-)^q, 1 - (1 - F_j^+)^q] \rangle$ and $x_i^p \otimes x_j^q = \langle [(T_i^-)^p \cdot (T_j^-)^q, (T_i^+)^p \cdot (T_j^+)^q], [1 - (1 - I_i^-)^p (1 - I_j^-)^q, 1 - (1 - I_i^+)^p (1 - I_j^+)^q], [1 - (1 - F_i^-)^p (1 - F_j^-)^q, 1 - (1 - F_i^+)^p (1 - F_j^+)^q] \rangle$. Let $a_{ij} = \langle [T_{ij}^-, T_{ij}^+], [I_{ij}^-, I_{ij}^+], [F_{ij}^-, F_{ij}^+] \rangle = (w_i x_i)^p \otimes (w_j x_j)^q$, $IVNWBM^{p,q}(x_1, x_2, \dots, x_n) = \left(\frac{1}{n(n-1)} \bigoplus_{\substack{i,j=1 \\ i \neq j}}^n ((w_i x_i)^p \otimes (w_j x_j)^q) \right)^{\frac{1}{p+q}} = \left(\frac{1}{n(n-1)} \bigoplus_{\substack{i,j=1 \\ i \neq j}}^n (\alpha_{ij}) \right)^{\frac{1}{p+q}}$. According to the operational laws (1) and (3) in Definition 4, $\frac{1}{n(n-1)} \bigoplus_{\substack{i,j=1 \\ i \neq j}}^n (\alpha_{ij}) =$

$$\left\langle \left[1 - \prod_{\substack{i,j=1 \\ i \neq j}}^n (1 - T_{ij}^-)^{\frac{1}{n(n-1)}}, 1 - \prod_{\substack{i,j=1 \\ i \neq j}}^n (1 - T_{ij}^+)^{\frac{1}{n(n-1)}} \right], \left[\prod_{\substack{i,j=1 \\ i \neq j}}^n (I_{ij}^-)^{\frac{1}{n(n-1)}}, \prod_{\substack{i,j=1 \\ i \neq j}}^n (I_{ij}^+)^{\frac{1}{n(n-1)}} \right], \left[\prod_{\substack{i,j=1 \\ i \neq j}}^n (F_{ij}^-)^{\frac{1}{n(n-1)}}, \prod_{\substack{i,j=1 \\ i \neq j}}^n (F_{ij}^+)^{\frac{1}{n(n-1)}} \right] \right\rangle .$$

Therefore,
$$IVNWBM^{p,q}(x_1, x_2, \dots, x_n) = \left(\frac{1}{n(n-1)} \bigoplus_{\substack{i,j=1 \\ i \neq j}}^n (\alpha_{ij}) \right)^{\frac{1}{p+q}} = \left\langle \left[1 - \prod_{\substack{i,j=1 \\ i \neq j}}^n (1 - T_{ij}^-)^{\frac{1}{n(n-1)}} \right]^{\frac{1}{p+q}}, \right.$$

$$\left. \left[1 - \prod_{\substack{i,j=1 \\ i \neq j}}^n (1 - T_{ij}^+)^{\frac{1}{n(n-1)}} \right]^{\frac{1}{p+q}} \right], \left[1 - \left(1 - \prod_{\substack{i,j=1 \\ i \neq j}}^n (I_{ij}^-)^{\frac{1}{n(n-1)}} \right)^{\frac{1}{p+q}}, 1 - \left(1 - \prod_{\substack{i,j=1 \\ i \neq j}}^n (I_{ij}^+)^{\frac{1}{n(n-1)}} \right)^{\frac{1}{p+q}} \right], \left[1 - \left(1 - \prod_{\substack{i,j=1 \\ i \neq j}}^n (F_{ij}^-)^{\frac{1}{n(n-1)}} \right)^{\frac{1}{p+q}}, \right.$$

$$\left. 1 - \left(1 - \prod_{\substack{i,j=1 \\ i \neq j}}^n (F_{ij}^+)^{\frac{1}{n(n-1)}} \right)^{\frac{1}{p+q}} \right] \right\rangle = \left\langle \left[1 - \left(\prod_{\substack{i,j=1 \\ i \neq j}}^n (1 - (T_i^-)^p (T_j^-)^q) \right)^{\frac{1}{n(n-1)}} \right]^{\frac{1}{p+q}}, \left[1 - \left(\prod_{\substack{i,j=1 \\ i \neq j}}^n (1 - (T_i^+)^p (T_j^+)^q) \right)^{\frac{1}{n(n-1)}} \right]^{\frac{1}{p+q}} \right],$$

$$\left[1 - \left(1 - \left(\prod_{\substack{i,j=1 \\ i \neq j}}^n (1 - (1 - I_i^-)^p (1 - I_j^-)^q) \right)^{\frac{1}{n(n-1)}} \right)^{\frac{1}{p+q}}, 1 - \left(1 - \left(\prod_{\substack{i,j=1 \\ i \neq j}}^n (1 - (1 - I_i^+)^p (1 - I_j^+)^q) \right)^{\frac{1}{n(n-1)}} \right)^{\frac{1}{p+q}} \right],$$

$$\left. \left[1 - \left(1 - \left(\prod_{\substack{i,j=1 \\ i \neq j}}^n (1 - (1 - F_i^-)^p (1 - F_j^-)^q) \right)^{\frac{1}{n(n-1)}} \right)^{\frac{1}{p+q}}, 1 - \left(1 - \left(\prod_{\substack{i,j=1 \\ i \neq j}}^n (1 - (1 - F_i^+)^p (1 - F_j^+)^q) \right)^{\frac{1}{n(n-1)}} \right)^{\frac{1}{p+q}} \right] \right\rangle .$$

Furthermore, the following inequalities are true:

$$0 \leq \left[1 - \left(\prod_{\substack{i,j=1 \\ i \neq j}}^n (1 - (T_i^-)^p (T_j^-)^q) \right)^{\frac{1}{n(n-1)}} \right]^{\frac{1}{p+q}} \leq 1, \quad 0 \leq \left[1 - \left(\prod_{\substack{i,j=1 \\ i \neq j}}^n (1 - (T_i^+)^p (T_j^+)^q) \right)^{\frac{1}{n(n-1)}} \right]^{\frac{1}{p+q}} \leq 1,$$

$$0 \leq 1 - \left[1 - \left(\prod_{\substack{i,j=1 \\ i \neq j}}^n (1 - (1 - I_i^-)^p (1 - I_j^-)^q) \right)^{\frac{1}{n(n-1)}} \right]^{\frac{1}{p+q}} \leq 1, \quad 0 \leq 1 - \left[1 - \left(\prod_{\substack{i,j=1 \\ i \neq j}}^n (1 - (1 - I_i^+)^p (1 - I_j^+)^q) \right)^{\frac{1}{n(n-1)}} \right]^{\frac{1}{p+q}} \leq 1,$$

$$0 \leq 1 - \left[1 - \left(\prod_{\substack{i,j=1 \\ i \neq j}}^n (1 - (1 - F_i^-)^p (1 - F_j^-)^q) \right)^{\frac{1}{n(n-1)}} \right]^{\frac{1}{p+q}} \leq 1 \text{ and } 0 \leq 1 - \left[1 - \left(\prod_{\substack{i,j=1 \\ i \neq j}}^n (1 - (1 - F_i^+)^p (1 - F_j^+)^q) \right)^{\frac{1}{n(n-1)}} \right]^{\frac{1}{p+q}} \leq 1$$

which meets the requirements of an IVNN.

Therefore, Theorem 1 holds.

In the following part, we investigate some properties of IVNBM:

(1) When $x_i = \langle [1,1], [0,0], [0,0] \rangle$ ($i=1,2,\dots,n$), $IVNBM^{p,q}(x_1, x_2, \dots, x_n) = \langle [1,1], [0,0], [0,0] \rangle$.

(2) When $x_i = \langle [0,0], [1,1], [1,1] \rangle$ ($i=1,2,\dots,n$), $IVNBM^{p,q}(x_1, x_2, \dots, x_n) = \langle [0,0], [1,1], [1,1] \rangle$.

(3) (**Idempotency**) When all IVNNs x_i ($i=1,2,\dots,n$) are equal, i.e., $x_i = x$ for all i ,

$$IVNBM^{p,q}(x_1, x_2, \dots, x_n) = x. \quad (5)$$

Proof. Since $x_i = x$ for all i , we can obtain that $IVNBM^{p,q}(x_1, x_2, \dots, x_n) = \left(\frac{1}{n(n-1)} \bigoplus_{\substack{i,j=1 \\ i \neq j}}^n (x_i^p \otimes x_j^q) \right)^{\frac{1}{p+q}} =$

$$\left(\frac{1}{n(n-1)} \bigoplus_{\substack{i,j=1 \\ i \neq j}}^n (x^p \otimes x^q) \right)^{\frac{1}{p+q}} = \left(\frac{1}{n(n-1)} \bigoplus_{\substack{i,j=1 \\ i \neq j}}^n (x^{p+q}) \right)^{\frac{1}{p+q}} = x.$$

(4) (**Monotonicity**) Let $x_i = \langle [T_{x_i}^-, T_{x_i}^+], [I_{x_i}^-, I_{x_i}^+], [F_{x_i}^-, F_{x_i}^+] \rangle$ ($i=1,2,\dots,n$) and $y_i = \langle [T_{y_i}^-, T_{y_i}^+], [I_{y_i}^-, I_{y_i}^+], [F_{y_i}^-, F_{y_i}^+] \rangle$ ($i=1,2,\dots,n$) be two collections of IVNNs. When $T_{x_i}^- \leq T_{y_i}^-$, $T_{x_i}^+ \leq T_{y_i}^+$, $I_{x_i}^- \geq I_{y_i}^-$, $I_{x_i}^+ \geq I_{y_i}^+$, $F_{x_i}^- \geq F_{y_i}^-$ and $F_{x_i}^+ \geq F_{y_i}^+$ for all i ,

$$IVNBM^{p,q}(x_1, x_2, \dots, x_n) \leq IVNBM^{p,q}(y_1, y_2, \dots, y_n). \quad (6)$$

(5) (**Commutativity**) Let (x_1, x_2, \dots, x_n) be any permutation of (x_1, x_2, \dots, x_n) , $IVNBM^{p,q}(x_1, x_2, \dots, x_n) = IVNBM^{p,q}(x_1, x_2, \dots, x_n)$.

(6) (**Boundedness**) Let $x_i = \langle [T_i^-, T_i^+], [I_i^-, I_i^+], [F_i^-, F_i^+] \rangle$ ($i=1,2,\dots,n$) be a collection of IVNNs, and $x^- = \langle [\min_i \{T_i^-\}, \min_i \{T_i^+\}], [\max_i \{I_i^-\}, \max_i \{I_i^+\}], [\max_i \{F_i^-\}, \max_i \{F_i^+\}] \rangle$, $x^+ = \langle [\max_i \{T_i^-\}, \max_i \{T_i^+\}], [\min_i \{I_i^-\}, \min_i \{I_i^+\}], [\min_i \{F_i^-\}, \min_i \{F_i^+\}] \rangle$. We can obtain that $x^- \leq IVNBM^{p,q}(x_1, x_2, \dots, x_n) \leq x^+$.

Proof. Since $x_i \geq x^-$, according to Equation (5) and Inequality (6), we have $IVNBM^{p,q}(x_1, x_2, \dots, x_n) \geq IVNBM^{p,q}(x^-, x^-, \dots, x^-) = x^-$. Likewise, we can obtain that $IVNBM^{p,q}(x_1, x_2, \dots, x_n) \leq IVNBM^{p,q}(x^+, x^+, \dots, x^+) = x^+$. Then, $x^- \leq IVNBM^{p,q}(x_1, x_2, \dots, x_n) \leq x^+$.

In the following part, we discuss some special cases of IVNBM.

1. When $q \rightarrow 0$, from Equation (3) and (4), IVNBM reduces to the generalized interval-valued neutrosophic average (GIVNA) operator as follows:

$$\begin{aligned} \lim_{q \rightarrow 0} IVNBM^{p,q}(x_1, x_2, \dots, x_n) &= \lim_{q \rightarrow 0} \left(\frac{1}{n(n-1)} \bigoplus_{\substack{i,j=1 \\ i \neq j}}^n (x_i^p \otimes x_j^q) \right)^{\frac{1}{p+q}} = \left(\frac{1}{n} \bigoplus_{i=1}^n (x_i^p) \right)^{\frac{1}{p}} \\ &= \left[\left(1 - \prod_{i=1}^n \left(1 - (T_i^-)^p \right)^{\frac{1}{n}} \right)^{\frac{1}{p}}, \left(1 - \prod_{i=1}^n \left(1 - (T_i^+)^p \right)^{\frac{1}{n}} \right)^{\frac{1}{p}} \right], \\ &\quad \left[1 - \left(1 - \prod_{i=1}^n \left(1 - (1 - I_i^-)^p \right)^{\frac{1}{n}} \right)^{\frac{1}{p}}, 1 - \left(1 - \prod_{i=1}^n \left(1 - (1 - I_i^+)^p \right)^{\frac{1}{n}} \right)^{\frac{1}{p}} \right], \\ &\quad \left[1 - \left(1 - \prod_{i=1}^n \left(1 - (1 - F_i^-)^p \right)^{\frac{1}{n}} \right)^{\frac{1}{p}}, 1 - \left(1 - \prod_{i=1}^n \left(1 - (1 - F_i^+)^p \right)^{\frac{1}{n}} \right)^{\frac{1}{p}} \right] \Big] \\ &= IVNBM^{p,0}(x_1, x_2, \dots, x_n). \end{aligned}$$

2. When $p=2$ and $q \rightarrow 0$, IVNBM reduces to the interval-valued neutrosophic square average (IVNSA) operator as follows:

$$\begin{aligned} IVNBM^{2,0}(x_1, x_2, \dots, x_n) &= \left(\frac{1}{n} \bigoplus_{i=1}^n (x_i^2) \right)^{\frac{1}{2}} \\ &= \left[\left(1 - \prod_{i=1}^n \left(1 - (T_i^-)^2 \right)^{\frac{1}{n}} \right)^{\frac{1}{2}}, \left(1 - \prod_{i=1}^n \left(1 - (T_i^+)^2 \right)^{\frac{1}{n}} \right)^{\frac{1}{2}} \right], \\ &\quad \left[1 - \left(1 - \prod_{i=1}^n \left(1 - (1 - I_i^-)^2 \right)^{\frac{1}{n}} \right)^{\frac{1}{2}}, 1 - \left(1 - \prod_{i=1}^n \left(1 - (1 - I_i^+)^2 \right)^{\frac{1}{n}} \right)^{\frac{1}{2}} \right], \\ &\quad \left[1 - \left(1 - \prod_{i=1}^n \left(1 - (1 - F_i^-)^2 \right)^{\frac{1}{n}} \right)^{\frac{1}{2}}, 1 - \left(1 - \prod_{i=1}^n \left(1 - (1 - F_i^+)^2 \right)^{\frac{1}{n}} \right)^{\frac{1}{2}} \right] \Big]. \end{aligned}$$

3. When $p=1$ and $q \rightarrow 0$, IVNBM reduces to the interval-valued neutrosophic average (IVNA) operator as follows:

$$\begin{aligned} IVNBM^{1,0}(x_1, x_2, \dots, x_n) &= \frac{1}{n} \bigoplus_{i=1}^n (x_i) \\ &= \left[\left[1 - \prod_{i=1}^n \left(1 - (T_i^-) \right)^{\frac{1}{n}}, 1 - \prod_{i=1}^n \left(1 - (T_i^+) \right)^{\frac{1}{n}} \right], \left[\prod_{i=1}^n (I_i^-)^{\frac{1}{n}}, \prod_{i=1}^n (I_i^+)^{\frac{1}{n}} \right], \left[\prod_{i=1}^n (F_i^-)^{\frac{1}{n}}, \prod_{i=1}^n (F_i^+)^{\frac{1}{n}} \right] \right]. \end{aligned}$$

4. When $p=q=1$, IVNBM reduces to the interval-valued neutrosophic interrelated average (IVNIA) operator as follows:

$$\begin{aligned}
 IVNBM^{1,1}(x_1, x_2, \dots, x_n) &= \left(\frac{1}{n(n-1)} \bigoplus_{\substack{i,j=1 \\ i \neq j}}^n (x_i \otimes x_j) \right)^{\frac{1}{2}} \\
 &= \left[\left[\left(1 - \prod_{\substack{i,j=1 \\ i \neq j}}^n (1 - (T_i^-)(T_j^-))^{\frac{1}{n(n-1)}} \right)^{\frac{1}{2}}, \left(1 - \prod_{\substack{i,j=1 \\ i \neq j}}^n (1 - (T_i^+)(T_j^+))^{\frac{1}{n(n-1)}} \right)^{\frac{1}{2}} \right], \right. \\
 &\quad \left[1 - \left(1 - \prod_{\substack{i,j=1 \\ i \neq j}}^n (1 - (1 - I_i^-)(1 - I_j^-))^{\frac{1}{n(n-1)}} \right)^{\frac{1}{2}}, 1 - \left(1 - \prod_{\substack{i,j=1 \\ i \neq j}}^n (1 - (1 - I_i^+)(1 - I_j^+))^{\frac{1}{n(n-1)}} \right)^{\frac{1}{2}} \right], \\
 &\quad \left. \left[1 - \left(1 - \prod_{\substack{i,j=1 \\ i \neq j}}^n (1 - (1 - F_i^-)(1 - F_j^-))^{\frac{1}{n(n-1)}} \right)^{\frac{1}{2}}, 1 - \left(1 - \prod_{\substack{i,j=1 \\ i \neq j}}^n (1 - (1 - F_i^+)(1 - F_j^+))^{\frac{1}{n(n-1)}} \right)^{\frac{1}{2}} \right] \right].
 \end{aligned}$$

3.2 IVNWBM

Definition 6. Let $p, q \geq 0$ and $x_i = \langle [T_i^-, T_i^+], [I_i^-, I_i^+], [F_i^-, F_i^+] \rangle$ ($i=1, 2, \dots, n$) be a collection of IVNNs. $w = (w_1, w_2, \dots, w_n)^T$ is the weight vector of x_i ($i=1, 2, \dots, n$) where $w_i > 0$ ($i=1, 2, \dots, n$) and $\sum_{i=1}^n w_i = 1$. IVNWBM can be defined as:

$$IVNWBM^{p,q}(x_1, x_2, \dots, x_n) = \left(\frac{1}{n(n-1)} \bigoplus_{\substack{i,j=1 \\ i \neq j}}^n ((w_i x_i)^p \otimes (w_j x_j)^q) \right)^{\frac{1}{p+q}}. \quad (7)$$

Theorem 2. Let $p, q \geq 0$ and $x_i = \langle [T_i^-, T_i^+], [I_i^-, I_i^+], [F_i^-, F_i^+] \rangle$ ($i=1, 2, \dots, n$) be a collection of IVNNs. $w = (w_1, w_2, \dots, w_n)^T$ is the weight vector of x_i ($i=1, 2, \dots, n$) where $w_i > 0$ ($i=1, 2, \dots, n$) and $\sum_{i=1}^n w_i = 1$. The aggregated value by IVNWBM in Equation (7) is also an IVNN, and

$$\begin{aligned}
 & IVNWBM^{p,q}(x_1, x_2, \dots, x_n) \\
 &= \left[\left[\left(1 - \prod_{\substack{i,j=1 \\ i \neq j}}^n \left(1 - \left(1 - (1 - T_i^-)^{w_i} \right)^p \left(1 - (1 - T_j^-)^{w_j} \right)^q \right)^{\frac{1}{n(n-1)}} \right)^{\frac{1}{p+q}}, \right. \right. \\
 & \quad \left. \left[1 - \prod_{\substack{i,j=1 \\ i \neq j}}^n \left(1 - \left(1 - (1 - T_i^+)^{w_i} \right)^p \left(1 - (1 - T_j^+)^{w_j} \right)^q \right)^{\frac{1}{n(n-1)}} \right]^{\frac{1}{p+q}} \right], \\
 & \quad \left[1 - \left(1 - \prod_{\substack{i,j=1 \\ i \neq j}}^n \left(1 - \left(1 - (I_i^-)^{w_i} \right)^p \left(1 - (I_j^-)^{w_j} \right)^q \right)^{\frac{1}{n(n-1)}} \right)^{\frac{1}{p+q}}, \right. \\
 & \quad \left. 1 - \left(1 - \prod_{\substack{i,j=1 \\ i \neq j}}^n \left(1 - \left(1 - (I_i^+)^{w_i} \right)^p \left(1 - (I_j^+)^{w_j} \right)^q \right)^{\frac{1}{n(n-1)}} \right)^{\frac{1}{p+q}} \right], \\
 & \quad \left[1 - \left(1 - \prod_{\substack{i,j=1 \\ i \neq j}}^n \left(1 - \left(1 - (F_i^-)^{w_i} \right)^p \left(1 - (F_j^-)^{w_j} \right)^q \right)^{\frac{1}{n(n-1)}} \right)^{\frac{1}{p+q}}, \right. \\
 & \quad \left. \left. 1 - \left(1 - \prod_{\substack{i,j=1 \\ i \neq j}}^n \left(1 - \left(1 - (F_i^+)^{w_i} \right)^p \left(1 - (F_j^+)^{w_j} \right)^q \right)^{\frac{1}{n(n-1)}} \right)^{\frac{1}{p+q}} \right] \right]. \tag{8}
 \end{aligned}$$

Proof is given in appendix.

3.3 IVNGBM

Definition 7. Let $p, q \geq 0$ and $x_i = \langle [T_i^-, T_i^+], [I_i^-, I_i^+], [F_i^-, F_i^+] \rangle$ ($i = 1, 2, \dots, n$) be a collection of IVNNs. IVNGBM can be defined as:

$$IVNGBM^{p,q}(x_1, x_2, \dots, x_n) = \frac{1}{p+q} \bigotimes_{\substack{i,j=1 \\ i \neq j}}^n (px_i \oplus qx_j)^{\frac{1}{n(n-1)}}. \tag{9}$$

Theorem 3. Let $p, q \geq 0$ and $x_i = \langle [T_i^-, T_i^+], [I_i^-, I_i^+], [F_i^-, F_i^+] \rangle$ ($i = 1, 2, \dots, n$) be a collection of IVNNs, then the aggregated value by IVNGBM in Equation (9) is also an IVNN, and

$$\begin{aligned}
 & IVNGBM^{p,q}(x_1, x_2, \dots, x_n) \\
 &= \left\langle \left[1 - \left(1 - \prod_{\substack{i,j=1 \\ i \neq j}}^n (1 - (1 - T_i^-)^p (1 - T_j^-)^q)^{\frac{1}{n(n-1)}} \right)^{\frac{1}{p+q}}, 1 - \left(1 - \prod_{\substack{i,j=1 \\ i \neq j}}^n (1 - (1 - T_i^+)^p (1 - T_j^+)^q)^{\frac{1}{n(n-1)}} \right)^{\frac{1}{p+q}} \right], \right. \\
 & \left[\left(1 - \prod_{\substack{i,j=1 \\ i \neq j}}^n (1 - (I_i^-)^p (I_j^-)^q)^{\frac{1}{n(n-1)}} \right)^{\frac{1}{p+q}}, \left(1 - \prod_{\substack{i,j=1 \\ i \neq j}}^n (1 - (I_i^+)^p (I_j^+)^q)^{\frac{1}{n(n-1)}} \right)^{\frac{1}{p+q}} \right], \\
 & \left. \left[\left(1 - \prod_{\substack{i,j=1 \\ i \neq j}}^n (1 - (F_i^-)^p (F_j^-)^q)^{\frac{1}{n(n-1)}} \right)^{\frac{1}{p+q}}, \left(1 - \prod_{\substack{i,j=1 \\ i \neq j}}^n (1 - (F_i^+)^p (F_j^+)^q)^{\frac{1}{n(n-1)}} \right)^{\frac{1}{p+q}} \right] \right\rangle. \tag{10}
 \end{aligned}$$

Proof is given in appendix.

In the following part, we investigate some properties of IVNGBM:

(1) When $x_i = \langle [1,1], [0,0], [0,0] \rangle$ ($i = 1, 2, \dots, n$), $IVNGBM^{p,q}(x_1, x_2, \dots, x_n) = \langle [1,1], [0,0], [0,0] \rangle$.

(2) When $x_i = \langle [0,0], [1,1], [1,1] \rangle$ ($i = 1, 2, \dots, n$), $IVNGBM^{p,q}(x_1, x_2, \dots, x_n) = \langle [0,0], [1,1], [1,1] \rangle$.

(3) **(Idempotency)** When all IVNNs x_i ($i = 1, 2, \dots, n$) are equal, i.e., $x_i = x$ for all i ,

$$IVNGBM^{p,q}(x_1, x_2, \dots, x_n) = x. \tag{11}$$

Proof. Since $x_i = x$ for all i , we can obtain that

$$IVNGBM^{p,q}(x_1, x_2, \dots, x_n) = \frac{1}{p+q} \otimes_{\substack{i,j=1 \\ i \neq j}}^n (px_i \oplus qx_j)^{\frac{1}{n(n-1)}} = \frac{1}{p+q} \left(((p+q)x)^{\frac{1}{n(n-1)}} \right)^{n(n-1)} = x.$$

(4) **(Monotonicity)** Let $x_i = \langle [T_{x_i}^-, T_{x_i}^+], [I_{x_i}^-, I_{x_i}^+], [F_{x_i}^-, F_{x_i}^+] \rangle$ ($i = 1, 2, \dots, n$) and $y_i = \langle [T_{y_i}^-, T_{y_i}^+], [I_{y_i}^-, I_{y_i}^+], [F_{y_i}^-, F_{y_i}^+] \rangle$ ($i = 1, 2, \dots, n$) be two collections of IVNNs. If $T_{x_i}^- \leq T_{y_i}^-$, $T_{x_i}^+ \leq T_{y_i}^+$, $I_{x_i}^- \geq I_{y_i}^-$, $I_{x_i}^+ \geq I_{y_i}^+$, $F_{x_i}^- \geq F_{y_i}^-$ and $F_{x_i}^+ \geq F_{y_i}^+$ for all i , we can obtain that

$$IVNGBM^{p,q}(x_1, x_2, \dots, x_n) \leq IVNGBM^{p,q}(y_1, y_2, \dots, y_n). \tag{12}$$

(5) **(Commutativity)** Let (x_1, x_2, \dots, x_n) be any permutation of (x_1, x_2, \dots, x_n) , then $IVNGBM^{p,q}(x_1, x_2, \dots, x_n) = IVNGBM^{p,q}(x_1, x_2, \dots, x_n)$.

(6) **(Boundedness)** Let $x_i = \langle [T_i^-, T_i^+], [I_i^-, I_i^+], [F_i^-, F_i^+] \rangle$ ($i = 1, 2, \dots, n$) be a collection of IVNNs, $x^- = \langle [\min_i \{T_i^-\}, \min_i \{T_i^+\}], [\max_i \{I_i^-\}, \max_i \{I_i^+\}], [\max_i \{F_i^-\}, \max_i \{F_i^+\}] \rangle$ and $x^+ = \langle [\max_i \{T_i^-\}, \max_i \{T_i^+\}], [\min_i \{I_i^-\}, \min_i \{I_i^+\}], [\min_i \{F_i^-\}, \min_i \{F_i^+\}] \rangle$, it is true that $x^- \leq IVNGBM^{p,q}(x_1, x_2, \dots, x_n) \leq x^+$.

Proof. Since $x_i \geq x^-$, according to Equation (11) and inequality (12), we have $IVNGBM^{p,q}(x_1, x_2, \dots, x_n) \geq IVNGBM^{p,q}(x^-, x^-, \dots, x^-) = x^-$. Likewise, we can obtain $IVNGBM^{p,q}(x_1, x_2, \dots, x_n) \leq IVNGBM^{p,q}(x^+, x^+, \dots, x^+) = x^+$. Therefore, $x^- \leq IVNGBM^{p,q}(x_1, x_2, \dots, x_n) \leq x^+$.

In the following part, we discuss some special cases of IVNGBM.

1. When $q \rightarrow 0$, from Equation (9) and (10), IVNGBM reduces to the generalized interval-valued neutrosophic geometric average (GIVNGA) operator as follows:

$$\begin{aligned} \lim_{q \rightarrow 0} IVNGBM^{p,q}(x_1, x_2, \dots, x_n) &= \lim_{q \rightarrow 0} \frac{1}{p+q} \bigotimes_{\substack{i,j=1 \\ i \neq j}}^n (px_i \oplus qx_j)^{\frac{1}{n(n-1)}} = \frac{1}{p} \bigotimes_{i=1}^n (px_i)^{\frac{1}{n}} \\ &= \left\langle \left[1 - \left(1 - \prod_{i=1}^n (1 - (1 - T_i^-)^p)^{\frac{1}{n}} \right)^{\frac{1}{p}}, 1 - \left(1 - \prod_{i=1}^n (1 - (1 - T_i^+)^p)^{\frac{1}{n}} \right)^{\frac{1}{p}} \right], \right. \\ &\quad \left[\left(1 - \prod_{i=1}^n (1 - (I_i^-)^p)^{\frac{1}{n}} \right)^{\frac{1}{p}}, \left(1 - \prod_{i=1}^n (1 - (I_i^+)^p)^{\frac{1}{n}} \right)^{\frac{1}{p}} \right], \left[\left(1 - \prod_{i=1}^n (1 - (F_i^-)^p)^{\frac{1}{n}} \right)^{\frac{1}{p}}, \right. \\ &\quad \left. \left. \left(1 - \prod_{i=1}^n (1 - (F_i^+)^p)^{\frac{1}{n}} \right)^{\frac{1}{p}} \right] \right\rangle. \end{aligned}$$

2. When $p=2$ and $q \rightarrow 0$, IVNBM reduces to the interval-valued neutrosophic square geometric average (IVNSGA) operator as follows:

$$\begin{aligned} IVNBM^{2,0}(x_1, x_2, \dots, x_n) &= \frac{1}{2} \bigotimes_{\substack{i,j=1 \\ i \neq j}}^n (2x_i)^{\frac{1}{n(n-1)}} = \frac{1}{2} \bigotimes_{i=1}^n (2x_i)^{\frac{1}{n}} \\ &= \left\langle \left[1 - \left(1 - \prod_{i=1}^n (1 - (1 - T_i^-)^2)^{\frac{1}{n}} \right)^{\frac{1}{2}}, 1 - \left(1 - \prod_{i=1}^n (1 - (1 - T_i^+)^2)^{\frac{1}{n}} \right)^{\frac{1}{2}} \right], \right. \\ &\quad \left[\left(1 - \prod_{i=1}^n (1 - (I_i^-)^2)^{\frac{1}{n}} \right)^{\frac{1}{2}}, \left(1 - \prod_{i=1}^n (1 - (I_i^+)^2)^{\frac{1}{n}} \right)^{\frac{1}{2}} \right], \left[\left(1 - \prod_{i=1}^n (1 - (F_i^-)^2)^{\frac{1}{n}} \right)^{\frac{1}{2}}, \right. \\ &\quad \left. \left. \left(1 - \prod_{i=1}^n (1 - (F_i^+)^2)^{\frac{1}{n}} \right)^{\frac{1}{2}} \right] \right\rangle. \end{aligned}$$

3. When $p=1$ and $q \rightarrow 0$, IVNGBM reduces to the interval-valued neutrosophic geometric average (IVNGA) operator as follows:

$$\begin{aligned} IVNGBM^{1,0}(x_1, x_2, \dots, x_n) &= \bigotimes_{i=1}^n (x_i)^{\frac{1}{n}} \\ &= \left\langle \left[\prod_{i=1}^n (T_i^-)^{\frac{1}{n}}, \prod_{i=1}^n (T_i^+)^{\frac{1}{n}} \right], \left[\left(1 - \prod_{i=1}^n (1 - I_i^-)^{\frac{1}{n}} \right), \left(1 - \prod_{i=1}^n (1 - I_i^+)^{\frac{1}{n}} \right) \right], \right. \\ &\quad \left. \left[\left(1 - \prod_{i=1}^n (1 - F_i^-)^{\frac{1}{n}} \right), \left(1 - \prod_{i=1}^n (1 - F_i^+)^{\frac{1}{n}} \right) \right] \right\rangle. \end{aligned}$$

4. When $p=q=1$, IVNGBM reduces to the interval-valued neutrosophic interrelated square geometric average (IVNISGA) operator as follows:

$$\begin{aligned}
 IVNGBM^{1,1}(x_1, x_2, \dots, x_n) &= \frac{1}{2} \bigotimes_{\substack{i,j=1 \\ i \neq j}}^n (x_i \oplus x_j)^{\frac{1}{n(n-1)}} \\
 &= \left\langle \left[1 - \left(1 - \prod_{\substack{i,j=1 \\ i \neq j}}^n (1 - (1 - T_i^-)(1 - T_j^-))^{\frac{1}{n(n-1)}} \right)^{\frac{1}{2}}, 1 - \left(1 - \prod_{\substack{i,j=1 \\ i \neq j}}^n (1 - (1 - T_i^+)(1 - T_j^+))^{\frac{1}{n(n-1)}} \right)^{\frac{1}{2}} \right], \right. \\
 &\quad \left[\left(1 - \prod_{\substack{i,j=1 \\ i \neq j}}^n (1 - (I_i^-)(I_j^-))^{\frac{1}{n(n-1)}} \right)^{\frac{1}{2}}, \left(1 - \prod_{\substack{i,j=1 \\ i \neq j}}^n (1 - (I_i^+)(I_j^+))^{\frac{1}{n(n-1)}} \right)^{\frac{1}{2}} \right], \\
 &\quad \left. \left[\left(1 - \prod_{\substack{i,j=1 \\ i \neq j}}^n (1 - (F_i^-)(F_j^-))^{\frac{1}{n(n-1)}} \right)^{\frac{1}{2}}, \left(1 - \prod_{\substack{i,j=1 \\ i \neq j}}^n (1 - (F_i^+)(F_j^+))^{\frac{1}{n(n-1)}} \right)^{\frac{1}{2}} \right] \right\rangle.
 \end{aligned}$$

3.4 IVNWGBM

Definition 8. Let $p, q \geq 0$ and $x_i = \langle [T_i^-, T_i^+], [I_i^-, I_i^+], [F_i^-, F_i^+] \rangle$ ($i=1, 2, \dots, n$) be a collection of IVNNs. $w = (w_1, w_2, \dots, w_n)^T$ is the weight vector of x_i ($i=1, 2, \dots, n$) where $w_i > 0$ ($i=1, 2, \dots, n$) and $\sum_{i=1}^n w_i = 1$. IVNWGBM can be defined as:

$$IVNWGBM^{p,q}(x_1, x_2, \dots, x_n) = \frac{1}{p+q} \left(\bigotimes_{\substack{i,j=1 \\ i \neq j}}^n (px_i^{w_i} \oplus qx_j^{w_j})^{\frac{1}{n(n-1)}} \right). \quad (13)$$

Theorem 4. Let $p, q \geq 0$ and $x_i = \langle [T_i^-, T_i^+], [I_i^-, I_i^+], [F_i^-, F_i^+] \rangle$ ($i=1, 2, \dots, n$) be a collection of IVNNs. $w = (w_1, w_2, \dots, w_n)^T$ is the weight vector of x_i ($i=1, 2, \dots, n$) where $w_i > 0$ ($i=1, 2, \dots, n$) and $\sum_{i=1}^n w_i = 1$. The aggregated value by IVNWGBM in (13) is also an IVNN, and

$$\begin{aligned}
 & IVNWGBM^{p,q}(x_1, x_2, \dots, x_n) \\
 &= \left\langle \left[1 - \left(1 - \prod_{\substack{i,j=1 \\ i \neq j}}^n \left(1 - \left(1 - (T_i^-)^{w_i} \right)^p \left(1 - (T_j^-)^{w_j} \right)^q \right)^{\frac{1}{n(n-1)}} \right)^{\frac{1}{p+q}}, \right. \right. \\
 & \quad \left. \left. 1 - \left(1 - \prod_{\substack{i,j=1 \\ i \neq j}}^n \left(1 - \left(1 - (T_i^+)^{w_i} \right)^p \left(1 - (T_j^+)^{w_j} \right)^q \right)^{\frac{1}{n(n-1)}} \right)^{\frac{1}{p+q}} \right], \right. \\
 & \quad \left[\left(1 - \prod_{\substack{i,j=1 \\ i \neq j}}^n \left(1 - \left(1 - (1 - I_i^-)^{w_i} \right)^p \left(1 - (1 - I_j^-)^{w_j} \right)^q \right)^{\frac{1}{n(n-1)}} \right)^{\frac{1}{p+q}}, \right. \\
 & \quad \left. \left(1 - \prod_{\substack{i,j=1 \\ i \neq j}}^n \left(1 - \left(1 - (1 - I_i^+)^{w_i} \right)^p \left(1 - (1 - I_j^+)^{w_j} \right)^q \right)^{\frac{1}{n(n-1)}} \right)^{\frac{1}{p+q}} \right], \\
 & \quad \left[\left(1 - \prod_{\substack{i,j=1 \\ i \neq j}}^n \left(1 - \left(1 - (1 - F_i^-)^{w_i} \right)^p \left(1 - (1 - F_j^-)^{w_j} \right)^q \right)^{\frac{1}{n(n-1)}} \right)^{\frac{1}{p+q}}, \right. \\
 & \quad \left. \left(1 - \prod_{\substack{i,j=1 \\ i \neq j}}^n \left(1 - \left(1 - (1 - F_i^+)^{w_i} \right)^p \left(1 - (1 - F_j^+)^{w_j} \right)^q \right)^{\frac{1}{n(n-1)}} \right)^{\frac{1}{p+q}} \right] \right\rangle. \tag{14}
 \end{aligned}$$

Proof is given in appendix.

3.5 PROCEDURES OF THE PROPOSED APPROACHES

Here we present our novel MCDM approaches for the selection of renewable energy based on the WBM (or the WGBM) for IVNNs.

Assume there are m alternatives $A = \{A_1, A_2, \dots, A_m\}$ and n criteria $C = \{C_1, C_2, \dots, C_n\}$, whose subjective weight vector provided by the decision maker is $w = (w_1, w_2, \dots, w_n)$, where $w_j \geq 0$

($j = 1, 2, \dots, n$) and $\sum_{j=1}^n w_j = 1$. Let $U = (a_{ij})_{m \times n}$ be the interval-valued neutrosophic decision matrix, where

$a_{ij} = \langle T_{a_{ij}}, I_{a_{ij}}, F_{a_{ij}} \rangle$ is an evaluation value, denoted by IVNN, where $T_{a_{ij}} = [\inf T_{a_{ij}}, \sup T_{a_{ij}}]$ indicates the truth-membership function that the alternative A_i satisfies the criterion C_j , $I_{a_{ij}} = [\inf I_{a_{ij}}, \sup I_{a_{ij}}]$ indicates the indeterminacy-membership function that the alternative A_i satisfies the criterion C_j and $F_{a_{ij}} = [\inf F_{a_{ij}}, \sup F_{a_{ij}}]$ indicates the falsity-membership function that the alternative A_i satisfies the criterion C_j .

In the following part, the proposed MCDM approach to rank and select the most desirable alternative(s) is based upon IVNWBM (or IVNWGBM) and its procedures are as follows:

Step 1: Normalize the decision matrix.

Criteria can be divided into two types: benefit criterion and cost criterion. The bigger the value of an alternative under a benefit criterion is, the better the attribute will be; conversely, the smaller the value of an alternative under a cost criterion is, the better the alternative is.

To unify all criteria, the decision matrix needs to be normalized, and the normalized decision matrix $N = (b_{ij})^{n \times m}$ can be obtained by:

$$b_{ij} = \begin{cases} a_{ij} & \text{if } C_j \text{ is a benefit criterion} \\ \text{neg}(a_{ij}) & \text{if } C_j \text{ is a cost criterion} \end{cases} \quad (15)$$

Step 2: Calculate the overall performance value r_i ($i = 1, 2, \dots, m$) of alternative A_i .

The overall performance value r_i can be computed by making use of IVNWBM or IVNWGBM.

Step 3: Calculate the score value s_i of the collective IVNN r_i ($i = 1, 2, \dots, m$).

According to the score function of IVNN defined in Definition 1, we can obtain the score value s_i of each collective IVNN r_i utilizing Equation (1).

Step 4: Calculate the accuracy value a_i of the collective IVNN r_i ($i = 1, 2, \dots, m$).

According to the score function of IVNN defined in Definition 2, we can get the accuracy value a_i of each collective IVNN r_i utilizing Equation (2).

Step 5: Rank the alternatives according to the comparative method of IVNNs.

According to the comparative method defined in Definition 3, we can derive the final ranking of alternatives.

4. EXAMPLE AND COMPARATIVE ANALYSIS

4.1 NUMERICAL EXAMPLE

In this subsection, a numerical example for the MCDM problem with IVNNs is used to demonstrate the applicability of the proposed decision-making approaches.

The following example about the selection of renewable energy is adapted from Ref. (Yazdani-Chamzini et al., 2013).

A government intends to select one kind of renewable energy to use for the sustainable development of local economy. After preliminary selection, there are three kinds of renewable energy: (1) solar energy (A_1); (2) wind energy (A_2); (3) hydraulic energy (A_3). These three kinds of renewable energy are assessed by experts with respect to seven criteria: (1) power (C_1); (2) investment ratio (C_2); and (3) implementation period (C_3); (4) operating hours (C_4); (5) useful life (C_5); (6) operation and maintenance costs (C_6); (7) emissions of CO₂ avoided per year (C_7). The criteria of C_1 , C_4 , C_5 and C_6 are benefit ones while the rest three criteria are cost ones. Moreover, these seven criteria are correlative. The weight vector of the criteria is calculated by Yazdani-Chamzini (Yazdani-Chamzini et al., 2013) as $w = (0.319, 0.09, 0.026, 0.116, 0.134, 0.042, 0.273)$. In order to reflect the reality more accurately and obtain more fuzzy and uncertain information, we transform the evaluation values provided by experts into IVNNs, as shown in Table 1.

Table1: The evaluation information

	A_1	A_2	A_3
C_1	$\langle [0.7, 0.8], [0.3, 0.4], [0.4, 0.5] \rangle$	$\langle [0.7, 0.9], [0.2, 0.4], [0.4, 0.6] \rangle$	$\langle [0.7, 0.9], [0.2, 0.3], [0.4, 0.5] \rangle$
C_2	$\langle [0.2, 0.3], [0.8, 0.9], [0.6, 0.7] \rangle$	$\langle [0.2, 0.3], [0.6, 0.7], [0.6, 0.7] \rangle$	$\langle [0.3, 0.6], [0.3, 0.5], [0.8, 0.9] \rangle$
C_3	$\langle [0.3, 0.4], [0.6, 0.9], [0.7, 0.8] \rangle$	$\langle [0.3, 0.4], [0.6, 0.7], [0.5, 0.6] \rangle$	$\langle [0.4, 0.5], [0.6, 0.8], [0.7, 0.9] \rangle$

C_4	$\langle [0.6, 0.8], [0.1, 0.2], [0.3, 0.4] \rangle$	$\langle [0.8, 0.9], [0.1, 0.3], [0.3, 0.4] \rangle$	$\langle [0.8, 0.9], [0.3, 0.4], [0.1, 0.2] \rangle$
C_5	$\langle [0.8, 0.9], [0.1, 0.2], [0.2, 0.3] \rangle$	$\langle [0.8, 0.9], [0.3, 0.5], [0.4, 0.6] \rangle$	$\langle [0.8, 0.9], [0.4, 0.5], [0.3, 0.4] \rangle$
C_6	$\langle [0.8, 0.9], [0.5, 0.6], [0.1, 0.2] \rangle$	$\langle [0.5, 0.8], [0.1, 0.2], [0.3, 0.4] \rangle$	$\langle [0.8, 1], [0.1, 0.3], [0.1, 0.2] \rangle$
C_7	$\langle [0.2, 0.3], [0.8, 0.9], [0.9, 1] \rangle$	$\langle [0.2, 0.4], [0.5, 0.7], [0.8, 0.9] \rangle$	$\langle [0.1, 0.2], [0.7, 0.9], [0.7, 0.8] \rangle$

Assume $p = q = 1$, we firstly utilize IVNWBM to solve the above MCDM problem about the selection of renewable energy, and the procedure is shown as follows:

Step 1: Normalize the decision matrix.

Since the criteria of C_1, C_4, C_5 and C_6 are benefit ones while the criteria C_2, C_3 , and C_7 are cost ones, the decision matrix can be normalized utilizing Equation (15), and the normalized decision information are shown in Table 2.

Table2: Normalized evaluation information

	A_1	A_2	A_3
C_1	$\langle [0.7, 0.8], [0.3, 0.4], [0.4, 0.5] \rangle$	$\langle [0.7, 0.9], [0.2, 0.4], [0.4, 0.6] \rangle$	$\langle [0.7, 0.9], [0.2, 0.3], [0.4, 0.5] \rangle$
C_2	$\langle [0.6, 0.7], [0.1, 0.2], [0.2, 0.3] \rangle$	$\langle [0.6, 0.7], [0.3, 0.4], [0.2, 0.3] \rangle$	$\langle [0.8, 0.9], [0.5, 0.7], [0.3, 0.6] \rangle$
C_3	$\langle [0.7, 0.8], [0.1, 0.4], [0.3, 0.4] \rangle$	$\langle [0.5, 0.6], [0.3, 0.4], [0.3, 0.4] \rangle$	$\langle [0.7, 0.9], [0.2, 0.4], [0.4, 0.5] \rangle$
C_4	$\langle [0.6, 0.8], [0.1, 0.2], [0.3, 0.4] \rangle$	$\langle [0.8, 0.9], [0.1, 0.3], [0.3, 0.4] \rangle$	$\langle [0.8, 0.9], [0.3, 0.4], [0.1, 0.2] \rangle$
C_5	$\langle [0.8, 0.9], [0.1, 0.2], [0.2, 0.3] \rangle$	$\langle [0.8, 0.9], [0.3, 0.5], [0.4, 0.6] \rangle$	$\langle [0.8, 0.9], [0.4, 0.5], [0.3, 0.4] \rangle$
C_6	$\langle [0.8, 0.9], [0.5, 0.6], [0.1, 0.2] \rangle$	$\langle [0.5, 0.8], [0.1, 0.2], [0.3, 0.4] \rangle$	$\langle [0.8, 1], [0.1, 0.3], [0.1, 0.2] \rangle$
C_7	$\langle [0.9, 1], [0.1, 0.2], [0.2, 0.3] \rangle$	$\langle [0.8, 0.9], [0.3, 0.5], [0.2, 0.4] \rangle$	$\langle [0.7, 0.8], [0.1, 0.3], [0.1, 0.2] \rangle$

Step 2: Calculate the collective overall value r_i ($i = 1, 2, \dots, m$) of alternative A_i .

Utilizing Equation (8), the collective matrix formed by the collective overall value r_i ($i = 1, 2, \dots, m$) is

$$C = \begin{pmatrix} \langle [0.1708, 0.2791], [0.7824, 0.8406], [0.8340, 0.8723] \rangle \\ \langle [0.1598, 0.2327], [0.8208, 0.8873], [0.8527, 0.9028] \rangle \\ \langle [0.1668, 0.3710], [0.8225, 0.8801], [0.8179, 0.8682] \rangle \end{pmatrix}.$$

Step 3: Calculate the score value s_i of the collective IVNN r_i ($i = 1, 2, \dots, m$).

Utilizing Equation (1), the score vector can be obtained as $s = [-0.6256, -0.6948, -0.6384]$.

Step 4: Calculate the accuracy value a_i of the collective IVNN r_i ($i = 1, 2, \dots, m$).

Utilizing Equation (2), the accuracy vector can be calculated as $a = [-0.0521, -0.0339, 0.0114]$.

Step 5: Rank the alternatives according to the comparative method of IVNNs.

Based on the above steps, the final order $A_1 \succ A_3 \succ A_2$ is obtained. Obviously, among the four alternatives, A_1 is the best one and A_2 is the worst one.

Then, we utilize IVNWGBM to solve the above MCDM problem, and the ranking result is obtained: $A_1 \succ A_3 \succ A_2$. It is evident that the best alternative is A_1 and the worst one is A_2 .

4.2 The influence of parameters

As discussed in Ref. (Zhu & Xu, 2013), the collective IVNN for a certain alternative with IVNWBM or IVNWGBM is monotonically increasing with increasing p (or q) and is symmetric about $p = q$. In order to demonstrate the influence of the parameters p and q on the final ranking order of this numerical example, we calculate the ranking results of alternatives using different values of these two parameters. All referred values of p and q can be divided into three categories. In the first category, the value of p is smaller than that of q , the values of p and q are equal in the second category, whilst the value of p is bigger than that of q in the third category. The significant pairs of p and q and the respective final ranking results of two proposed approaches are shown in Table 3 and Table 4, respectively. When the difference between the values of p and q is big enough, the ranking result will stay stable. In Tables 1 and 2, we obtain the ranking results when the difference between the values of p and q varies to represent the influence of p and q .

Table3: Ranking results of the approach using IVNWBM with different p and q

p, q	Score value s_i	Ranking result
$p = 0.001, q = 1$	$s_1 = -0.5042, s_2 = -0.6683, s_3 = -0.5220$	$A_1 \succ A_3 \succ A_2$
$p = 0.1, q = 1$	$s_1 = -0.5934, s_2 = -0.6839, s_3 = -0.6031$	$A_1 \succ A_3 \succ A_2$
$p = 1, q = 2$	$s_1 = -0.5725, s_2 = -0.6568, s_3 = -0.5817$	$A_1 \succ A_3 \succ A_2$
$p = 1, q = 5$	$s_1 = -0.4235, s_2 = -0.5546, s_3 = -0.4203$	$A_3 \succ A_1 \succ A_2$
$p = 1, q = 10$	$s_1 = -0.2920, s_2 = -0.4662, s_3 = -0.2914$	$A_3 \succ A_1 \succ A_2$
$p = 0.1, q = 0.1$	$s_1 = -0.6936, s_2 = -0.7453, s_3 = -0.7014$	$A_1 \succ A_3 \succ A_2$
$p = 1, q = 1$	$s_1 = -0.6256, s_2 = -0.6948, s_3 = -0.6384$	$A_1 \succ A_3 \succ A_2$
$p = 4, q = 4$	$s_1 = -0.4684, s_2 = -0.5689, s_3 = -0.4528$	$A_3 \succ A_1 \succ A_2$
$p = 10, q = 10$	$s_1 = -0.3688, s_2 = -0.5228, s_3 = -0.3336$	$A_3 \succ A_1 \succ A_2$
$p = 0.1, q = 0$	$s_1 = -0.4697, s_2 = -0.7182, s_3 = -0.5034$	$A_1 \succ A_3 \succ A_2$
$p = 0.5, q = 0$	$s_1 = -0.4480, s_2 = -0.6971, s_3 = -0.4812$	$A_1 \succ A_3 \succ A_2$
$p = 1, q = 0$	$s_1 = -0.4192, s_2 = -0.6681, s_3 = -0.4489$	$A_1 \succ A_3 \succ A_2$
$p = 5, q = 0$	$s_1 = -0.2640, s_2 = -0.5035, s_3 = -0.2597$	$A_3 \succ A_1 \succ A_2$

As displayed in Table 3, with changeable values of p and q , the ranking result of alternatives may be slightly different. Furthermore, all score values shown in Table 1 obtained by the proposed approach using IVNWBM are smaller than 0. In addition, two different ranking results exist when the value of p is smaller than that of q . A_2 is the worst alternative in both of these two different ranking results. The best alternative is A_1 when the value of q is smaller than 2 while the best one is A_3 in the when the values of p and q are not smaller than 4. Two different ranking results, which are same with the ranking results in the first category, exist in the second category. When the values of p and q are smaller than 1, the best alternative is A_1 and the worst one is A_3 . In the third category, A_1 is the best alternative and A_2 is the worst one when the value of p is not bigger than 1. There is another ranking result whose best alternative is A_3 and the worst one is A_2 in the third category.

Table4: Ranking results of the approach using the IVNWGBM with different p and q

p, q	Score value s_i	Ranking result
$p = 0.001, q = 1$	$s_1 = 0.6016, s_2 = 0.5426, s_3 = 0.5710$	$A_1 \succ A_3 \succ A_2$
$p = 0.1, q = 1$	$s_1 = 0.6696, s_2 = 0.6142, s_3 = 0.6397$	$A_1 \succ A_3 \succ A_2$
$p = 1, q = 2$	$s_1 = 0.9800, s_2 = 0.9690, s_3 = 0.9751$	$A_1 \succ A_3 \succ A_2$
$p = 1, q = 6$	$s_1 = 0.9996, s_2 = 0.9992, s_3 = 0.9997,$	$A_3 \succ A_1 \succ A_2$
$p = 0.1, q = 0.1$	$s_1 = -0.3768, s_2 = -0.4375, s_3 = -0.4027$	$A_1 \succ A_3 \succ A_2$
$p = 0.5, q = 0.5$	$s_1 = 0.6495, s_2 = 0.5892, s_3 = 0.6135$	$A_1 \succ A_3 \succ A_2$
$p = 1, q = 1$	$s_1 = 0.9254, s_2 = 0.8985, s_3 = 0.9096$	$A_1 \succ A_3 \succ A_2$
$p = 0.1, q = 0$	$s_1 = -0.6694, s_2 = -0.7020, s_3 = -0.6843$	$A_1 \succ A_3 \succ A_2$
$p = 0.5, q = 0$	$s_1 = 0.1470, s_2 = 0.0805, s_3 = 0.1093$	$A_1 \succ A_3 \succ A_2$
$p = 1, q = 0$	$s_1 = 0.5977, s_2 = 0.5418, s_3 = 0.5672$	$A_1 \succ A_3 \succ A_2$
$p = 2, q = 0$	$s_1 = 0.8862, s_2 = 0.8614, s_3 = 0.8792$	$A_1 \succ A_3 \succ A_2$
$p = 5, q = 0$	$s_1 = 0.9946, s_2 = 0.9922, s_3 = 0.9954$	$A_3 \succ A_1 \succ A_2$

As noted in Table 4, like what’s shown in Table 1, when the values of p and q vary, there may be slight differences in the ranking results of alternatives. In addition, when the value of p equals to that of q , the ranking result are same. The best alternative is A_1 and the worst one is A_2 . Two different ranking results exist in the first category. When the values of p and q are bigger than 6, the best alternative is A_3 and the worst one is A_2 . Another ranking result in the first category is same as the ranking result in the second category and that in the third category when the value of p is smaller than 2. In the third category, there is another ranking result whose best alternative is A_3 and the worst one is A_4 .

Moreover, all score values presented in Table 4 obtained by the proposed approach using IVNWGBM are bigger than those in Table 1 when the values of p and q are constant.

According to Tables 3 and 4, we can conclude that as the values of p and q change, the ranking results obtained by a certain approach may be different. The reason for this difference is discussed. The values of these two parameters, which are determined according to the subjective preference of decision maker, can reflect his risk preference. And it is obvious that the ranking result of alternatives may be distinct when the decision maker’s risk preference varies. Therefore, the difference mentioned above, which also exists in the extant studies about BM, is reasonable. In practical, if the values of p and q are known or can be obtained by regression analysis with decision maker’s available data, it is considerable to utilize the proposed approaches. Otherwise, the proposed approaches are not suitable since their ranking results may be inaccurate and volatile.

4.3 COMPARATIVE ANALYSIS

For the sake of validating the feasibility of the proposed decision-making approaches, a comparative study is conducted. The study includes two cases. The first case compares the proposed approaches with approaches proposed by Liu and Wang (Liu & Wang, 2014) and Şahin (Şahin, 2014) under single-valued neutrosophic environments. The second case compares the proposed approaches with two approaches proposed by Şahin (Şahin, 2014) and two approaches proposed by Zhang *et al.* (H. Y. Zhang et al., 2014) under interval-valued neutrosophic environments. Since the extant MCDM selection approaches (Cristóbal, 2011; Yazdani-Chamzini et al., 2013) for renewable energy cannot deal with IVNNs, the proposed approaches are not compare with approaches in Ref. (Cristóbal, 2011; Yazdani-Chamzini et al., 2013). The detail of the study is described in the following of this subsection.

Case 1: The comparative analysis under single-valued neutrosophic environments.

This case is based upon the same numerical example of MCDM problem with SVNNS in Ref. (Şahin, 2014). The ranking results of the proposed approaches are compared with that of the approaches in Refs.

(Liu & Wang, 2014; Şahin, 2014). The approaches in Ref. (Şahin, 2014) are constructed on the basis of the proposed single-valued neutrosophic weighted operators and score function. Two single-valued neutrosophic weighted operators are developed by Şahin (Şahin, 2014) including the single-valued neutrosophic weighted average (SVNWA) operator and the single-valued neutrosophic weighted geometric average (SVNWGA) operator. The approach in Ref. (Liu & Wang, 2014) utilizes the proposed single-valued neutrosophic normalized WBM (SVNNWBM) operator and the score function to rank alternatives. The ranking results of the proposed approaches and the approaches in Refs. (Liu & Wang, 2014; Şahin, 2014) are listed in Table 5.

Table5: Ranking results under single-valued neutrosophic environments

Approach	The ranking result	The best alternative(s)	The worst alternative(s)
Approach using SVNWA in Ref. (Şahin, 2014)	$A_4 \succ A_2 \succ A_3 \succ A_1$	A_4	A_1
Approach using SVNWGA in Ref. (Şahin, 2014)	$A_4 \succ A_2 \succ A_3 \succ A_1$	A_4	A_1
Approach using SVNNWBM in Ref. (Liu & Wang, 2014)	$A_4 \succ A_2 \succ A_3 \succ A_1$	A_4	A_1
The proposed approach using IVNWBM	$A_4 \succ A_2 \succ A_3 \succ A_1$	A_4	A_1
The proposed approach using IVNWGBM	$A_2 \succ A_3 \succ A_4 \succ A_1$	A_2	A_1

From Table 5, same ranking result is obtained by the approaches proposed by Şahin (Şahin, 2014) and Liu and Wang (Liu & Wang, 2014) and the proposed approach using IVNWBM. The best alternative of these approaches is A_4 and the worst one is A_1 . A different ranking result is obtained by the proposed approach using IVNWGBM. The best alternative of this proposed approach is A_2 and the worst one is A_1 .

In this case study, the ranking results of the approach using SVNWA in Ref. (Şahin, 2014), the approach in Ref. (Liu & Wang, 2014) and the proposed approach using IVNWBM are the same. And the same rankings of these three approaches illustrates that the proposed approach using IVNWBM can be effectively utilized to solve MCDM problems under single-valued neutrosophic environments. Different ranking results are obtained by the approach using SVNWGA in Ref. (Şahin, 2014) and the proposed approach using IVNWGBM. The reason is provided as follows. The proposed approach using IVNWGBM takes into account the interrelationships among criteria while the approach using SVNWGA in Ref. (Şahin, 2014) assumes that the criteria are independent. It is rational that the ranking results of these two approaches are different. We also explain why the ranking results of two proposed approaches are different. The proposed approach utilizing IVNWBM obtains a pessimistic result, while the proposed approach using IVNWGBM calculates an optimistic one. Therefore, the ranking results of the two proposed approaches may be different.

In general, the proposed approaches can be used to tackle MCDM problems with SVNSs while the extant SVNS approaches cannot address MCDM problems with IVNSs. From this perspective, the proposed approaches are flexible ones.

Case 2: The comparative analysis with extant interval-valued neutrosophic MCDM approaches.

This case is based upon the same numerical example of MCDM problem with IVNNs presented in Ref. (Şahin, 2014). The ranking results of the proposed approaches are compared with those of the MCDM approaches in Refs. (H. Y. Zhang et al., 2014) and (Şahin, 2014). Two approaches in Ref. (Şahin, 2014) make use of the IVNWA and IVNWG operators respectively to obtain the integrated value of each alternative considering all criteria. Two approaches proposed by Zhang *et al.* (H. Y. Zhang et al., 2014) utilize the novel IVNWA and IVNWG operators which are developed based on improved operations for

IVNSs. Additionally, the score value and the accuracy value are calculated to get the ranking list of alternatives. The ranking results of the proposed approaches and the approaches in Refs. (Şahin, 2014; H. Y. Zhang et al., 2014) are listed in Table 6.

Table6: Ranking results under interval-valued neutrosophic environments

Approach	The ranking result	The best alternative(s)	The worst alternative(s)
Approach using IVNWA in Ref. (Şahin, 2014)	$A_4 \succ A_1 \succ A_2 \succ A_3$	A_4	A_3
Approach using IVNWG in Ref. (Şahin, 2014)	$A_1 \succ A_4 \succ A_2 \succ A_3$	A_1	A_3
Approach using IVNWA in Ref. (H. Y. Zhang et al., 2014)	$A_4 \succ A_1 \succ A_2 \succ A_3$	A_4	A_3
Approach using IVNWG in Ref. (H. Y. Zhang et al., 2014)	$A_1 \succ A_4 \succ A_2 \succ A_3$	A_1	A_3
The proposed approach using IVNWBM	$A_4 \succ A_1 \succ A_3 \succ A_2$	A_4	A_2
The proposed approach using IVNWGBM	$A_1 \succ A_3 \succ A_4 \succ A_2$	A_1	A_2

As shown in Table 6, the best alternative of the proposed approach using IVNWGBM and approach using IVNWG in Refs. (Şahin, 2014; H. Y. Zhang et al., 2014) is A_1 while that of the other three approaches is A_4 . Moreover, two proposed approaches get the same worst alternative which is different from that obtained by the four approaches in Refs. (Şahin, 2014; H. Y. Zhang et al., 2014). The worst alternative in the proposed approaches is A_2 while that of the four approaches in Refs. (Şahin, 2014; H. Y. Zhang et al., 2014) is A_3 .

The reasons why inconsistencies exist in Table 6 are provided. Firstly, the operations and comparative method in approaches in Ref. (H. Y. Zhang et al., 2014) overcome the deficiencies of those in approaches proposed by Şahin (Şahin, 2014). The ranking results of approaches in Refs. (Şahin, 2014; H. Y. Zhang et al., 2014) may be different when using same aggregation operator. From Table 6, the ranking results obtained by the approaches in Refs. (Şahin, 2014; H. Y. Zhang et al., 2014) are same when using same aggregation operator. The reason is that the differences between approaches in Refs. (Şahin, 2014; H. Y. Zhang et al., 2014) with same aggregation operator do not influence the ranking result in this study. Nevertheless, different ranking results may be obtained by the approaches in Refs. (Şahin, 2014; H. Y. Zhang et al., 2014) using same aggregation operator when the decision matrix changes. Secondly, the approaches in Ref. (Şahin, 2014) assume that criteria are independent while the proposed approaches take into account the interrelationships among criteria. What's more, the operations and comparative method utilized in the proposed approaches are different from those in the approaches in Ref. (Şahin, 2014). Therefore, it is reasonable that different ranking results can be obtained by the ranking results of the proposed approaches and the approaches in Ref. (Şahin, 2014). Thirdly, the two proposed approaches investigate the interrelationships among criteria while the two approaches in Ref. (H. Y. Zhang et al., 2014) assume criteria independent. However, criteria are usually correlative in practical MCDM problems like the selection of renewable energy. Thus, the ranking results obtained by the proposed approaches are in accord with decision makers' preferences than those obtained by the two approaches in Ref. (H. Y. Zhang et al., 2014). Fourthly, similar to what's presented in Case 1, IVNWBM can be thought as a more pessimistic operator while IVNWGBM can be thought as a more optimistic one. Thus, difference may exist in the ranking results of the two proposed approaches. In addition, it is not necessary to say which proposed approach is the best. Utilizing which approach to obtain the ranking result relies on the

preference of decision maker, for instance, if a decision maker has a pessimistic nature, it may be more appropriate to utilize the proposed approach utilizing IVNWBM.

Generally speaking, the proposed approaches can be used to solve MCDM problems under single-valued neutrosophic environments and interval-valued neutrosophic environments. In addition, the proposed approaches take into consideration the interrelationships among criteria, which make them more suitable in dealing with practical MCDM problems under interval-valued neutrosophic environments than the extant approaches.

5. CONCLUSION AND FUTURE RESEARCH

In practice, the fuzziness and uncertainty often exist in the decision information provided by decision makers when selecting renewable energy, and IVNSs can depict the information. Moreover, the criteria may be interdependent in the problems of selecting renewable energy. BM is a valid tool to consider the interrelationships among criteria. Therefore, in this study, we extended BM and GBM to interval-valued neutrosophic environments, and defined IVNBM and IVNGBM. Some properties of these two operators were discussed. As IVNBM and IVNGBM do not take the relative importance of each integrated element into account, IVNWBM and IVNWGBM were proposed in this study. As well, two approaches applying IVNWBM and IVNWGBM respectively were presented to solve selection problems of renewable energy under interval-value neutrosophic environments. In addition, a numerical example about the selection of renewable energy is used to demonstrate the application of the proposed approaches. And the influence of parameters on final rankings is discussed. Subsequently, we verify the feasibility of the proposed approaches by comparing with other existing MCDM approaches.

The contributions of this paper are concluded as follows: firstly, this paper established novel approaches for the selection of renewable energy. Secondly, BM and GBM were extended into interval-valued neutrosophic environments. This theoretical extension can provide support for future other application researches. Thirdly, the proposed approaches reduce the loss of information during the processes of selecting renewable energy by utilizing IVNSs to deal with fuzzy and uncertain information. Fourthly, the proposed approaches take into consideration of the interrelationships among criteria, and the ranking results obtained by the proposed approaches are closer to decision makers' preferences than extant approaches. The feasibility and effectiveness have been proved by the comparative analysis.

Two promising directions are provided for future research. First, it is significant to apply IVNWBM and the IVMWGBM to solve problems in various other fields, such as purchasing decision-making, commodity recommendation and medical diagnosis. Second, the priority levels of criteria are different. It is worth of further study to construct a MCDM approach which considers the priority of criteria on the basis of this paper.

ACKNOWLEDGMENT

This work was supported by the National Natural Science Foundation of China (Nos. 71501192 and 71571193).

APPENDIX. PROOF OF THEOREMS

Proof of Theorem 2.

According to the operations (3) and (4) in Definition 4, we have $w_i x_i = \left\langle \left[1 - (1 - T_i^-)^{w_i}, 1 - (1 - T_i^+)^{w_i} \right], \left[(I_i^-)^{w_i}, (I_i^+)^{w_i} \right], \left[(F_i^-)^{w_i}, (F_i^+)^{w_i} \right] \right\rangle$, $w_j x_j = \left\langle \left[1 - (1 - T_j^-)^{w_j}, 1 - (1 - T_j^+)^{w_j} \right], \left[(I_j^-)^{w_j}, (I_j^+)^{w_j} \right], \left[(F_j^-)^{w_j}, (F_j^+)^{w_j} \right] \right\rangle$, $(w_i x_i)^p = \left\langle \left[\left(1 - (1 - T_i^-)^{w_i} \right)^p, \left(1 - (1 - T_i^+)^{w_i} \right)^p \right], \left[1 - \left(1 - (I_i^-)^{w_i} \right)^p, 1 - \left(1 - (I_i^+)^{w_i} \right)^p \right], \left[1 - \left(1 - (F_i^-)^{w_i} \right)^p, 1 - \left(1 - (F_i^+)^{w_i} \right)^p \right] \right\rangle$ and $(w_j x_j)^q = \left\langle \left[\left(1 - (1 - T_j^-)^{w_j} \right)^q, \left(1 - (1 - T_j^+)^{w_j} \right)^q \right], \left[1 - \left(1 - (I_j^-)^{w_j} \right)^q, 1 - \left(1 - (I_j^+)^{w_j} \right)^q \right], \left[1 - \left(1 - (F_j^-)^{w_j} \right)^q, 1 - \left(1 - (F_j^+)^{w_j} \right)^q \right] \right\rangle$.

$\left[1 - \left(1 - (I_j^-)^{w_j}\right)^q, 1 - \left(1 - (I_j^+)^{w_j}\right)^q\right], \left[1 - \left(1 - (F_j^-)^{w_j}\right)^q, 1 - \left(1 - (F_j^+)^{w_j}\right)^q\right]$. Then, $(w_i x_i)^p \otimes (w_j x_j)^q = \left\langle \left[\left(1 - \left(1 - T_i^-\right)^{w_i}\right)^p \cdot \left(1 - \left(1 - T_j^-\right)^{w_j}\right)^q, \left(1 - \left(1 - T_i^+\right)^{w_i}\right)^p \cdot \left(1 - \left(1 - T_j^+\right)^{w_j}\right)^q \right], \left[1 - \left(1 - (I_i^-)^{w_i}\right)^p \left(1 - (I_j^-)^{w_j}\right)^q, 1 - \left(1 - (I_i^+)^{w_i}\right)^p \left(1 - (I_j^+)^{w_j}\right)^q\right], \left[1 - \left(1 - (F_i^-)^{w_i}\right)^p \left(1 - (F_j^-)^{w_j}\right)^q, 1 - \left(1 - (F_i^+)^{w_i}\right)^p \left(1 - (F_j^+)^{w_j}\right)^q\right] \right\rangle$. Let $\alpha_{ij} = \langle [T_{ij}^-, T_{ij}^+], [I_{ij}^-, I_{ij}^+], [F_{ij}^-, F_{ij}^+] \rangle = (w_i x_i)^p \otimes (w_j x_j)^q$, we can obtain that $IVNWBM^{p,q}(x_1, x_2, \dots, x_n) = \left(\frac{1}{n(n-1)} \bigoplus_{\substack{i,j=1 \\ i \neq j}}^n \left((w_i x_i)^p \otimes (w_j x_j)^q \right) \right)^{\frac{1}{p+q}} = \left(\frac{1}{n(n-1)} \bigoplus_{\substack{i,j=1 \\ i \neq j}}^n (\alpha_{ij}) \right)^{\frac{1}{p+q}}$. By the operational laws (1) and (3) in

Definition 4, $\frac{1}{n(n-1)} \bigoplus_{\substack{i,j=1 \\ i \neq j}}^n (\alpha_{ij}) = \left\langle \left[1 - \prod_{\substack{i,j=1 \\ i \neq j}}^n \left(1 - T_{ij}^-\right)^{\frac{1}{n(n-1)}}, 1 - \prod_{\substack{i,j=1 \\ i \neq j}}^n \left(1 - T_{ij}^+\right)^{\frac{1}{n(n-1)}} \right], \left[\prod_{\substack{i,j=1 \\ i \neq j}}^n \left(I_{ij}^-\right)^{\frac{1}{n(n-1)}}, \prod_{\substack{i,j=1 \\ i \neq j}}^n \left(I_{ij}^+\right)^{\frac{1}{n(n-1)}} \right], \left[\prod_{\substack{i,j=1 \\ i \neq j}}^n \left(F_{ij}^-\right)^{\frac{1}{n(n-1)}}, \prod_{\substack{i,j=1 \\ i \neq j}}^n \left(F_{ij}^+\right)^{\frac{1}{n(n-1)}} \right] \right\rangle$. Therefore, $IVNWBM^{p,q}(x_1, x_2, \dots, x_n) = \left(\frac{1}{n(n-1)} \bigoplus_{\substack{i,j=1 \\ i \neq j}}^n (\alpha_{ij}) \right)^{\frac{1}{p+q}} = \left\langle \left[\left(1 - \prod_{\substack{i,j=1 \\ i \neq j}}^n \left(1 - T_{ij}^-\right)^{\frac{1}{n(n-1)}}\right)^{\frac{1}{p+q}}, \left(1 - \prod_{\substack{i,j=1 \\ i \neq j}}^n \left(1 - T_{ij}^+\right)^{\frac{1}{n(n-1)}}\right)^{\frac{1}{p+q}} \right], \left[1 - \left(1 - \prod_{\substack{i,j=1 \\ i \neq j}}^n \left(I_{ij}^-\right)^{\frac{1}{n(n-1)}}\right)^{\frac{1}{p+q}}, 1 - \left(1 - \prod_{\substack{i,j=1 \\ i \neq j}}^n \left(I_{ij}^+\right)^{\frac{1}{n(n-1)}}\right)^{\frac{1}{p+q}} \right], \left[1 - \left(1 - \prod_{\substack{i,j=1 \\ i \neq j}}^n \left(F_{ij}^-\right)^{\frac{1}{n(n-1)}}\right)^{\frac{1}{p+q}}, 1 - \left(1 - \prod_{\substack{i,j=1 \\ i \neq j}}^n \left(F_{ij}^+\right)^{\frac{1}{n(n-1)}}\right)^{\frac{1}{p+q}} \right] \right\rangle = \left\langle \left[\left(1 - \prod_{\substack{i,j=1 \\ i \neq j}}^n \left(1 - \left(1 - (1 - T_i^-)^{w_i}\right)^p \left(1 - (1 - T_j^-)^{w_j}\right)^q\right)^{\frac{1}{n(n-1)}}\right)^{\frac{1}{p+q}}, \left(1 - \prod_{\substack{i,j=1 \\ i \neq j}}^n \left(1 - \left(1 - (1 - T_i^+)^{w_i}\right)^p \left(1 - (1 - T_j^+)^{w_j}\right)^q\right)^{\frac{1}{n(n-1)}}\right)^{\frac{1}{p+q}} \right], \left[1 - \left(1 - \prod_{\substack{i,j=1 \\ i \neq j}}^n \left(1 - \left(1 - (I_i^-)^{w_i}\right)^p \left(1 - (I_j^-)^{w_j}\right)^q\right)^{\frac{1}{n(n-1)}}\right)^{\frac{1}{p+q}}, 1 - \left(1 - \prod_{\substack{i,j=1 \\ i \neq j}}^n \left(1 - \left(1 - (I_i^+)^{w_i}\right)^p \left(1 - (I_j^+)^{w_j}\right)^q\right)^{\frac{1}{n(n-1)}}\right)^{\frac{1}{p+q}} \right], \left[1 - \left(1 - \prod_{\substack{i,j=1 \\ i \neq j}}^n \left(1 - \left(1 - (F_i^-)^{w_i}\right)^p \left(1 - (F_j^-)^{w_j}\right)^q\right)^{\frac{1}{n(n-1)}}\right)^{\frac{1}{p+q}}, 1 - \left(1 - \prod_{\substack{i,j=1 \\ i \neq j}}^n \left(1 - \left(1 - (F_i^+)^{w_i}\right)^p \left(1 - (F_j^+)^{w_j}\right)^q\right)^{\frac{1}{n(n-1)}}\right)^{\frac{1}{p+q}} \right] \right\rangle$.

In addition, the following inequalities are right:

$$0 \leq \left(1 - \left(1 - \prod_{\substack{i,j=1 \\ i \neq j}}^n \left(1 - \left(1 - T_i^- \right)^{w_i} \right)^p \left(1 - \left(1 - T_j^- \right)^{w_j} \right)^q \right)^{\frac{1}{n(n-1)}} \right)^{\frac{1}{p+q}} \leq 1, \quad 0 \leq \left(1 - \left(1 - \prod_{\substack{i,j=1 \\ i \neq j}}^n \left(1 - \left(1 - T_i^+ \right)^{w_i} \right)^p \left(1 - \left(1 - T_j^+ \right)^{w_j} \right)^q \right)^{\frac{1}{n(n-1)}} \right)^{\frac{1}{p+q}} \leq 1,$$

$$0 \leq 1 - \left(1 - \prod_{\substack{i,j=1 \\ i \neq j}}^n \left(1 - \left(1 - (I_i^-)^{w_i} \right)^p \left(1 - (I_j^-)^{w_j} \right)^q \right)^{\frac{1}{n(n-1)}} \right)^{\frac{1}{p+q}} \leq 1$$

$$0 \leq 1 - \left(1 - \prod_{\substack{i,j=1 \\ i \neq j}}^n \left(1 - \left(1 - (I_i^+)^{w_i} \right)^p \left(1 - (I_j^+)^{w_j} \right)^q \right)^{\frac{1}{n(n-1)}} \right)^{\frac{1}{p+q}} \leq 1$$

$$0 \leq 1 - \left(1 - \prod_{\substack{i,j=1 \\ i \neq j}}^n \left(1 - \left(1 - (F_i^-)^{w_i} \right)^p \left(1 - (F_j^-)^{w_j} \right)^q \right)^{\frac{1}{n(n-1)}} \right)^{\frac{1}{p+q}} \leq 1$$

and

$$0 \leq 1 - \left(1 - \prod_{\substack{i,j=1 \\ i \neq j}}^n \left(1 - \left(1 - (F_i^+)^{w_i} \right)^p \left(1 - (F_j^+)^{w_j} \right)^q \right)^{\frac{1}{n(n-1)}} \right)^{\frac{1}{p+q}} \leq 1 \text{ which meets the requirements of an IVNN.}$$

Hence, Theorem 2 is true.

Proof of Theorem 3.

According to the operations (1) and (3) in Definition 4, we have $px_i = \left\langle \left[1 - (1 - T_i^-)^p, 1 - (1 - T_i^+)^p \right], [(I_i^-)^p, (I_i^+)^p], [(F_i^-)^p, (F_i^+)^p] \right\rangle$ and $qx_j = \left\langle \left[1 - (1 - T_j^-)^q, 1 - (1 - T_j^+)^q \right], [(I_j^-)^q, (I_j^+)^q], [(F_j^-)^q, (F_j^+)^q] \right\rangle$, then $px_i \oplus qx_j = \left\langle \left[1 - (1 - T_i^-)^p (1 - T_j^-)^q, 1 - (1 - T_i^+)^p (1 - T_j^+)^q \right], [(I_i^-)^p (I_j^-)^q, (I_i^+)^p (I_j^+)^q], [(F_i^-)^p (F_j^-)^q, (F_i^+)^p (F_j^+)^q] \right\rangle$. Let $\alpha_{ij} = \left\langle [T_{ij}^-, T_{ij}^+], [I_{ij}^-, I_{ij}^+], [F_{ij}^-, F_{ij}^+] \right\rangle = px_i \oplus qx_j = \left\langle \left[1 - (1 - T_i^-)^p (1 - T_j^-)^q, 1 - (1 - T_i^+)^p (1 - T_j^+)^q \right], [(I_i^-)^p (I_j^-)^q, (I_i^+)^p (I_j^+)^q], [(F_i^-)^p (F_j^-)^q, (F_i^+)^p (F_j^+)^q] \right\rangle$, then $IVNGBM^{p,q}(x_1, x_2, \dots, x_n) = \frac{1}{p+q} \left(\bigotimes_{\substack{i,j=1 \\ i \neq j}}^n (px_i \oplus qx_j)^{\frac{1}{n(n-1)}} \right) = \frac{1}{p+q} \left(\bigotimes_{\substack{i,j=1 \\ i \neq j}}^n (\alpha_{ij})^{\frac{1}{n(n-1)}} \right)$.

According to the operation (4) in Definition 4, $(\alpha_{ij})^{\frac{1}{n(n-1)}} = \left\langle \left[(T_{ij}^-)^{\frac{1}{n(n-1)}}, (T_{ij}^+)^{\frac{1}{n(n-1)}} \right], \left[1 - (1 - I_{ij}^-)^{\frac{1}{n(n-1)}}, 1 - (1 - I_{ij}^+)^{\frac{1}{n(n-1)}} \right], \left[1 - (1 - F_{ij}^-)^{\frac{1}{n(n-1)}}, 1 - (1 - F_{ij}^+)^{\frac{1}{n(n-1)}} \right] \right\rangle$. And according to the operation (2) in Definition 4,

$\bigotimes_{\substack{i,j=1 \\ i \neq j}}^n (\alpha_{ij})^{\frac{1}{n(n-1)}} = \left\langle \left[\prod_{\substack{i,j=1 \\ i \neq j}}^n (T_{ij}^-)^{\frac{1}{n(n-1)}}, \prod_{\substack{i,j=1 \\ i \neq j}}^n (T_{ij}^+)^{\frac{1}{n(n-1)}} \right], \left[1 - \prod_{\substack{i,j=1 \\ i \neq j}}^n (1 - I_{ij}^-)^{\frac{1}{n(n-1)}}, 1 - \prod_{\substack{i,j=1 \\ i \neq j}}^n (1 - I_{ij}^+)^{\frac{1}{n(n-1)}} \right], \left[1 - \prod_{\substack{i,j=1 \\ i \neq j}}^n (1 - F_{ij}^-)^{\frac{1}{n(n-1)}}, 1 - \prod_{\substack{i,j=1 \\ i \neq j}}^n (1 - F_{ij}^+)^{\frac{1}{n(n-1)}} \right] \right\rangle$. According to the operation (4) in Definition 4, $\frac{1}{p+q} \bigotimes_{\substack{i,j=1 \\ i \neq j}}^n (\alpha_{ij})^{\frac{1}{n(n-1)}} =$

$$\left\langle \left[1 - \left(1 - \prod_{\substack{i,j=1 \\ i \neq j}}^n (T_{ij}^-)^{\frac{1}{n(n-1)}} \right)^{\frac{1}{p+q}}, 1 - \left(1 - \prod_{\substack{i,j=1 \\ i \neq j}}^n (T_{ij}^+)^{\frac{1}{n(n-1)}} \right)^{\frac{1}{p+q}} \right], \left[\left(1 - \prod_{\substack{i,j=1 \\ i \neq j}}^n (1 - I_{ij}^-)^{\frac{1}{n(n-1)}} \right)^{\frac{1}{p+q}}, \left(1 - \prod_{\substack{i,j=1 \\ i \neq j}}^n (1 - I_{ij}^+)^{\frac{1}{n(n-1)}} \right)^{\frac{1}{p+q}} \right] \right\rangle,$$

$$\left[\left(1 - \prod_{\substack{i,j=1 \\ i \neq j}}^n (1 - F_{ij}^-)^{\frac{1}{n(n-1)}} \right)^{\frac{1}{p+q}}, \left(1 - \prod_{\substack{i,j=1 \\ i \neq j}}^n (1 - F_{ij}^+)^{\frac{1}{n(n-1)}} \right)^{\frac{1}{p+q}} \right] = \left\langle \left[1 - \left(1 - \prod_{\substack{i,j=1 \\ i \neq j}}^n (1 - (1 - T_i^-)^p (1 - T_j^-)^q)^{\frac{1}{n(n-1)}} \right)^{\frac{1}{p+q}}, \right. \right. \\ \left. \left. 1 - \left(1 - \prod_{\substack{i,j=1 \\ i \neq j}}^n (1 - (1 - T_i^+)^p (1 - T_j^+)^q)^{\frac{1}{n(n-1)}} \right)^{\frac{1}{p+q}} \right], \left[\left(1 - \prod_{\substack{i,j=1 \\ i \neq j}}^n (1 - (I_i^-)^p (I_j^-)^q)^{\frac{1}{n(n-1)}} \right)^{\frac{1}{p+q}}, \right. \right. \\ \left. \left. \left(1 - \prod_{\substack{i,j=1 \\ i \neq j}}^n (1 - (I_i^+)^p (I_j^+)^q)^{\frac{1}{n(n-1)}} \right)^{\frac{1}{p+q}} \right], \left[\left(1 - \prod_{\substack{i,j=1 \\ i \neq j}}^n (1 - (F_i^-)^p (F_j^-)^q)^{\frac{1}{n(n-1)}} \right)^{\frac{1}{p+q}}, \left(1 - \prod_{\substack{i,j=1 \\ i \neq j}}^n (1 - (F_i^+)^p (F_j^+)^q)^{\frac{1}{n(n-1)}} \right)^{\frac{1}{p+q}} \right] \right\rangle.$$

Moreover, the following inequalities hold:

$$0 \leq 1 - \left(1 - \prod_{\substack{i,j=1 \\ i \neq j}}^n (1 - (1 - T_i^-)^p (1 - T_j^-)^q)^{\frac{1}{n(n-1)}} \right)^{\frac{1}{p+q}} \leq 1, \quad 0 \leq 1 - \left(1 - \prod_{\substack{i,j=1 \\ i \neq j}}^n (1 - (1 - T_i^+)^p (1 - T_j^+)^q)^{\frac{1}{n(n-1)}} \right)^{\frac{1}{p+q}} \leq 1, \\ 0 \leq \left(1 - \prod_{\substack{i,j=1 \\ i \neq j}}^n (1 - (I_i^-)^p (I_j^-)^q)^{\frac{1}{n(n-1)}} \right)^{\frac{1}{p+q}} \leq 1, \quad 0 \leq \left(1 - \prod_{\substack{i,j=1 \\ i \neq j}}^n (1 - (I_i^+)^p (I_j^+)^q)^{\frac{1}{n(n-1)}} \right)^{\frac{1}{p+q}} \leq 1, \\ 0 \leq \left(1 - \prod_{\substack{i,j=1 \\ i \neq j}}^n (1 - (F_i^-)^p (F_j^-)^q)^{\frac{1}{n(n-1)}} \right)^{\frac{1}{p+q}} \leq 1 \text{ and } 0 \leq \left(1 - \prod_{\substack{i,j=1 \\ i \neq j}}^n (1 - (F_i^+)^p (F_j^+)^q)^{\frac{1}{n(n-1)}} \right)^{\frac{1}{p+q}} \leq 1, \text{ which meets the}$$

requirements of an IVNN.

Therefore, Theorem 3 holds.

Proof of Theorem 4.

By the operation (4) in Definition 4, we have $x_i^{w_i} = \left\langle \left[(T_i^-)^{w_i}, (T_i^+)^{w_i} \right], \left[1 - (1 - I_i^-)^{w_i}, 1 - (1 - I_i^+)^{w_i} \right], \left[1 - (1 - F_i^-)^{w_i}, 1 - (1 - F_i^+)^{w_i} \right] \right\rangle$ and $x_j^{w_j} = \left\langle \left[(T_j^-)^{w_j}, (T_j^+)^{w_j} \right], \left[1 - (1 - I_j^-)^{w_j}, 1 - (1 - I_j^+)^{w_j} \right], \left[1 - (1 - F_j^-)^{w_j}, 1 - (1 - F_j^+)^{w_j} \right] \right\rangle$. And according to the operation (4) in Definition 4, $px_i^{w_i} = \left\langle \left[1 - (1 - (T_i^-)^{w_i})^p, 1 - (1 - (T_i^+)^{w_i})^p \right], \left[(1 - (1 - I_i^-)^{w_i})^p, (1 - (1 - I_i^+)^{w_i})^p \right], \left[(1 - (1 - F_i^-)^{w_i})^p, (1 - (1 - F_i^+)^{w_i})^p \right] \right\rangle$ and $qx_j^{w_j} = \left\langle \left[1 - (1 - (T_j^-)^{w_j})^q, 1 - (1 - (T_j^+)^{w_j})^q \right], \left[(1 - (1 - I_j^-)^{w_j})^q, (1 - (1 - I_j^+)^{w_j})^q \right], \left[(1 - (1 - F_j^-)^{w_j})^q, (1 - (1 - F_j^+)^{w_j})^q \right] \right\rangle$. Then, $px_i^{w_i} + qx_j^{w_j} = \left\langle \left[1 - (1 - (T_i^-)^{w_i})^p (1 - (T_j^-)^{w_j})^q, 1 - (1 - (T_i^+)^{w_i})^p (1 - (T_j^+)^{w_j})^q \right], \left[(1 - (1 - I_i^-)^{w_i})^p (1 - (1 - I_j^-)^{w_j})^q, (1 - (1 - I_i^+)^{w_i})^p (1 - (1 - I_j^+)^{w_j})^q \right], \left[(1 - (1 - F_i^-)^{w_i})^p (1 - (1 - F_j^-)^{w_j})^q, (1 - (1 - F_i^+)^{w_i})^p (1 - (1 - F_j^+)^{w_j})^q \right] \right\rangle$.

$$\left. \left. \left(1 - (1 - F_i^+)^{w_i} \right)^p \left(1 - (1 - F_j^+)^{w_j} \right)^q \right) \right] \right\rangle. \quad \text{Let} \quad \alpha_{ij} = \langle [T_{ij}^-, T_{ij}^+], [I_{ij}^-, I_{ij}^+], [F_{ij}^-, F_{ij}^+] \rangle = px_i^{w_i} \oplus qx_j^{w_j} =$$

$$\left\langle \left[1 - \left(1 - (T_i^-)^{w_i} \right)^p \left(1 - (T_j^-)^{w_j} \right)^q, 1 - \left(1 - (T_i^+)^{w_i} \right)^p \left(1 - (T_j^+)^{w_j} \right)^q \right], \left[1 - \left(1 - I_i^- \right)^{w_i} \right]^p \left(1 - \left(1 - I_j^- \right)^{w_j} \right)^q, \right.$$

$$\left. \left. \left. \left. \left. \left(1 - \left(1 - I_i^+ \right)^{w_i} \right)^p \left(1 - \left(1 - I_j^+ \right)^{w_j} \right)^q \right], \left[\left(1 - \left(1 - F_i^- \right)^{w_i} \right)^p \left(1 - \left(1 - F_j^- \right)^{w_j} \right)^q, \left(1 - \left(1 - F_i^+ \right)^{w_i} \right)^p \left(1 - \left(1 - F_j^+ \right)^{w_j} \right)^q \right] \right] \right\rangle, \quad ,$$

according to the operation (4) in Definition 4, $(\alpha_{ij})^{\frac{1}{n(n-1)}} = \left\langle \left[(T_{ij}^-)^{\frac{1}{n(n-1)}}, (T_{ij}^+)^{\frac{1}{n(n-1)}} \right], \left[1 - \left(1 - I_{ij}^- \right)^{\frac{1}{n(n-1)}}, \right.$

$$\left. \left. \left. \left. 1 - \left(1 - I_{ij}^+ \right)^{\frac{1}{n(n-1)}} \right], \left[1 - \left(1 - F_{ij}^- \right)^{\frac{1}{n(n-1)}}, 1 - \left(1 - F_{ij}^+ \right)^{\frac{1}{n(n-1)}} \right] \right\rangle.$$
 And according to the operation (2) in Definition 4,

$$\bigotimes_{\substack{i,j=1 \\ i \neq j}}^n (\alpha_{ij})^{\frac{1}{n(n-1)}} = \left\langle \left[\prod_{\substack{i,j=1 \\ i \neq j}}^n (T_{ij}^-)^{\frac{1}{n(n-1)}}, \prod_{\substack{i,j=1 \\ i \neq j}}^n (T_{ij}^+)^{\frac{1}{n(n-1)}} \right], \left[1 - \prod_{\substack{i,j=1 \\ i \neq j}}^n \left(1 - I_{ij}^- \right)^{\frac{1}{n(n-1)}}, 1 - \prod_{\substack{i,j=1 \\ i \neq j}}^n \left(1 - I_{ij}^+ \right)^{\frac{1}{n(n-1)}} \right], \left[1 - \prod_{\substack{i,j=1 \\ i \neq j}}^n \left(1 - F_{ij}^- \right)^{\frac{1}{n(n-1)}}, \right.$$

$$\left. \left. \left. \left. 1 - \prod_{\substack{i,j=1 \\ i \neq j}}^n \left(1 - F_{ij}^+ \right)^{\frac{1}{n(n-1)}} \right] \right\rangle.$$
 Then, $IVNWGBM^{p,q}(x_1, x_2, \dots, x_n) = \frac{1}{p+q} \left(\bigotimes_{\substack{i,j=1 \\ i \neq j}}^n (\alpha_{ij})^{\frac{1}{n(n-1)}} \right) =$

$$\left\langle \left[1 - \left(1 - \prod_{\substack{i,j=1 \\ i \neq j}}^n (T_{ij}^-)^{\frac{1}{n(n-1)}} \right)^{\frac{1}{p+q}}, 1 - \left(1 - \prod_{\substack{i,j=1 \\ i \neq j}}^n (T_{ij}^+)^{\frac{1}{n(n-1)}} \right)^{\frac{1}{p+q}} \right], \left[\left(1 - \prod_{\substack{i,j=1 \\ i \neq j}}^n \left(1 - I_{ij}^- \right)^{\frac{1}{n(n-1)}} \right)^{\frac{1}{p+q}}, \left(1 - \prod_{\substack{i,j=1 \\ i \neq j}}^n \left(1 - I_{ij}^+ \right)^{\frac{1}{n(n-1)}} \right)^{\frac{1}{p+q}} \right], \right.$$

$$\left. \left[\left(1 - \prod_{\substack{i,j=1 \\ i \neq j}}^n \left(1 - F_{ij}^- \right)^{\frac{1}{n(n-1)}} \right)^{\frac{1}{p+q}}, \left(1 - \prod_{\substack{i,j=1 \\ i \neq j}}^n \left(1 - F_{ij}^+ \right)^{\frac{1}{n(n-1)}} \right)^{\frac{1}{p+q}} \right] \right\rangle = \left\langle \left[1 - \left(1 - \prod_{\substack{i,j=1 \\ i \neq j}}^n \left(1 - \left(1 - (T_i^-)^{w_i} \right)^p \left(1 - (T_j^-)^{w_j} \right)^q \right)^{\frac{1}{n(n-1)}} \right)^{\frac{1}{p+q}}, \right.$$

$$\left. \left. \left. \left. 1 - \left(1 - \prod_{\substack{i,j=1 \\ i \neq j}}^n \left(1 - \left(1 - (T_i^+)^{w_i} \right)^p \left(1 - (T_j^+)^{w_j} \right)^q \right)^{\frac{1}{n(n-1)}} \right)^{\frac{1}{p+q}} \right], \left[\left(1 - \prod_{\substack{i,j=1 \\ i \neq j}}^n \left(1 - \left(1 - \left(1 - I_i^- \right)^{w_i} \right)^p \left(1 - \left(1 - I_j^- \right)^{w_j} \right)^q \right)^{\frac{1}{n(n-1)}} \right)^{\frac{1}{p+q}}, \right.$$

$$\left. \left[\left(1 - \prod_{\substack{i,j=1 \\ i \neq j}}^n \left(1 - \left(1 - \left(1 - I_i^+ \right)^{w_i} \right)^p \left(1 - \left(1 - I_j^+ \right)^{w_j} \right)^q \right)^{\frac{1}{n(n-1)}} \right)^{\frac{1}{p+q}}, \left[\left(1 - \prod_{\substack{i,j=1 \\ i \neq j}}^n \left(1 - \left(1 - \left(1 - F_i^- \right)^{w_i} \right)^p \left(1 - \left(1 - F_j^- \right)^{w_j} \right)^q \right)^{\frac{1}{n(n-1)}} \right)^{\frac{1}{p+q}}, \right.$$

$$\left. \left. \left. \left. \left. \left(1 - \prod_{\substack{i,j=1 \\ i \neq j}}^n \left(1 - \left(1 - \left(1 - F_i^+ \right)^{w_i} \right)^p \left(1 - \left(1 - F_j^+ \right)^{w_j} \right)^q \right)^{\frac{1}{n(n-1)}} \right)^{\frac{1}{p+q}} \right] \right] \right\rangle.$$

Additionally, the following inequalities are proved to be true:

$$0 \leq 1 - \left[1 - \prod_{\substack{i,j=1 \\ i \neq j}}^n \left(1 - \left(1 - (T_i^-)^{w_i} \right)^p \left(1 - (T_j^-)^{w_j} \right)^q \right)^{\frac{1}{n(n-1)}} \right]^{\frac{1}{p+q}} \leq 1$$

$$0 \leq 1 - \left(1 - \prod_{\substack{i,j=1 \\ i \neq j}}^n \left(1 - \left(1 - (T_i^+)^{w_i} \right)^p \left(1 - (T_j^+)^{w_j} \right)^q \right)^{\frac{1}{n(n-1)}} \right)^{\frac{1}{p+q}} \leq 1$$

$$0 \leq \left(1 - \prod_{\substack{i,j=1 \\ i \neq j}}^n \left(1 - \left(1 - (1 - I_i^-)^{w_i} \right)^p \left(1 - (1 - I_j^-)^{w_j} \right)^q \right)^{\frac{1}{n(n-1)}} \right)^{\frac{1}{p+q}} \leq 1$$

$$0 \leq \left(1 - \prod_{\substack{i,j=1 \\ i \neq j}}^n \left(1 - \left(1 - (1 - I_i^+)^{w_i} \right)^p \left(1 - (1 - I_j^+)^{w_j} \right)^q \right)^{\frac{1}{n(n-1)}} \right)^{\frac{1}{p+q}} \leq 1, \quad 0 \leq \left(1 - \prod_{\substack{i,j=1 \\ i \neq j}}^n \left(1 - \left(1 - (1 - F_i^-)^{w_i} \right)^p \left(1 - (1 - F_j^-)^{w_j} \right)^q \right)^{\frac{1}{n(n-1)}} \right)^{\frac{1}{p+q}} \leq 1$$

and $0 \leq \left(1 - \prod_{\substack{i,j=1 \\ i \neq j}}^n \left(1 - \left(1 - (1 - F_i^+)^{w_i} \right)^p \left(1 - (1 - F_j^+)^{w_j} \right)^q \right)^{\frac{1}{n(n-1)}} \right)^{\frac{1}{p+q}} \leq 1$, which meets the requirements of an IVNN.

Hence, Theorem 4 is true.

REFERENCES

- Aghdaie, M. H., Zolfani, S. H., & Zavadskas, E. K. (2013). Market segment evaluation and selection based on application of fuzzy AHP and COPRAS-G methods. *Journal of Business Economics and Management*, 14(1), 213-233.
- Ananda, J., & Herath, G. (2009). A critical review of multi-criteria decision making methods with special reference to forest management and planning. *Ecological Economics*, 68, 2535-2548.
- Beliakov, G., James, S., Mordelová, J., Rückschlossová, T., & Yager, R. R. (2010). Generalized Bonferroni mean operators in multi-criteria aggregation. *Fuzzy Sets and Systems*, 161(17), 2227-2242.
- Bellman, R. E., & Zadeh, L. A. (1970). Decision-making in a fuzzy environment. *Management Science*, 17(4), B141-B164.
- Bonferroni, C. (1950). Sulle medie multiple di potenze. *Bollettino dell'Unione Matematica Italiana*, 5(3-4), 267-270.
- Cao, Y. X., Zhou, H., & Wang, J. Q. (2016). An approach to interval-valued intuitionistic stochastic multi-criteria decision-making using set pair analysis. *International Journal of Machine Learning & Cybernetics*, doi: 10.1007/s13042-016-0589-9.
- Chi, P. P., & Liu, P. D. (2013). An extended TOPSIS method for the multiple attribute decision making problems based on interval neutrosophic set. *Neutrosophic Sets and Systems*, 1(1), 63-70.
- Cristóbal, J. R. S. (2011). Multi-criteria decision-making in the selection of a renewable energy project in Spain: The VIKOR method. *Renewable Energy*, 36(2), 498-502.
- Govindan, K., Rajendran, S., Sarkis, J., & Murugesan, P. (2015). Multi criteria decision making approaches for green supplier evaluation and selection: A literature review. *Journal of Cleaner Production*, 98, 66-83.
- Ho, W., Xu, X., & Dey, P. K. (2010). Multi-criteria decision making approaches for supplier evaluation and selection: A literature review. *European Journal of Operational Research*, 202, 16-24.
- Ji, P., Wang, J. Q., & Zhang, H. Y. (2016). Frank prioritized Bonferroni mean operator with single-valued neutrosophic sets and its application in selecting third party logistics. *Neural Computing and Applications*, doi: 10.1007/s00521-016-2660-6.
- Ji, P., Zhang, H. Y., & Wang, J. Q. (2016). A projection-based TODIM method under multi-valued neutrosophic environments and its application in personnel selection. *Neural Computing and Applications*, doi: 10.1007/s00521-016-2436-z.
- Joshi, B. P., & Kumar, S. (2012). Fuzzy time series model based on intuitionistic fuzzy sets for empirical research in stock market. *International Journal of Applied Evolutionary Computation*, 3, 71-84.
- Kaya, T., & Kahraman, C. (2010). Multicriteria renewable energy planning using an integrated fuzzy VIKOR & AHP methodology: The case of Istanbul. *Energy*, 35(6), 2517-2527.
- Khalili-Damghani, K., M., T., Santos-Arteaga, F. J., & Mohtasham, S. (2015). A dynamic multi-stage data envelopment analysis model with application to energy consumption in the cotton industry. *Energy Economics*, 51, 320-328.
- Liang, R.-x., Wang, J.-q., & Li, L. (2016). Multi-criteria group decision making method based on interdependent inputs of single valued trapezoidal neutrosophic information. *Neural Computing and Applications*, doi: 10.1007/s00521-016-2672-2.

- Liu, P. D., & Wang, Y. M. (2014). Multiple attribute decision-making method based on single-valued neutrosophic normalized weighted Bonferroni mean. *Neural Computing and Applications*, 25(7-8), 2001-2010.
- Ma, H., Hu, Z., Li, K., & Zhang, H. (2016). Toward trustworthy cloud service selection: A time-aware approach using interval neutrosophic set. *Journal of Parallel & Distributed Computing*, 96, 75-94.
- Ma, Y. X., Wang, J. Q., Wang, J., & Wu, X. H. (2016). An interval neutrosophic linguistic multi-criteria group decision-making method and its application in selecting medical treatment options. *Neural Computing and Applications*, doi: 10.1007/s00521-016-2203-1.
- Majumdar, P., & Samanta, S. K. (2014). On similarity and entropy of neutrosophic sets. *Journal of Intelligent & Fuzzy Systems Applications in Engineering & Technology*, 26(3), 1245-1252.
- Mardani, A., Jusoh, A., Zavadskas, E. K., Cavallaro, F., & Khalifah, Z. (2015). Sustainable and renewable energy: An overview of the application of multiple criteria decision making techniques and approaches. *Sustainability*, 7(10), 135-175.
- Peng, H.-g., & Wang, J.-q. (2016). Hesitant uncertain linguistic Z-numbers and their application in multi-criteria group decision-making problems. *International Journal of Fuzzy Systems*, doi: 10.1007/s40815-016-0257-y.
- Peng, J.-j., Wang, J.-q., Wu, X.-h., Wang, J., & Chen, X.-h. (2015). Multi-valued neutrosophic sets and power aggregation operators with their applications in multi-criteria group decision-making problems. *International Journal of Computational Intelligence Systems*, 8(4), 345-363.
- Peng, J., Wang, J., & Yang, W. (2017). A multi-valued neutrosophic qualitative flexible approach based on likelihood for multi-criteria decision-making problems. *International Journal of Systems Science*, 48(2), 425-435.
- Peng, J. J., Wang, J. Q., Wang, J., Yang, L. J., & Chen, X. H. (2015). An extension of ELECTRE to multi-criteria decision-making problems with multi-hesitant fuzzy sets. *Information Sciences*, 307, 113-126.
- Peng, J. J., Wang, J. Q., Wang, J., Zhang, H. Y., & Chen, X. H. (2016). Simplified neutrosophic sets and their applications in multi-criteria group decision-making problems. *International Journal of Systems Science*, 47(10), 2342-2358.
- Peng, J. J., Wang, J. Q., Zhang, H. Y., & Chen, X. H. (2014). An outranking approach for multi-criteria decision-making problems with simplified neutrosophic sets. *Applied Soft Computing*, 25(C), 336-346.
- Rivieccio, U. (2008). Neutrosophic logics: Prospects and problems. *Fuzzy Sets and Systems*, 159(14), 1860-1868.
- Şahin, R. (2014). Multi-criteria neutrosophic decision making method based on score and accuracy functions under neutrosophic environment. *arXiv preprint arXiv:1412.5202*.
- Şahin, R., & Karabacak, M. (2015). A multi attribute decision making method based on inclusion measure for interval neutrosophic sets. *International Journal of Engineering and Applied Sciences*, 2(2), 13-15.
- Şahin, R., & Liu, P. (2016). Maximizing deviation method for neutrosophic multiple attribute decision making with incomplete weight information. *Neural Computing and Applications*, 27(7), 2017-2029.
- Shinoj, T. K., & Sunil, J. J. (2012). Intuitionistic fuzzy multisets and its application in medical diagnosis. *International Journal of Mathematical and Computational Sciences*, 6, 34-37.
- Smarandache, F. (1998). *Neutrosophy: Neutrosophic probability, set, and logic*. Rehoboth.
- Smarandache, F. (1999). A unifying field in logics: Neutrosophic logic, neutrosophy, neutrosophic set, probability. *American Research Press, Rehoboth*.
- Smarandache, F. (2013). N-valued refined neutrosophic logic and its applications to physics. *Progress in Physics*, 4, 143-146.
- Tian, Z., Zhang, H., Wang, J., Wang, J., & Chen, X. (2016). Multi-criteria decision-making method based on a cross-entropy with interval neutrosophic sets. *International Journal of Systems Science*, 47(15), 3598-3608.
- Tian, Z. P., Wang, J., Wang, J. Q., & Chen, X. H. (2015). Multi-criteria decision-making approach based on gray linguistic weighted Bonferroni mean operator. *International Transactions in Operational Research*, doi: 10.1111/itor.12220.
- Tian, Z. P., Wang, J., Wang, J. Q., & Zhang, H. Y. (2016a). An improved MULTIMOORA approach for multi-criteria decision-making based on interdependent inputs of simplified neutrosophic linguistic information. *Neural Computing and Applications*, doi:10.1007/s00521-016-2378-5.
- Tian, Z. P., Wang, J., Wang, J. Q., & Zhang, H. Y. (2016b). Simplified neutrosophic linguistic multi-criteria group decision-making approach to green product development. *Group Decision and Negotiation*, doi: 10.1007/s10726-016-9479-5.
- Tian, Z. P., Wang, J., Zhang, H. Y., Chen, X. H., & Wang, J. Q. (2015). Simplified neutrosophic linguistic normalized weighted Bonferroni mean operator and its application to multi-criteria decision-making problems. *FILOMAT*, doi: 10.1080/00207721.2015.1102359.
- Tian, Z. P., Wang, J., Zhang, H. Y., & Wang, J. Q. (2016). Multi-criteria decision-making based on generalized prioritized aggregation operators under simplified neutrosophic uncertain linguistic environment. *International Journal of Machine Learning & Cybernetics*, doi: 10.1007/s13042-016-0552-9.

- Troldborg, M., Heslop, S., & Hough, R. L. (2014). Assessing the sustainability of renewable energy technologies using multi-criteria analysis: Suitability of approach for national-scale assessments and associated uncertainties. *Renewable and Sustainable Energy Reviews*, 39, 1173-1184.
- Turksen, I. B. (1986). Interval valued fuzzy sets based on normal forms. *Fuzzy Sets and Systems*, 20(2), 191-210.
- Wang, B., Nistor, I., Murty, T., & Wei, Y.-M. (2014). Efficiency assessment of hydroelectric power plants in Canada: A multi criteria decision making approach. *Energy Economics*, 46, 112-121.
- Wang, H. B., Smarandache, F., Zhang, Y. Q., & Sunderraman, R. (2005). *Interval neutrosophic sets and logic: Theory and applications in computing* (Vol. 5): Hexis, Arizona.
- Wang, H. B., Smarandache, F., Zhang, Y. Q., & Sunderraman, R. (2010). Single valued neutrosophic sets. *Review of the Air Force Academy*, 10-14.
- Wang, J. Q., Han, Z. Q., & Zhang, H. Y. (2014). Multi-criteria group decision-making method based on intuitionistic interval fuzzy information. *Group Decision and Negotiation*, 23(4), 715-733.
- Wang, J. Q., Wu, J. T., Wang, J., Zhang, H. Y., & Chen, X. H. (2016). Multi-criteria decision-making methods based on the Hausdorff distance of hesitant fuzzy linguistic numbers. *Soft Computing*, 20(4), 1621-1633.
- Wang, J. Q., Yang, Y., & Li, L. (2016). Multi-criteria decision-making method based on single valued neutrosophic linguistic Maclaurin symmetric mean operators. *Neural Computing and Applications*, doi: 10.1007/s00521-016-2702-0.
- Wang, X.-Z., Xing, H.-J., Li, Y., Hua, Q., Dong, C.-R., & Pedrycz, W. (2015). A study on relationship between generalization abilities and fuzziness of base classifiers in ensemble learning. *IEEE Transactions on Fuzzy Systems*, 23(5), 1638-1654. doi: 10.1109/TFUZZ.2014.2371479
- Wu, X. H., Wang, J. Q., Peng, J. J., & Chen, X. H. (2016). Cross-entropy and prioritized aggregation operator with simplified neutrosophic sets and their application in multi-criteria decision-making problems. *International Journal of Fuzzy Systems*, doi: 10.1007/s40815-016-0180-2.
- Xia, M. M., Xu, Z. S., & Zhu, B. (2012). Generalized intuitionistic fuzzy Bonferroni means. *International Journal of Intelligent Systems*, 27(1), 23-47.
- Xia, M. M., Xu, Z. S., & Zhu, B. (2013). Geometric Bonferroni means with their application in multi-criteria decision making. *Knowledge-Based Systems*, 40, 88-100.
- Xu, Z., & Yager, R. R. (2011). Intuitionistic fuzzy Bonferroni means. *IEEE Transactions on Systems Man & Cybernetics Part B Cybernetics A Publication of the IEEE Systems Man & Cybernetics Society*, 41(2), 568-578.
- Yager, R. R. (1977). Multiple objective decision-making using fuzzy sets. *International Journal of Man-Machine Studies*, 9(4), 375-382.
- Yazdani-Chamzini, A., Fouladgar, M. M., Zavadskas, E. K., & Moini, S. H. H. (2013). Selecting the optimal renewable energy using multi criteria decision making. *Journal of Business Economics and Management*, 14(5), 957-978.
- Ye, J. (2013). Multicriteria decision-making method using the correlation coefficient under single-valued neutrosophic environment. *International Journal of General Systems*, 42(4), 386-394.
- Ye, J. (2014). A multicriteria decision-making method using aggregation operators for simplified neutrosophic sets. *Journal of Intelligent and Fuzzy Systems*, 26(5), 2459-2466.
- Zadeh, L. A. (1965). Fuzzy sets. *Information and Control*, 8(3), 338-353.
- Zadeh, L. A. (1968). Probability measures of fuzzy events. *Journal of Mathematical Analysis and Applications*, 23(2), 421-427.
- Zhang, H., Ji, P., Wang, J., & Chen, X. (2015). An improved weighted correlation coefficient based on integrated weight for interval neutrosophic sets and its application in multi-criteria decision making problems. *International Journal of Computational Intelligence Systems*, 8(6), 1027-1043.
- Zhang, H., Wang, J., & Chen, X. (2016). An outranking approach for multi-criteria decision-making problems with interval-valued neutrosophic sets. *Neural Computing and Applications*, 27(3), 615-627.
- Zhang, H. Y., Ji, P., Wang, J. Q., & Chen, X. H. (2016). A neutrosophic normal cloud and its application in decision-making. *Cognitive Computation*, 8(4), 649-669.
- Zhang, H. Y., Ji, P., Wang, J. Q., & Chen, X. H. (2017). A novel decision support model for satisfactory restaurants utilizing social information: A case study of TripAdvisor.com. *Tourism Management*, 59, 281-297.
- Zhang, H. Y., Wang, J. Q., & Chen, X. H. (2014). Interval neutrosophic sets and their application in multicriteria decision making problems. *Scientific World Journal*, doi: 10.1155/2014/645953.
- Zhou, W., & He, J. M. (2012). Intuitionistic fuzzy normalized weighted Bonferroni mean and its application in multicriteria decision making. *Journal of Applied Mathematics*, doi: 10.1155/2012/136254.
- Zhu, B., & Xu, Z. S. (2013). Hesitant fuzzy Bonferroni means for multi-criteria decision making. *Journal of the Operational Research Society*, 64(12), 1831-1840.

An Approach to Measuring the Website Quality Based on Neutrosophic Sets

Dragisa Stanujkic¹, Florentin Smarandache^{2*}, Edmundas Kazimieras Zavadskas³ and Darjan Karabasevic^{4*}

¹ Faculty of Management in Zajecar, John Naisbitt University, Belgrade, Serbia. E-mail: dragisa.stanujkic@fmz.edu.rs

^{2*} Department of Mathematics, University of New Mexico, Gallup, USA. E-mail: smarand@unm.edu

³ Research Institute of Smart Building Technologies, Vilnius Gediminas Technical University, Vilnius, Lithuania. E-mail: edmundas.zavadskas@vgtu.lt

⁴ Faculty of Applied Management, Economics and Finance, University Business Academy in Novi Sad, Serbia. E-mail: darjan.karabasevic@mef.edu.rs

Corresponding author's email^{4*}: darjan.karabasevic@mef.edu.rs

ABSTRACT

Gathering the attitudes of the examined respondents would be very significant in some evaluation models. Therefore, an approach to the evaluation of websites based on the use of the neutrosophic set is proposed in this paper. An example of websites evaluation is considered at the end of this paper with the aim to present in detail the proposed approach.

KEYWORDS: neutrosophic set; single valued neutrosophic set; website quality; website evaluation; multiple criteria decision making.

1. INTRODUCTION

A company's website can have a very important role in a competitive environment. It can be used to provide information to its customers, collect new and retain old users and so on.

A website can be visited by various groups of users that could have different requirements, needs and interests. In order to assess the quality of a website, it is necessary to obtain as realistic attitudes of its visitors about the fulfillment of their expectations and the perceived reality as possible.

The evaluation of the quality of websites has been considered in numerous studies, for which reason many approaches have been proposed. Some of them have been devoted to determining the impact of the website quality on customer satisfaction, such as: Al-Manasra *et al.* (2016), Bai *et al.* (2008), Lin (2007) and Kim and Stoel (2004).

Some other studies have been intended to determine the quality of websites and/or define the elements of the website that affect its quality, such as: Canziani and Welsh (2016), Salem and Cavlek (2016), Ting *et al.* (2013), Rocha (2012), Chiou *et al.* (2011) and Kincl and Strach (2012).

In some of them, the evaluation of websites has been considered as a multiple criteria decision making-problem, including the FS theory or its extensions, such as: Stanujkic *et al.* (2015), Chou and Cheng (2012), Kaya and Kahraman (2011), and Kaya (2010).

It is also known that a significant progress in multiple criteria decision making has been made after Zadeh (1965) proposed the Fuzzy Sets (FS) theory, thus introducing partial belonging to a set, expressed by using the membership function.

The FS theory has later been extended in order to provide an effective method for solving many complex

decision-making problems, often related to uncertainties and predictions. The Interval-Valued Fuzzy Set (IVFS) Theory, proposed by Turksen (1986; 1996) and Gorzalczany (1987), the Intuitionistic Fuzzy Sets (IFS) Theory, proposed by Atanassov (1986) and the Interval-Valued Intuitionistic Fuzzy Set (IVIFS) Theory, proposed by Atanassov and Gargov (1989), can be mentioned as the prominent and widely used extensions of the FS theory.

In the IFS, Atanassov introduced the non-membership function. Smarandache (1998) proposed the Neutrosophic Set (NS) and so further generalized the IFS by introducing the indeterminacy-membership function, thus providing a general framework generalizing the concepts of the classical, fuzzy, interval-valued fuzzy and intuitionistic fuzzy sets.

Compared with the FS and its extensions, the NS can be identified as more flexible, for which reason they have been chosen in this approach for collecting the respondents' attitudes.

Therefore, this manuscript is organized as follows: in Section 2, the NSs are considered and in Section 3, the SWARA method is presented. In Section 4, a procedure for evaluating companies' websites is considered and in Section 5, its usability is demonstrated. Finally, the conclusion is given.

2. PRELIMINARIES

Definition. *Fuzzy sets* (FS). Let X be the universe of discourse, with a generic element in X denoted by x . Then, the FS \tilde{A} in X is as follows:

$$\tilde{A} = \{x(\mu_A(x)) \mid x \in X\}, \quad (1)$$

where: $\mu_A : X \rightarrow [0, 1]$ is the membership function and $\mu_A(x)$ denotes the degree of the membership of the element x in the set \tilde{A} (Zadeh, 1965).

Definition. *Intuitionistic fuzzy set* (IFS). Let X be the universe of discourse, with a generic element in X denoted by x . Then, the IFS \tilde{A} in X can be defined as follows:

$$\tilde{A} = \{x \langle \mu_A(x), \nu_A(x) \rangle \mid x \in X\}, \quad (2)$$

where: $\mu_A(x)$ and $\nu_A(x)$ are the truth-membership and the falsity-membership functions of the element x in the set A , respectively; $\mu_A, \nu_A : X \rightarrow [0, 1]$ and $0 \leq \mu_A(x) + \nu_A(x) \leq 1$.

In intuitionistic fuzzy sets, indeterminacy $\pi_A(x)$ is $1 - \mu_A(x) - \nu_A(x)$ by default (Atanassov, 1986).

Definition. *Neutrosophic set* (NS). Let X be the universe of discourse, with a generic element in X denoted by x . Then, the NS A in X is as follows:

$$A = \{x \langle T_A(x), I_A(x), F_A(x) \rangle \mid x \in X\}, \quad (3)$$

where $T_A(x)$, $I_A(x)$ and $F_A(x)$ are the truth-membership function, the indeterminacy-membership function and the falsity-membership function, respectively, $T_A, I_A, F_A : X \rightarrow]0, 1^+[$ and $^-0 \leq T_A(x) + I_A(x) + F_A(x) \leq 3^+$ (Smarandache, 1999).

Definition. *Single valued neutrosophic set* (SVNS). Let X be the universe of discourse. The SVNS A over X is an object having the form

$$A = \{x \langle T_A(x), I_A(x), F_A(x) \rangle \mid x \in X\}, \quad (4)$$

where $T_A(x)$, $I_A(x)$ and $F_A(x)$ are the truth-membership function, the intermediacy-membership function

and the falsity-membership function, respectively, $T_A, I_A, F_A : X \rightarrow [^{-}0, 1^{+}]$ and $^{-}0 \leq T_A(x) + I_A(x) + F_A(x) \leq 3^{+}$ (Wang *et al.*, 2010).

Definition. *Single valued neutrosophic number.* For the SVNS A in X the triple $\langle t_A, i_A, f_A \rangle$ is called the single valued neutrosophic number (SVNN) (Smarandache, 1999).

Definition. *Basic operations on SVNNs.* Let $x_1 = \langle t_1, i_1, f_1 \rangle$ and $x_2 = \langle t_2, i_2, f_2 \rangle$ be two SVNNs, then additive and multiplication operations are defined as follows (Smarandache, 1998):

$$x_1 + x_2 = \langle t_1 + t_2 - t_1 t_2, i_1 i_2, f_1 f_2 \rangle, \quad (5)$$

$$x_1 \cdot x_2 = \langle t_1 t_2, i_1 + i_2 - i_1 i_2, f_1 + f_2 - f_1 f_2 \rangle. \quad (6)$$

Definition. *Scalar multiplication.* Let $x = \langle t_x, i_x, f_x \rangle$ be a SVNN and $\lambda > 0$, then scalar multiplication is defined as follows (Smarandache, 1998):

$$\lambda x_1 = \langle 1 - (1 - t_1)^\lambda, i_1^\lambda, f_1^\lambda \rangle. \quad (7)$$

Definition. *Power.* Let $x = \langle t_x, i_x, f_x \rangle$ be a SVNN and $\lambda > 0$, then power is defined as follows:

$$x_1^\lambda = \langle t_1^\lambda, i_1^\lambda, 1 - (1 - f_1)^\lambda \rangle. \quad (8)$$

Definition. *Score function.* Let $x = \langle t_x, i_x, f_x \rangle$ be a SVNN, then the score function s_x of x can be as follows:

$$s_x = (1 + t_x - 2i_x - f_x) / 2, \quad (9)$$

where $s_x \in [-1, 1]$ (Smarandache, 1998).

Definition. *Accuracy function.* Let $x = \langle t_x, i_x, f_x \rangle$ be a SVNN, then the score function s_x of x can be as follows:

$$h_x = (2 + t_x - i_x - f_x) / 3, \quad (10)$$

where $h_x \in [0, 1]$ (Smarandache, 1998).

Definition. *Ranking based on score and accuracy functions.* Let x_1 and x_2 be two SVNNs. Then, the ranking method can be defined as follows (Mondal & Pramanik, 2014):

- (1) If $s_{x1} > s_{x2}$, then $x_1 > x_2$;
- (2) If $s_{x1} = s_{x2}$ and $h_{x1} \geq h_{x2}$, then $x_1 \geq x_2$.

Definition. *Single Valued Neutrosophic Weighted Average Operator.* Let $A_j = \langle t_j, i_j, f_j \rangle$ be a collection of SVNSs and $W = (w_1, w_2, \dots, w_n)^T$ is an associated weighting vector. Then, the Single Valued Neutrosophic Weighted Average (SVNWA) operator of A_j is as follows (Sahin, 2014):

$$SVNWA(A_1, A_2, \dots, A_n) = \sum_{j=1}^n w_j A_j = \left(1 - \prod_{j=1}^n (1 - t_j)^{w_j}, \prod_{j=1}^n (i_j)^{w_j}, \prod_{j=1}^n (f_j)^{w_j} \right). \quad (11)$$

where: w_j is the element j of the weighting vector, $w_j \in [0, 1]$ and $\sum_{j=1}^n w_j = 1$.

3. The SWARA Method

The Step-wise Weight Assessment Ratio Analysis (SWARA) technique was proposed by Kersulienė *et al.* (2010). The computational procedure of the adapted SWARA method can be shown through the following steps (Kersulienė *et al.*, 2010; Stanujkic *et al.*, 2015):

Step 1. Determine the set of the relevant evaluation criteria and sort them in descending order, based on their expected significances.

Step 2. Starting from the second criterion, determine the relative importance s_j of the criterion j (C_j) in relation to the previous $j-1$ C_{j-1} criterion, and do so for each particular criterion as follows:

$$s_j = \begin{cases} >1 & \text{when significance of } C_j \succ C_{j-1} \\ 1 & \text{when significance of } C_j = C_{j-1} \\ <1 & \text{when significance of } C_j \prec C_{j-1} \end{cases} \quad (12)$$

where C_j and C_{j-1} denote criteria.

Using Eq. (11) respondents can more realistically express their opinions compared to the ordinary SWARA method, proposed by Kersulienė *et al.* (2010).

Step 3. The third step in the adapted SWARA method should be performed as follows:

$$k_j = \begin{cases} 1 & j = 1 \\ 2 - s_j & j > 1 \end{cases} \quad (13)$$

where k_j is a coefficient.

Step 4. Determine the recalculated weight q_j as follows:

$$q_j = \begin{cases} 1 & j = 1 \\ \frac{q_{j-1}}{k_j} & j > 1 \end{cases} \quad (14)$$

Step 5. Determine the relative weights of the evaluation criteria as follows:

$$w_j = \frac{q_j}{\sum_{k=1}^n q_k} \quad (15)$$

where w_j denotes the relative weight of the criterion j .

4. PROCEDURE FOR EVALUATING WEBSITES BASED ON THE SINGLE VALUED NEUTROSOPHIC SET AND THE SWARA METHOD

In their studies, many authors have identified different phases in the multiple criteria decision-making process. In order to precisely define the procedures for evaluating websites, the below phases have specially been emphasized:

- the selection of evaluation criteria
- the determination of the weights of the criteria
- the evaluation of alternatives in relation to the criteria
- the aggregation and analysis of the results

Selection of Evaluation Criteria

The choice of an appropriate set of the evaluation selection criteria is very important for the successful solving of each MCDM problem.

In many published studies, a number of authors have proposed different criteria for the evaluation of various websites. For example, Kapoun (1998) has proposed the use of the following criteria: Accuracy, Authority, Objectivity, Currency and Coverage. After that, Lydia (2009) has proposed Authority, Accuracy, Objectivity, Currency, Coverage and Appearance for evaluating the quality of a website. For the evaluation of websites at the California State University at Chico (http://www.csuchico.edu/lins/handouts/eval_websites.pdf), the so-called CRAAP test, based on the following criteria: Currency, Relevance, Authority, Accuracy and Purpose, has been proposed.

In this approach, the proven set of the criteria adopted from the Webby Awards (<http://webbyawards.com/judging-criteria/>) is proposed for the evaluation of the quality of websites. This set of the evaluation criteria is as follows:

- Content (C_1),
- Structure and Navigation (C_2),
- Visual Design (C_3),
- Interactivity (C_4),
- Functionality (C_5) and
- Overall Experience (C_6).

The meaning of the proposed evaluation criteria is as follows:

- **Content.** The content is the information provided on the website. It is not just a text, but also music, a sound, an animation or a video – anything that communicates the website's body of knowledge.
- **Structure and Navigation.** The structure and navigation refer to the framework of a website, the organization of the content, the prioritization of information and the method in which you move through the website. Websites with the good structure and navigation are consistent, intuitive, and transparent.
- **Visual Design.** A visual design is the appearance of a website. It is more than just a pretty homepage and it does not have to be cutting-edge or trendy. A good visual design is high-quality, appropriate and relevant for the audience and the message it is supportive of. It communicates a visual experience and may even take your breath away.
- **Interactivity.** Interactivity is the way a site allows a user to perform an action. Good interactivity refers to providing opportunities for users to personalize their search and find information or perform some action more easily and efficiently.
- **Functionality.** Functionality is the use of technology on a website. Good functionality means that a website works well. It loads quickly, has live links and any new technology that has been used is functional and relevant for the intended audience.
- **Overall Experience.** Demonstrating that websites are frequently more or less than just the sum of their parts, overall experience encompasses the content, a visual design, functionality, interactivity and the structure and navigation, but also includes the intangibles that make one stay on the website or leave it.

Determination of the Weights of the Criteria

In this approach, the SWARA method is used for determining the weights of the criteria. The SWARA method has been chosen because it is relatively simple to use and requires a relatively small number of comparisons in pairs.

The determination of the weights of the criteria is done by using an interactive questionnaire made in a spreadsheet file. By using such an approach, the interviewee can see the calculated weights of the criteria and can also modify his/her answers if he or she is not satisfied with the calculated weights.

Evaluation of Alternatives in Relation to the Evaluation Criteria

In this phase, there are several sub-phases that can be identified.

The evaluation of alternatives in relation to the chosen set of the criteria is also done by using an interactive questionnaire made in a spreadsheet file.

For each criterion, declarative sentences are formed. The respondents have a possibility to fill in their attitudes about the degree of truth, indeterminacy and the falsehood of the statement.

For the sake of simplicity, the respondents fill in their attitudes in the percentage form, which are later transformed into the corresponding numbers in $[0,1]$ intervals.

For completing the questionnaire, it is necessary that between 30 and 90 fields should be filled in, which can be dissuasive for a significant number of respondents. However, this approach can be good because it can distract uninterested respondents from completing the questionnaire, thus reducing the number of the completed questionnaires with incorrect information.

In addition, the Overall Experience criterion has also been used to assess the validity of the data entered.

Aggregation and Analysis of Results

In the Aggregation and Analysis phase, several components, sub-phases, could be identified, such as:

- the determination of the overall ratings and the ranking order of the considered alternatives,
- the assessment of the validity of the data in the completed questionnaire and
- the determination of the overall group ratings and the ranking order of the considered alternatives etc.

The first of them – the determination of the overall ratings – is mandatory, whereas the others are optional.

The determination of the overall ratings and the ranking order of the considered alternatives. The process of assessing the determination of the overall ratings and the ranking order could be shown through the following steps:

- the calculation of the overall single valued neutrosophic ratings of the alternatives by using the SVNWA operator based on the values of the criteria C_1-C_5 ;
- the calculation of the score function by using Eq. (9) for each alternative; and
- the sorting of the considered alternatives based on the values of the score function and the determination of the best one. The alternative with the highest value of the score function is the best one.

The assessment of the validity of the data in the completed questionnaire. The Overall Experience criterion is omitted from the calculation of the overall single valued neutrosophic ratings because it plays a special role in the proposed approach. More precisely, the ratings filled in for this criterion are used to assess the validity of the data in the completed questionnaire.

The process of assessing the validity of the data could be accounted for through the following steps:

- Calculate the value of the score function based on the ratings of the *Overall Experience* criterion, and do so for each alternative.
- Determine the ranking order of the alternatives based on the value of the score function.
- Calculate the correlation coefficient between the ranking order obtained based on C_1-C_5 and the ranking order obtained based on the *Overall Experience* criterion.

Based on the value of the correlation coefficient, the questionnaire could be either accepted or rejected.

The determination of the overall group ratings and the ranking order of the considered alternatives. In the case of real examinations, when more than one respondent is involved in the evaluation, it is necessary to determine the overall group ratings, and based on them the final ranking order of the alternatives.

The process of determining the overall group ratings and the final ranking order of the alternatives is as follows:

- the calculation of the overall group ratings by using the SVNWA operator, based on the overall ratings;
- the calculation of the score function of the overall group rating by using Eq. (9) for each alternative, and
- the sorting of the considered alternatives based on the values of the score function and the determination of the best one. The alternative with the highest value of the score function is the best one.

5. A NUMERICAL ILLUSTRATION

In this numerical illustration, one case of selecting websites is considered. The initial set of the alternatives has been formed based on the keyword “vinarija”, which is the Serbian word for a “winery”, in the Google search engine.

The list of eight top placed websites is as follows:

- Vinarija Zvonko Bogdan - <http://www.vinarijazvonkobogdan.com/>
- Vinarija Coka - <http://www.vinarijacoka.rs/>
- Vinarija Dulka - <http://www.dulka-vinarija.com/>
- Vinarija Milosavljevic - <http://www.vinarija-milosavljevic.com/>
- Vinarija Kis - <http://www.vinarijakis.com/>
- Vinarija Vink - <http://www.dobrovino.com/>
- Vinarija Matalj - <http://www.mataljvinarija.rs/>
- Vinarija Aleksandrovic - <http://www.vinarijaaleksandrovic.rs/>

From the above, a set of five alternatives has been formed¹, denoted A_1 to A_5 .

The survey has been conducted by email, with the aim to collect the attitudes from the respondents regarding the significance of the criteria and the ratings of the alternatives.

The interactive questionnaire made in the spreadsheet was used for attitudes gathering, so the participants had an opportunity to see the results and possibly change their own attitudes.

The attitudes obtained from the first of the three examinees are given in Table 1, which also accounts for the weights of the criteria calculated based on the examinees’ responses.

Table 1: The responses and weights of the criteria obtained from one of the evaluated respondents

Criteria	s_j	k_j	q_j	w_j
C_1 Content		1	1	0.22
C_2 Structure and Navigation	0.90	1.10	0.91	0.20
C_3 Visual Design	1.20	0.80	1.14	0.25
C_4 Interactivity	0.60	1.40	0.81	0.18
C_5 Functionality	0.90	1.10	0.74	0.16

The attitudes obtained from the three examinees, as well as the appropriate weights, are presented in Table 2 as well.

¹ This paper is not intended to promote any of the above-mentioned wineries.

Table 2: The attitudes and weights obtained from the three examinees

	E_1		E_1		E_1	
	s_j	w_j	s_j	w_j	s_j	w_j
C_1		0.22		0.20		0.20
C_2	0.90	0.20	1.10	0.22	1.00	0.20
C_3	1.20	0.25	1.10	0.25	1.10	0.22
C_4	0.60	0.18	0.60	0.18	0.90	0.20
C_5	0.90	0.16	0.90	0.16	0.90	0.18

The following are the responses obtained from the three examinees regarding the evaluation of the websites.

Table 3: The ratings obtained from the first of the three examinees

	C_1	C_2	C_3	C_4	C_5	C_6
A_1	<1.0, 0.0, 0.0>	<1.0, 0.2, 0.0>	<1.0, 0.0, 0.0>	<0.7, 0.3, 0.0>	<0.8, 0.2, 0.2>	<0.9, 0.1, 0.1>
A_2	<1.0, 0.0, 0.0>	<1.0, 0.0, 0.0>	<1.0, 0.0, 0.0>	<0.6, 0.0, 0.2>	<1.0, 0.0, 0.0>	<0.7, 0.0, 0.0>
A_3	<0.9, 0.0, 0.0>	<0.9, 0.0, 0.0>	<0.7, 0.2, 0.3>	<0.5, 0.0, 0.0>	<0.9, 0.0, 0.0>	<0.7, 2.0, 2.0>
A_4	<0.7, 0.0, 0.3>	<0.7, 0.3, 0.3>	<0.6, 0.4, 0.2>	<0.4, 0.0, 0.0>	<0.9, 0.0, 0.0>	<0.5, 0.0, 0.2>
A_5	<1.0, 0.0, 0.0>	<1.0, 0.0, 0.0>	<1.0, 0.0, 0.0>	<0.7, 0.0, 0.2>	<1.0, 0.0, 0.0>	<0.9, 0.0, 0.2>

Table 4: The ratings obtained from the second of the three examinees

	C_1	C_2	C_3	C_4	C_5	C_6
A_1	<0.8, 0.2, 0.2>	<1.0, 0.0, 0.0>	<0.7, 0.3, 0.1>	<0.7, 0.3, 0.2>	<1.0, 0.0, 0.0>	<0.8, 0.1, 0.1>
A_2	<1.0, 0.0, 0.0>	<1.0, 0.0, 0.0>	<1.0, 0.0, 0.0>	<0.6, 0.0, 0.2>	<1.0, 0.0, 0.0>	<1.0, 0.1, 0.1>
A_3	<0.7, 0.3, 0.2>	<0.9, 0.0, 0.0>	<0.7, 0.2, 0.3>	<0.5, 0.0, 0.0>	<0.9, 0.0, 0.0>	<0.7, 0.2, 0.2>
A_4	<0.7, 0.0, 0.3>	<0.7, 0.3, 0.3>	<0.6, 0.4, 0.2>	<0.4, 0.0, 0.0>	<0.9, 0.0, 0.0>	<0.5, 0.1, 0.2>
A_5	<1.0, 0.0, 0.0>	<1.0, 0.0, 0.0>	<1.0, 0.0, 0.0>	<0.7, 0.0, 0.2>	<1.0, 0.0, 0.0>	<0.9, 0.0, 0.0>

Table 5: The ratings obtained from the third of the three examinees

	C_1	C_2	C_3	C_4	C_5	C_6
A_1	<0.9, 1.0, 1.0>	<0.9, 0.0, 0.2>	<1.0, 0.0, 1.0>	<0.7, 0.3, 0.2>	<1.0, 0.0, 0.0>	<0.9, 0.0, 0.1>
A_2	<1.0, 0.0, 0.0>	<1.0, 0.0, 0.0>	<1.0, 0.0, 0.0>	<0.6, 0.0, 0.2>	<1.0, 0.0, 0.0>	<1.0, 0.1, 0.1>
A_3	<0.6, 0.3, 0.2>	<0.9, 0.0, 0.0>	<0.5, 0.2, 0.3>	<0.5, 0.3, 0.3>	<0.9, 0.3, 0.4>	<0.7, 0.0, 0.0>
A_4	<0.6, 0.0, 0.3>	<0.5, 0.3, 0.4>	<0.4, 0.4, 0.2>	<0.4, 0.0, 0.0>	<0.9, 0.3, 0.3>	<0.7, 0.0, 0.2>
A_5	<1.0, 0.0, 0.0>	<1.0, 0.0, 0.0>	<1.0, 0.0, 0.0>	<0.7, 0.0, 0.2>	<1.0, 0.0, 0.0>	<0.9, 0.0, 0.0>

The remaining part of the evaluation process is explained on the first of the three examinees.

The overall SVN ratings calculated by using the SVNWA, i.e. by using Eq. (11), are shown in Table 4. The ranking order obtained based on the values of the score function, calculated by using Eq. (9), is also presented in table 6.

The ranking order obtained based on the Overall Experience criterion is given in table 6, too.

Table 6: The ranking orders obtained on the basis of the ratings of the first of the three examinees

	$C_1 - C_5$	Score	Rank	C_6	Score	Rank
A_1	<1.000, 0.006, 0.000>	0.9936	3	<0.9, 0.1, 0.1>	0.80	3
A_2	<1.000, 0.000, 0.000>	0.9997	1	<0.7, 0.0, 0.0>	0.85	2
A_3	<0.826, 0.001, 0.001>	0.9118	4	<0.7, 2.0, 2.0>	-2.15	5
A_4	<0.695, 0.004, 0.018>	0.8345	5	<0.5, 0.0, 0.2>	0.65	4
A_5	<1.000, 0.000, 0.000>	0.9997	1	<0.9, 0.0, 0.2>	0.85	1

The Pearson correlation coefficient between the two ranking orders, shown in Table 6, is 0.884, which is indicative of the fact that the data in the questionnaire are valid.

The ranking orders obtained from the three examinees obtained based on the ratings of the criteria C_1 to C_5 are shown in Table 7.

Table 7: The ranking orders obtained from the three examinees

	I		II		II	
	Score	Rank	Score	Rank	Score	Rank
A_1	0.99	3	0.98	3	0.93	3
A_2	1.00	1	1.00	1	1.00	1
A_3	0.91	4	0.88	4	0.78	4
A_4	0.83	5	0.83	5	0.75	5
A_5	1.00	1	1.00	1	1.00	1
R		0.884		0.884		0.795

The correlation coefficients are also accounted for in Table 7.

The obtained correlation coefficients indicate that there is no significant difference between the ranking orders obtained based on the criteria C_1 to C_5 and the *Overall Experience* criterion, which is indicative of the fact that the data in the selected questionnaires are valid.

CONCLUSION

Obtaining a realistic attitude by surveying could often be related to some difficulties, when the data collected in such a manner are then further used in multiple criteria decision making.

There are two opposite possibilities. The first one is using a greater number of criteria, often organized into two or more hierarchical levels. Such an approach should lead to the formation of accurate models. However, an increase in the number of criteria could lead to the creation of complex questionnaires, which could have a negative impact on the examinee’s response as well as on the verisimilitude of the collected data.

Opposite to the previously said, the usage of a smaller number of criteria could have a positive impact on the collection of data, i.e. respondents’ attitudes, on the one hand, but could also lead to the creation of less precise decision-making models, on the other.

The neutrosophic set, or more precisely single valued neutrosophic numbers, could be an adequate basis for collecting the examinee’s attitudes by using a smaller number of criteria without losing precision.

By combining the SWARA method, in order to determine the importance of criteria, on the one hand, and Single Valued Neutrosophic Numbers, in order to acquire respondents’ attitudes, on the other, effective

and easy-to-use multiple criteria decision-making models can be created, as has been shown in the considered numerical illustration.

REFERENCES

- Al-Manasra, E., Khair, M., Zaid, S. A., & TaherQutaishat, F. (2013). Investigating the impact of website quality on consumers' satisfaction in Jordanian telecommunication sector. *Arab Economic and Business Journal*, 8(1-2), 31-37.
- Atanassov, K. T. (1986). Intuitionistic fuzzy sets. *Fuzzy sets and Systems*, 20(1), 87-96.
- Atanassov, K., & Gargov, G. (1989). Interval valued intuitionistic fuzzy sets. *Fuzzy sets and systems*, 31(3), 343-349.
- Bai, B., Law, R., & Wen, I. (2008). The impact of website quality on customer satisfaction and purchase intentions: Evidence from Chinese online visitors. *International Journal of Hospitality Management*, 27(3), 391-402.
- California State University at Chico. Evaluating Information – Applying the CRAAP Test. Available online: http://www.csuchico.edu/lins/handouts/eval_websites.pdf (Retrieved on 17.05.2017).
- Canziani, B. F., & Welsh, D. H. (2016). Website quality for SME wineries: measurement insights. *Journal of Hospitality and Tourism Technology*, 7(3), 266-280.
- Chiou, W. C., Lin, C. C., & Perng, C. (2011). A strategic website evaluation of online travel agencies. *Tourism Management*, 32(6), 1463-1473.
- Chou, W. C., & Cheng, Y. P. (2012). A hybrid fuzzy MCDM approach for evaluating website quality of professional accounting firms. *Expert Systems with Applications*, 39(3), 2783-2793.
- Goźzałczany, M. B. (1987). A method of inference in approximate reasoning based on interval-valued fuzzy sets. *Fuzzy sets and systems*, 21(1), 1-17.
- Kapoun, J. (1998). Teaching undergrads web evaluation - a guide for library instruction. *College and Research Libraries News*, 59(7), 522-523.
- Kaya, T. (2010). Multi-attribute evaluation of website quality in E-business using an integrated fuzzy AHPTOPSIS methodology. *International Journal of Computational Intelligence Systems*, 3(3), 301-314.
- Kaya, T., & Kahraman, C. (2011). A fuzzy approach to e-banking website quality assessment based on an integrated AHP-ELECTRE method. *Technological and Economic Development of Economy*, 17(2), 313-334.
- Keršulienė, V., Zavadskas, E. K., & Turskis, Z. (2010). Selection of rational dispute resolution method by applying new step-wise weight assessment ratio analysis (SWARA). *Journal of Business Economics and Management*, 11(2), 243-258.
- Kim, S., & Stoel, L. (2004). Apparel retailers: website quality dimensions and satisfaction. *Journal of Retailing and Consumer Services*, 11(2), 109-117.
- Kincl, T., & Štrach, P. (2012). Measuring website quality: asymmetric effect of user satisfaction. *Behaviour & Information Technology*, 31(7), 647-657.
- Lin, H. F. (2007). The impact of website quality dimensions on customer satisfaction in the B2C e-commerce context. *Total Quality Management and Business Excellence*, 18(4), 363-378.

- Lydia M. Olson Library. (2009). Evaluating internet sources: A library resource guide. Available online: <http://library.nmu.edu/guides/userguides/webeval.htm> (Retrieved on 10.06.2017).
- Mondal, K., & Pramanik, S. (2014). Multi-criteria group decision making approach for teacher recruitment in higher education under simplified neutrosophic environment. *Neutrosophic Sets and Systems*, 6, 28-34.
- Rocha, Á. (2012). Framework for a global quality evaluation of a website. *Online Information Review*, 36(3), 374-382.
- Sahin, R. (2014). Multi-criteria neutrosophic decision making method based on score and accuracy functions under neutrosophic environment. *arXiv preprint arXiv*, 1412.5202.
- Salem, I. E. B., & Čavlek, N. (2016). Evaluation of hotel website contents: existence-importance analysis. *Journal of Hospitality and Tourism Technology*, 7(4), 366-389.
- Smarandache, F. (1998). Neutrosophy: neutrosophic probability, set, and logic: analytic synthesis & synthetic analysis. American Research Press, Rehoboth, USA.
- Smarandache, F. (1999). A unifying field in logics. Neutrosophy: Neutrosophic probability, set and logic. American Research Press, Rehoboth, USA.
- Stanujkic, D., Karabasevic, D., & Zavadskas, E. K. (2015). A framework for the selection of a packaging design based on the SWARA method. *Inzinerine Ekonomika-Engineering Economics*, 26(2), 181-187.
- Stanujkic, D., Zavadskas, E. K., & Tamosaitiene, J. (2015). An approach to measuring website quality in the rural tourism industry based on Atanassov intuitionistic fuzzy sets. *E+M Ekonomie a Management*, 18(4), 461-470.
- Ting, P. H., Wang, S. T., Bau, D. Y., & Chiang, M. L. (2013). Website evaluation of the top 100 hotels using advanced content analysis and eMICA model. *Cornell Hospitality Quarterly*, 54(3), 284-293.
- Turksen, I. B. (1986). Interval valued fuzzy sets based on normal forms. *Fuzzy Sets and Systems*, 20(2), 191-210.
- Türkşen, I. B. (1996). Non-specificity and interval-valued fuzzy sets. *Fuzzy Sets and Systems*, 80(1), 87-100.
- Wang, H., Smarandache F., Zhang, Y.Q., & Sunderraman, R. (2010). Single valued neutrosophic sets. *Multispace and Multistructure*, 4, 410-413.
- Webby Awards. Available online: <http://webbyawards.com/judging-criteria/> (Retrieved on 26.06.2017).
- Zadeh, L. A. (1965). Fuzzy sets. *Information and Control*, 8(3), 338-353.
- Abdel-Basset, M., Mohamed, M., Smarandache, F., & Chang, V. (2018). Neutrosophic Association Rule Mining Algorithm for Big Data Analysis. *Symmetry*, 10(4), 106.
- Abdel-Basset, M., & Mohamed, M. (2018). The Role of Single Valued Neutrosophic Sets and Rough Sets in Smart City: Imperfect and Incomplete Information Systems. Measurement. Volume 124, August 2018, Pages 47-55
- Abdel-Basset, M.; Mohamed, M.; Smarandache, F. An Extension of Neutrosophic AHP–SWOT Analysis for Strategic Planning and Decision-Making. *Symmetry* 2018, 10, 116.

Generalized Single Valued Triangular Neutrosophic Numbers and Aggregation Operators for Application to Multi-attribute Group Decision Making

Mehmet Şahin^{1*}, Abdullah Kargin², Florentin Smarandache³

¹Department of Mathematics, Gaziantep University, Gaziantep 27310, Turkey, mesahin@gantep.edu.tr

²Department of Mathematics, Gaziantep University, Gaziantep 27310, Turkey, abduallahkargin27@gmail.com,

³Department of Mathematics, University of Mexico, 705 Gurley Ave., Gallup, NM 87301, USA, smarand@unm.edu

Corresponding author's email^{1*}: mesahin@gantep.edu.tr

ABSTRACT

In this study we define the generalizing single valued triangular neutrosophic number. In addition, single valued neutrosophic numbers are transformed into single valued triangular neutrosophic numbers according to the values of truth, indeterminacy and falsity. Furthermore, we extended the Hamming distance given for triangular intuitionistic fuzzy numbers to single valued triangular neutrosophic numbers. We have defined new score functions based on the Hamming distance. We then extended some operators given for intuitionistic fuzzy numbers to single valued triangular neutrosophic numbers. Finally, we developed a new solution to multi-attribute group decision making problems for single valued neutrosophic numbers with operators and scoring functions and we checked the suitability of our new method by comparing the results we obtained with previously obtained results. We have also mentioned for the first time that there is a solution for multi-attribute group decision making problems for single valued triangular neutrosophic numbers.

Keywords: Hamming distance, single valued neutrosophic number, generalized single valued neutrosophic number, multi-attribute group decision making

1. INTRODUCTION

There are many uncertainties in daily life. However, classical mathematical logic is insufficient to account for these uncertainties. In order to explain these uncertainties mathematically and to use them in practice, Zadeh (1965) first proposed a fuzzy logic theory. Although fuzzy logic is used in many field applications, the lack of membership is not explained because it is only a membership function. Then Atanassov (1986) introduced the theory of intuitionistic fuzzy logic. In this theory, he states membership, non-membership and indeterminacy, and has been used in many fields and applications. Later, Li (2010) defined triangular intuitionistic fuzzy numbers. However, in the intuitionistic fuzzy logic, membership, non-membership, and indeterminacy are all completely dependent in each other. Finally, Smarandache (1998 and 2016) proposed the neutrosophic set theory, which is the more general form of intuitionistic fuzzy logic. Many studies have been done on this theory

and have been used in many field applications. In this theory, the values of truth, indeterminacy and falsity of a situation are considered and these three values are defined completely independently of each other Smarandache, Wang, Zhang, and Sunderraman (2010) defined single valued neutrosophic sets. Subas (2015) defined single valued triangular neutrosophic numbers is a special form of single valued neutrosophic numbers. Many uncertainties and complex situations arise in decision-making applications. It is impossible to come up with these uncertainties and complexities, especially with known numbers. For example, in multi-attribute decision making (MADM), multiple objects are evaluated according to more than one property and there is a choice of the most suitable one. Particularly in multi-attribute group decision making (MAGDM), the most appropriate object selection is made according to the data received from more than one decision maker. Multi - attribute decision making group and multi-attribute decision making problems have been found by many researchers using various methods using intuitionistic fuzzy numbers. For example; Wan and Dong (2015) studied trapezoidal intuitionistic fuzzy numbers and application to multi attribute group decision making. Wan, Wang, Li and Dong (2016) studied triangular intuitionistic fuzzy numbers and application to multi attribute group decision making. Biswas, Pramanik, and Giri (2016) have studied trapezoidal fuzzy neutrosophic numbers and its application to multi-attribute decision making (MADM) and triangular fuzzy neutrosophic set and its application to multi-attribute decision making (MADM).

However, these methods and solutions are not suitable for neutrosophic sets and neutrosophic numbers. Therefore, many researchers have tried to find solutions to multi-attribute group decision making and multi-attribute decision making problems using neutrosophic sets and neutrosophic numbers. Recently, Liu and Luo (2017) have proposed multi-attribute group decision making problems using "power aggregation operators of simplifield neutrosophic sets"; Sahin, Uluçay, Kargın and Ecemiş (2017) studied centroid single valued triangular neutrosophic numbers and their applications in multi-attribute decision making; Sahin and Liu (2017) used multi-criteria decision making problems using exponential operations of simplest neutrosophic numbers; Liu and Li have produced solutions to multi-criteria decision making problems with "some normal neutrosophic Bonferroni mean operators" (2017). Smarandache (2016) have produced neutrosophic overset, neutrosophic underset, and neutrosophic offset. Biswas, Pramanik, and Giri (2016) have studied single-valued trapezoidal neutrosophic numbers and its application to multi-attribute decision making (MADM). Ye (2015) have studied multi-attribute decision making (MADM).

Subas (2015) defined $\tilde{a} = ((a_1, b_1, c_1); w_{\tilde{a}}, u_{\tilde{a}}, y_{\tilde{a}})$ as a positive single valued triangular neutrosophic number for $a_1, b_1, c_1 \in \mathbb{R}^+$ or a negative single valued triangular neutrosophic number for $a_1, b_1, c_1 \in \mathbb{R}^-$. However, the condition $a_1, b_1, c_1 \in \mathbb{R} - \{0\}$ has not been defined. This narrows the applications of single valued triangular neutrosophic numbers. In this study we first define the condition of $a_1, b_1, c_1 \in \mathbb{R}$ for single valued triangular neutrosophic numbers and gave basic operations on these conditions. These basic operations we have given also include operations where $a_1, b_1, c_1 \in \mathbb{R}^-$ and $a_1, b_1, c_1 \in \mathbb{R}^+$. Thus, by generalizing single valued triangular neutrosophic numbers, we made it more useful. Then, single valued neutrosophic numbers were converted to single valued triangular neutrosophic numbers. Thus, we made single valued neutrosophic numbers more useful by carrying single valued triangular neutrosophic numbers, which have rich application fields. We then extended the Hamming distance for triangular intuitionistic fuzzy numbers to single valued triangular neutrosophic numbers and showed some properties. Besides, we defined the scoring and certainty functions for the single-valued neutrosophic numbers and for the single valued triangular neutrosophic numbers based on the Hamming distance according to the truth, indeterminacy and falsity values. We compared the results of the score and certainty functions we obtained with the score and certainty functions. We also made some operators for triangular intuitionistic fuzzy numbers available for single valued triangular neutrosophic numbers and showed some properties of these operators. We mentioned similarities and differences with the operators. Finally, we have found a new solution to the multi-attribute group decision making problems by using the transformation of single valued neutrosophic numbers, new scoring functions and using the operators we have obtained. Since the transformations and the scoring functions are separate according to the values of truth, indeterminacy and falsity, we obtained results separately for each of the three values for multi-attribute group decision making problems. We compared our result with the result of a multi-attribute group decision making problem for single valued neutrosophic numbers. We have checked the applicability of the method we have achieved.

In this study, we gave some definitions of triangular intuitionistic fuzzy numbers and related definitions about neutrosophic sets, single valued neutrosophic sets and numbers, single valued triangular neutrosophic numbers, and some related definitions in section 2. In Section 3, we generalized the single valued triangular neutrosophic numbers to make them more usable and described the basic operations. In Section 3, we gave transformations for single valued neutrosophic numbers based on their truth, indeterminacy and falsity values. In section 4, we made the Hamming distance for triangular intuitionistic fuzzy numbers available for single valued triangular neutrosophic numbers and showed some properties.

In addition, we have separately defined the score and certainty functions according to the values of truth, indeterminacy and falsity depending on the generalized Hamming distance and compared with the score and certainty functions given before. In Section 5, we made some operators for triangular intuitionistic fuzzy numbers available with single valued triangular neutrosophic numbers, and we showed some properties of these operators and discussed the similarities and differences with the previously given operators. In Section 6, we gave a new method for solving multi-attribute group decision making problems for single valued neutrosophic numbers using the transform functions and operators that we have achieved in this work. In Section 7, we looked at the applicability of our method by comparing the result of a previous multi-attribute group decision making problem with the result of our method. Finally, in Section 8 we briefly discussed the results of our work.

2. PRELIMINARIES

Definition 2.1: A triangular intuitionistic fuzzy number $\tilde{a} = ((\underline{a}, a, \bar{a}); w_{\tilde{a}}, u_{\tilde{a}})$ is a special intuitionistic fuzzy set on the real number set \mathbb{R} , whose truth-membership and falsity-membership functions are defined as follows:

$$\mu_{\tilde{a}}(x) = \begin{cases} \frac{(x-\underline{a})w_{\tilde{a}}}{(a-\underline{a})} & (\underline{a} \leq x < a) \\ w_{\tilde{a}} & (x = a) \\ \frac{(\bar{a}-x)w_{\tilde{a}}}{(\bar{a}-a)} & (a < x \leq \bar{a}) \\ 0 & \text{otherwise} \end{cases}$$

$$\nu_{\tilde{a}}(x) = \begin{cases} \frac{(a-x+u_{\tilde{a}}(x-\underline{a}))}{(a-\underline{a})} & (\underline{a} \leq x < a) \\ u_{\tilde{a}} & (x = a) \\ \frac{(x-a+u_{\tilde{a}}(\bar{a}-x))}{(\bar{a}-a)} & (a < x \leq \bar{a}) \\ 1 & \text{otherwise} \end{cases}$$

respectively. (Li, 2010)

Definition 2.2: Let $\tilde{a}_i = ((\underline{a}_i, a_i, \bar{a}_i); w_{\tilde{a}_i}, u_{\tilde{a}_i})$ ($i=1,2$) be two triangular intuitionistic fuzzy numbers. The Hamming distance between \tilde{a}_1 and \tilde{a}_2 is

$$d_n(\tilde{a}_1, \tilde{a}_2) = \frac{1}{16} [|(1 + w_{\tilde{a}_1} - u_{\tilde{a}_1})\underline{a}_1 - (1 + w_{\tilde{a}_2} - u_{\tilde{a}_2})\underline{a}_2| + |(1 + w_{\tilde{a}_1} - u_{\tilde{a}_1})a_1 - (1 + w_{\tilde{a}_2} - u_{\tilde{a}_2})a_2| + |(1 + w_{\tilde{a}_1} - u_{\tilde{a}_1})\bar{a}_1 - (1 + w_{\tilde{a}_2} - u_{\tilde{a}_2})\bar{a}_2|]$$

(Wan, Wang, Li and Dang, 2016)

Definition 2.3: Let $\tilde{a}_i = \langle (\underline{a}_i, a_i, \overline{a}_i); w_{\tilde{a}_i}, u_{\tilde{a}_i} \rangle$ ($i = 1, 2, 3, \dots, n$) be a collection of triangular intuitionistic fuzzy numbers. Then triangular intuitionistic fuzzy generalized ordered weighted averaging operator is defined as;

$$\text{TIFGOWA} : \mathbf{U}^n \rightarrow \mathfrak{U}, \text{TIFGOWA}(\tilde{a}_1, \tilde{a}_2, \dots, \tilde{a}_n) = \mathbf{g}^{-1} \left(\sum_{j=1}^n w_j \mathbf{g}(\tilde{a}_{(j)}) \right)$$

Where \mathbf{g} is a continuous strictly monotone increasing function, $w = (w_1, w_2, \dots, w_n)^T$ is a weight vector associated with the TIFGOWA operator, with $w_j \geq 0$, $j = 1, 2, 3, \dots, n$ and $\sum_{j=1}^n w_j = 1$ and $((1), (2), \dots, (n))$ is a permutation of $(1, 2, \dots, n)$ such that $\tilde{a}_{(i)} \geq \tilde{a}_{(i+1)}$ for all i . (Wan, Wang, Li and Dang, 2016)

Definition 2.4: Let $\tilde{a}_i = \langle (\underline{a}_i, a_i, \overline{a}_i); w_{\tilde{a}_i}, u_{\tilde{a}_i} \rangle$ ($i = 1, 2, 3, \dots, n$) be a collection of triangular intuitionistic fuzzy numbers. Then triangular intuitionistic fuzzy generalized hybrid weighted averaging operator is defined as;

$$\text{TIFGHWA} : \mathbf{U}^n \rightarrow \mathfrak{U}, \text{TIFGHWA}(\tilde{a}_1, \tilde{a}_2, \dots, \tilde{a}_n) = \mathbf{g}^{-1} \left(\sum_{j=1}^n w_j \mathbf{g}(\tilde{b}_{(j)}) \right)$$

Where \mathbf{g} is a continuous strictly monotone increasing function, $w = (w_1, w_2, \dots, w_n)^T$ is a weight vector associated with the TIFGHWA operator, with $w_i \geq 0$, $i = 1, 2, 3, \dots, n$ $\sum_{i=1}^n w_i = 1$, $\omega = (\omega_1, \omega_2, \dots, \omega_n)^T$ is a weight vector of \tilde{a}_i and $\tilde{b}_{(i)} = \omega_1 \cdot \tilde{a}_i$. (Wan, Wang, Li and Dang, 2016)

Definition 2.5: Let U be an universe of discourse then the neutrosophic set A is on object having the form $A = \{ (x: T_A(x), I_A(x), F_A(x)) \mid x \in U \}$ where the functions $T, I, F: U \rightarrow]-0, 1^+[$ respectively the degree of membership, the degree of indeterminacy and degree of non-membership of the element $x \in U$ to the set A with the condition.

$$0^- \leq T_{A(x)} + I_{A(x)} + F_{A(x)} \leq 3^+ . \text{ (Smarandache, 2016)}$$

Definition 2.6: Let U be an universe of discourse then the single valued neutrosophic set A is on object having the form $A = \{ (x: T_A(x), I_A(x), F_A(x)) \mid x \in U \}$ where the functions $T, I, F: U \rightarrow [0, 1]$ respectively the degree of membership, the degree of indeterminacy and degree of non-membership of the element $x \in U$ to the set A with the condition.

$$0 \leq T_{A(x)} + I_{A(x)} + F_{A(x)} \leq 3$$

For convenience, we can simply use $x = (T, I, F)$ to represent an element x in single valued neutrosophic numbers and the element x can be called a single valued neutrosophic number. (Wang, Smarandache, Zhang, Sunderraman, 2010)

Definition 2.7: Let $x = (T, I, F)$ be a single valued triangular neutrosophic number and then

- 1) $sc(x) = T + 1 - I + 1 - F$;
- 2) $ac(x) = T - F$;

Where $sc(x)$ represents the score function of the single valued neutrosophic number and $ac(x)$ represent certainty function of the single valued neutrosophic number. (Liu, Chu, Li and Chen, 2014)

Definition 2.8: Let $x = (T_1, I_1, F_1)$ and $y = (T_2, I_2, F_2)$ be two single valued neutrosophic numbers, the comparison approach can be defined as follows.

- 1) If $sc(x) > sc(y)$, then x is greater than y and denoted $x \succ y$.
- 2) If $sc(x) = sc(y)$ and $ac(x) > ac(y)$, then x is greater than y and denoted $x \succ y$.
- 3) If $sc(x) = sc(y)$ and $ac(x) = ac(y)$, then x is equal to y and denoted by $x \sim y$.

(Liu, Chu, Li and Chen, 2014)

Definition 2.9: Let $w_{\tilde{a}}, u_{\tilde{a}}, y_{\tilde{a}} \in [0, 1]$. A single valued triangular neutrosophic number $\tilde{a} = \langle (a_1, b_1, c_1); w_{\tilde{a}}, u_{\tilde{a}}, y_{\tilde{a}} \rangle$ is a special neutrosophic set on the real number set R , whose truth-membership, indeterminacy-membership and falsity-membership functions are defined as follows:

$$\mu_{\tilde{a}}(x) = \begin{cases} (x-a_1)w_{\tilde{a}}/(b_1-a_1) & (a_1 \leq x < b_1) \\ w_{\tilde{a}} & (x = b_1) \\ (c_1-x)w_{\tilde{a}}/(c_1-b_1) & (b_1 < x \leq c_1) \\ 0 & otherwise \end{cases}$$

$$v_{\tilde{a}}(x) = \begin{cases} (b_1-x+u_{\tilde{a}}(x-a_1))/(b_1-a_1) & (a_1 \leq x < b_1) \\ u_{\tilde{a}} & (x = b_1) \\ (x-b_1+u_{\tilde{a}}(c_1-x))/(c_1-b_1) & (b_1 < x \leq c_1) \\ 1 & otherwise \end{cases}$$

$$\lambda_{\tilde{a}}(x) = \begin{cases} (b_1-x+y_{\tilde{a}}(x-a_1))/(b_1-a_1) & (a_1 \leq x < b_1) \\ y_{\tilde{a}} & (x = b_1) \\ (x-b_1+y_{\tilde{a}}(c_1-x))/(c_1-b_1) & (b_1 < x \leq c_1) \\ 1 & otherwise \end{cases}$$

respectively.

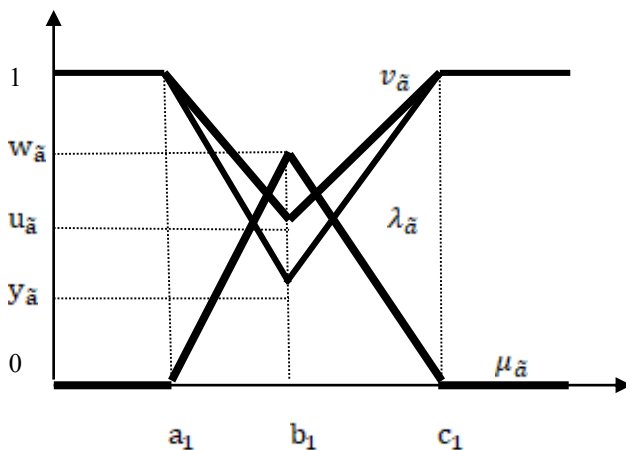

Fig. 1. $(\tilde{a} = \langle (a_1, b_1, c_1); w_{\tilde{a}}, u_{\tilde{a}}, y_{\tilde{a}} \rangle$ single valued triangular neutrosophic number)

If $a_1 \geq 0$ and at least $c_1 > 0$, then $\tilde{a} = \langle (a_1, b_1, c_1); w_{\tilde{a}}, u_{\tilde{a}}, y_{\tilde{a}} \rangle$ is called a positive triangular neutrosophic number, denoted by $\tilde{a} > 0$. Likewise, If $c_1 \leq 0$ and at least $a_1 < 0$, then $\tilde{a} = \langle (a_1, b_1, c_1); w_{\tilde{a}}, u_{\tilde{a}}, y_{\tilde{a}} \rangle$ is called a negative triangular neutrosophic number, denoted by $\tilde{a} < 0$.

A triangular neutrosophic number $\tilde{a} = \langle (a_1, b_1, c_1); w_{\tilde{a}}, u_{\tilde{a}}, y_{\tilde{a}} \rangle$ may express an ill-known quantity about a , which is approximately equal to a . (Subas, 2017)

Definition 2.10: Let $\tilde{a} = \langle (a_1, b_1, c_1); w_{\tilde{a}}, u_{\tilde{a}}, y_{\tilde{a}} \rangle$ and $\tilde{b} = \langle (a_2, b_2, c_2); w_{\tilde{b}}, u_{\tilde{b}}, y_{\tilde{b}} \rangle$, be two single valued triangular neutrosophic numbers and $\gamma \neq 0$ be any real number. Then,

1. $\tilde{a} + \tilde{b} = \langle (a_1 + a_2, b_1 + b_2, c_1 + c_2); w_{\tilde{a}} \wedge w_{\tilde{b}}, u_{\tilde{a}} \vee u_{\tilde{b}}, y_{\tilde{a}} \vee y_{\tilde{b}} \rangle$
2. $\tilde{a} - \tilde{b} = \langle (a_1 - a_2, b_1 - b_2, c_1 - c_2); w_{\tilde{a}} \wedge w_{\tilde{b}}, u_{\tilde{a}} \vee u_{\tilde{b}}, y_{\tilde{a}} \vee y_{\tilde{b}} \rangle$
3. $\tilde{a} \tilde{b} = \begin{cases} \langle (a_1 a_2, b_1 b_2, c_1 c_2); w_{\tilde{a}} \wedge w_{\tilde{b}}, u_{\tilde{a}} \vee u_{\tilde{b}}, y_{\tilde{a}} \vee y_{\tilde{b}} \rangle & (c_1 > 0, c_2 > 0) \\ \langle (a_1 c_2, b_1 b_2, c_1 a_2); w_{\tilde{a}} \wedge w_{\tilde{b}}, u_{\tilde{a}} \vee u_{\tilde{b}}, y_{\tilde{a}} \vee y_{\tilde{b}} \rangle & (c_1 < 0, c_2 > 0) \\ \langle (c_1 c_2, b_1 b_2, a_1 a_2); w_{\tilde{a}} \wedge w_{\tilde{b}}, u_{\tilde{a}} \vee u_{\tilde{b}}, y_{\tilde{a}} \vee y_{\tilde{b}} \rangle & (c_1 < 0, c_2 < 0) \end{cases}$
4. $\tilde{a} / \tilde{b} = \begin{cases} \langle (a_1/c_2, b_1/b_2, c_1/a_2); w_{\tilde{a}} \wedge w_{\tilde{b}}, u_{\tilde{a}} \vee u_{\tilde{b}}, y_{\tilde{a}} \vee y_{\tilde{b}} \rangle & (c_1 > 0, c_2 > 0) \\ \langle (c_1/c_2, b_1/b_2, a_1/a_2); w_{\tilde{a}} \wedge w_{\tilde{b}}, u_{\tilde{a}} \vee u_{\tilde{b}}, y_{\tilde{a}} \vee y_{\tilde{b}} \rangle & (c_1 < 0, c_2 > 0) \\ \langle (c_1/a_2, b_1/b_2, a_1/c_2); w_{\tilde{a}} \wedge w_{\tilde{b}}, u_{\tilde{a}} \vee u_{\tilde{b}}, y_{\tilde{a}} \vee y_{\tilde{b}} \rangle & (c_1 < 0, c_2 < 0) \end{cases}$
5. $\gamma \tilde{a} = \begin{cases} \langle (\gamma a_1, \gamma b_1, \gamma c_1); w_{\tilde{a}}, u_{\tilde{a}}, y_{\tilde{a}} \rangle & (\gamma > 0) \\ \langle (\gamma c_1, \gamma b_1, \gamma a_1); w_{\tilde{a}}, u_{\tilde{a}}, y_{\tilde{a}} \rangle & (\gamma < 0) \end{cases}$
6. $\tilde{a}^{-1} = \langle (1/c_1, 1/b_1, 1/a_1); w_{\tilde{a}}, u_{\tilde{a}}, y_{\tilde{a}} \rangle$ ($\tilde{a} \neq 0$). (Subas, 2017)

Definition 2.11: We defined a method to compare any two single valued triangular neutrosophic numbers which is based on the score function and the certainty function. Let $\tilde{a}_1 = \langle (a_1, b_1, c_1); w_{\tilde{a}_1}, u_{\tilde{a}_1}, y_{\tilde{a}_1} \rangle$ be any single valued triangular neutrosophic number, then

$$S(\tilde{a}_1) = \frac{1}{8}[a_1 + b_1 + c_1] \times (2 + w_{\tilde{a}_1} - u_{\tilde{a}_1} - y_{\tilde{a}_1})$$

and

$$A(\tilde{a}_1) = \frac{1}{8}[a_1 + b_1 + c_1] \times (2 + w_{\tilde{a}_1} - u_{\tilde{a}_1} + y_{\tilde{a}_1})$$

is called the score and certainty degrees of \tilde{a}_1 , respectively. (Subas, 2017)

Definition 2.12: Let \tilde{a}_1 and \tilde{a}_2 be two single valued triangular neutrosophic numbers,

1. If $S(\tilde{a}_1) < S(\tilde{a}_2)$, then \tilde{a}_1 is smaller than \tilde{a}_2 , denoted by $\tilde{a}_1 < \tilde{a}_2$.

2. If $S(\tilde{a}_1) = S(\tilde{a}_2)$;

(a) If $A(\tilde{a}_1) < A(\tilde{a}_2)$, then \tilde{a}_1 is smaller than \tilde{a}_2 , denoted by $\tilde{a}_1 < \tilde{a}_2$.

(b) If $A(\tilde{a}_1) = A(\tilde{a}_2)$, then \tilde{a}_1 and \tilde{a}_2 are the same, denoted by $\tilde{a}_1 = \tilde{a}_2$.

(Subas, 2017)

Definition 2.13: Let $\tilde{a}_j = \langle (a_j, b_j, c_j); w_{\tilde{a}_j}, u_{\tilde{a}_j}, y_{\tilde{a}_j} \rangle$ ($j = 1, 2, 3, \dots, n$) be a collection of single valued triangular neutrosophic numbers. Then single valued triangular neutrosophic weight averaging operator (SVTNWAO) is defined as;

$$\text{SVTNWAO: } \bar{N}_R^n \rightarrow \bar{N}_R, \quad \text{SVTNWAO}(\tilde{a}_1, \tilde{a}_2, \dots, \tilde{a}_n) = \sum_{j=1}^n w_j \tilde{a}_j$$

where $w = (w_1, w_2, \dots, w_n)^T$ is a weight vector associated with the SVTNWAO operator, with $w_j \geq 0$, $j = 1, 2, 3, \dots, n$ and $\sum_{j=1}^n w_j = 1$. (Subas, 2017)

Definition 2.14: Let $\tilde{a}_j = \langle (a_j, b_j, c_j); w_{\tilde{a}_j}, u_{\tilde{a}_j}, y_{\tilde{a}_j} \rangle$ ($j = 1, 2, 3, \dots, n$) be a collection of single valued triangular neutrosophic numbers and $w = (w_1, w_2, \dots, w_n)^T$ is a weight vector associated with $w_j \geq 0$, and $\sum_{j=1}^n w_j = 1$. Then single valued triangular neutrosophic ordered averaging operator (SVTNWAO) is defined as;

$$\text{SVTNOAO: } \bar{N}_R^n \rightarrow \bar{N}_R, \quad \text{SVTNOAO}(\tilde{a}_1, \tilde{a}_2, \dots, \tilde{a}_n) = \sum_{j=1}^n w_j \tilde{b}_j$$

where $\tilde{a}_k = \langle (a_k, b_k, c_k); w_{\tilde{a}_k}, u_{\tilde{a}_k}, y_{\tilde{a}_k} \rangle$, $k \in \{1, 2, 3, \dots, n\}$ is the single valued triangular neutrosophic number obtained by using the score and certainty function and For \tilde{b}_j ; $\tilde{a}_j = \langle (a_j, b_j, c_j); w_{\tilde{a}_j}, u_{\tilde{a}_j}, y_{\tilde{a}_j} \rangle$ is the maximum value of K . (Subas, 2017)

3. GENERALIZED SINGLE VALUED TRIANGULAR NEUTROSOPHIC NUMBERS

In this section we will generalize single valued triangular neutrosophic numbers to make them more usable. Because definition 2.9 for a single valued triangular neutrosophic number $\tilde{a} = \langle (a_1, b_1, c_1); w_{\tilde{a}}, u_{\tilde{a}}, y_{\tilde{a}} \rangle$; The values a_1, b_1, c_1 must either be negative real numbers or positive real numbers. However, some of these values are not defined as negative real numbers or some of them are positive real numbers. This situation narrows the field of use of single valued triangular neutrosophic numbers. We will abolish this limited situation with definitions given in this section.

Definition 3.1: Let $w_{\tilde{a}}, u_{\tilde{a}}, y_{\tilde{a}} \in [0, 1]$ and $a_1, b_1, c_1 \in \mathbb{R} - \{0\}$. A generalized single valued triangular neutrosophic number $\tilde{a} = \langle (a_1, b_1, c_1); w_{\tilde{a}}, u_{\tilde{a}}, y_{\tilde{a}} \rangle$ is a special neutrosophic set on the real number set \mathbb{R} , whose truth-membership, indeterminacy-membership and falsity-membership functions are defined as follows:

$$\mu_{\tilde{a}}(x) = \begin{cases} (x-a_1)w_{\tilde{a}}/(b_1-a_1) & (a_1 \leq x < b_1) \\ w_{\tilde{a}} & (x = b_1) \\ (c_1-x)w_{\tilde{a}}/(c_1-b_1) & (b_1 < x \leq c_1) \\ 0 & \text{otherwise} \end{cases}$$

$$v_{\tilde{a}}(x) = \begin{cases} (b_1-x+u_{\tilde{a}}(x-a_1))/(b_1-a_1) & (a_1 \leq x < b_1) \\ u_{\tilde{a}} & (x = b_1) \\ (x-b_1+u_{\tilde{a}}(c_1-x))/(c_1-b_1) & (b_1 < x \leq c_1) \\ 1 & \text{otherwise} \end{cases}$$

$$\lambda_{\tilde{a}}(x) = \begin{cases} (b_1-x+y_{\tilde{a}}(x-a_1))/(b_1-a_1) & (a_1 \leq x < b_1) \\ y_{\tilde{a}} & (x = b_1) \\ (x-b_1+y_{\tilde{a}}(c_1-x))/(c_1-b_1) & (b_1 < x \leq c_1) \\ 1 & \text{otherwise} \end{cases}$$

respectively.

The most important and only difference of this definition from definition 2.9 is that $a_1, b_1, c_1 \in \mathbb{R} - \{0\}$. For example $\langle (-2, -1, 3); w_{\tilde{a}}, u_{\tilde{a}}, y_{\tilde{a}} \rangle, \langle (-2, 1, 3); w_{\tilde{a}}, u_{\tilde{a}}, y_{\tilde{a}} \rangle$ cannot be single valued triangular neutrosophic numbers according to the previous definition, it is a generalized single valued triangular neutrosophic number according to this new definition. In addition, negative single valued triangular neutrosophic numbers and positive single valued triangular neutrosophic numbers are covered by single valued triangular neutrosophic numbers according to this definition.

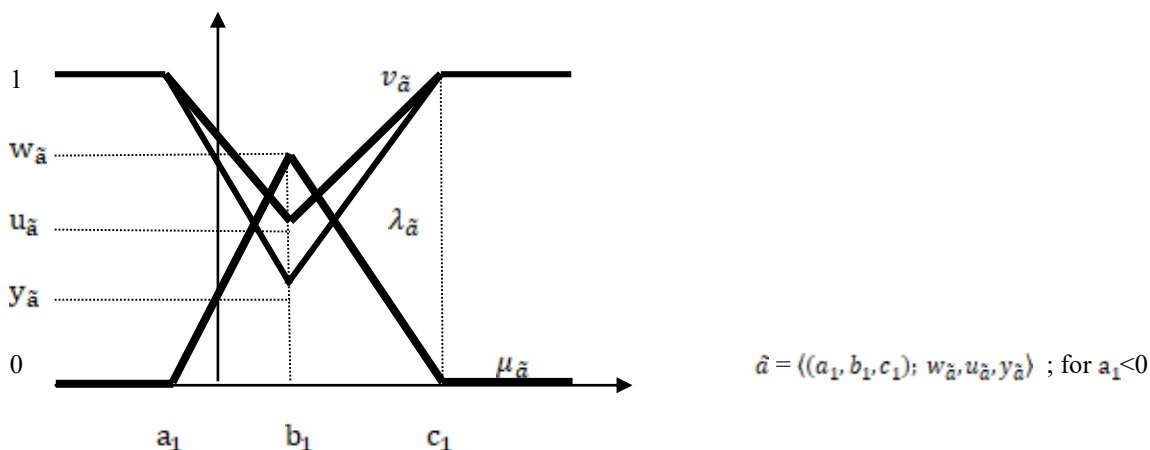

Fig. 2: ($\tilde{a} = \langle (a_1, b_1, c_1); w_{\tilde{a}}, u_{\tilde{a}}, y_{\tilde{a}} \rangle ; \text{ for } a_1 < 0$, generalized single valued triangular neutrosophic number)

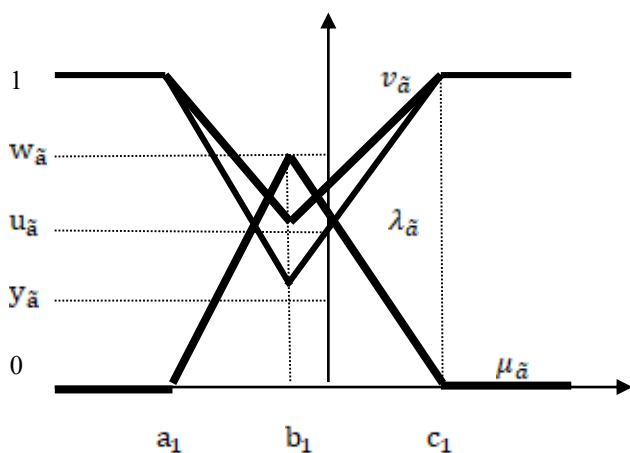

Fig. 3: ($\tilde{a} = \langle (a_1, b_1, c_1); w_{\tilde{a}}, u_{\tilde{a}}, y_{\tilde{a}} \rangle ; a_1, b_1 < 0$ generalized single valued triangular neutrosophic number)

Now let's define the basic operations for generalized single valued triangular neutrosophic numbers.

Degrees of membership / indeterminacy / nonmembership > 1 or < 0 have been proposed by Smarandache since 2007.

Definition 3.2: Let $\tilde{a} = \langle (a_1, b_1, c_1); w_{\tilde{a}}, u_{\tilde{a}}, y_{\tilde{a}} \rangle$ and $\tilde{b} = \langle (a_2, b_2, c_2); w_{\tilde{b}}, u_{\tilde{b}}, y_{\tilde{b}} \rangle$, be two generalized single valued triangular neutrosophic numbers and $\gamma \neq 0$ be any real number. Then,

$$1. \tilde{a} + \tilde{b} = \langle (a_1 + a_2, b_1 + b_2, c_1 + c_2); w_{\tilde{a}} \wedge w_{\tilde{b}}, u_{\tilde{a}} \vee u_{\tilde{b}}, y_{\tilde{a}} \vee y_{\tilde{b}} \rangle$$

$$2. \tilde{a} - \tilde{b} = \langle (a_1 - c_2, b_1 - b_2, c_1 - a_2); w_{\tilde{a}} \wedge w_{\tilde{b}}, u_{\tilde{a}} \vee u_{\tilde{b}}, y_{\tilde{a}} \vee y_{\tilde{b}} \rangle$$

$$3. \text{ For the set } \mathcal{L} = \{a_1 a_2, c_1 c_2, a_1 c_2, c_1 a_2\};$$

λ_1 : is the minimum value of \mathcal{L}

λ_2 : be the largest element of \mathcal{L} ;

$$\tilde{a} \tilde{b} = \langle (\lambda_1, b_1 b_2, \lambda_2); w_{\tilde{a}} \wedge w_{\tilde{b}}, u_{\tilde{a}} \vee u_{\tilde{b}}, y_{\tilde{a}} \vee y_{\tilde{b}} \rangle .$$

$$4. \text{ For the set } \mathcal{L} = \{a_1/a_2, c_1/c_2, a_1/c_2, c_1/a_2\};$$

λ_1 : is the minimum value of \mathcal{L} ,

λ_2 : be the largest element of \mathcal{L} ;

$$\tilde{a} / \tilde{b} = \langle (\lambda_1, b_1/b_2, \lambda_2); w_{\tilde{a}} \wedge w_{\tilde{b}}, u_{\tilde{a}} \vee u_{\tilde{b}}, y_{\tilde{a}} \vee y_{\tilde{b}} \rangle$$

$$5. \text{ For the set } \mathcal{L} = \{\gamma a_1, \gamma c_1\};$$

λ_1 : is the minimum value of \mathcal{L} ,

λ_2 : be the largest element of \mathcal{L} ;

$$\gamma \tilde{a} = \langle (\lambda_1, \gamma b_1, \lambda_2); w_{\tilde{a}} \wedge w_{\tilde{b}}, u_{\tilde{a}} \vee u_{\tilde{b}}, y_{\tilde{a}} \vee y_{\tilde{b}} \rangle$$

$$6. \text{ For the set } \mathcal{L} = \{1/a_1, 1/c_1\};$$

λ_1 : is the minimum value of \mathcal{L} ,

λ_2 : be the largest element of \mathcal{L} ;

$$\tilde{a}^{-1} = \langle (\lambda_1, 1/b_1, \lambda_2); w_{\tilde{a}} \wedge w_{\tilde{b}}, u_{\tilde{a}} \vee u_{\tilde{b}}, y_{\tilde{a}} \vee y_{\tilde{b}} \rangle$$

These operations also give the same results as the operations in definition 2.10. Namely, these operations are a generalized description of the operations in Definition 2.10.

4. TRANSFORMED SINGLE VALUED TRIANGULAR NEUTROSOPHIC NUMBERS, HAMMING DISTANCE AND A NEW SCORE FUNCTION BASED ON HAMMING DISTANCE FOR GENERALIZED SINGLE VALUED TRIANGULAR NEUTROSOPHIC NUMBER

In this section, we define single valued triangular neutrosophic numbers by transforming single valued neutrosophic numbers in the definition 2.6. However, since single valued neutrosophic numbers consist of independent truth, falsity, and indeterminacy states, we have defined a separate transformation for each case. However, we have generalized the Hamming distance to single valued triangular neutrosophic numbers in the definition 2.2 for the triangular intuitionistic fuzzy numbers and gave some properties. We then defined new score functions based on the Hamming distance measure. We compared the results obtained with these scoring functions to the results of the scoring functions in definition 2.7 and definition 2.11.

Definition 4.1 $\tilde{a} = (T_{\tilde{a}}, I_{\tilde{a}}, F_{\tilde{a}})$ conversion to a generalized single valued triangular neutrosophic number according to the truth value for a single valued neutrosophic number;

$$a_1 = T_{\tilde{a}} - I_{\tilde{a}} - F_{\tilde{a}}$$

$$b_1 = a_1 + (1 + T_{\tilde{a}} - F_{\tilde{a}}) = 1 + 2T_{\tilde{a}} - I_{\tilde{a}} - 2F_{\tilde{a}}$$

$$c_1 = b_1 + (1 + T_{\tilde{a}} - I_{\tilde{a}}) = 2 + 3T_{\tilde{a}} - 2I_{\tilde{a}} - 2F_{\tilde{a}} \quad \text{and}$$

$$T_{\tilde{a}} = w_{\tilde{a}}, I_{\tilde{a}} = u_{\tilde{a}}, F_{\tilde{a}} = y_{\tilde{a}} ;$$

$$\begin{array}{ccc} & \text{Transformed} & \\ \tilde{a} = (T_{\tilde{a}}, I_{\tilde{a}}, F_{\tilde{a}}) & \Longrightarrow & \tilde{a}_T = ((a_1, b_1, c_1); w_{\tilde{a}}, u_{\tilde{a}}, y_{\tilde{a}}). \text{ Namely} \\ & & \tilde{a}_T = ((T_{\tilde{a}} - I_{\tilde{a}} - F_{\tilde{a}}, 1 + 2T_{\tilde{a}} - I_{\tilde{a}} - 2F_{\tilde{a}}, 2 + 3T_{\tilde{a}} - 2I_{\tilde{a}} - 2F_{\tilde{a}}); T_{\tilde{a}}, I_{\tilde{a}}, F_{\tilde{a}})). \end{array}$$

Thus we obtained the number of \tilde{a}_T generalized single valued triangular neutrosophic number from \tilde{a} single valued neutrosophic number. Hence, $1 + T_{\tilde{a}} - F_{\tilde{a}} \geq 0$ and $1 + T_{\tilde{a}} - I_{\tilde{a}} \geq 0$ for $a_1 \leq b_1 \leq c_1$. Because of this each \tilde{a}_T number obtained from the definition of single valued neutrosophic number is a generalized single valued triangular neutrosophic number.

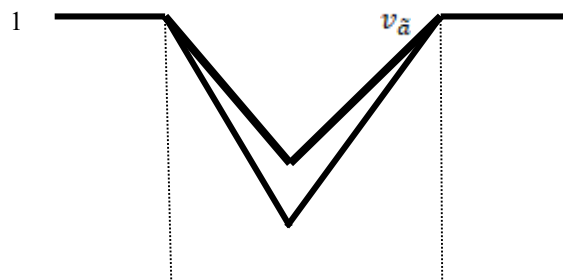

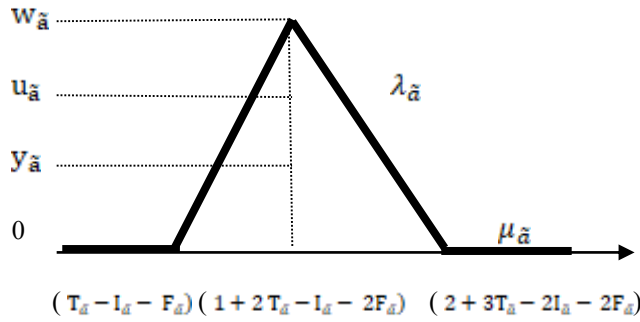

Fig. 4: $(\tilde{\alpha}_T = \langle (a_1, b_1, c_1); w_{\tilde{\alpha}}, u_{\tilde{\alpha}}, y_{\tilde{\alpha}} \rangle$ generalized single valued triangular neutrosophic number)

Definition 4.2 $\tilde{\alpha} = (T_{\tilde{\alpha}}, I_{\tilde{\alpha}}, F_{\tilde{\alpha}})$ conversion to a generalized single valued triangular neutrosophic number according to the indeterminacy value for the single valued neutrosophic number;

$$a_1 = T_{\tilde{\alpha}} - I_{\tilde{\alpha}} - F_{\tilde{\alpha}}$$

$$b_1 = a_1 + (1 + I_{\tilde{\alpha}} - F_{\tilde{\alpha}}) = 1 + T_{\tilde{\alpha}} - 2F_{\tilde{\alpha}}$$

$$c_1 = b_1 + (1 + I_{\tilde{\alpha}} - T_{\tilde{\alpha}}) = 2 + I_{\tilde{\alpha}} - 2F_{\tilde{\alpha}} \quad \text{and}$$

$$T_{\tilde{\alpha}} = w_{\tilde{\alpha}}, I_{\tilde{\alpha}} = u_{\tilde{\alpha}}, F_{\tilde{\alpha}} = y_{\tilde{\alpha}} ;$$

transformed

$$\tilde{\alpha} = (T_{\tilde{\alpha}}, I_{\tilde{\alpha}}, F_{\tilde{\alpha}}) \xrightarrow{\hspace{2cm}} \tilde{\alpha}_I = \langle (a_1, b_1, c_1); w_{\tilde{\alpha}}, u_{\tilde{\alpha}}, y_{\tilde{\alpha}} \rangle. \text{ Namely}$$

$$\tilde{\alpha}_I = \langle (T_{\tilde{\alpha}} - I_{\tilde{\alpha}} - F_{\tilde{\alpha}}, 1 + T_{\tilde{\alpha}} - 2F_{\tilde{\alpha}}, 2 + I_{\tilde{\alpha}} - 2F_{\tilde{\alpha}}); T_{\tilde{\alpha}}, I_{\tilde{\alpha}}, F_{\tilde{\alpha}} \rangle.$$

Thus we obtained the number of $\tilde{\alpha}_I$ generalized single valued triangular neutrosophic number from $\tilde{\alpha}$ single valued neutrosophic number. Hence $1 + I_{\tilde{\alpha}} - F_{\tilde{\alpha}} \geq 0$ and $1 + I_{\tilde{\alpha}} - T_{\tilde{\alpha}} \geq 0$; $a_1 \leq b_1 \leq c_1$. Because of this each $\tilde{\alpha}_I$ number obtained from the definition of single valued neutrosophic number is a generalized single valued triangular neutrosophic number.

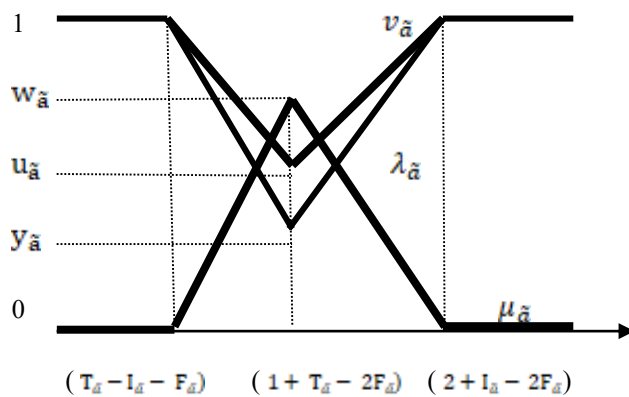

Fig. 5: $(\tilde{\alpha}_I = \langle (a_1, b_1, c_1); w_{\tilde{\alpha}}, u_{\tilde{\alpha}}, y_{\tilde{\alpha}} \rangle$ generalized single valued triangular neutrosophic number)

Definition 4.3 $\tilde{a}=(T_{\tilde{a}}, I_{\tilde{a}}, F_{\tilde{a}})$ conversion to a generalized single valued triangular neutrosophic number according to the falsity value for the single valued neutrosophic number;

$$a_1 = T_{\tilde{a}} - I_{\tilde{a}} - F_{\tilde{a}}$$

$$b_1 = a_1 + (1 + F_{\tilde{a}} - I_{\tilde{a}}) = 1 + T_{\tilde{a}} - 2I_{\tilde{a}}$$

$$c_1 = b_1 + (1 + F_{\tilde{a}} - T_{\tilde{a}}) = 2 + F_{\tilde{a}} - 2I_{\tilde{a}} \quad \text{and}$$

$$T_{\tilde{a}} = w_{\tilde{a}}, I_{\tilde{a}} = u_{\tilde{a}}, F_{\tilde{a}} = y_{\tilde{a}} ;$$

$$\begin{aligned} & \text{Transformed} \\ \tilde{a} = (T_{\tilde{a}}, I_{\tilde{a}}, F_{\tilde{a}}) & \quad \Longrightarrow \quad \tilde{a}_F = \langle (a_1, b_1, c_1); w_{\tilde{a}}, u_{\tilde{a}}, y_{\tilde{a}} \rangle. \text{ Namely} \\ & \tilde{a}_F = \langle (T_{\tilde{a}} - I_{\tilde{a}} - F_{\tilde{a}}, 1 + T_{\tilde{a}} - 2I_{\tilde{a}}, 2 + F_{\tilde{a}} - 2I_{\tilde{a}}); T_{\tilde{a}}, I_{\tilde{a}}, F_{\tilde{a}} \rangle. \end{aligned}$$

Thus we obtained the number of \tilde{a}_F generalized single valued triangular neutrosophic number from \tilde{a} single valued neutrosophic number. Hence, $1 + F_{\tilde{a}} - I_{\tilde{a}} \geq 0$ and $1 + F_{\tilde{a}} - T_{\tilde{a}} \geq 0$ for $a_1 \leq b_1 \leq c_1$. Because of this each \tilde{a}_F number obtained from the definition of single valued neutrosophic number is a generalized single valued triangular neutrosophic number.

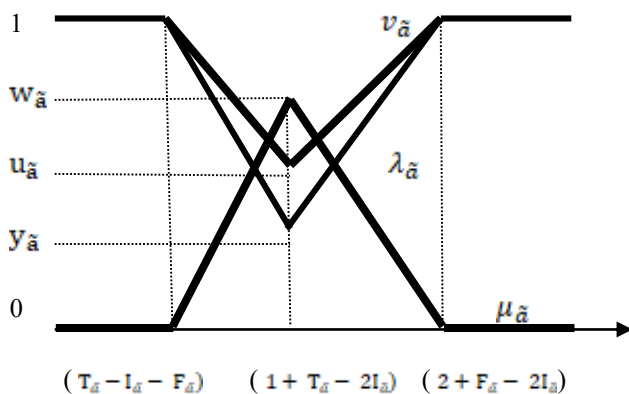

Fig. 6 $(\tilde{a}_F = \langle (a_1, b_1, c_1); w_{\tilde{a}}, u_{\tilde{a}}, y_{\tilde{a}} \rangle)$ generalized single valued triangular neutrosophic number

Definition 4.4:

a) $\tilde{a}=(T_{\tilde{a}}, I_{\tilde{a}}, F_{\tilde{a}})$ ideal generalized single valued triangular neutrosophic number according to the truth value for single valued neutrosophic numbers;

$$T_{\tilde{a}} = 1, I_{\tilde{a}} = 0 \text{ and } F_{\tilde{a}} = 0; \tilde{a}_T^i =$$

$$\langle (T_{\tilde{a}} - I_{\tilde{a}} - F_{\tilde{a}}, 1 + 2T_{\tilde{a}} - I_{\tilde{a}} - 2F_{\tilde{a}}, 2 + 3T_{\tilde{a}} - 2I_{\tilde{a}} - 2F_{\tilde{a}}); T_{\tilde{a}}, I_{\tilde{a}}, F_{\tilde{a}} \rangle = \langle (1, 3, 5); 1, 0, 0 \rangle.$$

b) $\tilde{a}=(T_{\tilde{a}}, I_{\tilde{a}}, F_{\tilde{a}})$ ideal generalized single valued triangular neutrosophic number according to the indeterminacy value for single valued neutrosophic numbers;

$$T_{\tilde{\alpha}} = 1, I_{\tilde{\alpha}} = 0 \text{ and } F_{\tilde{\alpha}} = 0; \tilde{\alpha}_1^i =$$

$$\langle (T_{\tilde{\alpha}} - I_{\tilde{\alpha}} - F_{\tilde{\alpha}}, 1 + T_{\tilde{\alpha}} - 2F_{\tilde{\alpha}}, 2 + I_{\tilde{\alpha}} - 2F_{\tilde{\alpha}}); T_{\tilde{\alpha}}, I_{\tilde{\alpha}}, F_{\tilde{\alpha}} \rangle = \langle (1, 2, 3); 1, 0, 0 \rangle.$$

c) $\tilde{\alpha} = (T_{\tilde{\alpha}}, I_{\tilde{\alpha}}, F_{\tilde{\alpha}})$ ideal generalized single valued triangular neutrosophic number according to the falsity value for single valued neutrosophic numbers;

$$T_{\tilde{\alpha}} = 1, I_{\tilde{\alpha}} = 0 \text{ and } F_{\tilde{\alpha}} = 0; \tilde{\alpha}_P^i =$$

$$\langle (T_{\tilde{\alpha}} - I_{\tilde{\alpha}} - F_{\tilde{\alpha}}, 1 + T_{\tilde{\alpha}} - 2I_{\tilde{\alpha}}, 2 + F_{\tilde{\alpha}} - 2I_{\tilde{\alpha}}); T_{\tilde{\alpha}}, I_{\tilde{\alpha}}, F_{\tilde{\alpha}} \rangle = \langle (1, 2, 3); 1, 0, 0 \rangle.$$

It can be seen from b) and c), $\tilde{\alpha}_1^i = \tilde{\alpha}_P^i$.

Definition 4.5: Let $\tilde{\alpha}_1 = \langle (a_1, b_1, c_1); w_{\tilde{\alpha}_1}, u_{\tilde{\alpha}_1}, y_{\tilde{\alpha}_1} \rangle$ and $\tilde{\alpha}_2 = \langle (a_2, b_2, c_2); w_{\tilde{\alpha}_2}, u_{\tilde{\alpha}_2}, y_{\tilde{\alpha}_2} \rangle$ be two generalized single valued triangular neutrosophic numbers. The Hamming distance between $\tilde{\alpha}_1$ and $\tilde{\alpha}_2$ is

$$d_n(\tilde{\alpha}_1, \tilde{\alpha}_2) = \frac{1}{12} [|(2 + w_{\tilde{\alpha}_1} - u_{\tilde{\alpha}_1} - y_{\tilde{\alpha}_1})a_1 - (2 + w_{\tilde{\alpha}_2} - u_{\tilde{\alpha}_2} - y_{\tilde{\alpha}_2})a_2| + \\ |(2 + w_{\tilde{\alpha}_1} - u_{\tilde{\alpha}_1} - y_{\tilde{\alpha}_1})b_1 - (2 + w_{\tilde{\alpha}_2} - u_{\tilde{\alpha}_2} - y_{\tilde{\alpha}_2})b_2| + \\ |(2 + w_{\tilde{\alpha}_1} - u_{\tilde{\alpha}_1} - y_{\tilde{\alpha}_1})c_1 - (2 + w_{\tilde{\alpha}_2} - u_{\tilde{\alpha}_2} - y_{\tilde{\alpha}_2})c_2|]$$

This definition is the expansion of the Hamming distance given to the triangular intuitionistic fuzzy numbers given in the definition to generalized single valued triangular neutrosophic numbers.

Proposition 4.6: The Hamming distance $d_n(\tilde{\alpha}_1, \tilde{\alpha}_2)$ satisfies the following properties.

$$1) d_n(\tilde{\alpha}_1, \tilde{\alpha}_2) \geq 0$$

$$2) d_n(\tilde{\alpha}_1, \tilde{\alpha}_2) = 0, \text{ if } \tilde{\alpha}_1 = \tilde{\alpha}_2, \text{ for all } \tilde{\alpha}_1, \tilde{\alpha}_2 \in \bar{N}_R$$

$$3) d_n(\tilde{\alpha}_1, \tilde{\alpha}_2) = d_n(\tilde{\alpha}_2, \tilde{\alpha}_1)$$

4) Let $\tilde{\alpha}_j = \langle (a_j, b_j, c_j); w_{\tilde{\alpha}_j}, u_{\tilde{\alpha}_j}, y_{\tilde{\alpha}_j} \rangle$, $\tilde{b}_j = \langle (e_j, f_j, g_j); w_{\tilde{b}_j}, u_{\tilde{b}_j}, y_{\tilde{b}_j} \rangle$ and $\tilde{c}_j = \langle (h_j, l_j, m_j); w_{\tilde{c}_j}, u_{\tilde{c}_j}, y_{\tilde{c}_j} \rangle$ be three single valued triangular neutrosophic numbers.

If $a_j \leq e_j \leq h_j, b_j \leq f_j \leq l_j, c_j \leq g_j \leq m_j, w_{\tilde{\alpha}_j} \leq w_{\tilde{b}_j} \leq w_{\tilde{c}_j}, u_{\tilde{\alpha}_j} \leq u_{\tilde{b}_j} \leq u_{\tilde{c}_j}, y_{\tilde{\alpha}_j} \geq y_{\tilde{b}_j} \geq y_{\tilde{c}_j}$ then;

$$d_n(\tilde{\alpha}_j, \tilde{c}_j) \geq d_n(\tilde{\alpha}_j, \tilde{b}_j) \quad \text{and} \quad d_n(\tilde{\alpha}_j, \tilde{c}_j) \geq d_n(\tilde{b}_j, \tilde{c}_j)$$

Proof: The proof of 1), 2), 3) can easily be done by the definition 4.5. Now let's prove 4).

Let's show that $d_n(\tilde{\alpha}_j, \tilde{c}_j) \geq d_n(\tilde{\alpha}_j, \tilde{b}_j)$.

$$d_n(\tilde{\alpha}_j, \tilde{c}_j) =$$

$$\frac{1}{12} \left[\left| \left(2 + w_{\tilde{a}_j} - u_{\tilde{a}_j} - y_{\tilde{a}_j} \right) a_j - \left(2 + w_{\tilde{c}_j} - u_{\tilde{c}_j} - y_{\tilde{c}_j} \right) h_j \right| + \right. \\ \left. \left| \left(2 + w_{\tilde{a}_j} - u_{\tilde{a}_j} - y_{\tilde{a}_j} \right) b_j - \left(2 + w_{\tilde{c}_j} - u_{\tilde{c}_j} - y_{\tilde{c}_j} \right) l_j \right| + \right. \\ \left. \left| \left(2 + w_{\tilde{a}_j} - u_{\tilde{a}_j} - y_{\tilde{a}_j} \right) c_j - \left(2 + w_{\tilde{c}_j} - u_{\tilde{c}_j} - y_{\tilde{c}_j} \right) m_j \right| \right]$$

And $a_j \leq e_j \leq h_j$, $b_j \leq f_j \leq l_j$, $c_j \leq g_j \leq m_j$, $w_{\tilde{a}_j} \leq w_{\tilde{b}_j} \leq w_{\tilde{c}_j}$, $u_{\tilde{a}_j} \leq u_{\tilde{b}_j} \leq u_{\tilde{c}_j}$, $y_{\tilde{a}_j} \geq y_{\tilde{b}_j} \geq y_{\tilde{c}_j}$ hence;

$2 + w_{\tilde{a}_j} - u_{\tilde{a}_j} - y_{\tilde{a}_j} \leq 2 + w_{\tilde{c}_j} - u_{\tilde{c}_j} - y_{\tilde{c}_j}$ and $a_j \leq e_j \leq h_j$. Hence;

$$\left(2 + w_{\tilde{a}_j} - u_{\tilde{a}_j} - y_{\tilde{a}_j} \right) a_j \leq \left(2 + w_{\tilde{c}_j} - u_{\tilde{c}_j} - y_{\tilde{c}_j} \right) h_j . \text{ Similarly;}$$

$$\left(2 + w_{\tilde{a}_j} - u_{\tilde{a}_j} - y_{\tilde{a}_j} \right) b_j \leq \left(2 + w_{\tilde{c}_j} - u_{\tilde{c}_j} - y_{\tilde{c}_j} \right) l_j ;$$

$$\left(2 + w_{\tilde{a}_j} - u_{\tilde{a}_j} - y_{\tilde{a}_j} \right) c_j \leq \left(2 + w_{\tilde{c}_j} - u_{\tilde{c}_j} - y_{\tilde{c}_j} \right) m_j . \text{ From here;}$$

$$d_n(\tilde{a}_j, \tilde{c}_j) =$$

$$\frac{1}{12} \left[\left(\left(2 + w_{\tilde{c}_j} - u_{\tilde{c}_j} - y_{\tilde{c}_j} \right) h_j - \left(2 + w_{\tilde{a}_j} - u_{\tilde{a}_j} - y_{\tilde{a}_j} \right) a_j \right) + \right. \\ \left(\left(2 + w_{\tilde{c}_j} - u_{\tilde{c}_j} - y_{\tilde{c}_j} \right) l_j - \left(2 + w_{\tilde{a}_j} - u_{\tilde{a}_j} - y_{\tilde{a}_j} \right) b_j \right) + \\ \left. \left(\left(2 + w_{\tilde{c}_j} - u_{\tilde{c}_j} - y_{\tilde{c}_j} \right) m_j - \left(2 + w_{\tilde{a}_j} - u_{\tilde{a}_j} - y_{\tilde{a}_j} \right) c_j \right) \right] \dots \dots \dots (1)$$

$$d_n(\tilde{a}_j, \tilde{b}_j) =$$

$$\frac{1}{12} \left[\left| \left(2 + w_{\tilde{a}_j} - u_{\tilde{a}_j} - y_{\tilde{a}_j} \right) a_j - \left(2 + w_{\tilde{b}_j} - u_{\tilde{b}_j} - y_{\tilde{b}_j} \right) e_j \right| + \right. \\ \left| \left(2 + w_{\tilde{a}_j} - u_{\tilde{a}_j} - y_{\tilde{a}_j} \right) b_j - \left(2 + w_{\tilde{b}_j} - u_{\tilde{b}_j} - y_{\tilde{b}_j} \right) f_j \right| + \\ \left| \left(2 + w_{\tilde{a}_j} - u_{\tilde{a}_j} - y_{\tilde{a}_j} \right) c_j - \left(2 + w_{\tilde{b}_j} - u_{\tilde{b}_j} - y_{\tilde{b}_j} \right) g_j \right| \right]$$

and $a_j \leq e_j \leq h_j$, $b_j \leq f_j \leq l_j$, $c_j \leq g_j \leq m_j$, $w_{\tilde{a}_j} \leq w_{\tilde{b}_j} \leq w_{\tilde{c}_j}$, $u_{\tilde{a}_j} \leq u_{\tilde{b}_j} \leq u_{\tilde{c}_j}$, $y_{\tilde{a}_j} \geq y_{\tilde{b}_j} \geq y_{\tilde{c}_j}$ hence;

$2 + w_{\tilde{a}_j} - u_{\tilde{a}_j} - y_{\tilde{a}_j} \leq 2 + w_{\tilde{c}_j} - u_{\tilde{c}_j} - y_{\tilde{c}_j}$ and $a_j \leq e_j \leq h_j$ hence;

$$\left(2 + w_{\tilde{a}_j} - u_{\tilde{a}_j} - y_{\tilde{a}_j} \right) a_j \leq \left(2 + w_{\tilde{b}_j} - u_{\tilde{b}_j} - y_{\tilde{b}_j} \right) e_j .$$

Similarly,

$$\left(2 + w_{\tilde{a}_j} - u_{\tilde{a}_j} - y_{\tilde{a}_j} \right) b_j \leq \left(2 + w_{\tilde{b}_j} - u_{\tilde{b}_j} - y_{\tilde{b}_j} \right) f_j ;$$

$$\left(2 + w_{\tilde{a}_j} - u_{\tilde{a}_j} - y_{\tilde{a}_j} \right) c_j \leq \left(2 + w_{\tilde{b}_j} - u_{\tilde{b}_j} - y_{\tilde{b}_j} \right) g_j . \text{ From here;}$$

$$d_n(\tilde{a}_j, \tilde{b}_j) =$$

$$\frac{1}{12} \left[\left(\left(2 + w_{\tilde{b}_j} - u_{\tilde{b}_j} - y_{\tilde{b}_j} \right) e_j - \left(2 + w_{\tilde{a}_j} - u_{\tilde{a}_j} - y_{\tilde{a}_j} \right) a_j \right) + \right.$$

$$\begin{aligned} & ((2 + w_{\tilde{b}_j} - u_{\tilde{b}_j} - y_{\tilde{b}_j})f_j - (2 + w_{\tilde{a}_j} - u_{\tilde{a}_j} - y_{\tilde{a}_j})b_j) + \\ & ((2 + w_{\tilde{b}_j} - u_{\tilde{b}_j} - y_{\tilde{b}_j})g_j - (2 + w_{\tilde{a}_j} - u_{\tilde{a}_j} - y_{\tilde{a}_j})c_j) \end{aligned} \dots\dots\dots(2)$$

From (1) and (2) $d_n(\tilde{a}_j, \tilde{c}_j) - d_n(\tilde{a}_j, \tilde{b}_j) =$

$$\begin{aligned} & \frac{1}{12}[(2 + w_{\tilde{e}_j} - u_{\tilde{e}_j} - y_{\tilde{e}_j})h_j - (2 + w_{\tilde{a}_j} - u_{\tilde{a}_j} - y_{\tilde{a}_j})a_j] - (2 + w_{\tilde{b}_j} - u_{\tilde{b}_j} - y_{\tilde{b}_j})e_j + \\ & (2 + w_{\tilde{a}_j} - u_{\tilde{a}_j} - y_{\tilde{a}_j})a_j] \\ & + \frac{1}{12}[(2 + w_{\tilde{a}_j} - u_{\tilde{a}_j} - y_{\tilde{a}_j})b_j - (2 + w_{\tilde{e}_j} - u_{\tilde{e}_j} - y_{\tilde{e}_j})l_j - (2 + w_{\tilde{b}_j} - u_{\tilde{b}_j} - y_{\tilde{b}_j})f_j + \\ & (2 + w_{\tilde{a}_j} - u_{\tilde{a}_j} - y_{\tilde{a}_j})b_j] \\ & + \frac{1}{12}[(2 + w_{\tilde{e}_j} - u_{\tilde{e}_j} - y_{\tilde{e}_j})m_j - (2 + w_{\tilde{a}_j} - u_{\tilde{a}_j} - y_{\tilde{a}_j})c_j - (2 + w_{\tilde{b}_j} - u_{\tilde{b}_j} - y_{\tilde{b}_j})g_j + \\ & (2 + w_{\tilde{a}_j} - u_{\tilde{a}_j} - y_{\tilde{a}_j})c_j] \\ & = \frac{1}{12}[(2 + w_{\tilde{e}_j} - u_{\tilde{e}_j} - y_{\tilde{e}_j})h_j - (2 + w_{\tilde{b}_j} - u_{\tilde{b}_j} - y_{\tilde{b}_j})e_j] \\ & + \frac{1}{12}[(2 + w_{\tilde{a}_j} - u_{\tilde{a}_j} - y_{\tilde{a}_j})b_j - (2 + w_{\tilde{b}_j} - u_{\tilde{b}_j} - y_{\tilde{b}_j})f_j] \\ & + \frac{1}{12}[(2 + w_{\tilde{e}_j} - u_{\tilde{e}_j} - y_{\tilde{e}_j})m_j - (2 + w_{\tilde{b}_j} - u_{\tilde{b}_j} - y_{\tilde{b}_j})g_j]. \text{ Here;} \end{aligned}$$

$a_j \leq e_j \leq h_j, b_j \leq f_j \leq l_j, c_j \leq g_j \leq m_j, w_{\tilde{a}_j} \leq w_{\tilde{b}_j} \leq w_{\tilde{e}_j}, u_{\tilde{a}_j} \leq u_{\tilde{b}_j} \leq u_{\tilde{e}_j}, y_{\tilde{a}_j} \geq y_{\tilde{b}_j} \geq y_{\tilde{e}_j}$. Hence;

$$\frac{1}{12}[(2 + w_{\tilde{e}_j} - u_{\tilde{e}_j} - y_{\tilde{e}_j})h_j - (2 + w_{\tilde{b}_j} - u_{\tilde{b}_j} - y_{\tilde{b}_j})e_j] \geq 0 \dots\dots\dots(3)$$

$$\frac{1}{12}[(2 + w_{\tilde{a}_j} - u_{\tilde{a}_j} - y_{\tilde{a}_j})b_j - (2 + w_{\tilde{b}_j} - u_{\tilde{b}_j} - y_{\tilde{b}_j})f_j] \geq 0 \dots\dots\dots(4)$$

$$\frac{1}{12}[(2 + w_{\tilde{e}_j} - u_{\tilde{e}_j} - y_{\tilde{e}_j})m_j - (2 + w_{\tilde{b}_j} - u_{\tilde{b}_j} - y_{\tilde{b}_j})g_j] \geq 0 \dots\dots\dots(5)$$

From (3), (4) and (5) $d_n(\tilde{a}_j, \tilde{c}_j) - d_n(\tilde{a}_j, \tilde{b}_j) \geq 0$. Namely; $d_n(\tilde{a}_j, \tilde{c}_j) \geq d_n(\tilde{a}_j, \tilde{b}_j)$.

$d_n(\tilde{a}_j, \tilde{c}_j) \geq d_n(\tilde{b}_j, \tilde{c}_j)$ can be showed a similar way to the proof of $d_n(\tilde{a}_j, \tilde{c}_j) \geq d_n(\tilde{a}_j, \tilde{b}_j)$.

Definition 4.7: $\tilde{a} = (T_{\tilde{a}}, I_{\tilde{a}}, F_{\tilde{a}})$ single valued neutrosophic number, $\tilde{a}_T = ((T_{\tilde{a}} - I_{\tilde{a}} - F_{\tilde{a}}, 1 + 2T_{\tilde{a}} - I_{\tilde{a}} - 2F_{\tilde{a}}, 2 + 3T_{\tilde{a}} - 2I_{\tilde{a}} - 2F_{\tilde{a}}); T_{\tilde{a}}, I_{\tilde{a}}, F_{\tilde{a}})$ generalized single valued triangular neutrosophic number transformed according to the truth value of \tilde{a} , $\tilde{a}_T^i = ((1,3,5); 1,0,0)$, ideal generalized single valued triangular neutrosophic number transformed according to the truth value of \tilde{a} , and let

d_n be the Hamming distance for generalized single valued triangular neutrosophic number. According to the truth value of single valued neutrosophic numbers certainty and score functions are

$$S_T(\tilde{\alpha}) = d_n(\tilde{\alpha}_T, \tilde{\alpha}_T^i)$$

$A_T(\tilde{\alpha}) = \min\{|T_{\tilde{\alpha}} - I_{\tilde{\alpha}}|, |T_{\tilde{\alpha}} - F_{\tilde{\alpha}}|\}$ respectively. Here;

$$S_T(\tilde{\alpha}) =$$

$$\begin{aligned} & \frac{1}{12}[|(2 + T_{\tilde{\alpha}} - I_{\tilde{\alpha}} - F_{\tilde{\alpha}})(T_{\tilde{\alpha}} - I_{\tilde{\alpha}} - F_{\tilde{\alpha}}) - (2 + 1 - 0 - 0). 1| + \\ & |(2 + T_{\tilde{\alpha}} - I_{\tilde{\alpha}} - F_{\tilde{\alpha}})(2T_{\tilde{\alpha}} - I_{\tilde{\alpha}} - 2F_{\tilde{\alpha}}) - (2 + 1 - 0 - 0). 3| + \\ & |(2 + T_{\tilde{\alpha}} - I_{\tilde{\alpha}} - F_{\tilde{\alpha}})(2 + 3T_{\tilde{\alpha}} - 2I_{\tilde{\alpha}} - 2F_{\tilde{\alpha}}) - (2 + 1 - 0 - 0). 5|] \\ & = \frac{1}{12}[|(2 + T_{\tilde{\alpha}} - I_{\tilde{\alpha}} - F_{\tilde{\alpha}})(T_{\tilde{\alpha}} - I_{\tilde{\alpha}} - F_{\tilde{\alpha}}) - 3| + |(2 + T_{\tilde{\alpha}} - I_{\tilde{\alpha}} - F_{\tilde{\alpha}})(2T_{\tilde{\alpha}} - I_{\tilde{\alpha}} - 2F_{\tilde{\alpha}}) - 9| + \\ & |(2 + T_{\tilde{\alpha}} - I_{\tilde{\alpha}} - F_{\tilde{\alpha}})(2 + 3T_{\tilde{\alpha}} - 2I_{\tilde{\alpha}} - 2F_{\tilde{\alpha}}) - 15|]. \end{aligned}$$

Definition 4.8: Let $\tilde{\alpha} = (T_{\tilde{\alpha}}, I_{\tilde{\alpha}}, F_{\tilde{\alpha}})$ be single valued neutrosophic number, $\tilde{\alpha}_I = ((T_{\tilde{\alpha}} - I_{\tilde{\alpha}} - F_{\tilde{\alpha}}, 1 + T_{\tilde{\alpha}} - 2F_{\tilde{\alpha}}, 2 + I_{\tilde{\alpha}} - 2F_{\tilde{\alpha}}); T_{\tilde{\alpha}}, I_{\tilde{\alpha}}, F_{\tilde{\alpha}})$; be generalized single valued triangular neutrosophic number transformed according to the indeterminacy value of $\tilde{\alpha}$, $\tilde{\alpha}_I^i = ((1, 2, 2); 1, 0, 0)$, be ideal generalized single valued triangular neutrosophic number transformed according to the indeterminacy value of $\tilde{\alpha}$, and d_n be hamming distance for generalized single valued triangular neutrosophic number. According to the indeterminacy value of single valued neutrosophic numbers certainty and score functions are;

$$S_I(\tilde{\alpha}) = d_n(\tilde{\alpha}_I, \tilde{\alpha}_I^i)$$

$A_I = \min\{|I_{\tilde{\alpha}} - T_{\tilde{\alpha}}|, |I_{\tilde{\alpha}} - F_{\tilde{\alpha}}|\}$, respectively. Here;

$$S_I(\tilde{\alpha}) =$$

$$\begin{aligned} & \frac{1}{12}[|(2 + T_{\tilde{\alpha}} - I_{\tilde{\alpha}} - F_{\tilde{\alpha}})(T_{\tilde{\alpha}} - I_{\tilde{\alpha}} - F_{\tilde{\alpha}}) - (2 + 1 - 0 - 0). 1| + \\ & |(2 + T_{\tilde{\alpha}} - I_{\tilde{\alpha}} - F_{\tilde{\alpha}})(1 + T_{\tilde{\alpha}} - 2F_{\tilde{\alpha}}) - (2 + 1 - 0 - 0). 2| + \\ & |(2 + T_{\tilde{\alpha}} - I_{\tilde{\alpha}} - F_{\tilde{\alpha}})(2 + I_{\tilde{\alpha}} - 2F_{\tilde{\alpha}}) - (2 + 1 - 0 - 0). 2|] \\ & = \frac{1}{12}[|(2 + T_{\tilde{\alpha}} - I_{\tilde{\alpha}} - F_{\tilde{\alpha}})(T_{\tilde{\alpha}} - I_{\tilde{\alpha}} - F_{\tilde{\alpha}}) - 2| + |(2 + T_{\tilde{\alpha}} - I_{\tilde{\alpha}} - F_{\tilde{\alpha}})(1 + T_{\tilde{\alpha}} - 2F_{\tilde{\alpha}}) - 6| + \\ & |(2 + T_{\tilde{\alpha}} - I_{\tilde{\alpha}} - F_{\tilde{\alpha}})(2 + I_{\tilde{\alpha}} - 2F_{\tilde{\alpha}}) - 6|] \end{aligned}$$

Definition 4.9: Let $\tilde{\alpha} = (T_{\tilde{\alpha}}, I_{\tilde{\alpha}}, F_{\tilde{\alpha}})$ be single valued neutrosophic number, $\tilde{\alpha}_F = ((T_{\tilde{\alpha}} - I_{\tilde{\alpha}} - F_{\tilde{\alpha}}, 1 + T_{\tilde{\alpha}} - 2I_{\tilde{\alpha}}, 2 + F_{\tilde{\alpha}} - 2I_{\tilde{\alpha}}); T_{\tilde{\alpha}}, I_{\tilde{\alpha}}, F_{\tilde{\alpha}})$; be generalized single valued triangular neutrosophic number transformed according to the falsity value of $\tilde{\alpha}$, $\tilde{\alpha}_F^i = ((1, 2, 2); 1, 0, 0)$, be ideal generalized single valued triangular neutrosophic number transformed according to the falsity value of $\tilde{\alpha}$, and d_n be Hamming distance for generalized single valued triangular neutrosophic number. According to the falsity value of single valued neutrosophic numbers certainty and score functions are;

$$S_F(\tilde{a}) = d_n(\tilde{a}_F, \tilde{a}_F^i)$$

$A_F = \min\{|F_{\tilde{a}} - I_{\tilde{a}}|, |F_{\tilde{a}} - I_{\tilde{a}}|\}$, respectively. Here;

$$S_F(\tilde{a}) =$$

$$\begin{aligned} & \frac{1}{12}[|(2 + T_{\tilde{a}} - I_{\tilde{a}} - F_{\tilde{a}})(T_{\tilde{a}} - I_{\tilde{a}} - F_{\tilde{a}}) - (2 + 1 - 0 - 0).1| + \\ & |(2 + T_{\tilde{a}} - I_{\tilde{a}} - F_{\tilde{a}})(1 + T_{\tilde{a}} - 2I_{\tilde{a}}) - (2 + 1 - 0 - 0).2| + \\ & |(2 + T_{\tilde{a}} - I_{\tilde{a}} - F_{\tilde{a}})(2 + F_{\tilde{a}} - 2I_{\tilde{a}}) - (2 + 1 - 0 - 0).2|] \\ & = \frac{1}{12}[|(2 + T_{\tilde{a}} - I_{\tilde{a}} - F_{\tilde{a}})(T_{\tilde{a}} - I_{\tilde{a}} - F_{\tilde{a}}) - 2| + |(2 + T_{\tilde{a}} - I_{\tilde{a}} - F_{\tilde{a}})(1 + T_{\tilde{a}} - 2I_{\tilde{a}}) - 6| + \\ & |(2 + T_{\tilde{a}} - I_{\tilde{a}} - F_{\tilde{a}})(2 + F_{\tilde{a}} - 2I_{\tilde{a}}) - 6|] \end{aligned}$$

Definition 4.10: Let $\tilde{a} = (T_{\tilde{a}}, I_{\tilde{a}}, F_{\tilde{a}})$ and $\tilde{b} = (T_{\tilde{b}}, I_{\tilde{b}}, F_{\tilde{b}})$ be two single valued neutrosophic numbers and S_T, A_T be score and certainty functions according to truth value.

- i) If $S_T(\tilde{a}) > S_T(\tilde{b})$, then \tilde{a} is greater than \tilde{b} and denoted by $\tilde{a} > \tilde{b}$.
- ii) If $S_T(\tilde{a}) = S_T(\tilde{b})$ and $A_T(\tilde{a}) > A_T(\tilde{b})$, then \tilde{a} is greater than \tilde{b} and denoted by $\tilde{a} > \tilde{b}$.
- iii) If $S_T(\tilde{a}) = S_T(\tilde{b})$ and $A_T(\tilde{a}) = A_T(\tilde{b})$, then \tilde{a} is equal to \tilde{b} and denoted by $\tilde{a} = \tilde{b}$.

This definition can also be done for S_I, A_I score and certainty functions in case of indeterminacy and for S_F, A_F score and certainty functions in case of falsity.

Definition 4.11: Let $\tilde{a}_j = \langle (a_j, b_j, c_j); w_{\tilde{a}_j}, u_{\tilde{a}_j}, y_{\tilde{a}_j} \rangle$ and d_n be Hamming distance for the generalized single valued triangular neutrosophic numbers.

- i) $\tilde{a}_T^i = \langle (1, 3, 5); 1, 0, 0 \rangle$, be ideal generalized single valued triangular neutrosophic number according to the truth value of \tilde{a} ; depending on the Hamming distance \tilde{a}_j generalized single valued triangular neutrosophic numbers according to the truth value score and certainty functions are;

$$S_{TT}(\tilde{a}_j) = d_n(\tilde{a}_j, \tilde{a}_T^i)$$

$A_{TT}(\tilde{a}_j) = \min\{|T_{\tilde{a}} - I_{\tilde{a}}|, |T_{\tilde{a}} - F_{\tilde{a}}|\}$ respectively.

- ii) $\tilde{a}_I^i = \langle (1, 2, 2); 1, 0, 0 \rangle$, be ideal generalized single valued triangular neutrosophic number according to the indeterminacy value of \tilde{a} ; depending on the hamming distance \tilde{a}_j generalized single valued triangular neutrosophic numbers according to the indeterminacy value score and certainty functions are;

$$S_{TI}(\tilde{a}_j) = d_n(\tilde{a}_j, \tilde{a}_I^i)$$

$$A_{TT}(\tilde{\alpha}_j) = \min\{|I_{\tilde{\alpha}} - T_{\tilde{\alpha}}|, |T_{\tilde{\alpha}} - F_{\tilde{\alpha}}|\} \text{ respectively.}$$

iii) i) $\tilde{\alpha}_F^i = \langle (1,2,2); 1,0,0 \rangle$, be ideal generalized single valued triangular neutrosophic number according to the falsity value of $\tilde{\alpha}$; depending on the Hamming distance $\tilde{\alpha}_j$ generalized single valued triangular neutrosophic numbers according to the falsity value score and certainty functions are;

$$S_{TF}(\tilde{\alpha}_j) = d_n(\tilde{\alpha}_j, \tilde{\alpha}_F^i)$$

$$A_{TF}(\tilde{\alpha}_j) = \min\{|F_{\tilde{\alpha}} - T_{\tilde{\alpha}}|, |F_{\tilde{\alpha}} - I_{\tilde{\alpha}}|\} \text{ respectively.}$$

Thus, for generalized single valued triangular neutrosophic numbers we have also defined a new scoring function based on the Hamming distance.

Definition 4.12: Let $\tilde{\alpha}_j = \langle (a_j, b_j, c_j); w_{\tilde{\alpha}_j}, u_{\tilde{\alpha}_j}, \gamma_{\tilde{\alpha}_j} \rangle$ and $\tilde{b}_j = \langle (d_j, e_j, f_j); w_{\tilde{b}_j}, u_{\tilde{b}_j}, \gamma_{\tilde{b}_j} \rangle$ be two generalized single valued triangular neutrosophic numbers and S_{TT}, A_{TT} be score and certainty functions according to truth value.

- i) If $S_{TT}(\tilde{\alpha}) > S_{TT}(\tilde{b})$, then $\tilde{\alpha}$ is greater than \tilde{b} and denoted by $\tilde{\alpha} > \tilde{b}$.
- ii) If $S_{TT}(\tilde{\alpha}) = S_{TT}(\tilde{b})$ and $A_{TT}(\tilde{\alpha}) > A_{TT}(\tilde{b})$, then $\tilde{\alpha}$ is greater than \tilde{b} and denoted by $\tilde{\alpha} > \tilde{b}$.
- iii) if $S_{TT}(\tilde{\alpha}) = S_{TT}(\tilde{b})$ and $A_{TT}(\tilde{\alpha}) = A_{TT}(\tilde{b})$, then $\tilde{\alpha}$ is equal to \tilde{b} and denoted by $\tilde{\alpha} = \tilde{b}$.

Example 4.13: Now let's compare the score and certainty function in definition 4.7 with the S_{TT}, A_{TT} score and certainty function according to the truth value, S_I, A_I score and certainty function in definition 4.8 according to the indeterminacy value and S_F, A_F score and certainty function in definition 4.9 according to the falsity value.

Let $\tilde{\alpha}_1 = (0.9, 0.4, 0.3)$, $\tilde{\alpha}_2 = (0.8, 0.4, 0.2)$ and $\tilde{\alpha}_3 = (0.7, 0.4, 0.1)$ be three single valued neutrosophic number.

i) For score and certainty functions in Definition 2.7;

$$ac(\tilde{\alpha}_1) = 2.2 \quad sc(\tilde{\alpha}_1) = 0.6$$

$$ac(\tilde{\alpha}_2) = 2.2 \quad sc(\tilde{\alpha}_2) = 0.6$$

$$ac(\tilde{\alpha}_2) = 2.2 \quad sc(\tilde{\alpha}_2) = 0.6 \quad \text{hence; } \tilde{\alpha}_1 = \tilde{\alpha}_2 = \tilde{\alpha}_3.$$

ii) For the score function according to the truth value in Definition 4.7;

$$S_T(\tilde{\alpha}_1) = 1.42 \quad S_T(\tilde{\alpha}_2) = 1.44 \quad S_T(\tilde{\alpha}_3) = 1.46 \quad \text{hence } \tilde{\alpha}_1 > \tilde{\alpha}_2 > \tilde{\alpha}_3$$

iii) For the score function according to the indeterminacy value in Definition 4.8;

$$S_I(\tilde{a}_1) = 0.51 \quad S_I(\tilde{a}_2) = 0.49 \quad S_I(\tilde{a}_3) = 0.47 \quad \text{hence } \tilde{a}_3 > \tilde{a}_2 > \tilde{a}_1.$$

iv) For the score function according to the falsity value in Definition 4.9;

$$S_F(\tilde{a}_1) = 0.51 \quad S_F(\tilde{a}_2) = 0.49 \quad S_F(\tilde{a}_3) = 0.47 \quad \text{hence } \tilde{a}_3 > \tilde{a}_2 > \tilde{a}_1.$$

Table 1: (Results of scoring functions for single valued triangular neutrosophic numbers)

The result of the score and certainty function in Definition 2.7	$\tilde{a}_1 = \tilde{a}_2 = \tilde{a}_3$
The result of the score function according to the truth value in definition 4.7	$\tilde{a}_1 > \tilde{a}_2 > \tilde{a}_3$
The result of the score function according to the indeterminacy value in definition 4.8	$\tilde{a}_3 > \tilde{a}_2 > \tilde{a}_1$
The result of the score function according to the falsity value in Definition 4.9	$\tilde{a}_3 > \tilde{a}_2 > \tilde{a}_1$

Example 4.14: Now let's compare the score and certainty function in definition 4.3 with the S_{TT} , score and certainty function in definition 2.1 according to the truth value, S_{TI} , A_{TI} score and certainty function according to the indeterminacy value and S_{TF} , A_{TF} score and certainty function according to the falsity value.

Let $\tilde{a}_1 = \langle (2,5,6); 0.9, 0.6, 0 \rangle$, $\tilde{a}_2 = \langle (3,4,6); 0.8, 0.5, 0 \rangle$ and $\tilde{a}_3 = \langle (1,5,7); 0.7, 0.4, 0 \rangle$ be three single valued triangular neutrosophic numbers.

i) For the score and certainty functions in Definition 2.11;

$$\begin{aligned} S(\tilde{a}_1) &= 3.73 & A(\tilde{a}_1) &= 3.73 \\ S(\tilde{a}_2) &= 3.73 & A(\tilde{a}_2) &= 3.73 \\ S(\tilde{a}_3) &= 3.73 & A(\tilde{a}_3) &= 3.73 \quad \text{hence } \tilde{a}_1 = \tilde{a}_2 = \tilde{a}_3. \end{aligned}$$

ii) For the score function according to the truth value in Definition 4.11;

$$S_{TT}(\tilde{a}_1) = 0,458 \quad S_{TT}(\tilde{a}_2) = 0,450 \quad S_{TT}(\tilde{a}_3) = 0,358 \quad \text{hence } \tilde{a}_3 > \tilde{a}_2 > \tilde{a}_1.$$

iii) For the score function according to the indeterminacy value in Definition 4.8;

$$S_{TI}(\tilde{a}_1) = 1,458 \quad S_{TI}(\tilde{a}_2) = 1,350 \quad S_{TI}(\tilde{a}_3) = 1,358 \quad \text{hence } \tilde{a}_2 > \tilde{a}_3 > \tilde{a}_1.$$

iv) For the score function according to the falsity value in Definition 4.9;

$$S_{TF}(\tilde{a}_1) = 1,458 \quad S_{TF}(\tilde{a}_2) = 1,350 \quad S_{TF}(\tilde{a}_3) = 1,358 \quad \text{hence } \tilde{a}_2 > \tilde{a}_3 > \tilde{a}_1.$$

Table 2: (Results of scoring functions for single valued triangular neutrosophic numbers)

The result of the score and certainty function in Definition 2.11	$\tilde{a}_1 = \tilde{a}_2 = \tilde{a}_3$
The result of score function according to the truth value in Definition 4.11	$\tilde{a}_3 > \tilde{a}_2 > \tilde{a}_1$
The result of score function according to the indeterminacy value in Definition 4.11	$\tilde{a}_2 > \tilde{a}_3 > \tilde{a}_1$
The result of score function according to the falsity value in Definition 4.11	$\tilde{a}_2 > \tilde{a}_3 > \tilde{a}_1$

5. SOME NEW GENERALIZED AGGREGATION OPERATORS BASED ON GENERALIZED SINGLE VALUED TRIANGULAR NEUTROSOPHIC NUMBERS FOR APPLICATION TO MULTI-ATTRIBUTE GROUP DECISION MAKING

In this section we have generalized some operators given for triangular intuitionistic fuzzy numbers in Definition 2.3 and Definition 2.4 for generalized single valued triangular neutrosophic numbers and showed some properties. We have shown that the new operators we have acquired include operators in definitions 2.13 and 2.14. Additionally, we showed the generalized single valued triangular neutrosophic numbers in this section.

Definition 5.1: Let $\tilde{a}_j = \langle (a_j, b_j, c_j); w_{\tilde{a}_j}, u_{\tilde{a}_j}, y_{\tilde{a}_j} \rangle$ ($j = 1, 2, 3, \dots, n$) be a collection of generalized single valued triangular neutrosophic numbers. Then generalized single valued triangular neutrosophic generalized weight averaging operator (SVTNGWAO) is defined as;

$$\text{GSVTNGWAO: } \bar{N}_R^n \rightarrow \bar{N}_R, \quad \text{GSVTNGWAO}(\tilde{a}_1, \tilde{a}_2, \dots, \tilde{a}_n) = g^{-1}(\sum_{j=1}^n w_j g(\tilde{a}_{(j)}))$$

where g is a continuous strictly monotone increasing function, $w = (w_1, w_2, \dots, w_n)^T$ is a weight vector associated with the GSVTNGWAO operator, with $w_j \geq 0$, $j = 1, 2, 3, \dots, n$ and $\sum_{j=1}^n w_j = 1$ ($j = 1, 2, 3, \dots, n$).

Theorem 5.2: Let $\tilde{a}_j = \langle (a_j, b_j, c_j); w_{\tilde{a}_j}, u_{\tilde{a}_j}, y_{\tilde{a}_j} \rangle$ ($j = 1, 2, 3, \dots, n$) be a collection of generalized single valued triangular neutrosophic numbers and $w = (w_1, w_2, \dots, w_n)^T$ is a weight vector associated with $w_j \geq 0$, and $\sum_{j=1}^n w_j = 1$. Then their aggregated value by using SVTNGWAO operator is also a neutrosophic number and

$$\begin{aligned} &\text{GSVTNGWAO}(\tilde{a}_1, \tilde{a}_2, \dots, \tilde{a}_n) \\ &= \\ &\langle [g^{-1}(\sum_{j=1}^n w_j g(a_{(j)})), g^{-1}(\sum_{j=1}^n w_j g(b_{(j)})), g^{-1}(\sum_{j=1}^n w_j g(c_{(j)}))]; \wedge_{j=1}^n w_{\tilde{a}_j} \vee_{j=1}^n u_{\tilde{a}_j} \vee_{j=1}^n y_{\tilde{a}_j} \rangle \end{aligned}$$

Where, g is a continuous strictly monotone increasing function.

Proof: We proof this by using the method of mathematical induction. For this;

i) For $n = 2$

$\tilde{a}_1 = \langle (a_1, b_1, c_1); w_{\tilde{a}_1}, u_{\tilde{a}_1}, y_{\tilde{a}_1} \rangle$ and $\tilde{a}_2 = \langle (a_2, b_2, c_2); w_{\tilde{a}_2}, u_{\tilde{a}_2}, y_{\tilde{a}_2} \rangle$ be two single valued triangular neutrosophic numbers by definition;

$$g^{-1}(w_1 g(\tilde{a}_1)) + g^{-1}(w_2 g(\tilde{a}_2)) =$$

$$\begin{aligned}
 &g^{-1}(w_1g(\langle (a_1, b_1, c_1); w_{\tilde{a}_1}, u_{\tilde{a}_1}, y_{\tilde{a}_1} \rangle)) + g^{-1}(w_2g(\langle (a_2, b_2, c_2); w_{\tilde{a}_2}, u_{\tilde{a}_2}, y_{\tilde{a}_2} \rangle)) \\
 &= g^{-1}(\langle (w_1g(a_1), w_1g(b_1), w_1g(c_1)); w_{\tilde{a}_1}, u_{\tilde{a}_1}, y_{\tilde{a}_1} \rangle) + \\
 &g^{-1}(\langle (w_2g(a_2), w_2g(b_2), w_2g(c_2)); w_{\tilde{a}_2}, u_{\tilde{a}_2}, y_{\tilde{a}_2} \rangle) \\
 &= g^{-1}(\langle (w_1g(a_1), w_1g(b_1), w_1g(c_1)); w_{\tilde{a}_1}, u_{\tilde{a}_1}, y_{\tilde{a}_1} \rangle) + \langle (w_2g(a_2), w_2g(b_2), w_2g(c_2)); w_{\tilde{a}_2}, u_{\tilde{a}_2}, y_{\tilde{a}_2} \rangle) \\
 &= \\
 &\langle [g^{-1}(\sum_{j=1}^2 w_jg(a_{(j)}), g^{-1}(\sum_{j=1}^2 w_jg(b_{(j)}), g^{-1}(\sum_{j=1}^2 w_jg(c_{(j)}))] ; \wedge_{j=1}^2 w_{\tilde{a}_j} \vee_{j=1}^2 u_{\tilde{a}_j} \vee_{j=1}^2 y_{\tilde{a}_j} \rangle \\
 &\text{it's true.}
 \end{aligned}$$

Let it be true for n = k that is we assumed

$$\begin{aligned}
 &g^{-1}(w_1g(\tilde{a}_1)) + g^{-1}(w_2g(\tilde{a}_2)) + \dots + g^{-1}(w_kg(\tilde{a}_k)) \\
 &= \\
 &\langle [g^{-1}(\sum_{j=1}^k w_jg(a_{(j)}), g^{-1}(\sum_{j=1}^k w_jg(b_{(j)}), g^{-1}(\sum_{j=1}^k w_jg(c_{(j)}))] ; \wedge_{j=1}^k w_{\tilde{a}_j} \vee_{j=1}^k u_{\tilde{a}_j} \vee_{j=1}^k y_{\tilde{a}_j} \rangle \\
 &\text{equation is true and let show that it is also true for n+1 .then}
 \end{aligned}$$

$$\begin{aligned}
 &g^{-1}(w_1g(\tilde{a}_1)) + g^{-1}(w_2g(\tilde{a}_2)) + \dots + g^{-1}(w_{k+1}g(\tilde{a}_{k+1})) \\
 &= \\
 &\langle [g^{-1}(\sum_{j=1}^k w_jg(a_{(j)}), g^{-1}(\sum_{j=1}^k w_jg(b_{(j)}), g^{-1}(\sum_{j=1}^k w_jg(c_{(j)}))] ; \wedge_{j=1}^k w_{\tilde{a}_j} \vee_{j=1}^k u_{\tilde{a}_j} \vee_{j=1}^k y_{\tilde{a}_j} \rangle \\
 &+ g^{-1}(\langle (w_{k+1}g(a_{k+1}), w_{k+1}g(b_{k+1}), w_{k+1}g(c_{k+1})); w_{\tilde{a}_{k+1}}, u_{\tilde{a}_{k+1}}, y_{\tilde{a}_{k+1}} \rangle) \\
 &= \\
 &\langle [g^{-1}(\sum_{j=1}^{k+1} w_jg(a_{(j)}), g^{-1}(\sum_{j=1}^{k+1} w_jg(b_{(j)}), g^{-1}(\sum_{j=1}^{k+1} w_jg(c_{(j)}))] ; \wedge_{j=1}^{k+1} w_{\tilde{a}_j} \vee_{j=1}^{k+1} u_{\tilde{a}_j} \vee_{j=1}^{k+1} y_{\tilde{a}_j} \rangle
 \end{aligned}$$

Hence the expression is true for n =k+1 as required.

As a result, the proof of the theorem is completed.

Lemma 5.3: Let $\tilde{a}_j = \langle (a_j, b_j, c_j); w_{\tilde{a}_j}, u_{\tilde{a}_j}, y_{\tilde{a}_j} \rangle$ and $\tilde{b}_j = \langle (d_j, e_j, f_j); w_{\tilde{b}_j}, u_{\tilde{b}_j}, y_{\tilde{b}_j} \rangle$ (j = 1, 2, 3, ...,n) be a collection of generalized single valued triangular neutrosophic numbers and $\tilde{a} = \langle (a, b, c); w_{\tilde{a}}, u_{\tilde{a}}, y_{\tilde{a}} \rangle$ be a generalized single valued triangular neutrosophic number. $w = (w_1, w_2, \dots, w_n)^T$ be a weight vector associated with $w_j \geq 0$, and $\sum_{j=1}^n w_j = 1$.

1) If $\tilde{a}_j = \tilde{a}$ (j = 1, 2, 3, ..., n), then $GSVTNGWAO(\tilde{a}_1, \tilde{a}_2, \dots, \tilde{a}_n) = \tilde{a}$

2) If $\tilde{a}_j^- = \langle (\min\{a_j\}, \min\{b_j\}, \min\{c_j\}); \min\{w_{\tilde{a}_j}\}, \max\{u_{\tilde{a}_j}\}, \max\{y_{\tilde{a}_j}\} \rangle$

$$\tilde{a}_j^+ = \langle (\max\{a_j\}, \max\{b_j\}, \max\{c_j\}); \max\{w_{\tilde{a}_j}\}, \min\{u_{\tilde{a}_j}\}, \min\{y_{\tilde{a}_j}\} \rangle$$

Then,

$$\tilde{a}_j^- \leq GSVTNGWAO(\tilde{a}_1, \tilde{a}_2, \dots, \tilde{a}_n) \leq \tilde{a}_j^+$$

3) If $a_j \leq d_j, b_j \leq e_j, c_j \leq f_j, w_{\tilde{a}_j} \leq w_{\tilde{b}_j}, u_{\tilde{a}_j} \geq u_{\tilde{b}_j}, y_{\tilde{a}_j} \geq y_{\tilde{b}_j}$ for all j then,

$$\text{GSVTNGWAO} (\tilde{a}_1, \tilde{a}_2, \dots, \tilde{a}_n) \leq \text{GSVTNGWAO} (\tilde{b}_1, \tilde{b}_2, \dots, \tilde{b}_n)$$

Proof:

1) From theorem 5.2 GSVTNGWAO $(\tilde{a}_1, \tilde{a}_2, \dots, \tilde{a}_n)$

$$= \langle [g^{-1}(\sum_{j=1}^n w_j g(a_{(j)})), g^{-1}(\sum_{j=1}^n w_j g(b_{(j)})), g^{-1}(\sum_{j=1}^n w_j g(c_{(j)}))] ; \bigwedge_{j=1}^n w_{\tilde{a}_j} \bigvee_{j=1}^n u_{\tilde{a}_j} \bigvee_{j=1}^n y_{\tilde{a}_j} \rangle$$

$$= \langle [g^{-1}(\sum_{j=1}^n w_j g(a)), g^{-1}(\sum_{j=1}^n w_j g(b)), g^{-1}(\sum_{j=1}^n w_j g(b))] ; \bigwedge_{j=1}^n w_{\tilde{a}} \bigvee_{j=1}^n w_{\tilde{a}} \bigvee_{j=1}^n w_{\tilde{a}} \rangle$$

$\sum_{j=1}^n w_j = 1$. Hence;

$$\text{GSVTNGWAO} (\tilde{a}_1, \tilde{a}_2, \dots, \tilde{a}_n) = \langle (g^{-1}(g(a)), g^{-1}(g(b)), g^{-1}(g(c))); w_{\tilde{a}}, u_{\tilde{a}}, y_{\tilde{a}} \rangle = \langle (a, b, c); w_{\tilde{a}}, u_{\tilde{a}}, y_{\tilde{a}} \rangle$$

The proof of 2) and 3) can easily be done from the proposition 4.6 given for the scoring function according to the center of the Hamming distance in the definition 5.1 and section 4.

Definition 5.4: Let $\tilde{\alpha}_j = \langle (a_j, b_j, c_j); w_{\tilde{\alpha}_j}, u_{\tilde{\alpha}_j}, y_{\tilde{\alpha}_j} \rangle$ ($j = 1, 2, 3, \dots, n$) be a collection of generalized single valued triangular neutrosophic numbers. Then generalized single valued triangular neutrosophic generalized ordered averaging operator (GSVTNGOAO) is defined as;

$$\text{GSVTNGOAO: } \bar{N}_R^n \rightarrow \bar{N}_R, \quad \text{GSVTNGOAO} (\tilde{a}_1, \tilde{a}_2, \dots, \tilde{a}_n) = g^{-1}(\sum_{j=1}^n w_j g(\tilde{b}_{(j)}))$$

where g is a continuous strictly monotone increasing function, $w = (w_1, w_2, \dots, w_n)^T$ is a weight vector associated with the GSVTNGOAO operator, with $w_j \geq 0$, $j = 1, 2, 3, \dots, n$ and $\sum_{j=1}^n w_j = 1$ ($j = 1, 2, 3, \dots, n$) and k is the largest generalized single valued triangular neutrosophic number obtained by using the new score function of $\tilde{b}_{(j)}$; $\tilde{\alpha}_j = \langle (a_j, b_j, c_j); w_{\tilde{\alpha}_j}, u_{\tilde{\alpha}_j}, y_{\tilde{\alpha}_j} \rangle$ for $k \in \{1, 2, 3, \dots, n\}$.

Theorem 5.5 Let $\tilde{\alpha}_j = \langle (a_j, b_j, c_j); w_{\tilde{\alpha}_j}, u_{\tilde{\alpha}_j}, y_{\tilde{\alpha}_j} \rangle$ ($j = 1, 2, 3, \dots, n$) be a collection of single valued triangular neutrosophic numbers and $w = (w_1, w_2, \dots, w_n)^T$ is a weight vector associated with $w_j \geq 0$, and $\sum_{j=1}^n w_j = 1$. Then their aggregated value by using GSVTNGOAO operator is also a neutrosophic number and

$$\text{GSVTNGOAO} (\tilde{a}_1, \tilde{a}_2, \dots, \tilde{a}_n)$$

$$= g^{-1}(\sum_{j=1}^n w_j g(\tilde{b}_{(j)})) =$$

$$\langle [g^{-1}(\sum_{j=1}^n w_j g(a_{(j)})), g^{-1}(\sum_{j=1}^n w_j g(b_{(j)})), g^{-1}(\sum_{j=1}^n w_j g(c_{(j)}))] ; \bigwedge_{j=1}^n w_{\tilde{a}_j} \bigvee_{j=1}^n u_{\tilde{a}_j} \bigvee_{j=1}^n y_{\tilde{a}_j} \rangle$$

where g is a continuous strictly monotone increasing function and k is the largest generalized single valued triangular neutrosophic number obtained by using the new score function of $\tilde{b}_{(j)}$; $\tilde{\alpha}_j = \langle (a_j, b_j, c_j); w_{\tilde{\alpha}_j}, u_{\tilde{\alpha}_j}, y_{\tilde{\alpha}_j} \rangle$ for $k \in \{1, 2, 3, \dots, n\}$.

Proof: Proof is made similar to Theorem 5.2 using Definition 5.4.

Lemma 5.6 Let $\tilde{a}_j = \langle (a_j, b_j, c_j); w_{\tilde{a}_j}, u_{\tilde{a}_j}, y_{\tilde{a}_j} \rangle$ and $\tilde{b}_2 = \langle (d_j, e_j, f_j); w_{\tilde{b}_j}, u_{\tilde{b}_j}, y_{\tilde{b}_j} \rangle$ ($j = 1, 2, 3, \dots, n$) be collections of generalized single valued triangular neutrosophic numbers and $\tilde{a} = \langle (a, b, c); w_{\tilde{a}}, u_{\tilde{a}}, y_{\tilde{a}} \rangle$ be a generalized single valued triangular neutrosophic number. $w = (w_1, w_2, \dots, w_n)^T$ be a weight vector associated with $w_j \geq 0$, and $\sum_{j=1}^n w_j = 1$.

1) If $\tilde{a}_j = \tilde{a}$ ($j = 1, 2, 3, \dots, n$), then $\text{GSVTNGOAO}(\tilde{a}_1, \tilde{a}_2, \dots, \tilde{a}_n) = \tilde{a}$

2) If $\tilde{a}_j^- = \langle (\min\{a_j\}, \min\{b_j\}, \min\{c_j\}); \min\{w_{\tilde{a}_j}\}, \max\{u_{\tilde{a}_j}\}, \max\{y_{\tilde{a}_j}\} \rangle$

$$\tilde{a}_j^+ = \langle (\max\{a_j\}, \max\{b_j\}, \max\{c_j\}); \max\{w_{\tilde{a}_j}\}, \min\{u_{\tilde{a}_j}\}, \min\{y_{\tilde{a}_j}\} \rangle$$

Then,

$$\tilde{a}_j^- \leq \text{GSVTNGOAO}(\tilde{a}_1, \tilde{a}_2, \dots, \tilde{a}_n) \leq \tilde{a}_j^+$$

3) If $a_j \leq d_j, b_j \leq e_j, c_j \leq f_j, w_{\tilde{a}_j} \leq w_{\tilde{b}_j}, u_{\tilde{a}_j} \geq u_{\tilde{b}_j}, y_{\tilde{a}_j} \geq y_{\tilde{b}_j}$ for all j then,

$$\text{GSVTNGOAO}(\tilde{a}_1, \tilde{a}_2, \dots, \tilde{a}_n) \leq \text{GSVTNGOAO}(\tilde{b}_1, \tilde{b}_2, \dots, \tilde{b}_n)$$

Proof:

The proof of 1) can be done similar to the proof of the theorem 5.3.

The proof of 2) and 3) can easily be done from proposition 4.6 given for the Hamming distance depending on the scoring function in the definition 5.4 and in the section 6.

Corollary 5.7: If $g(x) = x$ ($r = 1$) is taken in Definition 5.1, the operator in Definition 2.13 is obtained. Similarly, if $g(x) = x$ ($r = 1$) is taken in 5.2, the operator in Definition 2.14 is obtained.

Note 5.8: If $g(x) = x^r$ is taken in the operators in Definition 5.1 and Definition 5.2; r value should not be taken as an odd number. Indeterminacy emerges when any of the values a_j, b_j, c_j of a generalized single valued triangular neutrosophic number $\tilde{a}_j = \langle (a_j, b_j, c_j); w_{\tilde{a}_j}, u_{\tilde{a}_j}, y_{\tilde{a}_j} \rangle$ takes a negative real number value.

6. MULTI – ATTRIBUTE GROUP DECISION MAKING METHOD BASED ON THE SVTNGWAO OPERATOR

For a multi-attribute group decision making problem, let $E = \{e_1, e_2, \dots, e_n\}$ be a set of experts (or DMs), $A = \{A_1, A_2, \dots, A_m\}$ be set of alternatives, $X = \{x_1, x_2, \dots, x_p\}$ be set of attributes. Assume that the rating of alternative A_i on attribute x_j given by expert e_k is represented by single valued neutrosophic number $\tilde{a}_{ij}^k = (a_{ij}^k, b_{ij}^k, c_{ij}^k)$ ($i = 1, 2, \dots, m; j = 1, 2, \dots, p; k = 1, 2, \dots, n$). Additionally, let g be a continuous strictly monotone

increasing function. Now let's take the steps we will follow to solve the multi-attribute group decision making problem.

i) The decision matrices obtained by the decision makers are found as $\tilde{D}^k = (\tilde{a}_{ij}^k)_{m \times p}$ ($i = 1, 2, \dots, m; j = 1, 2, \dots, p; k = 1, 2, \dots, n$).

ii) \tilde{D}^k decision matrices; for \tilde{a}_{ij}^k single valued neutrosophic numbers, \tilde{D}^k_T matrices are formed that consist of \tilde{a}_{ij}^k converted single valued triangular neutrosophic numbers.

iii) Let $\omega = (\omega_1, \omega_2, \dots, \omega_n)^T$; be the weight vector of decision makers with $\omega_j \geq 0$, and $\sum_{j=1}^n \omega_j = 1$. Accordingly, the weighted decision matrix is $\tilde{D}^k_w = (\omega_k \tilde{a}_{ij}^k)_{m \times p}$ ($i = 1, 2, \dots, m; j = 1, 2, \dots, p; k = 1, 2, \dots, n$).

iv) GSVTNGWAO is the operator in the definition 5.1; the unified decision matrix $\tilde{D}_u = (\tilde{d}_{u,ij})_{m \times p}$ obtained from the weighted decision matrices. Here;

$$\tilde{d}_{u,i1} = \text{GSVTNGWAO}(\varphi_k \tilde{a}_{i1}^1, \varphi_k \tilde{a}_{i1}^2, \dots, \varphi_k \tilde{a}_{i1}^k),$$

$$\tilde{d}_{u,i2} = \text{GSVTNGWAO}(\varphi_k \tilde{a}_{i2}^1, \varphi_k \tilde{a}_{i2}^2, \dots, \varphi_k \tilde{a}_{i2}^k),$$

...

$$\tilde{d}_{u,ip} = \text{GSVTNGWAO}(\varphi_k \tilde{a}_{ip}^1, \varphi_k \tilde{a}_{ip}^2, \dots, \varphi_k \tilde{a}_{ip}^k). \text{ Where; } (i = 1, 2, 3, \dots, m).$$

Also here, the weight vector to be used for the GSVTNGWAO operator is $\varphi = (\varphi_1, \varphi_2, \dots, \varphi_n)^T$ with $\varphi_j \geq 0$, and $\sum_{j=1}^n \varphi_j = 1$.

v) $\tilde{D}_u = (\tilde{d}_{u,ij})_{m \times p}$ be the unified decision matrix; let $w = (w_1, w_2, \dots, w_p)^T$ weight vector of $\{x_1, x_2, \dots, x_p\}$ with $w_j \geq 0$, and $\sum_{j=1}^p w_j = 1$. single valued triangular neutrosophic numbers for the $\{A_1, A_2, \dots, A_m\}$ alternatives is ;

$$\tilde{A}_t = \text{GSVTNGWAO}_t(\tilde{d}_{u,t1}, \tilde{d}_{u,t2}, \dots, \tilde{d}_{u,tp}) \text{ (} t = 1, 2, \dots, m \text{)}.$$

vi) Single valued triangular neutrosophic numbers \tilde{A}_t ($t = 1, 2, \dots, m$) for the $\{A_1, A_2, \dots, A_m\}$ alternatives are compared with one of the new score functions in definition 4.7, definition 4.8 or definition 4.9, and the best alternative is found. Here; there is a score function according to the truth value in definition 4.7, according to the indeterminacy value in definition 4.8 and according to the falsity value in definition 4.9.

Corollary 6.1: In this method for single valued neutrosophic numbers, starting directly from the second step, single valued triangular neutrosophic numbers can be taken and processed. Thus the method we have obtained can be used for single valued triangular neutrosophic numbers or generalized single valued triangular neutrosophic numbers.

Example 6.2: A pharmaceutical company wants to choose the most appropriate diabetes drug from four alternatives $\{A_1, A_2, A_3, A_4\}$. For this, a decision committee of three pharmacological specialists $\{e_1, e_2, e_3\}$ was established. This decision commission will review alternative medicines in three qualities. These qualities are; the dose rate of the drug is x_1 , suitable for all ages x_2 and its cost is x_3 . For the decision committee $\{e_1, e_2, e_3\}$ weight vector $\omega = (0.4, 0.3, 0.3)^T$, (x_1, x_2, x_3) . Weight vector for qualities are $w = (0.4, 0.3, 0.3)^T$ and $\varphi = (\frac{1}{3}, \frac{1}{3}, \frac{1}{3})$. Additionally, let $g(x) = x^r$ is a continuous strictly monotone increasing function. Now let $g(x) = x$ for $r = 1$ and then perform the steps in section 5.1 according to the truth value of the transformations and scoring function.

i) The table showing single valued neutrosophic numbers for the alternatives evaluated by the decision makers is as follows.

Table 3: (Decision matrix created by e_1 decision maker)

	u_1	u_2	u_3
x_1	(0.8,0.5,0.3)	(0.3,0.8,0.6)	(0.8,0.1,0.3)
x_2	(0.3,0.4,0.5)	(0.8,0.2,0.3)	(0.6,0.2,0.3)
x_3	(0.7,0.2,0.3)	(0.6,0.1,0.3)	(0.4,0.2,0.6)
x_4	(0.4,0.5,0.3)	(0.9,0.1,0.1)	(0.8,0.4,0.1)
x_5	(0.4,0.3,0.2)	(0.7,0.1,0.3)	(0.9,0.1,0.0)

Table 4: (decision matrix created by e_2 decision maker)

	u_1	u_2	u_3
x_1	(0.6,0.3,0.3)	(0.5,0.3,0.3)	(0.7,0.2,0.3)
x_2	(0.6,0.2,0.3)	(0.6,0.3,0.2)	(0.4,0.3,0.4)
x_3	(0.8,0.2,0.1)	(0.6,0.2,0.2)	(0.5,0.3,0.3)
x_4	(0.6,0.2,0.2)	(0.7,0.3,0.1)	(0.8,0.2,0.2)
x_5	(0.7,0.2,0.2)	(0.8,0.1,0.2)	(0.7,0.3,0.1)

Table 5: (decision matrix created by e_3 decision maker)

	u_1	u_2	u_3
x_1	(0.7,0.2,0.2)	(0.7,0.2,0.2)	(0.9,0.1,0.1)
x_2	(0.7,0.2,0.3)	(0.7,0.1,0.2)	(0.5,0.3,0.2)
x_3	(0.7,0.1,0.3)	(0.5,0.3,0.3)	(0.6,0.2,0.3)
x_4	(0.5,0.1,0.3)	(0.8,0.1,0.2)	(0.9,0.1,0.2)
x_5	(0.8,0.1,0.1)	(0.6,0.3,0.2)	(0.8,0.2,0.1)

ii) Transformed decision-making matrices created by decision makers;

Table 6: (transformed decision matrix created by e_1 decision maker)

	u_1	u_2	u_3
x_1	$\langle\langle 0.0, 1.5, 2.8 \rangle\rangle; 0.8, 0.5, 0.3$	$\langle\langle -1.1, -0.4, 0.1 \rangle\rangle; 0.3, 0.8, 0.6$	$\langle\langle 0.4, 1.9, 3.6 \rangle\rangle; 0.8, 0.1, 0.3$
x_2	$\langle\langle -0.6, 0.2, 1.1 \rangle\rangle; 0.3, 0.4, 0.5$	$\langle\langle 0.3, 1.8, 3.4 \rangle\rangle; 0.8, 0.2, 0.3$	$\langle\langle 0.1, 1.4, 2.8 \rangle\rangle; 0.6, 0.2, 0.3$
x_3	$\langle\langle 0.2, 1.6, 3.1 \rangle\rangle; 0.7, 0.2, 0.3$	$\langle\langle 0.2, 1.5, 3.0 \rangle\rangle; 0.6, 0.1, 0.3$	$\langle\langle -0.4, 0.4, 1.6 \rangle\rangle; 0.4, 0.2, 0.6$
x_4	$\langle\langle -0.4, 0.7, 1.6 \rangle\rangle; 0.4, 0.5, 0.3$	$\langle\langle 0.7, 2.5, 4.3 \rangle\rangle; 0.9, 0.1, 0.1$	$\langle\langle 0.3, 2.0, 3.4 \rangle\rangle; 0.8, 0.4, 0.1$
x_5	$\langle\langle -0.1, 1.1, 2.2 \rangle\rangle; 0.4, 0.3, 0.2$	$\langle\langle 0.3, 1.7, 3.3 \rangle\rangle; 0.7, 0.1, 0.3$	$\langle\langle 0.8, 2.7, 4.5 \rangle\rangle; 0.9, 0.1, 0.0$

Table 7: (transformed decision matrix created by e_2 decision maker)

	u_1	u_2	u_3
x_1	$\langle\langle 0.0, 1.3, 2.6 \rangle\rangle; 0.6, 0.3, 0.3$	$\langle\langle -0.1, 1.1, 2.3 \rangle\rangle; 0.5, 0.3, 0.3$	$\langle\langle 0.2, 1.6, 3.1 \rangle\rangle; 0.7, 0.2, 0.3$
x_2	$\langle\langle 0.1, 1.4, 2.8 \rangle\rangle; 0.6, 0.2, 0.3$	$\langle\langle 0.1, 1.5, 2.8 \rangle\rangle; 0.6, 0.3, 0.2$	$\langle\langle -0.3, 0.7, 1.8 \rangle\rangle; 0.4, 0.3, 0.4$
x_3	$\langle\langle 0.5, 2.2, 3.8 \rangle\rangle; 0.8, 0.2, 0.1$	$\langle\langle 0.2, 1.6, 3.0 \rangle\rangle; 0.6, 0.2, 0.2$	$\langle\langle -0.1, 1.1, 2.3 \rangle\rangle; 0.5, 0.3, 0.3$
x_4	$\langle\langle 0.2, 1.6, 3.0 \rangle\rangle; 0.6, 0.2, 0.2$	$\langle\langle 0.3, 1.9, 3.3 \rangle\rangle; 0.7, 0.3, 0.1$	$\langle\langle 0.4, 2.0, 3.6 \rangle\rangle; 0.8, 0.2, 0.2$
x_5	$\langle\langle 0.3, 1.8, 3.3 \rangle\rangle; 0.7, 0.2, 0.2$	$\langle\langle 0.5, 2.1, 3.8 \rangle\rangle; 0.8, 0.1, 0.2$	$\langle\langle 0.3, 1.9, 3.3 \rangle\rangle; 0.7, 0.3, 0.1$

Table 8: (transformed decision matrix created by e_3 decision maker)

	u_1	u_2	u_3
x_1	$\langle(0.3,1.8,3.3); 0.7,0.2,0.2\rangle$	$\langle(0.3,1.8,3.3); 0.7,0.2,0.2\rangle$	$\langle(0.7,2.5,4.3); 0.9,0.1,0.1\rangle$
x_2	$\langle(0.2,1.6,3.1); 0.7,0.2,0.3\rangle$	$\langle(0.4,1.9,3.5); 0.7,0.1,0.2\rangle$	$\langle(0.0,1.3,2.5); 0.5,0.3,0.2\rangle$
x_3	$\langle(0.3,1.7,3.3); 0.7,0.1,0.3\rangle$	$\langle(-0.1,1.1,2.3); 0.5,0.3,0.3\rangle$	$\langle(0.1,1.4,2.8); 0.6,0.2,0.3\rangle$
x_4	$\langle(0.1,1.3,2.7); 0.5,0.1,0.3\rangle$	$\langle(0.5,2.1,3.8); 0.8,0.1,0.2\rangle$	$\langle(0.6,2.3,4.1); 0.9,0.1,0.2\rangle$
x_5	$\langle(0.6,2.3,4.0); 0.8,0.1,0.1\rangle$	$\langle(0.1,1.5,2.8); 0.6,0.3,0.2\rangle$	$\langle(0.5,2.2,3.8); 0.8,0.2,0.1\rangle$

iii) Transformed weighted decision matrices generated by decision makers;

Table 9: (transformed weighted decision matrix created by e_1 decision maker)

	u_1	u_2	u_3
x_1	$\langle(0.00,0.60,1.12); 0.8,0.5,0.3\rangle$	$\langle(-0.44, -0.16,0.04); 0.3,0.8,0.6\rangle$	$\langle(0.16,0.76,1.44); 0.8,0.1,0.3\rangle$
x_2	$\langle(-0.24,0.08,0.44); 0.3,0.4,0.5\rangle$	$\langle(0.12,0.72,1.36); 0.8,0.2,0.3\rangle$	$\langle(0.04,0.56,1.12); 0.6,0.2,0.3\rangle$
x_3	$\langle(0.08,0.64,1.24); 0.7,0.2,0.3\rangle$	$\langle(0.08,0.60,1.20); 0.6,0.1,0.3\rangle$	$\langle(-0.16,0.16,0.64); 0.4,0.2,0.6\rangle$
x_4	$\langle(-0.16,0.28,0.64); 0.4,0.5,0.3\rangle$	$\langle(0.28,1.00,1.72); 0.9,0.1,0.1\rangle$	$\langle(0.12,0.80,1.36); 0.8,0.4,0.1\rangle$
x_5	$\langle(-0.04,0.44,0.88); 0.4,0.3,0.2\rangle$	$\langle(0.12,0.68,1.32); 0.7,0.1,0.3\rangle$	$\langle(0.32,1.08,1.80); 0.9,0.1,0.0\rangle$

Table 10: (transformed weighted decision matrix created by e_2 decision maker)

	u_1	u_2	u_3
x_1	$\langle(0.00,0.39,0.78); 0.6,0.3,0.3\rangle$	$\langle(-0.03,0.33,0.69); 0.5,0.3,0.3\rangle$	$\langle(0.06,0.48,0.93); 0.7,0.2,0.3\rangle$
x_2	$\langle(0.03,0.42,0.84); 0.6,0.2,0.3\rangle$	$\langle(0.03,0.45,0.84); 0.6,0.3,0.2\rangle$	$\langle(-0.09,0.21,0.54); 0.4,0.3,0.4\rangle$
x_3	$\langle(0.15,0.66,1.14); 0.8,0.2,0.1\rangle$	$\langle(0.06,0.48,0.90); 0.6,0.2,0.2\rangle$	$\langle(-0.03,0.33,0.69); 0.5,0.3,0.3\rangle$
x_4	$\langle(0.06,0.48,0.90); 0.6,0.2,0.2\rangle$	$\langle(0.09,0.57,0.99); 0.7,0.3,0.1\rangle$	$\langle(0.12,0.60,1.08); 0.8,0.2,0.2\rangle$
x_5	$\langle(0.09,0.54,0.99); 0.7,0.2,0.2\rangle$	$\langle(0.15,0.63,1.14); 0.8,0.1,0.2\rangle$	$\langle(0.09,0.57,0.99); 0.7,0.3,0.1\rangle$

Table 11: (transformed weighted decision matrix created by e_3 decision maker)

	u_1	u_2	u_3
x_1	$\langle\langle(0.09,0.54,0.99); 0.7,0.2,0.2\rangle\rangle$	$\langle\langle(0.09,0.54,0.99); 0.7,0.2,0.2\rangle\rangle$	$\langle\langle(0.21,0.75,1.29); 0.9,0.1,0.1\rangle\rangle$
x_2	$\langle\langle(0.06,0.48,0.93); 0.7,0.2,0.3\rangle\rangle$	$\langle\langle(0.12,0.57,1.05); 0.7,0.1,0.2\rangle\rangle$	$\langle\langle(0.00,0.39,0.75); 0.5,0.3,0.2\rangle\rangle$
x_3	$\langle\langle(0.09,0.51,0.99); 0.7,0.1, .0.3\rangle\rangle$	$\langle\langle(-0.03,0.33,0.69); 0.5, ,0.3,0.3\rangle\rangle$	$\langle\langle(0.03,0.42,0.84); 0.6,0.2,0.3\rangle\rangle$
x_4	$\langle\langle(0.03,0.39,0.81); 0.5,0.1,0.3\rangle\rangle$	$\langle\langle(0.15,0.63,1.14); 0.8,0.1,0.2\rangle\rangle$	$\langle\langle(0.18,0.69,1.23); 0.9,0.1,0.2\rangle\rangle$
x_5	$\langle\langle(0.18,0.69,1.20); 0.8,0.1,0.1\rangle\rangle$	$\langle\langle(0.03,0.45,0.84); 0.6,0.3,0.2\rangle\rangle$	$\langle\langle(0.15,0.66,1.14); 0.8,0.2,0.1\rangle\rangle$

iv)The resulting unified decision matrix;

Table 12: (unified decision matrix)

	u_1	u_2	u_3
x_1	$\langle\langle(0.027,0.459,0.867); 0.6,0.5,0.3\rangle\rangle$	$\langle\langle(-0.144,0.213,0.516); 0.3,0.8,0.6\rangle\rangle$	$\langle\langle(0.129,0.597,1.98); 0.7,0.2,0.3\rangle\rangle$
x_2	$\langle\langle(-0.045,0.294,0.663); 0.3,0.4,0.5\rangle\rangle$	$\langle\langle(0.081,0.522,0.975); 0.6,0.3,0.3\rangle\rangle$	$\langle\langle(-0.015,0.348,0.723); 0.4,0.3,0.4\rangle\rangle$
x_3	$\langle\langle(0.096,0.543,1.011); 0.7,0.2,0.3\rangle\rangle$	$\langle\langle(0.033,0.423,0.837); 0.5,0.3,0.3\rangle\rangle$	$\langle\langle(-0.048,0.273,0.651); 0.4,0.3,0.6\rangle\rangle$
x_4	$\langle\langle(-0.021,0.345,0.705); 0.4,0.5,0.3\rangle\rangle$	$\langle\langle(0.156,0.660,1.155); 0.7,0.3,0.2\rangle\rangle$	$\langle\langle(0.126,0.627,1.101); 0.8,0.4,0.2\rangle\rangle$
x_5	$\langle\langle(0.069,0.501,0.921); 0.4,0.3,0.2\rangle\rangle$	$\langle\langle(0.009,0.528,0.990); 0.6,0.3,0.3\rangle\rangle$	$\langle\langle(0.168,0.693,1.179); 0.7,0.3,0.1\rangle\rangle$

v) Generalized single valued triangular neutrosophic numbers obtained from the unified decision matrix for the alternatives;

$$\widetilde{A}_1 = \text{GSVTNGWAO}_{x_1}(u_1, u_2, u_3) = \langle\langle(0.015,0.426,0.831); 0.3,0.8,0.6\rangle\rangle$$

$$\widetilde{A}_2 = \text{GSVTNGWAO}_{x_2}(u_1, u_2, u_3) = \langle\langle(0.001,0.378, ,0.774); 0.3,0.4,0.5\rangle\rangle$$

$$\widetilde{A}_3 = \text{GSVTNGWAO}_{x_3}(u_1, u_2, u_3) = \langle\langle(0.033,0.426,0.850); 0.4,0.3,0.6\rangle\rangle$$

$$\widetilde{A}_4 = \text{GSVTNGWAO}_{x_4}(u_1, u_2, u_3) = \langle\langle(0.076,0.524,0.958); 0.4,0.5,0.3\rangle\rangle$$

$$\widetilde{A}_5 = \text{GSVTNGWAO}_{x_5}(u_1, u_2, u_3) = \langle\langle(0.105,0.566,1.019); 0.4,0.3,0.3\rangle\rangle$$

vi) According to the values in v);

$$S_T(\widetilde{A}_1) = 2,15$$

$$S_T(\widetilde{A}_2) = 2,11$$

$$S_T(\widetilde{A}_3) = 2,08$$

$$S_T(\widetilde{A}_4) = 2,04$$

$$S_T(\widetilde{A}_5) = 1,99$$

Hence $x_1 < x_2 < x_3 < x_4 < x_5$. So the best alternative drug is x_5 .

If $g(x) = x^2$ is taken in example 6.2 for $r = 2$;

$$S_T(\widetilde{A}_1) = 2,12$$

$$S_T(\widetilde{A}_2) = 2,08$$

$$S_T(\widetilde{A}_3) = 2,06$$

$$S_T(\widetilde{A}_4) = 2,01$$

$$S_T(\widetilde{A}_5) = 1,97$$

Hence, $x_1 < x_2 < x_3 < x_4 < x_5$. So the best alternative drug is x_5 .

If $g(x) = x^5$ is taken in example 6.2 for $r = 5$;

$$S_T(\widetilde{A}_1) = 2,14$$

$$S_T(\widetilde{A}_2) = 2,09$$

$$S_T(\widetilde{A}_3) = 2,04$$

$$S_T(\widetilde{A}_4) = 1,97$$

$$S_T(\widetilde{A}_5) = 1,92$$

Hence, $x_1 < x_2 < x_3 < x_4 < x_5$. So the best alternative drug is x_5 .

If $g(x) = x^{0.04}$ is taken in example 6.2 for $r = 0.04$;

$$S_T(\widetilde{A}_1) = 2,246$$

$$S_T(\widetilde{A}_2) = 2,240$$

$$S_T(\widetilde{A}_3) = 2,237$$

$$S_T(\widetilde{A}_4) = 2,234$$

$$S_T(\widetilde{A}_5) = 2,231$$

Hence, $x_1 < x_2 < x_3 < x_4 < x_5$. So the best alternative drug is x_5 .

Example 6.3: If the same assumption in Example 6.2 applies to decision making based on indeterminacy;
i) If $g(x) = x$ is taken for $r = 1$;

$$S_I(\widetilde{A}_1) = 1,185$$

$$S_I(\widetilde{A}_2) = 1,160$$

$$S_I(\widetilde{A}_3) = 1,148$$

$$S_I(\widetilde{A}_4) = 1,113$$

$$S_I(\widetilde{A}_5) = 1,087$$

Hence, $x_1 < x_2 < x_3 < x_4 < x_5$. So the best alternative drug is x_5 .

ii) If $g(x) = x^2$ is taken for $r = 2$;

$$S_I(\widetilde{A}_1) = 1,169$$

$$S_I(\widetilde{A}_2) = 1,140$$

$$S_I(\widetilde{A}_3) = 1,133$$

$$S_I(\widetilde{A}_4) = 1,094$$

$$S_I(\widetilde{A}_5) = 1,071$$

Hence, $x_1 < x_2 < x_3 < x_4 < x_5$. So the best alternative drug is x_5 .

iii) If $g(x) = x^5$ is taken for $r = 5$;

$$S_I(\widetilde{A}_1) = 1,195$$

$$S_I(\widetilde{A}_2) = 1,163$$

$$S_I(\widetilde{A}_3) = 1,127$$

$$S_I(\widetilde{A}_4) = 1,072$$

$$S_I(\widetilde{A}_5) = 1,045$$

Hence, $x_1 < x_2 < x_3 < x_4 < x_5$. So the best alternative drug is x_5 .

iv) If $g(x) = x^{0.04}$ is taken for $r = 0.04$;

$$S_I(\widetilde{A}_1) = 1,245$$

$$S_I(\widetilde{A}_2) = 1,243$$

$$S_I(\widetilde{A}_3) = 1,242$$

$$S_I(\widetilde{A}_4) = 1,241$$

$$S_I(\widetilde{A}_5) = 1,238$$

Hence, $x_1 < x_2 < x_3 < x_4 < x_5$. So the best alternative drug is x_5 .

Example 6.4: If the same assumption in Example 6.2 applies to decision making based on falsity;

i) If $g(x) = x$ is taken for $r = 1$;

$$S_F(\widetilde{A}_1) = 1,173$$

$$S_F(\widetilde{A}_2) = 1,127$$

$$S_F(\widetilde{A}_3) = 1,104$$

$$S_F(\widetilde{A}_4) = 1,094$$

$$S_F(\widetilde{A}_5) = 1,063$$

Hence, $x_1 < x_2 < x_3 < x_4 < x_5$. So the best alternative drug is x_5 .

ii) If $g(x) = x^2$ is taken for $r = 2$;

$$S_F(\widetilde{A}_1) = 1,154$$

$$S_F(\widetilde{A}_2) = 1,106$$

$$S_F(\widetilde{A}_3) = 1,087$$

$$S_F(\widetilde{A}_4) = 1,073$$

$$S_F(\widetilde{A}_5) = 1,046$$

Hence, $x_1 < x_2 < x_3 < x_4 < x_5$. So the best alternative drug is x_5 .

iii) If $g(x) = x^5$ is taken for $r = 5$;

$$S_F(\widetilde{A}_1) = 1,179$$

$$S_F(\widetilde{A}_2) = 1,129$$

$$S_F(\widetilde{A}_3) = 1,076$$

$$S_F(\widetilde{A}_4) = 1,055$$

$$S_F(\widetilde{A}_5) = 1,027$$

Hence, $x_1 < x_2 < x_3 < x_4 < x_5$. So the best alternative drug is x_5 .

iv) If $g(x) = x^{0.04}$ is taken for $r = 0.04$;

$$S_F(\widetilde{A}_1) = 1,246$$

$$S_F(\widetilde{A}_2) = 1,240$$

$$S_F(\widetilde{A}_3) = 1,238$$

$$S_F(\widetilde{A}_4) = 1,239$$

$S_F(\widetilde{A}_5) = 1,236$ hence $x_1 < x_2 < x_4 < x_3 < x_5$. So the best alternative drug is x_5 .

Table 13: (Results obtained according to r in Example 6.2, example6.3 and example 6.4)

Value of R	The result according to the value of truth	The result according to the value of indeterminacy	The result according to the value of falsity
r=1	$x_1 < x_2 < x_3 < x_4 < x_5$	$x_1 < x_2 < x_3 < x_4 < x_5$	$x_1 < x_2 < x_3 < x_4 < x_5$
r=2	$x_1 < x_2 < x_3 < x_4 < x_5$	$x_1 < x_2 < x_3 < x_4 < x_5$	$x_1 < x_2 < x_3 < x_4 < x_5$
r=5	$x_1 < x_2 < x_3 < x_4 < x_5$	$x_1 < x_2 < x_3 < x_4 < x_5$	$x_1 < x_2 < x_3 < x_4 < x_5$
r=0.04	$x_1 < x_2 < x_3 < x_4 < x_5$	$x_1 < x_2 < x_3 < x_4 < x_5$	$x_1 < x_2 < x_4 < x_3 < x_5$

7. COMPARISON ANALYSIS AND DISCUSSION

Table 14: (Results obtained from methods)

	r=1	r=2	r=5
Method 1	$x_1 < x_2 < x_3 < x_4$	$x_2 < x_1 < x_3 < x_4$	$x_1 < x_2 < x_3 < x_4$
Method 2	$x_2 < x_1 < x_3 < x_4$	$x_2 < x_1 < x_3 < x_4$	$x_2 < x_1 < x_3 < x_4$
Method 3	$x_3 < x_1 < x_2 < x_4$	$x_3 < x_2 < x_1 < x_4$	$x_1 < x_3 < x_2 < x_4$
Method 4	$x_1 < x_2 < x_3 < x_4$	$x_1 < x_2 < x_3 < x_4$	$x_1 < x_2 < x_3 < x_4$

To be able to see the effect of the method given in section 6; we compared the results of the method with those of the method in Section 6. For the same "r" values were comparable a method obtained according to the truth value, indeterminacy value and falsity value in section 6. According to Table 14; the best alternative to the results from all methods is the same and it is x_4 . Besides; Hamacher aggregation operators are used for single valued neutrosophic numbers. In the chapter 5, we used generalized single valued triangular neutrosophic numbers obtained by transformed single valued neutrosophic numbers. With these numbers, we used the

operators we have generalized to the operators given for intuitionistic fuzzy numbers. These operators include previously given operators for single valued triangular neutrosophic numbers. Thus, in section 6 we used single valued triangular neutrosophic numbers and more general operators used in many decision making methods. We also compared the score and certainty functions used in Table 1 and used in Section 6. In this comparison, the values are not equal according to the scoring functions in Section 6 and therefore we have achieved different results. In addition, we have the possibility to obtain separate results according to the value of truth, falsity and indeterminacy in order to decide on the method in section 6. Thus, we have obtained a more comprehensive result. For this reason, the method in section 6 is effective and applicable.

8. CONCLUSION

In this study, we generalized single valued triangular neutrosophic numbers. Thus, we have defined a new set of numbers that can be more useful and can be very applicable. We have also obtained generalized single valued triangular neutrosophic numbers by converting single valued neutrosophic numbers according to their truth, indeterminacy and falsity values separately. Thus, single valued neutrosophic numbers are transformed into generalized single valued triangular neutrosophic numbers, which are a special case and have a lot of application field. We then defined the Hamming distance for single valued triangular neutrosophic numbers and gave some properties. We have defined the scoring and certainty functions based on this defined distance. We also extended operators for intuitionistic fuzzy numbers to single valued triangular neutrosophic numbers. Finally, we compared multi-attribute group decision making with generalized operators and new score functions, and compared the results with a previous multi-attribute group decision making application. In addition to this, the applied multi-attribute group decision making method can be used in many different scientific researches.

REFERENCES

- Atanassov, K. (1986). Intuitionistic fuzzy sets, *Fuzzy Sets Systems*, 20, 87–96
- Biswas, P., Pramanik, S. & Giri, B., C. (2016). Value and ambiguity index based ranking method of single-valued trapezoidal neutrosophic numbers and its application to multi-attribute decision making, *Neutrosophic Sets System*, 12, 127–138
- Biswas, P., Pramanik, S., & Giri, B.C. (2016). Cosine similarity measure based multi-attribute decision-making with trapezoidal fuzzy neutrosophic numbers, *Neutrosophic Sets System*, 8, 47–57
- Biswas, P., Pramanik, S., & Giri, B.C. (2016). Aggregation of triangular fuzzy neutrosophic set information and its application to multi-attribute decision making, *Neutrosophic Sets System*, 12, 20–40
- Liu, P. & Li, H. (2017). Multi attribute decision-making method based on some normal neutrosophic Bonferroni mean operators, *Neural Computing and Applications*, 28, 1, 179-194, DOI 10.1007/s00521-015-2048-z
- Liu, C. & Luo, Y. (2017). Power aggregation operators of simplifield neutrosophic sets and their use in multi-attribute group decision making, *IEE/CAA Journal of Automatica Sinica*, 99, DOI: 10.1109/JAS.2017.7510424
- Liu, P., Chu, Y., Li, Y. & Chen, Y. (2014). Some generalized neutrosophic number Hamacher aggregation operators and their application to group decision making, *International Journal of fuzzy systems*, 16, 2
- Li, D., F. (2010). A ratio ranking method of triangular intuitionistic fuzzy numbers and its application to MADM problems, *Computer and Mathematics with applications*, 60, 1557-1570.
- Şahin M., Ecemiş O., Uluçay V., & Kargin, A. (2017). Some new generalized aggregation operators based on centroid single valued triangular neutrosophic numbers and their applications in multi-attribute decision making,
- Sahin, R. & Liu, P. (2017). Some approaches to multi criteria decision making based on exponential operations of simplified neutrosophic numbers, *Journal of Intelligent & Fuzzy Systems*, 32, 3, 2083-2099, DOI: 10.3233/JIFS-161695
- Smarandache, F. (1998). *A unifying field in logics, neutrosophy: neutrosophic probability, set and logic*, Rehoboth, American Research Press
- Smarandache F. (2006). *Neutrosophic set, a generalization of the intuitionistic fuzzy set*, In 2006 IEEE international conference on granular computing, 38-42, DOI: 10.1109/GRC.2006.1635754.

- Abdel-Basset, M., Mohamed, M., Smarandache, F., & Chang, V. (2018). Neutrosophic Association Rule Mining Algorithm for Big Data Analysis. *Symmetry*, 10(4), 106.
- Abdel-Basset, M., & Mohamed, M. (2018). The Role of Single Valued Neutrosophic Sets and Rough Sets in Smart City: Imperfect and Incomplete Information Systems. Measurement. Volume 124, August 2018, Pages 47-55
- Abdel-Basset, M., Gunasekaran, M., Mohamed, M., & Smarandache, F. A novel method for solving the fully neutrosophic linear programming problems. *Neural Computing and Applications*, 1-11.
- Abdel-Basset, M., Manogaran, G., Gamal, A., & Smarandache, F. (2018). A hybrid approach of neutrosophic sets and DEMATEL method for developing supplier selection criteria. *Design Automation for Embedded Systems*, 1-22.
- Abdel-Basset, M., Mohamed, M., & Chang, V. (2018). NMCDA: A framework for evaluating cloud computing services. *Future Generation Computer Systems*, 86, 12-29.
- Abdel-Basset, M., Mohamed, M., Zhou, Y., & Hezam, I. (2017). Multi-criteria group decision making based on neutrosophic analytic hierarchy process. *Journal of Intelligent & Fuzzy Systems*, 33(6), 4055-4066.
- Abdel-Basset, M.; Mohamed, M.; Smarandache, F. An Extension of Neutrosophic AHP–SWOT Analysis for Strategic Planning and Decision-Making. *Symmetry* 2018, 10, 116.
- Smarandache, F. (1998). Neutrosophy: neutrosophic probability, set, and logic, *ProQuest Information & Learning*, Ann Arbor, Michigan, USA, 105; <http://fs.gallup.unm.edu/eBook-neutrosophics6.pdf> (online edition); reviewed in Zentralblatt fuer Mathematik (Berlin, Germany): <https://zbmath.org/?q=an:01273000>
- Smarandache F. (2016). Neutrosophic overset, neutrosophic underset, and neutrosophic offset, *Similarly for Neutrosophic Over-/Under-/Off- Logic, Probability, and Statistics*, 168, Pons Editions, Brussels, Belgium, , on Cornell University's website: <https://arxiv.org/ftp/arxiv/papers/1607/1607.00234.pdf> and in France at the international scientific database: <https://hal.archives-ouvertes.fr/hal-01340830>
- Subas, Y. (2015). *Neutrosophic Numbers and their application to Multi attribute decision making problems* Unpublished doctoral dissertation or master's theses, Kilis 7 Aralık University, Graduate School of Natural and Applied Science, Turkey
- Wang, H., Smarandache, F., Zhang, Y., Q. & Sunderraman, R. (2010). Single valued neutrosophic sets. *Multispace Multistructure*, 4, 410–413.
- Wan S. P. & Dong J. Y. (2015). Power geometric operators of trapezoidal intuitionistic fuzzy numbers and application to multi attribute group decision making, *Applied Soft Computing*, 29, 153-168.
- Wan, S., P., Wang, F., Li, L. & Dong., J., Y. (2016). Some generalized aggregation operators for triangular intuitionistic fuzzy numbers and application to multi attribute group decision making, *Computer & Industrial Engineering*, 286-301.
- Ye, J. (2015). Trapezoidal neutrosophic set and its application to multiple attribute decision-making. *Neural Computing and Applications*, doi: 10.1007/s00521-014-1787-6
- Zadeh, L., A. (1965). Fuzzy sets, *Information and Control*, 8, 338–353

Some weighted arithmetic operators and geometric operators with SVN_Ss and their application to multi-criteria decision making problems

Mehmet Şahin, Vakkas Uluçay*, and Hatice Acioğlu

Department of Mathematics, Gaziantep University, Gaziantep27310-Turkey
E-mail: mesahin@gantep.edu.tr, vuluçay27@gmail.com, haticeacioğlu@gmail.com

ABSTRACT

As a variation of fuzzy sets and intuitionistic fuzzy sets, neutrosophic sets have been developed to represent uncertain, imprecise, incomplete and inconsistent information that exists in the real world. In this paper, this article introduces an approach to handle multi-criteria decision making (MCDM) problems under the SVN_Ss. Therefore, we develop some new geometric and arithmetic aggregation operators, such as the single valued neutrosophic weighted arithmetic (SVNWA) operator, the single valued neutrosophic ordered weighted arithmetic (SVNOWA) operator, the single-valued neutrosophic sets hybrid ordered weighted arithmetic (SVNSHOWA) operator, the single-valued neutrosophic weighted geometric (SVN_{WG}) operator and the single-valued neutrosophic ordered weighted geometric (SVNOWG) operator and the single-valued neutrosophic hybrid ordered weighted geometric (SVNHOG) operator, which extend the intuitionistic fuzzy weighted geometric and intuitionistic fuzzy ordered weighted geometric operators to accommodate the environment in which the given arguments are single valued neutrosophic sets which are characterized by a membership function, an indeterminacy-membership function and a non-membership function. Some numerical examples are given to illustrate the developed operators. Finally, a numerical example is used to demonstrate how to apply the proposed approach.

KEYWORDS: Neutrosophic set, Single valued neutrosophic weighted geometric (SVN_{WG}) operator, Single valued neutrosophic weighted arithmetic (SVNWA) operator.

Section1. Introduction

To handle with imprecision and uncertainty, concept of fuzzy sets and intuitionistic fuzzy sets originally introduced by Zadeh (Zadeh 1965) and Atanassov (Atanassov 1986), respectively. Then, Smarandache (Smarandache 1998) proposed concept of neutrosophic set which is generalization of fuzzy set theory and intuitionistic fuzzy sets. The neutrosophic sets may express more abundant and flexible information as compared with the fuzzy sets and intuitionistic fuzzy sets. Recently, neutrosophic sets have been researched by many scholars in different fields. For example; on multi-criteria decision making problems (Liu et al. 2017a, 2017b, 2017c, Lin 2017, Kandasamy and Smarandache 2017) etc. Also the notations such as fuzzy sets, intuitionistic fuzzy sets and neutrosophic sets have been applied to some different fields in (Broumi et al. 2014a, 2014b, 2015a, 2015b, 2015c, 2016a, 2016b, 2016c, 2016d, He et al. 2014a, 2014b, 2014c, Şahin et al 2015, 2016, Uluçay et al. 2016a, 2016b).

This paper mainly discusses extension forms of these aggregation operators with intuitionistic fuzzy sets, including the intuitionistic fuzzy weighted averaging operator, intuitionistic fuzzy OWA operator, intuitionistic fuzzy hybrid weighted averaging operator, intuitionistic fuzzy GOWA operator, intuitionistic fuzzy generalized hybrid weighted averaging operator and their

applications to multi-attribute decision-making with intuitionistic fuzzy sets (Li 2011, Li 2010, Li et al. 2010a Wang et al. 2009, Li et al 2010b).

In this paper, we shall develop some geometric operators and arithmetic operator, such as the single-valued neutrosophic weighted arithmetic operator (SVNWAO), the single valued neutrosophic weighted geometric (SVNWG) operator, the intuitionistic fuzzy ordered weighted geometric (IFOWG) operator and the intuitionistic fuzzy hybrid geometric (IFHG) operator. To do so, this paper is structured as follows. In Section 2, we review the weighted geometric (WG) operator and the ordered weighted geometric (OWG) operator. In Section 3, we develop the IFWG operator, the IFOWG operator, and the IFHG operator, and study their various properties. In Section 4, we give an application of the IFHG operator to multiple attribute decision making with intuitionistic fuzzy information. Concluding remarks are made in Section 5.

Section 2. Preliminaries

To facilitate the following discussion, some concepts related to neutrosophic set and single valued neutrosophic set are briefly introduced in this section.

Definition 2.1 (Smarandache 1998) Let X be a space of points (objects), with a generic element in X , denoted by x . An *NS A* in X is characterised by a truth-membership function $T_A(x)$, an indeterminacy-membership function $I_A(x)$ and a falsity-membership function $F_A(x)$. $T_A(x)$, $I_A(x)$ and $F_A(x)$ are standard or non-standard subsets of $]0^-, 1^+[$, that is, $T_A(x) : X \rightarrow]0^-, 1^+[$, $I_A(x) : X \rightarrow]0^-, 1^+[$ and $F_A(x) : X \rightarrow]0^-, 1^+[$. There is no restriction on the sum of $T_A(x)$, $I_A(x)$ and $F_A(x)$, therefore

$$0^- \leq \sup T_A(x) + \sup I_A(x) + \sup F_A(x) \leq 3^+$$

Definition 2.2 (Smarandache 1998) The complement of a neutrosophic set A is denoted by A^c and is defined as

$$T_A^c(x) = \{1^+\} \ominus T_A(x), \quad I_A^c(x) = \{1^+\} \ominus I_A(x), \quad F_A^c(x) = \{1^+\} \ominus F_A(x)$$

for every element x in X .

Definition 2.3 (Smarandache 1998) A neutrosophic set A is contained in the other neutrosophic set B , $A \subseteq B$ if and only if

$$\inf T_A(x) \leq \inf T_B(x), \quad \sup T_A(x) \leq \sup T_B(x), \quad \inf I_A(x) \geq \inf I_B(x), \quad \sup I_A(x) \geq \sup I_B(x), \quad \inf F_A(x) \geq \inf F_B(x) \text{ and } \sup F_A(x) \geq \sup F_B(x)$$

for every x in X .

Definition 2.4 (Smarandache 1998) The union of two neutrosophic sets A and B is a neutrosophic set C denoted by $C = A \cup B$, whose truth-membership, indeterminacy-membership and falsity-membership functions are related to those of A and B by

$$\begin{aligned} T_C(x) &= T_A(x) \oplus T_B(x) \ominus T_A(x) \odot T_B(x) \\ I_C(x) &= I_A(x) \odot I_B(x) \text{ and} \\ F_C(x) &= F_A(x) \odot F_B(x) \end{aligned}$$

for any x in X .

Definition 2.5 (Smarandache 1998) The intersection of two neutrosophic sets A and B is a neutrosophic set C , denoted by $C = A \cap B$, whose truth-membership, indeterminacy-membership and false-membership functions are related to those of A and B by

$$\begin{aligned} T_C(x) &= T_A(x) \odot T_B(x) \\ I_C(x) &= I_A(x) \odot I_B(x) \text{ and} \\ F_C(x) &= F_A(x) \odot F_B(x) \end{aligned}$$

for any x in X .

A single valued neutrosophic set (SVNS) is an instance of a neutrosophic set, which can be used in real scientific and engineering applications (Ye 2014)

Note that the set of all SVNSs on R will be denoted by Λ .

Definition 2.6 (Wang et al. 2010) Let X be a universe set, with a generic element in X denoted by x . A single valued neutrosophic set (SVNS) A in X is characterized by truth-membership function $T_A(x)$, indeterminacy-membership function $I_A(x)$ and falsity-membership function $F_A(x)$. For each element x in X , $T_A(x), I_A(x), F_A(x) \in [0,1]$. Therefore, a SVNS A can be written as follows:

$$A = \{(x, T_A(x), I_A(x), F_A(x)) \mid x \in X\}.$$

For two SVNSs A, B , Wang et al. (Wang et al. 2010) presented the following expressions:

- (1) $A \subseteq B$ if and only if $T_A(x) \leq T_B(x)$, $I_A(x) \geq I_B(x)$ and $F_A(x) \geq F_B(x)$ for every $x \in X$.
- (2) $A = B$ if and only if $A \subseteq B$ and $B \subseteq A$.
- (3) $A^c = \{(x, F_A(x), 1 - I_A(x), T_A(x)) \mid x \in X\}$.

A SVNS A is usually denoted by the simplified symbol $A = \langle T_A(x), I_A(x), F_A(x) \rangle$ for any $x \in X$. For any two SVNSs A and B , the operational relations are defined by Wang et al. (Wang et al. 2010).

- (1) $A \cup B = \langle \max(T_A(x), T_B(x)), \min(I_A(x), I_B(x)), \min(F_A(x), F_B(x)) \rangle$ for every $x \in X$.
- (2) $A \cap B = \langle \min(T_A(x), T_B(x)), \max(I_A(x), I_B(x)), \max(F_A(x), F_B(x)) \rangle$ for every $x \in X$.
- (3) $A \times B = \langle T_A(x) + T_B(x) - T_A(x) \cdot T_B(x), I_A(x) \cdot I_B(x), F_A(x) \cdot F_B(x) \rangle$ for every $x \in X$.

For a SVNS A in X , Ye (Ye 2014) called the triplet $\langle T_A(x), I_A(x), F_A(x) \rangle$ single valued neutrosophic number (SVNN), which is denoted by $\alpha = \langle T_A, I_A, F_A \rangle$.

Definition 2.7 (Ju 2014) Let $\tilde{\alpha} = \langle T, I, F \rangle$ be a SVNN, then the score function and the accuracy function of A are determined by Eqs. (1) and (2), respectively

$$S(\tilde{\alpha}) = (T + 1 - I + 1 - F)/3 \quad (1)$$

$$V(\tilde{\alpha}) = (T + F + 1 - I)/3 \quad (2)$$

Theorem 2.8(Ju 2014) Let $\tilde{\alpha} = \langle T_{\alpha}, I_{\alpha}, F_{\alpha} \rangle$ and $\tilde{b} = \langle T_{\beta}, I_{\beta}, F_{\beta} \rangle$ be two *SVNNs*, then the comparison laws between them are shown as follows:

1-If $S(\tilde{\alpha}) > S(\tilde{b})$, then $\tilde{\alpha} > \tilde{b}$;

2-If $S(\tilde{\alpha}) < S(\tilde{b})$, then $\tilde{\alpha} < \tilde{b}$;

3-If $S(\tilde{\alpha}) = S(\tilde{b})$, then:

(1) If $V(\tilde{\alpha}) > V(\tilde{b})$, then $\tilde{\alpha} > \tilde{b}$;

(2) If $V(\tilde{\alpha}) < V(\tilde{b})$, then $\tilde{\alpha} < \tilde{b}$;

(3) If $V(\tilde{\alpha}) = V(\tilde{b})$, then $\tilde{\alpha} = \tilde{b}$;

Definition 2.9(Chi 2013) Let $\tilde{\alpha} = \langle T, I, F \rangle$, $\tilde{\alpha}_1 = \langle T_1, I_1, F_1 \rangle$ and $\tilde{\alpha}_2 = \langle T_2, I_2, F_2 \rangle$ be any three single valued neutrosophic numbers, and $>$ (*greater than*) 0 , then some operational laws of the *SVNNs* are defined as follows.

$$(1) \tilde{\alpha}_1 \oplus \tilde{\alpha}_2 = \langle T_1 + T_2 - T_1 \times T_2, I_1 \times I_2, F_1 \times F_2 \rangle;$$

$$(2) \tilde{\alpha}_1 \otimes \tilde{\alpha}_2 = \langle T_1 \times T_2, I_1 + I_2 - I_1 \times I_2, F_1 + F_2 - F_1 \times F_2 \rangle;$$

$$(3) \lambda \tilde{\alpha} = \langle 1 - (1 - T)^\lambda, I^\lambda, F^\lambda \rangle, \lambda > 0;$$

$$(4) \tilde{\alpha}^\lambda = \langle T^\lambda, 1 - (1 - I)^\lambda, 1 - (1 - F)^\lambda \rangle, \lambda > 0.$$

Obviously, the above operational results are still *SVNNs*. Some relationships can be further established for these operations on *SVNNs*.

Section 3. Arithmetic operators and Geometric operators of the *SVNS*

3.1 Arithmetic operators of the *SVNS*

Definition 3.1.1 Let $A_j = \langle \xi_j, \varphi_j, \zeta_j \rangle \in \Lambda (j \in I_n)$. Then *SVNS* weighted arithmetic operator, denoted by $\psi_{\alpha\sigma}$, is defined as;

$$\psi_{\alpha\sigma} : \Lambda^n \rightarrow \Lambda, \psi_{\alpha\sigma}(A_1, A_2, \dots, A_n) = \sum_{j=1}^n w_j A_j$$

where, $w = (w_1, w_2, \dots, w_n)^T$ is a weight vector associated with the $\psi_{\alpha\sigma}$ operator, for every $j \in I_n$ such that, $w_j \in [0, 1]$ and $\sum_{j=1}^n w_j = 1$.

Theorem 3.1.2 Let $A_j = \langle \xi_j, \varphi_j, \zeta_j \rangle \in \Lambda (j \in I_n)$ $(w_1, w_2, \dots, w_n)^T$ be a weight vector of A_j , for every $j \in I_n$ such that $w_j \in [0, 1]$ and $\sum_{j=1}^n w_j = 1$. Then, their aggregated value by using $\psi_{\alpha\sigma}$ operator is also a *SVNS* and

$$\psi_{ao}(A_1, A_2, \dots, A_n) = \left(\frac{\sum_{j=1}^n \xi_{A_j}^{w_j}}{1 + \prod_{j=1}^n \xi_{A_j}^{w_j}}, \frac{\sum_{j=1}^n \varphi_{A_j}^{w_j}}{2 - \left[\sum_{j=1}^n \varphi_{A_j}^{w_j} - \prod_{j=1}^n \varphi_{A_j}^{w_j} \right]}, \frac{\sum_{j=1}^n \zeta_{A_j}^{w_j}}{2 - \left[\sum_{j=1}^n \zeta_{A_j}^{w_j} - \prod_{j=1}^n \zeta_{A_j}^{w_j} \right]} \right)$$

Proof: The proof can be made by using mathematical induction on n as; assume that,

$A_1 = (\xi_1, \varphi_1, \zeta_1)$ and $A_2 = (\xi_2, \varphi_2, \zeta_2)$ be two *SVNS* then, for $n = 2$, we have

$$\begin{aligned} \psi_{ao}(A_1, A_2) &= \left(\frac{\sum_{j=1}^2 \xi_{A_j}^{w_j}}{1 + \prod_{j=1}^2 \xi_{A_j}^{w_j}}, \frac{\sum_{j=1}^2 \varphi_{A_j}^{w_j}}{2 - \left[\sum_{j=1}^2 \varphi_{A_j}^{w_j} - \prod_{j=1}^2 \varphi_{A_j}^{w_j} \right]}, \frac{\sum_{j=1}^2 \zeta_{A_j}^{w_j}}{2 - \left[\sum_{j=1}^2 \zeta_{A_j}^{w_j} - \prod_{j=1}^2 \zeta_{A_j}^{w_j} \right]} \right) \\ &= \left(\frac{\xi_{A_1}^{w_1} + \xi_{A_2}^{w_2}}{1 + \xi_{A_1}^{w_1} \cdot \xi_{A_2}^{w_2}}, \frac{\varphi_{A_1}^{w_1} + \varphi_{A_2}^{w_2}}{2 - \left[\varphi_{A_1}^{w_1} + \varphi_{A_2}^{w_2} - \varphi_{A_1}^{w_1} \cdot \varphi_{A_2}^{w_2} \right]}, \frac{\zeta_{A_1}^{w_1} + \zeta_{A_2}^{w_2}}{2 - \left[\zeta_{A_1}^{w_1} + \zeta_{A_2}^{w_2} - \zeta_{A_1}^{w_1} \cdot \zeta_{A_2}^{w_2} \right]} \right) \end{aligned}$$

If holds for $n = k$, that is

$$\psi_{ao}(A_1, A_2, \dots, A_k) = \left(\frac{\sum_{j=1}^k \xi_{A_j}^{w_j}}{1 + \prod_{j=1}^k \xi_{A_j}^{w_j}}, \frac{\sum_{j=1}^k \varphi_{A_j}^{w_j}}{2 - \left[\sum_{j=1}^k \varphi_{A_j}^{w_j} - \prod_{j=1}^k \varphi_{A_j}^{w_j} \right]}, \frac{\sum_{j=1}^k \zeta_{A_j}^{w_j}}{2 - \left[\sum_{j=1}^k \zeta_{A_j}^{w_j} - \prod_{j=1}^k \zeta_{A_j}^{w_j} \right]} \right)$$

then, when $n = k + 2$; by the operational laws in Definition 2.9, I have

$$\begin{aligned} \psi_{ao}(A_1, A_2, \dots, A_k, A_{k+1}, A_{k+2}) &= \left(\frac{\sum_{j=1}^k \xi_{A_j}^{w_j} + \xi_{A_{k+1}}^{w_{k+1}} + \xi_{A_{k+2}}^{w_{k+2}}}{1 + \left[\left(\prod_{j=1}^k \xi_{A_j}^{w_j} \right) \cdot \xi_{A_{k+1}}^{w_{k+1}} \cdot \xi_{A_{k+2}}^{w_{k+2}} \right]}, \right. \\ &\quad \left. \frac{\left(\sum_{j=1}^k \varphi_{A_j}^{w_j} \right) + \varphi_{A_{k+1}}^{w_{k+1}} + \varphi_{A_{k+2}}^{w_{k+2}}}{2 - \left[\left(\sum_{j=1}^k \varphi_{A_j}^{w_j} \right) + \varphi_{A_{k+1}}^{w_{k+1}} + \varphi_{A_{k+2}}^{w_{k+2}} - \left(\prod_{j=1}^k \varphi_{A_j}^{w_j} \right) \cdot \varphi_{A_{k+1}}^{w_{k+1}} \cdot \varphi_{A_{k+2}}^{w_{k+2}} \right]}, \right. \\ &\quad \left. \frac{\left(\sum_{j=1}^k \zeta_{A_j}^{w_j} \right) + \zeta_{A_{k+1}}^{w_{k+1}} + \zeta_{A_{k+2}}^{w_{k+2}}}{2 - \left[\left(\sum_{j=1}^k \zeta_{A_j}^{w_j} \right) + \zeta_{A_{k+1}}^{w_{k+1}} + \zeta_{A_{k+2}}^{w_{k+2}} - \left(\prod_{j=1}^k \zeta_{A_j}^{w_j} \right) \cdot \zeta_{A_{k+1}}^{w_{k+1}} \cdot \zeta_{A_{k+2}}^{w_{k+2}} \right]} \right) \\ \psi_{ao}(A_1, A_2, \dots, A_k, A_{k+1}, A_{k+2}) &= \left(\frac{\sum_{j=1}^{k+2} \xi_{A_j}^{w_j}}{1 + \prod_{j=1}^{k+2} \xi_{A_j}^{w_j}}, \frac{\sum_{j=1}^{k+2} \varphi_{A_j}^{w_j}}{2 - \left[\sum_{j=1}^{k+2} \varphi_{A_j}^{w_j} - \prod_{j=1}^{k+2} \varphi_{A_j}^{w_j} \right]}, \frac{\sum_{j=1}^{k+2} \zeta_{A_j}^{w_j}}{2 - \left[\sum_{j=1}^{k+2} \zeta_{A_j}^{w_j} - \prod_{j=1}^{k+2} \zeta_{A_j}^{w_j} \right]} \right) \end{aligned}$$

Example 3.1.3 $A_1 = (0.3, 0.2, 0.5)$, $A_2 = (0.1, 0.5, 0.7)$, $A_3 = (0.7, 0.1, 0.8)$ and $A_4 = (0.4, 0.2, 0.5)$ $w = (0.3, 0.4, 0.1, 0.2)^T$

$$\begin{aligned} \psi_{ao}(A_1, A_2, A_3, A_4) &= \left(\frac{\sum_{j=1}^4 \xi_{A_j}^{w_j}}{1 + \prod_{j=1}^4 \xi_{A_j}^{w_j}}, \frac{\sum_{j=1}^4 \varphi_{A_j}^{w_j}}{2 - \left[\sum_{j=1}^4 \varphi_{A_j}^{w_j} - \prod_{j=1}^4 \varphi_{A_j}^{w_j} \right]}, \frac{\sum_{j=1}^4 \zeta_{A_j}^{w_j}}{2 - \left[\sum_{j=1}^4 \zeta_{A_j}^{w_j} - \prod_{j=1}^4 \zeta_{A_j}^{w_j} \right]} \right) \\ &= \left(\frac{0.3^{0.3} + 0.1^{0.4} + 0.7^{0.1} + 0.4^{0.2}}{1 + 0.3^{0.3} \times 0.1^{0.4} \times 0.7^{0.1} \times 0.4^{0.2}}, \right. \end{aligned}$$

$$\frac{0.2^{0.3} + 0.5^{0.4} + 0.1^{0.1} + 0.2^{0.2}}{2 - [(0.2^{0.3} + 0.5^{0.4} + 0.1^{0.1} + 0.2^{0.2}) - (0.2^{0.3} \times 0.5^{0.4} \times 0.1^{0.1} \times 0.2^{0.2})]},$$

$$\frac{0.5^{0.3} + 0.7^{0.4} + 0.8^{0.1} + 0.5^{0.2}}{2 - [(0.5^{0.3} + 0.7^{0.4} + 0.8^{0.1} + 0.5^{0.2}) - (0.5^{0.3} \times 0.7^{0.4} \times 0.8^{0.1} \times 0.5^{0.2})]}$$

$$= \langle 2.365, -4.632, -3.800 \rangle$$

Definition 3.1.4 Let $A_j = \langle \xi_j, \varphi_j, \zeta_j \rangle \in \Lambda$ ($j \in I_n$) $w = (w_1, w_2, \dots, w_n)^T$. Then *SVNS* ordered weighted arithmetic operator denoted by $\psi_{\alpha\alpha\alpha}$, is defined as;

$$\psi_{\alpha\alpha\alpha} : \Lambda^n \rightarrow \Lambda, \psi_{\alpha\alpha\alpha}(A_1, A_2, \dots, A_n) = \sum_{j=1}^n w_j A_j$$

where $(w_1, w_2, \dots, w_n)^T$ is a weight vector associated with the mapping $\psi_{\alpha\alpha\alpha}$; which satisfies the normalized conditions: $w_k \in [0, 1]$ and $\sum_{k=1}^n w_k = 1$; $B_j = \langle \tilde{\xi}_j, \tilde{\varphi}_j, \tilde{\zeta}_j \rangle$ is the k -th largest of the n *SVNS* which is determined through using ranking method in Definition 2.7.

It is not difficult to follow from Definition 3.1.4 that

$$\psi_{\alpha\alpha\alpha}(B_1, B_2, \dots, B_n) = \left(\frac{\sum_{j=1}^n \xi_{B_j}^{w_j}}{1 + \prod_{j=1}^n \xi_{B_j}^{w_j}}, \frac{\sum_{j=1}^n \varphi_{B_j}^{w_j}}{2 - [\sum_{j=1}^n \varphi_{B_j}^{w_j} - \prod_{j=1}^n \varphi_{B_j}^{w_j}]}, \frac{\sum_{j=1}^n \zeta_{B_j}^{w_j}}{2 - [\sum_{j=1}^n \zeta_{B_j}^{w_j} - \prod_{j=1}^n \zeta_{B_j}^{w_j}]} \right)$$

which is summarized as in Theorem 3.1.5

Theorem 3.1.5 Let $A_j = \langle \xi_j, \varphi_j, \zeta_j \rangle \in \Lambda$ ($j \in I_n$). Then *SVNS* ordered weighted arithmetic operator denoted by $\psi_{\alpha\alpha\alpha}$, is defined as; $\psi_{\alpha\alpha\alpha} : \Lambda^n \rightarrow \Lambda$

$$\psi_{\alpha\alpha\alpha}(B_1, B_2, \dots, B_n) = \left(\frac{\sum_{j=1}^n \xi_{B_j}^{w_j}}{1 + \prod_{j=1}^n \xi_{B_j}^{w_j}}, \frac{\sum_{j=1}^n \varphi_{B_j}^{w_j}}{2 - [\sum_{j=1}^n \varphi_{B_j}^{w_j} - \prod_{j=1}^n \varphi_{B_j}^{w_j}]}, \frac{\sum_{j=1}^n \zeta_{B_j}^{w_j}}{2 - [\sum_{j=1}^n \zeta_{B_j}^{w_j} - \prod_{j=1}^n \zeta_{B_j}^{w_j}]} \right)$$

where $w_k \in [0, 1]$ and $\sum_{k=1}^n w_k = 1$ $B_j = \langle \tilde{\xi}_j, \tilde{\varphi}_j, \tilde{\zeta}_j \rangle$ is the k -th largest of the n *SVNS* \tilde{A}_j ($j \in I_n$) which is determined through using ranking method in Definition 2.7.

Proof: Theorem 3.1.5 can be proven in a similar way to that of Theorem 3.1.2 (omitted).

Example 3.1.6 $A_1 = \langle 0.1, 0.2, 0.4 \rangle$, $A_2 = \langle 0.2, 0.5, 0.3 \rangle$, $A_3 = \langle 0.5, 0.2, 0.1 \rangle$ and $A_4 = \langle 0.5, 0.1, 0.1 \rangle$ $w = \langle 0.1, 0.4, 0.3, 0.2 \rangle^T$

$$s(A) = \frac{T_A + 1 - I_A + 1 - F_A}{3}$$

$$s(A_1) = \frac{(0.1 + 1 - 0.2 + 1 - 0.4)}{3} = 0.5$$

$$s(A_2) = \frac{(0.2 + 1 - 0.5 + 1 - 0.3)}{3} = 0.466$$

$$s(A_3) = \frac{(0.5 + 1 - 0.2 + 1 - 0.1)}{3} = 0.733$$

$$s(A_4) = \frac{(0.5 + 1 - 0.1 + 1 - 0.1)}{3} = 0.766$$

It is obvious that $s(A_4) > s(A_3) > s(A_1) > s(A_2)$. Hence, according to the above scoring function ranking method, it follows that $A_4 > A_3 > A_1 > A_2$. Thus, we have:

$$B_1 = A_4 = \langle 0.5, 0.4, 0.7 \rangle$$

$$B_2 = A_3 = \langle 0.6, 0.4, 0.5 \rangle$$

$$B_3 = A_1 = \langle 0.1, 0.2, 0.4 \rangle$$

$$B_4 = A_2 = \langle 0.7, 0.2, 0.9 \rangle$$

$$\Psi_{\text{ono}}(B_1, B_2, \dots, B_n) = \left(\frac{\sum_{j=1}^n \xi_{B_j}^{w_j}}{1 + \prod_{j=1}^n \xi_{B_j}^{w_j}}, \frac{\sum_{j=1}^n \phi_{B_j}^{w_j}}{2 - [\sum_{j=1}^n \phi_{B_j}^{w_j} - \prod_{j=1}^n \phi_{B_j}^{w_j}]}, \frac{\sum_{j=1}^n \zeta_{B_j}^{w_j}}{2 - [\sum_{j=1}^n \zeta_{B_j}^{w_j} - \prod_{j=1}^n \zeta_{B_j}^{w_j}]} \right)$$

$$= \left(\frac{0.5^{0.1} + 0.6^{0.4} + 0.1^{0.3} + 0.7^{0.2}}{1 + 0.5^{0.1} \times 0.6^{0.4} \times 0.1^{0.3} \times 0.7^{0.2}}, \frac{0.4^{0.1} + 0.4^{0.4} + 0.2^{0.3} + 0.2^{0.2}}{2 - [(0.4^{0.1} + 0.4^{0.4} + 0.2^{0.3} + 0.2^{0.2}) - (0.4^{0.1} \times 0.4^{0.4} \times 0.2^{0.3} \times 0.2^{0.2})]} \right)$$

$$\frac{0.7^{0.1} + 0.5^{0.4} + 0.4^{0.3} + 0.9^{0.2}}{2 - [(0.7^{0.1} + 0.5^{0.4} + 0.4^{0.3} + 0.9^{0.2}) - (0.7^{0.1} \times 0.5^{0.4} \times 0.4^{0.3} \times 0.9^{0.2})]}$$

$$= \langle 2.320, -4.931, -4.984 \rangle$$

Definition 3.1.7 Let $A_j = \langle \xi_j, \varphi_j, \zeta_j \rangle \in \Lambda$ ($j \in I_n$) $w = (w_1, w_2, \dots, w_n)^T$. Then *SVNS* hybrid ordered weighted arithmetic operator denoted by Ψ_{hao} , is defined as;

$$\Psi_{\text{hao}} : \Lambda^n \rightarrow \Lambda, \Psi_{\text{hao}}(A_1, A_2, \dots, A_n) = \sum_{j=1}^n w_j \bar{B}_j$$

where $w = (w_1, w_2, \dots, w_n)^T$, $w_k \in [0, 1]$ and $\sum_{j=1}^n w_j = 1$ is a weight vector associated with the mapping Ψ_{hgo} , $\bar{B}_k = n w A_k$ here n is regarded as a balance factor $\omega = (\omega_1, \omega_2, \dots, \omega_n)^T$ is a weight vector of the $A_k \in \Lambda$ ($j \in I_n$) \bar{B}_k is the k -th largest of the n *SNS* $\bar{B}_k \in \Lambda$ ($j \in I_n$) which are determined through using some ranking method such as the above scoring function ranking method.

Note that if $\omega = (1/n, 1/n, \dots, 1/n)^T$, then Ψ_{hgo} degenerates to the Ψ_{ogo} .

Theorem 3.1.8 Let $A_j = \langle \xi_j, \varphi_j, \zeta_j \rangle \in \Lambda$ ($j \in I_n$) $w = (w_1, w_2, \dots, w_n)^T$ be a weight vector of A_j with $w_j \in [0, 1]$ and $\sum_{j=1}^n w_j = 1$. Then their aggregated value by using Ψ_{hao} operator is also a *SVNS* and $\Psi_{\text{hao}} : \Lambda^n \rightarrow \Lambda$

$$\psi_{h\sigma\alpha}(\bar{B}_1, \bar{B}_2, \dots, \bar{B}_n) = \left(\frac{\sum_{j=1}^n \bar{\xi}_{\bar{B}_j}^{wj}}{1 + \prod_{j=1}^n \bar{\xi}_{\bar{B}_j}^{wj}}, \frac{\sum_{j=1}^n \bar{\varphi}_{\bar{B}_j}^{wj}}{2 - \left[\sum_{j=1}^n \bar{\varphi}_{\bar{B}_j}^{wj} - \prod_{k=1}^n \bar{\varphi}_{\bar{B}_j}^{wj} \right]}, \frac{\sum_{j=1}^n \bar{\zeta}_{\bar{B}_j}^{wj}}{2 - \left[\sum_{j=1}^n \bar{\zeta}_{\bar{B}_j}^{wj} - \prod_{j=1}^n \bar{\zeta}_{\bar{B}_j}^{wj} \right]} \right)$$

where $\bar{B}_j = \langle \bar{\xi}_j, \bar{\varphi}_j, \bar{\zeta}_j \rangle$ is the k-th largest of the n SNS $\dot{B}_j = n w A_j (j \in I_n)$ which is determined through using some ranking method such as the above scoring function ranking method.

Proof : Theorem 3.1.8 can be proven in a similar way to that of Theorem 3.1.2 (omitted).

Example 3.1.9 $A_1 = \langle 0.2, 0.1, 0.3 \rangle, A_2 = \langle 0.8, 0.5, 0.9 \rangle, A_3 = \langle 0.2, 0.4, 0.5 \rangle$ and $A_4 = \langle 0.3, 0.7, 0.2 \rangle$ $w = (0.5, 0.2, 0.1, 0.2)^T$ $\omega = (0.4, 0.1, 0.2, 0.3)$

$$\begin{aligned} \dot{B}_1 &= 4 \times 0.4 A_1 = \langle 1 - (1 - 0.2)^{4 \times 0.4}, 0.1^{4 \times 0.4}, 0.3^{4 \times 0.4} \rangle = \langle 0.300, 0.025, 0.145 \rangle \\ \dot{B}_2 &= 4 \times 0.1 A_2 = \langle 1 - (1 - 0.8)^{4 \times 0.1}, 0.5^{4 \times 0.1}, 0.9^{4 \times 0.1} \rangle = \langle 0.474, 0.757, 0.958 \rangle \\ \dot{B}_3 &= 4 \times 0.2 A_3 = \langle 1 - (1 - 0.2)^{4 \times 0.2}, 0.4^{4 \times 0.2}, 0.5^{4 \times 0.2} \rangle = \langle 0.163, 0.480, 0.574 \rangle \\ \dot{B}_4 &= 4 \times 0.3 A_4 = \langle 1 - (1 - 0.3)^{4 \times 0.3}, 0.7^{4 \times 0.3}, 0.2^{4 \times 0.3} \rangle = \langle 0.348, 0.651, 0.144 \rangle \end{aligned}$$

we obtain the scores of the Simplified neutrosophic sets $\dot{B}_k (k = 1, 2, 3, 4)$ as follows:

$$\begin{aligned} s(A) &= \frac{T_A + 1 - I_A + 1 - F_A}{3} \\ s(\dot{B}_1) &= \frac{(0.300 + 1 - 0.025 + 1 - 0.145)}{3} = 0.709 \\ s(\dot{B}_2) &= \frac{(0.474 + 1 - 0.757 + 1 - 0.958)}{3} = 0.252 \\ s(\dot{B}_3) &= \frac{(0.163 + 1 - 0.480 + 1 - 0.574)}{3} = 0.369 \\ s(\dot{B}_4) &= \frac{(0.348 + 1 - 0.651 + 1 - 0.144)}{3} = 0.517 \end{aligned}$$

respectively. Obviously, $s(\dot{B}_1) > s(\dot{B}_4) > s(\dot{B}_3) > s(\dot{B}_2)$. Thereby, according to the above scoring function ranking method, we have:

$$\begin{aligned} \bar{B}_1 &= \dot{B}_1 = \langle 0.300, 0.025, 0.145 \rangle \\ \bar{B}_2 &= \dot{B}_4 = \langle 0.348, 0.651, 0.144 \rangle \\ \bar{B}_3 &= \dot{B}_3 = \langle 0.163, 0.480, 0.574 \rangle \\ \bar{B}_4 &= \dot{B}_2 = \langle 0.474, 0.757, 0.958 \rangle \end{aligned}$$

$$\psi_{h\sigma\alpha}(\bar{B}_1, \bar{B}_2, \dots, \bar{B}_n) = \left(\frac{\sum_{j=1}^n \bar{\xi}_{\bar{B}_j}^{wj}}{1 + \prod_{j=1}^n \bar{\xi}_{\bar{B}_j}^{wj}}, \frac{\sum_{j=1}^n \bar{\varphi}_{\bar{B}_j}^{wj}}{2 - \left[\sum_{j=1}^n \bar{\varphi}_{\bar{B}_j}^{wj} - \prod_{k=1}^n \bar{\varphi}_{\bar{B}_j}^{wj} \right]}, \frac{\sum_{j=1}^n \bar{\zeta}_{\bar{B}_j}^{wj}}{2 - \left[\sum_{j=1}^n \bar{\zeta}_{\bar{B}_j}^{wj} - \prod_{j=1}^n \bar{\zeta}_{\bar{B}_j}^{wj} \right]} \right)$$

$$\psi_{h\sigma\alpha}(\bar{B}_1, \bar{B}_2, \bar{B}_3, \bar{B}_4) = \left(\frac{0.300^{0.5} + 0.348^{0.2} + 0.163^{0.1} + 0.474^{0.2}}{1 + 0.300^{0.5} \times 0.348^{0.2} \times 0.163^{0.1} \times 0.474^{0.2}} \right)$$

$$\frac{0.025^{0.5} + 0.651^{0.2} + 0.480^{0.1} + 0.757^{0.2}}{2 - [(0.025^{0.5} + 0.651^{0.2} + 0.480^{0.1} + 0.757^{0.2}) - (0.025^{0.5} \times 0.651^{0.2} \times 0.480^{0.1} \times 0.757^{0.2})]}$$

$$\frac{0.145^{0.5} + 0.144^{0.2} + 0.574^{0.1} + 0.958^{0.2}}{2 - [(0.145^{0.5} + 0.144^{0.2} + 0.574^{0.1} + 0.958^{0.2}) - (0.145^{0.5} \times 0.144^{0.2} \times 0.574^{0.1} \times 0.958^{0.2})]}$$

$$=(2.315, -3.582, -3.968)$$

3.2. Geometric operators of the SVNS

In this section, three SVNS weighted geometric operator of SVNS is called SVNS weighted geometric operator, SVNS ordered weighted geometric operator and SVNS hybrid ordered weighted geometric operator is given. Some of it is quoted from application in (He 2014a 2014b, 2014c, Xu and Yager 2006, Wei 2010).

Definition 3.2.1 Let $A_j = \langle \xi_j, \varphi_j, \zeta_j \rangle \in \Lambda$ ($j \in I_n$). Then SVNS weighted geometric operator, denoted by U_{go} , is defined as;

$$U_{go} : \Lambda^n \rightarrow \Lambda, U_{go}(A_1, A_2, \dots, A_n) = \prod_{j=1}^n A_j^{w_j}$$

where, $w = (w_1, w_2, \dots, w_n)^T$ is a weight vector associated with the U_{go} operator, for every $j \in I_n$ such that, $w_j \in [0, 1]$ and $\sum_{j=1}^n w_j = 1$.

Theorem 3.2.2 Let $A_j = \langle \xi_j, \varphi_j, \zeta_j \rangle \in \Lambda$ ($j \in I_n$) $(w_1, w_2, \dots, w_n)^T$ be a weight vector of A_j , for every $j \in I_n$ such that $w_j \in [0, 1]$ and $\sum_{i=1}^n w_j = 1$. Then, their aggregated value by using U_{go} operator is also a SVNS and

$$U_{go}(A_1, A_2, \dots, A_n) = \left\langle \frac{\sum_{j=1}^n \xi_{A_j}^{w_j}}{2 - \left[\sum_{j=1}^n \xi_{A_j}^{w_j} - \prod_{j=1}^n \xi_{A_j}^{w_j} \right]}, \frac{\sum_{j=1}^n \varphi_{A_j}^{w_j}}{1 + \prod_{j=1}^n \varphi_{A_j}^{w_j}}, \frac{\sum_{j=1}^n \zeta_{A_j}^{w_j}}{1 + \prod_{j=1}^n \zeta_{A_j}^{w_j}} \right\rangle$$

Proof: The proof can be made by using mathematical induction on n as; assume that,

$A_1 = \langle \xi_1, \varphi_1, \zeta_1 \rangle$ and $A_2 = \langle \xi_2, \varphi_2, \zeta_2 \rangle$ be two SNS then,

for $n = 2$, we have

$$U_{go}(A_1, A_2) = \left\langle \frac{\sum_{j=1}^2 \xi_{A_j}^{w_j}}{2 - \left[\sum_{j=1}^2 \xi_{A_j}^{w_j} - \prod_{j=1}^2 \xi_{A_j}^{w_j} \right]}, \frac{\sum_{j=1}^2 \varphi_{A_j}^{w_j}}{1 + \prod_{j=1}^2 \varphi_{A_j}^{w_j}}, \frac{\sum_{j=1}^2 \zeta_{A_j}^{w_j}}{1 + \prod_{j=1}^2 \zeta_{A_j}^{w_j}} \right\rangle$$

$$= \left\langle \frac{\xi_{A_1}^{w_1} + \xi_{A_2}^{w_2}}{2 - \left[\xi_{A_1}^{w_1} + \xi_{A_2}^{w_2} - \xi_{A_1}^{w_1} \cdot \xi_{A_2}^{w_2} \right]}, \frac{\varphi_{A_1}^{w_1} + \varphi_{A_2}^{w_2}}{1 + \varphi_{A_1}^{w_1} \cdot \varphi_{A_2}^{w_2}}, \frac{\zeta_{A_1}^{w_1} + \zeta_{A_2}^{w_2}}{1 + \zeta_{A_1}^{w_1} \cdot \zeta_{A_2}^{w_2}} \right\rangle$$

If holds for $n = k$, that is

$$U_{go}(A_1, A_2, \dots, A_k) = \left(\frac{\sum_{j=1}^k \xi_{A_j}^{w_j}}{2 - \left[\sum_{j=1}^k \xi_{A_j}^{w_j} - \prod_{j=1}^k \xi_{A_j}^{w_j} \right]}, \frac{\sum_{j=1}^k \varphi_{A_j}^{w_j}}{1 + \prod_{j=1}^k \varphi_{A_j}^{w_j}}, \frac{\sum_{j=1}^k \zeta_{A_j}^{w_j}}{1 + \prod_{j=1}^k \zeta_{A_j}^{w_j}} \right)$$

then, when $n = k + 2$; by the operational laws in Definition 2.9, I have

$$U_{go}(A_1, A_2, \dots, A_k, A_{k+1}, A_{k+2}) = \left(\frac{\left(\sum_{j=1}^k \xi_{A_j}^{w_j} \right) + \xi_{A_{k+1}}^{w_{k+1}} + \xi_{A_{k+2}}^{w_{k+2}}}{2 - \left[\left(\sum_{j=1}^k \xi_{A_j}^{w_j} \right) + \xi_{A_{k+1}}^{w_{k+1}} + \xi_{A_{k+2}}^{w_{k+2}} - \left(\prod_{j=1}^k \xi_{A_j}^{w_j} \right) \times \xi_{A_{k+1}}^{w_{k+1}} \times \xi_{A_{k+2}}^{w_{k+2}} \right]}, \right. \\ \left. \frac{\left(\sum_{j=1}^k \varphi_{A_j}^{w_j} \right) + \varphi_{A_{k+1}}^{w_{k+1}} + \varphi_{A_{k+2}}^{w_{k+2}}}{1 + \left(\prod_{j=1}^k \varphi_{A_j}^{w_j} \right) + \varphi_{A_{k+1}}^{w_{k+1}} + \varphi_{A_{k+2}}^{w_{k+2}}}, \frac{\left(\sum_{j=1}^k \zeta_{A_j}^{w_j} \right) + \zeta_{A_{k+1}}^{w_{k+1}} + \zeta_{A_{k+2}}^{w_{k+2}}}{1 + \left(\prod_{j=1}^k \zeta_{A_j}^{w_j} \right) + \zeta_{A_{k+1}}^{w_{k+1}} + \zeta_{A_{k+2}}^{w_{k+2}}} \right) \\ U_{go}(A_1, A_2, \dots, A_k, A_{k+1}, A_{k+2}) = \left(\frac{\sum_{j=1}^{k+2} \xi_{A_j}^{w_j}}{2 - \left[\sum_{j=1}^{k+2} \xi_{A_j}^{w_j} - \prod_{j=1}^{k+2} \xi_{A_j}^{w_j} \right]}, \frac{\sum_{j=1}^{k+2} \varphi_{A_j}^{w_j}}{1 + \prod_{j=1}^{k+2} \varphi_{A_j}^{w_j}}, \frac{\sum_{j=1}^{k+2} \zeta_{A_j}^{w_j}}{1 + \prod_{j=1}^{k+2} \zeta_{A_j}^{w_j}} \right)$$

Example 3.2.3 $A_1 = \langle 0.4, 0.5, 0.6 \rangle$, $A_2 = \langle 0.8, 0.9, 0.3 \rangle$, $A_3 = \langle 0.8, 0.5, 0.3 \rangle$ and $A_4 = \langle 0.7, 0.6, 0.5 \rangle$ $w = (0.1, 0.5, 0.2, 0.2)^T$

$$U_{go}(A_1, A_2, \dots, A_n) = \left(\frac{\sum_{j=1}^n \xi_{A_j}^{w_j}}{2 - \left[\sum_{j=1}^n \xi_{A_j}^{w_j} - \prod_{j=1}^n \xi_{A_j}^{w_j} \right]}, \frac{\sum_{j=1}^n \varphi_{A_j}^{w_j}}{1 + \prod_{j=1}^n \varphi_{A_j}^{w_j}}, \frac{\sum_{j=1}^n \zeta_{A_j}^{w_j}}{1 + \prod_{j=1}^n \zeta_{A_j}^{w_j}} \right) \\ = \left(\frac{0.4^{0.1} + 0.8^{0.5} + 0.8^{0.2} + 0.7^{0.2}}{2 - \left[(0.4^{0.1} + 0.8^{0.5} + 0.8^{0.2} + 0.7^{0.2}) - (0.4^{0.1} \times 0.8^{0.5} \times 0.8^{0.2} \times 0.7^{0.2}) \right]}, \right. \\ \left. \frac{0.5^{0.1} + 0.9^{0.5} + 0.5^{0.2} + 0.6^{0.2}}{1 + 0.5^{0.1} \times 0.9^{0.5} \times 0.5^{0.2} \times 0.6^{0.2}}, \frac{0.6^{0.1} + 0.3^{0.5} + 0.3^{0.2} + 0.5^{0.2}}{1 + 0.6^{0.1} \times 0.3^{0.5} \times 0.3^{0.2} \times 0.5^{0.2}} \right) \\ = \langle -3.818, 2.155, 2.326 \rangle$$

Definition 3.2.4 Let $A_j = \langle \xi_j, \varphi_j, \zeta_j \rangle \in \Lambda$ ($j \in I_n$) $w = (w_1, w_2, \dots, w_n)^T$. Then *SVNS* ordered weighted geometric operator denoted by U_{oggo} , is defined as;

$$U_{oggo} : \Lambda^n \rightarrow \Lambda, U_{oggo}(A_1, A_2, \dots, A_n) = \prod_{j=1}^n B_j^{w_j}$$

where $(w_1, w_2, \dots, w_n)^T$ is a weight vector associated with the mapping U_{oggo} ; which satisfies the normalized conditions: $w_k \in [0, 1]$ and $\sum_{k=1}^n w_k = 1$; $B_k = \langle \xi_j, \varphi_j, \zeta_j \rangle$ is the k -th largest of the n *SVNS* which is determined through using ranking method in Definition 2.7.

It is not difficult to follows from Definition 3.2.4 that

$$U_{oggo}(B_1, B_2, \dots, B_n) = \left(\frac{\sum_{j=1}^n \xi_{B_j}^{w_j}}{2 - \left[\sum_{j=1}^n \xi_{B_j}^{w_j} - \prod_{j=1}^n \xi_{B_j}^{w_j} \right]}, \frac{\sum_{j=1}^n \tilde{\varphi}_{B_j}^{w_j}}{1 + \prod_{j=1}^n \tilde{\varphi}_{B_j}^{w_j}}, \frac{\sum_{j=1}^n \zeta_{B_j}^{w_j}}{1 + \prod_{j=1}^n \zeta_{B_j}^{w_j}} \right)$$

which is summarized as in Theorem 3.2.5.

Theorem 3.2.5 Let $A_j = \langle \xi_j, \varphi_j, \zeta_j \rangle \in A$ ($j \in I_n$). Then *SVNS* orderedweighted geometric operator denoted by U_{oggo} , is defined as; $U_{oggo} : A^n \rightarrow A$

$$U_{oggo}(B_1, B_2, \dots, B_n) = \left(\frac{\sum_{j=1}^n \xi_{B_j}^{w_j}}{2 - \left[\sum_{j=1}^n \xi_{B_j}^{w_j} - \prod_{j=1}^n \xi_{B_j}^{w_j} \right]}, \frac{\sum_{j=1}^n \tilde{\varphi}_{B_j}^{w_j}}{1 + \prod_{j=1}^n \tilde{\varphi}_{B_j}^{w_j}}, \frac{\sum_{j=1}^n \zeta_{B_j}^{w_j}}{1 + \prod_{j=1}^n \zeta_{B_j}^{w_j}} \right)$$

where $w_k \in [0, 1]$ and $\sum_{j=1}^n w_j = 1$ $B_j = \langle \xi_j, \tilde{\varphi}_j, \zeta_j \rangle$ is the k -th largest of then *SVNS* A_j ($j \in I_n$) which is determined through using ranking method in Definition 2.7.

Proof: Theorem 3.2.5 can be proven in a similar way to that of Theorem 3.2.2 (omitted).

Example 3.2.6 $A_1 = \langle 0.2, 0.4, 0.3 \rangle$, $A_2 = \langle 0.7, 0.2, 0.9 \rangle$, $A_3 = \langle 0.5, 0.4, 0.7 \rangle$ and $A_4 = \langle 0.6, 0.4, 0.5 \rangle$ $w = (0.6, 0.1, 0.1, 0.2)^T$

$$s(A) = \frac{T_A + 1 - I_A + 1 - F_A}{3}$$

$$s(A_1) = \frac{(0.2 + 1 - 0.4 + 1 - 0.3)}{3} = 0.5$$

$$s(A_2) = \frac{(0.7 + 1 - 0.2 + 1 - 0.9)}{3} = 0.533$$

$$s(A_3) = \frac{(0.5 + 1 - 0.4 + 1 - 0.7)}{3} = 0.466$$

$$s(A_4) = \frac{(0.6 + 1 - 0.4 + 1 - 0.5)}{3} = 0.566$$

It is obvious that $s(A_4) > s(A_2) > s(A_1) > s(A_3)$. Hence, according to the above scoring function ranking method, it follows that $A_4 > A_2 > A_1 > A_3$. Thus, we have:

$$B_1 = A_3 = \langle 0.5, 0.4, 0.7 \rangle$$

$$B_2 = A_4 = \langle 0.6, 0.4, 0.5 \rangle$$

$$B_3 = A_1 = \langle 0.2, 0.4, 0.3 \rangle$$

$$B_4 = A_2 = \langle 0.7, 0.2, 0.9 \rangle$$

$$U_{oggo}(B_1, B_2, \dots, B_n) = \left(\frac{\sum_{j=1}^n \xi_{B_j}^{w_j}}{2 - \left[\sum_{j=1}^n \xi_{B_j}^{w_j} - \prod_{j=1}^n \xi_{B_j}^{w_j} \right]}, \frac{\sum_{j=1}^n \tilde{\varphi}_{B_j}^{w_j}}{1 + \prod_{j=1}^n \tilde{\varphi}_{B_j}^{w_j}}, \frac{\sum_{j=1}^n \zeta_{B_j}^{w_j}}{1 + \prod_{j=1}^n \zeta_{B_j}^{w_j}} \right)$$

$$= \left(\frac{0.5^{0.6} + 0.6^{0.1} + 0.2^{0.1} + 0.7^{0.2}}{2 - \left[(0.5^{0.6} + 0.6^{0.1} + 0.2^{0.1} + 0.7^{0.2}) - (0.5^{0.6} \times 0.6^{0.1} \times 0.2^{0.1} \times 0.7^{0.2}) \right]}, \dots \right)$$

$$\frac{0.4^{0.6} + 0.4^{0.1} + 0.4^{0.1} + 0.2^{0.2}}{1 + 0.4^{0.6} \times 0.4^{0.1} \times 0.4^{0.1} \times 0.2^{0.2}}, \frac{0.7^{0.6} + 0.5^{0.1} + 0.3^{0.1} + 0.9^{0.2}}{1 + 0.7^{0.6} \times 0.5^{0.1} \times 0.3^{0.1} \times 0.9^{0.2}}$$

$$= \langle -3.818, 2.310, 2.252 \rangle$$

Definition 3.2.7 Let $A_j = \langle \xi_j, \varphi_j, \zeta_j \rangle \in \Lambda (j \in I_n) w = (w_1, w_2, \dots, w_n)^T$. Then *SVNS* hybrid ordered weighted geometric operator denoted by U_{hog} , is defined as;

$$U_{hog} : \Lambda^n \rightarrow \Lambda \quad U_{hog}(A_1, A_2, \dots, A_n) = \prod_{j=1}^n \bar{B}_j^{w_j}$$

where $w = (w_1, w_2, \dots, w_n)^T, w_j \in [0, 1]$ and $\sum_{j=1}^n w_j = 1$ is a weight vector associated with the mapping U_{hog} , $\bar{B}_j = n w A_j$ here n is regarded as a balance factor $\omega = (\omega_1, \omega_2, \dots, \omega_n)^T$ is a weight vector of the $A_j \in \Lambda (j \in I_n)$ \bar{B}_j is the k -th largest of the n *SVNS* $\hat{B}_j \in \Lambda (j \in I_n)$ which are determined through using some ranking method such as the above scoring function ranking method.

Note that if $\omega = (1/n, 1/n, \dots, 1/n)^T$, then U_{hog} degenerates to the U_{hog} :

Theorem 3.2.8 Let $A_j = \langle \xi_j, \varphi_j, \zeta_j \rangle \in \Lambda (j \in I_n) w = (w_1, w_2, \dots, w_n)^T$ be a weight vector of A_j with $w_j \in [0, 1]$ and $\sum_{j=1}^n w_j = 1$. Then their aggregated value by using U_{hog} operator is also a *SVNS* and $U_{hog} : \Lambda^n \rightarrow \Lambda$

$$U_{hog}(\bar{B}_1, \bar{B}_2, \dots, \bar{B}_n) = \left\langle \frac{\sum_{j=1}^n \bar{\xi}_{\bar{B}_j}^{w_j}}{2 - \left[\sum_{j=1}^n \bar{\xi}_{\bar{B}_j}^{w_j} - \prod_{j=1}^n \bar{\xi}_{\bar{B}_j}^{w_j} \right]}, \frac{\sum_{k=1}^n \bar{\varphi}_{\bar{B}_j}^{w_j}}{1 + \prod_{k=1}^n \bar{\varphi}_{\bar{B}_j}^{w_j}}, \frac{\sum_{k=1}^n \bar{\zeta}_{\bar{B}_j}^{w_j}}{1 + \prod_{k=1}^n \bar{\zeta}_{\bar{B}_j}^{w_j}} \right\rangle$$

where $\bar{B}_j = \langle \bar{\xi}_j, \bar{\varphi}_j, \bar{\zeta}_j \rangle$ is the k -th largest of the n *SVNS* $\hat{B}_j = n w A_j (j \in I_n)$ which is determined through using some ranking method such as the above scoring function ranking method.

Proof : Theorem 3.2.8 can be proven in a similar way to that of Theorem 3.2.2 (omitted).

Example 3.2.9 $A_1 = \langle 0.2, 0.7, 0.6 \rangle, A_2 = \langle 0.3, 0.5, 0.8 \rangle, A_3 = \langle 0.2, 0.9, 0.6 \rangle$ and $A_4 = \langle 0.2, 0.2, 0.4 \rangle w = (0.1, 0.5, 0.1, 0.3)^T \omega = (0.4, 0.2, 0.2, 0.2)$

$$\hat{B}_1 = 4 \times 0.4 A_1 = \langle 1 - (1 - 0.2)^{4 \times 0.4}, 0.7^{4 \times 0.4}, 0.6^{4 \times 0.4} \rangle = \langle 0.300, 0.565, 0.441 \rangle$$

$$\hat{B}_2 = 4 \times 0.2 A_2 = \langle 1 - (1 - 0.3)^{4 \times 0.2}, 0.5^{4 \times 0.2}, 0.8^{4 \times 0.2} \rangle = \langle 0.248, 0.574, 0.836 \rangle$$

$$\hat{B}_3 = 4 \times 0.2 A_3 = \langle 1 - (1 - 0.2)^{4 \times 0.2}, 0.9^{4 \times 0.2}, 0.6^{4 \times 0.2} \rangle = \langle 0.163, 0.919, 0.664 \rangle$$

$$\hat{B}_4 = 4 \times 0.2 A_4 = \langle 1 - (1 - 0.2)^{4 \times 0.2}, 0.2^{4 \times 0.2}, 0.4^{4 \times 0.2} \rangle = \langle 0.163, 0.275, 0.480 \rangle$$

we obtain the scores of the single-valued neutrosophic sets $\hat{B}_k (j = 1, 2, 3, 4)$ as follows:

$$s(A) = (T_A + 1 - I_A + 1 - F_A) / 3$$

$$\begin{aligned}
 s(\dot{B}_1) &= \frac{(0.300 + 1 - 0.565 + 1 - 0.441)}{3} = 0.431 \\
 s(\dot{B}_2) &= \frac{(0.248 + 1 - 0.574 + 1 - 0.836)}{3} = 0.279 \\
 s(\dot{B}_3) &= \frac{(0.163 + 1 - 0.919 + 1 - 0.664)}{3} = 0.193 \\
 s(\dot{B}_4) &= \frac{(0.163 + 1 - 0.275 + 1 - 0.480)}{3} = 0.469
 \end{aligned}$$

respectively. Obviously, $s(\dot{B}_4) > s(\dot{B}_1) > s(\dot{B}_2) > s(\dot{B}_3)$. Thereby, according to the above scoring function ranking method, we have:

$$\begin{aligned}
 \bar{B}_1 = \dot{B}_4 &= \langle 0.163, 0.275, 0.480 \rangle \\
 \bar{B}_2 = \dot{B}_1 &= \langle 0.300, 0.565, 0.441 \rangle \\
 \bar{B}_3 = \dot{B}_2 &= \langle 0.248, 0.574, 0.836 \rangle \\
 \bar{B}_4 = \dot{B}_3 &= \langle 0.163, 0.919, 0.664 \rangle
 \end{aligned}$$

$$U_{hog}(\bar{B}_1, \bar{B}_2, \dots, \bar{B}_n) = \left(\frac{\sum_{j=1}^n \bar{\xi}_{\bar{B}_j}^{w_j}}{2 - \left[\sum_{j=1}^n \bar{\xi}_{\bar{B}_j}^{w_j} - \prod_{j=1}^n \bar{\xi}_{\bar{B}_j}^{w_j} \right]}, \frac{\sum_{k=1}^n \bar{\varphi}_{\bar{B}_j}^{w_j}}{1 + \prod_{k=1}^n \bar{\varphi}_{\bar{B}_j}^{w_j}}, \frac{\sum_{k=1}^n \bar{\zeta}_{\bar{B}_j}^{w_j}}{1 + \prod_{k=1}^n \bar{\zeta}_{\bar{B}_j}^{w_j}} \right)$$

$$\begin{aligned}
 &U_{hog}(\bar{B}_1, \bar{B}_2, \bar{B}_3, \bar{B}_4) \\
 &= \left(\frac{0.163^{0.1} + 0.300^{0.5} + 0.248^{0.1} + 0.163^{0.3}}{2 - [(0.163^{0.1} + 0.300^{0.5} + 0.248^{0.1} + 0.163^{0.3}) - (0.163^{0.1} \times 0.300^{0.5} \times 0.248^{0.1} \times 0.163^{0.3})]}, \frac{0.275^{0.1} + 0.565^{0.5} + 0.574^{0.1} + 0.919^{0.3}}{1 + 0.275^{0.1} \times 0.565^{0.5} \times 0.574^{0.1} \times 0.919^{0.3}}, \frac{0.480^{0.1} + 0.441^{0.5} + 0.836^{0.1} + 0.664^{0.3}}{1 + 0.480^{0.1} \times 0.441^{0.5} \times 0.836^{0.1} \times 0.664^{0.3}} \right) \\
 &= \langle -4.705, 2.206, 2.252 \rangle
 \end{aligned}$$

Section4. Single valued neutrosophic sets and their applications in multi-criteria groupdecision-making problems

There is a panel with four possible alternatives to invest the money (adapted from Herrera 2000): (1) x_1 is a car company; (2) x_2 is a food company; (3) x_3 is a computer company; (4) x_4 is a television company. The investment Company must take a decision according to the following three criteria: (1) u_1 is the risk analysis; (2) u_2 is the growth analysis; (3) u_3 is the environmental impact analysis; (4) u_4 social political impact analysis. The four possible alternatives are to be evaluated under the above three criteria by corresponding to linguistic values of SVNNSs for linguistic terms (adapted from Ye 2011), as shown in Table 1.

	u_1	u_2	u_3	u_4
x_1	$\langle 0.3, 0.2, 0.5 \rangle$	$\langle 0.1, 0.5, 0.7 \rangle$	$\langle 0.7, 0.1, 0.8 \rangle$	$\langle 0.4, 0.2, 0.5 \rangle$
x_2	$\langle 0.2, 0.7, 0.6 \rangle$	$\langle 0.3, 0.5, 0.8 \rangle$	$\langle 0.2, 0.9, 0.6 \rangle$	$\langle 0.2, 0.2, 0.4 \rangle$
x_3	$\langle 0.4, 0.5, 0.6 \rangle$	$\langle 0.8, 0.9, 0.3 \rangle$	$\langle 0.8, 0.5, 0.3 \rangle$	$\langle 0.7, 0.6, 0.5 \rangle$
x_4	$\langle 0.2, 0.4, 0.3 \rangle$	$\langle 0.7, 0.2, 0.9 \rangle$	$\langle 0.5, 0.4, 0.7 \rangle$	$\langle 0.6, 0.4, 0.5 \rangle$

Definition 4.1 :Let $X = (x_1, x_2, \dots, x_m)$ be a set of alternatives, $U = (u_1, u_2, \dots, u_n)$ be the set of attributes. If $a_{ij} = \langle \xi_{ij}, \varphi_{ij}, \zeta_{ij} \rangle \in A$, then

$$[a_{ij}]_{m \times n} = \begin{matrix} & u_1 & u_2 & \dots & u_n \\ \begin{matrix} x_1 \\ x_2 \\ \vdots \\ x_n \end{matrix} & \begin{pmatrix} a_{11} & a_{12} & \dots & a_{1n} \\ a_{21} & a_{22} & \dots & a_{2n} \\ \vdots & \vdots & \vdots & \vdots \\ a_{n1} & a_{n2} & \dots & a_{nn} \end{pmatrix} \end{matrix}$$

is called an SVNS-multi-criteria decision-making matrix of the decision maker.

Now, we can give an algorithm of the **SVNSs**-multi-criteria decision-making method as follows;

Algorithm:

Step 1. Construct the decision-making matrix $[a_{ij}]_{m \times n}$ for decision;

Step 2. Compute the **SVNSs** $\psi_{oo}(A_1, A_2, \dots, A_n) = \left(\frac{\sum_{j=1}^n \xi_{A_j}^{w_j}}{1 + \prod_{j=1}^n \xi_{A_j}^{w_j}}, \frac{\sum_{j=1}^n \varphi_{A_j}^{w_j}}{2 - [\sum_{j=1}^n \varphi_{A_j}^{w_j} - \prod_{j=1}^n \varphi_{A_j}^{w_j}]}, \frac{\sum_{j=1}^n \zeta_{A_j}^{w_j}}{2 - [\sum_{j=1}^n \zeta_{A_j}^{w_j} - \prod_{j=1}^n \zeta_{A_j}^{w_j}]} \right)$ and write the decision-making matrix $[A_{ij}]_{m \times n}$; and obtain the scores of the **SVNSs** $\psi_{oo}(A_1, A_2, \dots, A_n)$;

Step 3. Compute the **SVNSs** $\psi_{ooo}(B_1, B_2, \dots, B_n) = \left(\frac{\sum_{j=1}^n \xi_{B_j}^{w_j}}{1 + \prod_{j=1}^n \xi_{B_j}^{w_j}}, \frac{\sum_{j=1}^n \varphi_{B_j}^{w_j}}{2 - [\sum_{j=1}^n \varphi_{B_j}^{w_j} - \prod_{j=1}^n \varphi_{B_j}^{w_j}]}, \frac{\sum_{j=1}^n \zeta_{B_j}^{w_j}}{2 - [\sum_{j=1}^n \zeta_{B_j}^{w_j} - \prod_{j=1}^n \zeta_{B_j}^{w_j}]} \right)$ and write the decision-making matrix $[A_{ij}]_{m \times n}$; and obtain the scores of the **SVNSs** $\psi_{ooo}(B_1, B_2, \dots, B_n)$;

Step 4. Compute the **SVNSs** $\psi_{hoo}(\bar{B}_1, \bar{B}_2, \dots, \bar{B}_n) = \left(\frac{\sum_{j=1}^n \xi_{\bar{B}_j}^{w_j}}{1 + \prod_{j=1}^n \xi_{\bar{B}_j}^{w_j}}, \frac{\sum_{j=1}^n \varphi_{\bar{B}_j}^{w_j}}{2 - [\sum_{j=1}^n \varphi_{\bar{B}_j}^{w_j} - \prod_{j=1}^n \varphi_{\bar{B}_j}^{w_j}]}, \frac{\sum_{j=1}^n \zeta_{\bar{B}_j}^{w_j}}{2 - [\sum_{j=1}^n \zeta_{\bar{B}_j}^{w_j} - \prod_{j=1}^n \zeta_{\bar{B}_j}^{w_j}]} \right)$ and write the decision-making matrix $[A_{ij}]_{m \times n}$; and obtain the scores of the **SVNSs** $\psi_{hoo}(\bar{B}_1, \bar{B}_2, \dots, \bar{B}_n)$;

Step 5. Compute the **SVNSs** $U_{oo}(A_1, A_2, \dots, A_n) = \left(\frac{\sum_{j=1}^n \xi_{A_j}^{w_j}}{2 - [\sum_{j=1}^n \xi_{A_j}^{w_j} - \prod_{j=1}^n \xi_{A_j}^{w_j}]}, \frac{\sum_{j=1}^n \varphi_{A_j}^{w_j}}{1 + \prod_{j=1}^n \varphi_{A_j}^{w_j}}, \frac{\sum_{j=1}^n \zeta_{A_j}^{w_j}}{1 + \prod_{j=1}^n \zeta_{A_j}^{w_j}} \right)$ then, write the decision-making matrix $[A_{ij}]_{m \times n}$; and obtain the scores of the **SVNSs** $U_{oo}(A_1, A_2, \dots, A_n)$;

Step 6. Compute the **SVNSs** $U_{ooo}(B_1, B_2, \dots, B_n) = \left(\frac{\sum_{j=1}^n \xi_{B_j}^{w_j}}{2 - [\sum_{j=1}^n \xi_{B_j}^{w_j} - \prod_{j=1}^n \xi_{B_j}^{w_j}]}, \frac{\sum_{j=1}^n \varphi_{B_j}^{w_j}}{1 + \prod_{j=1}^n \varphi_{B_j}^{w_j}}, \frac{\sum_{j=1}^n \zeta_{B_j}^{w_j}}{1 + \prod_{j=1}^n \zeta_{B_j}^{w_j}} \right)$

then, write the decision-making matrix $[A_{ij}]_{m \times n}$; and obtain the scores of the **SVNSs** $U_{ooo}(B_1, B_2, \dots, B_n)$;

Step 7. Compute the **SVNSs** $U_{hoo}(\bar{B}_1, \bar{B}_2, \dots, \bar{B}_n) = \left(\frac{\sum_{j=1}^n \xi_{\bar{B}_j}^{w_j}}{2 - [\sum_{j=1}^n \xi_{\bar{B}_j}^{w_j} - \prod_{j=1}^n \xi_{\bar{B}_j}^{w_j}]}, \frac{\sum_{k=1}^n \varphi_{\bar{B}_j}^{w_j}}{1 + \prod_{k=1}^n \varphi_{\bar{B}_j}^{w_j}}, \frac{\sum_{k=1}^n \zeta_{\bar{B}_j}^{w_j}}{1 + \prod_{k=1}^n \zeta_{\bar{B}_j}^{w_j}} \right)$

then, write the decision-making matrix $[A_{ij}]_{m \times n}$; and obtain the scores of the **SVNSs** $U_{hoo}(\bar{B}_1, \bar{B}_2, \dots, \bar{B}_n)$;

Step 8. Rank all alternatives x_i by using the ranking method of *SVNSs* and determine the best alternative.

Section 5. Application

In this section, we give an application for the *SVNSs* -multi-criteria decision-making method, by using the G_{HGO} operator. Some of it is quoted from application in (Deli 2015, Herrera 2000, Ye 2011).

Example 5.1 Let us consider the decision-making problem adapted from (Ye 2015). There is an investment company, which wants to invest a sum of money in the best option. There is a panel with the set of the four alternatives is denoted by $X =$

$\{x_1 = \text{car company}, x_2 = \text{food company}, x_3 = \text{computer company}, x_4 = \text{television company}\}$

to invest the money. The investment company must take a decision according to the set of the four attributes is denoted by $U = \{u_1 = \text{risk analysis}, u_2 = \text{growth analysis}, u_3 = \text{environmental impact analysis}, u_4 = \text{social political impact analysis}\}$. Then, the weight vector of the attributes is $\omega = (0.1, 0.2, 0.3, 0.4)^T$ and the position weight vector is $w = (0.3, 0.4, 0.1, 0.2)^T$ by using the weight determination based on the normal distribution. For the evaluation of an alternative x_i ($i = 1, 2, 3, 4$) with respect to a criterion u_j ($j = 1, 2, 3, 4$), it is obtained from the questionnaire of a domain expert. Then,

Step 1. The decision maker construct the decision matrix $[a_{ij}]_{4 \times 4}$ as follows:

$$[a_{ij}]_{m \times n} = \begin{matrix} & u_1 & u_2 & u_3 & u_4 \\ \begin{matrix} x_1 \\ x_2 \\ x_3 \\ x_4 \end{matrix} & \begin{pmatrix} 0.3 & 0.2 & 0.5 & 0.1 & 0.5 & 0.7 & 0.7 & 0.1 & 0.8 & 0.4 & 0.2 & 0.5 \\ 0.2 & 0.7 & 0.6 & 0.3 & 0.5 & 0.8 & 0.2 & 0.9 & 0.6 & 0.2 & 0.2 & 0.4 \\ 0.4 & 0.5 & 0.6 & 0.8 & 0.9 & 0.3 & 0.8 & 0.5 & 0.3 & 0.7 & 0.6 & 0.5 \\ 0.2 & 0.4 & 0.3 & 0.7 & 0.2 & 0.9 & 0.5 & 0.4 & 0.7 & 0.6 & 0.4 & 0.5 \end{pmatrix} \end{matrix}$$

Step 2. The values of $\psi_{\alpha\alpha\alpha}(A_1, A_2, \dots, A_n)$ are compute with the help of single-valued neutrosophic weighted arithmetic operator.

$$[A_{ij}]_{4 \times 4} = \begin{matrix} x_1 \\ x_2 \\ x_3 \\ x_4 \end{matrix} \begin{pmatrix} 2.365 & -4.632 & -3.800 \\ 2.275 & -3.820 & -3.804 \\ 2.194 & -3.793 & -3.924 \\ 2.288 & -4.168 & -3.754 \end{pmatrix}$$

The score function values of x_1, x_2, x_3 and x_4 are calculated.

$$s(A) = \frac{T_A + 1 - I_A + 1 - F_A}{3}$$

$$s(x_1) = \frac{2.365 + 1 - (-4.632) + 1 - (-3.800)}{3} = 4.265$$

$$s(x_2) = \frac{2.275 + 1 - (-3.820) + 1 - (-3.804)}{3} = 3.966$$

$$s(x_3) = \frac{2.194 + 1 - (-3.793) + 1 - (-3.924)}{3} = 3.970$$

$$s(x_4) = \frac{2.288 + 1 - (-4.168) + 1 - (-3.754)}{3} = 4.070$$

$$s(x_1) > s(x_4) > s(x_3) > s(x_2)$$

Step 3. The values of $\psi_{ooo}(A_1, A_2, \dots, A_n)$ are compute with the help of single-valued neutrosophic ordered weighted arithmetic operator.

$$\begin{matrix} x_1 \\ x_2 \\ x_3 \\ x_4 \end{matrix} \begin{pmatrix} 2.305 & -4.967 & -3.778 \\ 2.275 & -3.783 & -3.787 \\ 2.176 & -3.802 & -3.949 \\ 2.221 & -4.168 & -3.794 \end{pmatrix}$$

The score function values of x_1, x_2, x_3 and x_4 are calculated.

$$s(x_1) = 4.350$$

$$s(x_2) = 3.949$$

$$s(x_3) = 3.976$$

$$s(x_4) = 4.061$$

$$s(x_1) > s(x_4) > s(x_3) > s(x_2)$$

Step 4. The values of $\psi_{oooo}(A_1, A_2, \dots, A_n)$ are compute with the help of the Single-valued neutrosophic sets hybrid ordered weighted arithmetic operator(SVNSHOWA).

$$\begin{matrix} x_1 \\ x_2 \\ x_3 \\ x_4 \end{matrix} \begin{pmatrix} 2.301 & -5.279 & -3.754 \\ 2.267 & -3.715 & -3.720 \\ 2.208 & -3.774 & -3.970 \\ 2.299 & -4.086 & -3.779 \end{pmatrix}$$

The score function values of x_1, x_2, x_3 and x_4 are calculated.

$$s(x_1) = 4.445$$

$$s(x_2) = 3.901$$

$$s(x_3) = 3.984$$

$$s(x_4) = 4.055$$

$$s(x_1) > s(x_4) > s(x_3) > s(x_2)$$

Step 5. The values of $U_{ogo}(A_1, A_2, \dots, A_n)$ are compute with the help of single-valued neutrosophic weighted geometric operator.

$$\begin{matrix} x_1 \\ x_2 \\ x_3 \\ x_4 \end{matrix} \begin{pmatrix} -4.319 & 2.280 & 2.205 \\ -4.882 & 2.264 & 2.193 \\ -3.769 & 2.178 & 2.294 \\ -3.819 & 2.325 & 2.236 \end{pmatrix}$$

The score function values of x_1, x_2, x_3 and x_4 are calculated.

$$\begin{aligned} s(x_1) &= -2.268 \\ s(x_2) &= -2.446 \\ s(x_3) &= -2.080 \\ s(x_4) &= -2.126 \end{aligned}$$

$$s(x_3) > s(x_4) > s(x_1) > s(x_2)$$

Step 6. The values of $\bar{U}_{oggo}(A_1, A_2, \dots, A_n)$ are compute with the help of single-valued neutrosophic ordered weighted geometric operator.

$$\begin{matrix} x_1 \\ x_2 \\ x_3 \\ x_4 \end{matrix} \begin{pmatrix} -4.086 & 2.299 & 2.201 \\ -4.882 & 2.301 & 2.210 \\ -3.792 & 2.230 & 2.280 \\ -3.848 & 2.325 & 2.184 \end{pmatrix}$$

The score function values of x_1, x_2, x_3 and x_4 are calculated.

$$\begin{aligned} s(x_1) &= -2.195 \\ s(x_2) &= -2.464 \\ s(x_3) &= -2.097 \\ s(x_4) &= -2.119 \end{aligned}$$

$$s(x_3) > s(x_4) > s(x_1) > s(x_2)$$

Step 7. The values of $\bar{U}_{oggo}(A_1, A_2, \dots, A_n)$ are compute with the help of single-valued neutrosophic hybrid ordered weighted geometric operator.

$$\begin{matrix} x_1 \\ x_2 \\ x_3 \\ x_4 \end{matrix} \begin{pmatrix} -4.014 & 2.326 & 2.219 \\ -5.132 & 2.377 & 2.254 \\ -3.739 & 2.251 & 2.317 \\ -3.837 & 2.312 & 2.240 \end{pmatrix}$$

The score function values of x_1, x_2, x_3 and x_4 are calculated.

$$\begin{aligned} s(x_1) &= -2.187 \\ s(x_2) &= -2.588 \\ s(x_3) &= -2.102 \\ s(x_4) &= -2.130 \end{aligned}$$

$$s(x_3) > s(x_4) > s(x_1) > s(x_2)$$

Step 8.

Operators	
$\psi_{go}(A_1, A_2, A_3, A_4)$	$s(x_1) > s(x_4) > s(x_3) > s(x_2)$
$\psi_{ogo}(A_1, A_2, A_3, A_4)$	$s(x_1) > s(x_4) > s(x_3) > s(x_2)$
$\psi_{hog}(A_1, A_2, A_3, A_4)$	$s(x_1) > s(x_3) > s(x_2) > s(x_4)$
$U_{go}(A_1, A_2, A_3, A_4)$	$s(x_3) > s(x_4) > s(x_1) > s(x_2)$
$U_{ogo}(A_1, A_2, A_3, A_4)$	$s(x_3) > s(x_4) > s(x_1) > s(x_2)$
$U_{hog}(A_1, A_2, A_3, A_4)$	$s(x_3) > s(x_1) > s(x_4) > s(x_2)$

Section 6. FUTURE RESEARCH DIRECTIONS

In this paper, this article introduces an approach to handle multi-criteria decision making (MCDM) problems under the SVNNSs. Using this concept we can extend our work in (1) More effective approaches for SVNNSs (2) How to determine the weight vectors for SVNNSs (3) An approach of multi-criteria decision making with weight expressed by SVNNSs.

Section 7. Conclusion

This paper proposes six operator are called the single valued neutrosophic weighted geometric (SVNWG) operator, the single valued neutrosophic ordered weighted geometric (SVNOWG) operator, the single-valued neutrosophic sets hybrid ordered weighted arithmetic (SVNSHOWA) operator, the single-valued neutrosophic weighted geometric (SVNWG) operator , the single-valued neutrosophic ordered weighted geometric(SVNOWG) operator and the single-valued neutrosophic hybrid ordered weighted geometric (SVNHOG)operator. Then an approach is developed to solve more general multi-criteria decision making problems as straightforward manner.

ACKNOWLEDGMENT

We thank both editors for their useful suggestions.

REFERENCES

Atanassov, K. Intuitionistic fuzzy sets, *Fuzzy Sets and Systems*, 20 (1986) 87-96.
 Broumi, S. I. Deli, F. Smarandache, Relations on Interval Valued Neutrosophic Soft Sets, *Journal of New Results in Science* 5 (2014a) 01-20.
 Broumi, S. I. Deli, F. Smarandache, Interval valued neutrosophic parameterized soft set theory and its decision making, *Journal of New Results in Science* 7 (2014b) 58-71.
 Broumi, S., &Smarandache, F. (2015). Single valued neutrosophic soft expert sets and their application in decision making. *Journal of New Theory*, 3, 67-88.

- Broumi, S., & Smarandache, F. (2015). Possibility Single Valued Neutrosophic Soft Expert Sets and Its Application In Decision Making. *Journal of New Theory*, 4, 06-29.
- Broumi, S., Mumtaz, A., & Smarandache, F. (2015). Mappings on Neutrosophic Soft Expert Sets. *Journal of New Theory*, 5, 26-42.
- Broumi, S, M. Talea, A. Bakali, F. Smarandache,(2016). "Single Valued Neutrosophic Graphs," *Journal of New Theory*, N 10, pp. 86-101.
- Broumi, S, M. Talea, A. Bakali, F. Smarandache, (2016) "On Bipolar Single Valued Neutrosophic Graphs," *Journal of New Theory*, N11, pp.84-102.
- Broumi, S, A. Bakali, M, Talea, and F, Smarandache, (2016). Isolated Single Valued Neutrosophic Graphs. *Neutrosophic Sets and Systems*, Vol. 11, pp.74-78.
- Broumi, S, F. Smarandache, M. Talea and A. Bakali,(2016). An Introduction to Bipolar Single Valued Neutrosophic Graph Theory. *Applied Mechanics and Materials*, vol.841,184-191.
- Broumi, S, M. Talea, F. Smarandache and A. Bakali, (2016). Single Valued Neutrosophic Graphs: Degree, Order and Size. *IEEE World Congress on Computational Intelligence*, pp. 2444-2451.
- Chi PP, Liu PD. An extended TOPSIS method for multiple attribute decision making problems based on interval neutrosophic set. *Neutrosophic Sets and Systems* (2013); 1: 63–70.
- Deli, I., & Şubaş, Y. (2015). Some weighted geometric operators with SVTrN-numbers and their application to multi-criteria decision making problems. *Journal of Intelligent & Fuzzy Systems*, (Preprint), 1-11.
- He, Y. H. Chen, L. Zhou, B. Han, Q. Zhao, J. Liu, Generalized intuitionistic fuzzy geometric interaction operators and their application to decision making, *Expert Systems with Applications* 41 (2014a) 2484-2495.
- He, Y. H. Chen, L. Zhou, B. Han, Q. Zhao, J. Liu, Generalized intuitionistic fuzzy geometric interaction operators and their application to decision making, *Expert Systems with Applications* 41 (2014b) 2484- 2495.
- He, Y. H. Chen, L. Zhou, J. Liu, Z. Tao, Intuitionistic fuzzy geometric interaction averaging operators and their application to multi-criteria decision making, *Information Sciences* 259 (2014c) 142-159.
- Herrera, F. E. H. Viedma, Linguistic decision analysis: steps for solving decision problems under linguistic information, *Fuzzy Sets and Systems* 115 (2000) 67-82.
- Ju YB. Some aggregation operators with single valued neutrosophic information and their application to multiple attribute decision making. Technical Report 2014.
- Kandasamy, I., & Smarandache, F. (2017). Multicriteria Decision Making Using Double Refined Indeterminacy Neutrosophic Cross Entropy and Indeterminacy Based Cross Entropy. In *Applied Mechanics and Materials* (Vol. 859, pp. 129-143). Trans Tech Publications.
- Li, D.-F., Wu, Z.Q.: Generalized OWA operator based methodology for multiattribute decision-making using intuitionistic fuzzy sets. *Crit. View* 4, 13–34 (2010b)
- Li, D.-F.: The GOWA operator based approach to multiattribute decision-making using intuitionistic fuzzy sets. *Math. Comput. Modell.* 53(5–6), 1182–1196 (2011)
- Li, D.-F.: Multiattribute decision-making method based on generalized OWA operators with intuitionistic fuzzy sets. *Expert Syst. Appl.* 37(12), 8673–8678 (2010a)
- Li, D.-F., Wang, L.L., Chen, G.H.: Group decision-making methodology based on the Atanassov's intuitionistic fuzzy set generalized OWA operator. *Int. J. Uncertainty Fuzziness and Knowl. Based Syst.* 18(6), 801–817 (2010)
- Lin, J., & Zhang, Q. (2017). Note on continuous interval-valued intuitionistic fuzzy aggregation operator. *Applied Mathematical Modelling*, 43, 670-677

- Liu, P., & Li, D. (2017a). Some Muirhead Mean Operators for Intuitionistic Fuzzy Numbers and Their Applications to Group Decision Making. *PloS one*, 12(1), e0168767.
- Liu, P., & Li, H. (2017b). Multiple attribute decision-making method based on some normal neutrosophic Bonferroni mean operators. *Neural Computing and Applications*, 28(1), 179-194.
- Liu, C., & Luo, Y. (2017c). Power aggregation operators of simplified neutrosophic sets and their use in multi-attribute group decision making. *IEEE/CAA Journal of Automatica Sinica*.
- Smarandache, F. (1998). A unifying field in logics. Neutrosophy: Neutrosophic probability, set and logic. Rehoboth, DE: AmericanResearch Press.
- Şahin, M., Alkhalaf, S., & Uluçay, V. (2015). Neutrosophic soft expert sets. *Applied Mathematics*, 6(01), 116.
- Şahin, M., Deli, I., & Uluçay, V. Jaccard Vector Similarity Measure of Bipolar Neutrosophic Set Based on Multi-Criteria Decision Making. International Conference on Natural Science and Engineering (ICNASE'16) Kilis, Türkiye.
- Wang, S.Q., Li, D.-F., Wu, Z.Q.: Generalized ordered weighted averaging operators based methods for MADM in intuitionistic fuzzy set setting. *J. Syst. Eng. Electron.* 20(6), 1247–1254 (2009)
- Wang H, Smarandache F, Zhang YQ. Single valued neutrosophic sets. *MultispaceMultistruct* 2010; 4: 410–3.
- Wei, G. Some induced geometric aggregation operators with intuitionistic fuzzy information and their application to group decision making, *Applied Soft Computing* 10 (2010) 423-431.
- Xu, Z., R. R. Yager, Some geometric aggregation operators based on intuitionistic fuzzy sets, *International Journal of General Systems*, 35(4) (2006), 417433.
- Uluçay, V., Deli, I., & Şahin, M. (2016). Similarity measures of bipolar neutrosophic sets and their application to multiple criteria decision making. *Neural Computing and Applications*, 1-10.
- Uluçay, V., Deli, I., & Şahin, M. (2016). Trapezoidal fuzzy multi-number and its application to multi-criteria decision-making problems. *Neural Computing and Applications*, 1-10.
- Ye, J. Expected value method for intuitionistic trapezoidal fuzzy multicriteria decision-making problems, *Expert Systems with Applications* 38 (2011) 11730-11734.
- Ye, J. (2015). Trapezoidal neutrosophic set and its application to multiple attribute decision-making. *Neural Computing and Applications*, 26(5), 1157-1166.
- Ye J. A Single valued neutrosophic cross-entropy for multi-criteria decision making problems. *Appl Math Model* 2014; 38: 1170–5.
- Ye J, Multiple attribute group decision-making method with completely unknown weights based on similarity measures under single valued neutrosophic environment, *J Intell Fuzzy Syst* 2014; DOI: 10.3233/IFS-141252.
- Zadeh, L.A. Fuzzy Sets, *Information and Control*, 8, 338-353, 1965.

Multi-attribute Group decision Making Based on Expected Value of Neutrosophic Trapezoidal Numbers

Pranab Biswas¹, Surapati Pramanik², Bibhas C. Giri³

¹Department of Mathematics, Jadavpur University, Kolkata, 700032, India,

Email: paldam2010@gmail.com

²Department of Mathematics, Nandalal Ghosh B.T. College, Panpur, Narayanpur, 743126, India,

Email: sura_pati@yahoo.co.in.

³Department of Mathematics, Jadavpur University, Kolkata, 700032, India,

Email: bcgiri.jumath@gmail.com

ABSTRACT

We present an expected value based method for multiple attribute group decision making (MAGDM), where the preference values of alternatives and the importance of attributes are expressed in terms of neutrosophic trapezoidal numbers (NTrNs). First, we introduce an expected value formula for NTrNs to be used in MAGDM. Second, we determine the expected values of aggregated rating values and expected weight values of attributes, which are given by the decision makers. Third, we determine the weighted expected value of each alternative to rank the given alternatives and chose the desired alternative. Finally, we provide a numerical example to illustrate the validity and effectiveness of the proposed approach.

KEYWORDS: Trapezoidal fuzzy number, Neutrosophic trapezoidal number, Expected value of neutrosophic trapezoidal number, Multi-attribute group decision making

1 INTRODUCTION

Multi-attribute decision making (MADM) is an important part in the theory of decision making problems. In this method, we determine the best one from the set of possible alternatives after considering qualitative or quantitative assessment of finite conflicting attributes. Several methods for solving MADM such as TOPSIS (Hwang & Yoon, 2012), GRA (Deng, 1989; Li, Yamaguchi, & Nagai, 2007; Olson & Wu, 2006), AHP (Boucher & MacStravic, 1991; Saaty, 1980, 1994), VIKOR (Opricovic, 1998), ELECTREE (Roy, 1991) have been

developed in crisp environment. However, decision makers cannot always evaluate the performance of alternatives with crisp numbers due to insufficient knowledge of the problem, or inability to explain directly the performance of one alternative over the others. This issue has motivated us to extend the MADM problems with imprecise environment. Fuzzy sets (Zadeh, 1965), intuitionistic fuzzy sets (Atanassov, 1986), interval valued fuzzy sets (Turksen, 1986), hesitant fuzzy sets (Torra, 2010) have been proved as the effective tools to model MADM in imprecise or vague environment although these sets cannot represent incomplete, inconsistent and indeterminate information that we often face in decision making problems. Neutrosophic set (Smarandache, 1998) captures all these types of information. This set represents each element of universe with three independent membership functions: truth membership function, indeterminacy membership function, and falsity membership function. Single valued neutrosophic set (SVNS) (Wang, Smarandache, Zhang, & Sundaraman, 2010), an instance of neutrosophic set, can effectively handle uncertain information existing in the real world problems.

Recently, researchers have found the potentiality of SVNS and shown an increased interest about MADM problem under neutrosophic environment. Peng, Wang, Zhang, and Chen (2014) proposed outranking method for solving multi-criteria decision making problems (MCDM) under simplified neutrosophic environment. Ye (2014b) introduced some vector similarity measures of simplified neutrosophic sets. Pramanik, Biswas, and Giri (2017) extended vector similarity measure to hybrid vector similarity measure of single valued and interval neutrosophic sets to study MADM problem. Mondal and Pramanik (2015) proposed tangent similarity measure for SVNSs and applied it to MADM. Biswas, Pramanik, and Giri (2014a) proposed entropy based grey relational analysis method for MADM with SVNSs. Biswas, Pramanik, and Giri (2014b) further studied grey relational analysis for neutrosophic MADM problems in which the weight of attribute is partially known or completely unknown. Biswas, Pramanik, and Giri (2016a) developed a TOPSIS method for neutrosophic MAGDM problem, where decision maker's weight, attribute's weight and rating values of alternatives are represented in terms of SVNSs. Biswas, Pramanik, and Giri (2017) further developed a non-linear programming based TOPSIS method for MAGDM problem under SVNS environment. Şahin and Liu (2015) put forward maximum deviation method to determine weight of attributes and then solve neutrosophic MADM. In addition, different aggregation operators of neutrosophic sets (Liu, Chu, Li, & Chen, 2014; Liu & Wang, 2014; Peng, Wang, Wang, Zhang, & Chen, 2016; Ye, 2014a) have also been developed to solve MADM.

However in MADM, the domain of single-valued neutrosophic set is discrete set. A fuzzy number (Dubois & Prade, 1987) is expressed with imprecise value rather than exact numerical values. Fuzzy numbers are considered as a connected set of possible values, where each value is characterized by membership degree, which lies between zero and one. The main advantage of fuzzy number is that it depicts the physical world more realistically than

crisp numbers. Therefore to represent the physical universe with a degree of inherent uncertainty, we consider truth, indeterminacy and falsity membership functions of SVNSs with a triad of connected set of possible values rather than triad of crisp numbers. Recently neutrosophic numbers has received little attention to the researchers, and several definitions of single-valued neutrosophic numbers have been proposed. Ye (2015) proposed trapezoidal neutrosophic sets, and defined score function, accuracy functions, and two aggregation operators for trapezoidal neutrosophic sets. Biswas, Pramanik, and Giri (2015) defined cosine similarity measure and relative expected value of trapezoidal neutrosophic sets for MADM problem. Biswas, Pramanik, and Giri (2016b) introduced single-valued neutrosophic trapezoidal numbers, where each of truth, indeterminacy and falsity membership functions has been considered with trapezoidal fuzzy numbers. They (Biswas et al., 2016b) developed a value and ambiguity index based ranking method to compare neutrosophic trapezoidal numbers used in MADM problems. Deli and Şubaş (2017) introduced neutrosophic trapezoidal number (NTrNs) by assigning a set of four consecutive elements characterized by truth, indeterminacy and falsity membership degrees. and proposed a value and ambiguity index based ranking method to compare single-valued neutrosophic trapezoidal numbers.

Furthermore, the method of expected value is also used to rank fuzzy numbers and intuitionistic fuzzy numbers. Heilpern (1992) proposed the expected value for fuzzy number, and thereafter He and Wang (2009) extended expected value method to MADM with fuzzy data. Grzegorzewski (2003) put forward the expected value and ordering method for intuitionistic fuzzy numbers. Ye (2011) extended the method of expected value for intuitionistic trapezoidal fuzzy MCDM problems. The intuitionistic trapezoidal fuzzy number (Nehi, 2010) has two parts: membership function and non-membership functions expressed by trapezoidal fuzzy numbers. Because indeterminacy is a common issue in decision making problems, extension of the Ye's method (Ye, 2011) is required to deal the issue in multi-attribute decision making problems. There is a little research about neutrosophic trapezoidal number and thus more research is needed for MADM under NTrNs.

Literature review reflects that no research has been carried out on expected value method for MADM under NTrNs. To bridge the gap, we first propose expected value of neutrosophic trapezoidal numbers to order NTrNs. Then we develop an expected value based novel method for neutrosophic trapezoidal MAGDM. We define formulas to determine the expected weight values of the attribute and weighted expected value for an alternative to determine the best alternative.

The remainder of the paper has been organized as follows. In Section 2, we review some basic notions of fuzzy set, trapezoidal fuzzy numbers, single-valued neutrosophic set, NTrN, and its some arithmetical operations. In Section 3, we introduce an expected value of NTrN and a ranking method among NTrNs. In section 4, we put forward expected value method to derive attribute weights and develop an approach to MAGDM with NTrN information.

Section 5 provides a numerical example to illustrate the developed approach, and finally, in Section 6, we conclude the paper with future direction of research.

2 PRELIMINARIES

In this section, we recall some basic notions of fuzzy sets, trapezoidal fuzzy numbers, single-valued neutrosophic sets, and single-valued neutrosophic trapezoidal numbers.

Definition 1. (Zadeh, 1965) A fuzzy set A in a universe of discourse X is defined by $A = \{ \langle x, \mu_A(x) \rangle | x \in X \}$, where, $\mu_A(x): X \rightarrow [0, 1]$ is called the membership function of A and the value of $\mu_A(x)$ is called the degree of membership for $x \in X$.

Definition 2. (Dubois & Prade, 1987; Kauffman & Gupta, 1991) A fuzzy number A is called a trapezoidal fuzzy number(TrFN) if its membership function is defined by

$$\mu_A(x) = \begin{cases} \mu_A^L(x) = \frac{x - a_1}{a_2 - a_1}, & a_1 \leq x \leq a_2 \\ 1, & a_2 \leq x \leq a_3 \\ \mu_A^U(x) = \frac{a_4 - x}{a_4 - a_3}, & a_3 \leq x \leq a_4 \\ 0, & otherwise. \end{cases}$$

The TrFN A is denoted by the quadruplet $A=(a_1, a_2, a_3, a_4)$, where a_1, a_2, a_3, a_4 are the real numbers and $a_1 \leq a_2 \leq a_3 \leq a_4$.

Definition 3. (Heilpern, 1992) Let $A = (a_1, a_2, a_3, a_4)$ be a trapezoidal fuzzy number in the set of real number \mathbb{R} . Then the expected interval and expected value of \tilde{A} are respectively

$$EI(A) = [E(A^L), E(A^U)] \quad \text{and} \quad EI(A) = (E(A^L) + E(A^U))/2 \quad (1)$$

where, $E(A^L) = a_2 - \int_{a_1}^{a_2} \mu_A^L(x) dx$ and $E(A^U) = a_4 + \int_{a_3}^{a_4} \mu_A^U(x) dx$

Definition 4. (Wang et al., 2010) A single valued neutrosophic set \tilde{A} in a universe of discourse X is given by

$$\tilde{A} = \left\{ \langle x, T_{\tilde{A}}(x), I_{\tilde{A}}(x), F_{\tilde{A}}(x) \rangle | x \in X \right\},$$

where, $T_{\tilde{A}}: X \rightarrow [0, 1]$, $I_{\tilde{A}}: X \rightarrow [0, 1]$ and $F_{\tilde{A}}: X \rightarrow [0, 1]$, with the condition

$$0 \leq T_{\tilde{A}}(x) + I_{\tilde{A}}(x) + F_{\tilde{A}}(x) \leq 3, \text{ for all } x \in X.$$

The numbers $T_{\tilde{A}}(x)$, $I_{\tilde{A}}(x)$ and $F_{\tilde{A}}(x)$ respectively represent the truth membership, indeterminacy membership and falsity membership degree of the element x to the set \tilde{A} . For convenience, we take the single valued neutrosophic set $A = \langle T_A(x), I_A(x), F_A(x) \rangle$.

Definition 5. (Biswas et al., 2016b) Let \tilde{A} be a neutrosophic trapezoidal number in the set of real numbers \mathbb{R} , then its truth membership function, indeterminacy membership function and falsity membership function are defined as

$$T_{\tilde{A}}(x) = \begin{cases} T_{\tilde{A}}^L(x), & a_{11} \leq x \leq a_{21}, \\ 1, & a_{21} \leq x \leq a_{31}, \\ T_{\tilde{A}}^U(x), & a_{31} \leq x \leq a_{41}, \\ 0, & \text{otherwise.} \end{cases} \quad I_{\tilde{A}}(x) = \begin{cases} I_{\tilde{A}}^L(x), & b_{11} \leq x \leq b_{21}, \\ 0, & b_{21} \leq x \leq b_{31}, \\ I_{\tilde{A}}^U(x), & b_{31} \leq x \leq b_{41}, \\ 1, & \text{otherwise,} \end{cases}$$

$$F_{\tilde{A}}(x) = \begin{cases} F_{\tilde{A}}^L(x), & c_{11} \leq x \leq c_{21}, \\ 0, & c_{21} \leq x \leq c_{31}, \\ F_{\tilde{A}}^U(x), & c_{31} \leq x \leq c_{41}, \\ 1, & \text{otherwise.} \end{cases}$$

The sum of three independent membership degrees of a single-valued neutrosophic set \tilde{A} lie between the interval $[0, 3]$ and $a_{11}, a_{21}, a_{31}, a_{41}, b_{11}, b_{21}, b_{31}, b_{41}, c_{11}, c_{21}, c_{31}$, and c_{41} belong to \mathbb{R} such that $a_{11} \leq a_{21} \leq a_{31} \leq a_{41}$, $b_{11} \leq b_{21} \leq b_{31} \leq b_{41}$, and $c_{11} \leq c_{21} \leq c_{31} \leq c_{41}$. The functions $T_{\tilde{A}}^L, I_{\tilde{A}}^L$, and $F_{\tilde{A}}^L$ are non-decreasing continuous functions and $T_{\tilde{A}}^U, I_{\tilde{A}}^U$, and $F_{\tilde{A}}^U$ are non-increasing continuous functions.

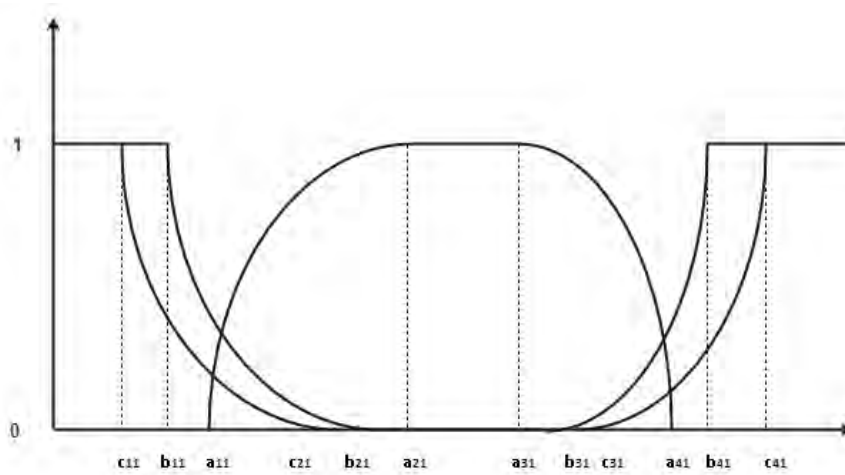

Figure 1: Neutrosophic number

Definition 6. (Biswas et al., 2016b) A neutrosophic trapezoidal number (NTrN) \tilde{A} is a set of twelve parameters satisfying the inequality $c_{11} \leq b_{11} \leq a_{11} \leq c_{21} \leq b_{21} \leq a_{21} \leq a_{31} \leq b_{31} \leq c_{31} \leq a_{41} \leq b_{41} \leq c_{41}$ and is denoted by $\tilde{A} = \langle (a_{11}, a_{21}, a_{31}, a_{41}), (b_{11}, b_{21}, b_{31}, b_{41}), (c_{11}, c_{21}, c_{31}, c_{41}) \rangle$ in the set of real numbers \mathbb{R} . Then the truth membership, the indetermi-

nacy membership and the falsity membership degree of \tilde{A} are defined as

$$T_{\tilde{A}}(x) = \begin{cases} \frac{x - a_{11}}{a_{21} - a_{11}}, & a_{11} \leq x \leq a_{21}, \\ 1, & a_{21} \leq x \leq a_{31}, \\ \frac{a_{41} - x}{a_{41} - a_{31}}, & a_{31} \leq x \leq a_{41}, \\ 0, & \text{otherwise.} \end{cases} \quad I_{\tilde{A}}(x) = \begin{cases} \frac{x - b_{21}}{b_{21} - b_{11}}, & b_{11} \leq x \leq b_{21}, \\ 0, & b_{21} \leq x \leq b_{31}, \\ \frac{x - b_{31}}{b_{41} - b_{31}}, & b_{31} \leq x \leq b_{41}, \\ 1, & \text{otherwise.} \end{cases}$$

$$F_{\tilde{A}}(x) = \begin{cases} \frac{x - c_{21}}{c_{21} - c_{11}}, & c_{11} \leq x \leq c_{21}, \\ 0, & c_{21} \leq x \leq c_{31}, \\ \frac{x - c_{31}}{c_{41} - c_{31}}, & c_{31} \leq x \leq c_{41}, \\ 1, & \text{otherwise.} \end{cases}$$

For $a_{21}=a_{31}$, $b_{21}=b_{31}$, and $c_{21}=c_{31}$ in a NTrN \tilde{A} , we get a new type of neutrosophic number and call it neutrosophic triangular number.

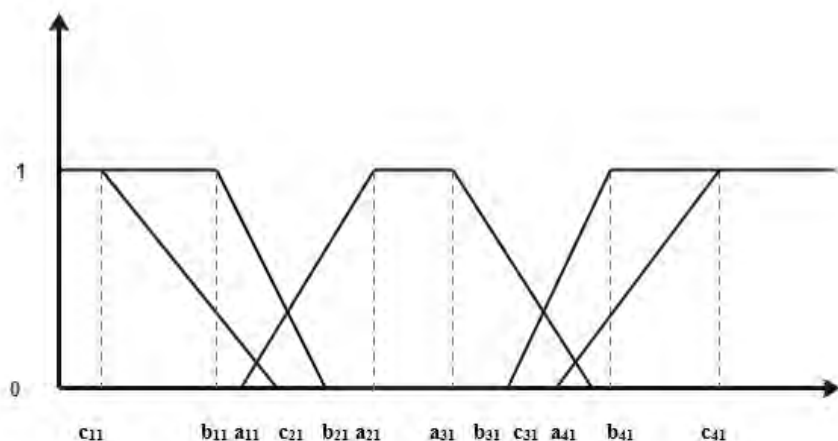

Figure 2: Neutrosophic trapezoidal number

Definition 7. (Biswas et al., 2016b) Let $\tilde{A} = \langle (a_{11}, a_{21}, a_{31}, a_{41}), (b_{11}, b_{21}, b_{31}, b_{41}), (c_{11}, c_{21}, c_{31}, c_{41}) \rangle$ and $\tilde{B} = \langle (a_{12}, a_{22}, a_{32}, a_{42}), (b_{12}, b_{22}, b_{32}, b_{42}), (c_{12}, c_{22}, c_{32}, c_{42}) \rangle$ be two NTrNs in the set of real numbers \mathbb{R} , then the following operations are valid:

1. $\tilde{A} \oplus \tilde{B} = \left\langle \begin{array}{l} (a_{11} + a_{12}, a_{21} + a_{22}, a_{31} + a_{32}, a_{41} + a_{42}), \\ (b_{11} + b_{12}, b_{21} + b_{22}, b_{31} + b_{32}, b_{41} + b_{42}), \\ (c_{11} + c_{12}, c_{21} + c_{22}, c_{31} + c_{32}, c_{41} + c_{42}) \end{array} \right\rangle,$
2. $\tilde{A} \otimes \tilde{B} = \left\langle \begin{array}{l} (a_{11}a_{12}, a_{21}a_{22}, a_{31}a_{32}, a_{41}a_{42}), \\ (b_{11}b_{12}, b_{21}b_{22}, b_{31}b_{32}, b_{41}b_{42}), \\ (c_{11}c_{12}, c_{21}c_{22}, c_{31}c_{32}, c_{41}c_{42}) \end{array} \right\rangle,$

3. $\lambda \tilde{A} = \left\langle \begin{array}{l} (\lambda a_{11}, \lambda a_{21}, \lambda a_{31}, \lambda a_{41}), (\lambda b_{11}, \lambda b_{21}, \lambda b_{31}, \lambda b_{41}), \\ (\lambda c_{11}, \lambda c_{21}, \lambda c_{31}, \lambda c_{41}) \end{array} \right\rangle$ for $\lambda > 0$,
4. $\tilde{A}^\lambda = \left\langle \begin{array}{l} (a_{11}^\lambda, a_{21}^\lambda, a_{31}^\lambda, a_{41}^\lambda), (b_{11}^\lambda, b_{21}^\lambda, b_{31}^\lambda, b_{41}^\lambda), \\ (c_{11}^\lambda, c_{21}^\lambda, c_{31}^\lambda, c_{41}^\lambda) \end{array} \right\rangle$ for $\lambda > 0$.

3 EXPECTED VALUE OF NEUTROSOPHIC TRAPEZOIDAL NUMBER

For a NTrN $\tilde{A} = \langle (a_{11}, a_{21}, a_{31}, a_{41}), (b_{11}, b_{21}, b_{31}, b_{41}), (c_{11}, c_{21}, c_{31}, c_{41}) \rangle$, we assume that $T_{\tilde{A}}^L(x) = \frac{x - a_{11}}{a_{21} - a_{11}}$ and $T_{\tilde{A}}^U(x) = \frac{x - a_{41}}{a_{31} - a_{41}}$ are the two sides of trapezoidal fuzzy number $T_{\tilde{A}}(x) = (a_{11}, a_{21}, a_{31}, a_{41})$ in \tilde{A} . Similarly, $I_{\tilde{A}}^L(x) = \frac{x - b_{21}}{b_{11} - b_{21}}$ and $I_{\tilde{A}}^U(x) = \frac{x - a_{31}}{a_{41} - a_{31}}$ are the two sides of trapezoidal fuzzy number $I_{\tilde{A}}(x) = (b_{11}, b_{21}, b_{31}, b_{41})$ and $F_{\tilde{A}}^L(x) = \frac{x - c_{21}}{c_{11} - c_{21}}$ and $F_{\tilde{A}}^U(x) = \frac{x - c_{31}}{c_{41} - c_{31}}$ are the two sides of trapezoidal fuzzy number $F_{\tilde{A}}(x) = (c_{11}, c_{21}, c_{31}, c_{41})$.

Definition 8. (Expected interval of a neutrosophic number)

The expected interval of a NTrN $\tilde{A} = \langle (a_{11}, a_{21}, a_{31}, a_{41}), (b_{11}, b_{21}, b_{31}, b_{41}), (c_{11}, c_{21}, c_{31}, c_{41}) \rangle$ is defined by

$$EI(\tilde{A}) = [E(\tilde{A}^L), E(\tilde{A}^U)]. \tag{2}$$

Here, the lower limit of expected interval for the functions $F_{\tilde{A}}^L(x)$, $I_{\tilde{A}}^L(x)$ and $T_{\tilde{A}}^L(x)$ is

$$\begin{aligned} E(\tilde{A}^L) &= \frac{1}{3} \left[\left(c_{11} - \int_{c_{21}}^{c_{11}} F_{\tilde{A}}^L(x) dx \right) + \left(b_{11} - \int_{b_{21}}^{b_{11}} I_{\tilde{A}}^L(x) dx \right) + \left(a_{21} - \int_{a_{11}}^{a_{21}} T_{\tilde{A}}^L(x) dx \right) \right] \\ &= \frac{c_{11} + b_{11} + a_{21}}{3} + \frac{1}{3} \int_{c_{11}}^{c_{21}} F_{\tilde{A}}^L(x) dx + \frac{1}{3} \int_{b_{11}}^{b_{21}} I_{\tilde{A}}^L(x) dx - \frac{1}{3} \int_{a_{11}}^{a_{21}} T_{\tilde{A}}^L(x) dx; \end{aligned} \tag{3}$$

and the upper limit of expected interval for the functions $F_{\tilde{A}}^U(x)$, $I_{\tilde{A}}^U(x)$ and $T_{\tilde{A}}^U(x)$ is

$$\begin{aligned} E(\tilde{A}^U) &= \frac{1}{3} \left[\left(c_{41} + \int_{c_{41}}^{c_{31}} F_{\tilde{A}}^L(x) dx \right) + \left(b_{41} + \int_{b_{41}}^{b_{31}} I_{\tilde{A}}^L(x) dx \right) + \left(a_{31} - \int_{a_{11}}^{a_{21}} T_{\tilde{A}}^L(x) dx \right) \right] \\ &= \frac{a_{31} + b_{41} + c_{41}}{3} + \frac{1}{3} \int_{a_{31}}^{a_{41}} T_{\tilde{A}}^U(x) dx - \frac{1}{3} \int_{b_{31}}^{b_{41}} I_{\tilde{A}}^U(x) dx - \frac{1}{3} \int_{c_{31}}^{c_{41}} F_{\tilde{A}}^U(x) dx \end{aligned} \tag{4}$$

Definition 9. Let $\tilde{A} = \langle (a_{11}, a_{21}, a_{31}, a_{41}), (b_{11}, b_{21}, b_{31}, b_{41}), (c_{11}, c_{21}, c_{31}, c_{41}) \rangle$

be a neutrosophic number in the set of real numbers \mathbb{R} . Then the expected value of \tilde{A} is

determined by taking the mid values of expected interval of \tilde{A} and is defined by

$$EV(\tilde{A}) = \frac{E(\tilde{A}^L) + E(\tilde{A}^U)}{2} \quad (5)$$

Therefore the expected value of a neutrosophic trapezoidal number can be determined by the expected interval of neutrosophic numbers with the following theorem.

Theorem 3.1. Let $\tilde{A} = \langle (a_{11}, a_{21}, a_{31}, a_{41}), (b_{11}, b_{21}, b_{31}, b_{41}), (c_{11}, c_{21}, c_{31}, c_{41}) \rangle$

be a NTrN in the set of real numbers \mathbb{R} satisfying the relation $c_{11} \leq b_{11} \leq a_{11} \leq c_{21} \leq b_{21} \leq a_{21} \leq a_{31} \leq b_{31} \leq c_{31} \leq a_{41} \leq b_{41} \leq c_{41}$. Then for $T_{\tilde{A}}^L(x) = \frac{x - a_{11}}{a_{21} - a_{11}}$, $T_{\tilde{A}}^U(x) = \frac{x - a_{41}}{a_{31} - a_{41}}$; $I_{\tilde{A}}^L(x) = \frac{x - b_{21}}{b_{11} - b_{21}}$, $I_{\tilde{A}}^U(x) = \frac{x - a_{31}}{a_{41} - a_{31}}$, $F_{\tilde{A}}^L(x) = \frac{x - c_{21}}{c_{11} - c_{21}}$ and $F_{\tilde{A}}^U(x) = \frac{x - c_{31}}{c_{41} - c_{31}}$, the expected value of \tilde{A} is obtained by

$$EV(\tilde{A}) = \frac{\sum_{i=1}^4 a_{i1} + \sum_{i=1}^4 b_{i1} + \sum_{i=1}^4 c_{i1}}{12}. \quad (6)$$

Proof. Putting the values of $T_{\tilde{A}}^L(x)$, $I_{\tilde{A}}^L(x)$, and $F_{\tilde{A}}^L(x)$ in Eq.(3), we get

$$\begin{aligned} E(\tilde{A}^L) &= \frac{c_{11} + b_{11} + a_{21}}{3} + \frac{1}{3} \int_{c_{11}}^{c_{21}} \frac{x - c_{21}}{c_{11} - c_{21}} dx + \frac{1}{3} \int_{b_{11}}^{b_{21}} \frac{x - b_{21}}{b_{11} - c_{21}} dx \\ &\quad - \frac{1}{3} \int_{a_{11}}^{a_{21}} \frac{x - a_{11}}{a_{21} - a_{11}} dx \\ &= \frac{c_{11} + b_{11} + a_{21}}{3} + \frac{c_{21} - c_{11}}{6} + \frac{b_{21} - b_{11}}{6} + \frac{a_{11} - a_{21}}{6} \\ &= \frac{c_{11} + b_{11} + a_{21} + c_{21} + b_{21} + a_{11}}{6}. \end{aligned} \quad (7)$$

Similarly, putting the values of $T_{\tilde{A}}^U(x)$, $I_{\tilde{A}}^U(x)$, and $F_{\tilde{A}}^U(x)$ in Eq.(4), we obtain

$$\begin{aligned} E(\tilde{A}^U) &= \frac{a_{31} + b_{41} + c_{41}}{3} + \frac{1}{3} \int_{a_{31}}^{a_{41}} \frac{x - a_{41}}{a_{31} - a_{41}} dx - \frac{1}{3} \int_{b_{31}}^{b_{41}} \frac{x - b_{31}}{b_{41} - b_{31}} dx \\ &\quad - \frac{1}{3} \int_{c_{31}}^{c_{41}} \frac{x - c_{31}}{a_{41} - a_{31}} dx \\ &= \frac{a_{31} + b_{41} + c_{41}}{3} + \frac{a_{41} - a_{31}}{6} + \frac{b_{31} - b_{41}}{6} + \frac{c_{31} - c_{41}}{6} \\ &= \frac{c_{11} + b_{11} + a_{21} + c_{21} + b_{21} + a_{11}}{6}. \end{aligned} \quad (8)$$

Following Eq.(5), we obtain the required expected value of \tilde{A}

$$EV(\tilde{A}) = \frac{\sum_{i=1}^4 a_{i1} + \sum_{i=1}^4 b_{i1} + \sum_{i=1}^4 c_{i1}}{12}.$$

This completes the proof. □

Proposition 3.2. Let $\tilde{A}_1 = \langle (a_{11}, a_{21}, a_{31}, a_{41}), (b_{11}, b_{21}, b_{31}, b_{41}), (c_{11}, c_{21}, c_{31}, c_{41}) \rangle$ and $\tilde{A}_2 = \langle (a_{12}, a_{22}, a_{32}, a_{42}), (b_{12}, b_{22}, b_{32}, b_{42}), (c_{12}, c_{22}, c_{32}, c_{42}) \rangle$ be two NTrNs in the set of real numbers \mathbb{R} . Then the following relations are satisfied:

1. $EV(\tilde{A}_1 + \tilde{A}_2) = EV(\tilde{A}_1) + EV(\tilde{A}_2)$;
2. $EV(\lambda\tilde{A}_1) = \lambda EV(\tilde{A}_1)$.

Proof. Following the Eq.(6) about expected value and addition of NTrNs, we have

$$\begin{aligned} EV(\tilde{A}_1 + \tilde{A}_2) &= \frac{\sum_{i=1}^4 (a_{i1} + a_{i2}) + \sum_{i=1}^4 (b_{i1} + b_{i2}) + \sum_{i=1}^4 (c_{i1} + c_{i2})}{12} \\ &= \frac{\left(\sum_{i=1}^4 a_{i1} + \sum_{i=1}^4 b_{i1} + \sum_{i=1}^4 c_{i1} \right) + \left(\sum_{i=1}^4 a_{i2} + \sum_{i=1}^4 b_{i2} + \sum_{i=1}^4 c_{i2} \right)}{12} \\ &= EV(\tilde{A}_1) + EV(\tilde{A}_2) \end{aligned}$$

Similarly,

$$\begin{aligned} EV(\lambda\tilde{A}_1) &= \frac{\sum_{i=1}^4 (\lambda a_{i1}) + \sum_{i=1}^4 (\lambda b_{i1}) + \sum_{i=1}^4 (\lambda c_{i1})}{12} \\ &= \lambda \left[\frac{\sum_{i=1}^4 a_{i1} + \sum_{i=1}^4 b_{i1} + \sum_{i=1}^4 c_{i1}}{12} \right] \\ &= \lambda EV(\tilde{A}_1). \end{aligned}$$

This completes the proof. □

Definition 10. Let $\tilde{A}_1 = \langle (a_{11}, a_{21}, a_{31}, a_{41}), (b_{11}, b_{21}, b_{31}, b_{41}), (c_{11}, c_{21}, c_{31}, c_{41}) \rangle$ and $\tilde{A}_2 = \langle (a_{12}, a_{22}, a_{32}, a_{42}), (b_{12}, b_{22}, b_{32}, b_{42}), (c_{12}, c_{22}, c_{32}, c_{42}) \rangle$ be two NTrNs. Then the following relations are satisfied:

1. $\tilde{A}_1 \prec_{EV} \tilde{A}_2 \Leftrightarrow EV(\tilde{A}_1) < EV(\tilde{A}_2)$;
2. $\tilde{A}_1 \succ_{EV} \tilde{A}_2 \Leftrightarrow EV(\tilde{A}_1) > EV(\tilde{A}_2)$;

$$3. \tilde{A}_1 \sim_{EV} \tilde{A}_2 \Leftrightarrow EV(\tilde{A}_1) = EV(\tilde{A}_2).$$

Example 11. Let $\tilde{A}_1 = \langle (0.5, 0.6, 0.7, 0.8), (0.4, 0.6, 0.7, 0.9), (0.4, 0.5, 0.8, 0.9) \rangle$ and $\tilde{A}_2 = \langle (0.7, 0.8, 0.9, 1.0), (0.7, 0.8, 0.9, 1.0), (0.7, 0.8, 0.9, 0.1) \rangle$ be two NTrNs, then by Definition 3.2 we can calculate

$$\begin{aligned} \tilde{A}_1 + \tilde{A}_2 &= \langle (1.2, 1.4, 1.6, 1.8), (1.1, 1.4, 1.6, 1.9), (1.1, 1.3, 1.7, 1.9) \rangle; \\ 5\tilde{A}_1 &= \langle (2.5, 3.0, 3.5, 4.0), (2.0, 2.4, 3.5, 4.5), (2.0, 2.5, 4.0, 4.5) \rangle. \end{aligned}$$

Following Eq. (6), we obtain the results: $EV(\tilde{A}_1) = 0.65$, $EV(\tilde{A}_2) = 0.85$, $EV(\tilde{A}_1 + \tilde{A}_2)$, and $EV(5\tilde{A}_1) = 3.25$. It follows that $EV(\tilde{A}_1 + \tilde{A}_2) = EV(\tilde{A}_1) + EV(\tilde{A}_2) = 1.5$ and $EV(5\tilde{A}_1) = 5EV(\tilde{A}_1) = 3.25$.

Because $EV(\tilde{A}_2) > EV(\tilde{A}_1)$, we can consider that $\tilde{A}_2 \succ_{EV} \tilde{A}_1$ i.e. \tilde{A}_2 is greater than \tilde{A}_1 .

4 MADM USING EXPECTED VALUE OF NEUTROSOPHIC TRAPEZOIDAL FUZZY NUMBER

In this section we develop multi-attribute group decision making with neutrosophic trapezoidal number.

Assume that $A = \{A_1, A_2, \dots, A_m\}$ be the set of m alternatives, $C = \{C_1, C_2, \dots, C_n\}$ be the set of n attributes, $D = \{D_1, D_2, \dots, D_K\}$ be the set of k decision makers (experts). We also consider that $\lambda^k = \{\tilde{\lambda}_j^1, \tilde{\lambda}_j^2, \dots, \tilde{\lambda}_j^k\}$ be the k -th decision maker's weight vector of j th attribute for $j = 1, 2, \dots, n$, where $\tilde{\lambda}_j^2$ takes the form on NTrN $\tilde{\lambda}_j^k = \langle (u_{j1}^k, u_{j2}^k, u_{j3}^k, u_{j4}^k), (v_{j1}^k, v_{j2}^k, v_{j3}^k, v_{j4}^k), (w_{j1}^k, w_{j2}^k, w_{j3}^k, w_{j4}^k) \rangle$. The rating values of k th decision maker of the alternatives A_i for $i=1, 2, \dots, m$ with respect to attributes C_j for $j=1, 2, \dots, n$ can be concisely expressed in matrix format. Then we obtain the decision matrix $(d_{ij}^k)_{m \times n}$ for the k th decision maker as

$$(d_{ij}^k)_{m \times n} = \begin{array}{c|cccc} & C_1 & C_2 & \cdots & C_n \\ \hline A_1 & d_{11}^k & d_{12}^k & \cdots & d_{1n}^k \\ A_2 & d_{21}^k & d_{22}^k & \cdots & d_{2n}^k \\ \vdots & \vdots & \vdots & \vdots & \vdots \\ A_m & d_{m1}^k & d_{m2}^k & \cdots & d_{mn}^k \end{array} \quad (9)$$

where, $\tilde{d}_{ij}^k = \langle T_{ij}^k, I_{ij}^k, F_{ij}^k \rangle$ is the neutrosophic rating of alternative A_i with respect to attribute C_j . In the rating \tilde{d}_{ij}^k for $i = 1, 2, \dots, m$ and $j = 1, 2, \dots, n$, the component $T_{ij}^k = (a_{ij1}^k, a_{ij2}^k, a_{ij3}^k, a_{ij4}^k)$ represents the truth membership function, $I_{ij}^k = (b_{ij1}^k, b_{ij2}^k, b_{ij3}^k, b_{ij4}^k)$ represents the indeterminacy membership function, and $F_{ij}^k = (c_{ij1}^k, c_{ij2}^k, c_{ij3}^k, c_{ij4}^k)$ represents the falsity membership function. Hence we can consider the NTrN $\tilde{d}_{ij}^k = \langle (a_{ij1}^k, a_{ij2}^k, a_{ij3}^k, a_{ij4}^k), (b_{ij1}^k, b_{ij2}^k, b_{ij3}^k, b_{ij4}^k), (c_{ij1}^k, c_{ij2}^k, c_{ij3}^k, c_{ij4}^k) \rangle$ as the neutrosophic rating of the decision matrix.

Step 1. Aggregate the rating values of alternatives

In the decision making process, experts provide their different ratings for each alternative. Therefore, the method of average value can be used to aggregate the neutrosophic ratings $\langle T_{ij}^k, I_{ij}^k, F_{ij}^k \rangle$ of K decision makers.

Thus the aggregated neutrosophic rating \tilde{d}_{ij} ($i = 1, 2, \dots, m; j = 1, 2, \dots, n$) of the alternatives are calculated as $\tilde{d}_{ij} = \langle T_{ij}, I_{ij}, F_{ij} \rangle$ where,

$$T_{ij} = \left(\frac{\sum_{k=1}^K a_{ij1}^k}{K}, \frac{\sum_{k=1}^K a_{ij2}^k}{K}, \frac{\sum_{k=1}^K a_{ij3}^k}{K}, \frac{\sum_{k=1}^K a_{ij4}^k}{K} \right) = (a_{ij1}, a_{ij2}, a_{ij3}, a_{ij4}) \tag{10}$$

$$I_{ij} = \left(\frac{\sum_{k=1}^K b_{ij1}^k}{K}, \frac{\sum_{k=1}^K b_{ij2}^k}{K}, \frac{\sum_{k=1}^K b_{ij3}^k}{K}, \frac{\sum_{k=1}^K b_{ij4}^k}{K} \right) = (b_{ij1}, b_{ij2}, b_{ij3}, b_{ij4}) \tag{11}$$

$$F_{ij} = \left(\frac{\sum_{k=1}^K c_{ij1}^k}{K}, \frac{\sum_{k=1}^K c_{ij2}^k}{K}, \frac{\sum_{k=1}^K c_{ij3}^k}{K}, \frac{\sum_{k=1}^K c_{ij4}^k}{K} \right) = (c_{ij1}, c_{ij2}, c_{ij3}, c_{ij4}) \tag{12}$$

Then the aggregated group decision matrix \tilde{D} can be obtained as

$$(\tilde{d}_{ij})_{m \times n} = \begin{array}{c|cccc} & C_1 & C_2 & \cdots & C_n \\ \hline A_1 & \tilde{d}_{11} & \tilde{d}_{12} & \cdots & \tilde{d}_{1n} \\ A_2 & \tilde{d}_{21} & \tilde{d}_{22} & \cdots & \tilde{d}_{2n} \\ \vdots & \vdots & \vdots & \vdots & \vdots \\ A_m & \tilde{d}_{m1} & \tilde{d}_{m2} & \cdots & \tilde{d}_{mn} \end{array} \tag{13}$$

and the corresponding expected value based decision matrix of \tilde{D} can be obtained by Eq.(6) as

$$(E(\tilde{d}_{ij}))_{m \times n} = \begin{array}{c|cccc} & C_1 & C_2 & \cdots & C_n \\ \hline A_1 & EV(\tilde{d}_{11}) & EV(\tilde{d}_{12}) & \cdots & EV(\tilde{d}_{1n}) \\ A_2 & EV(\tilde{d}_{21}) & EV(\tilde{d}_{22}) & \cdots & EV(\tilde{d}_{2n}) \\ \vdots & \vdots & \vdots & \vdots & \vdots \\ A_m & EV(\tilde{d}_{m1}) & EV(\tilde{d}_{m2}) & \cdots & EV(\tilde{d}_{mn}) \end{array} \tag{14}$$

Step 2. Aggregate of the weight of attributes

Similarly, using the method of average value, the aggregated neutrosophic weight $\tilde{\lambda}_j =$

$\langle u_j, v_j, w_j \rangle$ of $C_j (j = 1, 2, \dots, n)$ can be calculated as follows:

$$\begin{aligned} u_j &= \left(\frac{\sum_{k=1}^K u_{j1}^k}{K}, \frac{\sum_{k=1}^K u_{j2}^k}{K}, \frac{\sum_{k=1}^K u_{j3}^k}{K}, \frac{\sum_{k=1}^K u_{j4}^k}{K} \right) \\ &= (u_{j1}, u_{j2}, u_{j3}, u_{j4}) \end{aligned} \quad (15)$$

$$\begin{aligned} v_j &= \left(\frac{\sum_{k=1}^K v_{j1}^k}{K}, \frac{\sum_{k=1}^K v_{j2}^k}{K}, \frac{\sum_{k=1}^K v_{j3}^k}{K}, \frac{\sum_{k=1}^K v_{j4}^k}{K} \right) \\ &= (v_{j1}, v_{j2}, v_{j3}, v_{j4}) \end{aligned} \quad (16)$$

$$\begin{aligned} w_j &= \left(\frac{\sum_{k=1}^K w_{j1}^k}{K}, \frac{\sum_{k=1}^K w_{j2}^k}{K}, \frac{\sum_{k=1}^K w_{j3}^k}{K}, \frac{\sum_{k=1}^K w_{j4}^k}{K} \right) \\ &= (w_{j1}, w_{j2}, w_{j3}, w_{j4}). \end{aligned} \quad (17)$$

Then, the aggregated attribute weight \tilde{W} can be taken as

$$W = [\tilde{\lambda}_1, \tilde{\lambda}_2, \dots, \tilde{\lambda}_n]. \quad (18)$$

where, $\tilde{\lambda}_j = \langle u_j, v_j, w_j \rangle$ for $j = 1, 2, \dots, n$. Now by Eq.(6), we determine the expected value of weight $\tilde{\lambda}_j$ ($j = 1, 2, \dots, n$) for an attribute C_j and obtain the normalized expected weight vector

$$W^N = [\lambda_1^N, \lambda_2^N, \dots, \lambda_n^N] \quad (19)$$

where,

$$\lambda_j^N = \frac{EV(\tilde{\lambda}_j)}{\sum_{j=1}^n EV(\tilde{\lambda}_j)} \quad j = 1, 2, \dots, n. \quad (20)$$

Step 3. Determine the weighted expected value of alternative

We now determine the weighted expected value of the alternative A_i for $i = 1, 2, \dots, m$ by summing up the multiplicative values of normalized expected weight and expected value of aggregated rating value for an attribute $C_j (j = 1, 2, \dots, n)$ in the decision matrix $(E(\tilde{d}_{ij}))_{m \times n}$ shown in Eq.(14). Therefore, the weighted expected value of alternative $A_i (i = 1, 2, \dots, m)$ is

$$EV_w(A_i) = \sum_{j=1}^n \lambda_j^N EV(\tilde{d}_{ij}). \quad (21)$$

Step 4. Rank the alternatives

Largest value of the weighted expected value $EV_w(A_i)$ of an alternative $A_i (i = 1, 2, \dots, m)$ determines the best alternative.

5 ILLUSTRATIVE EXAMPLE

To illustrate the proposed approach, we provide an illustrative example. Assume that an organization desires to purchase some cars. After initial choice, four models (i.e. alternatives) A_1, A_2, A_3 and A_4 are considered for further evaluation. A committee of four experts D_1, D_2, D_3 and D_4 is set up to select the most appropriate alternative car. Six attributes are considered which include:

1. Performance (C_1),
2. Style (C_2),
3. Comfort (C_3),
4. Safety (C_4),
5. Specifications (C_5),
6. Customer service (C_6).

Linguistic variables are generally presented with linguistic terms Zadeh (1975). These terms play an important role to present uncertain information that are either too complex or too ill-defined to be described properly with conventional quantitative expressions. For example, the ratings of alternatives over the qualitative attributes could be expressed with linguistic variables such as very poor, poor, medium poor, fair, medium good, good, very good, etc. These linguistic terms can also be represented by NTrNs such as the term “fair” can be considered with $\langle(0.3, 0.4, 0.5, 0.6), (0.2, 0.4, 0.5, 0.7), (0.2, 0.3, 0.6, 0.7)\rangle$. We now define the following linguistic scales characterizing NTrNs.

Table 1: Linguistic variables for the importance of attributes

Linguistic variables	Corresponding NTrNs
Very low(VL)	$\langle(0.0, 0.0, 0.0, 0.0), (0.0, 0.0, 0.0, 0.0), (0.0, 0.0, 0.0, 0.0)\rangle$
Low(L)	$\langle(0.0, 0.1, 0.2, 0.3), (0.0, 0.1, 0.2, 0.3), (0.0, 0.1, 0.2, 0.3)\rangle$
Medium(M)	$\langle(0.1, 0.2, 0.3, 0.4), (0.0, 0.2, 0.3, 0.5), (0.0, 0.1, 0.4, 0.5)\rangle$
High(H)	$\langle(0.3, 0.4, 0.5, 0.6), (0.2, 0.4, 0.5, 0.7), (0.2, 0.3, 0.6, 0.7)\rangle$
Very High(VH)	$\langle(0.5, 0.6, 0.7, 0.8), (0.4, 0.6, 0.7, 0.9), (0.4, 0.5, 0.8, 0.9)\rangle$

We consider that the four experts describe the importance of the attribute and the rating of alternatives by linguistic variables such as very good, good, fair, poor, very poor, etc. The linguistic ratings of four alternatives under the pre-assigned attributes and the weights of the attributes for $k(k = 1, 2, \dots, K)$ are shown in Table 1. We first convert the assessed rating values of alternative and weights of each attribute with the help of pre-defined linguistic variables in the form of NTrNs defined in Table 2. The proposed method is applied to solve the problem and its computational procedure is summarized as follows:

Table 2: Linguistic variables for the ratings of alternatives

Linguistic variables	Corresponding NTrNs
Very Poor(VP)	$\langle(0.0, 0.0, 0.0, 0.0), (0.0, 0.0, 0.0, 0.0), (0.0, 0.0, 0.0, 0.0)\rangle$
Poor(P)	$\langle(0.0, 0.1, 0.2, 0.3), (0.0, 0.1, 0.2, 0.3), (0.0, 0.1, 0.2, 0.3)\rangle$
Medium Poor(MP)	$\langle(0.1, 0.2, 0.3, 0.4), (0.0, 0.2, 0.3, 0.5), (0.0, 0.1, 0.4, 0.5)\rangle$
Fair(F)	$\langle(0.3, 0.4, 0.5, 0.6), (0.2, 0.4, 0.5, 0.7), (0.2, 0.3, 0.6, 0.7)\rangle$
Good(G)	$\langle(0.5, 0.6, 0.7, 0.8), (0.4, 0.6, 0.7, 0.9), (0.4, 0.5, 0.8, 0.9)\rangle$
Medium Good(MG)	$\langle(0.7, 0.8, 0.9, 1.0), (0.7, 0.8, 0.9, 1.0), (0.7, 0.8, 0.9, 1.0)\rangle$
Very Good(VG)	$\langle(1.0, 1.0, 1.0, 1.0), (1.0, 1.0, 1.0, 1.0), (1.0, 1.0, 1.0, 1.0)\rangle$

Table 3: Rating of alternatives and weight of attributes

Alternatives (A_i)	Decision Makers	C_1	C_2	C_3	C_4	C_5	C_6
A_1	DM-1	VG	G	G	G	G	VG
	DM-2	VG	VG	G	G	G	VG
	DM-3	G	VG	G	G	VG	G
	DM-4	G	G	G	G	G	G
A_2	DM-1	F	G	F	G	G	F
	DM-2	G	MG	G	MG	G	G
	DM-3	G	F	G	F	VG	F
	DM-4	F	G	F	F	G	F
A_3	DM-1	VG	VG	G	G	VG	VG
	DM-2	G	VG	VG	G	G	VG
	DM-3	VG	G	G	MG	G	MG
	DM-4	G	G	G	MG	G	G
A_4	DM-1	F	VG	G	G	VG	F
	DM-2	F	F	G	G	F	G
	DM-3	G	MG	G	MG	MG	G
	DM-4	G	G	F	G	G	G
Weights	DM-1	VH	VH	H	M	H	H
	DM-2	H	VH	H	H	M	M
	DM-3	M	H	M	M	H	M
	DM-4	M	H	M	H	VH	H

Step 1. Determine the aggregated rating values of alternatives

Using Eqs.(10),(11), and (12), we aggregate each of four decision makers' opinion into a group opinion (see Table 4). Then employing expected value of neutrosophic trapezoidal number defined in Eq.(6), we construct the following expected value matrix:

$$(\tilde{d}_{ij})_{m \times n} = \begin{array}{c|cccccc} & C_1 & C_2 & C_3 & C_4 & C_5 & C_6 \\ \hline A_1 & 0.9250 & 0.9250 & 0.8500 & 0.8500 & 0.8875 & 0.9250 \\ A_2 & 0.6500 & 0.7000 & 0.6500 & 0.6000 & 0.8875 & 0.5500 \\ A_3 & 0.9250 & 0.9250 & 0.8875 & 0.7500 & 0.8875 & 0.8750 \\ A_4 & 0.6500 & 0.7375 & 0.7500 & 0.8000 & 0.7375 & 0.7500 \end{array} \quad (22)$$

Step 2. Aggregate of the weight of attributes

Similarly, we aggregate the weights of attributes by Eqs.(15), (16), and (17). Then the aggregated weight vector W is

$$W = \begin{bmatrix} \langle(0.60, 0.70, 0.80, 0.90), \langle(0.60, 0.70, 0.80, 0.90), \\ (0.58, 0.70, 0.80, 0.92), (0.58, 0.70, 0.80, 0.92), \\ (0.58, 0.67, 0.82, 0.92)\rangle, (0.58, 0.67, 0.82, 0.92)\rangle, \\ \langle(0.60, 0.70, 0.80, 0.90), \langle(0.60, 0.70, 0.80, 0.90), \\ (0.58, 0.70, 0.80, 0.92), (0.58, 0.70, 0.80, 0.92), \\ (0.58, 0.67, 0.82, 0.92)\rangle, (0.58, 0.67, 0.82, 0.92)\rangle, \\ \langle(0.60, 0.70, 0.80, 0.90), \langle(0.60, 0.70, 0.80, 0.90), \\ (0.58, 0.70, 0.80, 0.92), (0.58, 0.70, 0.80, 0.92), \\ (0.58, 0.67, 0.82, 0.92)\rangle, (0.58, 0.67, 0.82, 0.92)\rangle \end{bmatrix}. \quad (23)$$

Using Eq.(6), we calculate the expected value of each element of the weight vector W :

$$EV(W) = (0.40, 0.55, 0.35, 0.35, 0.45, 0.35)^T. \quad (24)$$

Following Eq.(20), we determine the normalized weight vector

$$W^N = (0.1633, 0.2246, 0.1428, 0.1428, 0.1428, 0.1837)^T. \quad (25)$$

Step 3. Determine the weighted expected value of alternative

By Eq.(21), we determine the following weighted expected value of alternative A_i for ($i = 1, 2, 3, 4$):
 $EV(A_1) = 0.8967, EV(A_2) = 0.6834, EV(A_3) = 0.8806, EV(A_4) = 0.7357.$

Table 4: Aggregated rating values of alternatives with NTrNs

(A_i)	C_1	C_2	C_3
A_1	$\langle(0.85, 0.90, 0.95, 1.00),$ $(0.85, 0.90, 0.95, 1.00),$ $(0.85, 0.90, 0.95, 1.00), \rangle$	$\langle(0.85, 0.90, 0.95, 1.00),$ $(0.85, 0.90, 0.95, 1.00),$ $(0.85, 0.90, 0.95, 1.00), \rangle$	$\langle(0.70, 0.80, 0.90, 1.00),$ $(0.70, 0.80, 0.90, 1.00),$ $(0.70, 0.80, 0.90, 1.00), \rangle$
A_2	$\langle(0.50, 0.60, 0.70, 0.80),$ $(0.45, 0.60, 0.70, 0.85),$ $(0.45, 0.55, 0.75, 0.85), \rangle$	$\langle(0.55, 0.65, 0.75, 0.85),$ $(0.50, 0.65, 0.75, 0.90),$ $(0.55, 0.60, 0.80, 0.90), \rangle$	$\langle(0.50, 0.60, 0.70, 0.80),$ $(0.45, 0.60, 0.70, 0.85),$ $(0.45, 0.55, 0.75, 0.85), \rangle$
A_3	$\langle(0.85, 0.90, 0.95, 1.00),$ $(0.85, 0.90, 0.95, 1.00),$ $(0.85, 0.90, 0.95, 1.00), \rangle$	$\langle(0.85, 0.90, 0.95, 1.00),$ $(0.85, 0.90, 0.95, 1.00),$ $(0.85, 0.90, 0.95, 1.00), \rangle$	$\langle(0.78, 0.85, 0.92, 1.00),$ $(0.78, 0.85, 0.92, 1.00),$ $(0.78, 0.85, 0.92, 1.00), \rangle$
A_4	$\langle(0.50, 0.60, 0.70, 0.80),$ $(0.45, 0.60, 0.70, 0.85),$ $(0.45, 0.55, 0.75, 0.85), \rangle$	$\langle(0.63, 0.70, 0.77, 0.85),$ $(0.58, 0.70, 0.77, 0.90),$ $(0.58, 0.65, 0.82, 0.90), \rangle$	$\langle(0.60, 0.70, 0.80, 0.90),$ $(0.58, 0.70, 0.80, 0.92),$ $(0.58, 0.68, 0.82, 0.92), \rangle$
(A_i)	C_4	C_5	C_6
A_1	$\langle(0.70, 0.80, 0.90, 1.00),$ $(0.70, 0.80, 0.90, 1.00),$ $(0.70, 0.80, 0.90, 1.00), \rangle$	$\langle(0.78, 0.85, 0.92, 1.00),$ $(0.78, 0.85, 0.92, 1.00),$ $(0.78, 0.85, 0.92, 1.00), \rangle$	$\langle(0.85, 0.90, 0.95, 1.00),$ $(0.85, 0.90, 0.95, 1.00),$ $(0.85, 0.90, 0.95, 1.00), \rangle$
A_2	$\langle(0.45, 0.55, 0.65, 0.75),$ $(0.38, 0.55, 0.65, 0.82),$ $(0.38, 0.48, 0.72, 0.82), \rangle$	$\langle(0.78, 0.85, 0.92, 1.00),$ $(0.78, 0.85, 0.92, 1.00),$ $(0.78, 0.85, 0.92, 1.00), \rangle$	$\langle(0.40, 0.50, 0.60, 0.70),$ $(0.33, 0.50, 0.60, 0.77),$ $(0.33, 0.43, 0.67, 0.77), \rangle$
A_3	$\langle(0.60, 0.70, 0.80, 0.90),$ $(0.55, 0.70, 0.80, 0.95),$ $(0.55, 0.65, 0.85, 0.95), \rangle$	$\langle(0.78, 0.85, 0.92, 1.00),$ $(0.78, 0.85, 0.92, 1.00),$ $(0.78, 0.85, 0.92, 1.00), \rangle$	$\langle(0.80, 0.85, 0.90, 0.95),$ $(0.78, 0.85, 0.90, 0.97),$ $(0.78, 0.83, 0.92, 0.97), \rangle$
A_4	$\langle(0.65, 0.75, 0.85, 0.95),$ $(0.63, 0.75, 0.85, 0.97),$ $(0.63, 0.73, 0.87, 0.97), \rangle$	$\langle(0.63, 0.70, 0.77, 0.85),$ $(0.58, 0.70, 0.77, 0.90),$ $(0.58, 0.65, 0.82, 0.90), \rangle$	$\langle(0.60, 0.70, 0.80, 0.90),$ $(0.58, 0.70, 0.80, 0.92),$ $(0.58, 0.67, 0.82, 0.92), \rangle$

Step 4. Rank the alternatives

We set the following ranking order according to the weighted expected value of alternative $A_i (i = 1, 2, \dots, m)$ as

$$EV(A_1) > EV(A_3) > EV(A_4) > EV(A_2).$$

Thus the ranking order $A_1 \succ A_3 \succ A_4 \succ A_2$ of alternatives reflects that A_1 is the best car for purchasing.

6 CONCLUSIONS

In MAGDM problems, the rating values provided by decision makers are often evaluated qualitatively and quantitatively due to uncertainty of real world problems. Neutrosophic trapezoidal number (NTrN) is an alternative tool that can represent incomplete and inconsistent information. In this paper, we have taken decision maker's qualitative opinion in-terms of linguistic variables represented by predefined NTrNs. We have developed an exact formula of expected value for NTrN. Then we have determined the expected values of aggregated rating values and expected weight values of attributes. Furthermore, we have calculated the weighted expected values of alternatives to get the ranking order of alternatives. Finally, we have provided a numerical example about MAGDM with NTrNs to illustrate the proposed method. The developed method is straightforward and effective. We hope that the proposed method has a great chance of success for dealing with uncertainty in MAGDM problems such as personal selection, supplier selection, project evaluation, and manufacturing systems. This method can be extended to MAGDM problems under interval neutrosophic trapezoidal number information.

REFERENCES

- Atanassov, K. (1986). Intuitionistic fuzzy sets. *Fuzzy sets and Systems*, 20(1), 87–96.
- Biswas, P., Pramanik, S., & Giri, B. C. (2014a). Entropy based grey relational analysis method for multi-attribute decision-making under single valued neutrosophic assessments. *Neutrosophic Sets and Systems*, 2, 102–110.
- Biswas, P., Pramanik, S., & Giri, B. C. (2014b). A new methodology for neutrosophic multi-attribute decision making with unknown weight information. *Neutrosophic Sets and Systems*, 3, 42–52.
- Biswas, P., Pramanik, S., & Giri, B. C. (2015). Cosine similarity measure based multi-attribute decision-making with trapezoidal fuzzy neutrosophic numbers. *Neutrosophic Sets and System*, 8, 47–57.

- Biswas, P., Pramanik, S., & Giri, B. C. (2016a). Topsis method for multi-attribute group decision-making under single-valued neutrosophic environment. *Neural Computing and Applications*, 27(3), 727–737.
- Biswas, P., Pramanik, S., & Giri, B. C. (2016b). Value and ambiguity index based ranking method of single-valued trapezoidal neutrosophic numbers and its application to multi-attribute decision making. *Neutrosophic Sets and Systems*, 12, 127–138.
- Biswas, P., Pramanik, S., & Giri, B. C. (2017). Non-linear programming approach for single-valued neutrosophic topsis method. *New Mathematics and Natural Computation*. ((In press))
- Boucher, T., & MacStravic, E. (1991). Multiattribute evaluation within a present value framework and its relation to the analytic hierarchy process. *The Engineering Economist*, 37(1), 1–32.
- Deli, I., & Şubaş, Y. (2017). A ranking method of single valued neutrosophic numbers and its applications to multi-attribute decision making problems. *International Journal of Machine Learning and Cybernetics*, 8(4), 1309–1322.
- Deng, J. (1989). Introduction to grey system theory. *The Journal of grey system*, 1(1), 1–24.
- Dubois, D., & Prade, H. (1987). The mean value of a fuzzy number. *Fuzzy sets and systems*, 24(3), 279–300.
- Grzegorzewski, P. (2003). The hamming distance between intuitionistic fuzzy sets. In *The proceeding of the ifsa 2003 world congress, istanbul*.
- He, Y., & Wang, D., Q. and Zhou. (2009). Extension of the expected value method for multiple attribute decision making with fuzzy data. *Knowledge-Based Systems*, 22(1), 63–66.
- Heilpern, S. (1992). The expected value of a fuzzy number. *Fuzzy sets and Systems*, 47(1), 81–86.
- Hwang, C., & Yoon, K. (2012). *Multiple attribute decision making: methods and applications a state-of-the-art survey* (Vol. 186). Springer Science & Business Media.
- Kauffman, A., & Gupta, M. (1991). *Introduction to fuzzy arithmetic: theory and application*. Van Nostrand Reinhold, New York. Van Nostrand Reinhold, New York.
- Li, G., Yamaguchi, D., & Nagai, M. (2007). A grey-based decision-making approach to the supplier selection problem. *Mathematical and computer modelling*, 46(3), 573–581.
- Liu, P., Chu, Y., Li, Y., & Chen, Y. (2014). Some generalized neutrosophic number hamacher aggregation operators and their application to group decision making. *International Journal of Fuzzy Systems*, 16(2), 242–255.
- Liu, P., & Wang, Y. (2014). Multiple attribute decision-making method based on single-valued neutrosophic normalized weighted bonferroni mean. *Neural Computing and Applications*, 25(7-8), 2001–2010.

- Mondal, K., & Pramanik, S. (2015). Neutrosophic tangent similarity measure and its application to multiple attribute decision making. *Neutrosophic Sets and Systems*, 9, 85–92.
- Nehi, H. (2010). A new ranking method for intuitionistic fuzzy numbers. *International Journal of Fuzzy Systems*, 12(1), 80–86.
- Olson, D. L., & Wu, D. (2006). Simulation of fuzzy multiattribute models for grey relationships. *European Journal of Operational Research*, 175(1), 111–120.
- Opricovic, S. (1998). Multicriteria optimization of civil engineering systems. *Faculty of Civil Engineering, Belgrade*, 2(1), 5–21.
- Peng, J., Wang, J., Wang, J., Zhang, H., & Chen, X. (2016). Simplified neutrosophic sets and their applications in multi-criteria group decision-making problems. *International Journal of Systems Science*, 47(10), 2342–2358.
- Peng, J., Wang, J., Zhang, H., & Chen, X. (2014). An outranking approach for multi-criteria decision-making problems with simplified neutrosophic sets. *Applied Soft Computing*, 25, 336–346.
- Pramanik, S., Biswas, P., & Giri, B. (2017). Hybrid vector similarity measures and their applications to multi-attribute decision making under neutrosophic environment. *Neural computing and Applications*, 28(5), 1163–1176.
- Roy, B. (1991). The outranking approach and the foundations of electre methods. *Theory and decision*, 31(1), 49–73.
- Saaty, T. L. (1980). *The analytic hierarchy process*. McGraw-Hill, New York. New York: McGraw-Hill New York.
- Saaty, T. L. (1994). *Fundamentals of decision making and priority theory with the ahp*. RWS Publications, Pittsburgh. RWS Publications, Pittsburgh.
- Şahin, R., & Liu, P. (2015). Maximizing deviation method for neutrosophic multiple attribute decision making with incomplete weight information. *Neural Computing and Applications*, 27(7), 2017–2029.
- Smarandache, F. (1998). *A unifying field in logics. neutrosophy: neutrosophic probability, set and logic*. Rehoboth: American Research Press.
- Torra, V. (2010). Hesitant fuzzy sets. *International Journal of Intelligent Systems*, 25(6), 529–539.
- Turksen, I. (1986). Interval valued fuzzy sets based on normal forms. *Fuzzy sets and systems*, 20(2), 191–210.
- Wang, H., Smarandache, F., Zhang, Y., & Sunderraman, R. (2010). Single valued neutrosophic sets. *Multispace and Multistructure*, 4, 410–413.
- Ye, J. (2011). Expected value method for intuitionistic trapezoidal fuzzy multicriteria decision-making problems. *Expert Systems with Applications*, 38(9), 11730–11734.
- Ye, J. (2014a). A multicriteria decision-making method using aggregation operators for simplified neutrosophic sets. *Journal of Intelligent & Fuzzy Systems*, 26 (5), 2459–2466.

- Abdel-Basset, M., Mohamed, M., Smarandache, F., & Chang, V. (2018). Neutrosophic Association Rule Mining Algorithm for Big Data Analysis. *Symmetry*, 10(4), 106.
- Abdel-Basset, M., & Mohamed, M. (2018). The Role of Single Valued Neutrosophic Sets and Rough Sets in Smart City: Imperfect and Incomplete Information Systems. *Measurement*. Volume 124, August 2018, Pages 47-55
- Abdel-Basset, M., Gunasekaran, M., Mohamed, M., & Smarandache, F. A novel method for solving the fully neutrosophic linear programming problems. *Neural Computing and Applications*, 1-11.
- Abdel-Basset, M., Manogaran, G., Gamal, A., & Smarandache, F. (2018). A hybrid approach of neutrosophic sets and DEMATEL method for developing supplier selection criteria. *Design Automation for Embedded Systems*, 1-22.
- Abdel-Basset, M., Mohamed, M., & Chang, V. (2018). NMCDA: A framework for evaluating cloud computing services. *Future Generation Computer Systems*, 86, 12-29.
- Abdel-Basset, M., Mohamed, M., Zhou, Y., & Hezam, I. (2017). Multi-criteria group decision making based on neutrosophic analytic hierarchy process. *Journal of Intelligent & Fuzzy Systems*, 33(6), 4055-4066.
- Abdel-Basset, M.; Mohamed, M.; Smarandache, F. An Extension of Neutrosophic AHP–SWOT Analysis for Strategic Planning and Decision-Making. *Symmetry* 2018, 10, 116.
- Ye, J. (2014b). Vector similarity measures of simplified neutrosophic sets and their application in multicriteria decision making. *International Journal of Fuzzy Systems*, 16(2), 204–215.
- Ye, J. (2015). Trapezoidal neutrosophic set and its application to multiple attribute decision-making. *Neural Computing and Applications*, 26(5), 1157–1166.
- Zadeh, L. (1965). Fuzzy sets. *Information and Control*, 8(3), 338–353.
- Zadeh, L. (1975). The concept of a linguistic variable and its application to approximate reasoning–i. *Information Sciences*, 8(3), 199–249.

Multi-criteria Group Decision Making based on Linguistic Refined Neutrosophic Strategy

Kalyan Mondal¹, Surapati Pramanik², Bibhas C. Giri³

^{1,3}Department of Mathematics, Jadavpur University, Kolkata-700032, West Bengal, India,

¹Email: kalyanmathematic@gmail.com, ³Email: bcgiri.jumath@gmail.com

²Department of Mathematics, Nandalal Ghosh B.T. College, Panpur, P.O.- Narayanpur, District–North 24 Parganas, Pin Code-743126, West Bengal, India, Email: sura_pati@yahoo.co.in

ABSTRACT

Multi-criteria group decision making (MCGDM) strategy, which consists of a group of experts acting collectively for best selection among all possible alternatives with respect to some criteria, is focused on in this study. To develop the paper, we define linguistic neutrosophic refine set. We also define entropy to calculate unknown weights of the criteria and establish basic properties of entropy in linguistic neutrosophy refine set environment. In the developed strategy, the rating of all alternatives is expressed with linguistic variables. All linguistic variables are expressed as refined neutrosophic numbers which are characterized by truth-membership sequences, indeterminacy-membership sequences, and falsity-membership sequences. Linguistic refined neutrosophic score function (LRNSF) and linguistic refined neutrosophic accumulated function (LRNAF) are proposed. Weight of each criterion is unknown to decision maker. Finally, an illustrative example is provided to demonstrate the applicability of the proposed approach.

KEYWORDS: Linguistic variable, Neutrosophic set, Refined neutrosophic set, Linguistic refined neutrosophic set, Score function, Group decision making

1. INTRODUCTION

To deal uncertainty characterized by indeterminacy, Smarandache (1998) introduced neutrosophic sets. The concept of neutrosophic sets is the generalization fuzzy set (Zadeh, 1965) and intuitionistic fuzzy set (Atanassov, 1986). Wang et al. (2010) proposed the concept of single valued neutrosophic set (SVNS) to deal with practical problems. SVNS has been studied and applied in different fields such as medical diagnosis (Ye, 2015a, Ye & Fu, 2016) decision making problems (Sodenkamp, 2013; Kharal, 2014; Biswas et al. 2014a, 2014b, 2015a, 2015b, 2016a, 2016b; Mondal & Pramanik, 2014b, 2015a, 2015c; Şahin, 2017; Şahin & Liu, 2016; Ye, 2015b, Smarandache & Pramanik, 2016), social problems (Mondal & Pramanik, 2014; Pramanik & Chackrabarti, 2013), engineering problem (Ye, 2016), conflict resolution (Pramanik & Roy, 2014) and so on.

Different neutrosophic hybrid sets are proposed in the literature such as neutrosophic soft set (Maji, 2013), neutrosophic cubic set (Ali, Deli, & Smarandache, 2016), neutrosophic bipolar set (Deli, Ali, M., & Smarandache, 2015), rough bipolar neutrosophic set (Pramanik & Mondal, 2016), etc. Broumi et al. (2014a, 2014b) proposed rough neutrosophic set by combining rough set and neutrosophic set. Mondal and Pramanik (2015a) proved the basic properties of cosine similarity measure of rough neutrosophic sets and provided its application in medical diagnosis. Pramanik & Mondal (2015) proved the basic properties of cotangent similarity measure of rough neutrosophic sets and its application to medical diagnosis. Mondal & Pramanik (2015d) also proposed new rough neutrosophic multi-attribute decision-making strategy based on

grey relational analysis. Mondal, Pramanik and Smarandache (2016a) proposed multi-attribute decision making based on rough neutrosophic variational coefficient similarity measure. Mondal, Pramanik and Smarandache (2016b) also established rough neutrosophic TOPSIS for multi-attribute group decision making. Pramanik, Roy, Roy and Smarandache (2017) proposed rough multi criteria decision making based on correlation coefficient.

Smarandache (2013) extended the classical neutrosophic logic to n-valued refined neutrosophic logic, by refining each neutrosophic component T, I, F into respectively, T_1, T_2, \dots, T_m , and I_1, I_2, \dots, I_p and F_1, F_2, \dots, F_r . Broumi & Smarandache (2014) presented an application of cosine similarity measure of neutrosophic refined sets in medical diagnosis problems. Ye & Ye (2014) introduced the concept of single valued neutrosophic multi-set (SVNM) and proved its basic operational relations. In the same study, Ye and Ye (2014) proposed the Dice similarity measure and the weighted Dice similarity measure for SVNMs and investigated their properties and they applied the Dice similarity measure of SVNMs to medical diagnosis. Broumi and Deli (2014) proposed correlation measure for neutrosophic refined sets and applied to medical diagnosis. Mondal and Pramanik (2015b) proposed neutrosophic refined similarity measure based on tangent function and applied it to multi-attribute decision making. In this paper, we propose a new multi-criteria group decision making method based on linguistic variables and refined neutrosophic sets. The proposed method is illustrated by solving an illustrative example.

Rest of the paper has been organized as follows: In section 2, some definitions of neutrosophic set, single valued neutrosophic set, refined neutrosophic set, refined neutrosophic number, and linguistic refined neutrosophic set have been presented briefly. In section 3, a new multi-criteria group decision making method has been presented. In section 4, the proposed method has been applied to deal with an illustrative example related to suitable spot selection for construction purpose. Section 5 presents the concluding remarks and future scope of research.

2. PRELIMINARIES

2.1 Concepts of neutrosophic sets (Smarandache, 1998)

A neutrosophic set A in a universal set X , which is characterized independently by a truth-membership function $T_A(x)$, an indeterminacy-membership function $I_A(x)$, and a falsity-membership function $F_A(x)$. The functions $T_A(x), I_A(x), F_A(x)$ in X are real standard or nonstandard subsets of $]0, 1^+[$, such that $T_A(x): X \rightarrow]0, 1^+[$, $I_A(x): X \rightarrow]0, 1^+[$, and $F_A(x): X \rightarrow]0, 1^+[$. Then, the sum of $T_A(x), I_A(x)$ and $F_A(x)$ satisfies the condition $0 \leq \sup T_A(x) + \sup I_A(x) + \sup F_A(x) \leq 3^+$.

2.2 Some concepts of single valued neutrosophic sets (Wang et al., 2010)

Definition 1 A single valued neutrosophic set A in a universal set X is characterized by a truth-membership function $T_A(x)$, an indeterminacy-membership function $I_A(x)$, and a falsity-membership function $F_A(x)$. Then, a single valued neutrosophic set A can be denoted by

$A = \{ \langle x, T_A(x), I_A(x), F_A(x) \rangle / x \in X \}$ where $T_A(x), I_A(x), F_A(x) \in [0, 1]$ for each x in X . Therefore, the sum of $T_A(x), I_A(x)$ and $F_A(x)$ satisfies $0 \leq T_A(x) + I_A(x) + F_A(x) \leq 3$.

Let $A = \{ \langle x, T_A(x), I_A(x), F_A(x) \rangle / x \in X \}$ and $B = \{ \langle x, T_B(x), I_B(x), F_B(x) \rangle / x \in X \}$ be two single valued neutrosophic sets, and then there are the following relations.

- Complement: $A^c = \{ \langle x, \langle F_A(x), 1 - I_A(x), T_A(x) \rangle / x \in X \}$;
- Inclusion: $A \subseteq B$ if and only if $T_A(x) \leq T_B(x), I_A(x) \geq I_B(x), F_A(x) \geq F_B(x)$ for any x in X ;

- Equality: $A = B$, if and only if $A \subseteq B$ and $B \subseteq A$;
- Union: $A \cup B = \{ \langle x, T_A(x) \vee T_B(x), I_A(x) \wedge I_B(x), F_A(x) \wedge F_B(x) \rangle / x \in X \}$
- Intersection: $A \cap B = \{ \langle x, T_A(x) \wedge T_B(x), I_A(x) \vee I_B(x), F_A(x) \vee F_B(x) \rangle / x \in X \}$
- Addition: $A \oplus B = \{ \langle x, T_A(x) + T_B(x) - T_A(x) \cdot T_B(x), I_A(x) \cdot I_B(x), F_A(x) \cdot F_B(x) \rangle / x \in X \}$
- Multiplication: $A \otimes B = \{ \langle x, T_A(x) \cdot T_B(x), I_A(x) + I_B(x) - I_A(x) \cdot I_B(x), F_A(x) + F_B(x) - F_A(x) \cdot F_B(x) \rangle / x \in X \}$

2.3 Refined neutrosophic sets (Smarandache, 2013)

Let A be a refined neutrosophic set in a universal set X . Then A can be expressed as

$$A = \langle x, (T_A^1(x), T_A^2(x), \dots, T_A^p(x)), (I_A^1(x), I_A^2(x), \dots, I_A^p(x)), (F_A^1(x), F_A^2(x), \dots, F_A^p(x)), x \in X \rangle,$$

where, $0 \leq T_A^i(x), I_A^i(x), F_A^i(x) \leq 1$, $0 \leq I_A^1(x), I_A^2(x), \dots, I_A^p(x) \leq 1$, $0 \leq F_A^1(x), F_A^2(x), \dots, F_A^p(x) \leq 1$ such that $0 \leq \sup T_A^i(x) + \sup I_A^i(x) + \sup F_A^i(x) \leq 3$ for $i = 1, 2, \dots, p$, for any $x \in X$. $T_A^1(x), T_A^2(x), \dots, T_A^p(x)$, $I_A^1(x), I_A^2(x), \dots, I_A^p(x)$ and $F_A^1(x), F_A^2(x), \dots, F_A^p(x)$ are the truth-membership sequence, indeterminacy-membership sequence and falsity-membership sequence of the element x , respectively. Also, ‘ p ’ is called the dimension of neutrosophic refined sets A .

2.4 Linguistic refined neutrosophic set

Let X be a universal set and a linguistic term S represented by a refined neutrosophic set A on X . The set containing linguistic variables S which is characterized by the truth-membership sequence, indeterminacy-membership sequence and falsity-membership sequence respectively is called a linguistic refined neutrosophic set. If the dimension of refined neutrosophic set is p , then the dimension of linguistic refined neutrosophic set is also p . Some linguistic variables and corresponding refined neutrosophic numbers are presented as follows (see Table 1).

Table 1: Refined neutrosophic sets corresponding to linguistic variables

Linguistic Variables	Refined neutrosophic set
Extremely Good (EG)	$\langle (1.00, 1.00, 1.00, \dots p \text{ times}), (0.00, 0.00, 0.00, \dots p \text{ times}), (0.00, 0.00, 0.00, \dots p \text{ times}) \rangle$
Very Good (VG)	$\langle (0.90, 0.90, 0.90, \dots p \text{ times}), (0.08, 0.08, 0.08, \dots p \text{ times}), (0.08, 0.08, 0.08, \dots p \text{ times}) \rangle$
Good (G)	$\langle (0.80, 0.80, 0.80, \dots p \text{ times}), (0.20, 0.20, 0.20, \dots p \text{ times}), (0.20, 0.20, 0.20, \dots p \text{ times}) \rangle$
Medium Good (MG)	$\langle (0.60, 0.60, 0.60, \dots p \text{ times}), (0.40, 0.40, 0.40, \dots p \text{ times}), (0.30, 0.30, 0.30, \dots p \text{ times}) \rangle$
Medium (M)	$\langle (0.50, 0.50, 0.50, \dots p \text{ times}), (0.50, 0.50, 0.50, \dots p \text{ times}), (0.40, 0.40, 0.40, \dots p \text{ times}) \rangle$
Medium Bad (MB)	$\langle (0.40, 0.40, 0.40, \dots p \text{ times}), (0.40, 0.40, 0.40, \dots p \text{ times}), (0.50, 0.50, 0.50, \dots p \text{ times}) \rangle$
Bad (B)	$\langle (0.20, 0.20, 0.20, \dots p \text{ times}), (0.80, 0.80, 0.80, \dots p \text{ times}), (0.80, 0.80, 0.80, \dots p \text{ times}) \rangle$
Very Bad (VB)	$\langle (0.10, 0.10, 0.10, \dots p \text{ times}), (0.80, 0.80, 0.80, \dots p \text{ times}), (0.90, 0.90, 0.90, \dots p \text{ times}) \rangle$
Very very Bad (VVB)	$\langle (0.05, 0.05, 0.05, \dots p \text{ times}), (0.90, 0.90, 0.90, \dots p \text{ times}), (0.90, 0.90, 0.90, \dots p \text{ times}) \rangle$

Definition 2: Linguistic refined neutrosophic accumulated function (LRNAF)

Let $n_{ij} = \langle (a_{ij}^1, a_{ij}^2, \dots, a_{ij}^p), (b_{ij}^1, b_{ij}^2, \dots, b_{ij}^p), (c_{ij}^1, c_{ij}^2, \dots, c_{ij}^p) \rangle$ $i = 1, 2, \dots, m, j = 1, 2, \dots, n$ be a collection of refined neutrosophic sets of order p . Then linguistic refined neutrosophic accumulated function (LRNAF) is defined as follows:

$$LRNAF(n_{ij}) = \langle \alpha_{ij}, \beta_{ij}, \gamma_{ij} \rangle = \left\langle \frac{a_{ij}^1 + a_{ij}^2 + \dots + a_{ij}^p}{p}, \frac{b_{ij}^1 + b_{ij}^2 + \dots + b_{ij}^p}{p}, \frac{c_{ij}^1 + c_{ij}^2 + \dots + c_{ij}^p}{p} \right\rangle \quad (1)$$

$i = 1, 2, \dots, m, j = 1, 2, \dots, n$.

Definition 3: Linguistic refined neutrosophic score function (LRNSF)

Let $\langle \alpha_{ij}, \beta_{ij}, \gamma_{ij} \rangle$ be a LRNAF, and then a score function of LRNAF can be defined as follows.

$$S\langle \alpha_{ij}, \beta_{ij}, \gamma_{ij} \rangle = \frac{1}{3}(2 + \alpha_{ij} - \beta_{ij} - \gamma_{ij}), S\langle \alpha_{ij}, \beta_{ij}, \gamma_{ij} \rangle \in [0, 1] \quad (2)$$

where the larger value of $S\langle \alpha_{ij}, \beta_{ij}, \gamma_{ij} \rangle$ indicates the truth value of LRNAF is larger.

Definition 4: Weighted accumulation score value (WASV)

Weighted accumulation score value (WASV) of all criteria is presented as:

$$WASV(C_1, C_2, \dots, C_n) = \sum_{j=1}^n w_j S\langle \alpha_j, \beta_j, \gamma_j \rangle \quad (3)$$

$$\sum_{j=1}^n w_j = 1, j = 1, 2, \dots, n$$

3. DECISION MAKING METHODOLOGY

Assume that L_1, L_2, \dots, L_m be a discrete set of alternatives, C_1, C_2, \dots, C_n be the set of criteria and $K_1, K_2,$

..., K_k are the decision makers. The decision makers provide the rating of alternatives with respect to all criteria. The rating represents the performances of alternative L_i ($i = 1, 2, \dots, m$) against the criterion C_j ($j = 1, 2, \dots, n$). The values associated with the alternatives for MCGDM problem can be presented in the following decision matrix. The relation between alternatives and criteria is given in the Table 2.

Table 2: The relation between alternatives and criteria

	C_1	C_2	...	C_n
L_1	$\langle (T_{11}^1, T_{11}^2, \dots, T_{11}^p), (I_{11}^1, I_{11}^2, \dots, I_{11}^p), (F_{11}^1, F_{11}^2, \dots, F_{11}^p) \rangle$	$\langle (T_{12}^1, T_{12}^2, \dots, T_{12}^p), (I_{12}^1, I_{12}^2, \dots, I_{12}^p), (F_{12}^1, F_{12}^2, \dots, F_{12}^p) \rangle$...	$\langle (T_{1n}^1, T_{1n}^2, \dots, T_{1n}^p), (I_{1n}^1, I_{1n}^2, \dots, I_{1n}^p), (F_{1n}^1, F_{1n}^2, \dots, F_{1n}^p) \rangle$
L_2	$\langle (T_{21}^1, T_{21}^2, \dots, T_{21}^p), (I_{21}^1, I_{21}^2, \dots, I_{21}^p), (F_{21}^1, F_{21}^2, \dots, F_{21}^p) \rangle$	$\langle (T_{22}^1, T_{22}^2, \dots, T_{22}^p), (I_{22}^1, I_{22}^2, \dots, I_{22}^p), (F_{22}^1, F_{22}^2, \dots, F_{22}^p) \rangle$...	$\langle (T_{2n}^1, T_{2n}^2, \dots, T_{2n}^p), (I_{2n}^1, I_{2n}^2, \dots, I_{2n}^p), (F_{2n}^1, F_{2n}^2, \dots, F_{2n}^p) \rangle$
...
L_m	$\langle (T_{m1}^1, T_{m1}^2, \dots, T_{m1}^p), (I_{m1}^1, I_{m1}^2, \dots, I_{m1}^p), (F_{m1}^1, F_{m1}^2, \dots, F_{m1}^p) \rangle$	$\langle (T_{m2}^1, T_{m2}^2, \dots, T_{m2}^p), (I_{m2}^1, I_{m2}^2, \dots, I_{m2}^p), (F_{m2}^1, F_{m2}^2, \dots, F_{m2}^p) \rangle$...	$\langle (T_{mn}^1, T_{mn}^2, \dots, T_{mn}^p), (I_{mn}^1, I_{mn}^2, \dots, I_{mn}^p), (F_{mn}^1, F_{mn}^2, \dots, F_{mn}^p) \rangle$

The steps of the group decision making method under linguistic refined neutrosophic environment are described as follows:

Step 1: Construction of the decision matrix with linguistic refined neutrosophic sets

For MCGDM, the rating of alternative L_i ($i = 1, 2, \dots, m$) with respect to criterion C_j ($j = 1, 2, \dots, n$) is taken as refined neutrosophic environment. It can be represented with the following forms:

$$L_i = \left[\begin{array}{l} C_1 / \langle (T_{i1}^1, T_{i1}^2, \dots, T_{i1}^p), (I_{i1}^1, I_{i1}^2, \dots, I_{i1}^p), (F_{i1}^1, F_{i1}^2, \dots, F_{i1}^p) \rangle \\ C_2 / \langle (T_{i2}^1, T_{i2}^2, \dots, T_{i2}^p), (I_{i2}^1, I_{i2}^2, \dots, I_{i2}^p), (F_{i2}^1, F_{i2}^2, \dots, F_{i2}^p) \rangle \\ \dots, C_n / \langle (T_{in}^1, T_{in}^2, \dots, T_{in}^p), (I_{in}^1, I_{in}^2, \dots, I_{in}^p), (F_{in}^1, F_{in}^2, \dots, F_{in}^p) \rangle \end{array} \right]$$

$$L_i = \left[C_j / \langle (T_{ij}^1, T_{ij}^2, \dots, T_{ij}^p), (I_{ij}^1, I_{ij}^2, \dots, I_{ij}^p), (F_{ij}^1, F_{ij}^2, \dots, F_{ij}^p) \rangle \right], j=1, 2, \dots, n$$

Here $\langle (T_{ij}^1, T_{ij}^2, \dots, T_{ij}^p), (I_{ij}^1, I_{ij}^2, \dots, I_{ij}^p), (F_{ij}^1, F_{ij}^2, \dots, F_{ij}^p) \rangle$ denotes refined neutrosophic set.

The degrees of truth, indeterminacy and falsity membership of the alternative L_i satisfying the criterion C_j , respectively where

$$0 \leq T_{ij}^1, T_{ij}^2, \dots, T_{ij}^p \leq 1, 0 \leq I_{ij}^1, I_{ij}^2, \dots, I_{ij}^p \leq 1, 0 \leq F_{ij}^1, F_{ij}^2, \dots, F_{ij}^p \leq 1$$

Step 2: Determination of the linguistic refined neutrosophic accumulated decision matrix

Assume that, a linguistic refined neutrosophic set is of the form

$$\langle (T_{ij}^1, T_{ij}^2, \dots, T_{ij}^p), (I_{ij}^1, I_{ij}^2, \dots, I_{ij}^p), (F_{ij}^1, F_{ij}^2, \dots, F_{ij}^p) \rangle$$

The linguistic refined neutrosophic matrix is formed by utilizing equation (1) and it is presented in the Table 3.

Table3: The linguistic refined neutrosophic accumulated decision matrix for decision maker K_i

$$[\text{LRNAF}]_{m \times n}^{K_i} =$$

	C_1	C_2	...	C_n
L_1	$\langle \alpha_{11}, \beta_{11}, \gamma_{11} \rangle^{K_i}$	$\langle \alpha_{12}, \beta_{12}, \gamma_{12} \rangle^{K_i}$...	$\langle \alpha_{1n}, \beta_{1n}, \gamma_{1n} \rangle^{K_i}$
L_2	$\langle \alpha_{21}, \beta_{21}, \gamma_{21} \rangle^{K_i}$	$\langle \alpha_{22}, \beta_{22}, \gamma_{22} \rangle^{K_i}$...	$\langle \alpha_{2n}, \beta_{2n}, \gamma_{2n} \rangle^{K_i}$
...
L_m	$\langle \alpha_{m1}, \beta_{m1}, \gamma_{m1} \rangle^{K_i}$	$\langle \alpha_{m2}, \beta_{m2}, \gamma_{m2} \rangle^{K_i}$...	$\langle \alpha_{mn}, \beta_{mn}, \gamma_{mn} \rangle^{K_i}$

(6)

Step 3: Determination of linguistic refined neutrosophic score matrix for decision makers

Using the equation (2), aggregated transferred neutrosophic score matrix for alternative L_i ($i = 1, 2, \dots, n$) is defined as follows:

Table 4: Aggregated transferred neutrosophic score matrix for alternatives

$$\langle S \langle \alpha_{ij}, \beta_{ij}, \gamma_{ij} \rangle \rangle_{m \times n}^{K_i}$$

	C_1	C_2	...	C_n
L_1	$S \langle \alpha_{11}, \beta_{11}, \gamma_{11} \rangle^{K_i}$	$S \langle \alpha_{12}, \beta_{12}, \gamma_{12} \rangle^{K_i}$...	$S \langle \alpha_{1n}, \beta_{1n}, \gamma_{1n} \rangle^{K_i}$
L_2	$S \langle \alpha_{21}, \beta_{21}, \gamma_{21} \rangle^{K_i}$	$S \langle \alpha_{22}, \beta_{22}, \gamma_{22} \rangle^{K_i}$...	$S \langle \alpha_{2n}, \beta_{2n}, \gamma_{2n} \rangle^{K_i}$
...
L_m	$S \langle \alpha_{m1}, \beta_{m1}, \gamma_{m1} \rangle^{K_i}$	$S \langle \alpha_{m2}, \beta_{m2}, \gamma_{m2} \rangle^{K_i}$...	$S \langle \alpha_{mn}, \beta_{mn}, \gamma_{mn} \rangle^{K_i}$

(7)

Step 4: Determination of geometric mean of score matrices for decision makers

To fuse the opinions of all decision makers, we determine geometric mean of all corresponding linguistic refined neutrosophic score values (see Table 5).

Table 5: Geometric mean of score matrix for decision makers

$$\langle S \langle \alpha_{ij}, \beta_{ij}, \gamma_{ij} \rangle \rangle_{m \times n}$$

	C_1	C_2	...	C_n
L_1	$\sqrt[n]{\prod_{r=1}^k S \langle \alpha_{11}, \beta_{11}, \gamma_{11} \rangle^{K_i}}$	$\sqrt[n]{\prod_{r=1}^k S \langle \alpha_{12}, \beta_{12}, \gamma_{12} \rangle^{K_i}}$...	$\sqrt[n]{\prod_{r=1}^k S \langle \alpha_{1n}, \beta_{1n}, \gamma_{1n} \rangle^{K_i}}$
L_2	$\sqrt[n]{\prod_{r=1}^k S \langle \alpha_{21}, \beta_{21}, \gamma_{21} \rangle^{K_i}}$	$\sqrt[n]{\prod_{r=1}^k S \langle \alpha_{22}, \beta_{22}, \gamma_{22} \rangle^{K_i}}$...	$\sqrt[n]{\prod_{r=1}^k S \langle \alpha_{2n}, \beta_{2n}, \gamma_{2n} \rangle^{K_i}}$
...
L_m	$\sqrt[n]{\prod_{r=1}^k S \langle \alpha_{m1}, \beta_{m1}, \gamma_{m1} \rangle^{K_i}}$	$\sqrt[n]{\prod_{r=1}^k S \langle \alpha_{m2}, \beta_{m2}, \gamma_{m2} \rangle^{K_i}}$...	$\sqrt[n]{\prod_{r=1}^k S \langle \alpha_{mn}, \beta_{mn}, \gamma_{mn} \rangle^{K_i}}$

(8)

Step 5: Determination of weights criteria

In practical decision making situation, criteria weights may be unknown to decision makers. Also, the importance of the criteria may be different.

3.1 Method of Entropy in linguistic refined neutrosophic environment

Entropy is an important method to measure uncertain information (Shannon, 1951). Kosko (1986) proposed fuzzy entropy and conditioning. Szmidt and Kacprzyk (2001) proposed entropy function for intuitionistic fuzzy sets. Majumdar and Samanta (2014) developed entropy measures for SVNSS. Biswas et al. (2014a) also studied entropy measures for SVNSS. The entropy measure can be used to calculate the

criteria weights when it is completely unknown to decision maker.

In this paper we propose an entropy method for linguistic refined neutrosophic sets to determining unknown criteria weight. Assume that, $N = \langle (T_{i1}^1, T_{i1}^2, \dots, T_{i1}^p), (I_{i1}^1, I_{i1}^2, \dots, I_{i1}^p), (F_{i1}^1, F_{i1}^2, \dots, F_{i1}^p) \rangle$ be a refined neutrosophic set. We define entropy function in linguistic refined neutrosophic environment as follows.

$$ENT_i(N) = 1 - \frac{1}{n} \sum_{i=1}^m \left(\frac{(T_{i1}^1 + T_{i1}^2 + \dots + T_{i1}^p)}{p} + \frac{(F_{i1}^1 + F_{i1}^2 + \dots + F_{i1}^p)}{p} \right) \left| 1 - 2 \cdot \frac{(I_{i1}^1 + I_{i1}^2 + \dots + I_{i1}^p)}{p} \right| \quad (9)$$

The function has the following properties:

P1. $ENT_i(N) = 0 \Rightarrow N$ is a crisp set and $\frac{(I_{i1}^1 + I_{i1}^2 + \dots + I_{i1}^p)}{p} = 0$.

Proof. N is a crisp set and $\frac{(I_{i1}^1 + I_{i1}^2 + \dots + I_{i1}^p)}{p} = 0$

$$\Rightarrow \frac{(T_{i1}^1 + T_{i1}^2 + \dots + T_{i1}^p)}{p} = 1, \frac{(F_{i1}^1 + F_{i1}^2 + \dots + F_{i1}^p)}{p} = 0, \frac{(I_{i1}^1 + I_{i1}^2 + \dots + I_{i1}^p)}{p} = 0$$

$$\Rightarrow ENT_i(N) = 0$$

P2. $ENT_i(N) = 1 \Rightarrow \left\langle \frac{(T_{i1}^1 + T_{i1}^2 + \dots + T_{i1}^p)}{p}, \frac{(I_{i1}^1 + I_{i1}^2 + \dots + I_{i1}^p)}{p}, \frac{(F_{i1}^1 + F_{i1}^2 + \dots + F_{i1}^p)}{p} \right\rangle = \langle 0.5, 0.5, 0.5 \rangle$.

Proof. $\left\langle \frac{(T_{i1}^1 + T_{i1}^2 + \dots + T_{i1}^p)}{p}, \frac{(I_{i1}^1 + I_{i1}^2 + \dots + I_{i1}^p)}{p}, \frac{(F_{i1}^1 + F_{i1}^2 + \dots + F_{i1}^p)}{p} \right\rangle = \langle 0.5, 0.5, 0.5 \rangle$

$$\Rightarrow ENT_i(N) = 1 - \frac{1}{n} \cdot 0 = 0.$$

3. $ENT_i(N_1) \geq ENT_i(N_2) \Rightarrow$

$$\left(\frac{(T_{i1}^1 + T_{i1}^2 + \dots + T_{i1}^p)}{p} + \frac{(F_{i1}^1 + F_{i1}^2 + \dots + F_{i1}^p)}{p} \right)_{\text{for } N_1} \leq \left(\frac{(T_{i1}^1 + T_{i1}^2 + \dots + T_{i1}^p)}{p} + \frac{(F_{i1}^1 + F_{i1}^2 + \dots + F_{i1}^p)}{p} \right)_{\text{for } N_2}$$

and $\left| 1 - 2 \cdot \frac{(I_{i1}^1 + I_{i1}^2 + \dots + I_{i1}^p)}{p} \right|_{\text{for } N_1} \leq \left| 1 - 2 \cdot \frac{(I_{i1}^1 + I_{i1}^2 + \dots + I_{i1}^p)}{p} \right|_{\text{for } N_2}$

Proof.

$$\left(\frac{(T_{i1}^1 + T_{i1}^2 + \dots + T_{i1}^p)}{p} + \frac{(F_{i1}^1 + F_{i1}^2 + \dots + F_{i1}^p)}{p} \right)_{\text{for } N_1} \leq \left(\frac{(T_{i1}^1 + T_{i1}^2 + \dots + T_{i1}^p)}{p} + \frac{(F_{i1}^1 + F_{i1}^2 + \dots + F_{i1}^p)}{p} \right)_{\text{for } N_2}$$

and $\left| 1 - 2 \cdot \frac{(I_{i1}^1 + I_{i1}^2 + \dots + I_{i1}^p)}{p} \right|_{\text{for } N_1} \leq \left| 1 - 2 \cdot \frac{(I_{i1}^1 + I_{i1}^2 + \dots + I_{i1}^p)}{p} \right|_{\text{for } N_2}$

$$\Rightarrow \left[1 - \frac{1}{n} \sum_{i=1}^m \left(\frac{(T_{i1}^1 + T_{i1}^2 + \dots + T_{i1}^p)}{p} + \frac{(F_{i1}^1 + F_{i1}^2 + \dots + F_{i1}^p)}{p} \right) \left| 1 - 2 \cdot \frac{(I_{i1}^1 + I_{i1}^2 + \dots + I_{i1}^p)}{p} \right| \right]_{\text{for } N_1}$$

$$\geq \left[1 - \frac{1}{n} \sum_{i=1}^m \left(\frac{(T_{i1}^1 + T_{i1}^2 + \dots + T_{i1}^p)}{p} + \frac{(F_{i1}^1 + F_{i1}^2 + \dots + F_{i1}^p)}{p} \right) \left| 1 - 2 \cdot \frac{(I_{i1}^1 + I_{i1}^2 + \dots + I_{i1}^p)}{p} \right| \right]_{\text{for } N_2}$$

$$\Rightarrow ENT_i(N_1) \geq ENT_i(N_2)$$

P4. $ENT_i(N_1) = ENT_i(N_1^c)$.

Proof.

$$\text{ENT}_i(N_j) = 1 - \frac{1}{n} \sum_{i=1}^m \left(\frac{(T_{i1}^1 + T_{i1}^2 + \dots + T_{i1}^p)}{p} + \frac{(F_{i1}^1 + F_{i1}^2 + \dots + F_{i1}^p)}{p} \right) \left| 1 - 2 \cdot \frac{(I_{i1}^1 + I_{i1}^2 + \dots + I_{i1}^p)}{p} \right|_{\text{for } N_j}$$

$$\text{ENT}_i(N_j^c) = 1 - \frac{1}{n} \sum_{i=1}^m \left(\frac{(F_{i1}^1 + F_{i1}^2 + \dots + F_{i1}^p)}{p} + \frac{(T_{i1}^1 + T_{i1}^2 + \dots + T_{i1}^p)}{p} \right) \left| 1 - 2 \cdot \frac{(I_{i1}^1 + I_{i1}^2 + \dots + I_{i1}^p)}{p} \right|_{\text{for } N_j^c}$$

Hence, $\text{ENT}_i(N_j) = \text{ENT}_i(N_j^c)$.

In order to obtain the entropy value ENT_j of the j -th criterion C_j ($j = 1, 2, \dots, n$), equation (16) can be written as :

$$\text{ENT}_i(N) = 1 - \frac{1}{n} \sum_{i=1}^m \left(\frac{(T_{i1}^1, T_{i1}^2, \dots, T_{i1}^p)}{p} + \frac{(F_{i1}^1, F_{i1}^2, \dots, F_{i1}^p)}{p} \right) \left| 1 - 2 \cdot \frac{(I_{i1}^1 + I_{i1}^2 + \dots + I_{i1}^p)}{p} \right| \quad (10)$$

For $i = 1, 2, \dots, n$; $j = 1, 2, \dots, m$

It is observed that $\text{ENT}_j \in [0,1]$. The entropy weight of the j -th criterion C_j in refined neutrosophic environment is presented as:

$$w_j = \frac{1 - \text{ENT}_j}{\sum_{j=1}^n (1 - \text{ENT}_j)} \quad (11)$$

We have weight vector $W = (w_1, w_2, \dots, w_n)^T$ of n criteria C_j ($j = 1, 2, \dots, n$) with $w_j \geq 0$ and $\sum_{j=1}^n w_j = 1$

Step 6: Determination of weighted accumulation score values (WASV)

Using equation (3), weighted accumulation score values (WASVs) for all alternatives corresponding to each criterion are defined as following matrix (see Table 6).

Table 6: Weighted accumulated score matrix

.	C_1	C_2	...	C_n
L_1	$WASV_{11}$	$WASV_{12}$...	$WASV_{1n}$
L_2	$WASV_{21}$	$WASV_{22}$...	$WASV_{2n}$
...
L_m	$WASV_{m1}$	$WASV_{m2}$...	$WASV_{mn}$

(12)

Step 7: Calculate extreme averaging score values

We define extreme averaging score values (EASVs) to aggregate all weighted accumulated score values as follows.

$$\text{EASV}(L_i) = \sum_{j=1}^n \text{WASV}_{ij} \quad i = 1, 2, \dots, n. \quad (13)$$

Step 8: Rank the priority

The set of alternatives then can be preference ranked according to the descending order of the extreme averaging score value $\text{EASV}(L_i)$.

The alternative corresponding to the highest extreme averaging score value reflects the best choice.

Step 9: End.

4. AN ILLUSTRATIVE EXAMPLE

A financial grand for Birnagar High School, West Bengal, India has been sanctioned from West Bengal

State Government to construct a modern sanitary system. For this purpose, school managing committee call for a meeting to select best spot for sanitary system construction. Three decision makers of the school are Headmaster (K_1), Assistant headmaster (K_2) and President (K_3). There are three potential spots in school boundary (marked as L_1, L_2, L_3) are chosen for final selection. Decision makers intended to select the best spot among L_1, L_2, L_3 with respect to six criteria namely,

- Distance form students (C_1),
- Water supply (C_2),
- Future maintenance (C_3),
- Costs for construction (C_4),
- Governmental Regulations and Laws (C_5),
- Environmental Impact (C_6).

Three alternatives (L_1, L_2, L_3) with respect to the six criteria ($C_1, C_2, C_3, C_4, C_5, C_6$) are evaluated by three decision makers (K_1, K_2, K_3) under the linguistic refined neutrosophic environment, thus we can establish the linguistic variables in terms of refined neutrosophic sets (LRNS) (see Table 7):

Table 7: Assessments of alternatives and criteria given by three decision makers in terms of linguistic variables

Alternatives	Decision Makers	C_1	C_2	C_3	C_4	C_5	C_6
L_1	K_1	EG	VG	G	EG	VG	G
	K_2	VG	G	G	EG	G	VG
	K_3	VG	VG	G	EG	VG	G
L_2	K_1	VG	VG	VG	VG	G	G
	K_2	VG	G	G	VG	VG	G
	K_3	VG	G	G	EG	G	G
L_3	K_1	EG	G	VG	VG	VG	VG
	K_2	VG	G	G	VG	G	VG
	K_3	VG	VG	G	VG	G	VG

Step 1: Construction of the decision matrix with linguistic refined neutrosophic sets

Three decision makers form decision matrix in terms of refined neutrosophic number corresponding to each logistic center. The decision matrices are described in Table 4, Table 5, and Table 6.

Table 8: Decision matrix for K_1

	C_1	C_2	C_3	C_4	C_5	C_6
L_1	$\left((1.00, 1.00, \dots p \text{ times}), (0.00, 0.00, \dots p \text{ times}), (0.00, 0.00, \dots p \text{ times}) \right)$	$\left((0.90, 0.90, \dots p \text{ times}), (0.80, 0.80, \dots p \text{ times}), (0.08, 0.08, \dots p \text{ times}) \right)$	$\left((0.80, 0.80, \dots p \text{ times}), (0.20, 0.20, \dots p \text{ times}), (0.20, 0.20, \dots p \text{ times}) \right)$	$\left((1.00, 1.00, \dots p \text{ times}), (0.00, 0.00, \dots p \text{ times}), (0.00, 0.00, \dots p \text{ times}) \right)$	$\left((0.90, .090, \dots p \text{ times}), (0.80, 0.80, \dots p \text{ times}), (0.08, 0.08, \dots p \text{ times}) \right)$	$\left((0.80, 0.80, \dots p \text{ times}), (0.20, 0.20, \dots p \text{ times}), (0.20, 0.20, \dots p \text{ times}) \right)$
L_2	$\left((0.90, 0.90, \dots p \text{ times}), (0.80, 0.80, \dots p \text{ times}), (0.08, 0.08, \dots p \text{ times}) \right)$	$\left((0.80, 0.80, \dots p \text{ times}), (0.20, 0.20, \dots p \text{ times}), (0.20, 0.20, \dots p \text{ times}) \right)$	$\left((0.80, 0.80, \dots p \text{ times}), (0.20, 0.20, \dots p \text{ times}), (0.20, 0.20, \dots p \text{ times}) \right)$	$\left((1.00, 1.00, \dots p \text{ times}), (0.00, 0.00, \dots p \text{ times}), (0.00, 0.00, \dots p \text{ times}) \right)$	$\left((0.80, 0.80, \dots p \text{ times}), (0.20, 0.20, \dots p \text{ times}), (0.20, 0.20, \dots p \text{ times}) \right)$	$\left((0.90, 0.90, \dots p \text{ times}), (0.80, 0.80, \dots p \text{ times}), (0.08, 0.08, \dots p \text{ times}) \right)$
L_3	$\left((0.90, 0.90, \dots p \text{ times}), (0.80, 0.80, \dots p \text{ times}), (0.08, 0.08, \dots p \text{ times}) \right)$	$\left((0.90, 0.90, \dots p \text{ times}), (0.80, 0.80, \dots p \text{ times}), (0.08, 0.08, \dots p \text{ times}) \right)$	$\left((0.80, 0.80, \dots p \text{ times}), (0.20, 0.20, \dots p \text{ times}), (0.20, 0.20, \dots p \text{ times}) \right)$	$\left((1.00, 1.00, \dots p \text{ times}), (0.00, 0.00, \dots p \text{ times}), (0.00, 0.00, \dots p \text{ times}) \right)$	$\left((0.90, 0.90, \dots p \text{ times}), (0.80, 0.80, \dots p \text{ times}), (0.08, 0.08, \dots p \text{ times}) \right)$	$\left((0.80, 0.80, \dots p \text{ times}), (0.20, 0.20, \dots p \text{ times}), (0.20, 0.20, \dots p \text{ times}) \right)$

Step 3: Determination of linguistic refined neutrosophic score matrix for decision makers

Using the equation (2), linguistic refined neutrosophic score matrix for alternative L_i ($i = 1, 2, 3$) is presented as follows (see Table 10, Table 11, and Table 12):

Table 14: Linguistic refined neutrosophic score matrix for decision maker K_1

	C_1	C_2	C_3	C_4	C_5	C_6
L_1	1.00	0.91	0.80	1.00	0.91	0.80
L_2	0.91	0.80	0.80	1.00	0.80	0.91
L_3	0.91	0.91	0.80	1.00	0.91	0.80

Table 15: Linguistic refined neutrosophic score matrix for decision maker K_2

	C_1	C_2	C_3	C_4	C_5	C_6
L_1	0.91	0.91	0.91	0.91	0.80	0.80
L_2	0.91	0.80	0.80	0.91	0.91	0.80
L_3	0.91	0.80	0.80	1.00	0.80	0.80

Table 16: Linguistic refined neutrosophic score matrix for decision maker K_3

	C_1	C_2	C_3	C_4	C_5	C_6
L_1	1.00	0.80	0.91	0.91	0.91	0.91
L_2	0.91	0.80	0.80	0.91	0.80	0.91
L_3	0.91	0.91	0.80	0.91	0.80	0.91

Step 4: Determination of geometric mean of score matrices for decision makers

Using equation (8), we calculate geometric mean of score values as follows.

Table 17: Geometric mean of score matrix for decision makers

	C_1	C_2	C_3	C_4	C_5	C_6
L_1	0.9691	0.8717	0.8717	0.9391	0.8717	0.8351
L_2	0.9100	0.8000	0.8000	0.9391	0.8351	0.8717
L_3	0.9100	0.8717	0.8000	0.9691	0.8351	0.8351

Step 5: Determination of weights criteria

Using equation (11), weight structure is calculated as follows:

$$w_1 = 0.15, w_2 = 0.20, w_3 = 0.15, w_4 = 0.20, w_5 = 0.10 \text{ and } w_6 = 0.20$$

Step 6: Determination of weighted accumulation score values (WASV)

Using equation (3), weighted accumulation score values (WASV) of all decision makers corresponding to each alternative is presented in Table 18.

Table 18: Weighted accumulated score matrix

	C_1	C_2	C_3	C_4	C_5	C_6
L_1	0.1454	0.1740	0.1308	0.1878	0.0872	0.1670
L_2	0.1365	0.1600	0.1200	0.1878	0.0835	0.1743
L_3	0.1365	0.1740	0.1200	0.1938	0.0835	0.1670

Step 7: Calculate extreme averaging score values

According to the weighted accumulated score values, extreme averaging score values (EASV) are calculated as follows.

$$\text{EASV}(L_1) = 0.8922, \text{EASV}(L_2) = 0.8548, \text{EASV}(L_3) = 0.8748;$$

Step 8: Rank the priority

All the extreme averaging score values are arranged in descending order. Alternatives then can be preference ranked as follows: $\text{EASV}(L_1) > \text{EASV}(L_3) > \text{EASV}(L_2)$.

So, L_1 is the best potential spot to construct a modern sanitary system for students for Birnagar High School.

Step 9: End

5. CONCLUSION

Linguistic values are rational and direct tools for decision makers to express qualitative evaluations under uncertainty characterized by indeterminacy. We employed refined neutrosophic set to express linguistic variables. Linguistic refined neutrosophic set is proposed. We have developed a multi-criteria decision making method based on linguistic refined neutrosophic set. We also proposed an entropy method to determine unknown weights of the criteria in linguistic neutrosophic refined set environment. An illustrative example of constructional spot selection has also been provided. The proposed concept can be used other practical decision making problems such as medical diagnosis, cluster analysis, pattern recognition, etc.

REFERENCES

- Ali, M., Deli, I., & Smarandache, F. (2016). The theory of neutrosophic cubic sets and their applications in pattern recognition. *Journal of Intelligent and Fuzzy Systems*, 30 (4), 1957–1963.
- Atanassov, K. T. (1986). Intuitionistic fuzzy sets. *Fuzzy Sets and Systems*, 20 (1), 87–96. [https://doi.org/10.1016/S0165-0114\(86\)80034-3](https://doi.org/10.1016/S0165-0114(86)80034-3)
- Biswas, P., Pramanik, S., & Giri, B. C. (2014a). Entropy based grey relational analysis method for multi-attribute decision making under single valued neutrosophic assessments. *Neutrosophic Sets and Systems*, 2, 102–110.
- Biswas, P., Pramanik, S., & Giri, B. C. (2014b). A new methodology for neutrosophic multi-attribute decision making with unknown weight information. *Neutrosophic Sets and Systems*, 3, 42–52.
- Biswas, P., Pramanik, S., & Giri, B. C. (2015a). TOPSIS method for multi-attribute group decision-making under single valued neutrosophic environment. *Neural Computing and Applications*, 27 (3), 727–737. doi: 10.1007/s00521-015-1891-2.
- Biswas, P., Pramanik, S., & Giri, B. C. (2015b). Cosine similarity measure based multi-attribute decision-making with trapezoidal fuzzy neutrosophic numbers. *Neutrosophic Sets and Systems*, 8, 47–57.

- Biswas, P., Pramanik, S., & Giri, B. C. (2016a). Aggregation of triangular fuzzy neutrosophic set information and its application to multi-attribute decision making. *Neutrosophic Sets and Systems*, 12, 20–40.
- Biswas, P., Pramanik, S., & Giri, B. C. (2016b). Value and ambiguity index based ranking method of single-valued trapezoidal neutrosophic numbers and its application to multi-attribute decision making. *Neutrosophic Sets and Systems*, 12, 127–138.
- Broumi, S., & Deli, I. (2014). Correlation measure for neutrosophic refined sets and its application in medical diagnosis. *Palestine Journal of Mathematics*, 3 (1), 11–19.
- Broumi, S., Smarandache, F., & Dhar, M. (2014). Neutrosophic refined similarity measure based on cosine function. *Neutrosophic Sets and Systems*, 6, 41–47.
- Broumi, S., Smarandache, F., & Dhar, M. (2014). Rough neutrosophic sets. *Italian Journal of Pure and Applied Mathematics*, 32, 493–502.
- Deli, I., Ali, M., & Smarandache, F. (2015a). Bipolar neutrosophic sets and their applications based on multicriteria decision making problems. *Advanced Mechatronic Systems, (ICAMechs), International Conference*, 249–254. doi: [10.1109/ICAMechS.2015.7287068](https://doi.org/10.1109/ICAMechS.2015.7287068)
- Kharal, A (2014). A neutrosophic multi-criteria decision making method. *New Mathematics and Natural Computation*, 10 (2), 143–162.
- Kosko, B. (1986). Fuzzy entropy and conditioning. *Information Sciences*, 40(2), 165–174. [https://doi.org/10.1016/0020-0255\(86\)90006-X](https://doi.org/10.1016/0020-0255(86)90006-X)
- Maji, P. K. (2013). Neutrosophic soft set. *Annals of Fuzzy Mathematics and Informatics* 5 (1), 157–168.
- Majumdar, P., & Samanta, S. . K. (2014). On similarity and entropy of neutrosophic sets. *Journal of Intelligent and Fuzzy Systems*, 26 (3), 1245–1252.
- Mondal, K., & Pramanik, S. (2014a). A study on problems of Hijras in West Bengal based on neutrosophic cognitive maps. *Neutrosophic Sets and Systems*, 5, 21–26.
- Mondal, K., & Pramanik, S. (2014b). Multi-criteria group decision making approach for teacher recruitment in higher education under simplified neutrosophic environment. *Neutrosophic Sets and Systems*, 6, 28–34.
- Mondal, K., & Pramanik, S. (2015a). Cosine similarity measure of rough neutrosophic sets and its application in medical diagnosis. *Global Journal of Advanced Research*, 2 (1), 212–220.
- Mondal, K., & Pramanik, S. (2015b). Neutrosophic refined similarity measure based on tangent function and its application to multi attribute decision making. *Journal of New Theory*, 8, 41–50.
- Mondal, K., & Pramanik, S. (2015c). Neutrosophic tangent similarity measure and its application to multiple attribute decision making. *Neutrosophic Sets and Systems*, 9, 85–92.
- Mondal, K., & Pramanik, S. (2015d). Rough neutrosophic multi-attribute decision-making based on grey

- relational analysis. *Neutrosophic Sets and Systems*, 7, 8–17.
- Mondal, K., & Pramanik, S. (2015e). Tri-complex rough neutrosophic similarity measure and its application in multi-attribute decision making. *Critical Review*, 11, 26–40.
- Mondal, K., Pramanik, S., & Smarandache, F. (2016a). Multi-attribute decision making based on rough neutrosophic variational coefficient similarity measure. *Neutrosophic Sets and Systems*, 13, 3–17.
- Mondal, K., Pramanik, S., & Smarandache, F. (2016b). Rough neutrosophic TOPSIS for multi-attribute group decision making. *Neutrosophic Sets and Systems*, 13, 105–117.
- Pramanik, S., & Chackrabarti, S. N. (2013). A study on problems of construction workers in West Bengal based on neutrosophic cognitive maps. *International Journal of Innovative Research in Science Engineering and Technology*, 2 (11), 6387–6394.
- Pramanik, S., & Mondal, K. (2015). Cotangent similarity measure of rough neutrosophic sets and its application to medical diagnosis. *Journal of New Theory*, 4, 90–102.
- Pramanik, S., & Mondal, K. (2016). Rough bipolar neutrosophic set. *Global Journal of Engineering Science and Research Management*, 3 (6), 71–81.
- Pramanik, S., Roy, R., Roy, T. K., & Smarandache, F. (2017). Multi criteria decision making using correlation coefficient under rough neutrosophic environment. *Neutrosophic Sets and Systems*, 17, 29–36.
- Pramanik, S., & Roy, T. K. (2014). Neutrosophic game theoretic approach to Indo-Pak conflict over Jammu-Kashmir. *Neutrosophic Sets and Systems*, 2 (1), 82–101.
- Şahin, R. (2017). Normal neutrosophic multiple attribute decision making based on generalized prioritized aggregation operators. *Neural Computing and Applications*. <https://doi.org/10.1007/s00521-017-2896-9>
- Şahin, R., & Liu, P. (2016). Maximizing deviation method for neutrosophic multiple attribute decision making with incomplete weight information. *Neural Computing and Applications*, 27 (7), 2017–2029. <https://doi.org/10.1007/s00521-015-1995-8>
- Shannon, C. E. (1951). Prediction and entropy of printed english. *Bell System Technical Journal*, 30 (1), 50–64. <https://doi.org/10.1002/j.1538-7305.1951.tb01366.x>
- Smarandache, F. (1998). *Neutrosophy: neutrosophic probability, set, and logic: analytic synthesis & synthetic analysis*. Rehoboth: American Research Press.
- Smarandache, F. (2013). n-Valued refined neutrosophic logic and its applications in physics. *Progress in Physics*, 4, 143–146.
- Sodenkamp, M. (2013). *Models, methods and applications of group multiple-criteria decision analysis in complex and uncertain systems*. Dissertation, University of Paderborn, Germany.
- Szmidt, E., & Kacprzyk, J. (2001). Entropy for intuitionistic fuzzy sets. *Fuzzy Sets and Systems*, 118 (3),

467–477. [https://doi.org/10.1016/S0165-0114\(98\)00402-3](https://doi.org/10.1016/S0165-0114(98)00402-3)

- Wang, H., Smarandache, F., Zhang, Y., & Sunderraman, R. (2010). Single valued neutrosophic sets. *Multispace & Multistructure*, 4, 410–413.
- Ye, J. (2015a). Improved cosine similarity measures of simplified neutrosophic sets for medical diagnoses. *Artificial Intelligence in Medicine*, 63 (3), 171–179. <https://doi.org/10.1016/j.artmed.2014.12.007>
- Ye, J. (2015b). Improved cross entropy measures of single valued neutrosophic sets and interval neutrosophic sets and their multicriteria decision making methods. *Cybernetics and Information Technologies*, 15 (4), 13–26. <https://doi.org/10.1515/cait-2015-0051>
- Ye, J. (2016). Fault diagnoses of steam turbine using the exponential similarity measure of neutrosophic numbers. *Journal of Intelligent & Fuzzy Systems*, 30 (4), 1927–1934.
- Ye, J., & Fu, J. (2016). Multi-period medical diagnosis method using a single valued neutrosophic similarity measure based on tangent function. *Computer Methods and Programs in Biomedicine*, 123, 142–149. <https://doi.org/10.1016/j.cmpb.2015.10.002>
- Ye, S., & Ye, J. (2014). Dice similarity measure between single valued neutrosophic multisets and its application in medical diagnosis. *Neutrosophic Sets and Systems*, 6, 48–53.
- Zadeh, L. A. (1965). Fuzzy sets. *Information and Control*, 8 (3), 338–353.

TODIM Method for Group Decision Making under Bipolar Neutrosophic Set Environment

Surapati Pramanik^{1*}, Shyamal Dalapati², Shariful Alam³, Tapan Kumar Roy⁴

¹ Department of Mathematics, Nandalal Ghosh B.T. College, Panpur, P.O.-Narayanpur, District –North 24 Parganas, Pin code-743126, West Bengal, India. ^{1*}E-mail: sura_pati@yahoo.co.in

² Department of Mathematics, Indian Institute of Engineering Science and Technology, Shibpur, P.O.-Botanic Garden, Howrah-711103, West Bengal,

India. E-mail: dalapatishyamal30@gmail.com

³ Department of Mathematics, Indian Institute of Engineering Science and Technology, Shibpur, P.O.-Botanic Garden, Howrah-711103, West Bengal,

India. E-mail: salam50in@yahoo.co.in

⁴Department of Mathematics, Indian Institute of Engineering Science and Technology, Shibpur, P.O.-Botanic Garden, Howrah-711103, West Bengal,

India. E-mail: roy_t_k@yahoo.co.in

ABSTRACT

Classical TODIM (an acronym in Portuguese for Interactive Multi criteria Decision Making) method works on crisp numbers to solve multi-attribute group decision making problems. In this paper, we define TODIM method in bipolar neutrosophic set environment to handle multi-attribute group decision making problems, which means we combine the TODIM with bipolar neutrosophic number to deal with multi-attribute group decision making problems. We have proposed a new method for solving multi-attribute group decision making problems. Finally, we solve multi-attribute group decision making problem using our newly proposed TODIM method to show the applicability and effectiveness of the proposed method.

Keywords: Bipolar neutrosophic sets, TODIM method, Multi attribute group decision making.

1. INTRODUCTION

There exist many decision making methods (Triantaphyllou, 2000; Hwang & Yoon, 1981; Shanian & Savadogo, 2009; Chan & Tong, 2007; Rao & Davim, 2008; Gomes & Lima, 1992) in the literature to deal with multi attribute group decision making (MAGDM) problems which are frequently meet in many fields such as politics, economy, military, etc. In classical methods for MAGDM attribute values are assumed as crisp numbers. In realistic decision making problem uncertainty involves due to the complexity of the problem. So crisp numbers are not sufficient to characterize attribute values. To handle this type of difficulties, Zadeh (1965) introduced the concept of fuzzy set by defining membership function. Atanassov (1986) incorporated non-membership function as independent component and defined intuitionistic fuzzy set to deal with uncertainty. Intuitionistic fuzzy set has been rapidly applied to many MADM fields (Gumus et al., 2016; Mondal & Pramanik, 2014c; Mondal & Pramanik, 2015a; Dey et al., 2015; Pramanik & Mukhopadhyaya, 2011; Xu, 2007; Xu & Yager, 2008; Atanassov et al., 2005; Wei, 2010).

Smarandache (1998) introduced the notion of neutrosophic set by incorporating indeterminacy as independent component to intuitionistic fuzzy set. For dealing with the imperfection knowledge received from real world decision making problems, Wang et al. (2010) defined single valued neutrosophic set (SVNS), which is an instance of neutrosophic set.

Neutrosophic sets and SVNSs are essential topics for research in different route of research such as conflict resolution (Pramanik & Roy, 2014), clustering analysis (Ye, 2014a, 2014b), decision making (Biswas et al., 2014a, 2014b, 2015a, 2015b, 2016a, 2016b; Deli & Subas, 2016; Ji, Wang et al., 2016; Kharal, 2014; Pramanik, Banerjee et al., 2016; Pramanik, Dalapati et al., 2016; Ye, 2013a, 2013b, 2014c, 2014d, 2015a, 2015b, 2017), educational problem (Mondal & Pramanik 2014b, 2015b), medical diagnosis (Ye, 2015c), optimization (Pramanik, 2016a, 2016b; Roy & Das, 2015), social problem (Mondal & Pramanik, 2014a; Pramanik & Chakrabarti, 2013), and so on.

Deli et al. (2015) defined bipolar neutrosophic sets and applied it to MCDM problems. Pramanik and Mondal (2016) defined bipolar rough neutrosophic set. Dey et al. (2016) defined TOPSIS for solving MADM problems under bipolar neutrosophic set environment.

Firstly, Gomes and Lima (1992) introduced TODIM method on the basis of the prospect theory (Kahneman & Tversky, 1979).

Krohling & De Souza (2012) developed a generalized version of TODIM called fuzzy TODIM to deal with fuzzy information. Researchers presented fuzzy TODIM methods in varied fuzzy MADM or MAGDM problems (Liu & Teng, 2014; Tosun & Akyu, 2015; Gomes et al., 2013). Fan et al. (2013) extended TODIM method to deal with the hybrid MADM problems where attribute values are crisp numbers, interval numbers and fuzzy information.

Krohling et al. (2013) studied intuitionistic fuzzy TODIM for MCDM problems. Lourenzutti & Krohling (2013) proposed intuitionistic fuzzy random TODIM method which deals intuitionistic fuzzy information and an underlying random vector that affects the performance of the alternatives. Krohling, R. A., & Pacheco proposed interval-valued intuitionistic fuzzy TODIM to tackle MCDM problems involving uncertainty characterized by interval-valued intuitionistic fuzzy numbers.

Wang (2015) extended TODIM method for MCDM in multi-valued neutrosophic set environment. Ji, Zhang et al. (2016) define projection based TODIM method under multi-valued neutrosophic environment and applied it to personal selection. Zhang et al. (2016) proposed TODIM method for group decision making in neutrosophic environment using neutrosophic numbers (Smarandache, 1998) in the form $a + bI$, where 'a' denotes real part and 'bI' denotes indeterminate part. Bipolar neutrosophic numbers are more suitable to deal with the uncertain information and the TODIM is a good decision making method based on prospect theory. Our objective is to propose an extended TODIM method to deal with multi-criteria group decision making problems in which the evaluation information is expressed by bipolar neutrosophic numbers.

Literature review suggests that TODIM method in bipolar neutrosophic set is yet to appear. To fill the gap, we develop a novel TODIM method for MAGDM in bipolar neutrosophic environment. A numerical example of MAGDM problem in bipolar neutrosophic set environment is solved to show the effectiveness of the proposed method.

Rest of the paper is presented as follows: Section 2 recalls some basic definitions of neutrosophic sets, single valued neutrosophic sets, bipolar neutrosophic set. Section 3 develops a novel MAGDM method based on TODIM method in bipolar neutrosophic set environment. Section 4 solves an illustrative example of MAGDM based on proposed TODIM method in bipolar neutrosophic environment. Finally, section 5 presents concluding remarks and future scope of research.

2. PRELIMINARIES

In this section we recall some basic definitions related to neutrosophic sets, bipolar neutrosophic sets and TODIM method.

Definition 2.1: Neutrosophic Set (Smarandache, 1998)

Let U be a space of points (objects), with a generic element in U denoted by u . A neutrosophic sets A in U is characterized by a truth-membership function $\mu_A(u)$, an indeterminacy-membership function $\nu_A(u)$ and a falsity-membership function $\delta_A(u)$,

where, $\mu_A(u), \nu_A(u), \delta_A(u) : U \rightarrow]^-0, 1^+]$.

Neutrosophic set A can be written as:

$A = \{ \langle u, (\mu_A(u), \nu_A(u), \delta_A(u)) \rangle : u \in U, \mu_A(u), \nu_A(u), \delta_A(u) \in]^-0, 1^+]$. There is no restriction on the sum of $\mu_A(u), \nu_A(u), \delta_A(u)$ so $^-0 \leq \mu_A(u) + \nu_A(u) + \delta_A(u) \leq 3^+$.

Definition 2.2: Single Valued Neutrosophic Set (Wang et al., 2010)

Let U be a space of points (objects) with a generic element in U denoted by u . A single valued neutrosophic set H in U is characterized by a truth-membership function $\mu_H(u)$, an indeterminacy-membership function $\nu_H(u)$ and a falsity-membership function $\delta_H(u)$, where,

$\mu_H(u), \nu_H(u), \delta_H(u) : U \rightarrow [0, 1]$. A single valued neutrosophic set H can be expressed by $H = \{ \langle u, (\mu_H(u), \nu_H(u), \delta_H(u)) \rangle, u \in U \}$. Therefore for each $u \in U$, $\mu_H(u), \nu_H(u), \delta_H(u) \in [0, 1]$ the sum of three functions lies between 0 and 1, i.e. $0 \leq \mu_H(u) + \nu_H(u) + \delta_H(u) \leq 3$.

Definition 2.3: Bipolar Neutrosophic Set (Deli et al., 2015)

Let U be a space of points (objects) with a generic element in U denoted by u . A bipolar neutrosophic set B in U is defined as an object of the form

$B = \{ \langle u, \mu^+(u), \nu^+(u), \delta^+(u), \mu^-(u), \nu^-(u), \delta^-(u) \rangle : u \in U \}$, where, $\mu^+(u), \nu^+(u), \delta^+(u) : U \rightarrow [0, 1]$ and $\mu^-(u), \nu^-(u), \delta^-(u) : U \rightarrow [-1, 0]$. We denote $B = \{ \langle u, \mu^+(u), \nu^+(u), \delta^+(u), \mu^-(u), \nu^-(u), \delta^-(u) \rangle : u \in U \}$ simply $b = \langle \mu^+, \nu^+, \delta^+, \mu^-, \nu^-, \delta^- \rangle$ as a bipolar neutrosophic number (BNN).

Definition 2.4: Containment of Two Bipolar Neutrosophic Sets (Deli et al., 2015)

Let $B_1 = \{ \langle u, \mu_1^+(u), \nu_1^+(u), \delta_1^+(u), \mu_1^-(u), \nu_1^-(u), \delta_1^-(u) \rangle : u \in U \}$ and

$B_2 = \{ \langle u, \mu_2^+(u), \nu_2^+(u), \delta_2^+(u), \mu_2^-(u), \nu_2^-(u), \delta_2^-(u) \rangle : u \in U \}$ be any two bipolar neutrosophic sets in U . Then $B_1 \subseteq B_2$ iff $\mu_1^+(u) \leq \mu_2^+(u)$, $\nu_1^+(u) \geq \nu_2^+(u)$, $\delta_1^+(u) \geq \delta_2^+(u)$ and $\mu_1^-(u) \geq \mu_2^-(u)$, $\nu_1^-(u) \leq \nu_2^-(u)$, $\delta_1^-(u) \leq \delta_2^-(u)$ for all $u \in U$.

Definition 2.5: Equality of Two Bipolar Neutrosophic Sets (Deli et al., 2015)

Let $B_1 = \{ \langle u, \mu_1^+(u), \nu_1^+(u), \delta_1^+(u), \mu_1^-(u), \nu_1^-(u), \delta_1^-(u) \rangle : u \in U \}$ and $B_2 = \{ \langle u, \mu_2^+(u), \nu_2^+(u), \delta_2^+(u), \mu_2^-(u), \nu_2^-(u), \delta_2^-(u) \rangle : u \in U \}$ be any two bipolar neutrosophic sets in U . Then, $B_1 = B_2$ iff $\mu_1^+(u) = \mu_2^+(u)$, $\nu_1^+(u) = \nu_2^+(u)$, $\delta_1^+(u) = \delta_2^+(u)$ and $\mu_1^-(u) = \mu_2^-(u)$, $\nu_1^-(u) = \nu_2^-(u)$, $\delta_1^-(u) = \delta_2^-(u)$ for all $u \in U$.

Definition 2.6: Union of Two Bipolar Neutrosophic Sets (Deli et al., 2015)

Let $B_1 = \{ \langle u, \mu_1^+(u), \nu_1^+(u), \delta_1^+(u), \mu_1^-(u), \nu_1^-(u), \delta_1^-(u) \rangle : u \in U \}$ and $B_2 = \{ \langle u, \mu_2^+(u), \nu_2^+(u), \delta_2^+(u), \mu_2^-(u), \nu_2^-(u), \delta_2^-(u) \rangle : u \in U \}$ be any two bipolar neutrosophic sets in U . Then, their union is defined as

$$B_3(u) = B_1(u) \cup B_2(u) = \{ \langle u, \max(\mu_1^+(u), \mu_2^+(u)), \max(\nu_1^+(u), \nu_2^+(u)), \min(\delta_1^+(u), \delta_2^+(u)), \min(\mu_1^-(u), \mu_2^-(u)), \min(\nu_1^-(u), \nu_2^-(u)), \max(\delta_1^-(u), \delta_2^-(u)) \rangle : u \in U \}, \text{ for all } u \in U.$$

Definition 2.7: Intersection of Two Bipolar Neutrosophic Sets (Deli et al., 2015)

Let $B_1 = \{ \langle u, \mu_1^+(u), \nu_1^+(u), \delta_1^+(u), \mu_1^-(u), \nu_1^-(u), \delta_1^-(u) \rangle : u \in U \}$ and $B_2 = \{ \langle u, \mu_2^+(u), \nu_2^+(u), \delta_2^+(u), \mu_2^-(u), \nu_2^-(u), \delta_2^-(u) \rangle : u \in U \}$ be any two bipolar neutrosophic sets in U . Then, their intersection is defined as

$$B_4(u) = B_1(u) \cap B_2(u) = \{ \langle u, \min(\mu_1^+(u), \mu_2^+(u)), \min(\nu_1^+(u), \nu_2^+(u)), \max(\delta_1^+(u), \delta_2^+(u)), \max(\mu_1^-(u), \mu_2^-(u)), \max(\nu_1^-(u), \nu_2^-(u)), \min(\delta_1^-(u), \delta_2^-(u)) \rangle : u \in U \} \text{ for all } u \in U.$$

Definition 2.8: Compliment of a Bipolar Neutrosophic Set (Deli et al., 2015)

Let $B_1 = \{ \langle u, \mu_1^+(u), \nu_1^+(u), \delta_1^+(u), \mu_1^-(u), \nu_1^-(u), \delta_1^-(u) \rangle : u \in U \}$ be a bipolar neutrosophic set in U . Then the compliment of B_1 is denoted by B_1^c and is defined by

$$B_1^c = \{ \langle u, 1 - \mu_1^+(u), 1 - \nu_1^+(u), 1 - \delta_1^+(u), \{-1\} - \mu_1^-(u), \{-1\} - \nu_1^-(u), \{-1\} - \delta_1^-(u) \rangle : u \in U \} \text{ for all } u \in U.$$

Definition 2.9: Score function of a BNN (Deli et al., 2015)

The score function of a bipolar neutrosophic number $b = \langle \mu^+, \nu^+, \delta^+, \mu^-, \nu^-, \delta^- \rangle$ is denoted by $Sc(b)$ and is defined by

$$Sc(b) = \frac{(\mu^+ + 1 - \nu^+ + 1 - \delta^+ + 1 + \mu^- - \nu^- - \delta^-)}{6}. \tag{1}$$

Definition 2.10: Accuracy function of a BNN (Deli et al., 2015)

The accuracy function of a bipolar neutrosophic number $b = \langle \mu^+, \nu^+, \delta^+, \mu^-, \nu^-, \delta^- \rangle$ is denoted by $Ac(b)$ and is defined by

$$Ac(b) = \mu^+ - \delta^+ + \mu^- - \delta^-. \tag{2}$$

Definition 2.11: Certainty function of a BNN (Deli et al., 2015)

The certainty function of a bipolar neutrosophic number $b = \langle \mu^+, \nu^+, \delta^+, \mu^-, \nu^-, \delta^- \rangle$ is denoted by $C(b)$ and is defined by $C(b) = \mu^+ - \delta^-$

Definition 2.12: Comparison procedure of two BNNs (Deli et al., 2015)

Let $b_1 = \langle \mu_1^+, \nu_1^+, \delta_1^+, \mu_1^-, \nu_1^-, \delta_1^- \rangle$ and $b_2 = \langle \mu_2^+, \nu_2^+, \delta_2^+, \mu_2^-, \nu_2^-, \delta_2^- \rangle$ be any two bipolar neutrosophic numbers in U . The comparison procedure is stated as follows:

1. If $Sc(b_1) > Sc(b_2)$, then b_1 is greater than b_2 , denoted by $b_1 > b_2$.
2. If $Sc(b_1) = Sc(b_2)$ and $Ac(b_1) > Ac(b_2)$, then b_1 is greater than b_2 , denoted by $b_1 > b_2$.
3. If $Sc(b_1) = Sc(b_2)$, $Ac(b_1) = Ac(b_2)$ and $C(b_1) > C(b_2)$, then b_1 is greater than b_2 , denoted by $b_1 > b_2$.
4. If $Sc(b) = Sc(b)$, $Ac(b) = Ac(b)$ and $C(b_1) = C(b_2)$, then b_1 is equal to b_2 , denoted by $b_1 = b_2$.

Definition 2.13: Distance measure between two BNNs

Let $b_1 = \langle \mu_1^+, \nu_1^+, \delta_1^+, \mu_1^-, \nu_1^-, \delta_1^- \rangle$ and $b_2 = \langle \mu_2^+, \nu_2^+, \delta_2^+, \mu_2^-, \nu_2^-, \delta_2^- \rangle$ be any two bipolar neutrosophic numbers in U . Distance measure between b_1 and b_2 is denoted by $d_H(b_1, b_2)$ and defined as

$$d_H(b_1, b_2) = \frac{1}{6} [|\mu_1^+ - \mu_2^+| + |\nu_1^+ - \nu_2^+| + |\delta_1^+ - \delta_2^+| + |\mu_1^- - \mu_2^-| + |\nu_1^- - \nu_2^-| + |\delta_1^- - \delta_2^-|] \quad (4)$$

Definition 2.14: Procedure of normalization

Assume that b_{ij} be a BNN to assess i -th alternative with regarding to j -th criterion. A criterion may be benefit type or cost type. To normalize the BNN b_{ij} , we use the following formula.

$$b_{ij}^* = \langle \{1\} - \mu_{ij}^+, \{1\} - \nu_{ij}^+, \{1\} - \delta_{ij}^+, \{-1\} - \mu_{ij}^-, \{-1\} - \nu_{ij}^-, \{1\} - \delta_{ij}^- \rangle \quad (5)$$

3. TODIM METHOD FOR SOLVING MAGDM PROBLEM UNDER BIPOLAR NEUTROSOPHIC ENVIRONMENT

In this section, we propose a MAGDM method under bipolar neutrosophic environment. Assume that $P = \{p_1, p_2, p_3, \dots, p_r\}$ be a set of r alternatives and $C = \{c_1, c_2, c_3, \dots, c_s\}$ be a set of s criteria. Assume that $W = \{w_1, w_2, w_3, \dots, w_s\}$ be the weight vector of the criteria, where $w_k > 0$ and $\sum_{k=1}^s w_k = 1$. Let $D = \{D_1, D_2, D_3, \dots, D_t\}$ be the set of t decision makers and $\lambda = \{\lambda_1, \lambda_2, \lambda_3, \dots, \lambda_t\}$ be the set of weight vector of decision makers, where $\lambda_l > 0$ and $\sum_{l=1}^t \lambda_l = 1$.

In the following sub section, we describe the TODIM based MAGDM method under bipolar neutrosophic set environment. The proposed method is described using the following steps:

Step1- Construction of the decision matrix

Assume that $M^L = (b_{ij}^L)_{r \times s}$ ($L = 1, 2, 3, \dots, t$) be the L -th decision matrix, where information about the alternative p_i provided by the decision maker D_L with respect to attribute c_j ($j = 1, 2, 3, \dots, s$). The L -th decision matrix denoted by M^L (see Equation 6) is constructed as follows:

$$M^L = \begin{pmatrix} p_1 & c_1^L & c_2^L & \dots & c_s^L \\ p_2 & b_{11}^L & b_{12}^L & \dots & b_{1s}^L \\ \vdots & \vdots & \vdots & \dots & \vdots \\ p_r & b_{r1}^L & b_{r2}^L & \dots & b_{rs}^L \end{pmatrix} \quad (6)$$

where $L = 1, 2, 3, \dots, t$; $i = 1, 2, 3, \dots, r$; $j = 1, 2, 3, \dots, s$.

Step 2-Normalization of the decision matrix

In decision making situation cost criteria and benefit criteria play an important role to choose the best alternative. Cost criteria and benefit criteria exist together, so the decision matrix needs to be normalized. We use Equation 5 to normalize the cost criteria. Benefit criteria need not be normalized. Using Equation 5 the normalize decision matrix (see Equation 6) is represented below (see Equation 7).

$$M^L = \begin{pmatrix} p_1 & \tilde{b}_1^L & \tilde{b}_2^L & \dots & \tilde{b}_s^L \\ p_2 & \tilde{b}_{11}^L & \tilde{b}_{12}^L & \dots & \tilde{b}_{1s}^L \\ \vdots & \vdots & \vdots & \dots & \vdots \\ p_r & \tilde{b}_{r1}^L & \tilde{b}_{r2}^L & \dots & \tilde{b}_{rs}^L \end{pmatrix} \quad (7)$$

Here $L = 1, 2, 3, \dots, t$; $i = 1, 2, 3, \dots, r$; $j = 1, 2, 3, \dots, s$.

Step 3- Determination of the relative weight of each criterion

We find relative weight of each criterion with respect to criterion with maximum weight. Relative weight is presented as:

$$W_{RC_j} = \frac{w_{C_j}}{w_m}, \text{ where } w_m = \max \{w_1, w_2, w_3, \dots, w_s\}. \quad (8)$$

Step 4- Calculation of score values

If the criteria are benefit criteria, then score values of Equation 6 are calculated by Equation 1, otherwise score values of Equation 7 are calculated by Equation 1.

Step 5- Calculation of accuracy values

If the criteria are benefit type, then accuracy values of Equation 6 are calculated by Equation 2, otherwise score values of Equation 7 are calculated by Equation 2.

Step 6- Construction of the dominance matrix remove

We construct the dominance matrix of each alternative p_i with respect to the criterion C_j of the L -th decision maker D_L (see Equation 9).

(For cost criteria)

$$\left. \begin{aligned} \alpha_c^L(p_i, p_j) &= \sqrt{\frac{W_{RC}}{\sum_{C=1}^s W_{RC}}} d_H(\tilde{b}_{ic}^L, \tilde{b}_{jc}^L), \text{ if } \tilde{b}_{ic}^L > \tilde{b}_{jc}^L \\ &= 0, \text{ if } \tilde{b}_{ic}^L = \tilde{b}_{jc}^L \\ &= -\frac{1}{\xi} \sqrt{\frac{W_{RC}}{\sum_{C=1}^s W_{RC}}} d_H(\tilde{b}_{ic}^L, \tilde{b}_{jc}^L), \text{ if } \tilde{b}_{ic}^L < \tilde{b}_{jc}^L \end{aligned} \right\} \quad (9)$$

(For benefit criteria)

$$\left. \begin{aligned} \alpha_c^L(p_i, p_j) &= \sqrt{\frac{W_{RC}}{\sum_{C=1}^s W_{RC}}} d_H(b_{ic}^L, b_{jc}^L), \text{ if } b_{ic}^L > b_{jc}^L \\ &= 0, \text{ if } b_{ic}^L = b_{jc}^L \\ &= -\frac{1}{\xi} \sqrt{\frac{W_{RC}}{\sum_{C=1}^s W_{RC}}} d_H(b_{ic}^L, b_{jc}^L), \text{ if } b_{ic}^L < b_{jc}^L \end{aligned} \right\} \quad (9a)$$

Here, ‘ ξ ’ denotes decay factor of loss and $\xi > 0$.

Step 7- Construction of the individual final dominance matrix

Using the Equation 10, individual final dominance matrix is constructed as follows:

$$\eta_L = \sum_{c=1}^s \alpha_c^L(p_i, p_j) \quad (10)$$

Step 8- Aggregation of all dominance matrix

Using the Equation 11, the aggregated dominance matrix is obtained as:

$$\eta(p_i, p_j) = \sum_{L=1}^t \lambda_L \eta_L(p_i, p_j) \quad (11)$$

Step 9- Calculation of the global values

Using Equation 12, the global value p_i is obtained as:

$$\beta_i = \frac{\sum_{j=1}^s \eta(p_i, p_j) - \min_{l \leq i \leq r} (\sum_{j=1}^s \eta(p_i, p_j))}{\max_{l \leq i \leq r} (\sum_{j=1}^s \eta(p_i, p_j)) - \min_{l \leq i \leq r} (\sum_{j=1}^s \eta(p_i, p_j))} \quad (12)$$

Step 10- Ranking of the alternatives

Ranking of the alternatives is done based on descending order of global values. The highest global value β_i reflects the best alternative p_i .

4. ILLUSTRATIVE EXAMPLE

To demonstrate the applicability and effectiveness of the proposed method, we solve a MAGDM problem adapted from (Ye, 2014d, Zhang et al., 2016). We assume that an investment company wants to invest a sum of money in the best option. The investment company forms a decision making board involving of three members (D_1, D_2, D_3) who evaluate the four alternatives to invest money. The alternatives are:

1. Car company (p_1),
2. Food company (p_2),
3. Company (p_3), and
4. Arms company (p_4).

Decision makers take decision to evaluate alternatives based on the criteria namely, risk factor (c_1), growth factor (c_2), environment impact (c_3). We consider three criteria as benefit type based on Zhang et al. (2016). Assume that the weight vector of attributes is $W=(.37,.33,.3)^T$ and weight vector of decision makers is $\lambda=(.38,.32,.3)^T$. Now, we apply the proposed MAGDM method to solve the problem using the following steps.

Step1- Construction of the decision matrix

We construct the decision matrix based on information provided by the decision makers in terms of BNN with respect to the criteria as follows:

Decision matrix for D_1

$$M^1 = \begin{pmatrix} & \begin{matrix} c_1 & c_2 & c_3 \end{matrix} \\ \begin{matrix} p_1 \\ p_2 \\ p_3 \\ p_4 \end{matrix} & \begin{pmatrix} (.5,.6,.7,-.3,-.6,-.3) & (.8,.5,.6,-.4,-.6,-.3) & (.9,.4,.6,-.1,-.6,-.5) \\ (.6,.2,.2,-.4,-.5,-.3) & (.6,.3,.7,-.4,-.3,-.5) & (.7,.5,.3,-.4,-.3,-.3) \\ (.8,.3,.5,-.6,-.4,-.5) & (.5,.2,.4,-.1,-.5,-.3) & (.4,.2,.8,-.5,-.3,-.2) \\ (.7,.5,.3,-.6,-.3,-.3) & (.8,.7,.2,-.8,-.6,-.1) & (.6,.3,.4,-.3,-.4,-.7) \end{pmatrix} \end{pmatrix}$$

Decision matrix for D₂

$$M^2 = \begin{pmatrix} & c_1 & C_2 & C_3 \\ p_1 & (.6, .3, .4, -.5, -.3, -.7) & (.5, .3, .4, -.3, -.3, -.4) & (.1, .5, .7, -.5, -.2, -.6) \\ p_2 & (.7, .4, .5, -.3, -.2, -.1) & (.8, .4, .5, -.7, -.3, -.2) & (.6, .2, .7, -.5, -.2, -.9) \\ p_3 & (.8, .3, .2, -.5, -.2, -.6) & (.3, .2, .1, -.6, -.3, -.4) & (.7, .5, .4, -.4, -.3, -.2) \\ p_4 & (.3, .5, .2, -.5, -.5, -.2) & (.5, .6, .4, -.3, -.6, -.7) & (.4, .3, .8, -.5, -.6, -.5) \end{pmatrix}$$

Decision matrix for D₃

$$M^3 = \begin{pmatrix} & c_1 & C_2 & C_3 \\ p_1 & (.9, .6, .4, -.7, -.3, -.2) & (.7, .5, .3, -.6, -.2, -.5) & (.4, .2, .3, -.2, -.5, -.7) \\ p_2 & (.5, .3, .2, -.6, -.4, -.1) & (.5, .2, .7, -.3, -.2, -.5) & (.6, .3, .2, -.7, -.6, -.3) \\ p_3 & (.2, .5, .6, -.4, -.5, -.7) & (.3, .2, .7, -.2, -.3, -.5) & (.8, .2, .4, -.2, -.3, -.6) \\ p_4 & (.8, .5, .5, -.4, -.6, -.3) & (.9, .3, .4, -.5, -.6, -.7) & (.7, .4, .3, -.2, -.5, -.7) \end{pmatrix}$$

Step 2-Normalization of the decision matrix

Since all the criteria are considered as benefit type, we do not need to normalize the decision matrix (M¹, M², M³).

Step 3- Determination of the relative weight of each criterion

Using Equation 8, the relative weights of the criteria are obtained as:

$$W_{RC_1} = 1, W_{RC_2} = .89, W_{RC_3} = .81.$$

Step 4- Calculation of score values

Using Equation 1, we calculate the score values of each alternative with respect to each criterion (see Table 1, 2, and 3).

Table 1: Score value for M¹

$$\begin{pmatrix} & C_1 & C_2 & C_3 \\ p_1 & .47 & .53 & .70 \\ p_2 & .60 & .50 & .52 \\ p_3 & .55 & .60 & .40 \\ p_4 & .48 & .50 & .58 \end{pmatrix}$$

Table 2: Score value for M²

$$\begin{pmatrix} & C_1 & C_2 & C_3 \\ p_1 & .60 & .53 & .37 \\ p_2 & .47 & .45 & .55 \\ p_3 & .60 & .52 & .48 \\ p_4 & .46 & .58 & .48 \end{pmatrix}$$

Table 3: Score value for M³

$$\begin{pmatrix} & C_1 & C_2 & C_3 \\ p_1 & .45 & .50 & .55 \\ p_2 & .48 & .50 & .55 \\ p_3 & .48 & .50 & .65 \\ p_4 & .55 & .67 & .67 \end{pmatrix}$$

Step 5-Calculate accuracy values

Using Equation 2, we calculate the accuracy values of each alternative with respect to each criterion (see Table 4, 5, and 6.)

Table 4: Accuracy value for M¹

$$\begin{pmatrix} & C_1 & C_2 & C_3 \\ p_1 & -.2 & .1 & .7 \\ p_2 & .3 & 0 & .3 \\ p_3 & .2 & .3 & -.7 \\ p_4 & .1 & -.1 & .6 \end{pmatrix}$$

Table 5: Accuracy value for M²

$$\begin{pmatrix} & C_1 & C_2 & C_3 \\ p_1 & .4 & .2 & -.5 \\ p_2 & 0 & -.2 & .3 \\ p_3 & .7 & 0 & .1 \\ p_4 & -.2 & .5 & -.4 \end{pmatrix}$$

Table 6: Accuracy value for M³

$$\begin{pmatrix} & C_1 & C_2 & C_3 \\ p_1 & 0 & .3 & .3 \\ p_2 & -.2 & 0 & 0 \\ p_3 & -.1 & -.1 & .8 \\ p_4 & .2 & .7 & .9 \end{pmatrix}$$

Step 6- Construction of the dominance matrix

Here, using Equation 9, we construct dominance matrix (Taking $\xi = 1$). The dominance matrices are represented in Table 7, 8, 9, 10, 11, 12, 13, 14, and 15.

Table 7: Dominance matrix α_1^1

$$\alpha_1^1 = \begin{pmatrix} & p_1 & p_2 & p_3 & p_4 \\ p_1 & 0 & .27 & -.82 & -.77 \\ p_2 & -.73 & 0 & -.70 & -.64 \\ p_3 & .30 & .26 & 0 & .22 \\ p_4 & .28 & .24 & -.59 & 0 \end{pmatrix}$$

Table 8: Dominance matrix α_2^1

$$\alpha_2^1 = \begin{pmatrix} & p_1 & p_2 & p_3 & p_4 \\ p_1 & 0 & .24 & .27 & .26 \\ p_2 & -.72 & 0 & -.78 & 0 \\ p_3 & -.82 & .26 & 0 & .33 \\ p_4 & -.78 & 0 & -1 & 0 \end{pmatrix}$$

Table 9: Dominance matrix α_3^1

$$\alpha_3^1 = \begin{pmatrix} & p_1 & p_2 & p_3 & p_4 \\ p_1 & 0 & -.88 & .31 & -.82 \\ p_2 & .26 & 0 & .26 & -.75 \\ p_3 & -1 & -.86 & 0 & -.91 \\ p_4 & .25 & .23 & .27 & 0 \end{pmatrix}$$

Table 10: Dominance matrix α_4^1

$$\alpha_4^1 = \begin{pmatrix} & p_1 & p_2 & p_3 & p_4 \\ p_1 & 0 & .27 & -.52 & .29 \\ p_2 & -.73 & 0 & -.73 & .29 \\ p_3 & .19 & .27 & 0 & .29 \\ p_4 & -.79 & -.79 & -.79 & 0 \end{pmatrix}$$

Table 11: Dominance matrix α_2^2

$$\alpha_2^2 = \begin{pmatrix} p_1 & p_2 & p_3 & p_4 \\ p_1 & 0 & .24 & .22 & -.67 \\ p_2 & -.74 & 0 & -.84 & -.95 \\ p_3 & -.67 & .28 & 0 & -.95 \\ p_4 & .22 & .31 & .31 & 0 \end{pmatrix}$$

Table 12: Dominance matrix α_3^2

$$\alpha_3^2 = \begin{pmatrix} p_1 & p_2 & p_3 & p_4 \\ p_1 & 0 & -.77 & -.91 & -.77 \\ p_2 & .23 & 0 & .28 & .24 \\ p_3 & .27 & -.95 & 0 & .28 \\ p_4 & .23 & -.82 & -.95 & 0 \end{pmatrix}$$

Table 13: Dominance matrix α_1^3

$$\alpha_1^3 = \begin{pmatrix} p_1 & p_2 & p_3 & p_4 \\ p_1 & 0 & -.73 & -.94 & -.68 \\ p_2 & .27 & 0 & -.90 & -.79 \\ p_3 & .35 & .33 & 0 & -.73 \\ p_4 & .25 & .29 & .27 & 0 \end{pmatrix}$$

Table 14: Dominance matrix α_2^3

$$\alpha_2^3 = \begin{pmatrix} p_1 & p_2 & p_3 & p_4 \\ p_1 & 0 & .26 & .30 & -.45 \\ p_2 & -.78 & 0 & .14 & -.91 \\ p_3 & -.91 & -.43 & 0 & -.95 \\ p_4 & .26 & .29 & .31 & 0 \end{pmatrix}$$

Table 15: Dominance matrix α_3^3

$$\alpha_3^3 = \begin{pmatrix} p_1 & p_2 & p_3 & p_4 \\ p_1 & 0 & .26 & -.91 & -.86 \\ p_2 & -.88 & 0 & -.95 & -.86 \\ p_3 & .27 & .28 & 0 & -.63 \\ p_4 & .26 & .26 & .91 & 0 \end{pmatrix}$$

Step 7- Construction of the individual final dominance matrix

Using Equation 10, the individual final dominance matrices are constructed (see Table 16, 17, and 18).

Table 16: Final dominance matrix η_1

η_2

$$\eta_1 = \begin{pmatrix} p_1 & p_2 & p_3 & p_4 \\ p_1 & 0 & -.37 & -.24 & -1.33 \\ p_2 & -1.19 & 0 & -1.22 & -1.39 \\ p_3 & -1.52 & -.34 & 0 & -.36 \\ p_4 & -.25 & .47 & -1.32 & 0 \end{pmatrix}$$

Table 17: Final dominance matrix

$$\eta_2 = \begin{pmatrix} p_1 & p_2 & p_3 & p_4 \\ p_1 & 0 & -.26 & -1.21 & -1.15 \\ p_2 & -1.24 & 0 & -1.29 & -.42 \\ p_3 & -.21 & -.40 & 0 & -.38 \\ p_4 & -.34 & -1.3 & -1.43 & 0 \end{pmatrix}$$

Table 18: Final dominance matrix η_3

$$\eta_3 = \begin{pmatrix} & p_1 & p_2 & p_3 & p_4 \\ p_1 & 0 & -.21 & -1.5 & -1.9 \\ p_2 & -1.39 & 0 & -1.7 & -2.6 \\ p_3 & -.29 & .18 & 0 & -2.3 \\ p_4 & .77 & .84 & .77 & 0 \end{pmatrix}$$

Step 8- Aggregation of all dominance matrix

Using Equation 11, the aggregated dominance matrix is represented in Table 19.

Table 19: Aggregated dominance matrix η

$$\eta = \begin{pmatrix} & p_1 & p_2 & p_3 & p_4 \\ p_1 & 0 & -.29 & -.94 & -1.47 \\ p_2 & -1.26 & 0 & -1.07 & -1.43 \\ p_3 & -.73 & -.20 & 0 & -.95 \\ p_4 & .03 & .01 & -.73 & 0 \end{pmatrix}$$

Step 9- Calculation of the global values

Using Equation 12, the global values β_i are calculated as:

$$\beta_1 = .34, \beta_2 = 0, \beta_3 = .61, \beta_4 = 1.$$

Step 10- Ranking of the alternatives

Here $\beta_4 > \beta_3 > \beta_1 > \beta_2$.

Thus the Arm company (p_4) is the best option to invest money.

Section 5. CONCLUSION

In real decision making, the evaluation information of alternatives provided by the decision maker is often incomplete, indeterminate and inconsistent. Bipolar neutrosophic set can describe this kind of information. In this paper, we have developed a new group decision making method based on TODIM under bipolar neutrosophic set environment. Finally, a numerical example is shown to demonstrate its practicality and effectiveness. We hope that the proposed method can be extended for solving multi criteria group decision making in other neutrosophic hybrid environment.

ACKNOWLEDGMENT

We thank both the editors for their useful suggestions.

REFERENCES

- Atanassov, K. (1986). Intuitionistic fuzzy sets. *Fuzzy Sets and Systems*, 20, 87-96.
- Atanassov, K. T., Pasi G., & Yager, R. R. (2005). Intuitionistic fuzzy interpretations of multi-criteria multi-person and multi-measurement tool decision making. *International Journal of Systems Science*, 36, 859-868.
- Biswas, P., Pramanik, S., & Giri, B. C. (2014a). Entropy based grey relational analysis method for multi-attribute decision making under single valued neutrosophic assessments. *Neutrosophic Sets and Systems*, 2, 102–110.
- Biswas, P., Pramanik, S., & Giri, B. C. (2014b). A new methodology for neutrosophic multi-attribute decision making with unknown weight information. *Neutrosophic Sets and Systems*, 3, 42–52.
- Biswas, P., Pramanik, S., & Giri, B. C. (2015a). TOPSIS method for multi-attribute group decision-making under single valued neutrosophic environment. *Neural Computing and Applications*, 27(3), 727- 737. doi: 10.1007/s00521-015-1891-2.
- Biswas, P., Pramanik, S., & Giri, B. C. (2015b). Cosine similarity measure based multi-attribute decision-making with trapezoidal fuzzy neutrosophic numbers. *Neutrosophic Sets and Systems*, 8, 47-57.
- Biswas, P., Pramanik, S., & Giri, B. C. (2016a). Aggregation of triangular fuzzy neutrosophic set information and its application to multi-attribute decision making. *Neutrosophic Sets and Systems*, 12, 20-40.
- Biswas, P., Pramanik, S., & Giri, B. C. (2016b). Value and ambiguity index based ranking method of single-valued trapezoidal neutrosophic numbers and its application to multi-attribute decision making. *Neutrosophic Sets and Systems*, 12, 127-138.
- Chan, J. W. K., & Tong, T. K. L. (2007). Multi-criteria material selection and end-of-life product strategy: grey relational analysis approach. *Materials and Design*, 28, 1539-1546.
- Deli, M., & Smarandache, F. (2015). Bipolar neutrosophic sets and their application based on multi-criteria decision making Proceedings of the 2015 International Conference on Advanced Mechatronic Systems, Beijing, China, August, 249-254.
- Deli, I., & Subas, Y. (2016). A ranking method of single valued neutrosophic numbers and its applications to multi-attribute decision making problems. *International Journal of Machine Learning and Cybernetics*. doi :10.1007/s13042016-0505-3.
- Dey, P.P., Pramanik, S. & Giri, B.C. (2015). Multi-criteria group decision making in intuitionistic fuzzy environment based on grey relational analysis for weaver selection in Khadi institution. *Journal of Applied and Quantitative Methods*, 10(4), 1-14.
- Dey, P. P., Pramanik, S., & Giri, B. C. (2016). TOPSIS for solving multi-attribute decision making problems under bi-polar neutrosophic environment. In F. Smarandache, & S. Pramanik (Eds), *New trends in neutrosophic theory and applications* (pp.65-77). Brussels: Pons Editions.
- Fan, Z.P., Zhang, X., Chen F.D., & Liu, Y. (2013). Extended TODIM method for hybrid multiple attribute decision making problems. *Knowledge-Based Systems*, 42, 331, 40–48.
- Gomes, L. F. A. M., & Lima, M. M. P. P. (1992). TODIM: Basics and application to multi criteria ranking of projects with environmental impacts. *Foundations of Computing and Decision Sciences*, 16, 113-127.
- Gomes, L. F. A. M., Machado, M. A. S., Costa F. F., & Rangel, L. A. D. (2013). Criteria interactions in multiple criteria decision aiding: a Choquet formulation for the TODIM method. *Procedia Computer Science* , 17, 324–331.
- Gumus, S., Kucukvar, M., & Tatari, O. (2016). Intuitionistic fuzzy multi-criteria decision making framework based on life cycle environmental, economic and social impacts: The case of U.S. wind energy. *Sustainable Production and Consumption*. doi.org/10.1016/j.spc.2016.06.006.
- Hwang, C. L., & Yoon, K. (1981). Multiple attribute decision making: methods and applications: a state-of-the-art survey. Springer-Verlag, Berlin, Heidelberg.

- Ji, P., Wang, J. Q., & Zhang, H. Y. (2016). Frank prioritized Bonferroni mean operator with single-valued neutrosophic sets and its application in selecting third-party logistics providers. *Neural Computing and Applications*. doi:10.1007/s00521-016-2660-6.
- Ji, P., Zhang, H., & Wang, J. (2016). A projection-based TODIM method under multi-valued neutrosophic environments and its application in personnel selection. *Neural Computing and Applications*, DOI 10.1007/s00521-016-2436-z.
- Kahneman, D., & Tversky, A. (1979). Prospect theory: an analysis of decision under risk. *Economic Journal of Economic Society*, 47(2), 263–292.
- Kharal, A. (2014). A neutrosophic multi-criteria decision making method. *New Mathematics and Natural Computation*, 10, 143–162.
- Krohling, R. A., & Pacheco, A. G. C. (2014). Interval-valued intuitionistic fuzzy TODIM. *Information Technology and Quantitative Management*, 31, 236-244.
- Krohling, R. A., Pacheco A. G. C., & Siviero, A. L. T. (2013). IF-TODIM: an intuitionistic fuzzy TODIM to multi-criteria decision making. *Knowledge- Based Systems*, 53, 142-146.
- Krohling, R. A., & De Souza, T. T. M. (2012). Combining prospect theory and fuzzy numbers to multi-criteria decision making. *Expert Systems with Application*, 39(13), 11487–11493.
- Liu, P., & Teng, F. (2014). An extended TODIM method for multiple attribute group decision-making based on 2-dimension uncertain linguistic variable. *Complexity*, 21(5), 20–30.
- Lourenzutti, R. & Krohling, R. A. (2013). A study of TODIM in a intuitionistic fuzzy and random environment. *Expert Systems with Applications*, 40, 6459–6468.
- Mondal, K., & Pramanik, S. (2014a). A study on problems of Hijras in West Bengal based on neutrosophic cognitive maps. *Neutrosophic Sets and Systems*, 5, 21-26.
- Mondal, K., & Pramanik, S., (2014b). Multi-criteria group decision making approach for teacher recruitment in higher education under simplified neutrosophic environment. *Neutrosophic Sets and Systems*, 6, 28-34.
- Mondal, K., & Pramanik, S., (2014c). Intuitionistic fuzzy multicriteria group decision making approach to quality clay-brick selection problems based on grey relational analysis. *Journal of Applied Quantitative Methods*, 9(2), 35-50.
- Mondal, K., & Pramanik, S. (2015a). Intuitionistic fuzzy similarity measure based on tangent function and its application to multi-attribute decision. *Global journal of advanced research*, 2 (2), 464-471.
- Mondal, K., & Pramanik, S., (2015b). Neutrosophic decision making model of school choice. *Neutrosophic Sets and Systems*, 7, 62-68.
- Pramanik, S. (2016a). Neutrosophic multi-objective linear programming. *Global Journal of Engineering Science and Research Management*, 3(8), 36-46.
- Pramanik, S. (2016b). Neutrosophic linear goal programming. *Global Journal of Engineering Science and Research Management*, 3(7), 01-11.
- Pramanik, S., Banerjee, D., & Giri, B. C. (2016). Multi – criteria group decision making model in neutrosophic refined set and its application. *Global Journal of Engineering Science and Research Management*, 3(6), 12-18.
- Pramanik, S., Biswas, P., & Giri, B. C. (2017). Hybrid vector similarity measures and their applications to multi-attribute decision making under neutrosophic environment. *Neural Computing and Applications*, 28(5), 1163-76.
- Pramanik, S., & Chakrabarti, S. (2013). A study on problems of construction workers in West Bengal based on neutrosophic cognitive maps. *International Journal of Innovative Research in Science, Engineering and Technology*, 2(11), 6387-6394.
- Pramanik, S., Dalapati, S., & Roy, T. K, (2016). Logistics center location selection approach based on neutrosophic multi-criteria decision making. In F. Smarandache, & S. Pramanik (Eds.), *New trends in neutrosophic theory and applications* (pp. 161-174). Brussels: Pons Editions.

- Pramanik, S., & Mondal, K. (2016). Rough bipolar neutrosophic set. *Global Journal of Engineering Science and Research Management*, 3(6), 71-81.
- Pramanik, S. & Mukhopadhyaya, D. (2011). Grey relational analysis based intuitionistic fuzzy multi-criteria group decision-making approach for teacher selection in higher education. *International Journal of Computer Applications*, 34 (10), 21-29.
- Pramanik, S., & Roy, T. K. (2014). Neutrosophic game theoretic approach to Indo-Pak conflict over Jammu-Kashmir. *Neutrosophic Sets and Systems*, 2, 82-101.
- Rao, R. V., & Davim, J. P. A. (2008). Decision-making framework model for material selection using a combined multiple attributes decision-making method. *International Journal of Advanced Manufacturing Technology*, 35, 751-760.
- Roy, R. & Das, P. (2015). A multi-objective production planning problem based on neutrosophic linear programming approach. *International Journal of Fuzzy Mathematical Archive*, 8(2), 81-91.
- Shanian, A., & Savadogo, O. (2009). A methodological concept for material selection of highly sensitive components based on multiple criteria decision analysis. *Expert Systems with Applications*, 36, 1362–1370.
- Smarandache, F. (1998). *A unifying field in logics: neutrosophic logic. Neutrosophy, neutrosophic set, neutrosophic probability, and neutrosophic statistics*. Rehoboth: American Research Press.
- Tosun, O. & Akyu, G. (2015). A fuzzy TODIM approach for the supplier selection problem. *International Journal of Computational Intelligence Systems*, 8(2), 317–329.
- Triantaphyllou, E. (2000). Multi-criteria decision making methods. In *Multi-criteria decision making methods: A comparative study* (pp. 5-21). Springer US.
- Wang, J.Q. (2008). Overview on fuzzy multi-criteria decision making approach. *Control and Decision*, 23, 601–606.
- Wang, J. Q., & Li, X. E. (2015). TODIM method with multi-valued neutrosophic set. *Control and Decision*, 30 (6), 1139-1142.
- Wang, H. Smarandache, F. Zhang, Y. Q., & Sunderraman, R. (2010). Single valued neutrosophic sets. *Multispace and Multistructure*, 4, 410–413.
- Wei, G. (2010). Some induced geometric aggregation operators with intuitionistic fuzzy information and their application to group decision making. *Applied Soft Computing*, 10, 423-431.
- Xu, Z. (2007). Some similarity measures of intuitionistic fuzzy sets and their applications to multiple attribute decision making. *Fuzzy Optimization and Decision Making*, 6, 109-121.
- Xu, Z., & Yager, R. R. (2008). Dynamic intuitionistic fuzzy multi-attribute making. *International Journal of Approximate Reasoning*, 48, 246-262.
- Ye, J. (2013a). Multi criteria decision-making method using the correlation coefficient under single-valued neutrosophic environment. *International Journal of General Systems* 42, 386–394.
- Ye, J. (2013b). Single valued neutrosophic cross-entropy for multi criteria decision making problems. *Applied Mathematical Modelling*, 38 (3), 1170–1175.
- Ye, J. (2014a). Single valued neutrosophic minimum spanning tree and its clustering method. *Journal of Intelligent Systems*, 23, 311–324.
- Ye, J. (2014b). Clustering methods using distance-based similarity measures of single-valued neutrosophic sets. *Journal of Intelligent Systems*, 23, 379–389.
- Ye, J. (2014c). A multi criteria decision-making method using aggregation operators for simplified neutrosophic sets. *Journal of Intelligent and Fuzzy Systems*, 26, 2459–2466.
- Ye, J. (2014d). Similarity measures between interval neutrosophic sets and their multi criteria decision-making method. *Journal of Intelligent and Fuzzy systems*, 26, 165-172.
- Ye, J. (2015a). Trapezoidal neutrosophic set and its application to multiple attribute decision-making. *Neural Computing and Applications*, 26, 1157–1166.
- Ye, J. (2015b). Bidirectional projection method for multiple attribute group decision making with neutrosophic number. *Neural Computing and Applications*. doi: 10.1007/s00521-015-2123-5.

- Ye, J. (2015c). Improved cosine similarity measures of simplified neutrosophic sets for medical diagnoses. *Artificial Intelligence in Medicine*, 63, 171–179.
- Ye, J. (2017). Projection and bidirectional projection measures of single valued neutrosophic sets and their decision – making method for mechanical design scheme. *Journal of Experimental and Theoretical Artificial Intelligence*, 29(4), 731-740.
- Zadeh, L. A. (1965). Fuzzy sets. *Information and Control*, 8(3), 338-353.
- Zhang, M., Liu, P., & Shi, L. (2016). An extended multiple attribute group decision-making TODIM method based on the neutrosophic numbers. *Journal of Intelligent and Fuzzy Systems*, 30, 1773–1781.
- Abdel-Basset, M., Mohamed, M., Smarandache, F., & Chang, V. (2018). Neutrosophic Association Rule Mining Algorithm for Big Data Analysis. *Symmetry*, 10(4), 106.
- Abdel-Basset, M., & Mohamed, M. (2018). The Role of Single Valued Neutrosophic Sets and Rough Sets in Smart City: Imperfect and Incomplete Information Systems. *Measurement*. Volume 124, August 2018, Pages 47-55
- Abdel-Basset, M., Gunasekaran, M., Mohamed, M., & Smarandache, F. A novel method for solving the fully neutrosophic linear programming problems. *Neural Computing and Applications*, 1-11.
- Abdel-Basset, M., Manogaran, G., Gamal, A., & Smarandache, F. (2018). A hybrid approach of neutrosophic sets and DEMATEL method for developing supplier selection criteria. *Design Automation for Embedded Systems*, 1-22.
- Abdel-Basset, M., Mohamed, M., & Chang, V. (2018). NMCDA: A framework for evaluating cloud computing services. *Future Generation Computer Systems*, 86, 12-29.
- Abdel-Basset, M., Mohamed, M., Zhou, Y., & Hezam, I. (2017). Multi-criteria group decision making based on neutrosophic analytic hierarchy process. *Journal of Intelligent & Fuzzy Systems*, 33(6), 4055-4066.
- Abdel-Basset, M.; Mohamed, M.; Smarandache, F. An Extension of Neutrosophic AHP–SWOT Analysis for Strategic Planning and Decision-Making. *Symmetry* 2018, 10, 116.

Hybrid vector similarity measure of single valued refined neutrosophic sets to multi-attribute decision making problems

Surapati Pramanik^{1*}, Partha Pratim Dey², Bibhas C. Giri³

^{1*}Department of Mathematics, Nandalal Ghosh B.T. College, Panpur, P.O.- Narayanpur, District –North 24 Parganas, Pin code-743126, West Bengal, India. E-mail: sura_pati@yahoo.co.in

²Department of Mathematics, Jadavpur University, Kolkata-700032, West Bengal, India. E-mail: parsur.fuzz@gmail.com

³Department of Mathematics, Jadavpur University, Kolkata-700032, West Bengal, India. E-mail: bcgiri.jumath@gmail.com

Corresponding author's email^{1*}: sura_pati@yahoo.co.in

ABSTRACT

This paper proposes hybrid vector similarity measures under single valued refined neutrosophic sets and proves some of its basic properties. The proposed similarity measure is then applied for solving multiple attribute decision making problems. Lastly, a numerical example of medical diagnosis is given on the basis of the proposed hybrid similarity measures and the results are compared with the results of other existing methods to validate the applicability, simplicity and effectiveness of the proposed method.

KEYWORDS: Single valued neutrosophic sets; Single valued refined neutrosophic sets; Hybrid vector similarity measures; Multi-attribute decision making.

1. INTRODUCTION

Smarandache (1998) initiated the theory of neutrosophic sets (NSs) which is characterized by a truth membership $T_A(x)$, an indeterminacy membership $I_A(x)$ and a falsity membership $F_A(x)$ to cope with indeterminate, incomplete and inconsistent information. However, single valued neutrosophic sets (SVNSs) defined by Wang et al. (2010) is useful tool for practical decision making purposes. Multi attribute decision making (MADM) under SVNSs attracted many researchers and many methods have been proposed for MADM problems such as TOPSIS (Zhang & Wu, 2014, Biswas et al., 2016a), grey relational analysis (Biswas et al., 2014a; Biswas et al., 2014b; Mondal & Pramanik, 2015a; Mondal & Pramanik, 2015c), outranking approach (Peng et al., 2014), maximizing deviation method (Şahin & Liu, 2016), hybrid vector similarity measure (Pramanik et al., 2017), etc. Further theoretical development and applications of SVNS can be found in the studies (Biswas et al. 2016a, 2016b, 2016c, 2016d, 2016e, 2017a, 2017b; Pramanik & Roy, 2104; Sodenkamp, 2102).

Hanafy et al. (2013) proposed a method to determine the correlation coefficient of NSs by using centroid method. Ye (2013a) defined correlation of SVNSs, correlation coefficient of SVNSs, and weighted correlation coefficient of SVNSs. In the same study, Ye (2013a) developed a multi-criteria decision making method (MCDM) based on weighted correlation coefficient and the weighted cosine similarity measure. Ye (2013b) proposed another form of correlation coefficient between SVNSs and presented a MADM method. Broumi and Smarandache (2013) proposed a new method called extended Hausdroff distance for SVNSs and a new series of similarity measures were developed to find the similarity of SVNSs. Majumdar and Samanta (2014) presented some similarity measures between SVNSs based on distance, a matching function, membership grades and defined the notion of entropy measure for

SVNSs. Ye (2014a) proposed cross entropy of SVNSs and solved a MCDM based on the cross entropy of SVNSs. Ye and Zhang (2014) formulated three similarity measures between SVNSs by utilizing maximum and minimum operators and investigated their characteristics. In the same study, Ye and Zhang (2014) developed weighted similarity measures for solving MADM problems under single valued neutrosophic setting. Ye (2014b) suggested three similarity measures between simplified NSs as an extension of the Jaccard, Dice and cosine similarity measures in vector space for solving MCDM problems. Ye (2015) proposed an improved cosine similarity measure for SVNSs and employed the concept for medical diagnosis. Mondal and Pramanik (2015b) defined tangent similarity measure due to Pramanik and Mondal (2015) and Mondal and Pramanik (2015f) and proved its basic properties. In the same study, Mondal and Pramanik (2015b) developed a new MADM method based on tangent similarity measure and presented two illustrative MADM problems. Ye and Fu (2016) presented a multi-period medical diagnosis method using tangent similarity measure and the weighted aggregation of multi-period information for solving multi-period medical diagnosis problems under single valued neutrosophic environment. Pramanik et al. (2017) investigated a new hybrid vector similarity measure under both single valued neutrosophic and interval neutrosophic assessments by extending the notion of variation coefficient similarity method (Xu et al., 2012) with neutrosophic information and proved some of their fundamental properties.

Smarandache (2013) generalized the conventional neutrosophic logic and defined the most n - symbol or numerical valued refined neutrosophic logic. Each neutrosophic element T, I, F can be refined into T_1, T_2, \dots, T_m , and I_1, I_2, \dots, I_p , and F_1, F_2, \dots, F_q , respectively, where $m, p, q (\geq 1)$ are integers and $m + p + q = n$. Broumi and Smarandache (2014) proposed cosine similarity measure for refined neutrosophic sets due to Bhattacharya's distance (Bhattacharya, 1946). Ye and Ye (2014) introduced the idea of single valued neutrosophic multi sets (SVNMSs) (refined sets) by combining SVNSs along with the theory of multisets (Yager, 1986) and presented several operational relations of SVNMSs. In the same study, Ye and Ye (2014) proposed Dice similarity measure and weighted Dice similarity measure for SVNMSs and investigated their properties. Chatterjee et al. (2015) slightly modified the definition of SVNMSs (Ye & Ye, 2014) and incorporated few new set-theoretic operators of SVNMSs and their properties. Broumi and Deli (2014) defined correlation measure of neutrosophic refined sets and applied the proposed model to medical diagnosis and pattern recognition problems. Ye et al. (2015) further defined generalized distance and its two similarity measures between SVNMSs and applied the concept to medical diagnosis problem. Mondal and Pramanik (2015e) developed a new multi attribute decision making method in refined neutrosophic set environment based on tangent function due to Mondal and Pramanik (2015b). Mondal and Pramanik (2015d) proposed neutrosophic refined similarity measure based on cotangent function and presented an application to suitable educational stream selection problem. Deli et al. (2015) studied several operators of neutrosophic refined sets such as union, intersection, convex, strongly convex in order to deal with indeterminate and inconsistent information. In their paper, Deli et al. (2015) also examined several results of neutrosophic refined sets using the proposed operators and defined distance measure of neutrosophic refined sets with properties. Karaaslan (2015) developed Jaccard, Dice and cosine similarity based MCDM methods in single valued refined neutrosophic set and interval neutrosophic refined set environment. Broumi and Smarandache (2015) proposed a new similarity measure between refined neutrosophic sets based on extended Housdorff distance of SVNSs and proved some of their basic properties. Mondal and Pramanik (2015e) discussed refined tangent similarity measure for SVNSs and they applied the proposed similarity measure to medical diagnosis problems. Juan-juan and Jian-qiang (2015) defined several multi-valued neutrosophic aggregation operators and established a MCDM method based on the proposed operators. Ye and Smarandache (2016) presented a MCDM method with single valued refined neutrosophic information by extending the concept of similarity method with single valued neutrosophic information of Majumdar and Samanta (2014).

In this paper, we propose another form of cosine similarity measures under SVRNSs by extending the concept given in (Broumi & Smarandache, 2014a; Rajarajeswari & Uma, 2014) and prove some of its basic properties. We propose hybrid vector similarity measure with single valued refined neutrosophic information by extending hybrid vector similarity measure of SVNSs (Pramanik et al., 2017) and prove some of its basic properties. The proposed similarity measure is a hybridization of Dice and cosine similarity measures under single valued refined neutrosophic information. Moreover, we establish weighted hybrid vector similarity measure under single valued refined neutrosophic environment and prove its basic properties. The article is structured in the following way. Section 2 presents some mathematical preliminaries which are required for the construction of the paper. In Section 3 defines hybrid similarity and weighted hybrid similarity measures of SVRNSs and proves some of their properties. Section 4 is devoted to develop two algorithms for solving MADM problems involving single valued refined neutrosophic information. An illustrative example of medical diagnosis is solved to demonstrate the applicability of the proposed procedure in Section 5. Conclusions and future scope of research are presented in Section 6.

2. MATHEMATICAL PRELIMINARIES

In this Section, we recall some basic definitions concerning neutrosophic sets, single valued neutrosophic sets, single valued refined neutrosophic sets.

2.1 Neutrosophic set (Smarandache, 1998)

Let U be a universal space of objects with a generic element of U denoted by z . Then, a neutrosophic set P on U is defined as given below.

$$P = \{z, \langle T_p(z), I_p(z), F_p(z) \rangle \mid z \in U\}$$

where, $T_p(z), I_p(z), F_p(z): U \rightarrow]0, 1^+[$ stand for the degree of membership, the degree of indeterminacy, and the degree of falsity-membership respectively of a point $z \in U$ to the set P satisfying the condition $0 \leq T_p(z) + I_p(z) + F_p(z) \leq 3^+$.

2.2 Single valued neutrosophic sets (Wang et al., 2010)

Consider U be a space of points with a generic element of U denoted by z , then a SVNS Q is defined as follows:

$$Q = \{z, \langle T_Q(z), I_Q(z), F_Q(z) \rangle \mid z \in U\}$$

where, $T_Q(x), I_Q(x), F_Q(x): U \rightarrow [0, 1]$ denote the degree of membership, the degree of indeterminacy, and the degree of falsity-membership respectively of a point $z \in U$ to the set Q satisfying the condition and $0 \leq T_Q(x) + I_Q(x) + F_Q(x) \leq 3$ for each point $z \in U$.

2.3 Single valued neutrosophic refined sets (Ye & Ye, 2014)

A SVNRS R in the universe $U = \{z_1, z_2, \dots, z_n\}$ is defined as follows:

$$R = \{ \langle z, (T_{1R}(z), T_{2R}(z), \dots, T_{sR}(z)), (I_{1R}(z), I_{2R}(z), \dots, I_{sR}(z)), (F_{1R}(z), F_{2R}(z), \dots, F_{sR}(z)) \rangle \mid z \in U \}$$

where $T_{1R}(z), T_{2R}(z), \dots, T_{sR}(z): U \rightarrow [0, 1]$, $I_{1R}(z), I_{2R}(z), \dots, I_{sR}(z): U \rightarrow [0, 1]$, $F_{1R}(z), F_{2R}(z), \dots, F_{sR}(z): U \rightarrow [0, 1]$ such that $0 \leq T_{iR}(z) + I_{iR}(z) + F_{iR}(z) \leq 3$ for $i = 1, 2, \dots, s$. where, s is said to be the dimension of R .

Definition 2.1 (Ye & Ye, 2014): Let R_1 and R_2 be two SVRNSs in U , where

$$R_1 = \{ \langle z, (T_{1R_1}(z), T_{2R_1}(z), \dots, T_{sR_1}(z)), (I_{1R_1}(z), I_{2R_1}(z), \dots, I_{sR_1}(z)), (F_{1R_1}(z), F_{2R_1}(z), \dots, F_{sR_1}(z)) \rangle \mid z \in U \},$$

$$R_2 = \{ \langle z, (T_{1R_2}(z), T_{2R_2}(z), \dots, T_{sR_2}(z)), (I_{1R_2}(z), I_{2R_2}(z), \dots, I_{sR_2}(z)), (F_{1R_2}(z), F_{2R_2}(z), \dots, F_{sR_2}(z)) \rangle \mid z \in U \},$$

then the relations between R_1 and R_2 are presented as follows:

(1). Containment:

$R_1 \subseteq R_2$, if and only if $T_{iR_1}(z) \leq T_{iR_2}(z)$, $I_{iR_1}(z) \geq I_{iR_2}(z)$, $F_{iR_1}(z) \geq F_{iR_2}(z)$ for $i = 1, 2, \dots, s$.

(2). Equality:

$R_1 = R_2$, if and only if $T_{iR_1}(z) = T_{iR_2}(z)$, $I_{iR_1}(z) = I_{iR_2}(z)$, $F_{iR_1}(z) = F_{iR_2}(z)$ for $i = 1, 2, \dots, s$.

(3). Union:

$R_1 \cup R_2 = \{ \langle z, (T_{iR_1}(z) \vee T_{iR_2}(z)), (I_{iR_1}(z) \wedge I_{iR_2}(z)), (F_{iR_1}(z) \wedge F_{iR_2}(z)) \rangle \mid z \in U \}$ for $i = 1, 2, \dots, s$.

(4). Intersection:

$R_1 \cap R_2 = \{ \langle z, (T_{iR_1}(z) \wedge T_{iR_2}(z)), (I_{iR_1}(z) \vee I_{iR_2}(z)), (F_{iR_1}(z) \vee F_{iR_2}(z)) \rangle \mid z \in U \}$ for $i = 1, 2, \dots, s$.

3. HYBRID VECTOR SIMILARITY MEASURES OF SVRNS

Definition 3.1 (Ye, 2014c): Let $P = \{z, \langle T_P(z), I_P(z), F_P(z) \rangle \mid z \in U\}$ and $Q = \{z, \langle T_Q(z), I_Q(z), F_Q(z) \rangle \mid z \in U\}$ be two SVNSs (non-refined) in the universe of discourse U . Then, the Dice similarity measure of SVNSs is defined as follows.

$$Dice(P, Q) = \frac{1}{n} \sum_{i=1}^n \frac{2(T_P(z_i) \cdot T_Q(z_i) + I_P(z_i) \cdot I_Q(z_i) + F_P(z_i) \cdot F_Q(z_i))}{[(T_P(z_i))^2 + (I_P(z_i))^2 + (F_P(z_i))^2 + (T_Q(z_i))^2 + (I_Q(z_i))^2 + (F_Q(z_i))^2]} \quad (1)$$

and if $w_i \in [0, 1]$ be the weight of z_i for $i = 1, 2, \dots, n$ such that $\sum_{i=1}^n w_i = 1$, then the weighted Dice similarity measure of SVNSs can be defined as follows.

$$Dice_w(P, Q) = \sum_{i=1}^n w_i \frac{2(T_P(z_i) \cdot T_Q(z_i) + I_P(z_i) \cdot I_Q(z_i) + F_P(z_i) \cdot F_Q(z_i))}{[(T_P(z_i))^2 + (I_P(z_i))^2 + (F_P(z_i))^2 + (T_Q(z_i))^2 + (I_Q(z_i))^2 + (F_Q(z_i))^2]} \quad (2)$$

Definition 3.2 (Broumi & Smarandache, 2014b): Let $P = \{z, \langle T_P(z), I_P(z), F_P(z) \rangle \mid z \in U\}$ and $Q = \{z, \langle T_Q(z), I_Q(z), F_Q(z) \rangle \mid z \in U\}$ be two SVNSs (non-refined) in the universe of discourse $U = \{z_1, z_2, \dots, z_n\}$. Then, the cosine similarity measure of SVNSs is defined as given below.

$$Cos(P, Q) = \frac{1}{n} \sum_{i=1}^n \frac{(T_P(z_i) \cdot T_Q(z_i) + I_P(z_i) \cdot I_Q(z_i) + F_P(z_i) \cdot F_Q(z_i))}{\sqrt{[(T_P(z_i))^2 + (I_P(z_i))^2 + (F_P(z_i))^2] \cdot [(T_Q(z_i))^2 + (I_Q(z_i))^2 + (F_Q(z_i))^2]}} \quad (3)$$

and if $w_i \in [0, 1]$ be the weight of z_i for $i = 1, 2, \dots, n$ satisfying $\sum_{i=1}^n w_i = 1$, then the weighted cosine similarity measure of SVNSs can be defined as follows.

$$Cos_w(P, Q) = \sum_{i=1}^n w_i \frac{(T_P(z_i) \cdot T_Q(z_i) + I_P(z_i) \cdot I_Q(z_i) + F_P(z_i) \cdot F_Q(z_i))}{\sqrt{[(T_P(z_i))^2 + (I_P(z_i))^2 + (F_P(z_i))^2] \cdot [(T_Q(z_i))^2 + (I_Q(z_i))^2 + (F_Q(z_i))^2]}} \quad (4)$$

Definition 3.3 (Pramanik et al., 2017): Hybrid vector similarity measure of SVNSs

Consider $Q_1 = \{z, \langle T_{Q_1}(z), I_{Q_1}(z), F_{Q_1}(z) \rangle \mid z \in U\}$ and $Q_2 = \{z, \langle T_{Q_2}(z), I_{Q_2}(z), F_{Q_2}(z) \rangle \mid z \in U\}$ be two SVNSs in U . Then, the hybrid vector similarity measure of Q_1 and Q_2 is defined as follows:

$$Hyb(Q_1, Q_2) = \frac{1}{n} \left[\alpha \sum_{i=1}^n \frac{2(T_{Q_1}(z_i) \cdot T_{Q_2}(z_i) + I_{Q_1}(z_i) \cdot I_{Q_2}(z_i) + F_{Q_1}(z_i) \cdot F_{Q_2}(z_i))}{[(T_{Q_1}(z_i))^2 + (I_{Q_1}(z_i))^2 + (F_{Q_1}(z_i))^2 + (T_{Q_2}(z_i))^2 + (I_{Q_2}(z_i))^2 + (F_{Q_2}(z_i))^2]} + (1 - \alpha) \sum_{i=1}^n \frac{(T_{Q_1}(z_i) \cdot T_{Q_2}(z_i) + I_{Q_1}(z_i) \cdot I_{Q_2}(z_i) + F_{Q_1}(z_i) \cdot F_{Q_2}(z_i))}{\sqrt{[(T_{Q_1}(z_i))^2 + (I_{Q_1}(z_i))^2 + (F_{Q_1}(z_i))^2] \cdot [(T_{Q_2}(z_i))^2 + (I_{Q_2}(z_i))^2 + (F_{Q_2}(z_i))^2]}} \right] \quad (5)$$

where $\alpha \in [0, 1]$.

Definition 3.4 (Pramanik et al., 2017): Weighted hybrid vector similarity measure of SVNNS

The weighted hybrid vector similarity measure of $Q_1 = \{z, \langle T_{Q_1}(z), I_{Q_1}(z), F_{Q_1}(z) \rangle \mid z \in U\}$ and $Q_2 = \{z, \langle T_{Q_2}(z), I_{Q_2}(z), F_{Q_2}(z) \rangle \mid z \in U\}$ can be defined as follows:

$$WHyb(Q_1, Q_2) = \left[\begin{aligned} & \alpha \sum_{i=1}^n w_i \frac{2(T_{Q_1}(z_i).T_{Q_2}(z_i) + I_{Q_1}(z_i).I_{Q_2}(z_i) + F_{Q_1}(z_i).F_{Q_2}(z_i))}{[(T_p(z_i))^2 + (I_p(z_i))^2 + (F_p(z_i))^2 + (T_Q(z_i))^2 + (I_Q(z_i))^2 + (F_Q(z_i))^2]} \\ & + (1-\alpha) \sum_{i=1}^n w_i \frac{(T_{Q_1}(z_i).T_{Q_2}(z_i) + I_{Q_1}(z_i).I_{Q_2}(z_i) + F_{Q_1}(z_i).F_{Q_2}(z_i))}{\sqrt{[(T_p(z_i))^2 + (I_p(z_i))^2 + (F_p(z_i))^2] \cdot \sqrt{[(T_Q(z_i))^2 + (I_Q(z_i))^2 + (F_Q(z_i))^2]}}} \end{aligned} \right] \quad (6)$$

(6)

where $w_i \in [0, 1]$ be the weight of z_i for $i = 1, 2, \dots, n$ such that $\sum_{i=1}^n w_i = 1$, and $\alpha \in [0, 1]$.

Definition 3.5 (Ye & Ye, 2014): Dice similarity measure between two SVNRSs Q_1, Q_2 is defined as follows.

$Dice_{SVNRS}(Q_1, Q_2)$

$$= \frac{1}{p} \sum_{j=1}^p \left\langle \frac{1}{n} \left[\sum_{i=1}^n \frac{2(T_{Q_1}^j(z_i).T_{Q_2}^j(z_i) + I_{Q_1}^j(z_i).I_{Q_2}^j(z_i) + F_{Q_1}^j(z_i).F_{Q_2}^j(z_i))}{[(T_{Q_1}^j(z_i))^2 + (I_{Q_1}^j(z_i))^2 + (F_{Q_1}^j(z_i))^2 + ((T_{Q_2}^j(z_i))^2 + (I_{Q_2}^j(z_i))^2 + (F_{Q_2}^j(z_i))^2]} \right] \right\rangle \quad (7)$$

(7)

Definition 3.6 (Ye & Ye, 2014): Weighted Dice similarity measure between two SVNRSs Q_1, Q_2 is presented as follows.

$WDice_{SVNRS}(Q_1, Q_2)$

$$= \frac{1}{p} \sum_{j=1}^p \left\langle \left[\sum_{i=1}^n w_i \frac{2(T_{Q_1}^j(z_i).T_{Q_2}^j(z_i) + I_{Q_1}^j(z_i).I_{Q_2}^j(z_i) + F_{Q_1}^j(z_i).F_{Q_2}^j(z_i))}{[(T_{Q_1}^j(z_i))^2 + (I_{Q_1}^j(z_i))^2 + (F_{Q_1}^j(z_i))^2 + ((T_{Q_2}^j(z_i))^2 + (I_{Q_2}^j(z_i))^2 + (F_{Q_2}^j(z_i))^2]} \right] \right\rangle \quad (8)$$

(8)

Definition 3.7: Cosine similarity measure between two SVNRSs Q_1, Q_2 can be defined in the following way:

$COS_{SVNRS}(Q_1, Q_2)$

$$= \frac{1}{p} \sum_{j=1}^p \left\langle \frac{1}{n} \left[\sum_{i=1}^n \frac{(T_{Q_1}^j(z_i).T_{Q_2}^j(z_i) + I_{Q_1}^j(z_i).I_{Q_2}^j(z_i) + F_{Q_1}^j(z_i).F_{Q_2}^j(z_i))}{\sqrt{[(T_{Q_1}^j(z_i))^2 + (I_{Q_1}^j(z_i))^2 + (F_{Q_1}^j(z_i))^2] \cdot \sqrt{[(T_{Q_2}^j(z_i))^2 + (I_{Q_2}^j(z_i))^2 + (F_{Q_2}^j(z_i))^2]}}} \right] \right\rangle. \quad (9)$$

(9)

Proposition 3.1 The defined cosine similarity measure $COS_{SVNRS}(Q_1, Q_2)$ between SVNRSs Q_1 and Q_2 satisfies the following properties:

P1. $0 \leq COS_{SVNRS}(Q_1, Q_2) \leq 1$

P2. $COS_{SVNRS}(Q_1, Q_2) = 1$, if and only if $Q_1 = Q_2$

P3. $COS_{SVNRS}(Q_1, Q_2) = COS_{SVNRS}(Q_2, Q_1)$.

Proof.

P1: According to Cauchy-Schwarz inequality:

$$(\mu_1.v_1 + \mu_2.v_2 + \dots + \mu_n.v_n)^2 \leq (\mu_1^2 + \mu_2^2 + \dots + \mu_n^2).(v_1^2 + v_2^2 + \dots + v_n^2), \text{ where } (\mu_1, \mu_2, \dots, \mu_n) \in \mathfrak{R}^n$$

and $(v_1, v_2, \dots, v_n) \in \mathfrak{R}^n$, we have

$$(T_p(z_i).T_Q(z_i) + I_p(z_i).I_Q(z_i) + F_p(z_i).F_Q(z_i)) \leq$$

$$\sqrt{(T_p(z_i))^2 + (I_p(z_i))^2 + (F_p(z_i))^2} \cdot \sqrt{(T_Q(z_i))^2 + (I_Q(z_i))^2 + (F_Q(z_i))^2}$$

$$\text{Therefore, } \frac{1}{n} \sum_{i=1}^n \left[\frac{(T_p(z_i).T_Q(z_i) + I_p(z_i).I_Q(z_i) + F_p(z_i).F_Q(z_i))}{\sqrt{[(T_p(z_i))^2 + (I_p(z_i))^2 + (F_p(z_i))^2] \cdot \sqrt{[(T_Q(z_i))^2 + (I_Q(z_i))^2 + (F_Q(z_i))^2]}}} \right] \leq 1,$$

So, $Cos_{SVRNS}(Q_1, Q_2) =$

$$\frac{1}{p} \sum_{j=1}^p \left\langle \frac{1}{n} \left[\sum_{i=1}^n \frac{(T_{Q_1}^j(z_i).T_{Q_2}^j(z_i) + I_{Q_1}^j(z_i).I_{Q_2}^j(z_i) + F_{Q_1}^j(z_i).F_{Q_2}^j(z_i))}{\sqrt{((T_{Q_1}^j(z_i))^2 + (I_{Q_1}^j(z_i))^2 + (F_{Q_1}^j(z_i))^2) \cdot \sqrt{(T_{Q_2}^j(z_i))^2 + (I_{Q_2}^j(z_i))^2 + (F_{Q_2}^j(z_i))^2)}} \right] \right\rangle \leq 1,$$

Obviously, $Cos_{SVRNS}(Q_1, Q_2) \geq 0$, thus $0 \leq Cos_{SVRNS}(Q_1, Q_2) \leq 1$

P₂: If $Q_1 = Q_2$, then, $T_{Q_1}^j(z_i) = T_{Q_2}^j(z_i)$, $I_{Q_1}^j(z_i) = I_{Q_2}^j(z_i)$ and $F_{Q_1}^j(z_i) = F_{Q_2}^j(z_i)$ for $i = 1, 2, \dots, n$; $j = 1, 2, \dots, p$.

Therefore, $Cos_{SVRNS}(Q_1, Q_1) =$

$$\frac{1}{p} \sum_{j=1}^p \left\langle \frac{1}{n} \left[\sum_{i=1}^n \frac{(T_{Q_1}^j(z_i).T_{Q_1}^j(z_i) + I_{Q_1}^j(z_i).I_{Q_1}^j(z_i) + F_{Q_1}^j(z_i).F_{Q_1}^j(z_i))}{\sqrt{((T_{Q_1}^j(z_i))^2 + (I_{Q_1}^j(z_i))^2 + (F_{Q_1}^j(z_i))^2) \cdot \sqrt{(T_{Q_1}^j(z_i))^2 + (I_{Q_1}^j(z_i))^2 + (F_{Q_1}^j(z_i))^2)}} \right] \right\rangle = 1.$$

P₃: $Cos_{SVRNS}(Q_1, Q_2) =$

$$\frac{1}{p} \sum_{j=1}^p \left\langle \frac{1}{n} \left[\sum_{i=1}^n \frac{(T_{Q_1}^j(z_i).T_{Q_2}^j(z_i) + I_{Q_1}^j(z_i).I_{Q_2}^j(z_i) + F_{Q_1}^j(z_i).F_{Q_2}^j(z_i))}{\sqrt{((T_{Q_1}^j(z_i))^2 + (I_{Q_1}^j(z_i))^2 + (F_{Q_1}^j(z_i))^2) \cdot \sqrt{(T_{Q_2}^j(z_i))^2 + (I_{Q_2}^j(z_i))^2 + (F_{Q_2}^j(z_i))^2)}} \right] \right\rangle =$$

$$\frac{1}{p} \sum_{j=1}^p \left\langle \frac{1}{n} \left[\sum_{i=1}^n \frac{(T_{Q_2}^j(z_i).T_{Q_1}^j(z_i) + I_{Q_2}^j(z_i).I_{Q_1}^j(z_i) + F_{Q_2}^j(z_i).F_{Q_1}^j(z_i))}{\sqrt{((T_{Q_2}^j(z_i))^2 + (I_{Q_2}^j(z_i))^2 + (F_{Q_2}^j(z_i))^2) \cdot \sqrt{(T_{Q_1}^j(z_i))^2 + (I_{Q_1}^j(z_i))^2 + (F_{Q_1}^j(z_i))^2)}} \right] \right\rangle = Cos_{SVRNS}(Q_2, Q_1).$$

Q_1).

Definition 3.8: Weighted cosine similarity measure between SVNRs Q_1, Q_2 can be defined as follows:

$WCos_{SVRNS}(Q_1, Q_2)$

$$= \frac{1}{p} \sum_{j=1}^p \left\langle \frac{\sum_{i=1}^n w_i \left[\frac{(T_{Q_1}^j(z_i).T_{Q_2}^j(z_i) + I_{Q_1}^j(z_i).I_{Q_2}^j(z_i) + F_{Q_1}^j(z_i).F_{Q_2}^j(z_i))}{\sqrt{((T_{Q_1}^j(z_i))^2 + (I_{Q_1}^j(z_i))^2 + (F_{Q_1}^j(z_i))^2) \cdot \sqrt{(T_{Q_2}^j(z_i))^2 + (I_{Q_2}^j(z_i))^2 + (F_{Q_2}^j(z_i))^2)}} \right]}{\sum_{i=1}^n w_i} \right\rangle$$

(10)

Proposition 3.2 The defined weighted cosine similarity measure $WCos_{SVRNS}(Q_1, Q_2)$ between SVNRs Q_1 and Q_2 satisfies the following properties:

P₁. $0 \leq WCos_{SVRNS}(Q_1, Q_2) \leq 1$

P₂. $WCos_{SVRNS}(Q_1, Q_2) = 1$, if and only if $Q_1 = Q_2$

P₃. $WCos_{SVRNS}(Q_1, Q_2) = Cos_{SVRNS}(Q_2, Q_1)$

Proof.

P₁: From Cauchy-Schwarz inequality, we have

$$(T_p(z_i).T_Q(z_i) + I_p(z_i).I_Q(z_i) + F_p(z_i).F_Q(z_i)) \leq \sqrt{(T_p(z_i))^2 + (I_p(z_i))^2 + (F_p(z_i))^2} \cdot \sqrt{(T_Q(z_i))^2 + (I_Q(z_i))^2 + (F_Q(z_i))^2}$$

$$\text{So, } \sum_{i=1}^n w_i \left[\frac{(T_p(z_i).T_Q(z_i) + I_p(z_i).I_Q(z_i) + F_p(z_i).F_Q(z_i))}{\sqrt{(T_p(z_i))^2 + (I_p(z_i))^2 + (F_p(z_i))^2} \cdot \sqrt{(T_Q(z_i))^2 + (I_Q(z_i))^2 + (F_Q(z_i))^2}} \right] \leq 1, w_i \in [0, 1] \text{ and}$$

$$\sum_{i=1}^n w_i = 1.$$

$WCos_{SVRNS}(Q_1, Q_2) =$

$$\frac{1}{p} \sum_{j=1}^p \left\langle \frac{\sum_{i=1}^n w_i \left[\frac{(T_{Q_1}^j(z_i).T_{Q_2}^j(z_i) + I_{Q_1}^j(z_i).I_{Q_2}^j(z_i) + F_{Q_1}^j(z_i).F_{Q_2}^j(z_i))}{\sqrt{((T_{Q_1}^j(z_i))^2 + (I_{Q_1}^j(z_i))^2 + (F_{Q_1}^j(z_i))^2) \cdot \sqrt{(T_{Q_2}^j(z_i))^2 + (I_{Q_2}^j(z_i))^2 + (F_{Q_2}^j(z_i))^2)}} \right]}{\sum_{i=1}^n w_i} \right\rangle \leq 1,$$

where $w_i \in [0, 1]$ be the weight of z_i for $i = 1, 2, \dots, n$ such that $\sum_{i=1}^n w_i = 1$. Obviously, $WCos_{SVRNS}(Q_1, Q_2) \geq 0$, and therefore $0 \leq WCos_{SVRNS}(Q_1, Q_2) \leq 1$

P₂: If $Q_1 = Q_2$, then, $T_{Q_1}^j(z_i) = T_{Q_2}^j(z_i)$, $I_{Q_1}^j(z_i) = I_{Q_2}^j(z_i)$ and $F_{Q_1}^j(z_i) = F_{Q_2}^j(z_i)$ for $i = 1, 2, \dots, n$; $j = 1, 2, \dots, p$.

$$\dots, p.$$

$$WCos_{SVRNS}(Q_1, Q_1) = \frac{1}{p} \sum_{j=1}^p \left\langle \left[\frac{\sum_{i=1}^n w_i \left[\frac{(T_{Q_1}^j(z_i) \cdot T_{Q_1}^j(z_i) + I_{Q_1}^j(z_i) \cdot I_{Q_1}^j(z_i) + F_{Q_1}^j(z_i) \cdot F_{Q_1}^j(z_i))}{\sqrt{((T_{Q_1}^j(z_i))^2 + (I_{Q_1}^j(z_i))^2 + (F_{Q_1}^j(z_i))^2)} \cdot \sqrt{(T_{Q_1}^j(z_i))^2 + (I_{Q_1}^j(z_i))^2 + (F_{Q_1}^j(z_i))^2}} \right]} \right] \right\rangle = 1.$$

$$P_3: WCos_{SVRNS}(Q_1, Q_2) = \frac{1}{p} \sum_{j=1}^p \left\langle \left[\frac{\sum_{i=1}^n w_i \left[\frac{(T_{Q_1}^j(z_i) \cdot T_{Q_2}^j(z_i) + I_{Q_1}^j(z_i) \cdot I_{Q_2}^j(z_i) + F_{Q_1}^j(z_i) \cdot F_{Q_2}^j(z_i))}{\sqrt{((T_{Q_1}^j(z_i))^2 + (I_{Q_1}^j(z_i))^2 + (F_{Q_1}^j(z_i))^2)} \cdot \sqrt{(T_{Q_2}^j(z_i))^2 + (I_{Q_2}^j(z_i))^2 + (F_{Q_2}^j(z_i))^2}} \right]} \right] \right\rangle =$$

$$\frac{1}{p} \sum_{j=1}^p \left\langle \left[\frac{\sum_{i=1}^n w_i \left[\frac{(T_{Q_2}^j(z_i) \cdot T_{Q_1}^j(z_i) + I_{Q_2}^j(z_i) \cdot I_{Q_1}^j(z_i) + F_{Q_2}^j(z_i) \cdot F_{Q_1}^j(z_i))}{\sqrt{((T_{Q_2}^j(z_i))^2 + (I_{Q_2}^j(z_i))^2 + (F_{Q_2}^j(z_i))^2)} \cdot \sqrt{(T_{Q_1}^j(z_i))^2 + (I_{Q_1}^j(z_i))^2 + (F_{Q_1}^j(z_i))^2}} \right]} \right] \right\rangle = WCos_{SVRNS}(Q_2, Q_1).$$

Next, we have defined hybrid vector similarity methods between SVRNSs by extending the concept of Pramanik et al. (2017) as given below.

Definition 3.9: Hybrid vector similarity measure between SVRNSs Q_1, Q_2 can be defined as follows:

$$Hyb_{SVRNS}(Q_1, Q_2) = \frac{1}{p} \sum_{j=1}^p \left\langle \left[\frac{1}{n} \left[\alpha \sum_{i=1}^n \left[\frac{2(T_{Q_1}^j(z_i) \cdot T_{Q_2}^j(z_i) + I_{Q_1}^j(z_i) \cdot I_{Q_2}^j(z_i) + F_{Q_1}^j(z_i) \cdot F_{Q_2}^j(z_i))}{\sqrt{((T_{Q_1}^j(z_i))^2 + (I_{Q_1}^j(z_i))^2 + (F_{Q_1}^j(z_i))^2)} \cdot \sqrt{(T_{Q_2}^j(z_i))^2 + (I_{Q_2}^j(z_i))^2 + (F_{Q_2}^j(z_i))^2}} \right]} \right] + (1-\alpha) \sum_{i=1}^n \left[\frac{(T_{Q_1}^j(z_i) \cdot T_{Q_2}^j(z_i) + I_{Q_1}^j(z_i) \cdot I_{Q_2}^j(z_i) + F_{Q_1}^j(z_i) \cdot F_{Q_2}^j(z_i))}{\sqrt{((T_{Q_1}^j(z_i))^2 + (I_{Q_1}^j(z_i))^2 + (F_{Q_1}^j(z_i))^2)} \cdot \sqrt{(T_{Q_2}^j(z_i))^2 + (I_{Q_2}^j(z_i))^2 + (F_{Q_2}^j(z_i))^2}} \right]} \right] \right\rangle$$

(11)

where $\alpha \in [0, 1]$.

Proposition 3.3 The defined single valued refined hybrid vector similarity measure $Hyb_{SVRNS}(Q_1, Q_2)$ between two SVRNSs Q_1 and Q_2 satisfies the following properties:

- P₁. $0 \leq Hyb_{SVRNS}(Q_1, Q_2) \leq 1$
- P₂. $Hyb_{SVRNS}(Q_1, Q_2) = 1$, if and only if $Q_1 = Q_2$.
- P₃. $Hyb_{SVRNS}(Q_1, Q_2) = Hyb_{SVRNS}(Q_2, Q_1)$.

Proof.

P₁. From Dice and cosine measures of SVRNSs defined in Equation (7) and Equation (9), we have $0 \leq Dice_{SVRNS}(Q_1, Q_2) \leq 1, 0 \leq Cos_{SVRNS}(Q_1, Q_2) \leq 1$.

Therefore, we have, $Dice_{SVRNS}(Q_1, Q_2) =$

$$\frac{1}{n} \sum_{i=1}^n \frac{2(T_{Q_1}^j(z_i) \cdot T_{Q_2}^j(z_i) + I_{Q_1}^j(z_i) \cdot I_{Q_2}^j(z_i) + F_{Q_1}^j(z_i) \cdot F_{Q_2}^j(z_i))}{\sqrt{((T_{Q_1}^j(z_i))^2 + (I_{Q_1}^j(z_i))^2 + (F_{Q_1}^j(z_i))^2)} \cdot \sqrt{(T_{Q_2}^j(z_i))^2 + (I_{Q_2}^j(z_i))^2 + (F_{Q_2}^j(z_i))^2}} \leq 1, \text{ for } j = 1, 2, \dots, p,$$

$Cos_{SVRNS}(Q_1, Q_2) =$

$$\frac{1}{n} \sum_{i=1}^n \left[\frac{(T_{Q_1}^j(z_i) \cdot T_{Q_2}^j(z_i) + I_{Q_1}^j(z_i) \cdot I_{Q_2}^j(z_i) + F_{Q_1}^j(z_i) \cdot F_{Q_2}^j(z_i))}{\sqrt{((T_{Q_1}^j(z_i))^2 + (I_{Q_1}^j(z_i))^2 + (F_{Q_1}^j(z_i))^2)} \cdot \sqrt{(T_{Q_2}^j(z_i))^2 + (I_{Q_2}^j(z_i))^2 + (F_{Q_2}^j(z_i))^2}} \right] \leq 1, \text{ for } j = 1, 2, \dots,$$

$p,$

Here, $(\alpha) Dice_{SVRNS}(Q_1, Q_2) + (1-\alpha) Cos_{SVRNS}(Q_1, Q_2) =$

$$(\alpha) \frac{1}{n} \left(\sum_{i=1}^n \left[\frac{2(T_{Q_1}^j(z_i) \cdot T_{Q_2}^j(z_i) + I_{Q_1}^j(z_i) \cdot I_{Q_2}^j(z_i) + F_{Q_1}^j(z_i) \cdot F_{Q_2}^j(z_i))}{\sqrt{((T_{Q_1}^j(z_i))^2 + (I_{Q_1}^j(z_i))^2 + (F_{Q_1}^j(z_i))^2)} \cdot \sqrt{(T_{Q_2}^j(z_i))^2 + (I_{Q_2}^j(z_i))^2 + (F_{Q_2}^j(z_i))^2}} \right] \right) + \quad (1-$$

$$\alpha) \frac{1}{n} \left(\sum_{i=1}^n \left[\frac{(T_{Q_1}^j(z_i) \cdot T_{Q_2}^j(z_i) + I_{Q_1}^j(z_i) \cdot I_{Q_2}^j(z_i) + F_{Q_1}^j(z_i) \cdot F_{Q_2}^j(z_i))}{\sqrt{((T_{Q_1}^j(z_i))^2 + (I_{Q_1}^j(z_i))^2 + (F_{Q_1}^j(z_i))^2)} \cdot \sqrt{(T_{Q_2}^j(z_i))^2 + (I_{Q_2}^j(z_i))^2 + (F_{Q_2}^j(z_i))^2}} \right] \right) \leq \alpha + (1-\alpha) = 1,$$

for $j = 1, 2, \dots, p$.

Therefore, $Hyb_{SVRNS}(Q_1, Q_2)$

$$= \frac{1}{p} \sum_{j=1}^p \left\langle \frac{1}{n} \left[\alpha \sum_{i=1}^n \frac{2(T_{Q_1}^j(z_i).T_{Q_2}^j(z_i) + I_{Q_1}^j(z_i).I_{Q_2}^j(z_i) + F_{Q_1}^j(z_i).F_{Q_2}^j(z_i))}{[(T_{Q_1}^j(z_i))^2 + (I_{Q_1}^j(z_i))^2 + (F_{Q_1}^j(z_i))^2 + (T_{Q_2}^j(z_i))^2 + (I_{Q_2}^j(z_i))^2 + (F_{Q_2}^j(z_i))^2]} + (1-\alpha) \sum_{i=1}^n \frac{(T_{Q_1}^j(z_i).T_{Q_2}^j(z_i) + I_{Q_1}^j(z_i).I_{Q_2}^j(z_i) + F_{Q_1}^j(z_i).F_{Q_2}^j(z_i))}{\sqrt{[(T_{Q_1}^j(z_i))^2 + (I_{Q_1}^j(z_i))^2 + (F_{Q_1}^j(z_i))^2] \cdot [(T_{Q_2}^j(z_i))^2 + (I_{Q_2}^j(z_i))^2 + (F_{Q_2}^j(z_i))^2]}} \right] \right\rangle \leq 1.$$

Also, $Dice_{SVRNS}(Q_1, Q_2), Cos_{SVRNS}(Q_1, Q_2) \geq 0$, for $j = 1, 2, \dots, p$.

Obviously, $Hyb_{SVRNS}(Q_1, Q_2) \geq 0$.

This proves that $0 \leq Hyb_{SVRNS}(Q_1, Q_2) \leq 1$.

P₂. For any two SVNRSSs Q_1 and Q_2 , if $Q_1 = Q_2$, this implies $T_{Q_1}^j(z_i) = T_{Q_2}^j(z_i), I_{Q_1}^j(z_i) = I_{Q_2}^j(z_i),$

$F_{Q_1}^j(z_i) = F_{Q_2}^j(z_i)$, for $i = 1, 2, \dots, n$ and $j = 1, 2, \dots, p$.

$$Dice_{SVRNS}(Q_1, Q_2) = \frac{1}{n} \sum_{i=1}^n \frac{2(T_{Q_1}^j(z_i).T_{Q_2}^j(z_i) + I_{Q_1}^j(z_i).I_{Q_2}^j(z_i) + F_{Q_1}^j(z_i).F_{Q_2}^j(z_i))}{[(T_{Q_1}^j(z_i))^2 + (I_{Q_1}^j(z_i))^2 + (F_{Q_1}^j(z_i))^2 + (T_{Q_2}^j(z_i))^2 + (I_{Q_2}^j(z_i))^2 + (F_{Q_2}^j(z_i))^2]} = 1,$$

for $j = 1, 2, \dots, p$, and

$$Cos_{SVRNS}(Q_1, Q_2) = \sum_{i=1}^n \left[\frac{(T_{Q_1}^j(z_i).T_{Q_2}^j(z_i) + I_{Q_1}^j(z_i).I_{Q_2}^j(z_i) + F_{Q_1}^j(z_i).F_{Q_2}^j(z_i))}{\sqrt{[(T_{Q_1}^j(z_i))^2 + (I_{Q_1}^j(z_i))^2 + (F_{Q_1}^j(z_i))^2] \cdot [(T_{Q_2}^j(z_i))^2 + (I_{Q_2}^j(z_i))^2 + (F_{Q_2}^j(z_i))^2]}} \right] = 1, \text{ for } j$$

$= 1, 2, \dots, p$. Hence, $Hyb_{SVRNS}(Q_1, Q_2) = 1$.

P₃. $Hyb_{SVRNS}(Q_1, Q_2)$

$$= \frac{1}{p} \sum_{j=1}^p \left\langle \frac{1}{n} \left[\alpha \sum_{i=1}^n \frac{2(T_{Q_1}^j(z_i).T_{Q_2}^j(z_i) + I_{Q_1}^j(z_i).I_{Q_2}^j(z_i) + F_{Q_1}^j(z_i).F_{Q_2}^j(z_i))}{[(T_{Q_1}^j(z_i))^2 + (I_{Q_1}^j(z_i))^2 + (F_{Q_1}^j(z_i))^2 + (T_{Q_2}^j(z_i))^2 + (I_{Q_2}^j(z_i))^2 + (F_{Q_2}^j(z_i))^2]} + (1-\alpha) \sum_{i=1}^n \frac{(T_{Q_1}^j(z_i).T_{Q_2}^j(z_i) + I_{Q_1}^j(z_i).I_{Q_2}^j(z_i) + F_{Q_1}^j(z_i).F_{Q_2}^j(z_i))}{\sqrt{[(T_{Q_1}^j(z_i))^2 + (I_{Q_1}^j(z_i))^2 + (F_{Q_1}^j(z_i))^2] \cdot [(T_{Q_2}^j(z_i))^2 + (I_{Q_2}^j(z_i))^2 + (F_{Q_2}^j(z_i))^2]}} \right] \right\rangle$$

$$= \frac{1}{p} \sum_{j=1}^p \left\langle \frac{1}{n} \left[\alpha \sum_{i=1}^n \frac{2(T_{Q_2}^j(z_i).T_{Q_1}^j(z_i) + I_{Q_2}^j(z_i).I_{Q_1}^j(z_i) + F_{Q_2}^j(z_i).F_{Q_1}^j(z_i))}{[(T_{Q_2}^j(z_i))^2 + (I_{Q_2}^j(z_i))^2 + (F_{Q_2}^j(z_i))^2 + (T_{Q_1}^j(z_i))^2 + (I_{Q_1}^j(z_i))^2 + (F_{Q_1}^j(z_i))^2]} + (1-\alpha) \sum_{i=1}^n \frac{(T_{Q_2}^j(z_i).T_{Q_1}^j(z_i) + I_{Q_2}^j(z_i).I_{Q_1}^j(z_i) + F_{Q_2}^j(z_i).F_{Q_1}^j(z_i))}{\sqrt{[(T_{Q_2}^j(z_i))^2 + (I_{Q_2}^j(z_i))^2 + (F_{Q_2}^j(z_i))^2] \cdot [(T_{Q_1}^j(z_i))^2 + (I_{Q_1}^j(z_i))^2 + (F_{Q_1}^j(z_i))^2]}} \right] \right\rangle$$

$= Hyb_{SVRNS}(Q_2, Q_1)$.

Definition 10: Weighted hybrid vector similarity measure between SVRNSs can be defined as follows.

$WHyb_w(Q_1, Q_2)$

$$= \frac{1}{p} \sum_{j=1}^p \left\langle \alpha \sum_{i=1}^n w_i \frac{2(T_{Q_1}^j(z_i).T_{Q_2}^j(z_i) + I_{Q_1}^j(z_i).I_{Q_2}^j(z_i) + F_{Q_1}^j(z_i).F_{Q_2}^j(z_i))}{[(T_{Q_1}^j(z_i))^2 + (I_{Q_1}^j(z_i))^2 + (F_{Q_1}^j(z_i))^2 + (T_{Q_2}^j(z_i))^2 + (I_{Q_2}^j(z_i))^2 + (F_{Q_2}^j(z_i))^2]} + (1-\alpha) \sum_{i=1}^n w_i \frac{(T_{Q_1}^j(z_i).T_{Q_2}^j(z_i) + I_{Q_1}^j(z_i).I_{Q_2}^j(z_i) + F_{Q_1}^j(z_i).F_{Q_2}^j(z_i))}{\sqrt{[(T_{Q_1}^j(z_i))^2 + (I_{Q_1}^j(z_i))^2 + (F_{Q_1}^j(z_i))^2] \cdot [(T_{Q_2}^j(z_i))^2 + (I_{Q_2}^j(z_i))^2 + (F_{Q_2}^j(z_i))^2]}} \right\rangle$$

(12)

Here, $w_i \in [0, 1]$ represents the weight of z_i for $i = 1, 2, \dots, n$ such that $\sum_{i=1}^n w_i = 1$, where $\alpha \in [0, 1]$, and

$WHyb_w(Q_1, Q_2)$ should satisfy the following properties.

Proposition 3.4

P₁. $0 \leq WHyb_w(Q_1, Q_2) \leq 1$.

P₂. $WHyb_w(Q_1, Q_2) = 1$, if and only if $Q_1 = Q_2$.

P₃. $WHyb_w(Q_1, Q_2) = WHyb_w(Q_2, Q_1)$.

Proof.

P₁. Using Dice and cosine measures of SVRNSs, we have $0 \leq Dice_{SVRNS}(Q_1, Q_2) \leq 1$, $0 \leq Cos_{SVRNS}(Q_1, Q_2) \leq 1$.

$$\begin{aligned}
 & (\alpha) Dice_{SVRNS}(Q_1, Q_2) + (1-\alpha) Cos_{SVRNS}(Q_1, Q_2) = \\
 & (\alpha) \frac{1}{n} \left(\sum_{i=1}^n \frac{2(T_{Q_1}^j(z_i).T_{Q_2}^j(z_i) + I_{Q_1}^j(z_i).I_{Q_2}^j(z_i) + F_{Q_1}^j(z_i).F_{Q_2}^j(z_i))}{[(T_{Q_1}^j(z_i))^2 + (I_{Q_1}^j(z_i))^2 + (F_{Q_1}^j(z_i))^2 + (T_{Q_2}^j(z_i))^2 + (I_{Q_2}^j(z_i))^2 + (F_{Q_2}^j(z_i))^2]} \right) + \quad (1- \\
 & \alpha) \frac{1}{n} \left(\sum_{i=1}^n \frac{(T_{Q_1}^j(z_i).T_{Q_2}^j(z_i) + I_{Q_1}^j(z_i).I_{Q_2}^j(z_i) + F_{Q_1}^j(z_i).F_{Q_2}^j(z_i))}{\sqrt{[(T_{Q_1}^j(z_i))^2 + (I_{Q_1}^j(z_i))^2 + (F_{Q_1}^j(z_i))^2] \cdot [(T_{Q_2}^j(z_i))^2 + (I_{Q_2}^j(z_i))^2 + (F_{Q_2}^j(z_i))^2]}} \right) \leq \alpha + (1-\alpha) = 1,
 \end{aligned}$$

for $j = 1, 2, \dots, p$.

Therefore, $WHyb_w(Q_1, Q_2)$

$$= \frac{1}{p} \sum_{j=1}^p \left\langle \begin{aligned} & \alpha \sum_{i=1}^n w_i \frac{2(T_{Q_1}^j(z_i).T_{Q_2}^j(z_i) + I_{Q_1}^j(z_i).I_{Q_2}^j(z_i) + F_{Q_1}^j(z_i).F_{Q_2}^j(z_i))}{[(T_{Q_1}^j(z_i))^2 + (I_{Q_1}^j(z_i))^2 + (F_{Q_1}^j(z_i))^2 + (T_{Q_2}^j(z_i))^2 + (I_{Q_2}^j(z_i))^2 + (F_{Q_2}^j(z_i))^2]} \\ & + (1-\alpha) \sum_{i=1}^n w_i \frac{(T_{Q_1}^j(z_i).T_{Q_2}^j(z_i) + I_{Q_1}^j(z_i).I_{Q_2}^j(z_i) + F_{Q_1}^j(z_i).F_{Q_2}^j(z_i))}{\sqrt{[(T_{Q_1}^j(z_i))^2 + (I_{Q_1}^j(z_i))^2 + (F_{Q_1}^j(z_i))^2] \cdot [(T_{Q_2}^j(z_i))^2 + (I_{Q_2}^j(z_i))^2 + (F_{Q_2}^j(z_i))^2]}} \end{aligned} \right\rangle \leq 1.$$

$Dice_{SVRNS}(Q_1, Q_2), Cos_{SVRNS}(Q_1, Q_2) \geq 0$, for $j = 1, 2, \dots, p$.

Obviously, $WHyb_w(Q_1, Q_2) \geq 0$, therefore $0 \leq WHyb_w(Q_1, Q_2) \leq 1$.

P₂. If $Q_1 = Q_2$, then $T_{Q_1}^j(z_i) = T_{Q_2}^j(z_i)$, $I_{Q_1}^j(z_i) = I_{Q_2}^j(z_i)$, $F_{Q_1}^j(z_i) = F_{Q_2}^j(z_i)$, for $i = 1, 2, \dots, n$ and $j = 1, 2, \dots, p$.

$$Dice_{SVRNS}(Q_1, Q_2) = \frac{1}{n} \sum_{i=1}^n \frac{2(T_{Q_1}^j(z_i).T_{Q_2}^j(z_i) + I_{Q_1}^j(z_i).I_{Q_2}^j(z_i) + F_{Q_1}^j(z_i).F_{Q_2}^j(z_i))}{[(T_{Q_1}^j(z_i))^2 + (I_{Q_1}^j(z_i))^2 + (F_{Q_1}^j(z_i))^2 + (T_{Q_2}^j(z_i))^2 + (I_{Q_2}^j(z_i))^2 + (F_{Q_2}^j(z_i))^2]} = 1,$$

for $j = 1, 2, \dots, p$, and

$$Cos_{SVRNS}(Q_1, Q_2) = \sum_{i=1}^n \frac{(T_{Q_1}^j(z_i).T_{Q_2}^j(z_i) + I_{Q_1}^j(z_i).I_{Q_2}^j(z_i) + F_{Q_1}^j(z_i).F_{Q_2}^j(z_i))}{\sqrt{[(T_{Q_1}^j(z_i))^2 + (I_{Q_1}^j(z_i))^2 + (F_{Q_1}^j(z_i))^2] \cdot [(T_{Q_2}^j(z_i))^2 + (I_{Q_2}^j(z_i))^2 + (F_{Q_2}^j(z_i))^2]}} = 1, \text{ for } j$$

$= 1, 2, \dots, p$. Hence, $WHyb_w(Q_1, Q_2) = 1$.

P₃. $WHyb_w(Q_1, Q_2)$

$$\begin{aligned}
 & = \frac{1}{p} \sum_{j=1}^p \left\langle \begin{aligned} & \alpha \sum_{i=1}^n w_i \frac{2(T_{Q_1}^j(z_i).T_{Q_2}^j(z_i) + I_{Q_1}^j(z_i).I_{Q_2}^j(z_i) + F_{Q_1}^j(z_i).F_{Q_2}^j(z_i))}{[(T_{Q_1}^j(z_i))^2 + (I_{Q_1}^j(z_i))^2 + (F_{Q_1}^j(z_i))^2 + (T_{Q_2}^j(z_i))^2 + (I_{Q_2}^j(z_i))^2 + (F_{Q_2}^j(z_i))^2]} \\ & + (1-\alpha) \sum_{i=1}^n w_i \frac{(T_{Q_1}^j(z_i).T_{Q_2}^j(z_i) + I_{Q_1}^j(z_i).I_{Q_2}^j(z_i) + F_{Q_1}^j(z_i).F_{Q_2}^j(z_i))}{\sqrt{[(T_{Q_1}^j(z_i))^2 + (I_{Q_1}^j(z_i))^2 + (F_{Q_1}^j(z_i))^2] \cdot [(T_{Q_2}^j(z_i))^2 + (I_{Q_2}^j(z_i))^2 + (F_{Q_2}^j(z_i))^2]}} \end{aligned} \right\rangle \\
 & = \frac{1}{p} \sum_{j=1}^p \left\langle \begin{aligned} & \alpha \sum_{i=1}^n w_i \frac{2(T_{Q_2}^j(z_i).T_{Q_1}^j(z_i) + I_{Q_2}^j(z_i).I_{Q_1}^j(z_i) + F_{Q_2}^j(z_i).F_{Q_1}^j(z_i))}{[(T_{Q_2}^j(z_i))^2 + (I_{Q_2}^j(z_i))^2 + (F_{Q_2}^j(z_i))^2 + (T_{Q_1}^j(z_i))^2 + (I_{Q_1}^j(z_i))^2 + (F_{Q_1}^j(z_i))^2]} \\ & + (1-\alpha) \sum_{i=1}^n w_i \frac{(T_{Q_2}^j(z_i).T_{Q_1}^j(z_i) + I_{Q_2}^j(z_i).I_{Q_1}^j(z_i) + F_{Q_2}^j(z_i).F_{Q_1}^j(z_i))}{\sqrt{[(T_{Q_2}^j(z_i))^2 + (I_{Q_2}^j(z_i))^2 + (F_{Q_2}^j(z_i))^2] \cdot [(T_{Q_1}^j(z_i))^2 + (I_{Q_1}^j(z_i))^2 + (F_{Q_1}^j(z_i))^2]}} \end{aligned} \right\rangle \\
 & = WHyb_w(Q_2, Q_1).
 \end{aligned}$$

4. MADM WITH SINGLE VALUED REFINED NEUTROSOPHIC INFORMATION BASED ON HYBRID SIMILARITY MEASURE

Assume that $P = \{P_1, P_2, \dots, P_m\}$ ($m \geq 2$) be a discrete set of m candidates, $C = \{C_1, C_2, \dots, C_n\}$, ($n \geq 2$) be the set of attributes of each candidates, and $A = \{A_1, A_2, \dots, A_k\}$, ($k \geq 2$) be the set of alternatives of each candidate. The decision maker or expert presents the ranking of alternatives with regard to each

candidate. The ranking represents the performances of $P_i, i = 1, 2, \dots, m$ against the attributes $C_j, j = 1, 2, \dots, n$ and $w = (w_1, w_2, \dots, w_n)^T$ be the weight vector of the attributes $C_j, j = 1, 2, \dots, n$ with $0 \leq w_j \leq 1$ and $\sum_{j=1}^n w_j = 1$. The relation between candidates and attributes, and the relation between attributes and alternatives can be presented as follows (see Table 1 and Table 2 respectively).

Table 1. The relation between candidates and pre-defined attributes

$$\begin{pmatrix} & C_1 & C_2 & \dots & C_n \\ P_1 & \beta_{11}^t & \beta_{12}^t & \dots & \beta_{1n}^t \\ P_2 & \beta_{21}^t & \beta_{22}^t & \dots & \beta_{2n}^t \\ \cdot & \cdot & \cdot & \dots & \cdot \\ \cdot & \cdot & \cdot & \dots & \cdot \\ P_m & \beta_{m1}^t & \beta_{m2}^t & \dots & \beta_{mn}^t \end{pmatrix}$$

where $\beta_{ij}^t = \langle T_{ij}^t, I_{ij}^t, F_{ij}^t \rangle$ represents single valued neutrosophic numbers (SVNNs), $i = 1, 2, \dots, m; j = 1, 2, \dots, n; t = 1, 2, \dots, s$.

Table 2. The relation between attributes and alternatives

$$\begin{pmatrix} & A_1 & A_2 & \dots & A_k \\ C_1 & \gamma_{11} & \gamma_{12} & \dots & \gamma_{1k} \\ C_2 & \gamma_{21} & \gamma_{22} & \dots & \gamma_{2k} \\ \cdot & \cdot & \cdot & \dots & \cdot \\ \cdot & \cdot & \cdot & \dots & \cdot \\ C_n & \gamma_{n1} & \gamma_{n2} & \dots & \gamma_{nk} \end{pmatrix}$$

Here, $\gamma_{j\ell} = \langle T_{j\ell}, I_{j\ell}, F_{j\ell} \rangle$ denotes SVNNs, $j = 1, 2, \dots, n; \ell = 1, 2, \dots, k$.

We now develop two algorithms for MADM problems based on hybrid similarity measure with single valued refined neutrosophic information as given below.

Algorithm 1

Step 1. Calculate the single valued refined hybrid similarity measures between Table 1, and 2 by using Equation 11.

Step 2. Rank the alternatives based on the descending order of hybrid similarity measures. The biggest value reflects the best alternative.

Step 3. Stop.

Algorithm 2

Step 1. Compute the single valued refined weighted hybrid similarity measure between Table 1 and 2 by means of Equation 12.

Step 2. The alternatives are ranked in descending order of the refined weighted hybrid similarity measures. The highest value of refined weighted hybrid similarity measures indicates the best alternative.

Step 3. Stop.

5. APPLICATION OF THE PROPOSED METHOD TO MEDICAL DIAGNOSIS PROBLEM

We consider the illustrative example of medical diagnosis with single valued refined neutrosophic information studied in (Mondal & Pramanik, 2015e). Medical diagnosis has to deal with a large amount of uncertainties and huge amount of information available to the medical practitioners using new and advanced technologies. The procedure of classifying dissimilar set of symptoms under a single name of diseases is not easy (Broumi & Smarandache, 2014). Also, it is possible that every object has different truth, indeterminate and false membership functions and the proposed similarity measures among the patients versus symptoms and symptoms versus diseases will provide the appropriate medical diagnosis. In practical situation, there may occur errors in diagnosis if we consider data from single (one time) observation and therefore multi time inspection, by considering the samples of same patient at different times will provide best medical diagnosis (Rajarajeswari & Uma, 2014).

Consider $P = \{P_1, P_2, P_3, P_4\}$ be the set of four patients, $C = \{\text{viral fever, malaria, typhoid, stomach problem, chest problem}\}$ be the set of five diseases, $A = \{\text{temperature, headache, stomach pain, cough, chest pain}\}$ be the set of six symptoms. Now our objective is to examine the patient at different time intervals and we will obtain different truth, indeterminate and false membership functions for every patient. Let three observations are taken in a day: 7 am, 1 pm and 6 pm (see Table 3) (Mondal & Pramanik, 2015e).

Table 3. The relation between patients and symptoms

	Temperature	Headache	Stomach pain	Cough	Chest pain
P_1	(0.8, 0.1, 0.1)	(0.6, 0.1, 0.3)	(0.2, 0.8, 0.0)	(0.6, 0.1, 0.3)	(0.1, 0.6, 0.3)
	(0.6, 0.3, 0.3)	(0.5, 0.2, 0.4)	(0.3, 0.5, 0.2)	(0.4, 0.4, 0.4)	(0.3, 0.4, 0.5)
	(0.6, 0.3, 0.1)	(0.5, 0.1, 0.2)	(0.2, 0.3, 0.4)	(0.4, 0.3, 0.3)	(0.2, 0.5, 0.4)
P_2	(0.0, 0.8, 0.2)	(0.4, 0.4, 0.2)	(0.6, 0.1, 0.3)	(0.1, 0.7, 0.2)	(0.1, 0.8, 0.1)
	(0.2, 0.6, 0.4)	(0.5, 0.4, 0.1)	(0.4, 0.2, 0.5)	(0.2, 0.7, 0.5)	(0.3, 0.6, 0.4)
	(0.1, 0.6, 0.4)	(0.4, 0.6, 0.3)	(0.3, 0.2, 0.4)	(0.3, 0.5, 0.4)	(0.3, 0.6, 0.3)
P_3	(0.8, 0.1, 0.1)	(0.8, 0.1, 0.1)	(0.0, 0.6, 0.4)	(0.2, 0.7, 0.1)	(0.0, 0.5, 0.5)
	(0.6, 0.4, 0.1)	(0.6, 0.2, 0.4)	(0.2, 0.5, 0.5)	(0.2, 0.5, 0.5)	(0.2, 0.5, 0.3)
	(0.5, 0.3, 0.3)	(0.6, 0.1, 0.3)	(0.3, 0.4, 0.6)	(0.1, 0.6, 0.3)	(0.3, 0.3, 0.4)
P_4	(0.6, 0.1, 0.3)	(0.5, 0.4, 0.1)	(0.3, 0.4, 0.3)	(0.7, 0.2, 0.1)	(0.3, 0.4, 0.3)
	(0.4, 0.3, 0.2)	(0.4, 0.4, 0.4)	(0.2, 0.4, 0.5)	(0.5, 0.2, 0.4)	(0.4, 0.3, 0.4)
	(0.5, 0.2, 0.3)	(0.5, 0.2, 0.4)	(0.1, 0.5, 0.4)	(0.6, 0.4, 0.1)	(0.3, 0.5, 0.5)

The relation between symptoms and diseases in the form single valued neutrosophic assessments is given in Table 4 below.

Table 4. The relation between symptoms and diseases

	Viral fever	Malaria	Typhoid	Stomach problem	Chest problem
Temperature	(0.6, 0.3, 0.3)	(0.2, 0.5, 0.3)	(0.2, 0.6, 0.4)	(0.1, 0.6, 0.6)	(0.1, 0.6, 0.4)
Headache	(0.4, 0.5, 0.3)	(0.2, 0.6, 0.4)	(0.1, 0.5, 0.4)	(0.2, 0.4, 0.6)	(0.1, 0.6, 0.4)
Stomach pain	(0.1, 0.6, 0.3)	(0.0, 0.6, 0.4)	(0.2, 0.5, 0.5)	(0.8, 0.2, 0.2)	(0.1, 0.7, 0.1)
Cough	(0.4, 0.4, 0.4)	(0.4, 0.1, 0.5)	(0.2, 0.5, 0.5)	(0.1, 0.7, 0.4)	(0.4, 0.5, 0.4)
Chest pain	(0.1, 0.7, 0.4)	(0.1, 0.6, 0.3)	(0.1, 0.6, 0.4)	(0.1, 0.7, 0.4)	(0.8, 0.2, 0.2)

Now using Equation (11), Hybrid vector refined similarity measures (HVRSM) by considering $\alpha = 0.5$ between Relation 1, and 2 are presented as given below (see Table 5).

Table 5. HVRSM between Relation 1 and Relation 2

	Viral fever	Malaria	Typhoid	Stomach problem	Chest problem
P_1	0.9033	0.7953	0.7676	0.6809	0.6809
P_2	0.8135	0.7981	0.8892	0.8880	0.7446
P_3	0.8846	0.7418	0.7959	0.7074	0.6535
P_4	0.9116	0.8231	0.8031	0.6898	0.7526

The maximal HVRSM from Table 5 determines the proper medical diagnosis. Therefore, from Table 5, we observe that P_1, P_3, P_4 suffer from viral fever, and P_2 suffers from typhoid.

Also, using Equation (12), weighted hybrid vector refined similarity measures (WHVRSM) with known weight information $w = (0.3, 0.2, 0.15, 0.2, 0.15)$ and $\alpha = 0.5$ between Relation 1, and 2 are presented as given below (see the Table 6).

Table 6. Weighted hybrid vector refined similarity measure (WHVRSM) between Relation 1 and Relation 2

	Viral fever	Malaria	Typhoid	Stomach problem	Chest problem
P_1	0.9078	0.7721	0.7383	0.6533	0.6607
P_2	0.7994	0.8165	0.8989	0.8919	0.7909
P_3	0.8879	0.7189	0.7664	0.6886	0.6423
P_4	0.9189	0.8030	0.7814	0.6788	0.7326

Here, we also see that P_1, P_3, P_4 suffer from viral fever, and P_2 suffers from typhoid. By using Equation. 11, and 12, HVRSMs and WHVRSMs with different values of α between Relation 1, 2 are presented in the following Tables 7, 8, 9, 10, 11, 12, 13, and 14 and which patient suffers from which disease is indicated by \rightarrow mark below the Tables.

Table 7. HVRSM between Relation 1 and Relation 2 when $\alpha = 0.1$

	Viral fever	Malaria	Typhoid	Stomach problem	Chest problem
P_1	0.9059	0.7987	0.7706	0.6904	0.6849
P_2	0.8156	0.8033	0.8917	0.8931	0.7467
P_3	0.8880	0.7434	0.7976	0.7118	0.6562
P_4	0.9157	0.8301	0.8066	0.6979	0.7571

$P_1 \rightarrow$ Viral fever, $P_2 \rightarrow$ Stomach problem, $P_3 \rightarrow$ Viral fever, $P_4 \rightarrow$ Viral fever

Table 8. HVRSM between Relation 1 and Relation 2 when $\alpha = 0.25$

	Viral fever	Malaria	Typhoid	Stomach problem	Chest problem
P_1	0.9049	0.7974	0.7695	0.6868	0.6834
P_2	0.8148	0.8014	0.8908	0.8912	0.7459
P_3	0.8867	0.7428	0.7970	0.7102	0.6552
P_4	0.9142	0.8274	0.8053	0.6949	0.7554

$P_1 \rightarrow$ Viral fever, $P_2 \rightarrow$ Stomach problem, $P_3 \rightarrow$ Viral fever, $P_4 \rightarrow$ Viral fever

Table 9. HVRSM between Relation 1 and Relation 2 when $\alpha = 0.75$

	Viral fever	Malaria	Typhoid	Stomach problem	Chest problem
P_1	0.9016	0.7931	0.7658	0.6750	0.6784
P_2	0.8122	0.7948	0.8876	0.8848	0.7434
P_3	0.8825	0.7408	0.7949	0.7047	0.6517
P_4	0.9090	0.8187	0.8009	0.6847	0.7498

$P_1 \rightarrow$ Viral fever, $P_2 \rightarrow$ Typhoid, $P_3 \rightarrow$ Viral fever, $P_4 \rightarrow$ Viral fever

Table 10. HVRSM between Relation 1 and Relation 2 when $\alpha = 0.90$

	Viral fever	Malaria	Typhoid	Stomach problem	Chest problem
P_1	0.9006	0.7918	0.7647	0.6714	0.6769
P_2	0.8114	0.7928	0.8867	0.8829	0.7426
P_3	0.8813	0.7401	0.7942	0.7030	0.6507
P_4	0.9075	0.8161	0.7996	0.6816	0.7482

$P_1 \rightarrow$ Viral fever, $P_2 \rightarrow$ Typhoid, $P_3 \rightarrow$ Viral fever, $P_4 \rightarrow$ Viral fever

Table 11. WHVRSM between Relation 1 and Relation 2 when $\alpha = 0.1$

	Viral fever	Malaria	Typhoid	Stomach problem	Chest problem
P_1	0.9136	0.7756	0.7409	0.6616	0.6641
P_2	0.8014	0.8224	0.9012	0.8966	0.7890
P_3	0.8907	0.7208	0.7679	0.6926	0.6448
P_4	0.9233	0.8170	0.7852	0.6875	0.7408

$P_1 \rightarrow$ Viral fever, $P_2 \rightarrow$ Typhoid, $P_3 \rightarrow$ Viral fever, $P_4 \rightarrow$ Viral fever

Table 12. WHVRSM between Relation 1 and Relation 2 when $\alpha = 0.25$

	Viral fever	Malaria	Typhoid	Stomach problem	Chest problem
P_1	0.9114	0.7743	0.7399	0.6585	0.6628
P_2	0.8006	0.8202	0.9003	0.8948	0.7920
P_3	0.8397	0.7201	0.7673	0.6911	0.6438
P_4	0.9217	0.8162	0.7838	0.6842	0.7378

$P_1 \rightarrow$ Viral fever, $P_2 \rightarrow$ Typhoid, $P_3 \rightarrow$ Viral fever, $P_4 \rightarrow$ Viral fever

Table 13. WHVRSM between Relation 1, and 2 when $\alpha = 0.75$

	Viral fever	Malaria	Typhoid	Stomach problem	Chest problem
P_1	0.9041	0.7698	0.7366	0.6482	0.6585
P_2	0.7981	0.8128	0.8975	0.8890	0.7897
P_3	0.8695	0.7178	0.7655	0.6861	0.6408
P_4	0.9162	0.8138	0.7790	0.6734	0.7274

$P_1 \rightarrow$ Viral fever, $P_2 \rightarrow$ Typhoid, $P_3 \rightarrow$ Viral fever, $P_4 \rightarrow$ Viral fever

Table 14. WHVRSM between Relation 1, and 2 when $\alpha = 0.90$

	Viral fever	Malaria	Typhoid	Stomach problem	Chest problem
P_1	0.9019	0.7685	0.7356	0.6451	0.6572
P_2	0.7974	0.8106	0.8967	0.8873	0.7890
P_3	0.8785	0.7171	0.7649	0.6846	0.6400
P_4	0.9145	0.8130	0.7775	0.6702	0.7243

$P_1 \rightarrow$ Viral fever, $P_2 \rightarrow$ Typhoid, $P_3 \rightarrow$ Viral fever, $P_4 \rightarrow$ Viral fever

Note 1. Using neutrosophic refined tangent similarity measure, Mondal and Pramanik (2015e) obtained the results as shown in Table 15.

Table 15. The tangent refined similarity measure between Relation 1, and 2 (Mandal & Pramanik, 2015e)

	Viral fever	Malaria	Typhoid	Stomach problem	Chest problem
P_1	0.8963	0.8312	0.8237	0.8015	0.7778
P_2	0.8404	0.8386	0.8877	0.8768	0.8049
P_3	0.8643	0.8091	0.8393	0.7620	0.7540
P_4	0.8893	0.8465	0.8335	0.7565	0.7959

$P_1 \rightarrow$ Viral fever, $P_2 \rightarrow$ Typhoid, $P_3 \rightarrow$ Viral fever, $P_4 \rightarrow$ Viral fever

From the Table 15, we observe that P_1, P_3, P_4 suffer from viral fever, and P_2 suffers from typhoid.

6. CONCLUSION

We have investigated hybrid vector similarity and weighted hybrid vector similarity measures with single valued refined neutrosophic assessments and proved some of their basic properties. Then, the proposed hybrid similarity measures have been used to solve a medical diagnosis problem. We have compared the obtained results with different values of the parameter α and with the results of other existing method in order to verify the effectiveness of the proposed method. We hope that the proposed hybrid vector similarity measure can be applied to solve decision making problems in refined neutrosophic environment such as fault diagnosis, cluster analysis, data mining, investment, etc.

REFERENCES

- Bhattacharya. A. (1946). On a measure of divergence of two multimomial population. *Sankhya*,7, 401-406.
- Biswas, P., Pramanik, S., & Giri, B.C. (2014a). Entropy based grey relational analysis method for multi-attribute decision making under single valued neutrosophic assessment. *Neutrosophic Sets and Systems*, 2, 102-110.
- Biswas, P., Pramanik, S., & Giri, B.C. (2014b). A new methodology for neutrosophic multi-attribute decision making with unknown weight information. *Neutrosophic Sets and Systems*, 3, 42-50.
- Biswas, P., Pramanik, S., & Giri, B.C. (2016a). TOPSIS method for multi-attribute group decision making under single-valued neutrosophic environment. *Neural Computing and Applications* 27(3), 727-737. DOI: 10.1007/s00521-015-1891-2.
- Biswas, P., Pramanik, S., & Giri, B. C. (2016b). Value and ambiguity index based ranking method of single-valued trapezoidal neutrosophic numbers and its application to multi-

- attribute decision making. *Neutrosophic Sets and Systems* 12, 127-138.
- Biswas, P., Pramanik, S., & Giri, B. C. (2016c). Aggregation of triangular fuzzy neutrosophic set information and its application to multi-attribute decision making. *Neutrosophic Sets and Systems* 12, 20-40.
- Biswas, P., Pramanik, S., & Giri, B. C. (2016d). [GRA method of multiple attribute decision making with single valued neutrosophic hesitant fuzzy set information](#). In F. Smarandache, & S. Pramanik (Eds), *New trends in neutrosophic theory and applications* (pp. 55-63). Brussels: Pons Editions.
- Biswas, P., Pramanik, S., & Giri, B. C. (2016e). [Some distance measures of single valued neutrosophic hesitant fuzzy sets and their applications to multiple attribute decision making](#). In F. Smarandache, & S. Pramanik (Eds), *New trends in neutrosophic theory and applications* (pp. 55-63). Brussels: Pons Editions.
- Biswas, P., Pramanik, S., & Giri, B., C. (2017a). Non-linear programming approach for single-valued neutrosophic TOPSIS method, *New Mathematics and Natural Computation*, In Press.
- Biswas, P., Pramanik, S., & Giri, B., C. (2017b). Multi-attribute group decision making based on expected value of neutrosophic trapezoidal numbers. In F. Smarandache, & S. Pramanik (Eds.), *New trends in neutrosophic theory and applications*, Vol. -II. Brussels: Pons Editions.
- Broumi, S., & Smarandache, F. (2013). Several similarity measures of neutrosophic sets. *Neutrosophic Sets and Systems*, 1, 54-62.
- Broumi, S., & Smarandache, F. (2014a). Cosine similarity measure of interval neutrosophic sets. *Neutrosophic Sets and Systems*, 5, 15-20.
- Broumi, S., & Smarandache, F. (2014b). Neutrosophic refined similarity measure based on cosine function. *Neutrosophic Sets and Systems*, 6, 41-47.
- Broumi, S., & Smarandache, F. (2015). Extended Hausdorff distance and similarity measures for neutrosophic refined sets and their application in medical diagnosis. *Journal of New Theory*, (7), 64-78.
- Broumi, S., & Deli, I. (2014). Correlation measure for neutrosophic refined sets and its application in medical diagnosis. *Palestine Journal of Mathematics*, 3(1), 11-19.
- Chatterjee, R., Majumder, P., & Samanta, S.K. (2015). Single valued neutrosophic multisets. *Annals of Fuzzy Mathematics and Informatics*, 10(3), 499-514.
- Deli, I., Broumi, S., & Smarandache, F. (2015). On neutrosophic refined sets and their applications in medical diagnosis. *Journal of New Theory*, (6) 88-98.
- Hanafy, I.M., Salama, A.A., & Mahfouz, K.M. (2013). Correlation coefficient of neutrosophic sets by centroid method. *International Journal of Probability and Statistics*, 2(1), 9-12.
- Juan-juan, P., & Jian-qiang, W. (2015). Multi-valued neutrosophic sets and its application in multi-criteria decision-making problems. *Neutrosophic Sets and Systems*, 10, 3-17.
- Karaaslan, F. Multicriteria decision making method based on similarity measure under single valued neutrosophic refined and interval neutrosophic refined environments. arXiv:1512.03687v1 [math.GM].
- Majumder, P., & Samanta, S.K. (2014). On similarity and entropy of neutrosophic sets. *Journal of Intelligent and Fuzzy Systems*, 26, 1245-1252.

- Mondal, K., & Pramanik, S. (2015a). Neutrosophic decision making model for clay-brick selection in construction field based on grey relational analysis. *Neutrosophic Sets and Systems*, 9, 71-78.
- Mondal, K., & Pramanik, S. (2015b). Neutrosophic tangent similarity measure and its application to multiple attribute decision making. *Neutrosophic Sets and Systems*, 9, 85-92.
- Mondal, K., Pramanik, S. (2015c). Neutrosophic decision making model of school choice. *Neutrosophic Sets and Systems*, 7, 62-68.
- Mondal, K., & Pramanik, S. (2015d). Neutrosophic refined similarity measure based on cotangent function and its application to multi-attribute decision making. *Global Journal of Advanced Research*, 2(2), 486-496.
- Mondal, K., & Pramanik, S. (2015e). Neutrosophic refined similarity measure based on tangent function and its application to multi-attribute decision making. *Journal of New Theory*, (8), 41-50.
- Mondal, K., & Pramanik, S. (2015f). Intuitionistic fuzzy similarity measure based on tangent function and its application to multi-attribute decision making. *Global Journal of Advanced Research* 2(2), 464-471.
- Peng, J., Wang, J., Zhang, H., & Chen, X. (2014). An outranking approach for multi-criteria decision-making problems with simplified neutrosophic sets. *Applied Soft Computing*, 25, 336-346.
- Pramanik, S., Biswas, P. & Giri, B.C. (2017). Hybrid vector similarity measures and their applications to multi-attribute decision making under neutrosophic environment. *Neural Computing and Applications*, 28(5), 1163-1176.
- Pramanik, S., & Mondal, K. (2015). Weighted fuzzy similarity measure based on tangent function and its application to medical diagnosis. *International Journal of Innovative Research in Science, Engineering and Technology*, 4 (2), 158-164.
- Pramanik, S., & Roy, T. K. (2014). Neutrosophic game theoretic approach to Indo-Pak conflict over Jammu-Kashmir. *Neutrosophic Sets and Systems*, 2, 82-101.
- Rajarajeswari, P., & Uma, N. (2014). Zhang and Fu's similarity measure on intuitionistic fuzzy multi sets. *International Journal of Innovative Research in Science, Engineering and Technology*, 3(5), 12309-12317.
- Şahin, R., & Liu, P. (2016). Maximizing deviation method for neutrosophic multiple attribute decision making with incomplete weight information. *Neural Computing and Applications*, 27(7), 2017-2029.
- Smarandache, F. (1998). *A unifying field of logics. Neutrosophy: neutrosophic probability, set and logic*. Rehoboth: American Research Press.
- Smarandache, F. (2013). n-Valued refined neutrosophic logic and its applications to physics. *Progress in Physics*, 4, 143-146.
- Sodenkamp, M. (2013). *Models, methods and applications of group multiple-criteria decision analysis in complex and uncertain systems. Dissertation*, University of Paderborn, Germany.
- Wang, H., Smarandache, F., Zhang, Y., & Sunderraman, R. (2010). Single valued neutrosophic sets. *Multi-space and Multi-Structure*, 4, 410-413.
- Xu, X., Zhang, L., & Wan, Q. (2012). A variation coefficient similarity measure and its application in emergency group decision making. *System Engineering Procedia*, 5, 119-124.

- Abdel-Basset, M., Mohamed, M., Smarandache, F., & Chang, V. (2018). Neutrosophic Association Rule Mining Algorithm for Big Data Analysis. *Symmetry*, 10(4), 106.
- Abdel-Basset, M., & Mohamed, M. (2018). The Role of Single Valued Neutrosophic Sets and Rough Sets in Smart City: Imperfect and Incomplete Information Systems. *Measurement*. Volume 124, August 2018, Pages 47-55
- Abdel-Basset, M., Gunasekaran, M., Mohamed, M., & Smarandache, F. A novel method for solving the fully neutrosophic linear programming problems. *Neural Computing and Applications*, 1-11.
- Abdel-Basset, M., Manogaran, G., Gamal, A., & Smarandache, F. (2018). A hybrid approach of neutrosophic sets and DEMATEL method for developing supplier selection criteria. *Design Automation for Embedded Systems*, 1-22.
- Abdel-Basset, M., Mohamed, M., & Chang, V. (2018). NMCDA: A framework for evaluating cloud computing services. *Future Generation Computer Systems*, 86, 12-29.
- Abdel-Basset, M., Mohamed, M., Zhou, Y., & Hezam, I. (2017). Multi-criteria group decision making based on neutrosophic analytic hierarchy process. *Journal of Intelligent & Fuzzy Systems*, 33(6), 4055-4066.
- Abdel-Basset, M.; Mohamed, M.; Smarandache, F. An Extension of Neutrosophic AHP–SWOT Analysis for Strategic Planning and Decision-Making. *Symmetry* 2018, 10, 116.
- Yager., R. R. (1986). On the theory of bags (Multi-sets). *International Journal of General Systems*, 13, 23-37.
- Ye, J. (2013a). Multicriteria decision – making method using the correlation coefficient under single – valued neutrosophic environment. *International Journal of General Systems*, 42(4), 386-394.
- Ye, J. (2013b). Another form of correlation coefficient between single valued neutrosophic sets and its multiple attribute decision making method. *Neutrosophic Sets and Systems*, 1, 8-12.
- Ye, J. (2014a). Single valued neutrosophic cross-entropy for multicriteria decision making problems. *Applied Mathematical Modelling*, 38(3), 1170-1175.
- Ye, J. (2014b). Vector similarity measures of simplified neutrosophic sets and their application in multicriteria decision making. *International Journal of Fuzzy Systems*, 16(2), 204- 211.
- Ye, J. (2014c). Improved correlation coefficients of single valued neutrosophic sets and interval neutrosophic sets for multiple attribute decision making. *Journal of Intelligent & Fuzzy Systems*, 27, 2453-2462.
- Ye, J. (2015). Improved cosine similarity measure of simplified sets for medical diagnosis. *Artificial Intelligent in Medicine*, 63(3), 171-179.
- Ye, J., & Fu, J. (2016). Multi- period medical diagnosis method using a single-valued neutrosophic similarity measure based on tangent function. *Computer methods and Programs in Bio-medicine*, 123, 142-149.
- Ye, S., Fu, J. & Ye, J. (2015). Medical diagnosis using distance- valued similarity measures of single valued multisets. *Neutrosophic Sets and Systems*, 7, 47-52.
- Ye, J., & Smarandache, F. (2016). Similarity measure of refined single-valued neutrosophic sets and its multicriteria decision method. *Neutrosophic Sets and Systems*, 12, 41-44.
- Ye, S., & Ye, J. (2014). Dice similarity measure between single valued neutrosophic multisets and its application in medical diagnosis. *Neutrosophic Sets and Systems*, 6, 48-53.
- Ye, J., & Zhang, Q. (2014). Single valued neutrosophic similarity measures for multiple attribute decision – making. *Neutrosophic Sets and Systems*, 2, 48-54.
- Zhang, Z. & Wu. C. (2014). A novel method for single-valued neutrosophic multi-criteria decision making with incomplete weight information. *Neutrosophic Sets and Systems*, 4, 35-49.

Multi Criteria Decision Making Based on Projection and Bidirectional Projection Measures of Rough Neutrosophic Sets

Surapati Pramanik^{1*}, Rumi Roy², and Tapan Kumar Roy³

¹ Department of Mathematics, Nandalal Ghosh B.T. College, Panpur, P.O.-Narayanpur, District –North 24 Parganas, Pin code-743126, West Bengal, India. E-mail: sura_pati@yahoo.co.in

² Department of Mathematics, Indian Institute of Engineering Science and Technology, Shibpur, Howrah-711103, West Bengal, India. E-mail: roy.rumi.r@gmail.com

³ Department of Mathematics, Indian Institute of Engineering Science and Technology, Shibpur, Howrah-711103, West Bengal, India. E-mail: roy_t_k@gmail.com

Corresponding author's email^{1*}: sura_pati@yahoo.co.in

ABSTRACT

In this paper, we define projection and bidirectional projection measures between rough neutrosophic sets. Then two new multi criteria decision making methods are proposed based on neutrosophic projection and bidirectional projection measures respectively. Then the proposed methods are applied for solving multiple criteria group decision making problems. Finally, two numerical examples are provided to demonstrate the applicability and effectiveness of the proposed methods.

KEYWORDS: Rough neutrosophic set; projection measure; bidirectional projection measure.

1. INTRODUCTION

The concept of fuzzy set theory made its first appearance in the literature in two nearly simultaneous publications by Zadeh (1965) and Klaua (1965). Zadeh's work caught much more attention of the researchers than Klau's pure mathematical treatment. Zadeh (1965) defined fuzzy set by introducing membership function to deal non-statistical uncertainty. Atanassov (1983, 1986) defined intuitionistic fuzzy sets by introducing non-membership function as independent component. Smarandache (1998, 1999, 2002, 2005, 2010) introduced indeterminacy membership function as independent component and defined neutrosophic set. Smarandache (1998) paved the way to define single valued neutrosophic set (SVNS) (Wang et al., 2010) to deal realistic problems. SVNSs (Wang et al., 2010) have been widely studied and applied in different fields such as medical diagnosis (Ye, 2015b), multi criteria/multi attribute decision making (Sodenkamp, 2013; Ye, 2013a, 2013b, 2014a, 2014b, 2015a,; Biswas et al. 2014a, 2014b, 2015a, 2015b, 2016a, 2016b, 2017a, 2017b; Kharal, 2014; Liu et al., 2014; Liu & Li, 2017; Liu & Wang, 2014; Sahin & Liu, 2015; Peng et al., 2016; Pramanik et al., 2015, 2016; Broumi & Smarandache, 2013; Mondal & Pramanik, 2015d, 2015e), educational problem (Mondal & Pramanik, 2014b, 2015a), conflict resolution (Pramanik & Roy 2014), social problem (Pramanik & Chakrabarti, 2013, Mondal & Pramanik, 2014a), optimization (Das & Roy, 2015; Hezam et al, 2015; Abdel-Baset et al., 2016; Pramanik, 2016a, 2016b; Sarkar et al., 2016), clustering analysis (Ye, 2014a, 2014b), image processing (Cheng & Guo, 2008; Guo & Cheng, 2009; Guo et al., 2014), etc.

Pawlak (1982) proposed the concept of rough set. Rough set is an extension of the classical set theory (Cantor, 1874). It is very useful in dealing with incompleteness.

Broumi et al. (2014a, 2014b) proposed the concept of rough neutrosophic set (RNS) by combining the concept of rough set (Pawlak, 1982) and neutrosophic set (Smarandache, 1998). Rough neutrosophic set is very useful to deal with uncertain, inconsistent and incomplete information. Yang et al. (2016) introduced single valued neutrosophic rough sets on two-universes and presented an algorithm for multi criteria decision making (MCDM). Mondal and Pramanik (2015b) presented rough multi-attribute decision making based on grey relational analysis. Pramanik and Mondal (2015a) defined cosine similarity measure of rough neutrosophic sets and presented a MCDM approach in medical diagnosis. Mondal and Pramanik (2015c) presented MADM method using rough accuracy score function. Pramanik and Mondal (2015c) proposed cotangent similarity measure under rough neutrosophic environment. Pramanik and Mondal (2015b) further proposed some similarity measures namely, Dice similarity measure and Jaccard similarity measure in rough neutrosophic environment and their applications in MADM problems. Mondal et al. (2016a) defined several trigonometric Hamming similarity measures such as cosine, sine, cotangent similarity measures and proved some of their properties. In the same study (Mondal et al., 2016a) also presented MADM models based on Hamming similarity measures. Mondal et al. (2016b) proposed rough neutrosophic variational coefficient similarity measure and presented its application in multi attribute decision making. Mondal et al. (2016c) presented rough neutrosophic TOPSIS for multi-attribute group decision making problems.

Pramanik and Mondal (2015d) studied interval neutrosophic multi-attribute decision-making method based on GRA. Mondal and Pramanik (2015f) developed MADM methods based on cosine similarity measure, Dice similarity measure and Jaccard similarity measures under interval rough neutrosophic environment.

Mondal and Pramanik (2015g) proposed tri-complex rough neutrosophic similarity measure and presented its application in multi-attribute decision making problems. Mondal, Pramanik, Smarandache (2016d) defined rough neutrosophic hyper-complex set and presented its application to multi-attribute decision making problem.

Yue & Jia (2015) proposed a method for multi attribute group decision making (MAGDM) problems based on normalized projection measure, in which the attribute values are offered by decision makers in hybrid form with crisp values and interval data. Yue (2012a) studied a new method for MAGDM based on determining the weights of decision makers using an extended projection method with interval data. Yue (2012a) Xu and Da (2004) and Xu (2005) studied projection method for decision making in uncertain environment with preference information. Yue (2012b) described a model to obtain the weights of DMs with crisp values using a projection method. Yue (2017) defined new projection measures in real number and interval settings and proposed group decision-making with hybrid decision information, including real numbers and interval data. Zheng et al. (2010) proposed an improved grey relational projection method by combining grey relational analysis (GRA) and technique for order of preference by similarity to ideal solution (TOPSIS) to select the optimum building envelope.

Yang et al. (2014) develop projection method for material selection problem in fuzzy environment. Xu and Hu (2010) developed two projection based models for MADM in intuitionistic fuzzy and interval valued intuitionistic fuzzy environment. Zeng et al. (2013) provided weighted projection algorithm for intuitionistic fuzzy MADM problems and interval-valued intuitionistic fuzzy MADM problems.

Chen and Ye (2016) developed the projection based model for solving neutrosophic MADM problem and applied it to select clay-bricks in construction field.

Dey et al. (2016b) defined weighted projection measure with interval neutrosophic environment and applied it to solve MADM problems with interval valued neutrosophic information. Ye (2015c) developed a projection measure-based multiple attribute decision making method with interval neutrosophic information and credibility information.

To overcome the shortcomings of the general projection measure, Ye (2016) introduced a bidirectional projection measure between single valued neutrosophic numbers and developed MADM method for selecting problems of mechanical design schemes under a single valued neutrosophic environment. Ye (2015d) also presented the bidirectional projection method for multiple attribute group decision making with neutrosophic numbers.

Dey et al. (2016a) proposed a new approach to neutrosophic soft MADM using grey relational projection method. Yue (2012b) presented a projection method to obtain weights of the experts in a group decision making problem. Yue (2013) proposed a projection based approach for partner selection in a group decision making problem with linguistic value and intuitionistic fuzzy information.

Dey et al. (2017) defined projection, bidirectional projection and hybrid projection measures between bipolar neutrosophic sets and presented bipolar neutrosophic projection based models for multi-attribute decision making problems.

Literature review reflects that no studies have been made on multi-attribute decision making using projection and bidirectional projection measures under rough neutrosophic environment. In this paper, we propose projection and bidirectional projection measures under rough neutrosophic environment. We also present two numerical examples to show the effectiveness and applicability of the proposed measures.

Rest of the paper is organized as follows: Section 2 describes preliminaries of neutrosophic number, SVNS and rough neutrosophic set (RNS). Section 3 describes projection and bidirectional projection measures of rough neutrosophic sets. Section 4 presents projection and bidirectional projection based decision making methods for MCDM problems with rough neutrosophic information. Section 5 solves a numerical example. Finally, section 6 presents the conclusion and future scope of research.

2. PRELIMINARIES

In this Section, we provide some basic definitions regarding SVNSs, RNSs which are useful for developing the paper.

2.1 Neutrosophic set

Smarandache (1998) offered the following definition of neutrosophic set.

Definition 2.1.1. Let X be a space of points (objects) with generic element in X denoted by x . A neutrosophic set A in X is characterized by a truth-membership function T_A , an indeterminacy membership function I_A and a falsity membership function F_A . The functions T_A , I_A and F_A are real standard or non-standard subsets of $]^{-}0, 1^{+}[$ [that is $T_A: X \rightarrow]^{-}0, 1^{+}[$, $I_A: X \rightarrow]^{-}0, 1^{+}[$ and $F_A: X \rightarrow]^{-}0, 1^{+}[$. It should be noted that there is no restriction on the sum of $T_A(x)$, $I_A(x)$ and $F_A(x)$ i.e. $0^{-} \leq T_A(x) + I_A(x) + F_A(x) \leq 3^{+}$.

Definition 2.1.2: (complement) The complement of a neutrosophic set A is denoted by $c(A)$ and is defined by $T_{c(A)}(x) = \{1^{+}\} - T_A(x)$, $I_{c(A)}(x) = \{1^{+}\} - I_A(x)$, $F_{c(A)}(x) = \{1^{+}\} - F_A(x)$.

Definition 2.1.3: (Containment) A neutrosophic set A is contained in the other neutrosophic set B, denoted by $A \subseteq B$ iff

$$\inf T_A(x) \leq \inf T_B(x), \sup T_A(x) \leq \sup T_B(x), \inf I_A(x) \geq \inf I_B(x), \sup I_A(x) \geq \sup I_B(x)$$

and $\inf F_A(x) \geq \inf F_B(x), \sup F_A(x) \geq \sup F_B(x) \forall x \in X$

Definition 2.1.4: (Single-valued neutrosophic set). Let X be a universal space of points (objects) with a generic element of X denoted by x. A single valued neutrosophic set A is characterized by a truth membership function $T_A(x)$, a falsity membership function $F_A(x)$ and indeterminacy function $I_A(x)$ with

$$T_A(x), I_A(x) \text{ and } F_A(x) \in [0,1] \forall x \text{ in } X.$$

When X is continuous, a SNVS S can be written as follows:

$$A = \int_x \langle T_A(x), F_A(x), I_A(x) \rangle / x \forall x \in X$$

and when X is discrete, a SVNS S can be written as follows:

$$A = \sum \langle T_A(x), F_A(x), I_A(x) \rangle / x \forall x \in X$$

For a SVNS S, $0 \leq \sup T_A(x) + \sup I_A(x) + \sup F_A(x) \leq 3$.

Definition 2.1.5: The complement of a single valued neutrosophic set A is denoted by $c(A)$ and is defined by $T_{c(A)}(x) = F_A(x)$, $I_{c(A)}(x) = 1 - I_A(x)$, $F_{c(A)}(x) = T_A(x)$.

Definition 2.1.6: A SVNS A is contained in the other SVNS B, denoted as $A \subseteq B$ iff,

$$T_A(x) \leq T_B(x), I_A(x) \geq I_B(x) \text{ and } F_A(x) \geq F_B(x), \forall x \in X.$$

2.2 Rough neutrosophic set (Broumi et al., 2014a, 2014b)

Broumi et al., (2014a, 2014b) defined hybrid intelligent structure called Rough neutrosophic set.

Definition 2.2.1: Let Y be a non-null set and R be an equivalence relation on Y. Let P be a neutrosophic set in Y with the membership function T_P , indeterminacy membership function I_P and falsity membership function F_P . The lower and the upper approximations of P in the approximation space (Y, R) denoted by $\underline{N(P)}$ and $\overline{N(P)}$ are respectively defined as:

$$\underline{N(P)} = \left\langle x, T_{\underline{N(P)}}(x), I_{\underline{N(P)}}(x), F_{\underline{N(P)}}(x) \right\rangle / y \in [x]_R, x \in Y$$

and

$$\overline{N(P)} = \left\langle x, T_{\overline{N(P)}}(x), I_{\overline{N(P)}}(x), F_{\overline{N(P)}}(x) \right\rangle / y \in [x]_R, x \in Y$$

where,

$$T_{\underline{N(P)}}(x) = \wedge z \in [x]_R T_P(Y), I_{\underline{N(P)}}(x) = \wedge z \in [x]_R I_P(Y), F_{\underline{N(P)}}(x) = \wedge z \in [x]_R F_P(Y) \text{ and}$$

$$T_{\overline{N(P)}}(x) = \vee z \in [x]_R T_P(Y), I_{\overline{N(P)}}(x) = \vee z \in [x]_R I_P(Y), F_{\overline{N(P)}}(x) = \vee z \in [x]_R F_P(Y).$$

So,

$$0 \leq T_{\underline{N(P)}}(x) + I_{\underline{N(P)}}(x) + F_{\underline{N(P)}}(x) \leq 3$$

and

$$0 \leq T_{\overline{N(P)}}(x) + I_{\overline{N(P)}}(x) + F_{\overline{N(P)}}(x) \leq 3.$$

Here \vee and \wedge denote “max” and “min” operators respectively. $T_P(y)$, $I_P(y)$ and $F_P(y)$ are the membership, indeterminacy and non-membership of Y with respect to P .

Thus NS mappings \underline{N} , $\overline{N}: N(Y) \rightarrow N(Y)$ are, respectively, referred to as the lower and upper rough NS approximation operators, and the pair $(\underline{N}(P), \overline{N}(P))$ is called the rough neutrosophic set in (Y, R) .

Definition 2.2.2 If $N(P) = (\underline{N}(P), \overline{N}(P))$ is a rough neutrosophic set in (Y, R) , the rough complement of $N(P)$ is the rough neutrosophic set denoted by $\sim(N(P))$ and defined as: $\sim(N(P)) = ((\underline{N}(P))^c, (\overline{N}(P))^c)$, where $(\underline{N}(P))^c$ and $(\overline{N}(P))^c$ are the complements of neutrosophic sets $\underline{N}(P)$ and $\overline{N}(P)$ respectively.

3. PROJECTION AND BIDIRECTIONAL PROJECTION MEASURE OF ROUGH NEUTROSOPHIC SETS

Existing projection and bidirectional projection measure are not capable of dealing with MCDM problems in rough neutrosophic environment. Therefore, new projection and bidirectional projection measures between RNSs are proposed.

Assume that M and N are two RNSs represented by

$$M = \{ \langle (\underline{T}_M(x_i), \underline{I}_M(x_i), \underline{F}_M(x_i)), (\overline{T}_M(x_i), \overline{I}_M(x_i), \overline{F}_M(x_i))) \rangle : i = 1, 2, \dots, n \}$$

and

$$N = \{ \langle (\underline{T}_N(x_i), \underline{I}_N(x_i), \underline{F}_N(x_i)), (\overline{T}_N(x_i), \overline{I}_N(x_i), \overline{F}_N(x_i))) \rangle : i = 1, 2, \dots, n \}.$$

Then, the inner product of M and N denoted by $M.N$ can be defined as:

$$M.N = \sum_{i=1}^n [\underline{T}_1(x_i) \cdot \underline{T}_2(x_i) + \underline{I}_1(x_i) \cdot \underline{I}_2(x_i) + \underline{F}_1(x_i) \cdot \underline{F}_2(x_i) + \overline{T}_1(x_i) \cdot \overline{T}_2(x_i) + \overline{I}_1(x_i) \cdot \overline{I}_2(x_i) + \overline{F}_1(x_i) \cdot \overline{F}_2(x_i)].$$

The modulus of M can be defined as

$$\|M\| = \sqrt{\sum_{i=1}^n [\underline{T}_1(x_i)^2 + \underline{I}_1(x_i)^2 + \underline{F}_1(x_i)^2 + \overline{T}_1(x_i)^2 + \overline{I}_1(x_i)^2 + \overline{F}_1(x_i)^2]}$$

and the modulus of N can be defined as

$$\|N\| = \sqrt{\sum_{i=1}^n [\underline{T}_2(x_i)^2 + \underline{I}_2(x_i)^2 + \underline{F}_2(x_i)^2 + \overline{T}_2(x_i)^2 + \overline{I}_2(x_i)^2 + \overline{F}_2(x_i)^2]}.$$

Definition 4.1. The projection of M on N can be defined as:

$$\text{Pr oj}(M)_N = \frac{1}{\|N\|} M.N.$$

Definition 4.2. The bidirectional projection measure between the RNSs M and N is defined as:

$$\text{B Pr oj}(M, N) = \frac{1}{1 + \left| \frac{\|M\| - \|N\|}{\|M.N\|} \right|} = \frac{\|M\| \|N\|}{\|M\| \|N\| + \left| \frac{\|M\| - \|N\|}{\|M.N\|} \right|}.$$

Here also the bidirectional projection measure satisfies the following properties:

- (1) $\text{BProj}(M, N) = \text{BProj}(N, M)$;
- (2) $0 \leq \text{BProj}(M, N) \leq 1$;
- (3) $\text{BProj}(M, N) = 1$, if $M = N$.

Proof:

$$(i) \text{B Pr oj}(M, N) = \frac{1}{1 + \left| \frac{\|M\| - \|N\|}{\|M.N\|} \right|} = \frac{1}{1 + \left| \frac{\|N\| - \|M\|}{\|N.M\|} \right|} = \text{B Pr oj}(N, M)$$

(ii) As $\frac{1}{1 + \left| \|M\| - \|N\| \right| \|M.N\|} \geq 0$ and $\frac{1}{1 + \left| \|M\| - \|N\| \right| \|M.N\|} \leq 1$ so, $0 \leq BProj(M, N) \leq 1$

(iii) If $M = N$ then $BProj(M, N) = BProj(M, M) = \frac{1}{1 + \left| \|M\| - \|M\| \right| \|M.M\|} = 1$

4. PROJECTION AND BIDIRECTIONAL PROJECTION BASED DECISION MAKING METHODS FOR MCDM PROBLEMS WITH ROUGH NEUTROSOPHIC INFORMATION

In this section, we develop projection and bidirectional projection based MCDM models to solve MCDM problems with rough neutrosophic information. Consider $E = \{E_1, \dots, E_n\}$ be a set of alternatives and $A = \{A_1, \dots, A_m\}$ be a set of attributes. Now we present two algorithms for MCDM problems involving rough neutrosophic information.

4.1 PROJECTION BASED DECISION MAKING METHODS FOR MCDM PROBLEMS WITH ROUGH NEUTROSOPHIC INFORMATION

Algorithm 1.

Step 1. The value of alternative $E_i (i = 1, 2, \dots, n)$ for the attribute $A_j (j = 1, 2, \dots, m)$ is evaluated by the decision maker in terms of RNSs and the rough neutrosophic decision matrix is constructed as:

$$Z = \langle Z_{ij} \rangle_{n \times m} = \begin{bmatrix} Z_{11} & Z_{12} & \dots & Z_{1m} \\ Z_{21} & Z_{22} & \dots & Z_{2m} \\ \dots & \dots & \dots & \dots \\ \dots & \dots & \dots & \dots \\ \dots & \dots & \dots & \dots \\ Z_{n1} & Z_{n2} & \dots & Z_{nm} \end{bmatrix} \text{ where } Z_{ij} = \langle (\underline{T}_{ij}, \underline{I}_{ij}, \underline{F}_{ij}), (\overline{T}_{ij}, \overline{I}_{ij}, \overline{F}_{ij}) \rangle \text{ with}$$

$$0 \leq \underline{T}_{ij} + \underline{I}_{ij} + \underline{F}_{ij} \leq 3 \text{ and } 0 \leq \overline{T}_{ij}, \overline{I}_{ij}, \overline{F}_{ij} \leq 3.$$

Step 2. Determine the ideal solution $S^* = \{S_1, S_2, \dots, S_m\}$.

If A_i is benefit type attribute then $S_i = \{(\min_j \underline{T}_{ji}, \max_j \underline{I}_{ji}, \max_j \underline{F}_{ji}), (\max_j \overline{T}_{ji}, \min_j \overline{I}_{ji}, \min_j \overline{F}_{ji})\}$.

If A_i is cost type attribute then $S_i = \{(\max_j \underline{T}_{ji}, \min_j \underline{I}_{ji}, \min_j \underline{F}_{ji}), (\min_j \overline{T}_{ji}, \max_j \overline{I}_{ji}, \max_j \overline{F}_{ji})\}$.

Step 3. Compute the projection measure between S^* and $Z_i = \langle Z_{ij} \rangle_{n \times m}$ for all $i = 1, \dots, n$ and $j = 1, \dots, m$. According to the descending order of projection measure $Proj(Z_i)_{S^*}$ for $i = 1, \dots, n$ alternatives are ranked and highest value of $Proj(Z_i)_{S^*}$ reflects the best option.

4.2. BIDIRECTIONAL PROJECTION BASED DECISION MAKING METHODS FOR MCDM PROBLEMS WITH ROUGH NEUTROSOPHIC INFORMATION

Algorithm 2.

Step 1. The value of alternative $E_i (i = 1, 2, \dots, n)$ for the attribute $A_j (j = 1, 2, \dots, m)$ is evaluated by the decision maker in terms of RNSs and the rough neutrosophic decision matrix is constructed as:

$$Z = \langle Z_{ij} \rangle_{n \times m} = \begin{bmatrix} Z_{11} & Z_{12} & \dots & Z_{1m} \\ Z_{21} & Z_{22} & \dots & Z_{2m} \\ \dots & \dots & \dots & \dots \\ \dots & \dots & \dots & \dots \\ Z_{n1} & Z_{n2} & \dots & Z_{nm} \end{bmatrix} \text{ where } Z_{ij} = \langle (\underline{T}_{ij}, \underline{I}_{ij}, \underline{F}_{ij}), (\overline{T}_{ij}, \overline{I}_{ij}, \overline{F}_{ij}) \rangle \text{ with}$$

$$0 \leq \underline{T}_{ij} + \underline{I}_{ij} + \underline{F}_{ij} \leq 3 \text{ and } 0 \leq \overline{T}_{ij}, \overline{I}_{ij}, \overline{F}_{ij} \leq 3.$$

Step 2. Determine the ideal solution $S^* = \{S_1, S_2, \dots, S_m\}$.

If A_i is benefit type attribute then $S_i = \{(\min_j \underline{T}_{ji}, \max_j \underline{I}_{ji}, \max_j \underline{F}_{ji}), (\max_j \overline{T}_{ji}, \min_j \overline{I}_{ji}, \min_j \overline{F}_{ji})\}$.

If A_i is cost type attribute then $S_i = \{(\max_j \underline{T}_{ji}, \min_j \underline{I}_{ji}, \min_j \underline{F}_{ji}), (\min_j \overline{T}_{ji}, \max_j \overline{I}_{ji}, \max_j \overline{F}_{ji})\}$.

Step 3. Compute the bidirectional projection measure between S^* and $Z_i = \langle Z_{ij} \rangle_{n \times m}$ for all $i = 1, \dots, n$ and $j = 1, 2, \dots, m$. According to the descending order of bidirectional projection measure $BProj(Z_i, S^*)$ for $i = 1, 2, \dots, n$ alternatives are ranked and highest value of $BProj(Z_i, S^*)$ reflects the best option.

Section 5. NUMERICAL EXAMPLES

Example 1: Assume that a decision maker intends to select the most suitable smartphone from the three initially chosen smartphones (S_1, S_2, S_3) by considering four attributes namely: feature A_1 , price A_2 , customer care A_3 , and risk factor A_4 .

Step1: The decision maker forms the following decision matrix:

	A_1	A_2	A_3	A_4
S_1	$\langle (.6, .3, .3), (.8, .1, .1) \rangle$	$\langle (.6, .4, .4), (.8, .2, .2) \rangle$	$\langle (.6, .4, .4), (.8, .2, .2) \rangle$	$\langle (.7, .4, .4), (.9, .2, .2) \rangle$
S_2	$\langle (.7, .3, .3), (.9, .1, .3) \rangle$	$\langle (.6, .3, .3), (.8, .3, .3) \rangle$	$\langle (.6, .2, .2), (.8, .4, .2) \rangle$	$\langle (.7, .3, .3), (.9, .3, .3) \rangle$
S_3	$\langle (.6, .2, .2), (.8, .0, .2) \rangle$	$\langle (.7, .3, .3), (.9, .1, .1) \rangle$	$\langle (.7, .4, .6), (.9, .2, .4) \rangle$	$\langle (.6, .3, .2), (.8, .1, .2) \rangle$

Step2: Here A_2 and A_4 are the cost type attributes.

So, the ideal solution is:

$S^* = [\langle (.6, .3, .3), (.9, .0, .1) \rangle, \langle (.7, .3, .3), (.8, .3, .3) \rangle, \langle (.6, .4, .6), (.9, .2, .2) \rangle, \langle (.7, .3, .2), (.8, .3, .3) \rangle]$.

Step3: Determination of the projection and bidirectional projection measure:

$$\|S^*\| = 6.06, \|S_1\| = 2.387467, \|S_2\| = 2.424871, \|S_3\| = 2.412468$$

$$S_1.S^* = 5.78, S_2.S^* = 5.80, S_3.S^* = 5.82.$$

$$\text{Pr oj}(S_1)_{S^*} = 0.953795, \text{Pr oj}(S_2)_{S^*} = 0.957095, \text{Pr oj}(S_3)_{S^*} = 0.960396.$$

$$\Rightarrow \text{Pr oj}(S_3)_{S^*} > \text{Pr oj}(S_2)_{S^*} > \text{Pr oj}(S_1)_{S^*}$$

$$\Rightarrow S_3 > S_2 > S_1.$$

$$\text{BPr oj}(S_1, S^*) = 0.405320, \text{BPr oj}(S_2, S^*) = 0.410714, \text{BPr oj}(S_3, S^*) = 0.407818.$$

$$\Rightarrow \text{BPr oj}(S_2, S^*) > \text{BPr oj}(S_3, S^*) > \text{BPr oj}(S_1, S^*)$$

$$\Rightarrow S_2 > S_3 > S_1.$$

Here S_3 is the best alternative according to projection measure and S_2 is the best alternative according to bidirectional projection measure. As bidirectional projection measure is better than projection measure so the decision maker selects the smartphone S_2 .

Example 2: Assume that a decision maker intends to select the most suitable location of modern logistic centre from the three initially chosen locations (K_1, K_2, K_3) by considering six attributes namely: cost L_1 , distance to suppliers L_2 , distance to customers L_3 , conformance to government and law L_4 , quality of service L_5 , environmental impact L_6 .

Step1: The decision maker forms the following decision matrix:

	L_1	L_2	L_3	L_4	L_5	L_6
K_1	$\langle (.85,.05, .05), (.95,.15,.15) \rangle$	$\langle (.75,.15, .10), (.85,.25,.20) \rangle$	$\langle (.75,.15, 5,.10), (.85,.25, .20) \rangle$	$\langle (.75,.15, 5,.10), (.85,.25, .20) \rangle$	$\langle (.75,.15,.10), (.85,.25,.20) \rangle$	$\langle (.85,.05,.05), (.95,.15,.15) \rangle$
K_2	$\langle (.45,.45, .35), (.55,.55,.55) \rangle$	$\langle (.75,.15, .10), (.85,.25,.20) \rangle$	$\langle (.45,.45, 5,.35), (.55,.55, .55) \rangle$	$\langle (.75,.15, 5,.10), (.85,.25, .20) \rangle$	$\langle (.75,.15,.10), (.85,.25,.20) \rangle$	$\langle (.45,.45,.35), (.55,.55,.55) \rangle$
K_3	$\langle (.45,.45, .35), (.55,.55,.55) \rangle$	$\langle (.85,.05, .05), (.95,.15,.15) \rangle$	$\langle (.75,.15, 5,.10), (.85,.25, .20) \rangle$	$\langle (.75,.15, 5,.10), (.85,.25, .20) \rangle$	$\langle (.85,.05,.05), (.95,.15,.15) \rangle$	$\langle (.45,.45,.35), (.55,.55,.55) \rangle$

Step2: Here L_1, L_2, L_3 are cost type attributes

So, the ideal solution is:

$$S^* = [\langle (.85,.05,.05), (.55,.55,.55) \rangle, \langle (.85,.05,.05), (.85,.25,.20) \rangle, \langle (.75,.15,.10), (.55,.55,.55) \rangle, \langle (.55,.30,.25), (.85,.25,.20) \rangle, \langle (.75,.15,.10), (.95,.15,.15) \rangle, \langle (.45,.45,.35), (.95,.15,.15) \rangle].$$

Step3: Determination of the projection and bidirectional projection measure:

$$\|S^*\| = 2.997916$$

$$\|K_1\| = 3.004995, \|K_2\| = 2.926602, \|K_3\| = 2.966479$$

$$K_1.S^* = 8.3475, K_2.S^* = 8.1450, K_3.S^* = 8.2325.$$

$$\text{Pr oj}(K_1)_{S^*} = 2.784434, \text{Pr oj}(K_2)_{S^*} = 2.716897, \text{Pr oj}(K_3)_{S^*} = 2.746074.$$

$$\Rightarrow \text{Pr oj}(K_1)_{S^*} > \text{Pr oj}(K_3)_{S^*} > \text{Pr oj}(K_2)_{S^*}$$

$$\Rightarrow K_1 > K_3 > K_2.$$

$$\text{BPr oj}(K_1, S^*) = 0.993481, \text{BPr oj}(K_2, S^*) = 0.937908, \text{BPr oj}(K_3, S^*) = 0.971721.$$

$$\Rightarrow \text{BPr oj}(K_1, S^*) > \text{BPr oj}(K_3, S^*) > \text{BPr oj}(K_2, S^*)$$

$$\Rightarrow K_1 > K_3 > K_2.$$

Hence, K_1 is the best alternative.

6. CONCLUSION

This paper defines projection measure and bidirectional projection measure between rough neutrosophic sets. Two new multi criteria decision making methods have been proposed based on the proposed neutrosophic projection and bidirectional projection measures respectively. Finally, two numerical examples are provided to demonstrate the applicability and effectiveness of the proposed methods. The proposed methods can be extended for solving multi criteria decision making in interval neutrosophic rough environments.

REFERENCES

- Abdel-Baset, M., Hezam, I. M., & Smarandache. F. (2016). Neutrosophic goal programming. *Neutrosophic Sets and Systems*, 11, 112-118.
- Atanassov, K. (1983). Intuitionistic fuzzy sets. in: *Proceedings of the VII ITKR's Session*, Sofia (Deposited in Central Sci.-Techn. Library of Bulgaria Academy of Science), 1677-1684.
- Atanassov, K. (1986). Intuitionistic fuzzy sets. *Fuzzy Sets and Systems*, 20, 87-96.
- Biswas, P., Pramanik, S., & Giri, B. C. (2014a). Entropy based grey relational analysis method for multi-attribute decision making under single valued neutrosophic assessments. *Neutrosophic Sets and Systems*, 2, 102-110.
- Biswas, P., Pramanik, S., & Giri, B. C. (2014b). A new methodology for neutrosophic multi-attribute decision making with unknown weight information. *Neutrosophic Sets and Systems*, 3, 42-52.
- Biswas, P., Pramanik, S., & Giri, B. C. (2015a). Cosine similarity measure based multi-attribute decision-making with trapezoidal fuzzy neutrosophic numbers. *Neutrosophic Sets and Systems*, 8, 47-57.
- Biswas, P., Pramanik, S., & Giri, B. C. (2015b). TOPSIS method for multi-attribute group decision-making under single valued neutrosophic environment. *Neural Computing and Applications*, 27(3), 727-737. doi: 10.1007/s00521-015-1891-2.
- Biswas, P., Pramanik, S., & Giri, B. C. (2016a). Aggregation of triangular fuzzy neutrosophic set information and its application to multi-attribute decision making. *Neutrosophic Sets and Systems*, 12, 20-40.
- Biswas, P., Pramanik, S., & Giri, B. C. (2016b). Value and ambiguity index based ranking method of single-valued trapezoidal neutrosophic numbers and its application to multi-attribute decision making. *Neutrosophic Sets and Systems*, 12, 127-138.
- Biswas, P., Pramanik, S., & Giri, B. C. (2017a). Multi-attribute group decision making based on expected value of neutrosophic trapezoidal numbers. In F. Smarandache, & S. Pramanik (Eds), *New Trends in Neutrosophic Theory and Applications, Vol. II*. Brussels:Pons Editions. In Press.

- Biswas, P., Pramanik, S., & Giri, B., C. (2017b). Non-linear programming approach for single-valued neutrosophic TOPSIS method, *New Mathematics and Natural Computation*, In Press.
- Broumi, S., & Smarandache, F. (2013). Several similarity measures of neutrosophic sets. *Neutrosophic Sets and Systems*, 1, 54–62.
- Broumi, S., Smarandache, F., & Dhar, M. (2014a). Rough neutrosophic sets. *Italian Journal of Pure and Applied Mathematics*, 32, 493–502.
- Broumi, S., Smarandache, F., & Dhar, M. (2014b). Rough neutrosophic sets. *Neutrosophic Sets and Systems*, 3, 60–66.
- Cantor, G. (1874). Ueber eine Eigenschaft des Inbegriffes aller reellen algebraischen Zahlen. *Journal für die reine und angewandte Mathematik*, 77, 258–262. doi:10.1515/crll.1874.77.258.
- Chen, J., & Ye, J. (2016). A projection model of neutrosophic numbers for multiple attribute decision making of clay-brick selection. *Neutrosophic Sets and Systems*, 12, 139–142.
- Cheng, H.D.; Guo, Y. (2008). A new neutrosophic approach to image thresholding. *New Mathematics and Natural Computation*, 4, 291–308.
- Das, P., & Roy, T., K. (2015). Multi-objective non-linear programming problem based on neutrosophic optimization technique and its application in riser design problem. *Neutrosophic Sets and Systems*, 9, 88–95.
- Dey, P. P., Pramanik, S., & Giri, B. C. (2016a). Neutrosophic soft multi-attribute decision making based on grey relational projection method. *Neutrosophic Sets and Systems*, 11, 98–106.
- Dey, P. P., Pramanik, S., & Giri, B. C. (2016b). Extended projection based models for solving multiple attribute decision making problems with interval valued neutrosophic information. In F. Smarandache, & S. Pramanik (Eds), *New Trends in Neutrosophic Theory and Applications* (pp. 127–140). Brussels: Pons Editions.
- Guo, Y., Cheng, H.D. (2009). New neutrosophic approach to image segmentation. *Pattern Recognition*, 42, 587–595.
- Guo, Y., Sengur, A., Ye, J. (2014). A novel image thresholding algorithm based on neutrosophic similarity score. *Measurement*, 58, 175–186.
- Hezam, I. M., Abdel-Baset, M., & Smarandache, F. (2015). Taylor series approximation to solve neutrosophic multiobjective programming problem. *Neutrosophic Sets and Systems*, 10, 39–45.
- Kharal, A. (2014). A neutrosophic multi-criteria decision making method. *New Mathematics and Natural Computing*, 10, 143–162. doi: 10.1142/S1793005714500070.
- Klaua, D. (1965). Über einen Ansatz zur mehrwertigen Mengenlehre. *Monatsber. Deut. Akad. Wiss. Berlin*, 7, 859–876.
- Liu, P., Chu, Y., Li, Y., & Chen, Y. (2014). Some generalized neutrosophic number Hamacher aggregation operators and their application to group decision making, *International Journal of Fuzzy Systems*, 16(2)242–255.
- Liu, P. D. & Li, H. G. (2017). Multiple attribute decision-making method based on some normal neutrosophic Bonferroni mean operators. *Neural Computing and Applications*, 28, 179–194.
- Liu, P., & Wang, Y. (2014). Multiple attribute decision-making method based on single-valued neutrosophic normalized weighted Bonferroni mean. *Neural Computing and Applications*, 25(7)2001–2010.
- Mondal, K., & Pramanik, S. (2014a). A study on problems of Hijras in West Bengal based on neutrosophic cognitive maps. *Neutrosophic Sets and Systems*, 5, 21–26.
- Mondal, K., & Pramanik, S., (2014b). Multi-criteria group decision making approach for teacher recruitment in higher education under simplified Neutrosophic environment. *Neutrosophic Sets and Systems*, 6, 28–34.
- Mondal, K., & Pramanik, S., (2015a). Neutrosophic decision making model of school choice. *Neutrosophic Sets and Systems*, 7, 62–68.
- Mondal, K., & Pramanik, S., (2015b). Rough neutrosophic multi-attribute decision-making based on grey relational analysis. *Neutrosophic Sets and Systems*, 7, 8–17.

- Mondal, K., & Pramanik, S., (2015c). Rough neutrosophic multi-attribute decision-making based on rough accuracy score function. *Neutrosophic Sets and Systems*, 8, 14-21.
- Mondal, K., & Pramanik, S., (2015d). Neutrosophic tangent similarity measure and its application to multiple attribute decision making. *Neutrosophic Sets and Systems*, 9, 80-87.
- Mondal, K., & Pramanik, S., (2015e). Neutrosophic refined similarity measure based on tangent function and its application to multi attribute decision making. *Journal of New Theory*, 8, 41-50.
- Mondal, K., Pramanik, S., (2015f). Decision making based on some similarity measures under interval rough neutrosophic environment. *Neutrosophic Sets and Systems*, 10, 46-57.
- Mondal, K., Pramanik, S., (2015g). Tri-complex rough neutrosophic similarity measure and its application in multi-attribute decision making. *Critical Review*, 11, 26-40.
- Mondal, K., Pramanik, S., & Smarandache, F. (2016a). Several trigonometric Hamming similarity measures of rough neutrosophic sets and their applications in decision making. In F. Smarandache, & S. Pramanik (Eds), *New Trends in Neutrosophic Theory and Application* (pp 93-103). Brussels, Belgium: Pons Editions.
- Mondal, K., Pramanik, S., & Smarandache, F. (2016b). Multi-attribute decision making based on rough neutrosophic variational coefficient similarity measure. *Neutrosophic Sets and Systems*, 13, 3-17.
- Mondal, K., Pramanik, S., & Smarandache, F. (2016c). Rough neutrosophic TOPSIS for multi-attribute group decision making. *Neutrosophic Sets and Systems*, 13, 105-117.
- Mondal, K., Pramanik, S., & Smarandache, F. (2016d). Rough neutrosophic hyper-complex set and its application to multi-attribute decision making. *Critical Review*, 13, 111-126.
- Pawlak, Z. (1982). Rough sets. *International Journal of Information and Computer Sciences*, 11(5), 341-356.
- Peng, J., J., Wang, J., Q., Wang, J., Zhang, H., Y., & Chen, X. H. (2016). Simplified neutrosophic sets and their applications in multi-criteria group decision-making problems. *International Journal of Systems Science*, 47 (10), 2342-2358.
- Pramanik, S. (2016a). Neutrosophic linear goal programming. *Global Journal of Engineering Science and Research Management*, 3(7), 01-11.
- Pramanik, S. (2016b). Neutrosophic multi-objective linear programming. *Global Journal of Engineering Science and Research Management*, 3(8), 36-46.
- Pramanik, S., Banerjee, D., & Giri, B. C. (2016). Multi – criteria group decision making model in neutrosophic refined set and its application. *Global Journal of Engineering Science and Research Management*, 3(6), 12-18.
- Pramanik, S., Biswas, P., & Giri, B. C. (2015). Hybrid vector similarity measures and their applications to multi-attribute decision making under neutrosophic environment. *Neural Computing and Applications*, doi:10.1007/s00521015-2125-3.
- Pramanik, S., & Chakrabarti, S. (2013). A study on problems of construction workers in West Bengal based on neutrosophic cognitive maps. *International Journal of Innovative Research in Science, Engineering and Technology*, 2(11), 6387-6394.
- Pramanik, S., Dalapati, S., & Roy, T. K. (2016). *Logistics center location selection approach based on neutrosophic multi-criteria decision making*. In F. Smarandache, & S. Pramanik (Eds), *New Trends in Neutrosophic Theories and Applications*, (pp 161-174). Brussels, Belgium: Pons Editions.
- Pramanik, S., Dey, P. P., Giri, B.C. & Smarandache, F. (2017). Bipolar neutrosophic projection based models for multi-attribute decision making problems. *Neutrosophic Sets and Systems*, 15, 74-83.
- Pramanik, S., & Mondal, K. (2015a). Cosine similarity measure of rough neutrosophic sets and its application in medical diagnosis. *Global Journal of Advanced Research*, 2(1), 212-220.
- Pramanik, S., & Mondal, K. (2015b). Some rough neutrosophic similarity measure and their application to multi attribute decision making. *Global Journal of Engineering Science and Research Management*, 2(7) (2015) 61-74.
- Pramanik, S., & Mondal, K. (2015c). Cotangent similarity measure of rough neutrosophic sets and its application to medical diagnosis. *Journal of New Theory*, 4, 90-102.

- Pramanik, S., & Mondal, K. (2015d). Interval neutrosophic multi-attribute decision-making based on grey relational analysis. *Neutrosophic Sets and Systems*, 9, 13-22.
- Pramanik, S., & Roy, T. K. (2014). Neutrosophic game theoretic approach to Indo-Pak conflict over Jammu-Kashmir. *Neutrosophic Sets and Systems*, 2, 82-101.
- Sahin, R., & Liu, P. (2015). Maximizing deviation method for neutrosophic multiple attribute decision making with incomplete weight information. *Neural Computing and Applications*. doi: 10.1007/s00521-015-1995-8.
- Sarkar, M., Dey, S., & Roy, T. K. (2016). Truss design optimization using neutrosophic optimization technique., *Neutrosophic Sets and Systems*, 13, 62-69.
- Smarandache, F. (1998). *A unifying field in logics: neutrosophic logic. Neutrosophy, neutrosophic set, neutrosophic probability, and neutrosophic statistics*. Rehoboth: American Research Press.
- Smarandache, F. (1999). Linguistic paradoxes and tautologies, *Libertas Mathematica, University of Texas at Arlington*, IX, 143-154.
- Smarandache, F., (2002). A unifying field in logics: neutrosophic logics. *Multiple valued logic*, 8(3), 385-438.
- Smarandache, F. (2005). Neutrosophic set – a generalization of intuitionistic fuzzy sets. *International Journal of Pure and Applied Mathematics*, 24(3), 287-297.
- Smarandache, F. (2010). Neutrosophic set – a generalization of intuitionistic fuzzy set. *Journal of Defense Resources Management*, 1(1), 107-116.
- Sodenkamp, M. (2013). *Models, methods and applications of group multiple-criteria decision analysis in complex and uncertain systems*. Dissertation, University of Paderborn, Germany.
- Wang, H. Smarandache, F. Zhang, Y. Q., & Sunderraman, R. (2010). Single valued neutrosophic sets. *Multispace and Multistructure*, 4, 410–413.
- Xu, Z. S., & Da, Q. L. (2004). Projection method for uncertain multi-attribute decision making with preference information on alternatives. *International Journal of Information Technology & Decision Making*, 3, 429-434.
- Xu, Z. (2005). On methods for uncertain multiple attribute group decision making with uncertain multiplicative preference information on alternatives. *Fuzzy Optimization and Decision Making*, 4, 131-139.
- Xu, Z., & Hu, H. (2010). Projection models for intuitionistic fuzzy multiple attribute decision making. *International Journal of Information Technology & Decision Making*, 9(2), 267-280.
- Yang, L., Xiao, S., & Yuan, S. (2014). Projection method for material selection problem with triangular fuzzy numbers. *Advanced Materials Research*, 1046, 375-379.
- Yang, H. L., Zhang, C. L., Guo, Z. L., Liu, Y. L., & Liao, X. (2016). A hybrid model of single valued neutrosophic sets and rough sets: single valued neutrosophic rough set model. *Soft Computing*, 1-15. doi:10.1007/s00500-016-2356-y.
- Ye, J. (2013a). Multicriteria decision-making method using the correlation coefficient under single-valued neutrosophic environment. *International Journal of General Systems*, 42, 386–394.
- Ye, J. (2013b). Single valued neutrosophic cross-entropy for multicriteria decision making problems. *Applied Mathematical Modelling*, 38 (3),1170–1175.
- Ye, J. (2014a). A multicriteria decision-making method using aggregation operators for simplified neutrosophic sets. *Journal of Intelligent and Fuzzy Systems*, 26, 2459–2466.
- Ye, J. (2014b). Vector similarity measures of simplified neutrosophic sets and their application in multicriteria decision making. *International Journal of Fuzzy Systems*, 16, 204–215.
- Ye, J. (2015a). Trapezoidal neutrosophic set and its application to multiple attribute decision-making. *Neural Computing and Applications*, 26,1157–1166.
- Ye, J. (2015b). Improved cosine similarity measures of simplified neutrosophic sets for medical diagnoses. *Artificial Intelligence in Medicine*, 63, 171–179.
- Ye, J. (2015c). Interval neutrosophic multiple attribute decision-making method with credibility information. *International Journal of Fuzzy Systems*. doi 10.1007/s40815-015-0122-4.
- Ye, J. (2015d). Bidirectional projection method for multiple attribute group decision making with neutrosophic number. *Neural Computing and Applications*. doi: 10.1007/s00521-015-2123-5.

- Abdel-Basset, M., Mohamed, M., Smarandache, F., & Chang, V. (2018). Neutrosophic Association Rule Mining Algorithm for Big Data Analysis. *Symmetry*, 10(4), 106.
- Abdel-Basset, M., & Mohamed, M. (2018). The Role of Single Valued Neutrosophic Sets and Rough Sets in Smart City: Imperfect and Incomplete Information Systems. *Measurement*. Volume 124, August 2018, Pages 47-55
- Abdel-Basset, M., Gunasekaran, M., Mohamed, M., & Smarandache, F. A novel method for solving the fully neutrosophic linear programming problems. *Neural Computing and Applications*, 1-11.
- Abdel-Basset, M., Manogaran, G., Gamal, A., & Smarandache, F. (2018). A hybrid approach of neutrosophic sets and DEMATEL method for developing supplier selection criteria. *Design Automation for Embedded Systems*, 1-22.
- Abdel-Basset, M., Mohamed, M., & Chang, V. (2018). NMCDA: A framework for evaluating cloud computing services. *Future Generation Computer Systems*, 86, 12-29.
- Abdel-Basset, M., Mohamed, M., Zhou, Y., & Hezam, I. (2017). Multi-criteria group decision making based on neutrosophic analytic hierarchy process. *Journal of Intelligent & Fuzzy Systems*, 33(6), 4055-4066.
- Abdel-Basset, M.; Mohamed, M.; Smarandache, F. An Extension of Neutrosophic AHP–SWOT Analysis for Strategic Planning and Decision-Making. *Symmetry* 2018, 10, 116.
- Ye, J. (2016). Projection and bidirectional projection measures of single valued neutrosophic sets and their decision – making method for mechanical design scheme. *Journal of Experimental & Theoretical Artificial Intelligence*. doi:10.1080/0952813X.2016.1259263.
- Ye, J. (2014a). Single valued neutrosophic minimum spanning tree and its clustering method. *Journal of Intelligent Systems*, 23, 311–324.
- Ye, J. (2014b). Clustering methods using distance-based similarity measures of single-valued neutrosophic sets. *Journal of Intelligent Systems*, 23, 379–389.
- Yue, C. (2017). Normalized projection approach to group decision-making with hybrid decision information. *International Journal of Machine Learning and Cybernetics*. doi:10.1007/s13042-017-0650-3.
- Yue, Z. L. (2012a). Application of the projection method to determine weights of decision makers for group decision making. *Scientia Iranica*, 19(3), 872-878.
- Yue, Z. L. (2012b). Approach to group decision making based on determining the weights of experts by using projection method. *Applied Mathematical Modelling*, 36(7), 2900-2910.
- Yue, Z. L. (2013). An intuitionistic fuzzy projection-based approach for partner selection. *Applied Mathematical Modelling*, 37, 9538-9551.
- Yue, Z., L., & Jia, Y. (2015). A direct projection-based group decision-making methodology with crisp values and interval data. *Soft Computing*. doi: 10.1007/s00500-015-1953-5
- Zadeh, L. A. (1965). Fuzzy sets. *Information and Control*, 8(3), 338-353.
- Zeng, S., Balezentis, T., Chen, J., & Luo, G. (2013). A projection method for multiple attribute group decision making with intuitionistic fuzzy information. *Informatica*, 24(3), 485-503.
- Zheng, G., Jing, Y., Huang, H., & Gao, Y. (2010). Application of improvement grey relational projection method to evaluate sustainable building envelope performance. *Applied Energy*, 87(2), 710-720.

Neutrosophic Graph Theory

Bipolar Complex Neutrosophic Graphs of Type 1

Said Broumi^{1,*}, Assia Bakali², Mohamed Talea³, Florentin Smarandache⁴, V. Venkateswara Rao⁵

^{1,3} Laboratory of Information Processing, Faculty of Science Ben M'Sik, University Hassan II, B.P 7955, Sidi Othman, Casablanca, Morocco. E-mail: broumisaid78@gmail.com, taleamohamed@yahoo.fr

²Ecole Royale Navale-Boulevard Sour Jdid, B.P 16303 Casablanca, Morocco. E-mail: assiabakali@yahoo.fr

⁴Department of Mathematics, University of New Mexico, 705 Gurley Avenue, Gallup, NM 87301, USA. E-mail: fsmarandache@gmail.com

⁵Department of S&H, VFSTR University, Vadlamudi - 522 207, Guntur, India
E-mail: vunnamvenky@gmail.com

ABSTRACT

In this paper, we introduced a new neutrosophic graphs called bipolar complex neutrosophic graphs of type 1 (BCNG1) and presented a matrix representation for it and studied some properties of this new concept. The concept of BCNG1 is an extension of generalized fuzzy graphs of type 1 (GFG1), generalized single valued neutrosophic graphs of type 1 (GSVNG1), Generalized bipolar neutrosophic graphs of type 1 (GBNG1) and complex neutrosophic graph of type 1 (CNG1).

KEYWORDS: Bipolar complex neutrosophic set; Bipolar complex neutrosophic graph of type 1; Matrix representation.

1. INTRODUCTION

In 1998, (Smarandache, 1998), introduced a new theory called Neutrosophy, which is basically a branch of philosophy that focus on the origin, nature, and scope of neutralities and their interactions with different ideational spectra. Based on the neutrosophy, Smarandache defined the concept of neutrosophic set which is characterized by a degree of truth membership T , a degree of indeterminate-membership I and a degree false-membership F . The concept of neutrosophic set theory is a generalization of the concept of classical sets, fuzzy sets (Zadeh, 1965), intuitionistic fuzzy sets (Atanassov, 1986), interval-valued fuzzy sets (Turksen, 1986). Neutrosophic sets is mathematical tool used to handle problems like imprecision, indeterminacy and inconsistency of data. Specially, the indeterminacy presented in the neutrosophic sets is independent on the truth and falsity values. To easily apply the neutrosophic sets to real scientific and engineering areas, (Smarandache, 1998) proposed the single valued neutrosophic sets as subclass of neutrosophic sets. Later on, (Wang et al., 2010) provided the set-theoretic operators and various properties of single valued neutrosophic sets. The concept of neutrosophic sets and their extensions such as bipolar neutrosophic sets, complex neutrosophic sets, bipolar complex neutrosophic sets (Broumi et al. 2017) and so on have been applied successfully in several fields (<http://fs.gallup.unm.edu/NSS/>).

Graphs are the most powerful tool used in representing information involving relationship between objects and concepts. In a crisp graphs two vertices are either related or not related to each other, mathematically, the degree of relationship is either 0 or 1. While in fuzzy graphs, the degree of relationship takes values from $[0, 1]$. In (Shannon and Atanassov, 1994) introduced the concept of intuitionistic fuzzy graphs (IFGs) using five types of Cartesian products. The concept fuzzy graphs and their extensions have a common property that each edge must have a membership value less than or equal to the minimum membership of the nodes it connects.

When description of the object or their relations or both is indeterminate and inconsistent, it cannot be handled by fuzzy graphs and their particular types (Sharma et al., 2013; Arindam et al., 2012, 2013). So, for this reason, (Smarandache, 2015) proposed the concept of neutrosophic graphs based on literal indeterminacy (I) to deal with such situations. Then, (Smarandache, 2015, 2015a) introduced another version of neutrosophic graph theory using the neutrosophic truth-values (T, I, F) and proposed three structures of neutrosophic graphs: neutrosophic edge graphs, neutrosophic vertex graphs and neutrosophic vertex-edge graphs. Later on (Smarandache, 2016) proposed new version of neutrosophic graphs such as neutrosophic offgraph, neutrosophic bipolar/tripolar/multipolar graph. Presently, works on neutrosophic vertex-edge graphs and neutrosophic edge graphs are progressing rapidly. (Broumi et al., 2016) combined the concept of single valued neutrosophic sets and graph theory, and introduced certain types of single valued neutrosophic graphs (SVNG) such as strong single valued neutrosophic graph, constant single valued neutrosophic graph, complete single valued neutrosophic graph and investigate some of their properties with proofs and examples. Also, (Broumi et al., 2016a) also introduced neighborhood degree of a vertex and closed neighborhood degree of vertex in single valued neutrosophic graph as a generalization of neighborhood degree of a vertex and closed neighborhood degree of vertex in fuzzy graph and intuitionistic fuzzy graph. In addition, (Broumi et al., 2016b) proved a necessary and sufficient condition for a single valued neutrosophic graph to be an isolated single valued neutrosophic graph. After Broumi, the studies on the single valued neutrosophic graph theory have been studied increasingly (Broumi et al., 2016c, 2016d, 2016e, 2016g, 2016h, 2016i; Samanta et al., 2016; Mehra, 2017; Ashraf et al., 2016; Fathi et al., 2016)

Recently, (Smarandache, 2017) initiated the idea of removal of the edge degree restriction of fuzzy graphs, intuitionistic fuzzy graphs and single valued neutrosophic graphs. (Samanta et al., 2016) introduced a new concept named the generalized fuzzy graphs (GFG) and defined two types of GFG, also the authors studied some major properties such as completeness and regularity with proved results. In this paper, the authors claim that fuzzy graphs and their extension defined by many researches are limited to represent for some systems such as social network. Later on (Broumi et al., 2017) have discussed the removal of the edge degree restriction of single valued neutrosophic graphs and defined a new class of single valued neutrosophic graph called generalized single valued neutrosophic graph of type 1, which is an extension of generalized fuzzy graph of type 1 (Samanta et al., 2016). Later on (Broumi et al., 2017a) introduced the concept of generalized bipolar neutrosophic of type 1. In addition, (Broumi et al., 2017b) combined the concept of complex neutrosophic sets with generalized single valued neutrosophic of type 1 (GSVNG1) and introduced the complex neutrosophic graph of type 1 (CNG1). Up to day, to our best knowledge, there is no research on bipolar complex neutrosophic graphs.

The main objective of this paper is to extend the concept of complex neutrosophic graph of type 1 (CNG1) introduced in (Broumi et al., 2017b) to bipolar complex neutrosophic graphs of type 1 and showed a matrix representation of BCNG1.

The remainder of this paper is organized as follows. In Section 2, we review some basic concepts about neutrosophic sets, single valued neutrosophic sets, complex neutrosophic sets, bipolar complex neutrosophic sets, generalized fuzzy graph, generalized single valued neutrosophic graphs of type 1, generalized bipolar neutrosophic graphs of type 1 and complex neutrosophic graph of type 1. In Section 3, the concept of complex neutrosophic graphs of type 1 is proposed with an illustrative example. In section 4 a representation matrix of complex neutrosophic graphs of type 1 is introduced. Finally, Section 5 outlines the conclusion of this paper and suggests several directions for future research.

2. PRELIMINARIES

In this section, we mainly recall some notions related to neutrosophic sets, single valued neutrosophic sets, complex neutrosophic sets, bipolar complex neutrosophic sets, generalized fuzzy graph, generalized single valued neutrosophic graphs of type 1, generalized bipolar neutrosophic graphs of type 1 and complex neutrosophic graph of type 1 relevant to the present work. See especially (Smarandache, 1998; Wang et al. 2010; Deli et al., 2015; Ali and Smarandache, 2015; Broumi et al., 2017, 2017b, 2017c; Samanta et al. 2016) for further details and background.

Definition 2.1 (Smarandache, 1998). Let X be a space of points and let $x \in X$. A neutrosophic set A in X is characterized by a truth membership function T , an indeterminacy membership function I , and a falsity membership function F . T, I, F are real standard or nonstandard subsets of $]^{-}0, 1^{+}[$, and $T, I, F: X \rightarrow]^{-}0, 1^{+}[$. The neutrosophic set can be represented as

$$A = \{(x, T_A(x), I_A(x), F_A(x)) : x \in X\} \quad (1)$$

There is no restriction on the sum of T, I, F , So

$$^{-}0 \leq T_A(x) + I_A(x) + F_A(x) \leq 3^{+}. \quad (2)$$

From philosophical point of view, the neutrosophic set takes the value from real standard or non-standard subsets of $]^{-}0, 1^{+}[$. Thus it is necessary to take the interval $[0, 1]$ instead of $]^{-}0, 1^{+}[$. For technical applications. It is difficult to apply $]^{-}0, 1^{+}[$ in the real life applications such as engineering and scientific problems.

Definition 2.2 (Wang et al. 2010). Let X be a space of points (objects) with generic elements in X denoted by x . A single valued neutrosophic set A (SVNS A) is characterized by truth-membership function $T_A(x)$, an indeterminate-membership function $I_A(x)$, and a false-membership function $F_A(x)$. For each point x in X , $T_A(x), I_A(x), F_A(x) \in [0, 1]$. A SVNS A can be written as

$$A = \{(x, T_A(x), I_A(x), F_A(x)) : x \in X\} \quad (3)$$

Definition 2.3 (Deli et al., 2015). A bipolar neutrosophic set A in X is defined as an object of the form

$A = \{ \langle x, (T_A^+(x), I_A^+(x), F_A^+(x), T_A^-(x), I_A^-(x), F_A^-(x)) \rangle : x \in X \}$, where $T_A^+, I_A^+, F_A^+ : X \rightarrow [1, 0]$ and $T_A^-, I_A^-, F_A^- : X \rightarrow [-1, 0]$. The positive membership degree $T_A^+(x), I_A^+(x), F_A^+(x)$ denotes the truth membership, indeterminate membership and false membership of an element $\in X$ corresponding to a bipolar neutrosophic set A and the negative membership degree $T_A^-(x), I_A^-(x), F_A^-(x)$ denotes the truth membership, indeterminate membership and false membership of an element $\in X$ to some implicit counter-property corresponding to a bipolar neutrosophic set A . For convenience a bipolar neutrosophic number is represented by

$$A = \langle (T_A^+, I_A^+, F_A^+, T_A^-, I_A^-, F_A^-) \rangle \quad (4)$$

Definition 2.4 (Ali and Smarandache, 2015)

A complex neutrosophic set A defined on a universe of discourse X , which is characterized by a truth membership function $T_A(x)$, an indeterminacy membership function $I_A(x)$, and a falsity membership function $F_A(x)$ that assigns a complex-valued grade of $T_A(x), I_A(x)$, and $F_A(x)$ in A for any $x \in X$. The values $T_A(x), I_A(x)$, and $F_A(x)$ and their sum may all within the unit circle in the complex plane and so is of the following form,

$$T_A(x) = p_A(x) \cdot e^{j\mu_A(x)},$$

$$I_A(x) = q_A(x) \cdot e^{j\nu_A(x)} \text{ and}$$

$$F_A(x) = r_A(x) \cdot e^{j\omega_A(x)}$$

Where, $p_A(x), q_A(x), r_A(x)$ and $\mu_A(x), \nu_A(x), \omega_A(x)$ are respectively, real valued and $p_A(x), q_A(x), r_A(x) \in [0, 1]$ such that

$$0 \leq p_A(x) + q_A(x) + r_A(x) \leq 3$$

The complex neutrosophic set A can be represented in set form as

$$A = \{(x, T_A(x) = a_T, I_A(x) = a_I, F_A(x) = a_F) : x \in X\}$$

where $T_A: X \rightarrow \{a_T: a_T \in \mathbb{C}, |a_T| \leq 1\}$,

$I_A: X \rightarrow \{a_I: a_I \in \mathbb{C}, |a_I| \leq 1\}$,

$F_A: X \rightarrow \{a_F: a_F \in \mathbb{C}, |a_F| \leq 1\}$ and

$$|T_A(x) + I_A(x) + F_A(x)| \leq 3.$$

Definition 2.5 (Ali and Smarandache, 2015) The union of two complex neutrosophic sets as follows:

Let A and B be two complex neutrosophic sets in X, where $A = \{(x, T_A(x), I_A(x), F_A(x)) : x \in X\}$ and

$$B = \{(x, T_B(x), I_B(x), F_B(x)) : x \in X\}.$$

Then, the union of A and B is denoted as $A \cup_N B$ and is given as

$$A \cup_N B = \{(x, T_{A \cup B}(x), I_{A \cup B}(x), F_{A \cup B}(x)) : x \in X\}$$

Where the truth membership function $T_{A \cup B}(x)$, the indeterminacy membership function $I_{A \cup B}(x)$ and the falsehood membership function $F_{A \cup B}(x)$ is defined by

$$T_{A \cup B}(x) = [(p_A(x) \vee p_B(x))] \cdot e^{j\mu_{T_{A \cup B}}(x)},$$

$$I_{A \cup B}(x) = [(q_A(x) \wedge q_B(x))] \cdot e^{j\nu_{I_{A \cup B}}(x)},$$

$$F_{A \cup B}(x) = [(r_A(x) \wedge r_B(x))] \cdot e^{j\omega_{F_{A \cup B}}(x)}$$

Where \vee and \wedge denotes the max and min operators respectively.

The phase term of complex truth membership function, complex indeterminacy membership function and complex falsity membership function belongs to $(0, 2\pi)$ and, they are defined as follows:

a) Sum:

$$\mu_{A \cup B}(x) = \mu_A(x) + \mu_B(x),$$

$$\nu_{A \cup B}(x) = \nu_A(x) + \nu_B(x),$$

$$\omega_{A \cup B}(x) = \omega_A(x) + \omega_B(x).$$

b) Max:

$$\mu_{A \cup B}(x) = \max(\mu_A(x), \mu_B(x)),$$

$$\nu_{A \cup B}(x) = \max(\nu_A(x), \nu_B(x)),$$

$$\omega_{A \cup B}(x) = \max(\omega_A(x), \omega_B(x)).$$

c) Min:

$$\mu_{A \cup B}(x) = \min(\mu_A(x), \mu_B(x)),$$

$$v_{A \cup B}(x) = \min(v_A(x), v_B(x)),$$

$$\omega_{A \cup B}(x) = \min(\omega_A(x), \omega_B(x)).$$

d) “The game of winner, neutral, and loser”:

$$\mu_{A \cup B}(x) = \begin{cases} \mu_A(x) & \text{if } p_A > p_B \\ \mu_B(x) & \text{if } p_B > p_A \end{cases},$$

$$v_{A \cup B}(x) = \begin{cases} v_A(x) & \text{if } q_A < q_B \\ v_B(x) & \text{if } q_B < q_A \end{cases},$$

$$\omega_{A \cup B}(x) = \begin{cases} \omega_A(x) & \text{if } r_A < r_B \\ \omega_B(x) & \text{if } r_B < r_A \end{cases}.$$

The game of winner, neutral, and loser is the generalization of the concept “winner take all” introduced by Ramot et al. in (2002) for the union of phase terms.

Definition 2.6 (Ali and Smarandache, 2015) Intersection of complex neutrosophic sets

Let A and B be two complex neutrosophic sets in X, $A = \{(x, T_A(x), I_A(x), F_A(x)) : x \in X\}$ and $B = \{(x, T_B(x), I_B(x), F_B(x)) : x \in X\}$.

Then the intersection of A and B is denoted as $A \cap_N B$ and is define as

$$A \cap_N B = \{(x, T_{A \cap B}(x), I_{A \cap B}(x), F_{A \cap B}(x)) : x \in X\}$$

Where the truth membership function $T_{A \cap B}(x)$, the indeterminacy membership function $I_{A \cap B}(x)$ and the falsehood membership function $F_{A \cap B}(x)$ is given as:

$$T_{A \cap B}(x) = [(p_A(x) \wedge p_B(x))] \cdot e^{j \cdot \mu_{T_{A \cap B}}(x)},$$

$$I_{A \cap B}(x) = [(q_A(x) \vee q_B(x))] \cdot e^{j \cdot \nu_{I_{A \cap B}}(x)},$$

$$F_{A \cap B}(x) = [(r_A(x) \vee r_B(x))] \cdot e^{j \cdot \omega_{F_{A \cap B}}(x)}$$

Where \vee and \wedge denotes denotes the max and min operators respectively

The phase terms $e^{j \cdot \mu_{T_{A \cap B}}(x)}$, $e^{j \cdot \nu_{I_{A \cap B}}(x)}$ and $e^{j \cdot \omega_{F_{A \cap B}}(x)}$ was calculated on the same lines by winner, neutral, and loser game.

Definition 2.7 (Broumi et al., 2017c). A bipolar complex neutrosophic set A in X is defined as an object of the form

$A = \{ \langle x, T_1^+ e^{iT_2^+}, I_1^+ e^{iI_2^+}, F_1^+ e^{iF_2^+}, T_1^- e^{iT_2^-}, I_1^- e^{iI_2^-}, F_1^- e^{iF_2^-} \rangle : x \in X \}$, where $T_1^+, I_1^+, F_1^+ : X \rightarrow [1, 0]$ and $T_1^-, I_1^-, F_1^- : X \rightarrow [-1, 0]$. The positive membership degree $T_1^+(x), I_1^+(x), F_1^+(x)$ denotes the truth membership, indeterminate membership and false membership of an element $x \in X$ corresponding to a bipolar complex neutrosophic set A and the negative membership degree $T_1^-(x), I_1^-(x), F_1^-(x)$ denotes the truth membership, indeterminate membership and false membership of an element $x \in X$ to some implicit counter-property corresponding to a bipolar complex neutrosophic set A. For convenience a bipolar complex neutrosophic number is represented by

$$A = \langle T_1^+ e^{iT_2^+}, I_1^+ e^{iI_2^+}, F_1^+ e^{iF_2^+}, T_1^- e^{iT_2^-}, I_1^- e^{iI_2^-}, F_1^- e^{iF_2^-} \rangle$$

Definition 2.8 (Broumi et al., 2017c). The union of two bipolar complex neutrosophic sets as follows:

Let A and B be two bipolar complex neutrosophic sets in X, where

$A = (T_1^+ e^{iT_2^+}, I_1^+ e^{iI_2^+}, F_1^+ e^{iF_2^+}, T_1^- e^{iT_2^-}, I_1^- e^{iI_2^-}, F_1^- e^{iF_2^-})$ and

$$B = (T_3^+ e^{iT_4^+}, I_3^+ e^{iI_4^+}, F_3^+ e^{iF_4^+}, T_3^- e^{iT_4^-}, I_3^- e^{iI_4^-}, F_3^- e^{iF_4^-})$$

Then the union of A and B is denoted as $A \cup_{BN} B$ and is given as

$$A \cup_{BN} B = \{(x, T_{A \cup B}^+(x), I_{A \cup B}^+(x), F_{A \cup B}^+(x), T_{A \cup B}^-(x), I_{A \cup B}^-(x), F_{A \cup B}^-(x)) : x \in X\}$$

Where positive the truth membership function $T_{A \cup B}^+(x)$, positive the indeterminacy membership function $I_{A \cup B}^+(x)$ and positive the falsehood membership function $F_{A \cup B}^+(x)$, negative the truth membership function $T_{A \cup B}^-(x)$, negative the indeterminacy membership function $I_{A \cup B}^-(x)$ and negative the falsehood membership function $F_{A \cup B}^-(x)$ is defined by

$$T_{A \cup B}^+(x) = (T_1^+ \vee T_3^+) e^{i(T_2^+ \cup T_4^+)},$$

$$T_{A \cup B}^-(x) = (T_1^- \wedge T_3^-) e^{i(T_2^- \cup T_4^-)},$$

$$I_{A \cup B}^+(x) = (I_1^+ \wedge I_3^+) e^{i(I_2^+ \cup I_4^+)},$$

$$I_{A \cup B}^-(x) = (I_1^- \vee I_3^-) e^{i(I_2^- \cup I_4^-)},$$

$$F_{A \cup B}^+(x) = (F_1^+ \wedge F_3^+) e^{i(F_2^+ \cup F_4^+)},$$

$$F_{A \cup B}^-(x) = (F_1^- \vee F_3^-) e^{i(F_2^- \cup F_4^-)}$$

Where \vee and \wedge denotes the max and min operators respectively

The phase term of bipolar complex truth membership function, bipolar complex indeterminate membership function and bipolar complex false -membership function belongs to $(0, 2\pi)$ and, they are defined as follows:

e) Sum:

$$T_{A \cup B}^+(x) = T_A^+(x) + T_B^+(x)$$

$$T_{A \cup B}^-(x) = T_A^-(x) + T_B^-(x)$$

$$I_{A \cup B}^+(x) = I_A^+(x) + I_B^+(x)$$

$$I_{A \cup B}^-(x) = I_A^-(x) + I_B^-(x)$$

$$F_{A \cup B}^+(x) = F_A^+(x) + F_B^+(x)$$

$$F_{A \cup B}^-(x) = F_A^-(x) + F_B^-(x)$$

f) Max and min:

$$T_{A \cup B}^+(x) = \max(T_A^+(x), T_B^+(x))$$

$$T_{A \cup B}^-(x) = \min(T_A^-(x), T_B^-(x))$$

$$I_{A \cup B}^+(x) = \min(I_A^+(x), I_B^+(x))$$

$$I_{A \cup B}^-(x) = \max(I_A^-(x), I_B^-(x))$$

$$F_{A \cup B}^+(x) = \min(F_A^+(x), F_B^+(x))$$

$$F_{A \cup B}^-(x) = \max(F_A^-(x), F_B^-(x))$$

g) “The game of winner, neutral, and loser”:

$$T_{A \cup B}^+(x) = \begin{cases} T_A^+(x) & \text{if } p_A > p_B \\ T_B^+(x) & \text{if } p_B > p_A \end{cases},$$

$$T_{A \cup B}^-(x) = \begin{cases} T_A^-(x) & \text{if } p_A < p_B \\ T_B^-(x) & \text{if } p_B < p_A \end{cases}$$

$$I_{A \cup B}^+(x) = \begin{cases} I_A^+(x) & \text{if } q_A < q_B \\ I_B^+(x) & \text{if } q_B < q_A \end{cases},$$

$$I^-_{A \cup B}(x) = \begin{cases} I^-_A(x) & \text{if } q_A > q_B \\ I^-_B(x) & \text{if } q_B > q_A \end{cases}$$

$$F^+_{A \cup B}(x) = \begin{cases} F^+_A(x) & \text{if } r_A < r_B \\ F^+_B(x) & \text{if } r_B < r_A \end{cases}$$

$$F^-_{A \cup B}(x) = \begin{cases} F^-_A(x) & \text{if } r_A > r_B \\ F^-_B(x) & \text{if } r_B > r_A \end{cases}$$

Example 2.9: Let $X = \{x_1, x_2\}$ be a universe of discourse. Let A and B be two bipolar complex neutrosophic sets in X as shown below:

$$A = \left(\frac{0.5e^{i.0.7}, 0.2e^{i.\pi}, 0.4e^{i.0.1}, -0.7e^{i.-0.4}, -0.3e^{i.-\frac{\pi}{3}}, -0.2e^{i.0}}{x_1} \right), \left(\frac{0.6e^{i.0.8}, 0.3e^{i.\frac{\pi}{3}}, 0.1e^{i.0.3}, -0.8e^{i.-0.5}, -0.4e^{i.-\frac{2\pi}{3}}, -0.1e^{i.-0.1}}{x_2} \right)$$

And

$$B = \left(\frac{0.9e^{i.0.6}, 0.3e^{i.\pi}, 0.1e^{i.0.3}, -0.6e^{i.-0.6}, -0.2e^{i.-2\pi}, -0.3e^{i.-0.3}}{x_1} \right), \left(\frac{0.8e^{i.0.9}, 0.4e^{i.\frac{3\pi}{4}}, 0.2e^{i.0.2}, -0.5e^{i.-0.6}, -0.1e^{i.-\frac{\pi}{3}}, -0.2e^{i.-0.1}}{x_2} \right)$$

Then

$$A \cup_{BN} B = \left(\frac{0.9e^{i.0.7}, 0.2e^{i.\pi}, 0.1e^{i.0.1}, -0.7e^{i.-0.6}, -0.2e^{i.-\frac{\pi}{3}}, -0.2e^{i.0}}{x_1} \right), \left(\frac{0.8e^{i.0.9}, 0.3e^{i.\frac{\pi}{3}}, 0.1e^{i.0.2}, -0.8e^{i.-0.6}, -0.1e^{i.-\frac{\pi}{3}}, -0.1e^{i.-0.1}}{x_2} \right)$$

Definition 2.10(Broumi et al., 2017c) The intersection of two bipolar complex neutrosophic sets as follows:

Let A and B be two bipolar complex neutrosophic sets in X , where

$$A = (T_1^+ e^{iT_2^+}, I_1^+ e^{iI_2^+}, F_1^+ e^{iF_2^+}, T_1^- e^{iT_2^-}, I_1^- e^{iI_2^-}, F_1^- e^{iF_2^-}) \text{ and}$$

$$B = (T_3^+ e^{iT_4^+}, I_3^+ e^{iI_4^+}, F_3^+ e^{iF_4^+}, T_3^- e^{iT_4^-}, I_3^- e^{iI_4^-}, F_3^- e^{iF_4^-})$$

Then the intersection of A and B is denoted as $A \cap_{BN} B$ and is given as

$$A \cap_{BN} B = \{(x, T^+_{A \cap B}(x), I^+_{A \cap B}(x), F^+_{A \cap B}(x), T^-_{A \cap B}(x), I^-_{A \cap B}(x), F^-_{A \cap B}(x)) : x \in X\}$$

Where positive the truth membership function $T^+_{A \cap B}(x)$, positive the indeterminacy membership function $I^+_{A \cap B}(x)$ and positive the falsehood membership function $F^+_{A \cap B}(x)$, negative the truth membership function $T^-_{A \cap B}(x)$, negative the indeterminacy membership function $I^-_{A \cap B}(x)$ and negative the falsehood membership function $F^-_{A \cap B}(x)$ is defined by

$$T^+_{A \cap B}(x) = (T_1^+ \wedge T_3^+) e^{i(T_2^+ \cap T_4^+)},$$

$$T^-_{A \cap B}(x) = (T_1^- \vee T_3^-) e^{i(T_2^- \cap T_4^-)},$$

$$\begin{aligned}
 I_{A \cap B}^+(x) &= (I_1^+ \vee I_3^+) e^{i(I_2^+ \cap I_4^+)}, \\
 T_{A \cap B}^-(x) &= (I_1^- \wedge I_3^-) e^{i(I_2^- \cap I_4^-)}, \\
 F_{A \cap B}^+(x) &= (F_1^+ \vee F_3^+) e^{i(F_2^+ \cap F_4^+)}, \\
 F_{A \cap B}^-(x) &= (F_1^- \wedge F_3^-) e^{i(F_2^- \cap F_4^-)}
 \end{aligned}$$

Where \vee and \wedge denotes the max and min operators respectively

The phase term of bipolar complex truth membership function, bipolar complex indeterminacy membership function and bipolar complex falsity membership function belongs to $(0, 2\pi)$ and, they are defined as follows:

h) Sum:

$$\begin{aligned}
 T_{A \cap B}^+(x) &= T_A^+(x) + T_B^+(x) \\
 T_{A \cap B}^-(x) &= T_A^-(x) + T_B^-(x) \\
 I_{A \cap B}^+(x) &= I_A^+(x) + I_B^+(x) \\
 I_{A \cap B}^-(x) &= I_A^-(x) + I_B^-(x) \\
 F_{A \cap B}^+(x) &= F_A^+(x) + F_B^+(x) \\
 F_{A \cap B}^-(x) &= F_A^-(x) + F_B^-(x)
 \end{aligned}$$

i) Max and min:

$$\begin{aligned}
 T_{A \cap B}^+(x) &= \min(T_A^+(x), T_B^+(x)) \\
 T_{A \cap B}^-(x) &= \max(T_A^-(x), T_B^-(x)) \\
 I_{A \cap B}^+(x) &= \max(I_A^+(x), I_B^+(x)) \\
 I_{A \cap B}^-(x) &= \min(I_A^-(x), I_B^-(x)) \\
 F_{A \cap B}^+(x) &= \max(F_A^+(x), F_B^+(x)) \\
 F_{A \cap B}^-(x) &= \min(F_A^-(x), F_B^-(x))
 \end{aligned}$$

j) “The game of winner, neutral, and loser”:

$$\begin{aligned}
 T_{A \cap B}^+(x) &= \begin{cases} T_A^+(x) & \text{if } p_A < p_B \\ T_B^+(x) & \text{if } p_B < p_A \end{cases}, \\
 T_{A \cap B}^-(x) &= \begin{cases} T_A^-(x) & \text{if } p_A > p_B \\ T_B^-(x) & \text{if } p_B > p_A \end{cases} \\
 I_{A \cap B}^+(x) &= \begin{cases} I_A^+(x) & \text{if } q_A > q_B \\ I_B^+(x) & \text{if } q_B > q_A \end{cases}, \\
 I_{A \cap B}^-(x) &= \begin{cases} I_A^-(x) & \text{if } q_A < q_B \\ I_B^-(x) & \text{if } q_B < q_A \end{cases} \\
 F_{A \cap B}^+(x) &= \begin{cases} F_A^+(x) & \text{if } r_A > r_B \\ F_B^+(x) & \text{if } r_B > r_A \end{cases} \\
 F_{A \cap B}^-(x) &= \begin{cases} F_A^-(x) & \text{if } r_A < r_B \\ F_B^-(x) & \text{if } r_B < r_A \end{cases}
 \end{aligned}$$

Example 2.11: Let $X = \{x_1, x_2\}$ be a universe of discourse. Let A and B be two bipolar complex neutrosophic sets in X as shown below:

$$A = \left(\frac{0.5e^{i.0.7}, 0.2e^{i.\pi}, 0.4e^{i.0.1}, -0.7e^{i.-0.4}, -0.3e^{i.-\frac{\pi}{3}}, -0.2e^{i.0}}{x_1} \right)$$

$$, \left(\frac{0.6e^{i.0.8}, 0.3e^{i.\frac{\pi}{3}}, 0.1e^{i.0.3}, -0.8e^{i.-0.5}, -0.4e^{i.-\frac{2\pi}{3}}, -0.1e^{i.-0.1}}{x_2} \right)$$

And

$$B = \left(\frac{0.9e^{i.0.6}, 0.3e^{i.\pi}, 0.1e^{i.0.3}, -0.6e^{i.-0.6}, -0.2e^{i.-2\pi}, -0.3e^{i.-0.3}}{x_1} \right), \left(\frac{0.8e^{i.0.9}, 0.4e^{i.\frac{3\pi}{4}}, 0.2e^{i.0.2}, -0.5e^{i.-0.6}, -0.1e^{i.-\frac{\pi}{3}}, -0.2e^{i.-0.1}}{x_2} \right)$$

Then

$$A \cap_{BN} B = \left(\frac{0.5e^{i.0.6}, 0.3e^{i.\pi}, 0.4e^{i.0.3}, -0.6e^{i.-0.4}, -0.3e^{i.-2\pi}, -0.3e^{i.-0.3}}{x_1} \right), \left(\frac{0.6e^{i.0.8}, 0.4e^{i.\frac{3\pi}{4}}, 0.2e^{i.0.3}, -0.5e^{i.-0.5}, -0.4e^{i.-\frac{2\pi}{3}}, -0.2e^{i.-0.1}}{x_2} \right)$$

Definition 2.12 (Samanta et al.2016). Let V be a non-void set. Two function are considered as follows:

$\rho:V \rightarrow [0, 1]$ and $\omega:V \times V \rightarrow [0, 1]$. We suppose

$A = \{(\rho(x), \rho(y)) \mid \omega(x, y) > 0\}$,

We have considered $\omega_T, > 0$ for all set A

The triad (V, ρ, ω) is defined to be generalized fuzzy graph of first type (GFG1) if there is function $\alpha:A \rightarrow [0, 1]$ such that $\omega(x, y) = \alpha((\rho(x), \rho(y)))$ Where $x, y \in V$.

The $\rho(x)$, $x \in V$ are the membership of the vertex x and $\omega(x, y)$, $x, y \in V$ are the membership values of the edge (x, y) .

Definition 2.13 (Broumi et al., 2017). Let V be a non-void set. Two function are considered as follows:

$\rho = (\rho_T, \rho_I, \rho_F):V \rightarrow [0, 1]^3$ and

$\omega = (\omega_T, \omega_I, \omega_F):V \times V \rightarrow [0, 1]^3$. Suppose

$A = \{(\rho_T(x), \rho_T(y)) \mid \omega_T(x, y) \geq 0\}$,

$B = \{(\rho_I(x), \rho_I(y)) \mid \omega_I(x, y) \geq 0\}$,

$C = \{(\rho_F(x), \rho_F(y)) \mid \omega_F(x, y) \geq 0\}$,

We have considered ω_T, ω_I and $\omega_F \geq 0$ for all set A, B, C, since its is possible to have edge degree = 0 (for T, or I, or F).

The triad (V, ρ, ω) is defined to be generalized single valued neutrosophic graph of type 1 (GSVNG1) if there are functions

$\alpha:A \rightarrow [0, 1]$, $\beta:B \rightarrow [0, 1]$ and $\delta:C \rightarrow [0, 1]$ such that

$\omega_T(x, y) = \alpha((\rho_T(x), \rho_T(y)))$

$\omega_I(x, y) = \beta((\rho_I(x), \rho_I(y)))$

$\omega_F(x, y) = \delta((\rho_F(x), \rho_F(y)))$ where $x, y \in V$.

Here $\rho(x) = (\rho_T(x), \rho_I(x), \rho_F(x))$, $x \in V$ are the truth-membership, indeterminate-membership and false-membership of the vertex x and $\omega(x, y) = (\omega_T(x, y), \omega_I(x, y), \omega_F(x, y))$, $x, y \in V$ are the truth-membership, indeterminate-membership and false-membership values of the edge (x, y) .

Definition 2.14 (Broumi et al., 2017b) Let V be a non-void set. Two functions are considered as follows:

$$\rho = (\rho_T, \rho_I, \rho_F): V \rightarrow [0, 1]^3 \text{ and}$$

$$\omega = (\omega_T, \omega_I, \omega_F): V \times V \rightarrow [0, 1]^3. \text{ Suppose}$$

$$A = \{(\rho_T(x), \rho_T(y)) \mid \omega_T(x, y) \geq 0\},$$

$$B = \{(\rho_I(x), \rho_I(y)) \mid \omega_I(x, y) \geq 0\},$$

$$C = \{(\rho_F(x), \rho_F(y)) \mid \omega_F(x, y) \geq 0\},$$

We have considered ω_T, ω_I and $\omega_F \geq 0$ for all set A, B, C , since its is possible to have edge degree = 0 (for T , or I , or F).

The triad (V, ρ, ω) is defined to be complex neutrosophic graph of type 1 (CNG1) if there are functions

$$\alpha: A \rightarrow [0, 1], \beta: B \rightarrow [0, 1] \text{ and } \delta: C \rightarrow [0, 1] \text{ such that}$$

$$\omega_T(x, y) = \alpha((\rho_T(x), \rho_T(y)))$$

$$\omega_I(x, y) = \beta((\rho_I(x), \rho_I(y)))$$

$$\omega_F(x, y) = \delta((\rho_F(x), \rho_F(y)))$$

Where $x, y \in V$.

Here $\rho(x) = (\rho_T(x), \rho_I(x), \rho_F(x))$, $x \in V$ are the complex truth-membership, complex indeterminate-membership and complex false-membership of the vertex x and $\omega(x, y) = (\omega_T(x, y), \omega_I(x, y), \omega_F(x, y))$, $x, y \in V$ are the complex truth-membership, complex indeterminate-membership and complex false-membership values of the edge (x, y) .

Definition 2.15 (Broumi et al., 2017b). Let V be a non-void set. Two function are considered as follows:

$$\rho = (\rho_T^+, \rho_I^+, \rho_F^+, \rho_T^-, \rho_I^-, \rho_F^-): V \rightarrow [0, 1]^3 \times [-1, 0]^3 \text{ and}$$

$$\omega = (\omega_T^+, \omega_I^+, \omega_F^+, \omega_T^-, \omega_I^-, \omega_F^-): V \times V \rightarrow [0, 1]^3 \times [-1, 0]^3. \text{ We suppose}$$

$$A = \{(\rho_T^+(x), \rho_T^+(y)) \mid \omega_T^+(x, y) \geq 0\},$$

$$B = \{(\rho_I^+(x), \rho_I^+(y)) \mid \omega_I^+(x, y) \geq 0\},$$

$$C = \{(\rho_F^+(x), \rho_F^+(y)) \mid \omega_F^+(x, y) \geq 0\},$$

$$D = \{(\rho_T^-(x), \rho_T^-(y)) \mid \omega_T^-(x, y) \leq 0\},$$

$$E = \{(\rho_I^-(x), \rho_I^-(y)) \mid \omega_I^-(x, y) \leq 0\},$$

$$F = \{(\rho_F^-(x), \rho_F^-(y)) \mid \omega_F^-(x, y) \leq 0\},$$

We have considered $\omega_T^+, \omega_I^+, \omega_F^+ \geq 0$ and $\omega_T^-, \omega_I^-, \omega_F^- \leq 0$ for all set A, B, C, D, E, F since its is possible to have edge degree = 0 (for T^+ or I^+ or F^+ , T^- or I^- or F^-).

The triad (V, ρ, ω) is defined to be generalized bipolar neutrosophic graph of first type (GBNG1) if there are functions

$$\alpha: A \rightarrow [0, 1], \beta: B \rightarrow [0, 1], \delta: C \rightarrow [0, 1] \text{ and } \xi: D \rightarrow [-1, 0], \sigma: E \rightarrow [-1, 0], \psi: F \rightarrow [-1, 0] \text{ such that}$$

$$\omega_T^+(x, y) = \alpha((\rho_T^+(x), \rho_T^+(y))),$$

$$\omega_T^-(x, y) = \xi((\rho_T^-(x), \rho_T^-(y))),$$

$$\omega_I^+(x, y) = \beta((\rho_I^+(x), \rho_I^+(y))),$$

$$\omega_I^-(x, y) = \sigma((\rho_I^-(x), \rho_I^-(y))),$$

$$\omega_F^+(x, y) = \delta((\rho_F^+(x), \rho_F^+(y))),$$

$$\omega_F^-(x, y) = \psi((\rho_F^-(x), \rho_F^-(y)))$$

Where $x, y \in V$.

Here $\rho(x) = (\rho_T^+(x), \rho_I^+(x), \rho_F^+(x), \rho_T^-(x), \rho_I^-(x), \rho_F^-(x))$, $x \in V$ are the positive and negative membership, indeterminacy and non-membership of the vertex x and $\omega(x, y) = (\omega_T^+(x, y),$

$\omega_I^+(x, y), \omega_F^+(x, y), \omega_T^-(x, y), \omega_I^-(x, y), \omega_F^-(x, y)$, $x, y \in V$ are the positive and negative membership, indeterminacy membership and non-membership values of the edge (x, y) .

3. Bipolar Complex Neutrosophic Graph of Type 1

In this section, based on the concept of bipolar complex neutrosophic sets (Broumi et al., 2017c) and the concept of generalized single valued neutrosophic graph of type 1 (Broumi et al., 2017), we define the concept of bipolar complex neutrosophic graph of type 1 as follows:

Definition 3.1. Let V be a non-void set. Two function are considered as follows:

$$\rho = (\rho_T^+, \rho_I^+, \rho_F^+, \rho_T^-, \rho_I^-, \rho_F^-): V \rightarrow [-1, 1]^6 \text{ and}$$

$$\omega = (\omega_T^+, \omega_I^+, \omega_F^+, \omega_T^-, \omega_I^-, \omega_F^-): V \times V \rightarrow [-1, 1]^6 . \text{ We suppose}$$

$$A = \{(\rho_T^+(x), \rho_T^+(y)) \mid \omega_T^+(x, y) \geq 0\},$$

$$B = \{(\rho_I^+(x), \rho_I^+(y)) \mid \omega_I^+(x, y) \geq 0\},$$

$$C = \{(\rho_F^+(x), \rho_F^+(y)) \mid \omega_F^+(x, y) \geq 0\},$$

$$D = \{(\rho_T^-(x), \rho_T^-(y)) \mid \omega_T^-(x, y) \leq 0\},$$

$$E = \{(\rho_I^-(x), \rho_I^-(y)) \mid \omega_I^-(x, y) \leq 0\},$$

$$F = \{(\rho_F^-(x), \rho_F^-(y)) \mid \omega_F^-(x, y) \leq 0\},$$

We have considered $\omega_T^+, \omega_I^+, \omega_F^+ \geq 0$ and $\omega_T^-, \omega_I^-, \omega_F^- \leq 0$ for all set A, B, C, D, E, F since its is possible to have edge degree = 0 (for T^+ or I^+ or F^+, T^- or I^- or F^-).

The triad (V, ρ, ω) is defined to be bipolar complex neutrosophic graph of first type (BCNG1) if there are functions

$$\alpha: A \rightarrow [0, 1], \beta: B \rightarrow [0, 1], \delta: C \rightarrow [0, 1] \text{ and } \xi: D \rightarrow [-1, 0], \sigma: E \rightarrow [-1, 0], \psi: F \rightarrow [-1, 0] \text{ such that}$$

$$\omega_T^+(x, y) = \alpha((\rho_T^+(x), \rho_T^+(y))),$$

$$\omega_T^-(x, y) = \xi((\rho_T^-(x), \rho_T^-(y))),$$

$$\omega_I^+(x, y) = \beta((\rho_I^+(x), \rho_I^+(y))),$$

$$\omega_I^-(x, y) = \sigma((\rho_I^-(x), \rho_I^-(y))),$$

$$\omega_F^+(x, y) = \delta((\rho_F^+(x), \rho_F^+(y))),$$

$$\omega_F^-(x, y) = \psi((\rho_F^-(x), \rho_F^-(y)))$$

Where $x, y \in V$.

Here $\rho(x) = (\rho_T^+(x), \rho_I^+(x), \rho_F^+(x), \rho_T^-(x), \rho_I^-(x), \rho_F^-(x))$, $x \in V$ are the positive and negative complex truth-membership, indeterminate and false-membership of the vertex x and $\omega(x, y) = (\omega_T^+(x, y), \omega_I^+(x, y), \omega_F^+(x, y), \omega_T^-(x, y), \omega_I^-(x, y), \omega_F^-(x, y))$, $x, y \in V$ are the positive and negative complex truth-membership, indeterminate and false-membership values of the edge (x, y) .

Example 3.2: Let the vertex set be $V = \{x, y, z, t\}$ and edge set be $E = \{(x, y), (x, z), (x, t), (y, t)\}$

	x	y	z	t
ρ_T^+	$0.5e^{i.0.8}$	$0.9e^{i.0.9}$	$0.3e^{i.0.3}$	$0.8e^{i.0.1}$
ρ_I^+	$0.3e^{i.\frac{3\pi}{4}}$	$0.2e^{i.\frac{\pi}{4}}$	$0.1e^{i.2\pi}$	$0.5e^{i.\pi}$
ρ_F^+	$0.1e^{i.0.3}$	$0.6e^{i.0.5}$	$0.8e^{i.0.5}$	$0.4e^{i.0.7}$
ρ_T^-	$-0.6e^{i.-0.6}$	$-1e^{i.-\pi}$	$-0.4e^{i.-0.1}$	$-0.9e^{i.-0.1}$
ρ_I^-	$-0.4e^{i.-2\pi}$	$-0.3e^{i.0}$	$-0.2e^{i.-0.3}$	$-0.6e^{i.-0.2}$
ρ_F^-	$-0.2e^{i.-0.3}$	$-0.7e^{i.-0.6}$	$-0.9e^{i.-2\pi}$	$-0.5e^{i.-\pi}$

Table 1: Bipolar complex truth-membership, bipolar complex indeterminate-membership and bipolar complex false-membership of the vertex set.

Let us consider the function

$$\alpha(m, n) = (m_T^+ \vee n_T^+) \cdot e^{j \cdot \mu_{T_{m \cup n}}}$$

$$\beta(m, n) = (m_I^+ \wedge n_I^+) \cdot e^{j \cdot \mu_{I_{m \cup n}}}$$

$$\delta(m, n) = (m_F^+ \wedge n_F^+) \cdot e^{j \cdot \mu_{F_{m \cup n}}}$$

$$\xi(m, n) = (m_T^- \wedge n_T^-) \cdot e^{j \cdot \mu_{T_{m \cup n}}}$$

$$\sigma(m, n) = (m_I^- \vee n_I^-) \cdot e^{j \cdot \mu_{I_{m \cup n}}}$$

$$\psi(m, n) = (m_F^- \vee n_F^-) \cdot e^{j \cdot \mu_{F_{m \cup n}}}$$

Here,

$$A = \{(0.5e^{i \cdot 0.8}, 0.9e^{i \cdot 0.9}), (0.5e^{i \cdot 0.8}, 0.3e^{i \cdot 0.3}), (0.5e^{i \cdot 0.8}, 0.8e^{i \cdot 0.1}), (0.9e^{i \cdot 0.9}, 0.8e^{i \cdot 0.1})\}$$

$$B = \{(0.3e^{i \cdot \frac{3\pi}{4}}, 0.2e^{i \cdot \frac{\pi}{4}}), (0.3e^{i \cdot \frac{3\pi}{4}}, 0.1e^{i \cdot 2\pi}), (0.3e^{i \cdot \frac{3\pi}{4}}, 0.5e^{i \cdot \pi}), (0.2e^{i \cdot \frac{\pi}{4}}, 0.5e^{i \cdot \pi})\}$$

$$C = \{(0.1e^{i \cdot 0.3}, 0.6e^{i \cdot 0.5}), (0.1e^{i \cdot 0.3}, 0.8e^{i \cdot 0.5}), (0.1e^{i \cdot 0.3}, 0.4e^{i \cdot 0.7}), (0.6e^{i \cdot 0.5}, 0.4e^{i \cdot 0.7})\}$$

$$D = \{(-0.6e^{i \cdot -0.6}, -1e^{i \cdot -\pi}), (-0.6e^{i \cdot -0.6}, -0.4e^{i \cdot -0.1}), (-0.6e^{i \cdot -0.6}, -0.9e^{i \cdot -0.1}), (-1e^{i \cdot -\pi}, -0.9e^{i \cdot -0.1})\}$$

$$E = \{(-0.4e^{i \cdot -2\pi}, -0.3e^{i \cdot 0}), (-0.4e^{i \cdot -2\pi}, -0.2e^{i \cdot -0.3}), (-0.4e^{i \cdot -2\pi}, -0.6e^{i \cdot -0.2}), (-0.3e^{i \cdot 0}, -0.6e^{i \cdot -0.2})\}$$

$$F = \{(-0.2e^{i \cdot -0.3}, -0.7e^{i \cdot -0.6}), (-0.2e^{i \cdot -0.3}, -0.9e^{i \cdot -2\pi}), (-0.2e^{i \cdot -0.3}, -0.5e^{i \cdot -\pi}), (-0.7e^{i \cdot -0.6}, -0.5e^{i \cdot -\pi})\}$$

Then

ω	(x, y)	(x, z)	(x, t)	(y, t)
$\omega_T^+(x, y)$	$0.9e^{i \cdot 0.9}$	$0.5e^{i \cdot 0.8}$	$0.8e^{i \cdot 0.8}$	$0.9e^{i \cdot 0.9}$
$\omega_I^+(x, y)$	$0.2e^{i \cdot \frac{\pi}{4}}$	$0.1e^{i \cdot \frac{3\pi}{4}}$	$0.3e^{i \cdot \frac{3\pi}{4}}$	$0.2e^{i \cdot \frac{\pi}{4}}$
$\omega_F^+(x, y)$	$0.1e^{i \cdot 0.3}$	$0.1e^{i \cdot 0.3}$	$0.1e^{i \cdot 0.3}$	$0.4e^{i \cdot 0.5}$
$\omega_T^-(x, y)$	$-1e^{i \cdot -\pi}$	$-0.6e^{i \cdot -0.6}$	$-0.9e^{i \cdot -0.6}$	$-1e^{i \cdot -\pi}$
$\omega_I^-(x, y)$	$-0.3e^{i \cdot 0}$	$-0.2e^{i \cdot -2\pi}$	$-0.4e^{i \cdot -2\pi}$	$-0.3e^{i \cdot 0}$
$\omega_F^-(x, y)$	$-0.2e^{i \cdot -0.3}$	$-0.2e^{i \cdot -0.3}$	$-0.2e^{i \cdot -0.3}$	$-0.5e^{i \cdot -0.6}$

Table 2: Bipolar complex truth-membership, bipolar complex indeterminate-membership and bipolar complex false-membership of the edge set.

The corresponding complex neutrosophic graph is shown in Fig.2

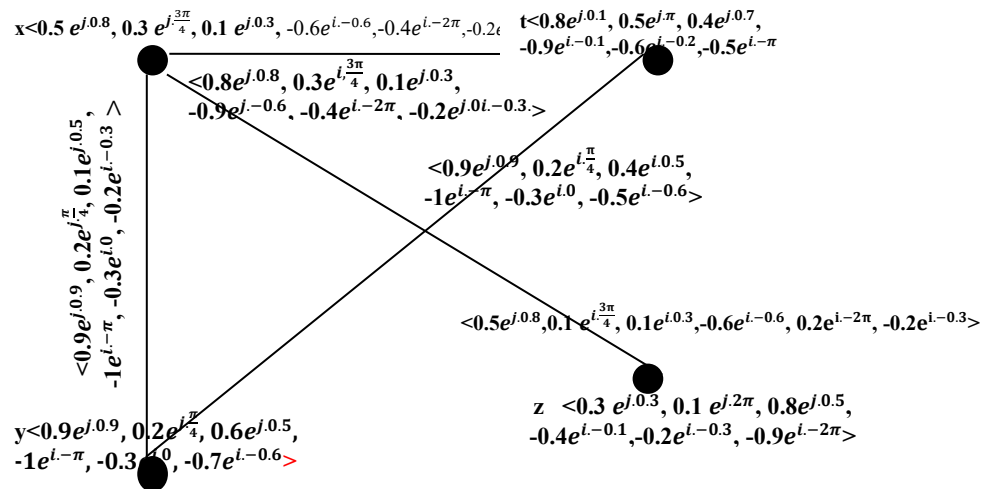

Fig 2. BCNG of type 1.

4. Matrix Representation of Bipolar Complex Neutrosophic Graph of Type 1

In this section, bipolar complex truth-membership, bipolar complex indeterminate-membership, and bipolar complex false-membership are considered independent. So, we adopted the representation matrix of complex neutrosophic graphs of type 1 presented in (Broumi et al., 2017b).

The bipolar complex neutrosophic graph (BCNG1) has one property that edge membership values ($T^+, I^+, F^+, T^-, I^-, F^-$) depends on the membership values ($T^+, I^+, F^+, T^-, I^-, F^-$) of adjacent vertices. Suppose $\zeta=(V, \rho, \omega)$ is a BCNG1 where vertex set $V=\{v_1, v_2, \dots, v_n\}$. The functions

$\alpha :A \rightarrow [0, 1]$ is taken such that $\omega_T^+(x, y) = \alpha ((\rho_T^+(x), \rho_T^+(y)))$, where $x, y \in V$ and $A= \{(\rho_T^+(x), \rho_T^+(y)) \mid \omega_T^+(x, y) \geq 0\}$,

$\beta :B \rightarrow [0, 1]$ is taken such that $\omega_I^+(x, y) = \beta ((\rho_I^+(x), \rho_I^+(y)))$, where $x, y \in V$ and $B= \{(\rho_I^+(x), \rho_I^+(y)) \mid \omega_I^+(x, y) \geq 0\}$,

$\delta :C \rightarrow [0, 1]$ is taken such that $\omega_F^+(x, y) = \delta ((\rho_F^+(x), \rho_F^+(y)))$, where $x, y \in V$ and $C = \{(\rho_F^+(x), \rho_F^+(y)) \mid \omega_F^+(x, y) \geq 0\}$,

$\xi :D \rightarrow [-1, 0]$ is taken such that $\omega_T^-(x, y) = \xi ((\rho_T^-(x), \rho_T^-(y)))$, where $x, y \in V$ and $D= \{(\rho_T^-(x), \rho_T^-(y)) \mid \omega_T^-(x, y) \leq 0\}$,

$\sigma :E \rightarrow [-1, 0]$ is taken such that $\omega_I^-(x, y) = \sigma ((\rho_I^-(x), \rho_I^-(y)))$, where $x, y \in V$ and $E= \{(\rho_I^-(x), \rho_I^-(y)) \mid \omega_I^-(x, y) \leq 0\}$, and

$\psi :F \rightarrow [-1, 0]$ is taken such that $\omega_F^-(x, y) = \psi ((\rho_F^-(x), \rho_F^-(y)))$, where $x, y \in V$ and $F = \{(\rho_F^-(x), \rho_F^-(y)) \mid \omega_F^-(x, y) \leq 0\}$,

The BCNG1 can be represented by $(n+1) \times (n+1)$ matrix $M_{G_1}^{T,I,F}=[a^{T,I,F}(i,j)]$ as follows:

The positive and negative bipolar complex truth-membership (T^+, T^-), indeterminate-membership (I^+, I^-) and false-membership (F^+, F^-), values of the vertices are provided in the first row and first column. The $(i+1, j+1)$ -th-entry are the bipolar complex truth -membership (T^+, T^-), indeterminate-membership (I^+, I^-) and the false-membership (F^+, F^-) values of the edge (x_i, x_j) , $i, j=1, \dots, n$ if $i \neq j$.

The (i, i) -th entry is $\rho(x_i)=(\rho_T^+(x_i), \rho_I^+(x_i), \rho_F^+(x_i), \rho_T^-(x_i), \rho_I^-(x_i), \rho_F^-(x_i))$ where $i=1, 2, \dots, n$. The positive and negative bipolar complex truth-membership (T^+, T^-), indeterminate-membership (I^+, I^-) and false-membership (F^+, F^-), values of the edge can be computed easily using the functions $\alpha, \beta, \delta, \xi, \sigma$ and ψ which are in $(1,1)$ -position of the matrix. The matrix representation of BCNG1, denoted by $M_{G_1}^{T,I,F}$, can be written as sixth matrix representation $M_{G_1}^{T^+}, M_{G_1}^{I^+}, M_{G_1}^{F^+}, M_{G_1}^{T^-}, M_{G_1}^{I^-}, M_{G_1}^{F^-}$.

The $M_{G_1}^{T^+}$ is represented in Table 3.

Table 3. Matrix representation of T^+ -BCNG1

α	$v_1(\rho_T^+(v_1))$	$v_2(\rho_T^+(v_2))$	$v_n(\rho_T^+(v_n))$
$v_1(\rho_T^+(v_1))$	$\rho_T^+(v_1)$	$\alpha(\rho_T^+(v_1), \rho_T^+(v_2))$	$\alpha(\rho_T^+(v_1), \rho_T^+(v_n))$
$v_2(\rho_T^+(v_2))$	$\alpha(\rho_T^+(v_2), \rho_T^+(v_1))$	$\rho_T^+(v_2)$	$\alpha(\rho_T^+(v_2), \rho_T^+(v_2))$
...
$v_n(\rho_T^+(v_n))$	$\alpha(\rho_T^+(v_n), \rho_T^+(v_1))$	$\alpha(\rho_T^+(v_n), \rho_T^+(v_2))$	$\rho_T^+(v_n)$

The $M_{G_1}^{I^+}$ is presented in Table 4. Table4. Matrix representation of I^+ - BCNG

β	$v_1(\rho_I^+(v_1))$	$v_2(\rho_I^+(v_2))$	$v_n(\rho_I^+(v_n))$
$v_1(\rho_I^+(v_1))$	$\rho_I^+(v_1)$	$\beta(\rho_I^+(v_1), \rho_I^+(v_2))$	$\beta(\rho_I^+(v_1), \rho_I^+(v_n))$
$v_2(\rho_I^+(v_2))$	$\beta(\rho_I^+(v_2), \rho_I^+(v_1))$	$\rho_I^+(v_2)$	$\beta(\rho_I^+(v_2), \rho_I^+(v_2))$
...
$v_n(\rho_I^+(v_n))$	$\beta(\rho_I^+(v_n), \rho_I^+(v_1))$	$\beta(\rho_I^+(v_n), \rho_I^+(v_2))$	$\rho_I^+(v_n)$

1

The $M_{G_1}^{F^+}$ is presented in Table 5.

Table5. Matrix representation of F^+ - BCNG1

δ	$v_1(\rho_F^+(v_1))$	$v_2(\rho_F^+(v_2))$	$v_n(\rho_F^+(v_n))$
$v_1(\rho_F^+(v_1))$	$\rho_F^+(v_1)$	$\delta(\rho_F^+(v_1), \rho_F^+(v_2))$	$\delta(\rho_F^+(v_1), \rho_F^+(v_n))$
$v_2(\rho_F^+(v_2))$	$\delta(\rho_F^+(v_2), \rho_F^+(v_1))$	$\rho_F^+(v_2)$	$\delta(\rho_F^+(v_2), \rho_F^+(v_2))$
...
$v_n(\rho_F^+(v_n))$	$\delta(\rho_F^+(v_n), \rho_F^+(v_1))$	$\delta(\rho_F^+(v_n), \rho_F^+(v_2))$	$\rho_F^+(v_n)$

The $M_{G_1}^{T^-}$ is shown in table 6.

Table 6. Matrix representation of T^- - BCNG1

ξ	$v_1(\rho_T^-(v_1))$	$v_2(\rho_T^-(v_2))$	$v_n(\rho_T^-(v_n))$
$v_1(\rho_T^-(v_1))$	$\rho_T^-(v_1)$	$\xi(\rho_T^-(v_1), \rho_T^-(v_2))$	$\xi(\rho_T^-(v_1), \rho_T^-(v_n))$
$v_2(\rho_T^-(v_2))$	$\xi(\rho_T^-(v_2), \rho_T^-(v_1))$	$\rho_T^-(v_2)$	$\xi(\rho_T^-(v_2), \rho_T^-(v_2))$
...
$v_n(\rho_T^-(v_n))$	$\xi(\rho_T^-(v_n), \rho_T^-(v_1))$	$\xi(\rho_T^-(v_n), \rho_T^-(v_2))$	$\rho_T^-(v_n)$

The $M_{G_1}^{I^-}$ is shown in Table 7.

Table 7. Matrix representation of I^- - BCNG1

σ	$v_1(\rho_I^-(v_1))$	$v_2(\rho_I^-(v_2))$	$v_n(\rho_I^-(v_n))$
$v_1(\rho_I^-(v_1))$	$\rho_I^-(v_1)$	$\sigma(\rho_I^-(v_1), \rho_I^-(v_2))$	$\sigma(\rho_I^-(v_1), \rho_I^-(v_n))$
$v_2(\rho_I^-(v_2))$	$\sigma(\rho_I^-(v_2), \rho_I^-(v_1))$	$\rho_I^-(v_2)$	$\sigma(\rho_I^-(v_2), \rho_I^-(v_2))$
...
$v_n(\rho_I^-(v_n))$	$\sigma(\rho_I^-(v_n), \rho_I^-(v_1))$	$\sigma(\rho_I^-(v_n), \rho_I^-(v_2))$	$\rho_I^-(v_n)$

The $M_{G_1}^{F^-}$ is presented in Table 8.

Table8. Matrix representation of F^- - BCNG1

ψ	$v_1(\rho_F^-(v_1))$	$v_2(\rho_F^-(v_2))$	$v_n(\rho_F^-(v_n))$
$v_1(\rho_F^-(v_1))$	$\rho_F^-(v_1)$	$\psi(\rho_F^-(v_1), \rho_F^-(v_2))$	$\psi(\rho_F^-(v_1), \rho_F^-(v_n))$
$v_2(\rho_F^-(v_2))$	$\psi(\rho_F^-(v_2), \rho_F^-(v_1))$	$\rho_F^-(v_2)$	$\psi(\rho_F^-(v_2), \rho_F^-(v_2))$
...
$v_n(\rho_F^-(v_n))$	$\psi(\rho_F^-(v_n), \rho_F^-(v_1))$	$\psi(\rho_F^-(v_n), \rho_F^-(v_2))$	$\rho_F^-(v_n)$

Remark1:if $\rho_T^-(x) = \rho_I^-(x) = \rho_F^-(x) = 0$, the bipolar complex neutrosophic graphs of type 1 is reduced to complex neutrosophic graph of type 1 (CNG1).

Remark2:if $\rho_T^-(x) = \rho_I^-(x) = \rho_F^-(x) = 0$, and $\rho_I^+(x) = \rho_F^+(x) = 0$, the bipolar complex neutrosophic graphs of type 1 is reduced to generalized fuzzy graph of type 1 (GFG1).

Remark3:if the phase terms of bipolar complex neutrosophic values of the vertices equals 0, the bipolar complex neutrosophic graphs of type 1 is reduced to generalized bipolar neutrosophic graph of type 1 (GBNG1).

Remark4:if $\rho_T^-(x) = \rho_I^-(x) = \rho_F^-(x) = 0$, and the phase terms of positive truth-membership, indeterminate-membership and false-membership of the vertices equals 0, the bipolar complex neutrosophic graphs of type 1 is reduced to generalized single valued neutrosophic graph of type 1 (GSVNG1).

Here the bipolar complex neutrosophic graph of type 1 (BCNG1) can be represented by the matrix representation depicted in table 15. The matrix representation can be written as six matrices one containing the entries as $T^+, I^+, F^+, T^-, I^-, F^-$ (see table 9, 10, 11, 12, 13 and 14).

Table 9. T^+ - matrix representation of BCNG1

α	$x(0.5 e^{j.0.8})$	$y(0.9 e^{j.0.9})$	$z(0.3 e^{j.0.3})$	$t(0.8 e^{j.0.1})$
$x(0.5 e^{i.0.8})$	$0.5 e^{j.0.8}$	$0.9 e^{j.0.9}$	$0.5 e^{j.0.8}$	$0.8 e^{i.0.8}$
$y(0.9 e^{i.0.9})$	$0.9 e^{j.0.9}$	$0.9 e^{j.0.9}$	0	$0.9 e^{j.0.9}$
$z(0.3 e^{i.0.3})$	$0.5 e^{j.0.8}$	0	$0.3 e^{j.0.3}$	0
$t(0.8 e^{i.0.1})$	$0.8 e^{j.0.8}$	$0.9 e^{j.0.9}$	0	$0.8 e^{j.0.1}$

Table 10. I^+ - matrix representation of BCNG1

β	$x(0.3 e^{j.\frac{3\pi}{4}})$	$y(0.2 e^{j.\frac{\pi}{4}})$	$z(0.1 e^{j.2\pi})$	$t(0.5 e^{j.\pi})$
$x(0.3 e^{j.\frac{3\pi}{4}})$	$0.3 e^{j.\frac{3\pi}{4}}$	$0.2 e^{j.\frac{\pi}{4}}$	$0.1 e^{j.\frac{3\pi}{4}}$	$0.1 e^{j.\frac{3\pi}{4}}$
$y(0.2 e^{j.\frac{\pi}{4}})$	$0.2 e^{j.\frac{\pi}{4}}$	$0.2 e^{j.\frac{\pi}{4}}$	0	$0.2 e^{j.\frac{\pi}{4}}$
$z(0.1 e^{j.2\pi})$	$0.1 e^{j.\frac{3\pi}{4}}$	0	$0.1 e^{j.2\pi}$	0
$t(0.5 e^{j.\pi})$	$0.3 e^{j.2\pi}$	$0.2 e^{j.\frac{\pi}{4}}$	0	$0.5 e^{j.\pi}$

Table 11: F^+ - matrix representation of BCNG1

δ	$x(0.1 e^{i.0.3})$	$y(0.6 e^{j.0.5})$	$z(0.8 e^{j.0.5})$	$t(0.4e^{j.0.7})$
$x(0.1 e^{j.0.3})$	$0.1 e^{i.0.3}$	$0.1 e^{i.0.3}$	$0.1 e^{j.0.3}$	$0.1 e^{j.0.3}$
$y(0.6 e^{j.0.5})$	$0.1 e^{i.0.3}$	$0.6 e^{j.0.5}$	0	$0.4e^{j.0.5}$
$z(0.8 e^{j.0.5})$	$0.1 e^{i.0.3}$	0	$0.8 e^{j.0.5}$	0
$t(0.4e^{j.0.7})$	$0.1 e^{i.0.3}$	$0.4e^{j.0.5}$	0	$0.4e^{j.0.7}$

Table 12: T^- - matrix representation of BCNG1

ξ	$x(-0.6 e^{i.-0.6})$	$y(-1 e^{i.-\pi})$	$z(-0.4 e^{i.-0.1})$	$t(-0.9e^{i.-0.1})$
$x(-0.6 e^{i.-0.6})$	$-0.6 e^{i.-0.6}$	$-1 e^{i.-\pi}$	$-0.6 e^{i.-0.6}$	$-0.9 e^{i.-0.6}$
$y(-1 e^{i.-\pi})$	$-1 e^{i.-\pi}$	$-1 e^{i.-\pi}$	0	$-1 e^{i.-\pi}$
$z(-0.4 e^{i.-0.1})$	$-0.6 e^{i.-0.6}$	0	$-0.4 e^{i.-0.1}$	0
$t(-0.9e^{i.-0.1})$	$-0.9 e^{i.-0.6}$	$-1 e^{i.-\pi}$	0	$-0.9e^{i.-0.1}$

Table 13: I^- - matrix representation of BCNG1

σ	$x(-0.4 e^{i.-2\pi})$	$y(-0.3 e^{i.0})$	$z(-0.2 e^{i.-0.3})$	$t(-0.6e^{i.-0.2})$
$x(-0.4 e^{i.-2\pi})$	$-0.4 e^{i.-2\pi}$	$-0.3e^{i.0}$	$-0.2e^{i.-2\pi}$	$-0.4e^{i.-2\pi}$
$y(-0.3e^{i.0})$	$-0.3 e^{i.0}$	$-0.3 e^{i.0}$	0	$-0.3 e^{i.0}$
$z(-0.2 e^{i.-0.3})$	$-0.2 e^{i.-2\pi}$	0	$-0.2 e^{i.-0.3}$	0
$t(-0.6e^{i.-0.2})$	$-0.4 e^{i.-2\pi}$	$-0.3 e^{i.0}$	0	$-0.6e^{i.-0.2}$

Table 14: F^- - matrix representation of BCNG1

ψ	$x(-0.2 e^{i.-2\pi})$	$y(-0.7 e^{i.-0.6})$	$z(-0.9 e^{i.-2\pi})$	$t(-0.5e^{i.-\pi})$
$x(-0.2e^{i.-2\pi})$	$-0.2 e^{i.-2\pi}$	$-0.2e^{i.-0.3}$	$-0.2 e^{i.-0.3}$	$-0.2e^{i.-0.3}$
$y(-0.7 e^{i.-0.6})$	$-0.2 e^{i.-0.3}$	$-0.7 e^{i.-0.6}$	0	$-0.5e^{i.-0.6}$
$z(-0.9 e^{i.-2\pi})$	$-0.2 e^{i.-0.3}$	0	$-0.9 e^{i.-2\pi}$	0
$t(-0.5e^{i.-\pi})$	$-0.2 e^{i.-0.3}$	$-0.3 e^{i.0}$	0	$-0.5e^{i.-\pi}$

The matrix representation of GBNG1 is shown in Table 15.

Table 15. Matrix representation of BCNG1.

$(\alpha, \beta, \delta, \xi, \sigma, \psi)$	$x < 0.5 e^{j.0.8}, 0.3 e^{j.\frac{3\pi}{4}}, 0.1 e^{j.0.3}, -0.6 e^{i.-0.6}, -0.4 e^{i.-2\pi}, -0.2 e^{i.-0.3} >$	$y < 0.9 e^{j.0.9}, 0.2 e^{j.\frac{\pi}{4}}, 0.6 e^{j.0.5}, -1 e^{i.-\pi}, -0.3 e^{i.0}, -0.7 e^{i.-0.6} >$	$z < 0.3 e^{j.0.3}, 0.1 e^{j.2\pi}, 0.8 e^{j.0.5}, -0.4 e^{i.-0.1}, -0.2 e^{i.-0.3}, -0.9 e^{i.-2\pi} >$	$t < 0.8 e^{j.0.1}, 0.5 e^{j.\pi}, 0.4 e^{j.0.7}, -0.9 e^{i.-0.1}, -0.6 e^{i.-0.2}, -0.5 e^{i.-\pi}, -0.7 e^{i.-0.6} >$
$x < 0.5 e^{j.0.8}, 0.3 e^{j.\frac{3\pi}{4}}, 0.1 e^{j.0.3}, -0.6 e^{i.-0.6}, -0.4 e^{i.-2\pi}, -0.2 e^{i.-0.3} >$	$< 0.5 e^{j.0.8}, 0.3 e^{j.\frac{3\pi}{4}}, 0.1 e^{j.0.3}, -0.6 e^{i.-0.6}, -0.4 e^{i.-2\pi}, -0.2 e^{i.-0.3} >$	$< 0.9 e^{j.0.9}, 0.2 e^{j.\frac{\pi}{4}}, 0.1 e^{j.0.5}, -1 e^{i.-\pi}, -0.3 e^{i.0}, -0.2 e^{i.-0.3} >$	$< 0.5 e^{j.0.8}, 0.1 e^{j.\frac{3\pi}{4}}, 0.1 e^{j.0.3}, -0.6 e^{i.-0.6}, -0.2 e^{i.-2\pi}, -0.2 e^{i.-0.3} >$	$< 0.8 e^{j.0.8}, 0.3 e^{j.\frac{3\pi}{4}}, 0.1 e^{j.0.3}, -0.9 e^{i.-0.6}, -0.4 e^{i.-2\pi}, -0.2 e^{i.0i.-0.3} >$
$y < 0.9 e^{j.0.9}, 0.2 e^{j.\frac{\pi}{4}}, 0.6 e^{j.0.5}, -1 e^{i.-\pi}, -0.3 e^{i.0}, -0.7 e^{i.-0.6} >$	$< 0.9 e^{j.0.9}, 0.2 e^{j.\frac{\pi}{4}}, 0.1 e^{j.0.5}, -1 e^{i.-\pi}, -0.3 e^{i.0}, -0.2 e^{i.-0.3} >$	$< 0.9 e^{j.0.9}, 0.2 e^{j.\frac{\pi}{4}}, 0.6 e^{j.0.5}, -1 e^{i.-\pi}, -0.3 e^{i.0}, -0.7 e^{i.-0.6} >$	$(0, 0, 0, 0, 0, 0)$	$< 0.9 e^{j.0.9}, 0.2 e^{j.\frac{\pi}{4}}, 0.4 e^{j.0.5}, -1 e^{i.-\pi}, -0.3 e^{i.0}, -0.5 e^{i.-0.6} >$
$z < 0.3 e^{j.0.3}, 0.1 e^{j.2\pi}, 0.8 e^{j.0.5}, -0.4 e^{i.-0.1}, -0.2 e^{i.-0.3}, -0.9 e^{i.-2\pi} >$	$< 0.5 e^{j.0.8}, 0.1 e^{j.\frac{3\pi}{4}}, 0.1 e^{j.0.3}, -0.6 e^{i.-0.6}, -0.2 e^{i.-2\pi}, -0.2 e^{i.-0.3} >$	$(0, 0, 0, 0, 0, 0)$	$z < 0.3 e^{j.0.3}, 0.1 e^{j.2\pi}, 0.8 e^{j.0.5}, -0.4 e^{i.-0.1}, -0.2 e^{i.-0.3}, -0.9 e^{i.-2\pi} >$	$(0, 0, 0, 0, 0, 0)$
$t < 0.8 e^{j.0.1}, 0.5 e^{j.\pi}, 0.4 e^{j.0.7}, -0.9 e^{i.-0.1}, -0.6 e^{i.-0.2}, -0.5 e^{i.-\pi}, -0.7 e^{i.-0.6} >$	$< 0.8 e^{j.0.8}, 0.3 e^{j.\frac{3\pi}{4}}, 0.1 e^{j.0.3}, -0.9 e^{i.-0.6}, -0.4 e^{i.-2\pi}, -0.2 e^{i.0i.-0.3} >$	$< 0.9 e^{j.0.9}, 0.2 e^{j.\frac{\pi}{4}}, 0.4 e^{j.0.5}, -1 e^{i.-\pi}, -0.3 e^{i.0}, -0.5 e^{i.-0.6} >$	$(0, 0, 0, 0, 0, 0)$	$< 0.8 e^{j.0.1}, 0.5 e^{j.\pi}, 0.4 e^{j.0.7}, -0.9 e^{i.-0.1}, -0.6 e^{i.-0.2}, -0.5 e^{i.-\pi}, -0.7 e^{i.-0.6} >$

Table 15: Matrix representation of BCNG1.

Theorem 1. Let $M_{G_l}^{T^+}$ be matrix representation of T^+ -BCNG1, then the degree of vertex $D_{T^+}(x_k) = \sum_{j=1, j \neq k}^n a_{T^+}(k+1, j+1), x_k \in V$ or $D_{T^+}(x_p) = \sum_{i=1, i \neq p}^n a_{T^+}(i+1, p+1), x_p \in V$.

Proof: It is similar as in theorem 1 of (Broumi et al., 2017b).

Theorem 2. Let $M_{G_l}^{I^+}$ be matrix representation of I^+ -BCNG1, then the degree of vertex $D_{I^+}(x_k) = \sum_{j=1, j \neq k}^n a_{I^+}(k+1, j+1), x_k \in V$ or $D_{I^+}(x_p) = \sum_{i=1, i \neq p}^n a_{I^+}(i+1, p+1), x_p \in V$.

Proof: It is similar as in theorem 1 of (Broumi et al., 2017b).

Theorem 3. Let $M_{G_l}^{F^+}$ be matrix representation of F^+ - BCNG1, then the degree of vertex

$$D_{F^+}(x_k) = \sum_{j=1, j \neq k}^n a_{F^+}(k+1, j+1), x_k \in V \text{ or}$$

$$D_{F^+}(x_p) = \sum_{i=1, i \neq p}^n a_{F^+}(i+1, p+1), x_p \in V.$$

Proof: It is similar as in theorem 1 of (Broumi et al., 2017b)

Theorem 4. Let $M_{G_l}^{T^-}$ be matrix representation of T^- - BCNG1, then the degree of vertex

$$D_{T^-}(x_k) = \sum_{j=1, j \neq k}^n a_{T^-}(k+1, j+1), x_k \in V \text{ or}$$

$$D_{T^-}(x_p) = \sum_{i=1, i \neq p}^n a_{T^-}(i+1, p+1), x_p \in V.$$

Proof: It is similar as in theorem 1 of (Broumi et al., 2017b).

Theorem 5. Let $M_{G_l}^{I^-}$ be matrix representation of I^- - BCNG1, then the degree of vertex

$$D_{I^-}(x_k) = \sum_{j=1, j \neq k}^n a_{I^-}(k+1, j+1), x_k \in V \text{ or}$$

$$D_{I^-}(x_p) = \sum_{i=1, i \neq p}^n a_{I^-}(i+1, p+1), x_p \in V.$$

Proof: It is similar as in theorem 1 of (Broumi et al., 2017b).

Theorem 6. Let $M_{G_l}^{F^-}$ be matrix representation of F^- - BCNG1, then the degree of vertex

$$D_{F^-}(x_k) = \sum_{j=1, j \neq k}^n a_{F^-}(k+1, j+1), x_k \in V \text{ or}$$

$$D_{F^-}(x_p) = \sum_{i=1, i \neq p}^n a_{F^-}(i+1, p+1), x_p \in V.$$

Proof: It is similar as in theorem 1 of (Broumi et al., 2017b)

5. CONCLUSION

In this article, we have extended the concept of complex neutrosophic graph of type 1 (CNG1) to bipolar complex neutrosophic graph of type 1(BCNG1) and presented a matrix representation of it. The concept of BCNG1 is a generalization of Generalized fuzzy graph of type 1 (GFG1), generalized bipolar neutrosophic graph of type 1 (GBNG1), generalized single valued neutrosophic graph of type 1 (GSVNG1) and complex neutrosophic graph of type 1(CNG1). This concept can be applied to the case of tri-polar neutrosophic graphs and multi-polar neutrosophic graphs. In the future works, we plan to study the concept of completeness, the concept of regularity and to define the concept of bipolar complex neutrosophic graphs of type 2.

ACKNOWLEDGMENT

The authors are very grateful to the chief editor and reviewers for their comments and suggestions, which is helpful in improving the paper.

REFERENCES.

- Ali, M., & Smarandache, F. (2015). Complex neutrosophic set. *Neural Computing and Applications*. doi:10.1007/s00521-015-2154-y.
- Atanassov, K. (1986). Intuitionistic fuzzy sets. *Fuzzy Sets and Systems*, 20, 1986, 87-96.
- Arindam, D. & Anita, P. (2012). Vertex coloring of a fuzzy graph using alpha cut. *International Journal of Management, IT and Engineering*, 2(8), 340-352.
- Arindam, D. and Anita, P. (2013). Fuzzy graph coloring technique to classify the accidental zone of a traffic control. *Annals of Pure and Applied Mathematics*, 3(2),169-178.

- Ashraf, S., Naz, S., Rashmanlou, H., & Malik, M. A. (2016). Regularity of graphs in single valued neutrosophic environment, in press
- Broumi, S., Talea, M., Bakali, A., & Smarandache, F. (2016). Single valued neutrosophic graphs. *Journal of New Theory*, 10, 86-101.
- Broumi, S., Talea, M., Smarandache, F. & Bakali, A. (2016a). Single Valued Neutrosophic Graphs: Degree, order and size. IEEE International Conference on Fuzzy Systems (FUZZ), 2444-2451.
- Broumi, S., Bakali, A., Talea, M., & Smarandache, F. (2016b). Isolated single valued neutrosophic graphs. *Neutrosophic Sets and Systems*, 11, 2016, 74-78.
- Broumi, S., Bakali, A., Talea, M., Smarandache, F. & Kishore Kumar, P. K. (2016c). A new concept of matrix algorithm for mst in undirected interval valued neutrosophic graph. Chapter in book- Neutrosophic Operational Research- Volume II-Florentin Smarandache, Mohamed Abdel-Basset and Victor Chang(Editors), 2017, pp. 54-69. ISBN 978-1-59973-537-
- Broumi, S., Smarandache, F., Talea, M. & Bakali, A. (2016d). Decision-making method based on the interval valued neutrosophic graph. *Future Technologie, IEEE*, 44-50.
- Broumi, S., Bakali, A., Talea, M., Smarandache, F. & Ali, M. (2016e). Shortest path problem under bipolar neutrosophic setting. *Applied Mechanics and Materials*, 859, 59-66.
- Broumi, S., Bakali, A., Talea, M., Smarandache, F. & Vladareanu, L.(2016f). Computation of shortest path problem in a network with sv-trapezoidal neutrosophic numbers. Proceedings of the 2016 International Conference on Advanced Mechatronic Systems, Melbourne, Australia, 417-422.
- Broumi, S., Bakali, A., Talea, M., Smarandache, F. & Vladareanu, L. (2016g). Applying Dijkstra algorithm for solving neutrosophic shortest path problem. Proceedings of the 2016 International Conference on Advanced Mechatronic Systems, Melbourne, Australia, November 30 - December 3, 412-416.
- Broumi, S., Talea, M., Bakali, A., & Smarandache, F. (2016h). On bipolar single valued neutrosophic graphs, *Journal of New Theory*, 11, 84-102.
- Broumi, S., Smarandache, F., Talea, M. & Bakali, A. (2016i). An introduction to bipolar single valued neutrosophic graph theory. *Applied Mechanics and Materials*, 841, 184-191.
- Broumi, S., Bakali, A., Talea, M., Hassan, A. & Smarandache, F. (2017). Generalized single valued neutrosophic graphs of type 1. 2017, submitted.
- Broumi, S., Bakali, A., Talea, M., & Smarandache, F.(2017a). Generalized bipolar neutrosophic graph of type 1. 2017, submitted.
- Broumi, S., Bakali, A., Talea, M., & Smarandache, F.(2017b). Complex neutrosophic graph of type 1, submitted.
- Broumi, S., Bakali, A., Talea, M., Smarandache, F., Ulucay, V., Khan, & M, Mumtaz, A. (2017c). Bipolar complex neutrosophic sets, submitted.
- Deli, I., Ali, M., & Smarandache, F. (2015). Bipolar neutrosophic sets and their application based on multi-criteria decision making problems. *Advanced Mechatronic Systems (ICAMEchS)*, 249- 254, DOI: 10.1109/ICAMEchS.2015.7287068.
- Fathi, S., Elchawalby, H. & Salama, A. A. (2016). A neutrosophic graph similarity measures, chapter in book- New Trends in Neutrosophic Theory and Applications- Florentin Smarandache and Surapati Pramanik (Editors), 223-230. ISBN 978-1-59973-498-9.
- Mehra, S. & Singh, M. (2017). Single valued neutrosophic signed graphs. *International Journal of Computer Applications*, 157(9), 31-34.
- Ramot, D., Menahem, F., Gideon, L. & Abraham, K. (2002). Complex fuzzy set. *IEEE Transactions on Fuzzy Systems*, 10 (2), 171-186. doi: 10.1109/91.995119 .
- Shannon, A., Atanassov, K. (1994). A first step to a theory of the intuitionistic fuzzy graphs. Proc. of the First Workshop on Fuzzy Based Expert Systems (D. akov, Ed.), Sofia, 59-61.
- Sharma, A.K., Padamwar, B.V., Dewangan, C. L. (2013). Trends in fuzzy graphs. *International Journal of Innovative Research in Science. Engineering and Technology*, 2(9), 4636-4640.
- Smarandache, F. (2015). Refined literal indeterminacy and the multiplication law of sub-indeterminacies. *Neutrosophic Sets and Systems*, 9, 58.63.
- Smarandache, F. (2015a). Types of Neutrosophic Graphs and neutrosophic Algebraic Structures together with their Applications in Technology, seminar, Universitatea Transilvania din Brasov, Facultatea de Design de Produsii Mediu, Brasov, Romania 06 June 2015.
- Smarandache, F. (1998). Neutrosophy. neutrosophic probability, set, and logic. ProQuest Information & Learning, Ann Arbor, Michigan, USA, 105 p., 1998; <http://fs.gallup.unm.edu/eBook-neutrosophics6.pdf> (last edition online)

- Abdel-Basset, M., Mohamed, M., Smarandache, F., & Chang, V. (2018). Neutrosophic Association Rule Mining Algorithm for Big Data Analysis. *Symmetry*, 10(4), 106.
- Abdel-Basset, M., & Mohamed, M. (2018). The Role of Single Valued Neutrosophic Sets and Rough Sets in Smart City: Imperfect and Incomplete Information Systems. *Measurement*. Volume 124, August 2018, Pages 47-55
- Abdel-Basset, M., Gunasekaran, M., Mohamed, M., & Smarandache, F. A novel method for solving the fully neutrosophic linear programming problems. *Neural Computing and Applications*, 1-11.
- Abdel-Basset, M., Manogaran, G., Gamal, A., & Smarandache, F. (2018). A hybrid approach of neutrosophic sets and DEMATEL method for developing supplier selection criteria. *Design Automation for Embedded Systems*, 1-22.
- Abdel-Basset, M., Mohamed, M., & Chang, V. (2018). NMCDA: A framework for evaluating cloud computing services. *Future Generation Computer Systems*, 86, 12-29.
- Abdel-Basset, M., Mohamed, M., Zhou, Y., & Hezam, I. (2017). Multi-criteria group decision making based on neutrosophic analytic hierarchy process. *Journal of Intelligent & Fuzzy Systems*, 33(6), 4055-4066.
- Abdel-Basset, M.; Mohamed, M.; Smarandache, F. An Extension of Neutrosophic AHP–SWOT Analysis for Strategic Planning and Decision-Making. *Symmetry* 2018, 10, 116.
- Smarandache, F. (2016). Neutrosophic overset, neutrosophic underset, Neutrosophic off set, Similarly for Neutrosophic Over-/Under-/OffLogic, Probability, and Statistic, Pons Editions, Brussels, 170p.
- Smarandache, F. (2017). Nidusidearum. Scilogs, III: Viva la Neutrosophia!, Brussels, ,134p.
- Smarandache, F. (2015). Symbolic neutrosophic theory. Europanova, asbl, Brussels, 195 p., Belgium.
- Samanta, S., Sarkar, B., Shin, D. & Pal, M. (2016). Completeness and regularity of generalized fuzzy graphs. Springer Plus. doi: 10.1186/s40064-016-3558-6.
- Turksen, I. (1986). Interval valued fuzzy sets based on normal forms. *Fuzzy Sets and Systems*, 20, 191-210.
- Wang, H., Smarandache, F., Zhang, Y., & Sunderraman, R. (2010). Single valued neutrosophic sets. *Multispace and Multistructure*, 4, 410 - 413.
- Zadeh, L. A. (1965). Fuzzy Sets. *Information and Control*, 8 (3), 338-353.

Neutrosophic Invertible Graphs of Neutrosophic Rings

T. Chalapathi¹, R. V. M. S. S. Kiran Kumar², Florentin Smarandache^{3,*}

¹Department of Mathematics, SreeVidyanikethanEng.College, Tirupati,517502,A.P, India

²Research Scholar, Department of Mathematics, S.V.University, Tirupati,517502, A.P, India

^{3,*}University of New Mexico, 705 Gurley Ave., Gallup, New Mexico 87301, USA

Emails: ^a chalapathi.tekuri@gmail.com, ^b kksaisiva@gmail.com, ^c fsmarandache@gmail.com

ABSTRACT

Let $N(R, I)$ be a Neutrosophic ring of a finite commutative classical ring R with non-zero identity. Then the Neutrosophic invertible graph of $N(R, I)$, denoted by $J_G(N(R, I))$ and defined as an undirected simple graph whose vertex set is $N(R, I)$ and two vertices $a + bI$ and $c + dI$ are adjacent in $J_G(N(R, I))$ if and only $a + bI$ is different from $-(c + dI)$ which is equivalent to $c + dI$ is different from $-(a + bI)$. We begin by considering some properties of the self and mutual additive inverse elements of finite Neutrosophic rings. We then proceed to determine several properties of Neutrosophic invertible graphs and we obtain an interrelation between classical rings, Neutrosophic rings and their Neutrosophic invertible graphs.

KEYWORDS: Classical ring, Neutrosophic ring, Neutrosophic invertible graphs, Neutrosophic Isomorphism, self and additive inverse elements.

1. INTRODUCTION

The investigation of simple undirected graphs associated to finite algebraic structures, namely, rings and fields which are very important in the theory of algebraic graphs. In recent years the interplay between Neutrosophic algebraic structure and graph structure is studied by few researchers. For such kind of study, researchers define a Neutrosophic graph whose vertices are set of elements of a Neutrosophic algebraic structure and edges are defined with respect to a well-defined condition on the pre-defined vertex set. Kandasami and Smarandache (2006) introduced the notion and structure of the Neutrosophic graphs. Also, the authors Kandasami and Smarandache (2006) and Kandasamy, Ilanthenral, & Smarandache (2015) studied the notion and structure of the Neutrosophic graphs of several finite algebraic structures and exhibited them with various examples. Later, Chalapathi and Kiran (2017a) introduced another Neutrosophic graph of a finite group and this work was specifically concerned with finite Neutrosophic multiplicative groups only.

Throughout this paper, we will write $N(R, I)$ be a finite Neutrosophic commutative ring with identity 1 and indeterminacy I . For this Neutrosophic algebraic structure, we denote $S(N(R, I))$ and $M(N(R, I))$ be the set of self and respectively mutual additive Neutrosophic inverse elements. We may construct a new type of graphs associated with Neutrosophic rings. Our primary goal is to introduce Neutrosophic invertible graphs of finite rings and to study properties of these graphs. Further, we determine the diameter of Neutrosophic invertible graphs and introduce an isomorphic relation between classical rings, Neutrosophic rings and their invertible graphs.

2. BASIC PROPERTIES OF NEUTROSOPHIC RINGS

In this section, for all terminology and notations in graph theory, classical ring theory and Neutrosophic ring theory, we refer (Vitaly & Voloshin, 2009), (Lanski, 2004). and (Agboola, Akinola, & Oyebola. (2011); Agboola, Adeleke, & Akinleye, 2012) respectively. Chalapathi and Kiran (2017b) introduced and studied self and mutual additive inverse elements of finite Neutrosophic rings and illustrated them with few examples in different cases and proposed various results regarding the characterization of the Neutrosophic rings with identity $1 \neq 0$. We will restate some of the results as follows (Chalapathi & Kiran, 2017a; 2017b).

Definition 2.1. Let $(R, +, \cdot)$ be a finite ring. The set $N(R, I) = \langle R \cup I \rangle = \{a + bI : a, b \in R\}$ is called a Neutrosophic finite ring generated by R and I , where I is the Neutrosophic element with the properties $I^2 = I, 0I = 0, I + I = 2I$ and I^{-1} does not exist.

Theorem 2.2. Let R be a finite ring with unity. Then $S(R) = R$ if and only if $S(N(R, I)) = N(R, I)$.

Theorem 2.3. Let R be a finite Boolean ring with unity. Then $S(R) = R$ and $S(N(R, I)) = N(R, I)$.

Theorem 2.4. Let R and R' be two finite commutative rings with unity. If $R \cong R'$, then $S(N(R, I)) \cong S(N(R', I))$.

Theorem 2.5. Let R and R' be two finite commutative rings with unity. Then $R \cong R'$ if and only if $N(R, I) \cong N(R', I)$.

Theorem 2.6. Let R be a finite Boolean ring with unity and $|R| > 1$. Then $4 \leq |N(R, I)| \leq |R|^2$

Proof. Since $R = \{0\}$ if and only if $N(R, I) = \{0\}$. It is clear that $R \neq \{0\}$ implies that $|R| > 1$.

Suppose $|R| = 2$. Then, obviously, $R \cong Z_2$. This implies that $N(R, I) = N(Z_2, I)$

$= \{0, 1, I, 1+I\}$, and hence $|N(R, I)| = 4$. It is one extremity of the inequality. For another extremity of the inequality, we set $R^*I = \{aI : a \in R^*\}$, $R^* + R^*I = \{a + bI : a, b \in R^*\}$ where $R^* = R - \{0\}$. These sets imply that R, R^*I and $R^* + R^*I$ are mutually non-empty disjoint subsets of $N(R, I)$. Thus, $N(R, I) = R \cup R^*I \cup (R^* + R^*I)$, and clearly the cardinality of $N(R, I)$ is $|N(R, I)| = |R| + |R^*I| + |R^* + R^*I| = |R| + (|R| - 1) + (|R| - 1)^2 = |R|^2$.

Theorem 2.7. For any finite ring R with $|R| > 1$, we have $N(R, I)$ is the disjoint union of $S(N(R, I))$ and $M(N(R, I))$.

Proof. By the definition of self and mutual additive inverse elements of the Neutrosophic ring,

$$S(N(R, I)) = \{a + bI : 2a = 0, 2b = 0\}$$

$$\text{and } M(N(R, I)) = \{c + dI : 2c \neq 0, 2d \neq 0\}.$$

Clearly, $S(N(R, I)) \cap M(N(R, I)) = \emptyset$, and thus $S(N(R, I)) \cup M(N(R, I)) = N(R, I)$.

3. NEUTROSOPHIC INVERTIBLE GRAPHS

In this section, we introduced Neutrosophic invertible graphs and characterized its structural concepts.

Definition 3.1. Let R be a finite commutative ring with identity $1 \neq 0$. A graph with its vertex set as $N(R, I)$ and two distinct vertices $a + bI$ and $c + dI$ are adjacent if and only if $a + bI$ is different from $-(c + dI)$ which is equivalent to $c + dI$ is different from $-(a + bI)$ and we denote it by $\mathcal{J}_G(N(R, I))$.

The following theorem is a consequence of the Definition [3.1].

Theorem 3.2. For each $N(R, I) \neq \{0\}$, there exist Neutrosophic invertible graph $\mathcal{J}_G(N(R, I))$.

Further, the aim of this section is to show how Neutrosophic algebraic representation of some philosophical concepts and some real world problems in the society can be modified to the study of algebraic Neutrosophic graphs. So, we shall investigate some important concrete properties of Neutrosophic invertible graphs, and also establish results of these graphs, which we required in the subsequent sections.

We begin with the algebraic graph theoretical properties of $\mathcal{J}_G(N(R, I))$, $|R| > 1$. Note that $|R| > 1$ if and only if $4 \leq |N(R, I)| \leq |R|^2$.

Theorem 3.3. The Neutrosophic invertible graph $\mathcal{J}_G(N(R, I))$ is connected.

Proof. Since $0+0I \in S(N(R, I))$ for any $N(R, I)$, $|N(R, I)| \geq 4$. So, $(a+bI)+(0+0I) = a+bI \neq 0+0I$, for any non-zero element in $a+bI$ in $S(N(R, I))$. This implies that the vertex $0+0I$ is adjacent with remaining all the vertices in $J_G(N(R, I))$. It is clear that there is a path between the vertices $0+0I$ and $a+bI$ in $J_G(N(R, I))$. Hence $J_G(N(R, I))$ is connected.

The next few results provide a characterization for all Neutrosophic rings whose invertible graphs are complete.

Theorem 3.4. The Neutrosophic invertible graph $J_G(N(R, I))$ is complete if and only if $S(N(R, I)) = N(R, I)$.

Proof. Necessity. Suppose that $J_G(N(R, I))$ is complete. Then any two vertices $a+bI$ and $c+dI$ are adjacent in $J_G(N(R, I))$. Consequently,

$$\begin{aligned} (a+bI)+(c+dI) \neq 0+0I &\Rightarrow 2(a+bI) = 0 \text{ and } 2(c+dI) = 0 \\ &\Rightarrow a+bI, c+dI \in S(N(R, I)). \end{aligned}$$

This implies that each and every element in $N(R, I)$ is an element of $S(N(R, I))$. This shows that $N(R, I) \subseteq S(N(R, I))$. Further, by the Theorem [4.2] (Chalapathi & Kiran, 2017b), $S(N(R, I))$ is a Neutrosophic subring of $N(R, I)$. So, $S(N(R, I)) \subseteq N(R, I)$. Hence, $S(N(R, I)) = N(R, I)$.

Sufficient. Let $S(N(R, I)) = N(R, I)$. Then we have to prove that $J_G(N(R, I))$ is complete. Suppose $J_G(N(R, I))$ is not complete. Then there exist at least two vertices $a'+b'I$ and $c'+d'I$ in $N(R, I)$ such that $(a'+b'I)+(c'+d'I) = 0+0I$. Therefore,

$$\begin{aligned} a'+b'I &= -(c'+d'I) \Rightarrow a'+b'I, c'+d'I \in M(N(R, I)) \\ &\Rightarrow a'+b'I, c'+d'I \notin S(N(R, I)), \text{ by the Theorem [2.7]} \end{aligned}$$

$\Rightarrow S(N(R, I)) \neq N(R, I)$, this is a contradiction to our hypothesis, and hence $J_G(N(R, I))$ is complete.

Corollary 3.5. The Neutrosophic invertible graph of $N(R, I)$ is complete if and only if $N(R, I)$ is a finite Neutrosophic Boolean ring.

Proof. In view of the Theorem [2.5] and Theorem [3.4], $N(R, I)$ is a Neutrosophic Boolean ring if and only if $S(N(R, I)) = N(R, I)$ if and only if $J_G(N(R, I))$ is complete.

Corollary 3.6. For $n \geq 1$, $J_G(N(Z_2^n, I))$ is complete.

Proof. Since $N(Z_2^n, I)$ is a Neutrosophic Boolean ring with 2^{2n} elements; $(0, 0, \dots, 0)$, $(1, 0, \dots, 0)$, \dots , $(1, 1, \dots, 1)$, $(I, 0, \dots, 0)$, \dots , (I, I, \dots, I) . Clearly, it is the vertex set of the graph $\mathcal{J}_G(N(Z_2^n, I))$, and the sum of any two vertices in $\mathcal{J}_G(N(Z_2^n, I))$ is non-zero. This implies that $S(N(Z_2^n, I)) = N(Z_2^n, I)$. So, by the Theorem [3.4], $\mathcal{J}_G(N(Z_2^n, I))$ is complete.

Example 3.7. By the definition of Neutrosophic ring, the Neutrosophic ring of Gaussian integers $N(Z_2[i], I)$ of modulo 2 is defined as $\{0, 1, i, 1+i, I, iI, (1+i)I, 1+I, i+I, (1+i)+I, (1+i)+iI, 1+iI, i+iI, i+(1+i)I, 1+(1+i)I, (1+i)+(1+i)I\}$. The Neutrosophic invertible graph of $N(Z_2[i], I)$ is a complete graph because $S(N(Z_2[i], I)) = N(Z_2[i], I)$, but it is not a Neutrosophic Boolean ring, since $(i+I)^2 \neq (i+I)$, where $i^2 = -1$ and $I^2 = I$.

The Example [3.7] explains that the completeness property of the Neutrosophic invertible graph depends on the $S(N(R, I)) = N(R, I)$, but not the Boolean property.

Theorem 3.8. The graph $\mathcal{J}_G(N(R, I))$ is not complete if and only if $S(N(R, I)) \neq N(R, I)$.

Proof. Follows from the Theorem [3.4].

Theorem 3.9. Let p be an odd prime. Then, the Neutrosophic invertible graph of a Neutrosophic field of order p^{2n} is never complete.

Proof. Let $\pi(x)$ be an irreducible polynomial of degree n over the classical field Z_p . Then, the

Neutrosophic field of order p^{2n} is isomorphic to $N\left(\frac{Z_p[x]}{\langle \pi(x) \rangle}, I\right)$. Now to show that its

invertible graph is never complete. For this let $u = \frac{p-1}{2}x + \frac{p-1}{2}xI, v = \frac{p+1}{2}x + \frac{p+1}{2}xI$ be

two vertices in $N\left(\frac{Z_p[x]}{\langle \pi(x) \rangle}, I\right)$, then clearly, $u+v = px + pxI \equiv 0 \pmod{p}$. This means that u

and v are not adjacent. Hence the proof.

Again we recall that the result $4 \leq |N(R, I)| \leq |R|^2$ for each $|R| > 1$. So the immediate results ensures that the Neutrosophic invertible graph has at least one 3-cycle when $|N(R, I)| \geq 4$.

Theorem 3.10. Let $|N(R, I)| \geq 4$. Then, $\mathcal{J}_G(N(R, I))$ has at least one cycle of length 3.

Proof. Let $N(R, I)$ be a finite Neutrosophic ring with $1 \neq 0$ and $|N(R, I)| = 4$. Then clearly $N(R, I) \cong N(Z_2, I)$, and its invertible graph has a cycle $1-I-(1+I)-1$ of length 3 because

1 $I \neq 0$, $I(1+I) \neq 0$ and $(1+I)1 \neq 0$ so in this case the result is true.

Now consider $|N(R, I)| > 4$. Then there exist the following two cases.

Case. (i) Suppose $S(N(R, I)) = N(R, I)$. Then, by the Theorem [3.4], the result is trivial.

Case. (ii) Suppose $S(N(R, I)) \neq N(R, I)$. There is at least one element $s + tI$ in $S(N(R, I))$ and $m + nI$ in $M(N(R, I))$ such that $(s + tI) + (m + nI) \neq 0$. It is clear that there is a cycle $0 - (s + tI) - (m + nI) - 0$ of length 3 in $J_G(N(R, I))$.

In the area of graph theory, a simple graph G is bipartite if its vertex set $V(G)$ can be partitioned into two disjoint subsets V_1 and V_2 such that no vertices both in V_1 or both in V_2 are connected. In 1931, the König's theorem provided by König Dénes (Dénes, 1931), it describes the relation between bipartite graph and its odd cycles.

Theorem 3.11. A simple graph is bipartite if and only if it does not have an odd length cycle.

Now we are in a position to determine precisely when $J_G(N(R, I))$ is bipartite or not. Note that $N(R, I) \cong N(Z_2, I)$ if and only if the graph $J_G(N(Z_2, I))$ is isomorphic to the complete graph K_4 of order 4. It is clear that the following result is hold in view of the Theorem [3.10].

Theorem 3.12. Every Neutrosophic invertible graph is never a bipartite graph.

Already we proved that the graph $J_G(N(R, I))$ is connected for any finite Neutrosophic ring $N(R, I)$. Therefore, $J_G(N(R, I))$ has a diameter. Now, we immediate compute the diameter of $J_G(N(R, I))$ for any $N(R, I)$ such that $4 \leq |N(R, I)| \leq |R|^2$.

Theorem 3.13. The diameter of $J_G(N(R, I))$ is at most 2.

Proof. Let $N(R, I)$ be a finite Neutrosophic ring with unity 1 and indeterminacy I . Then we consider the following two cases for finding diameter of $J_G(N(R, I))$. Note that,

$$\text{diam}(J_G(N(R, I))) = \min \{d(u, v) : u, v \in N(R, I)\},$$

where $d(u, v)$ is the length of the shortest path between the vertices u and v .

Case. (i) Suppose $S(N(R, I)) = N(R, I)$. Then, by the Theorem [3.4], $J_G(N(R, I))$ is complete, so in this case $\text{diam}(J_G(N(R, I))) = 1$.

Case. (ii) Suppose $S(N(R, I)) \neq N(R, I)$. Then, by the Theorem [3.8], $J_G(N(R, I))$ is never a complete graph. Therefore, $\text{diam}(J_G(N(R, I))) \neq 1$. This implies that $\text{diam}(J_G(N(R, I))) >$

1. So, there exist a path $(s+tI)-0-(m+nI)$ in $\mathcal{J}_G(N(R, I))$, which is smallest. Therefore, $d(s+tI, m+nI) = 2$, this implies that $\text{diam}(\mathcal{J}_G(N(R, I))) = 2$.

From case (i) and (ii) we conclude that the diameter of $\mathcal{J}_G(N(R, I))$ is at most 2 .

4.ISOMORPHIC PROPERTIES OF NEUTROSOPHIC INVERTIBLE GRAPHS

In this section, we compute an interrelation between classical rings, their Neutrosophic rings and their Neutrosophic invertible graphs. Refer the definitions of isomorphism of two classical rings, two Neutrosophic rings and two simple graphs from (Chalapathi &Kiran, (2017b).

Theorem 4.1. Let R and R' be two finite rings with unities. Then the following implications holds.

$$R \cong R' \Rightarrow N(R, I) \cong N(R', I) \Rightarrow \mathcal{J}_G(N(R, I)) \cong \mathcal{J}_G(N(R', I)).$$

Proof. The implication $R \cong R' \Rightarrow N(R, I) \cong N(R', I)$ follows from Theorem [2.4]. To complete the proof, it is enough to show that the second implication of the result. For any finite rings R and R' , suppose $N(R, I) \cong N(R', I)$. Then by the definition of Neutrosophic isomorphism, there exist a bijection f from $N(R, I)$ onto $N(R', I)$ such that $R \cong R'$ and $f(I) = I$ where $I^2 = I$. Now to show that $\mathcal{J}_G(N(R, I)) \cong \mathcal{J}_G(N(R', I))$. For this we define a map $\varphi : \mathcal{J}_G(N(R, I)) \rightarrow \mathcal{J}_G(N(R', I))$ as

$$(i). \varphi(a+bI) = f(a+bI) \text{ and}$$

$$(ii). \varphi((a+bI, c+dI)) = (f(a+bI), f(c+dI)).$$

Trivially, φ is a bijection since f is bijection. Further, we claim that each edge of $\mathcal{J}_G(N(R, I))$ with end vertices $a+bI$ and $c+dI$ is mapped to an edge in $\mathcal{J}_G(N(R', I))$ with end vertices $f(a+bI)$ and $f(c+dI)$. So, we have

$$\begin{aligned} (a+bI, c+dI) \in E(\mathcal{J}_G(N(R, I))) &\Leftrightarrow (a+bI)+(c+dI) \neq 0 \Leftrightarrow \varphi((a+bI)+(c+dI)) \neq \varphi(0) \\ &\Leftrightarrow \varphi((a+c)+(b+d)I) \neq 0 \Leftrightarrow f((a+c)+(b+d)I) \neq 0 \Leftrightarrow f((a+c))+f((b+d)I) \neq 0 \\ &\Leftrightarrow f(a)+f(c)+f(b)I+f(d)I \neq 0 \Leftrightarrow (f(a)+f(b)I)+(f(c)+f(d)I) \neq 0 \\ &\Leftrightarrow f(a+bI)+f(c+dI) \neq 0 \Leftrightarrow (f(a+bI), f(c+dI)) \in E(\mathcal{J}_G(N(R', I))). \end{aligned}$$

Similarly we can show that φ maps non-adjacent vertices in $\mathcal{J}_G(N(R, I))$ to non-adjacent vertices in $\mathcal{J}_G(N(R', I))$. Thus, φ is a graph isomorphism from $\mathcal{J}_G(N(R, I))$ onto $\mathcal{J}_G(N(R', I))$, and hence $\mathcal{J}_G(N(R, I)) \cong \mathcal{J}_G(N(R', I))$.

By the Theorem [2.4], two classical rings are isomorphic, so their Neutrosophic rings are isomorphic and consequently their Neutrosophic invertible graphs are also isomorphic, but converse of these implication, in general, not true. The next results provide such a class. First we state the following results due to isomorphism of two simple graphs. The proof of the following results is essentially contained in Bondy and Murty (2008).

Theorem 4.2. Two simple graphs G and G' are isomorphic if and only if their complement graphs \bar{G} and \bar{G}' .

Recall from Mullen and Panario (2013) that F_{p^n} is a field of order p^n and Z_{p^n} is a commutative ring of order p^n , where p is a prime and $n > 1$. Note that F_{p^n} is not isomorphic to Z_{p^n} because the characteristic of F_{p^n} is p and the characteristic of Z_{p^n} is p^n .

Theorem 4.3. Let $p > 2$ be a prime. Then the Neutrosophic invertible graphs of order p^{2n} are isomorphic.

Proof. For each odd prime p , we have $N(F_{p^n}, I)$ is a Neutrosophic field of modulo p .

$N(Z_{p^n}, I)$ is a Neutrosophic commutative ring of modulo p^n , clearly these Neutrosophic rings not isomorphic. Now it remains to show that the graphs $\mathcal{J}_G(N(F_{p^n}, I))$ and $\mathcal{J}_G(N(Z_{p^n}, I))$ are isomorphic. For this we shall show that their complement graphs are isomorphic. By the definition of complement graph,

$$\begin{aligned} \bar{\mathcal{J}}_G(N(F_{p^n}, I)) &= \left| M(N(F_{p^n}, I)) \right| K_2 \cup \left| S(N(F_{p^n}, I)) \right| K_1 \\ &= \left(\frac{p^{2n} - 1}{2} \right) K_2 \cup K_1 \cong \bar{\mathcal{J}}_G(N(Z_{p^n}, I)), \end{aligned}$$

so due to Theorem [4.2], we get the required result.

Corollary 4.4. For each $n > 1$, the Neutrosophic invertible graphs of order 2^{2n} are isomorphic.

Proof. Follows from $\mathcal{J}_G(N(F_{2^n}, I)) \cong \left| S(N(F_{2^n}, I)) \right| K_1 \cong 2^{2n} K_1 \cong N_{2^n} \cong \mathcal{J}_G(N(Z_{2^n}, I))$, where

N_{2^n} is totally disconnected graph of order 2^{2n} . It is clear that $F_{2^n} \not\cong Z_{2^n}$ and $N(F_{p^n}, I) \not\cong N(Z_{p^n}, I)$ but their Neutrosophic invertible graphs are isomorphic.

ACKNOWLEDGMENTS

The authors express their sincere thanks to Prof.L.Nagamuni Reddy and Prof.S.Vijaya Kumar Varma for his suggestions during the preparation of this paper and the referee for his suggestions. Also, we specifically thanks to Dr.Surapati Pramanik for his valuable comments and suggestions.

REFERENCES

- Abdel-Basset, M., Mohamed, M., Smarandache, F., & Chang, V. (2018). Neutrosophic Association Rule Mining Algorithm for Big Data Analysis. *Symmetry*, 10(4), 106.
- Abdel-Basset, M., & Mohamed, M. (2018). The Role of Single Valued Neutrosophic Sets and Rough Sets in Smart City: Imperfect and Incomplete Information Systems. Measurement. Volume 124, August 2018, Pages 47-55
- Abdel-Basset, M., Gunasekaran, M., Mohamed, M., & Smarandache, F. A novel method for solving the fully neutrosophic linear programming problems. *Neural Computing and Applications*, 1-11.
- Abdel-Basset, M., Manogaran, G., Gamal, A., & Smarandache, F. (2018). A hybrid approach of neutrosophic sets and DEMATEL method for developing supplier selection criteria. *Design Automation for Embedded Systems*, 1-22.
- Abdel-Basset, M., Mohamed, M., & Chang, V. (2018). NMCDA: A framework for evaluating cloud computing services. *Future Generation Computer Systems*, 86, 12-29.
- Abdel-Basset, M., Mohamed, M., Zhou, Y., & Hezam, I. (2017). Multi-criteria group decision making based on neutrosophic analytic hierarchy process. *Journal of Intelligent & Fuzzy Systems*, 33(6), 4055-4066.
- Abdel-Basset, M.; Mohamed, M.; Smarandache, F. An Extension of Neutrosophic AHP–SWOT Analysis for Strategic Planning and Decision-Making. *Symmetry* 2018, 10, 116.
- Agboola, A.A.A., Akinola, A. D., & Oyebola, O.Y. (2011). Neutrosophic rings I. *International Journal of Mathematical Combinatorics*, 4, 1-14.
- Agboola A.A.A., Adeleke E. O., & Akinleye S. A. (2012). Neutrosophic rings II. *International Journal of Mathematical Combinatorics*, 2, 1-8.
- Bondy, J.A., & Murty, U.S.R. (2008). *Graph theory*. London: Springer-Verlag.
- Chalapathi, T., & Kiran, R.V.M.S.S.K. (2017a). Neutrosophic graphs of finite groups. *Neutrosophic Sets and Systems*, 15, 26-34.
- Chalapathi, T., & Kiran, R.V.M.S.S.K. (2017b). Self additive inverse elements of neutrosophic rings and fields. *Annals of Pure and Applied Mathematics*, 13, 63-72.
- Dénes, K. (1931), Gráfok és mátrixok. *Matematikai és Fizikai Lapok*, 38: 116–119.
- Kandasamy, W. B. V., Ilanthenral, I., & Smarandache, F. (2015). *Neutrosophic graphs: A new dimension to graph theory*. Bruxelles: EuropaNova.
- Kandasamy, W. B. V., & Smarandache, F. (2006). *Some neutrosophic algebraic structures and neutrosophic N-algebraic structures*. Phoenix: Hexis.
- Lanski, C. (2004). *Concepts in abstract algebra*. Rumford, ME: American Mathematical Society.
- Mullen G.L., Panario D. (Eds). (2013). *Handbook of finite fields*. Boca Raton, FL: CRC Press.
- Vitaly, I., & Voloshin, I. (2009). *Introduction to graph theory*. New York: Nova Science Publishers, Inc.

Interval Valued Neutrosophic Soft Graphs

Said Broumi^{1,2}, Assia Bakali², Mohamed Talea³, Florentin Smarandache⁴, Faruk Karaaslan⁵

^{1,3} Laboratory of Information Processing, Faculty of Science Ben M'Sik, University Hassan II, B.P 7955, Sidi Othman, Casablanca, Morocco. E-mail: broumsaid78@gmail.com, taleamohamed@yahoo.fr

²Ecole Royale Navale-Boulevard Sour Jdid, B.P 16303 Casablanca, Morocco. E-mail: assiabakali@yahoo.fr

⁴Department of Mathematics, University of New Mexico, 705 Gurley Avenue, Gallup, NM 87301, USA. E-mail: fsmarandache@gmail.com

⁵Department of Mathematics, Faculty of Sciences, Çankırı Karatekin University, 18100, Çankırı, Turkey. E-mail: fkaraaslan@karatekin.edu.tr, karaaslan.faruk@gmail.com

ABSTRACT

In this article, we combine the interval valued neutrosophic soft set and graph theory. We introduce the notions of interval valued neutrosophic soft graphs, strong interval valued neutrosophic graphs, complete interval valued neutrosophic graphs, and investigate some of their related properties. We study some operations on interval valued neutrosophic soft graphs. We also give an application of interval valued neutrosophic soft graphs into a decision making problem. We hold forth an algorithm to solve decision making problems by using interval valued neutrosophic soft graphs.

KEYWORDS: interval valued neutrosophic soft sets, interval valued neutrosophic soft sets, interval valued neutrosophic soft graphs, strong interval valued neutrosophic soft graphs, complete interval valued neutrosophic soft graphs, decision making.

1. INTRODUCTION

The neutrosophic set (NSs), proposed by (Smarandache, 2006, 2011), is a powerful mathematical tool for dealing with incomplete, indeterminate and inconsistent information in real world. It is a generalization of the theory of fuzzy sets (Zadeh, 1965), intuitionistic fuzzy sets (Atanassov, 1986, 1999) and interval-valued intuitionistic fuzzy sets (Atanassov, 1989). The neutrosophic sets are characterized by a truth-membership function (t), an indeterminacy-membership function (i) and a falsity-membership function (f) independently, which are within the real standard or nonstandard unit interval $]0, 1^+]$. In order to conveniently employ NS in real life applications, (Wang et al., 2010) introduced the concept of single-valued neutrosophic set (SVNS), a subclass of the neutrosophic sets. The same authors (Wang, Zhang, & Sunderraman, 2005) introduced the concept of interval valued neutrosophic set (IVNS), which is more precise and flexible than single valued neutrosophic set. The IVNS is a generalization of single valued neutrosophic set, in which three membership functions are independent and their value belong to the unit interval $[0, 1]$. Some more work on single valued neutrosophic set, interval valued neutrosophic set and their applications may be found in (Aydoğdu, 2015; Ansari et al., 2012; Ansari et al. 2013; Ansari et al. 2013a; Zhang et al., 2015; Zhang et al., 2015b; Deli et al., 2015; Ye, 2014, 2014a; Şahin, 2015; Aggarwal et al., 2010; Broumi and Smarandache, 2014; Karaaslan and Davvaz, 2018).

Graph theory has now become a major branch of applied mathematics and it is generally regarded as a branch of combinatorics. Graph is a widely used tool for solving a combinatorial problem in different areas, such as geometry, algebra, number theory, topology, optimization and computer science. Most important thing to be noted is that, when we have uncertainty regarding either the set of vertices or edges, or both, the model becomes a fuzzy graph. The extension of fuzzy graph theory (Nagoor and Basheer, 2003; Nagoor & Latha, 2012; Bhattacharya, 1987) have been developed by several researchers. Intuitionistic fuzzy graphs

(Nagoor & Shajitha, 2010; Akram, 2012) considered the vertex sets and edge sets as intuitionistic fuzzy sets. Interval valued fuzzy graphs (Akram & Dudek, 2011; Akram, 2012a) considered the vertex sets and edge sets as interval valued fuzzy sets. Interval valued intuitionistic fuzzy graphs (Akram, 2014; Hai-Long et al., 2016) considered the vertex sets and edge sets as interval valued intuitionistic fuzzy sets. Bipolar fuzzy graphs (Akram, 2011, 2013) considered the vertex sets and edge sets as bipolar fuzzy sets. M-polar fuzzy graphs (Akram, 2016) considered the vertex sets and edge sets as m-polar fuzzy sets. But, when the relations between nodes (or vertices) in problems are indeterminate, the fuzzy graphs and their extensions fail. For this purpose, (Smarandache, 2015, 2015a, 2015b; Vasantha and Smarandache, 2013) defined four main categories of neutrosophic graphs. Two of them are based on literal indeterminacy (I), which are called I-edge neutrosophic graph and I-vertex neutrosophic graph; these concepts are studied deeply and gained popularity among the researchers due to their applications via real world problems (Devadoss et al., 2013, Jiang et al., 2010; Vasantha et al., 2015) The two others graphs are based on (t, i, f) components and are called: (t, i, f)-edge neutrosophic graph and (t, i, f)-vertex neutrosophic graph; these concepts are not developed at all.

Later on, (Broumi et al., 2016a) introduced a third neutrosophic graph model, and investigated some of its properties. This model allows the attachment of truth-membership (t), indeterminacy-membership (i) and falsity-membership degrees (f) both to vertices and edges. The third neutrosophic graph model is called single valued neutrosophic graph (SVNG for short). The single valued neutrosophic graph is the generalization of fuzzy graph and intuitionistic fuzzy graph. Also, the same authors (Broumi et al., 2016a, 2016e) introduced neighborhood degree of a vertex and closed neighborhood degree of a vertex in single valued neutrosophic graph as a generalization of neighborhood degree of a vertex and closed neighborhood degree of a vertex in fuzzy graph and intuitionistic fuzzy graph. Also, (Broumi et al., 2016b) introduced the concept of interval valued neutrosophic graph as a generalization of fuzzy graph, intuitionistic fuzzy graph, interval valued fuzzy graph, interval valued intuitionistic fuzzy graph and single valued neutrosophic graph, and have discussed some of their properties with proofs and examples. In addition, (Broumi et al., 2016c) have introduced some operations, such as Cartesian product, composition, union and join on interval valued neutrosophic graphs, and investigate some their properties. On the other hand, (Broumi et al., 2016d) discussed a subclass of interval valued neutrosophic graph, called strong interval valued neutrosophic graph, and introduced some operations such as, Cartesian product, composition and join of two strong interval valued neutrosophic graph with proofs. Interval valued neutrosophic soft sets are the generalization of fuzzy soft sets (Maji, 2001), intuitionistic fuzzy soft sets (Maji, 2001a), interval valued intuitionistic fuzzy soft sets (Jiang, et al., 2010) and (Maji, 2013). (Thumbakara and George, 2014) combined the concept of soft set theory with graph theory. (Irfan et al, 2016) proposed a method to represent a graph, which is based on adjacency of vertices and soft set theory and introduced some operations such as restricted intersection, restricted union, extended intersection and extended union for graphs. In addition, the authors defined a metric to find distances between graphs represented by soft sets. Later on, Mohinta (2015) extended the concept of soft graph to the case of fuzzy soft graph. Also, Akram et al. (2015) studied more properties on fuzzy soft graphs and some operations. Shahzadi and Akram (2016) presented different types of new concepts, including intuitionistic fuzzy soft graphs, complete intuitionistic fuzzy soft graph, strong intuitionistic fuzzy soft graph and self-complement of intuitionistic fuzzy soft graph. And described various methods of their

construction, and investigated some of their related properties and discussed the applications of intuitionistic fuzzy soft graphs in communication network and decision making.

Recently, the notion of neutrosophic soft set has been extended in the graph theory and the concept of neutrosophic soft graph was provided by (Shah and Hussain, 2016) Later on, Shahzadi and Akram (2016) have applied the concept of neutrosophic soft sets to graphs and discussed various methods of construction of neutrosophic soft graphs. In the literature, the study of interval valued neutrosophic soft graphs (IVNS-graph) is still blank.

In the present paper, interval valued neutrosophic soft sets (Deli, 2015). are employed to study graphs and give rise to a new class of graphs called interval valued neutrosophic soft graphs. We have discussed different operations defined on neutrosophic soft graphs such as Cartesian product, composition, union and join with examples and proofs. The concepts of strong interval valued neutrosophic soft graphs, complete interval valued neutrosophic soft graphs and the complement of strong interval valued neutrosophic soft graphs a real so discussed. Interval valued neutrosophic soft graphs are pictorial representation in which each vertex and each edge is an element of interval valued neutrosophic soft sets.

This paper is organized as follows. In section 2, we give all the basic definitions related to interval valued neutrosophic graphs and interval valued neutrosophic soft sets which will be employed in later sections. In section 3, we introduce certain notions including interval valued neutrosophic soft graphs, strong interval valued neutrosophic soft graphs, complete interval valued neutrosophic soft graphs, the complement of strong interval valued neutrosophic soft graphs, and illustrate these notions by several examples, then we present some operations such as Cartesian product, composition, intersection, union and join on an interval valued neutrosophic soft graphs and investigate some of their related properties. In section 4, we present an application of interval valued neutrosophic soft graphs in decision making.

2. PRELIMINARIES

In this section, we mainly recall some notions related to neutrosophic sets, single valued neutrosophic sets, interval valued neutrosophic sets, neutrosophic soft sets, interval valued, soft sets, neutrosophic soft sets, single valued neutrosophic graphs, fuzzy graph, intuitionistic fuzzy graph, interval valued intuitionistic fuzzy graphs and interval valued neutrosophic graphs, relevant to the present work. See especially (Mohamed et al, 2014; Nagoor and Basheer, 2003; Nagoor and Shajitha2010; Molodtsov, 1999; Smarandache, 2006; Wang et al., 2005; Wang et al., 2010; Deli, 2015; Broumi et al., 2016a, 2016b) for further details and background.

Definition 2.1 (Smarandache, 2006). Let X be a space of points (objects) with generic elements in X denoted by x ; then the neutrosophic set A (NS A) is an object having the form $A = \{< x: T_A(x), I_A(x), F_A(x)>, x \in X\}$, where the functions $T, I, F: X \rightarrow]^{-}0, 1^{+}[$ define respectively the a truth-membership function, an indeterminacy-membership function, and a falsity-membership function of the element $x \in X$ to the set A , with the condition:

$$^{-}0 \leq T_A(x) + I_A(x) + F_A(x) \leq 3^{+}. \quad (1)$$

The functions $T_A(x)$, $I_A(x)$ and $F_A(x)$ are real standard or nonstandard subsets of $]^{-}0, 1^{+}[$.

Since it is difficult to apply NSs to practical problems, (Wang et al., 2010). introduced the concept of a SVNS, which is an instance of a NS and can be used in real scientific and engineering applications.

Definition 2.2 (Wang et al., 2010). Let X be a space of points (objects) with generic elements in X denoted by x . A single valued neutrosophic set A (SVNS A) is characterized by truth-membership function $T_A(x)$, an indeterminacy-membership function $I_A(x)$, and a falsity-membership function $F_A(x)$. For each point x in X $T_A(x), I_A(x), F_A(x) \in [0, 1]$. A SVNS A can be written as

$$A = \{ \langle x: T_A(x), I_A(x), F_A(x) \rangle, x \in X \}. \tag{2}$$

Definition 2.3 (Nagoor and Basheer, 2003) A fuzzy graph is a pair of functions $G = (\sigma, \mu)$ where σ is a fuzzy subset of a non-empty set V and μ is a symmetric fuzzy relation on σ . i.e. $\sigma: V \rightarrow [0, 1]$ and $\mu: V \times V \rightarrow [0, 1]$ such that $\mu(uv) \leq \sigma(u) \wedge \sigma(v)$ for all $u, v \in V$, where uv denotes the edge between u and v and $\sigma(u) \wedge \sigma(v)$ denotes the minimum of $\sigma(u)$ and $\sigma(v)$. σ is called the fuzzy vertex set of V and μ is called the fuzzy edge set of E .

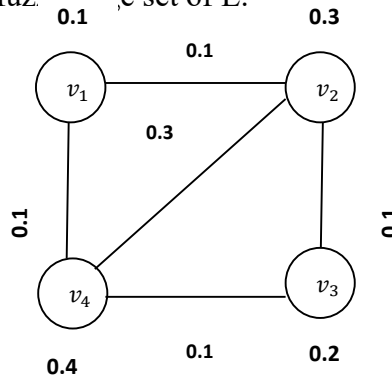

Fig.1: Fuzzy Graph

Definition 2.4 (Nagoor and Basheer, 2003) The fuzzy subgraph $H = (\tau, \rho)$ is called a fuzzy subgraph of $G = (\sigma, \mu)$

If $\tau(u) \leq \sigma(u)$ for all $u \in V$ and $\rho(u, v) \leq \mu(u, v)$ for all $u, v \in V$.

Definition 2.5 (Nagoor and Shajitha 2010) An Intuitionistic fuzzy graph is of the form $G = (V, E)$ where:

- i. $V = \{v_1, v_2, \dots, v_n\}$ such that $\mu_1: V \rightarrow [0, 1]$ and $\gamma_1: V \rightarrow [0, 1]$ denote the degree of membership and non-membership of the element $v_i \in V$, respectively, and $0 \leq \mu_1(v_i) + \gamma_1(v_i) \leq 1$ for every $v_i \in V, (i=1, 2, \dots, n)$,
- ii. $E \subseteq V \times V$ where $\mu_2: V \times V \rightarrow [0, 1]$ and $\gamma_2: V \times V \rightarrow [0, 1]$ are such that $\mu_2(v_i, v_j) \leq \min[\mu_1(v_i), \mu_1(v_j)]$ and $\gamma_2(v_i, v_j) \geq \max[\gamma_1(v_i), \gamma_1(v_j)]$ and $0 \leq \mu_2(v_i, v_j) + \gamma_2(v_i, v_j) \leq 1$ for every $(v_i, v_j) \in E, (i, j = 1, 2, \dots, n)$

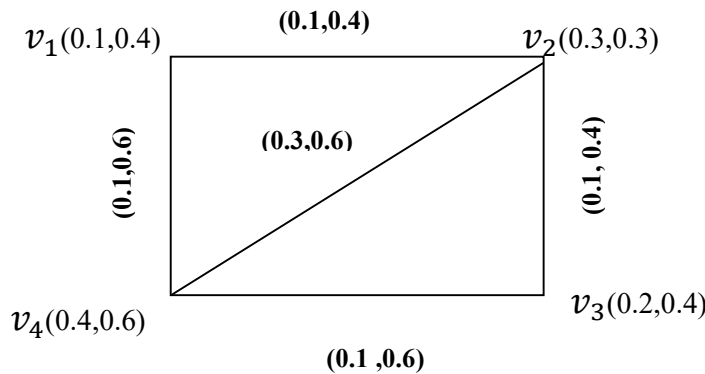

Fig.2: Intuitionistic Fuzzy Graph

Definition 2.6 (Broumi et al., 2016a). Let $A = (T_A, I_A, F_A)$ and $B = (T_B, I_B, F_B)$ be single valued neutrosophic sets on a set X . If $A = (T_A, I_A, F_A)$ is a single valued neutrosophic relation on a set X , then $A = (T_A, I_A, F_A)$ is called a single valued neutrosophic relation on $B = (T_B, I_B, F_B)$ if

$$\begin{aligned} T_B(x, y) &\leq \min(T_A(x), T_A(y)) \\ I_B(x, y) &\geq \max(I_A(x), I_A(y)) \text{ and} \\ F_B(x, y) &\geq \max(F_A(x), F_A(y)) \text{ for all } x, y \in X. \end{aligned}$$

A single valued neutrosophic relation A on X is called symmetric if $T_A(x, y) = T_A(y, x)$, $I_A(x, y) = I_A(y, x)$, $F_A(x, y) = F_A(y, x)$ and $T_B(x, y) = T_B(y, x)$, $I_B(x, y) = I_B(y, x)$ and $F_B(x, y) = F_B(y, x)$, for all $x, y \in X$.

Definition 2.7 (Broumi et al., 2016a). A single valued neutrosophic graph (SVN-graph) with underlying set V is defined to be a pair $G = (A, B)$ where:

1. The functions $T_A: V \rightarrow [0, 1]$, $I_A: V \rightarrow [0, 1]$ and $F_A: V \rightarrow [0, 1]$ denote the degree of truth-membership, degree of indeterminacy-membership and falsity-membership of the element $v_i \in V$, respectively, and

$$0 \leq T_A(v_i) + I_A(v_i) + F_A(v_i) \leq 3 \text{ for all } v_i \in V (i=1, 2, \dots, n)$$

2. The functions $T_B: E \subseteq V \times V \rightarrow [0, 1]$, $I_B: E \subseteq V \times V \rightarrow [0, 1]$ and $F_B: E \subseteq V \times V \rightarrow [0, 1]$ are defined by

$$\begin{aligned} T_B(\{v_i, v_j\}) &\leq \min [T_A(v_i), T_A(v_j)], \\ I_B(\{v_i, v_j\}) &\geq \max [I_A(v_i), I_A(v_j)], \text{ and} \\ F_B(\{v_i, v_j\}) &\geq \max [F_A(v_i), F_A(v_j)], \end{aligned}$$

Denoting the degree of truth-membership, indeterminacy-membership and falsity-membership of the edge $(v_i, v_j) \in E$ respectively, where:

$$0 \leq T_B(\{v_i, v_j\}) + I_B(\{v_i, v_j\}) + F_B(\{v_i, v_j\}) \leq 3 \text{ for all } \{v_i, v_j\} \in E (i, j = 1, 2, \dots, n)$$

We call A the single valued neutrosophic vertex set of V , B the single valued neutrosophic edge set of E , respectively. Note that B is a symmetric single valued neutrosophic relation on A . We use the notation (v_i, v_j) for an element of E . Thus, $G = (A, B)$ is a single valued neutrosophic graph of $G^* = (V, E)$ if:

$$\begin{aligned} T_B(v_i, v_j) &\leq \min [T_A(v_i), T_A(v_j)], \\ I_B(v_i, v_j) &\geq \max [I_A(v_i), I_A(v_j)] \text{ and} \\ F_B(v_i, v_j) &\geq \max [F_A(v_i), F_A(v_j)], \text{ for all } (v_i, v_j) \in E. \end{aligned}$$

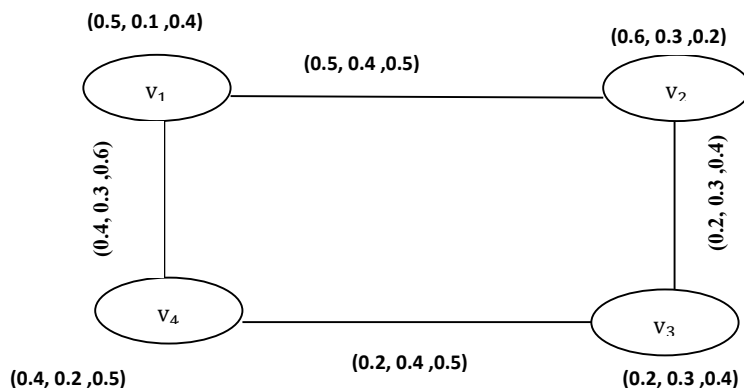

Fig.3: Single valued neutrosophic graph

Definition 2.9 (Broumi et al., 2016a). A partial SVN-subgraph of SVN-graph $G = (A, B)$ is a SVN-graph $H = (V', E')$ such that

- (i) $V' \subseteq V$, where $T'_A(v_i) \leq T_A(v_i)$, $I'_A(v_i) \geq I_A(v_i)$, $F'_A(v_i) \geq F_A(v_i)$, for all $v_i \in V$.
- (ii) $E' \subseteq E$, where $T'_B(v_i, v_j) \leq T_B(v_i, v_j)$, $I'_{Bij} \geq I_B(v_i, v_j)$, $F'_{Bij} \geq F_B(v_i, v_j)$

$F_B(v_i, v_j)$, for all $(v_i v_j) \in E$.

Definition 2.10 (Broumi et al., 2016a). ASVN-subgraph of SVN-graph $G = (V, E)$ is a SVN-graph $H = (V', E')$ such that

- (i) $V' = V$, where $T'_A(v_i) = T_A(v_i), I'_A(v_i) = I_A(v_i), F'_A(v_i) = F_A(v_i)$ for all v_i in the vertex set of V' .
- (ii) $E' = E$, where $T'_B(v_i, v_j) = T_B(v_i, v_j), I'_B(v_i, v_j) = I_B(v_i, v_j), F'_B(v_i, v_j) = F_B(v_i, v_j)$ for every $(v_i v_j) \in E$ in the edge set of E' .

Definition 2.10 (Broumi et al., 2016a). Let $G = (A, B)$ be a single valued neutrosophic graph. Then the degree of any vertex v is sum of degree of truth-membership, sum of degree of indeterminacy-membership and sum of degree of falsity-membership of all those edges which are incident on vertex v denoted by $d(v) = (d_T(v), d_I(v), d_F(v))$ where:

$d_T(v) = \sum_{u \neq v} T_B(u, v)$ denotes degree of truth-membership vertex.

$d_I(v) = \sum_{u \neq v} I_B(u, v)$ denotes degree of indeterminacy-membership vertex.

$d_F(v) = \sum_{u \neq v} F_B(u, v)$ denotes degree of falsity-membership vertex.

Definition 2.11 (Broumi et al., 2016a). A single valued neutrosophic graph $G = (A, B)$ of $G^* = (V, E)$ is called strong single valued neutrosophic graph if:

$$T_B(v_i, v_j) = \min [T_A(v_i), T_A(v_j)]$$

$$I_B(v_i, v_j) = \max [I_A(v_i), I_A(v_j)]$$

$$F_B(v_i, v_j) = \max [F_A(v_i), F_A(v_j)], \text{ for all } (v_i, v_j) \in E.$$

Definition 2.12 (Broumi et al., 2016a). A single valued neutrosophic graph $G = (A, B)$ is called complete if

$$T_B(v_i, v_j) = \min [T_A(v_i), T_A(v_j)]$$

$$I_B(v_i, v_j) = \max [I_A(v_i), I_A(v_j)]$$

$$F_B(v_i, v_j) = \max [F_A(v_i), F_A(v_j)], \text{ for all } v_i, v_j \in V.$$

Definition 2.13 (Broumi et al., 2016a) The complement of a single valued neutrosophic graph $G = (A, B)$ on G^* is a single valued neutrosophic graph \bar{G} on G^* where:

$$1. \bar{A} = A$$

$$2. \bar{T}_A(v_i) = T_A(v_i), \bar{I}_A(v_i) = I_A(v_i), \bar{F}_A(v_i) = F_A(v_i), \text{ for all } v_i \in V.$$

$$3. \bar{T}_B(v_i, v_j) = \min [T_A(v_i), T_A(v_j)] - T_B(v_i, v_j)$$

$$\bar{I}_B(v_i, v_j) = \max [I_A(v_i), I_A(v_j)] - I_B(v_i, v_j) \text{ and}$$

$$\bar{F}_B(v_i, v_j) = \max [F_A(v_i), F_A(v_j)] - F_B(v_i, v_j), \text{ for all } (v_i, v_j) \in E.$$

Definition 2.14 (Mohamed et al, 2014). An interval valued intuitionistic fuzzy graph with underlying set V is defined to be a pair $G = (A, B)$ where

1) The functions $M_A : V \rightarrow D [0, 1]$ and $N_A : V \rightarrow D [0, 1]$ denote the degree of membership and non-membership of the element $x \in V$, respectively, such that $0 \leq M_A(x) + N_A(x) \leq 1$ for all $x \in V$.

2) The functions $M_B : E \subseteq V \times V \rightarrow D [0, 1]$ and $N_B : E \subseteq V \times V \rightarrow D [0, 1]$ are defined by

$$M_{BL}(x, y) \leq \min (M_{AL}(x), M_{AL}(y)) \text{ and } N_{BL}(x, y) \geq \max (N_{AL}(x), N_{AL}(y))$$

$$M_{BU}(x, y) \leq \min (M_{AU}(x), M_{AU}(y)) \text{ and } N_{BU}(x, y) \geq \max (N_{AU}(x), N_{AU}(y)),$$

such that

$$0 \leq M_{BU}(x, y) + N_{BU}(x, y) \leq 1 \text{ for all } (x, y) \in E.$$

Définition 2.15 (Broumi et al., 2016b). By an interval-valued neutrosophic graph of a graph $G^* = (V, E)$ we mean a pair $G = (A, B)$, where $A = \langle [T_{AL}, T_{AU}], [I_{AL}, I_{AU}], [F_{AL}, F_{AU}] \rangle$ is an interval-valued neutrosophic set on V and $B = \langle [T_{BL}, T_{BU}], [I_{BL}, I_{BU}], [F_{BL}, F_{BU}] \rangle$ is an interval-valued neutrosophic relation on E satisfies the following condition:

1. $V = \{v_1, v_2, \dots, v_n\}$ such that $T_{AL}: V \rightarrow [0, 1], T_{AU}: V \rightarrow [0, 1], I_{AL}: V \rightarrow [0, 1], I_{AU}: V \rightarrow [0, 1]$ and $F_{AL}: V \rightarrow [0, 1], F_{AU}: V \rightarrow [0, 1]$ denote the degree of truth-membership, the degree of indeterminacy-membership and falsity-membership of the element $y \in V$, respectively, and $0 \leq T_A(v_i) + I_A(v_i) + F_A(v_i) \leq 3$ for all $v_i \in V$ ($i=1, 2, \dots, n$).
2. The functions $T_{BL}: V \times V \rightarrow [0, 1], T_{BU}: V \times V \rightarrow [0, 1], I_{BL}: V \times V \rightarrow [0, 1], I_{BU}: V \times V \rightarrow [0, 1]$ and $F_{BL}: V \times V \rightarrow [0, 1], F_{BU}: V \times V \rightarrow [0, 1]$ are such that:

$$T_{BL}(\{v_i, v_j\}) \leq \min [T_{AL}(v_i), T_{AL}(v_j)]$$

$$T_{BU}(\{v_i, v_j\}) \leq \min [T_{AU}(v_i), T_{AU}(v_j)]$$

$$I_{BL}(\{v_i, v_j\}) \geq \max [I_{BL}(v_i), I_{BL}(v_j)]$$

$$I_{BU}(\{v_i, v_j\}) \geq \max [I_{BU}(v_i), I_{BU}(v_j)]$$

$$F_{BL}(\{v_i, v_j\}) \geq \max [F_{BL}(v_i), F_{BL}(v_j)]$$

$$F_{BU}(\{v_i, v_j\}) \geq \max [F_{BU}(v_i), F_{BU}(v_j)],$$

Denoting the degree of truth-membership, indeterminacy-membership and falsity-membership of the edge $(v_i, v_j) \in E$ respectively, where

$$0 \leq T_B(\{v_i, v_j\}) + I_B(\{v_i, v_j\}) + F_B(\{v_i, v_j\}) \leq 3 \text{ for all } \{v_i, v_j\} \in E \text{ (i, j = 1, 2, \dots, n)}.$$

they call A the interval valued neutrosophic vertex set of V , B the interval valued neutrosophic edge set of E , respectively, Note that B is a symmetric interval valued neutrosophic relation on A . We use the notation (v_i, v_j) for an element of E . Thus, $G = (A, B)$ is an interval valued neutrosophic graph of $G^* = (V, E)$ if

$$T_{BL}(v_i, v_j) \leq \min [T_{AL}(v_i), T_{AL}(v_j)]$$

$$\begin{aligned}
 T_{BU}(v_i, v_j) &\leq \min [T_{AU}(v_i), T_{AU}(v_j)] \\
 I_{BL}(v_i, v_j) &\geq \max [I_{BL}(v_i), I_{BL}(v_j)] \\
 I_{BU}(v_i, v_j) &\geq \max [I_{BU}(v_i), I_{BU}(v_j)] \text{ And} \\
 F_{BL}(v_i, v_j) &\geq \max [F_{BL}(v_i), F_{BL}(v_j)] \\
 F_{BU}(v_i, v_j) &\geq \max [F_{BU}(v_i), F_{BU}(v_j)], \text{ for all } (v_i, v_j) \in E.
 \end{aligned}$$

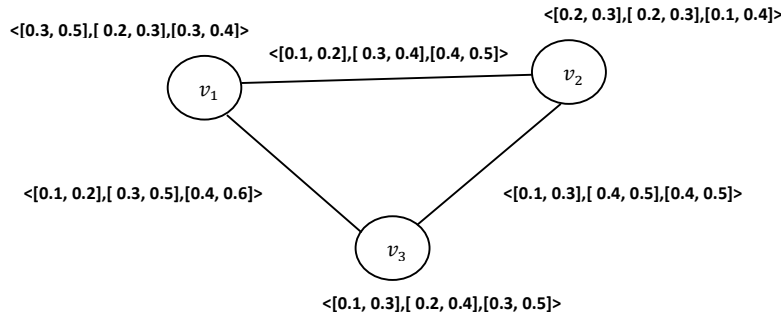

Fig. 4: G : Interval valued neutrosophic graph.

Definition 2.16 (Molodtsov, 1999). Let U be an initial universe set and E be a set of parameters. Let $P(U)$ denotes the power set of U . Consider a nonempty set A , $A \subset E$. A pair (K, A) is called a soft set over U , where K is a mapping given by $K: A \rightarrow P(U)$.

As an illustration, let us consider the following example.

Example 2. Suppose that U is the set of houses under consideration, say $U = \{h_1, h_2, \dots, h_5\}$. Let E be the set of some attributes of such houses, say $E = \{e_1, e_2, \dots, e_5\}$, where e_1, e_2, \dots, e_5 stand for the attributes “beautiful”, “costly”, “in the green surroundings”, “moderate”, respectively.

In this case, to define a soft set means to point out expensive houses, beautiful houses, and so on. For example, the soft set (K, A) that describes the “attractiveness of the houses” in the opinion of a buyer, say Thomas, may be defined like this:

$$\begin{aligned}
 A &= \{e_1, e_2, e_3, e_4, e_5\}; \\
 K(e_1) &= \{h_2, h_3, h_5\}, K(e_2) = \{h_2, h_4\}, K(e_3) = \{h_1\}, K(e_4) = U, K(e_5) = \{h_3, h_5\}.
 \end{aligned}$$

Definition 2.17 (Wang et al., 2005). Let $IVNS(X)$ denote the family of all the interval valued neutrosophic sets in universe X , assume $A, B \in IVNS(X)$ such that

$$\begin{aligned}
 A &= \{ \langle x, [T_A^L(x), T_A^U(x)], [I_A^L(x), I_A^U(x)], [F_A^L(x), F_A^U(x)] \rangle : x \in X \} \\
 B &= \{ \langle x, [T_B^L(x), T_B^U(x)], [I_B^L(x), I_B^U(x)], [F_B^L(x), F_B^U(x)] \rangle : x \in X \}
 \end{aligned}$$

then some operations can be defined as follows:

- (1) $A \cup B = \{ \langle x, [\max\{T_A^L(x), T_B^L(x)\}, \max\{T_A^U(x), T_B^U(x)\}], [\min\{I_A^L(x), I_B^L(x)\}, \min\{I_A^U(x), I_B^U(x)\}], [\min\{F_A^L(x), F_B^L(x)\}, \min\{F_A^U(x), F_B^U(x)\}] \rangle : x \in X \}$;
- (2) $A \cap B = \{ \langle x, [\min\{T_A^L(x), T_B^L(x)\}, \min\{T_A^U(x), T_B^U(x)\}], [\max\{I_A^L(x), I_B^L(x)\}, \max\{I_A^U(x), I_B^U(x)\}], [\max\{F_A^L(x), F_B^L(x)\}, \max\{F_A^U(x), F_B^U(x)\}] \rangle : x \in X \}$;

$$[\max\{I_A^L(x), I_B^L(x)\}, \max\{I_A^U(x), I_B^U(x)\}], [\max\{F_A^L(x), F_B^L(x)\}, \max\{F_A^U(x), F_B^U(x)\}]: x \in X];$$

(3) $A^c = \{ \langle x, [F_A^L(x), F_A^U(x)], [1 - I_A^U(x), 1 - I_A^L(x)], [T_A^L(x), T_A^U(x)] \rangle : x \in X \};$

(4) $A \subseteq B$, iff $T_A^L(x) \leq T_B^L(x)$, $T_A^U(x) \leq T_B^U(x)$, $I_A^L(x) \geq I_B^L(x)$, $I_A^U(x) \geq I_B^U(x)$ and $F_A^L(x) \geq F_B^L(x)$, $F_A^U(x) \geq F_B^U(x)$ for all $x \in X$.

$A = B$, iff $A \subseteq B$ and $B \subseteq A$.

As an illustration, let us consider the following example.

Example 2.18. Assume that the universe of discourse $U = \{x_1, x_2, x_3, x_4\}$. Then, A is an interval valued neutrosophic set (IVNS) of U such that:

$$A = \{ \langle x_1, [0.1, 0.8], [0.2, 0.6], [0.8, 0.9] \rangle, \langle x_2, [0.2, 0.5], [0.3, 0.5], [0.6, 0.8] \rangle, \langle x_3, [0.5, 0.8], [0.4, 0.5], [0.5, 0.6] \rangle, \langle x_4, [0.1, 0.4], [0.1, 0.5], [0.4, 0.8] \rangle \}.$$

Definition 2.19 (Deli et al., 2015). Let U be an initial universe set and $A \subset E$ be a set of parameters. Let IVNS (U) denote the set of all interval valued neutrosophic subsets of U . The collection (K, A) is termed to be the soft interval valued neutrosophic set over U , where K is a mapping given by $K: A \rightarrow IVNS(U)$.

The interval valued neutrosophic soft set defined over a universe is denoted by INSS. Here,

1. Y is an ivn-soft subset of Ψ , denoted by $Y \Subset \Psi$, if $K(e) \subseteq L(e)$ for all $e \in E$.
2. Y is an ivn-soft equals to Ψ , denoted by $Y = \Psi$, if $K(e) = L(e)$ for all $e \in E$.
3. The complement of Y is denoted by Y^c , and is defined by $Y^c = \{ \langle x, K^o(x) \rangle : x \in E \}$
4. The union of Y and Ψ is denoted by $Y \cup \Psi$, if $K(e) \cup L(e)$ for all $e \in E$.
5. The intersection of Y and Ψ is denoted by $Y \cap \Psi$, if $K(e) \cap L(e)$ for all $e \in E$.

To illustrate let us consider the following example:

Let U be the set of houses under consideration and E is the set of parameters (or qualities). Each parameter is an interval valued neutrosophic word or sentence involving interval valued neutrosophic words. Consider $E = \{ \text{beautiful, costly, in the green surroundings, moderate, expensive} \}$. In this case, to define an interval valued neutrosophic soft set means to point out beautiful houses, costly houses, and so on.

Suppose that there are five houses in the universe U , given by $U = \{h_1, h_2, h_3, h_4, h_5\}$ and the set of parameters $A = \{e_1, e_2, e_3, e_4\}$, where each e_i is a specific criterion for houses:

- e_1 stands for ‘beautiful’,
- e_2 stands for ‘costly’,
- e_3 stands for ‘in the green surroundings’,
- e_4 stands for ‘moderate’.

Suppose that,

$$K(\text{beautiful}) = \{ \langle h_1, [0.5, 0.6], [0.6, 0.7], [0.3, 0.4] \rangle, \langle h_2, [0.4, 0.5], [0.7, 0.8], [0.2, 0.3] \rangle, \langle h_3, [0.6, 0.7], [0.2, 0.3], [0.3, 0.5] \rangle, \langle h_4, [0.7, 0.8], [0.3, 0.4], [0.2, 0.4] \rangle, \langle h_5, [0.8, 0.4], [0.2, 0.6], [0.3, 0.4] \rangle \}.$$

$$K(\text{costly}) = \{ \langle h_1, [0.5, 0.6], [0.3, 0.7], [0.1, 0.4] \rangle, \langle h_2, [0.3, 0.5], [0.6, 0.8], [0.1, 0.3] \rangle, \langle h_3, [0.3, 0.5], [0.2, 0.6], [0.3, 0.4] \rangle, \langle h_4, [0.2, 0.5], [0.1, 0.2], [0.2, 0.4] \rangle, \langle h_5, [0.2, 0.4], [0.1, 0.5], [0.1, 0.5] \rangle \}.$$

0.4] > }.

$K(\text{in the green surroundings}) = \{ \langle h_1, [0.5, 0.6], [0.6, 0.7], [0.3, 0.4] \rangle, \langle h_2, [0.4, 0.5], [0.7, 0.8], [0.2, 0.5] \rangle, \langle h_3, [0.2, 0.4], [0.2, 0.3], [0.3, 0.5] \rangle, \langle h_4, [0.7, 0.8], [0.3, 0.4], [0.2, 0.4] \rangle, \langle h_5, [0.8, 0.4], [0.2, 0.6], [0.2, 0.3] \rangle \}$,

$K(\text{moderate}) = \{ \langle h_1, [0.1, 0.6], [0.6, 0.7], [0.3, 0.4] \rangle, \langle h_2, [0.2, 0.5], [0.4, 0.8], [0.2, 0.4] \rangle, \langle h_3, [0.3, 0.7], [0.2, 0.4], [0.2, 0.5] \rangle, \langle h_4, [0.7, 0.8], [0.3, 0.4], [0.1, 0.2] \rangle, \langle h_5, [0.3, 0.4], [0.2, 0.6], [0.1, 0.2] \rangle \}$.

3. INTERVAL VALUED NEUTROSOPHIC SOFT GRAPHS

Let U be an initial universe and P the set of all parameters, $P(U)$ denoting the set of all interval neutrosophic sets of U . Let A be a subset of P . A pair (K, A) is called an interval valued neutrosophic soft set over U . Let $P(V)$ denote the set of all interval valued neutrosophic sets of V and $P(E)$ denote the set of all interval valued neutrosophic sets of E .

Definition 3.1 An interval valued neutrosophics of the graph $G=(G^*,K, M,A)$ is a 4-tuple such that

- a) $G^*=(V, E)$ is a simple graph,
- b) A is a nonempty set of parameters,
- c) (K, A) is an interval valued neutrosophic soft set over V ,
- d) (M, A) is an interval valued neutrosophic over E ,
- e) $(K(e), M(e))$ is an interval valued neutrosophic (sub)graph of G^* for all $e \in A$.

That is,

$$T_{M(e)}^L(xy) \leq \min [T_{K(e)}^L(x), T_{K(e)}^L(y)], T_{M(e)}^U(xy) \leq \min [T_{K(e)}^U(x), T_{K(e)}^U(y)],$$

$$I_{M(e)}^L(xy) \geq \max [I_{K(e)}^L(x), I_{K(e)}^L(y)], I_{M(e)}^U(xy) \geq \max [I_{K(e)}^U(x), I_{K(e)}^U(y)]$$

$$\text{and } F_{M(e)}^L(xy) \geq \max [F_{K(e)}^L(x), F_{K(e)}^L(y)], F_{M(e)}^U(xy) \geq \max [F_{K(e)}^U(x), F_{K(e)}^U(y)],$$

such that

$$0 \leq T_{M(e)}(xy) + I_{M(e)}(xy) + F(xy) \leq 3 \text{ for all } e \in A \text{ and } x, y \in V.$$

The interval valued neutrosophic graph $(K(e), M(e))$ is denoted by $H(e)$ for convenience. An interval valued neutrosophic graph is a parametrized family of interval valued neutrosophic graphs. The class of all interval valued neutrosophic soft graphs of G^* is denoted by $IVN(G^*)$. Note that

$$T_{M(e)}^L(xy) = T_{M(e)}^U(xy) = I_{M(e)}^L(xy) = I_{M(e)}^U(xy) = 0 \text{ and } F_{M(e)}^L(xy) = F_{M(e)}^U(xy) = 0 \text{ for all } xy \in V - E, e \notin A.$$

Definition 3.2 Let $G_1=(K_1, M_1, A)$ and $G_2=(K_2, M_2, B)$ be two interval valued neutrosophic graphs of G^* . Then G_1 is an interval valued neutrosophic soft subgraph of G_2 if

- (i) $A \subseteq B$
- (ii) $H_1(e)$ is a partial subgraph of $H_2(e)$ for all $e \in A$.

Example 3.3. Consider a simple graph $G^*=(V, E)$ such that $V=\{v_1, v_2, v_3\}$ and $E=\{v_1v_2, v_2v_3, v_3v_1\}$.

Let $A= \{e_1, e_2\}$ be a set of parameter and let (K, A) be an interval valued neutrosophic soft set over V with its interval valued neutrosophic approximate function $K : A \rightarrow P(V)$ defined by

$$K(e_1)=\{v_1|([0.3, 0.5],[0.2, 0.3], [0.3, 0.4]), v_2|([0.2, 0.3], [0.2, 0.3], [0.1, 0.4]), v_3|([0.1, 0.3], [0.2, 0.4], [0.3, 0.5])\},$$

$$K(e_2)=\{v_1|([0.1, 0.4], [0.1, 0.3], [0.2, 0.3]), v_2|([0.1, 0.3], [0.1, 0.2], [0.1, 0.4]), v_3|([0.1, 0.2], [0.2, 0.3], [0.2, 0.5])\}.$$

Let (M, A) be an interval valued neutrosophic soft set over E with its interval valued neutrosophic approximate function $M : A \rightarrow P(E)$ defined by

$$M(e_1)=\{v_1v_2|([0.1, 0.2], [0.3, 0.4], [0.4, 0.5]), v_2v_3|([0.1, 0.3], [0.4, 0.5], [0.4, 0.5]), v_3v_1|([0.1, 0.2], [0.3, 0.5], [0.5, 0.6])\},$$

$$M(e_2)=\{v_1v_2|([0.1, 0.2], [0.2, 0.3], [0.3, 0.4]), v_2v_3|([0.1, 0.2], [0.3, 0.4], [0.2, 0.5]), v_3v_1|([0.1, 0.2], [0.2, 0.4], [0.3, 0.5])\}.$$

Thus, $H(e_1)=(K(e_1), M(e_1))$, $H(e_2)=(K(e_2), M(e_2))$ are interval valued neutrosophic graphs corresponding to the parameters e_1 and e_2 as shown below.

$H(e_1)$

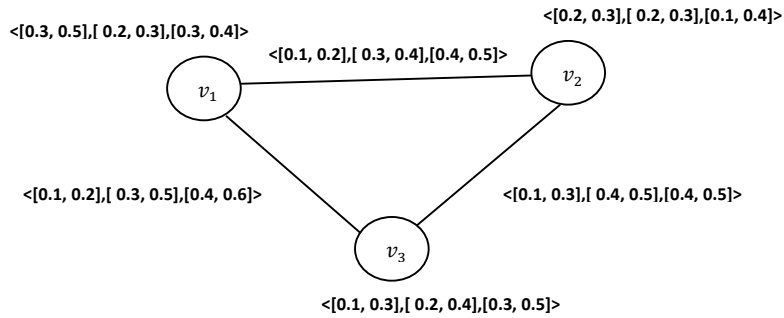

$H(e_2)$

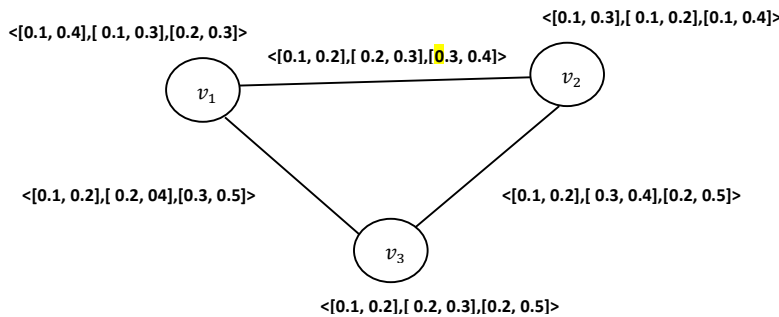

Fig. 3.1: Interval valued neutrosophic soft graph $G = \{H(e_1), H(e_2)\}$.

Hence $G = \{H(e_1), H(e_2)\}$ is an interval valued neutrosophic soft graph of G^* .

Tabular representation of an interval valued neutrosophic soft graph is given in Table below.

Table 1: Tabular representation of an interval valued neutrosophic soft graph.

K	v_1	v_2	v_3
e_1	$\langle [0.3, 0.5], [0.2, 0.3], [0.3, 0.4] \rangle$	$\langle [0.2, 0.3], [0.2, 0.3], [0.1, 0.4] \rangle$	$\langle [0.1, 0.3], [0.2, 0.4], [0.3, 0.5] \rangle$
e_2	$\langle [0.1, 0.4], [0.1, 0.3], [0.2, 0.3] \rangle$	$\langle [0.1, 0.3], [0.1, 0.2], [0.1, 0.4] \rangle$	$\langle [0.1, 0.2], [0.2, 0.3], [0.2, 0.5] \rangle$

M	(v ₁ , v ₂)	(v ₂ , v ₃)	(v ₁ , v ₃)
e ₁	<[0.1,0.2],[0.3, 0.4][0.4, 0.5]>	<[0.1,0.3],[0.4, 0.5][0.4, 0.5]>	<[0.1,0.2],[0.3, 0.5][0.4, 0.6]>
e ₂	<[0.1,0.2],[0.2, 0.3][0.3, 0.4]>	<[0.1,0.2],[0.3, 0.4][0.2, 0.5]>	<[0.1,0.2],[0.2, 0.4][0.3, 0.5]>

Definition 3.4 Let $G_1=(K_1, M_1, A)$ and $G_2=(K_2, M_2, B)$ be two interval valued neutrosophic graphs of $G_1^* = (V_1, E_1)$ and $G_2^* = (V_2, E_2)$ respectively. The Cartesian product of two graphs G_1 and G_2 is an interval valued neutrosophic soft graph $G= G_1 \times G_2 = (K, M, A \times B)$, where $(K=K_1 \times K_2, A \times B)$ is an interval valued neutrosophic soft set over $V=V_1 \times V_2$, $(M=M_1 \times M_2, A \times B)$ is an interval valued neutrosophic soft set over $E= \{(x, x_2) (x, y_2) / x \in V_1, x_2 y_2 \in E_2\} \cup \{(x_1, z) (y_1, z) / z \in V_2, x_1 y_1 \in E_1\}$ and $(K, M, A \times B)$ are interval valued neutrosophic soft graphs such that:

- 1) $(T_{K_1(a)}^L \times T_{K_2(b)}^L) (x_1, x_2) = \min (T_{K_1(a)}^L(x_1), T_{K_2(b)}^L(x_2))$
 $(T_{K_1(a)}^U \times T_{K_2(b)}^U) (x_1, x_2) = \min (T_{K_1(a)}^U(x_1), T_{K_2(b)}^U(x_2))$
 $(I_{K_1(a)}^L \times I_{K_2(b)}^L) (x_1, x_2) = \max (I_{K_1(a)}^L(x_1), I_{K_2(b)}^L(x_2))$
 $(I_{K_1(a)}^U \times I_{K_2(b)}^U) (x_1, x_2) = \max (I_{K_1(a)}^U(x_1), I_{K_2(b)}^U(x_2))$
 $(F_{K_1(a)}^L \times F_{K_2(b)}^L) (x_1, x_2) = \max (F_{K_1(a)}^L(x_1), F_{K_2(b)}^L(x_2))$
 $(F_{K_1(a)}^U \times F_{K_2(b)}^U) (x_1, x_2) = \max (F_{K_1(a)}^U(x_1), F_{K_2(b)}^U(x_2))$ for all $(x_1, x_2) \in A \times B$

- 2) $(T_{M_1(a)}^L \times T_{M_2(b)}^L) ((x, x_2)(x, y_2)) = \min (T_{K_1(a)}^L(x), T_{M_2(b)}^L(x_2 y_2))$
 $(T_{M_1(a)}^U \times T_{M_2(b)}^U) ((x, x_2)(x, y_2)) = \min (T_{K_1(a)}^U(x), T_{M_2(b)}^U(x_2 y_2))$
 $(I_{M_1(a)}^L \times I_{M_2(b)}^L) ((x, x_2)(x, y_2)) = \max (I_{K_1(a)}^L(x), I_{M_2(b)}^L(x_2 y_2))$
 $(I_{M_1(a)}^U \times I_{M_2(b)}^U) ((x, x_2)(x, y_2)) = \max (I_{K_1(a)}^U(x), I_{M_2(b)}^U(x_2 y_2))$
 $(F_{M_1(a)}^L \times F_{M_2(b)}^L) ((x, x_2)(x, y_2)) = \max (F_{K_1(a)}^L(x), F_{M_2(b)}^L(x_2 y_2))$
 $(F_{M_1(a)}^U \times F_{M_2(b)}^U) ((x, x_2)(x, y_2)) = \max (F_{K_1(a)}^U(x), F_{M_2(b)}^U(x_2 y_2)) \forall x \in V_1$
and $\forall x_2 y_2 \in E_2$

- 3) $(T_{M_1(a)}^L \times T_{M_2(b)}^L) ((x_1, z) (y_1, z)) = \min (T_{M_1(a)}^L(x_1 y_1), T_{K_2(b)}^L(z))$
 $(T_{M_1(a)}^U \times T_{M_2(b)}^U) ((x_1, z) (y_1, z)) = \min (T_{M_1(a)}^U(x_1 y_1), T_{K_2(b)}^U(z))$
 $(I_{M_1(a)}^L \times I_{M_2(b)}^L) ((x_1, z) (y_1, z)) = \max (I_{M_1(a)}^L(x_1 y_1), I_{K_2(b)}^L(z))$
 $(I_{M_1(a)}^U \times I_{M_2(b)}^U) ((x_1, z) (y_1, z)) = \max (I_{M_1(a)}^U(x_1 y_1), I_{K_2(b)}^U(z))$
 $(F_{M_1(a)}^L \times F_{M_2(b)}^L) ((x_1, z) (y_1, z)) = \max (F_{M_1(a)}^L(x_1 y_1), F_{K_2(b)}^L(z))$
 $(F_{M_1(a)}^U \times F_{M_2(b)}^U) ((x_1, z) (y_1, z)) = \max (F_{M_1(a)}^U(x_1 y_1), F_{K_2(b)}^U(z)) \forall z \in V_2$
and $\forall x_1 y_1 \in E_1$

$H(a, b) = H_1(a) \times H_2(b)$ for all $(a, b) \in A \times B$ are interval valued neutrosophic graphs of G.

Example 3.5. Let $A= \{e_1, e_2\}$ and $B= \{e_3, e_4\}$ be a set of parameters. Consider two interval valued neutrosophic soft graphs $G_1=(H_1, A) = \{H(e_1), H(e_2)\}$ and $G_2=(H_2, B) = \{H(e_3), H(e_4)\}$ such that

$$H_1(e_1) = (\{u_1|([0.3, 0.5], [0.2, 0.3], [0.3, 0.4]), u_2|([0.6, 0.7], [0.2, 0.4], [0.1, 0.3])\}, \{u_1u_2|([0.3, 0.6], [0.2, 0.4], [0.2, 0.5])\})$$

$$H_1(e_2) = (\{u_1|([0.3, 0.5], [0.2, 0.3], [0.3, 0.4]), u_2|([0.2, 0.3], [0.2, 0.3], [0.1, 0.4]), u_3|([0.1, 0.3], [0.2, 0.4], [0.3, 0.5])\}, \{u_1u_2|([0.1, 0.2], [0.3, 0.4], [0.4, 0.5]), u_2u_3|([0.1, 0.3], [0.4, 0.5], [0.4, 0.5]), u_3u_1|([0.1, 0.2], [0.3, 0.5], [0.5, 0.6])\})$$

$$H_2(e_3) = (\{v_1|([0.4, 0.6], [0.2, 0.3], [0.1, 0.3]), v_2|([0.4, 0.7], [0.2, 0.4], [0.1, 0.3])\}, \{v_1v_2|([0.3, 0.5], [0.4, 0.5], [0.3, 0.5])\})$$

$$H_2(e_4) = (\{v_1|([0.1, 0.4], [0.1, 0.3], [0.2, 0.3]), v_2|([0.1, 0.3], [0.1, 0.2], [0.1, 0.4]), v_3|([0.1, 0.2], [0.2, 0.3], [0.2, 0.5])\}, \{v_1v_2|([0.1, 0.2], [0.2, 0.3], [0.3, 0.4]), v_2v_3|([0.1, 0.2], [0.3, 0.4], [0.2, 0.5]), v_3v_1|([0.1, 0.2], [0.2, 0.4], [0.3, 0.5])\})$$

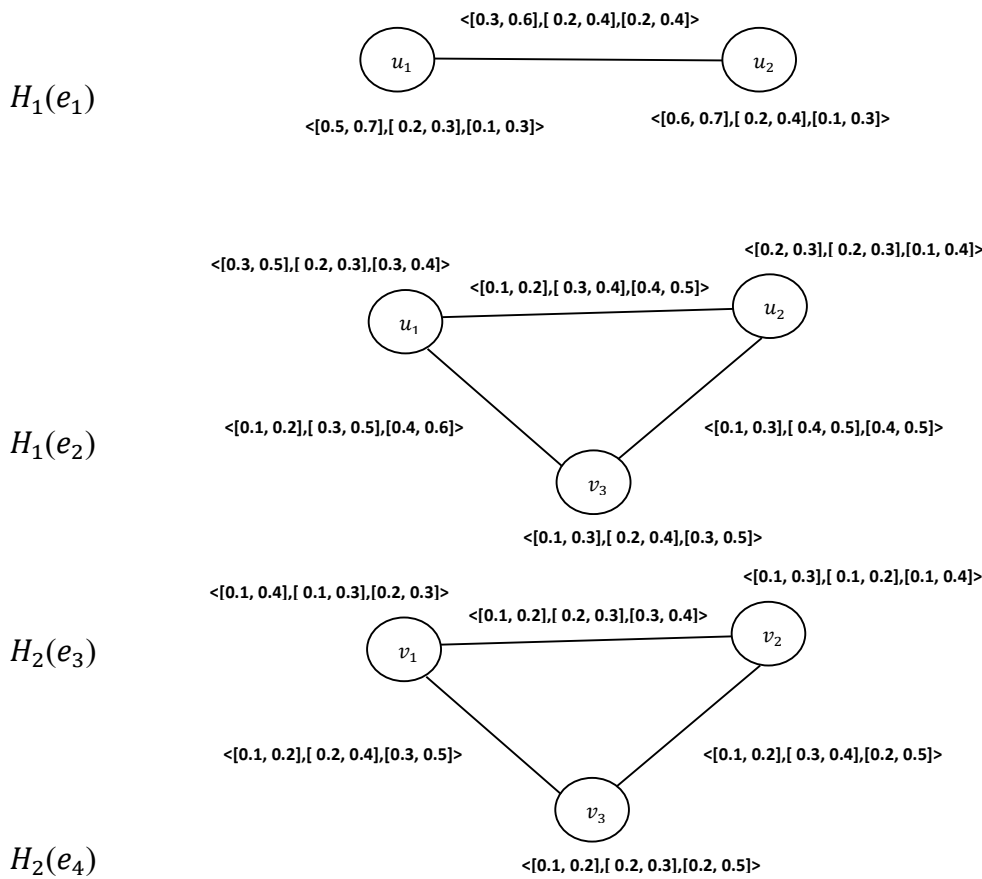

Fig. 3.2: Interval valued neutrosophic soft graph $G_1 = \{H_1(e_1), H_1(e_2)\}$ and $G_2 = \{H_2(e_3), H_2(e_4)\}$

The Cartesian product of G_1 and G_2 is $G_1 \times G_2 = (H, A \times B)$, where $A \times B = \{(e_1, e_3), (e_1, e_4), (e_2, e_3), (e_2, e_4)\}$, $H(e_1, e_3) = H_1(e_1) \times H_2(e_3)$, $H(e_1, e_4) = H_1(e_1) \times H_2(e_4)$, $H(e_2, e_3) = H_1(e_2) \times H_2(e_3)$ and $H(e_2, e_4) = H_1(e_2) \times H_2(e_4)$ are interval valued neutrosophic graphs of $G = G_1 \times G_2$. $H(e_1, e_3) = H_1(e_1) \times H_2(e_3)$ is shown in Fig. 3.3.

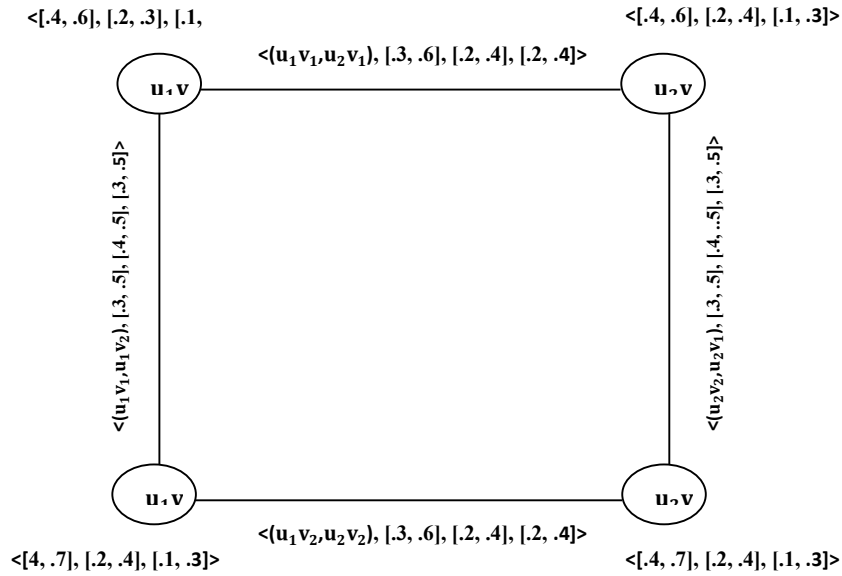

Fig. 3.3: Cartesian product

In the similar way, Cartesian product of $H(e_1, e_4) = H_1(e_1) \times H_2(e_4)$, $H(e_2, e_3) = H_1(e_2) \times H_2(e_3)$ and $H(e_2, e_4) = H_1(e_2) \times H_2(e_4)$ can be drawn.

Hence $G = G_1 \times G_2 = \{H(e_1, e_3), H(e_1, e_4), H(e_2, e_3), H(e_2, e_4)\}$ is an interval valued neutrosophic soft graph.

Theorem 3.6. The Cartesian product of two interval valued neutrosophic soft graph is an interval valued neutrosophic soft graph.

Proof. Let $G_1 = (K_1, M_1, A)$ and $G_2 = (K_2, M_2, B)$ be two interval valued neutrosophic graphs of $G_1^* = (V_1, E_1)$ and $G_2^* = (V_2, E_2)$ respectively. Let $G = G_1 \times G_2 = (K, M, A \times B)$ be the Cartesian product of two graphs G_1 and G_2 . We claim that $G = G_1 \times G_2 = (K, M, A \times B)$ is an interval valued neutrosophic soft graph $G = G_1 \times G_2 = (K, M, A \times B)$, where $(K = K_1 \times K_2, A \times B)$ is an interval valued neutrosophic soft graph and $(H, A \times B) = \{(K_1 \times K_2)(a_i, b_j), (M_1 \times M_2)(a_i, b_j)\}$ for all $a_i \in A, b_j \in B$ for $i = 1, 2, \dots, m, j = 1, 2, \dots, n$ are interval valued neutrosophic graphs of G .

Consider, $(x, x_2)(x, y_2) \in E$, we have

$$\begin{aligned} T_{M(a_i, b_j)}^L((x, x_2)(x, y_2)) &= \min(T_{K_1(a_i)}^L(x), T_{M_2(b_j)}^L(x_2 y_2)), \text{ for } i = 1, 2, \dots, m, j = 1, \\ &2, \dots, n \\ &\leq \min\{T_{K_1(a_i)}^L(x), \min\{T_{K_2(b_j)}^L(x_2), T_{K_2(b_j)}^L(y_2)\}\} \\ &= \min\{\min\{T_{K_1(a_i)}^L(x), T_{K_2(b_j)}^L(x_2)\}, \min\{T_{K_1(a_i)}^L(x), T_{K_2(b_j)}^L(y_2)\}\} \\ T_{M(a_i, b_j)}^L((x, x_2)(x, y_2)) &\leq \min\{(T_{K_1(a_i)}^L \times T_{K_2(b_j)}^L)(x, x_2), (T_{K_1(a_i)}^L \times T_{K_2(b_j)}^L)(x, \\ &y_2), \text{ for } i = 1, 2, \dots, m, j = 1, 2, \dots, n \end{aligned}$$

Similarly, we prove that

$$T_{M(a_i,b_j)}^U((x, x_2)(x, y_2)) \leq \min\{(T_{K_1(a_i)}^U \times T_{K_2(b_j)}^U)(x, x_2), (T_{K_1(a_i)}^U \times T_{K_2(b_j)}^U)(x, y_2)\}, \text{for } i=1, 2, \dots, m, j=1, 2, \dots, n.$$

$$I_{M(a_i,b_j)}^L((x, x_2)(x, y_2)) = \max(I_{K_1(a_i)}^L(x), I_{M_2(b_j)}^L(x_2 y_2)), \text{for } i=1, 2, \dots, m, j=1, 2, \dots, n$$

$$\geq \max\{I_{K_1(a_i)}^L(x), \max\{I_{K_2(b_j)}^L(x_2), I_{K_2(b_j)}^L(y_2)\}\}$$

$$= \max\{\max\{I_{K_1(a_i)}^L(x), I_{K_2(b_j)}^L(x_2)\}, \max\{I_{K_1(a_i)}^L(x), I_{K_2(b_j)}^L(y_2)\}\}$$

$$I_{M(a_i,b_j)}^L((x, x_2)(x, y_2)) \geq \max\{(I_{K_1(a_i)}^L \times I_{K_2(b_j)}^L)(x, x_2), (I_{K_1(a_i)}^L \times I_{K_2(b_j)}^L)(x, y_2)\}, \text{for } i=1, 2, \dots, m, j=1, 2, \dots, n$$

Similarly, we prove that

$$I_{M(a_i,b_j)}^U((x, x_2)(x, y_2)) \geq \max\{(I_{K_1(a_i)}^U \times I_{K_2(b_j)}^U)(x, x_2), (I_{K_1(a_i)}^U \times I_{K_2(b_j)}^U)(x, y_2)\}, \text{for } i=1, 2, \dots, m, j=1, 2, \dots, n$$

$$F_{M(a_i,b_j)}^L((x, x_2)(x, y_2)) = \max(F_{K_1(a_i)}^L(x), F_{M_2(b_j)}^L(x_2 y_2)), \text{for } i=1, 2, \dots, m, j=1, 2, \dots, n$$

$$\geq \max\{F_{K_1(a_i)}^L(x), \max\{F_{K_2(b_j)}^L(x_2), F_{K_2(b_j)}^L(y_2)\}\}$$

$$= \max\{\max\{F_{K_1(a_i)}^L(x), F_{K_2(b_j)}^L(x_2)\}, \max\{F_{K_1(a_i)}^L(x), F_{K_2(b_j)}^L(y_2)\}\}$$

$$F_{M(a_i,b_j)}^L((x, x_2)(x, y_2)) \geq \max\{(F_{K_1(a_i)}^L \times F_{K_2(b_j)}^L)(x, x_2), (F_{K_1(a_i)}^L \times F_{K_2(b_j)}^L)(x, y_2)\}, \text{for } i=1, 2, \dots, m, j=1, 2, \dots, n$$

Similarly, we prove that

$$F_{M(a_i,b_j)}^U((x, x_2)(x, y_2)) \geq \max\{(F_{K_1(a_i)}^U \times F_{K_2(b_j)}^U)(x, x_2), (F_{K_1(a_i)}^U \times F_{K_2(b_j)}^U)(x, y_2)\}, \text{for } i=1, 2, \dots, m, j=1, 2, \dots, n$$

Similarly, for $(x_1, z) (y_1, z) \in E$, we have

$$T_{M(a_i,b_j)}^L((x_1, z) (y_1, z)) \leq \min\{(T_{K_1(a_i)}^L \times T_{K_2(b_j)}^L)(x_1, z), (T_{K_1(a_i)}^L \times T_{K_2(b_j)}^L)(y_1, z),$$

$$T_{M(a_i,b_j)}^U((x_1, z) (y_1, z)) \leq \min\{(T_{K_1(a_i)}^U \times T_{K_2(b_j)}^U)(x_1, z), (T_{K_1(a_i)}^U \times T_{K_2(b_j)}^U)(y_1, z),$$

$$I_{M(a_i,b_j)}^L((x_1, z) (y_1, z)) \geq \max\{(I_{K_1(a_i)}^L \times I_{K_2(b_j)}^L)(x_1, z), (I_{K_1(a_i)}^L \times I_{K_2(b_j)}^L)(y_1, z),$$

$$I_{M(a_i,b_j)}^U((x_1, z) (y_1, z)) \geq \max\{(I_{K_1(a_i)}^U \times I_{K_2(b_j)}^U)(x_1, z), (I_{K_1(a_i)}^U \times I_{K_2(b_j)}^U)(y_1, z),$$

$$F_{M(a_i,b_j)}^L((x_1, z) (y_1, z)) \geq \max\{(F_{K_1(a_i)}^L \times F_{K_2(b_j)}^L)(x_1, z), (F_{K_1(a_i)}^L \times F_{K_2(b_j)}^L)(y_1, z),$$

$$F_{M(a_i,b_j)}^U((x_1, z) (y_1, z)) \geq \max\{(F_{K_1(a_i)}^U \times F_{K_2(b_j)}^U)(x_1, z), (F_{K_1(a_i)}^U \times F_{K_2(b_j)}^U)(y_1, z)\}, \text{for } i=1, 2, \dots, m, j=1, 2, \dots, n$$

Hence $G = (K, M, A \times B)$ is an interval valued neutrosophic soft graph.

Definition 3.7 Let $G_1=(K_1, M_1, A)$ and $G_2=(K_2, M_2, B)$ be two interval valued neutrosophic graphs of $G_1^*=(V_1, E_1)$ and $G_2^*=(V_2, E_2)$ respectively. The strong product of two graphs G_1 and G_2 is an interval valued neutrosophic soft graph $G= G_1 \otimes G_2 = (K, M, A \times B)$, where $(K=K_1 \times K_2, A \times B)$ is an interval valued neutrosophic soft set over $V=V_1 \times V_2$, $(M, A \times B)$ is an interval valued neutrosophic soft set over $E= \{(x, x_2) (x, y_2) / x \in V_1, x_2 y_2 \in E_2\} \cup \{(x_1, z) (y_1, z) / z \in V_2, x_1 y_1 \in E_1\} \cup \{(x_1, x_2) (y_1, y_2) / x_1 y_1 \in E_1, x_2 y_2 \in E_2\}$ and $(K, M, A \times B)$ are interval valued neutrosophic soft graphs such that:

- 1) $(T_{K_1(a)}^L \times T_{K_2(b)}^L) (x_1, x_2) = \min (T_{K_1(a)}^L(x_1), T_{K_2(b)}^L(x_2))$
 $(T_{K_1(a)}^U \times T_{K_2(b)}^U) (x_1, x_2) = \min (T_{K_1(a)}^U(x_1), T_{K_2(b)}^U(x_2))$
 $(I_{K_1(a)}^L \times I_{K_2(b)}^L) (x_1, x_2) = \max (I_{K_1(a)}^L(x_1), I_{K_2(b)}^L(x_2))$
 $(I_{K_1(a)}^U \times I_{K_2(b)}^U) (x_1, x_2) = \max (I_{K_1(a)}^U(x_1), I_{K_2(b)}^U(x_2))$
 $(F_{K_1(a)}^L \times F_{K_2(b)}^L) (x_1, x_2) = \max (F_{K_1(a)}^L(x_1), F_{K_2(b)}^L(x_2))$
 $(F_{K_1(a)}^U \times F_{K_2(b)}^U) (x_1, x_2) = \max (F_{K_1(a)}^U(x_1), F_{K_2(b)}^U(x_2))$ for all $(x_1, x_2) \in A \times B$

- 2) $(T_{M_1(a)}^L \times T_{M_2(b)}^L) ((x, x_2)(x, y_2)) = \min (T_{K_1(a)}^L(x), T_{M_2(b)}^L(x_2 y_2))$
 $(T_{M_1(a)}^U \times T_{M_2(b)}^U) ((x, x_2)(x, y_2)) = \min (T_{K_1(a)}^U(x), T_{M_2(b)}^U(x_2 y_2))$
 $(I_{M_1(a)}^L \times I_{M_2(b)}^L) ((x, x_2)(x, y_2)) = \max (I_{K_1(a)}^L(x), I_{M_2(b)}^L(x_2 y_2))$
 $(I_{M_1(a)}^U \times I_{M_2(b)}^U) ((x, x_2)(x, y_2)) = \max (I_{K_1(a)}^U(x), I_{M_2(b)}^U(x_2 y_2))$
 $(F_{M_1(a)}^L \times F_{M_2(b)}^L) ((x, x_2)(x, y_2)) = \max (F_{K_1(a)}^L(x), F_{M_2(b)}^L(x_2 y_2))$
 $(F_{M_1(a)}^U \times F_{M_2(b)}^U) ((x, x_2)(x, y_2)) = \max (F_{K_1(a)}^U(x), F_{M_2(b)}^U(x_2 y_2)) \quad \forall x \in V_1$ and $\forall x_2 y_2 \in E_2$.

- 3) $(T_{M_1(a)}^L \times T_{M_2(b)}^L) ((x_1, z) (y_1, z)) = \min (T_{M_1(a)}^L(x_1 y_1), T_{K_2(b)}^L(z))$
 $(T_{M_1(a)}^U \times T_{M_2(b)}^U) ((x_1, z) (y_1, z)) = \min (T_{M_1(a)}^U(x_1 y_1), T_{K_2(b)}^U(z))$
 $(I_{M_1(a)}^L \times I_{M_2(b)}^L) ((x_1, z) (y_1, z)) = \max (I_{M_1(a)}^L(x_1 y_1), I_{K_2(b)}^L(z))$
 $(I_{M_1(a)}^U \times I_{M_2(b)}^U) ((x_1, z) (y_1, z)) = \max (I_{M_1(a)}^U(x_1 y_1), I_{K_2(b)}^U(z))$
 $(F_{M_1(a)}^L \times F_{M_2(b)}^L) ((x_1, z) (y_1, z)) = \max (F_{M_1(a)}^L(x_1 y_1), F_{K_2(b)}^L(z))$
 $(F_{M_1(a)}^U \times F_{M_2(b)}^U) ((x_1, z) (y_1, z)) = \max (F_{M_1(a)}^U(x_1 y_1), F_{K_2(b)}^U(z)) \quad \forall z \in V_2$ and $\forall x_1 y_1 \in E_1$.

- 4) $(T_{M_1(a)}^L \times T_{M_2(b)}^L) ((x_1, x_2), (y_1, y_2)) = \min (T_{K_1(a)}^L(x_1 y_1), T_{K_2(b)}^L(x_2 y_2))$
 $(T_{M_1(a)}^U \times T_{M_2(b)}^U) ((x_1, x_2), (y_1, y_2)) = \min (T_{K_1(a)}^U(x_1 y_1), T_{K_2(b)}^U(x_2 y_2))$
 $(I_{M_1(a)}^L \times I_{M_2(b)}^L) ((x_1, x_2), (y_1, y_2)) = \max (I_{K_1(a)}^L(x_1 y_1), I_{K_2(b)}^L(x_2 y_2))$
 $(I_{M_1(a)}^U \times I_{M_2(b)}^U) ((x_1, x_2), (y_1, y_2)) = \max (I_{K_1(a)}^U(x_1 y_1), I_{K_2(b)}^U(x_2 y_2))$
 $(F_{M_1(a)}^L \times F_{M_2(b)}^L) ((x_1, x_2), (y_1, y_2)) = \max (F_{K_1(a)}^L(x_1 y_1), F_{K_2(b)}^L(x_2 y_2))$
 $(F_{M_1(a)}^U \times F_{M_2(b)}^U) ((x_1, x_2), (y_1, y_2)) = \max (F_{K_1(a)}^U(x_1 y_1), F_{K_2(b)}^U(x_2 y_2))$ for all $(x_1, y_1) \in E_1, ((x_2, y_2) \in E_2$.

$H(a, b) = H_1(a) \otimes H_2(b)$ for all $(a, b) \in A \times B$ are interval valued neutrosophic graphs of G .

Theorem 3.8. The strong product of two interval valued neutrosophic soft graph is an interval valued neutrosophic soft graph.

Definition 3.9 Let $G_1=(K_1, M_1, A)$ and $G_2=(K_2, M_2, B)$ be two interval valued neutrosophic graphs of $G_1^* = (V_1, E_1)$ and $G_1^* = (V_2, E_2)$ respectively. The composition of two graphs G_1 and G_2 is an interval valued neutrosophic soft graph $G= G_1[G_2] = (K,M, A \circ B)$, where $(K=K_1 \circ K_2, A \circ B)$ is an interval valued neutrosophic soft set over $V=V_1 \times V_2$, $(M, A \circ B)$ is an interval valued neutrosophic soft set over $E= \{(x, x_2) (x, y_2) /x \in V_1, x_2y_2 \in E_2\} \cup \{(x_1,z) (y_1, z) /z \in V_2, x_1y_1 \in E_1\} \cup \{(x_1,x_2) (y_1,y_2) /x_1y_1 \in E_1, x_2 \neq y_2\}$ and $(K, M, A \circ B)$ are interval valued neutrosophic soft graphs such that:

- 1) $(T_{K_1(a)}^L \circ T_{K_2(b)}^L) (x_1, x_2) = \min (T_{K_1(a)}^L(x_1), T_{K_2(b)}^L(x_2))$
 $(T_{K_1(a)}^U \circ T_{K_2(b)}^U) (x_1, x_2) = \min (T_{K_1(a)}^U(x_1), T_{K_2(b)}^U(x_2))$
 $(I_{K_1(a)}^L \circ I_{K_2(b)}^L) (x_1, x_2) = \max (I_{K_1(a)}^L(x_1), I_{K_2(b)}^L(x_2))$
 $(I_{K_1(a)}^U \circ I_{K_2(b)}^U) (x_1, x_2) = \max (I_{K_1(a)}^U(x_1), I_{K_2(b)}^U(x_2))$
 $(F_{K_1(a)}^L \circ F_{K_2(b)}^L) (x_1, x_2) = \max (F_{K_1(a)}^L(x_1), F_{K_2(b)}^L(x_2))$
 $(F_{K_1(a)}^U \circ F_{K_2(b)}^U) (x_1, x_2) = \max (F_{K_1(a)}^U(x_1), F_{K_2(b)}^U(x_2))$ for all $(x_1, x_2) \in A \times B$

- 2) $(T_{M_1(a)}^L \circ T_{M_2(b)}^L) ((x, x_2)(x, y_2)) = \min (T_{K_1(a)}^L(x), T_{M_2(b)}^L(x_2y_2))$
 $(T_{M_1(a)}^U \circ T_{M_2(b)}^U) ((x, x_2)(x, y_2)) = \min (T_{K_1(a)}^U(x), T_{M_2(b)}^U(x_2y_2))$
 $(I_{M_1(a)}^L \circ I_{M_2(b)}^L) ((x, x_2)(x, y_2)) = \max (I_{K_1(a)}^L(x), I_{M_2(b)}^L(x_2y_2))$
 $(I_{M_1(a)}^U \circ I_{M_2(b)}^U) ((x, x_2)(x, y_2)) = \max (I_{K_1(a)}^U(x), I_{M_2(b)}^U(x_2y_2))$
 $(F_{M_1(a)}^L \circ F_{M_2(b)}^L) ((x, x_2)(x, y_2)) = \max (F_{K_1(a)}^L(x), F_{M_2(b)}^L(x_2y_2))$
 $(F_{M_1(a)}^U \circ F_{M_2(b)}^U) ((x, x_2)(x, y_2)) = \max (F_{K_1(a)}^U(x), F_{M_2(b)}^U(x_2y_2)) \quad \forall x \in V_1$ and $\forall x_2y_2 \in E_2$.

- 3) $(T_{M_1(a)}^L \circ T_{M_2(b)}^L) ((x_1, z) (y_1, z)) = \min (T_{M_1(a)}^L(x_1y_1), T_{K_2(b)}^L(z))$
 $(T_{M_1(a)}^U \circ T_{M_2(b)}^U) ((x_1, z) (y_1, z)) = \min (T_{M_1(a)}^U(x_1y_1), T_{K_2(b)}^U(z))$
 $(I_{M_1(a)}^L \circ I_{M_2(b)}^L) ((x_1, z) (y_1, z)) = \max (I_{M_1(a)}^L(x_1y_1), I_{K_2(b)}^L(z))$
 $(I_{M_1(a)}^U \circ I_{M_2(b)}^U) ((x_1, z) (y_1, z)) = \max (I_{M_1(a)}^U(x_1y_1), I_{K_2(b)}^U(z))$
 $(F_{M_1(a)}^L \circ F_{M_2(b)}^L)((x_1, z) (y_1, z)) = \max (F_{M_1(a)}^L(x_1y_1), F_{K_2(b)}^L(z))$
 $(F_{M_1(a)}^U \circ F_{M_2(b)}^U) ((x_1, z) (y_1, z)) = \max (F_{M_1(a)}^U(x_1y_1), F_{K_2(b)}^U(z)) \quad \forall z \in V_2$ and $\forall x_1y_1 \in E_1$.

- 4) $(T_{M_1(a)}^L \circ T_{M_2(b)}^L) ((x_1, x_2), (y_1, y_2)) = \min (T_{K_1(a)}^L(x_1y_1), T_{K_2(b)}^L(x_2), T_{K_2(b)}^L(y_2))$
 $(T_{M_1(a)}^U \circ T_{M_2(b)}^U) ((x_1, x_2), (y_1, y_2)) = \min (T_{K_1(a)}^U(x_1y_1), T_{K_2(b)}^U(x_2), T_{K_2(b)}^U(y_2))$
 $(I_{M_1(a)}^L \circ I_{M_2(b)}^L) ((x_1, x_2), (y_1, y_2)) = \max (I_{K_1(a)}^L(x_1y_1), I_{K_2(b)}^L(x_2), I_{K_2(b)}^L(y_2))$
 $(I_{M_1(a)}^U \circ I_{M_2(b)}^U) ((x_1, x_2), (y_1, y_2)) = \max (I_{K_1(a)}^U(x_1y_1), I_{K_2(b)}^U(x_2), I_{K_2(b)}^U(y_2))$
 $(F_{M_1(a)}^L \circ F_{M_2(b)}^L) ((x_1, x_2), (y_1, y_2)) = \max (F_{K_1(a)}^L(x_1y_1), F_{K_2(b)}^L(x_2), F_{K_2(b)}^L(y_2))$
 $(F_{M_1(a)}^U \circ F_{M_2(b)}^U) ((x_1, x_2), (y_1, y_2)) = \max (F_{K_1(a)}^U(x_1y_1), F_{K_2(b)}^U(x_2), F_{K_2(b)}^U(y_2))$ for all $(x_1, y_1) \in E_1$, and $x_2 \neq y_2$.

$H(a, b) = H_1(a)[H_2(b)]$ for all $(a, b) \in A \times B$ are interval valued neutrosophic graphs of G .

Example 3.10. Let $A = \{e_1\}$, $A = \{e_2, e_3\}$ be the parameters sets. Consider two interval valued neutrosophic soft graphs $G_1 = (H_1, A) = \{H_1(e_1)\}$ and $G_2 = (H_2, B) = \{H_2(e_2), H_2(e_3)\}$ such that

$$H_1(e_1) = (\{u_1 | ([0.5, 0.7], [0.2, 0.3], [0.1, 0.3]), u_2 | ([0.6, 0.7], [0.2, 0.4], [0.1, 0.3])\}, \{u_1 u_2 | ([0.3, 0.6], [0.2, 0.4], [0.2, 0.4])\})$$

$$H_2(e_2) = (\{v_1 | ([0.1, 0.4], [0.1, 0.3], [0.2, 0.3]), v_2 | ([0.1, 0.3], [0.1, 0.2], [0.1, 0.4]), v_3 | ([0.1, 0.2], [0.2, 0.3], [0.2, 0.5])\}, \{v_1 v_2 | ([0.1, 0.2], [0.2, 0.3], [0.3, 0.4]), v_2 v_3 | ([0.1, 0.2], [0.3, 0.4], [0.2, 0.5]), v_3 v_1 | ([0.1, 0.2], [0.2, 0.4], [0.3, 0.5])\})$$

$$H_2(e_3) = (\{v_1 | ([0.4, 0.6], [0.2, 0.3], [0.1, 0.3]), v_2 | ([0.4, 0.7], [0.2, 0.4], [0.1, 0.3])\}, \{v_1 v_2 | ([0.3, 0.5], [0.2, 0.5], [0.3, 0.5])\})$$

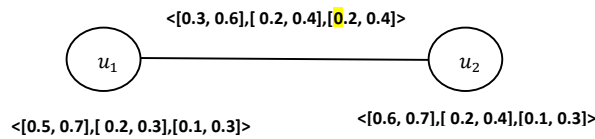

Fig. 3.4: Interval valued neutrosophic soft graph corresponding to $H_1(e_1)$

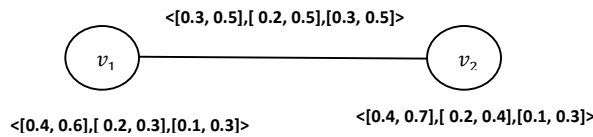

Fig. 3.5: Interval valued neutrosophic soft graph corresponding to $H_2(e_3)$.

The composition of G_1 and G_2 is $G_1[G_2] = (H, A \times B)$, where $A \times B = \{(e_1, e_2), (e_1, e_3), (e_2, e_3)\}$, $H(e_1, e_2) = H_1(e_1) [H_2(e_2)]$ and $H(e_1, e_3) = H_1(e_1) [H_2(e_3)]$ are interval valued neutrosophic graphs of $G_1[G_2]$. $H_1(e_1) [H_2(e_3)]$ is shown in Fig. 3.6.

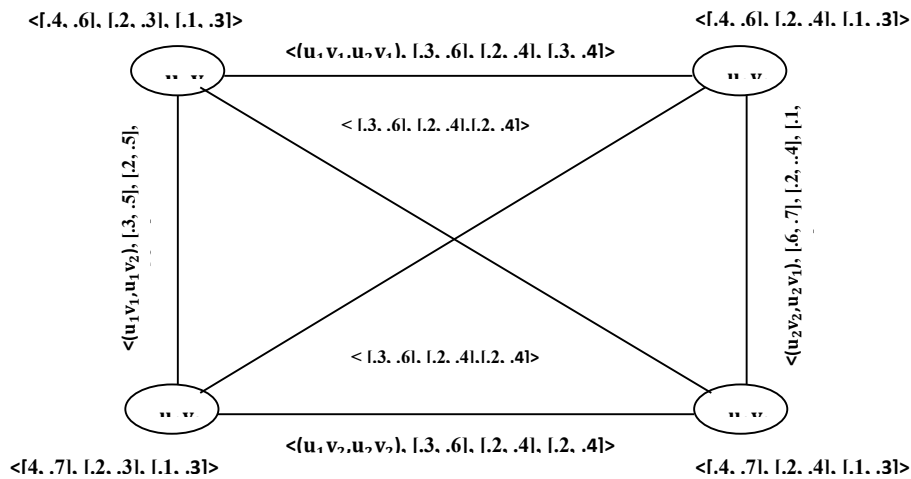

Fig. 3.6: Composition $H_1(e_1) [H_2(e_3)]$

Hence $G = G_1[G_2] = \{H_1(e_1) [H_2(e_2)], H_1(e_1) [H_2(e_3)]\}$ is an interval valued neutrosophic soft graph.

Theorem 3.11. The composition of two interval valued neutrosophic soft graph is an interval valued neutrosophic soft graph

Proof. Let $G_1=(K_1, M_1, A)$ and $G_2=(K_2, M_2, B)$ be two interval valued neutrosophic graphs of $G_1^* = (V_1, E_1)$ and $G_2^* = (V_2, E_2)$ respectively. Let $G= G_1[G_2] = (K,M, A \times B)$ be the Cartesian composition of two graphs G_1 and G_2 . We claim that $G= G_1[G_2] = (K,M, A \circ B)$ is an interval valued neutrosophic soft graph and $(H, A \circ B) = \{K_1(a_i)[K_2(b_j)], M_1(a_i)[M_2(b_j)]\}$ for all $a_i \in A, b_j \in B$ for $i= 1, 2, \dots, m, j= 1, 2, \dots, n$ are interval valued neutrosophic graphs of G .

Consider, $(x, x_2)(x, y_2) \in E$, we have

$$\begin{aligned} T_{M(a_i,b_j)}^L((x, x_2)(x, y_2)) &= \min (T_{K_1(a_i)}^L(x), T_{M_2(b_j)}^L(x_2y_2)), \text{ for } i= 1, 2, \dots, m, j= 1, \\ &2, \dots, n \\ &\leq \min \{T_{K_1(a_i)}^L(x), \min \{T_{K_2(b_j)}^L(x_2), T_{K_2(b_j)}^L(y_2)\}\} \\ &= \min \{ \min \{T_{K_1(a_i)}^L(x), T_{K_2(b_j)}^L(x_2)\}, \min \{T_{K_1(a_i)}^L(x), T_{K_2(b_j)}^L(y_2)\}\} \\ T_{M(a_i,b_j)}^L((x, x_2)(x, y_2)) &\leq \min \{ (T_{K_1(a_i)}^L \circ T_{K_2(b_j)}^L) (x, x_2), (T_{K_1(a_i)}^L \circ T_{K_2(b_j)}^L) (x, \\ &y_2), \text{ for } i= 1, 2, \dots, m, j= 1, 2, \dots, n \end{aligned}$$

Similarly, we prove that

$$\begin{aligned} T_{M(a_i,b_j)}^U((x, x_2)(x, y_2)) &\leq \min \{ (T_{K_1(a_i)}^U \circ T_{K_2(b_j)}^U) (x, x_2), (T_{K_1(a_i)}^U \circ T_{K_2(b_j)}^U) (x, \\ &y_2), \text{ for } i= 1, 2, \dots, m, j= 1, 2, \dots, n. \\ I_{M(a_i,b_j)}^L((x, x_2)(x, y_2)) &= \max (I_{K_1(a_i)}^L(x), I_{M_2(b_j)}^L(x_2y_2)), \text{ for } i= 1, 2, \dots, m, j= 1, \\ &2, \dots, n \\ &\geq \max \{I_{K_1(a_i)}^L(x), \max \{I_{K_2(b_j)}^L(x_2), I_{K_2(b_j)}^L(y_2)\}\} \\ &= \max \{ \max \{I_{K_1(a_i)}^L(x), I_{K_2(b_j)}^L(x_2)\}, \max \{I_{K_1(a_i)}^L(x), I_{K_2(b_j)}^L(y_2)\}\} \\ I_{M(a_i,b_j)}^L((x, x_2)(x, y_2)) &\geq \max \{ (I_{K_1(a_i)}^L \circ I_{K_2(b_j)}^L) (x, x_2), (I_{K_1(a_i)}^L \circ I_{K_2(b_j)}^L) (x, y_2), \text{ for } \\ &i= 1, 2, \dots, m, j= 1, 2, \dots, n \end{aligned}$$

Similarly, we prove that

$$\begin{aligned} I_{M(a_i,b_j)}^U((x, x_2)(x, y_2)) &\geq \max \{ (I_{K_1(a_i)}^U \circ I_{K_2(b_j)}^U) (x, x_2), (I_{K_1(a_i)}^U \circ I_{K_2(b_j)}^U) (x, y_2), \text{ for } \\ &i= 1, 2, \dots, m, j= 1, 2, \dots, n \\ F_{M(a_i,b_j)}^L((x, x_2)(x, y_2)) &= \max (F_{K_1(a_i)}^L(x), F_{M_2(b_j)}^L(x_2y_2)), \text{ for } i= 1, 2, \dots, m, j= 1, \\ &2, \dots, n \\ &\geq \max \{F_{K_1(a_i)}^L(x), \max \{F_{K_2(b_j)}^L(x_2), F_{K_2(b_j)}^L(y_2)\}\} \\ &= \max \{ \max \{F_{K_1(a_i)}^L(x), F_{K_2(b_j)}^L(x_2)\}, \max \{F_{K_1(a_i)}^L(x), F_{K_2(b_j)}^L(y_2)\}\} \\ F_{M(a_i,b_j)}^L((x, x_2)(x, y_2)) &\geq \max \{ (F_{K_1(a_i)}^L \circ F_{K_2(b_j)}^L) (x, x_2), (F_{K_1(a_i)}^L \circ F_{K_2(b_j)}^L) (x, \\ &y_2), \text{ for } i= 1, 2, \dots, m, j= 1, 2, \dots, n \end{aligned}$$

Similarly, we prove that

$$F_{M(a_i,b_j)}^U((x, x_2)(x, y_2)) \geq \max \{ (F_{K_1(a_i)}^U \circ F_{K_2(b_j)}^U) (x, x_2), (F_{K_1(a_i)}^U \circ F_{K_2(b_j)}^U) (x, y_2), \text{for } i= 1, 2, \dots, m, j= 1, 2, \dots, n$$

Similarly, for $(x_1, z) (y_1, z) \in E$, we have

$$\begin{aligned} T_{M(a_i,b_j)}^L((x_1, z) (y_1, z)) &\leq \min \{ (T_{K_1(a_i)}^L \circ T_{K_2(b_j)}^L) (x_1, z), (T_{K_1(a_i)}^L \circ T_{K_2(b_j)}^L) (y_1, z), \\ T_{M(a_i,b_j)}^U((x_1, z) (y_1, z)) &\leq \min \{ (T_{K_1(a_i)}^U \circ T_{K_2(b_j)}^U) (x_1, z), (T_{K_1(a_i)}^U \circ T_{K_2(b_j)}^U) (y_1, z), \\ I_{M(a_i,b_j)}^L((x_1, z) (y_1, z)) &\geq \max \{ (I_{K_1(a_i)}^L \circ I_{K_2(b_j)}^L) (x_1, z), (I_{K_1(a_i)}^L \circ I_{K_2(b_j)}^L) (y_1, z), \\ I_{M(a_i,b_j)}^U((x_1, z) (y_1, z)) &\geq \max \{ (I_{K_1(a_i)}^U \circ I_{K_2(b_j)}^U) (x_1, z), (I_{K_1(a_i)}^U \circ I_{K_2(b_j)}^U) (y_1, z), \\ F_{M(a_i,b_j)}^L((x_1, z) (y_1, z)) &\geq \max \{ (F_{K_1(a_i)}^L \circ F_{K_2(b_j)}^L) (x_1, z), (F_{K_1(a_i)}^L \circ F_{K_2(b_j)}^L) (y_1, z), \\ F_{M(a_i,b_j)}^U((x_1, z) (y_1, z)) &\geq \max \{ (F_{K_1(a_i)}^U \circ F_{K_2(b_j)}^U) (x_1, z), (F_{K_1(a_i)}^U \circ F_{K_2(b_j)}^U) (y_1, z), \text{for } i= 1, 2, \dots, m, j= 1, 2, \dots, n \end{aligned}$$

Let $(x_1, x_2) (y_1, y_2) \in E, (x_1, y_1) \in E_1$ and $x_2 \neq y_2$. Then we have

$$\begin{aligned} T_{M(a_i,b_j)}^L((x_1, x_2), (y_1, y_2)) &= \min (T_{K_1(a_i)}^L(x_1y_1), T_{K_2(b_j)}^L(x_2), T_{K_2(b_j)}^L(y_2)) \\ &\leq \min \{ \min \{ T_{K_1(a_i)}^L(x_1), T_{K_1(a_i)}^L(y_1) \}, T_{K_2(b_j)}^L(x_2), T_{K_2(b_j)}^L(y_2) \} \\ &= \min \{ \min \{ T_{K_1(a_i)}^L(x_1), T_{K_2(b_j)}^L(x_2) \}, \min \{ T_{K_1(a_i)}^L(y_1), T_{K_2(b_j)}^L(y_2) \} \} \\ T_{M(a_i,b_j)}^L((x_1, x_2), (y_1, y_2)) &\leq \min \{ T_{K(a_i,b_j)}^L(x_1, x_2), T_{K(a_i,b_j)}^L(y_1, y_2) \} \end{aligned}$$

We prove also that,

$$\begin{aligned} T_{M(a_i,b_j)}^U((x_1, x_2), (y_1, y_2)) &\geq \max \{ T_{K(a_i,b_j)}^U(x_1, x_2), T_{K(a_i,b_j)}^U(y_1, y_2) \}. \\ I_{M(a_i,b_j)}^L((x_1, x_2), (y_1, y_2)) &= \max (I_{K_1(a_i)}^L(x_1y_1), I_{K_2(b_j)}^L(x_2), I_{K_2(b_j)}^L(y_2)) \\ &\geq \max \{ \max \{ I_{K_1(a_i)}^L(x_1), I_{K_1(a_i)}^L(y_1) \}, I_{K_2(b_j)}^L(x_2), I_{K_2(b_j)}^L(y_2) \} \\ &= \max \{ \max \{ I_{K_1(a_i)}^L(x_1), I_{K_2(b_j)}^L(x_2) \}, \max \{ I_{K_1(a_i)}^L(y_1), I_{K_2(b_j)}^L(y_2) \} \} \\ I_{M(a_i,b_j)}^L((x_1, x_2), (y_1, y_2)) &\geq \max \{ I_{K(a_i,b_j)}^L(x_1, x_2), I_{K(a_i,b_j)}^L(y_1, y_2) \} \end{aligned}$$

We prove also that,

$$I_{M(a_i,b_j)}^U((x_1, x_2), (y_1, y_2)) \geq \max \{ I_{K(a_i,b_j)}^U(x_1, x_2), I_{K(a_i,b_j)}^U(y_1, y_2) \}$$

Similarly, we prove also that

$$\begin{aligned} F_{M(a_i,b_j)}^L((x_1, x_2), (y_1, y_2)) &\geq \max \{ F_{K(a_i,b_j)}^L(x_1, x_2), F_{K(a_i,b_j)}^L(y_1, y_2) \} \\ F_{M(a_i,b_j)}^U((x_1, x_2), (y_1, y_2)) &\geq \max \{ F_{K(a_i,b_j)}^U(x_1, x_2), F_{K(a_i,b_j)}^U(y_1, y_2) \} \end{aligned}$$

Hence $G= (K, M, A \circ B)$ is an interval valued neutrosophic graph.

Definition 3.12 Let $G_1=(K_1, M_1, A)$ and $G_2=(K_2, M_2, B)$ be two interval valued neutrosophic graphs of $G_1^*=(V_1, E_1)$ and $G_2^*=(V_2, E_2)$ respectively. The intersection of two graphs G_1 and G_2 is an interval valued neutrosophic soft graph $G= G_1 \cap G_2 = (K, M, A \cup B)$, where $(K, A \cup B)$ is an interval valued neutrosophic soft set over $V=V_1 \cap V_2$, $(M, A \cup B)$ is an interval valued neutrosophic soft set over $E= E_1 \cap E_2$, truth-membership, indeterminacy–membership, and falsity-membership function of G for all $x, z \in V$ defined by

$$\begin{aligned}
 1) \quad T_{K(e)}^L(x) &= \begin{cases} T_{K_1(e)}^L(x) & \text{if } e \in A - B \\ T_{K_2(e)}^L(x) & \text{if } e \in A - B \\ \min(T_{K_1(e)}^L(x), T_{K_2(e)}^L(x)) & \text{if } e \in A \cap B \end{cases} \\
 T_{K(e)}^U(x) &= \begin{cases} T_{K_1(e)}^U(x) & \text{if } e \in A - B \\ T_{K_2(e)}^U(x) & \text{if } e \in A - B \\ \min(T_{K_1(e)}^U(x), T_{K_2(e)}^U(x)) & \text{if } e \in A \cap B \end{cases} \\
 I_{K(e)}^L(x) &= \begin{cases} I_{K_1(e)}^L(x) & \text{if } e \in A - B \\ I_{K_2(e)}^L(x) & \text{if } e \in A - B \\ \max(I_{K_1(e)}^L(x), I_{K_2(e)}^L(x)) & \text{if } e \in A \cap B \end{cases} \\
 I_{K(e)}^U(x) &= \begin{cases} I_{K_1(e)}^U(x) & \text{if } e \in A - B \\ I_{K_2(e)}^U(x) & \text{if } e \in A - B \\ \max(I_{K_1(e)}^L(x), I_{K_2(e)}^U(x)) & \text{if } e \in A \cap B \end{cases} \\
 F_{K(e)}^L(x) &= \begin{cases} F_{K_1(e)}^L(x) & \text{if } e \in A - B \\ F_{K_2(e)}^L(x) & \text{if } e \in A - B \\ \max(F_{K_1(e)}^L(x), F_{K_2(e)}^L(x)) & \text{if } e \in A \cap B \end{cases} \\
 F_{K(e)}^U(x) &= \begin{cases} F_{K_1(e)}^U(x) & \text{if } e \in A - B \\ F_{K_2(e)}^U(x) & \text{if } e \in A - B \\ \max(F_{K_1(e)}^L(x), F_{K_2(e)}^U(x)) & \text{if } e \in A \cap B \end{cases} \\
 2) \quad T_{M(e)}^L(xz) &= \begin{cases} T_{M_1(e)}^L(xz) & \text{if } e \in A - B \\ T_{M_2(e)}^L(xz) & \text{if } e \in A - B \\ \min(T_{M_1(e)}^L(xz), T_{M_2(e)}^L(xz)) & \text{if } e \in A \cap B \end{cases} \\
 T_{M(e)}^U(xz) &= \begin{cases} T_{M_1(e)}^U(xz) & \text{if } e \in A - B \\ T_{M_2(e)}^U(xz) & \text{if } e \in A - B \\ \min(T_{M_1(e)}^U(xz), T_{M_2(e)}^U(xz)) & \text{if } e \in A \cap B \end{cases}
 \end{aligned}$$

$$I_{M(e)}^L(xz) = \begin{cases} I_{M_1(e)}^L(xz) & \text{if } e \in A - B \\ I_{M_2(e)}^L(xz) & \text{if } e \in A - B \\ \max(I_{M_1(e)}^L(xz), I_{M_2(e)}^L(xz)) & \text{if } e \in A \cap B \end{cases}$$

$$I_{M(e)}^U(xz) = \begin{cases} I_{M_1(e)}^U(xz) & \text{if } e \in A - B \\ I_{M_2(e)}^U(xz) & \text{if } e \in A - B \\ \max(I_{M_1(e)}^U(xz), I_{M_2(e)}^U(xz)) & \text{if } e \in A \cap B \end{cases}$$

$$F_{M(e)}^L(x) = \begin{cases} F_{M_1(e)}^L(xz) & \text{if } e \in A - B \\ F_{M_2(e)}^L(xz) & \text{if } e \in A - B \\ \max(F_{M_1(e)}^L(xz), F_{M_2(e)}^L(xz)) & \text{if } e \in A \cap B \end{cases}$$

$$F_{M(e)}^U(xz) = \begin{cases} F_{M_1(e)}^U(xz) & \text{if } e \in A - B \\ F_{M_2(e)}^U(xz) & \text{if } e \in A - B \\ \max(F_{M_1(e)}^U(xz), F_{M_2(e)}^U(xz)) & \text{if } e \in A \cap B \end{cases}$$

Example 3.13. Let $A = \{e_1, e_2\}$ and $B = \{e_1, e_4\}$ be a set of parameters. Consider two interval valued neutrosophic soft graphs $G_1 = (H_1, A) = \{H_1(e_1), H_1(e_2)\}$ and $G_2 = (H_2, B) = \{H_2(e_1), H_2(e_4)\}$ such that

$H_1(e_1) = (\{v_1 | ([0.4, 0.5], [0.1, 0.3], [0.1, 0.4]), v_2 | ([0.4, 0.6], [0.1, 0.2], [0.2, 0.3]), v_3 | ([0.2, 0.3], [0.2, 0.4], [0.1, 0.2]), v_4 | ([0.3, 0.6], [0.2, 0.3], [0.2, 0.3])\}, \{v_1 v_2 | ([0.4, 0.5], [0.2, 0.3], [0.3, 0.4]), v_2 v_3 | ([0.2, 0.3], [0.2, 0.4], [0.4, 0.5]), v_3 v_4 | ([0.2, 0.4], [0.2, 0.4], [0.4, 0.5]), v_1 v_4 | ([0.3, 0.5], [0.2, 0.3], [0.3, 0.4]), v_1 v_3 | ([0.2, 0.3], [0.2, 0.5], [0.3, 0.4])\})$.

$H_1(e_2) = (\{v_1 | ([0.4, 0.6], [0.2, 0.3], [0.1, 0.3]), v_2 | ([0.4, 0.7], [0.2, 0.4], [0.1, 0.3])\}, \{v_1 v_2 | ([0.3, 0.5], [0.4, 0.5], [0.3, 0.5])\})$.

$H_2(e_1) = (\{v_1 | ([0.3, 0.5], [0.2, 0.3], [0.3, 0.4]), v_2 | ([0.2, 0.3], [0.2, 0.3], [0.1, 0.4]), v_3 | ([0.1, 0.3], [0.2, 0.4], [0.3, 0.5])\}, \{v_1 v_2 | ([0.1, 0.2], [0.3, 0.4], [0.4, 0.5]), v_2 v_3 | ([0.1, 0.3], [0.4, 0.5], [0.4, 0.5]), v_3 v_1 | ([0.1, 0.2], [0.3, 0.5], [0.5, 0.6])\})$.

$H_2(e_4) = (\{u_1 | ([0.4, 0.6], [0.2, 0.3], [0.2, 0.4]), u_2 | ([0.4, 0.5], [0.1, 0.4], [0.2, 0.3])\}, \{u_1 u_2 | ([0.3, 0.5], [0.4, 0.5], [0.3, 0.5])\})$.

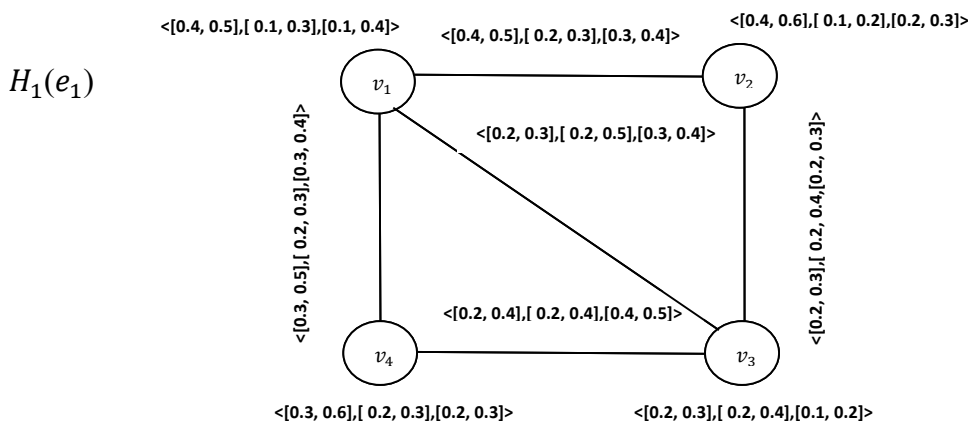

$H_1(e_2)$

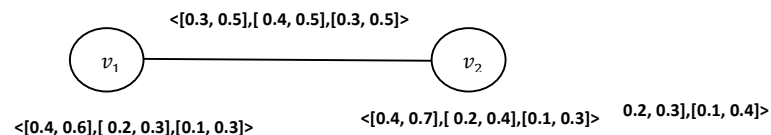

$H_2(e_1)$

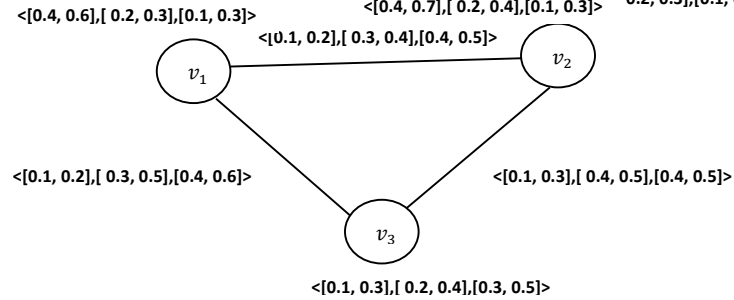

$H_2(e_4)$

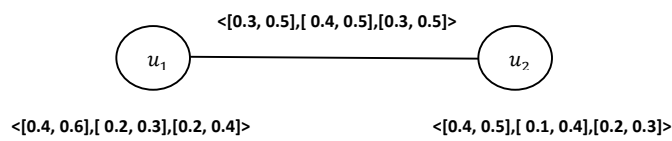
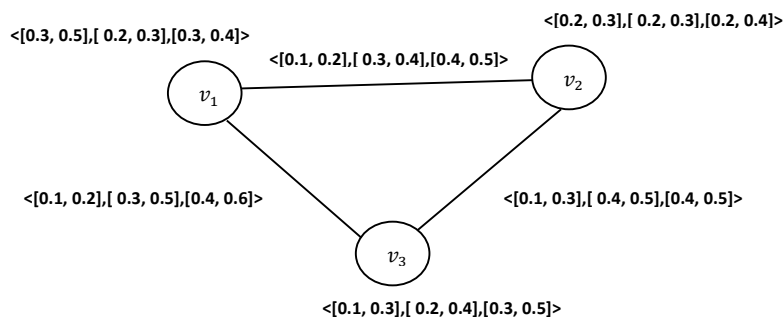

Fig. 3.7: Interval valued neutrosophic soft graph $G_1 = \{H_1(e_1), H_1(e_2)\}$ and $G_2 = \{H_2(e_1), H_2(e_4)\}$

The intersection of G_1 and G_2 is $G_1 \cap G_2 = (H, A \cup B)$, where $A \cup B = \{e_1, e_2, e_3, e_4\}$, $H(e_1) = H_1(e_1) \cap H_2(e_1)$, $H(e_2)$ and $H(e_4)$ are interval valued neutrosophic graphs of $G = G_1 \cap G_2$. are shown in Fig. 3.8.

$H(e_1)$



$H(e_2)$

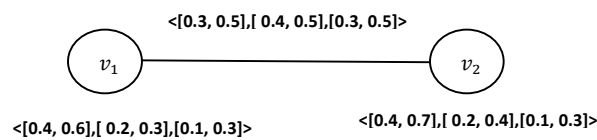

$H(e_4)$

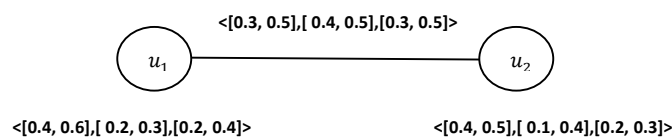

Fig. 3.8: Interval valued neutrosophic soft graph $G = G_1 \cap G_2$.

Definition 3.14 Let $G_1=(K_1, M_1, A)$ and $G_2=(K_2, M_2, B)$ be two interval valued neutrosophic graphs of $G_1^*=(V_1, E_1)$ and $G_2^*=(V_2, E_2)$ respectively. The union of two graphs G_1 and G_2 is an interval valued neutrosophic soft graph $G= G_1 \cup G_2 = (K, M, A \cup B)$, where $(K, A \cup B)$ is an interval valued neutrosophic soft set over $V=V_1 \cup V_2$, $(M, A \cup B)$ is an interval valued neutrosophic soft set over $E= E_1 \cap E_2$, truth-membership, indeterminacy-membership, and falsity-membership function of G for all $x, z \in V$ defined by:

$$\begin{aligned}
 1) \quad T_{K(e)}^L(x) &= \begin{cases} T_{K_1(e)}^L(x) & \text{if } e \in A - B \\ T_{K_2(e)}^L(x) & \text{if } e \in A - B \\ \max(T_{K_1(e)}^L(x), T_{K_2(e)}^L(x)) & \text{if } e \in A \cap B \end{cases} \\
 T_{K(e)}^U(x) &= \begin{cases} T_{K_1(e)}^U(x) & \text{if } e \in A - B \\ T_{K_2(e)}^U(x) & \text{if } e \in A - B \\ \max(T_{K_1(e)}^U(x), T_{K_2(e)}^U(x)) & \text{if } e \in A \cap B \end{cases} \\
 I_{K(e)}^L(x) &= \begin{cases} I_{K_1(e)}^L(x) & \text{if } e \in A - B \\ I_{K_2(e)}^L(x) & \text{if } e \in A - B \\ \min(I_{K_1(e)}^L(x), I_{K_2(e)}^L(x)) & \text{if } e \in A \cap B \end{cases} \\
 I_{K(e)}^U(x) &= \begin{cases} I_{K_1(e)}^U(x) & \text{if } e \in A - B \\ I_{K_2(e)}^U(x) & \text{if } e \in A - B \\ \min(I_{K_1(e)}^L(x), I_{K_2(e)}^U(x)) & \text{if } e \in A \cap B \end{cases} \\
 F_{K(e)}^L(x) &= \begin{cases} F_{K_1(e)}^L(x) & \text{if } e \in A - B \\ F_{K_2(e)}^L(x) & \text{if } e \in A - B \\ \min(F_{K_1(e)}^L(x), F_{K_2(e)}^L(x)) & \text{if } e \in A \cap B \end{cases} \\
 F_{K(e)}^U(x) &= \begin{cases} F_{K_1(e)}^U(x) & \text{if } e \in A - B \\ F_{K_2(e)}^U(x) & \text{if } e \in A - B \\ \min(F_{K_1(e)}^L(x), F_{K_2(e)}^U(x)) & \text{if } e \in A \cap B \end{cases} \\
 2) \quad T_{M(e)}^L(xz) &= \begin{cases} T_{M_1(e)}^L(xz) & \text{if } e \in A - B \\ T_{M_2(e)}^L(xz) & \text{if } e \in A - B \\ \max(T_{M_1(e)}^L(xz), T_{M_2(e)}^L(xz)) & \text{if } e \in A \cap B \end{cases} \\
 T_{M(e)}^U(xz) &= \begin{cases} T_{M_1(e)}^U(xz) & \text{if } e \in A - B \\ T_{M_2(e)}^U(xz) & \text{if } e \in A - B \\ \max(T_{M_1(e)}^U(xz), T_{M_2(e)}^U(xz)) & \text{if } e \in A \cap B \end{cases}
 \end{aligned}$$

$$I_{M(e)}^L(xz) = \begin{cases} I_{M_1(e)}^L(xz) & \text{if } e \in A - B \\ I_{M_2(e)}^L(xz) & \text{if } e \in A - B \\ \min(I_{M_1(e)}^L(xz), I_{M_2(e)}^L(xz)) & \text{if } e \in A \cap B \end{cases}$$

$$I_{M(e)}^U(xz) = \begin{cases} I_{M_1(e)}^U(xz) & \text{if } e \in A - B \\ I_{M_2(e)}^U(xz) & \text{if } e \in A - B \\ \min(I_{M_1(e)}^U(xz), I_{M_2(e)}^U(xz)) & \text{if } e \in A \cap B \end{cases}$$

$$F_{M(e)}^L(x) = \begin{cases} F_{M_1(e)}^L(xz) & \text{if } e \in A - B \\ F_{M_2(e)}^L(xz) & \text{if } e \in A - B \\ \min(F_{M_1(e)}^L(xz), F_{M_2(e)}^L(xz)) & \text{if } e \in A \cap B \end{cases}$$

$$F_{M(e)}^U(xz) = \begin{cases} F_{M_1(e)}^U(xz) & \text{if } e \in A - B \\ F_{M_2(e)}^U(xz) & \text{if } e \in A - B \\ \min(F_{M_1(e)}^L(xz), F_{M_2(e)}^U(xz)) & \text{if } e \in A \cap B \end{cases}$$

Definition 3.16. Let G_1 and G_2 be two interval valued neutrosophic soft graphs denoted by $G_1 + G_2 = (K_1 + K_2, M_1 + M_2, A \cup B)$, Where $(K_1 + K_2, A \cup B)$ is an interval valued neutrosophic soft set over $V_1 \cup V_2$, $(M_1 + M_2, A \cup B)$ is an interval valued neutrosophic soft set over $E_1 \cup E_2 \cup E'$ defined by

$$(K_1 + K_2, A \cup B) = (K_1, A) \cup (K_2, B)$$

$$(M_1 + M_2, A \cup B) = (M_1, A) \cup (M_2, B) \text{ if } xz \in E_1 \cup E_2,$$

when $e \in A \cap B, xz \in E'$, where E' is the set of all edge joining the vertices of V_1 and V_2 .

Definition 3.17 The complement of an interval valued neutrosophic soft graph $G = (K, M, A)$ denoted by $\bar{G} = (\bar{K}, \bar{M}, \bar{A})$.

1. $\bar{A} = A$
2. $\bar{K}(e) = K(e)$,
3. $T_{\bar{M}(e)}^L(x, z) = \min(T_{K(e)}^L(x), T_{K(e)}^L(z)) - T_{M(e)}^L(x, z)$,
 $T_{\bar{M}(e)}^U(x, z) = \min(T_{K(e)}^U(x), T_{K(e)}^U(z)) - T_{M(e)}^U(x, z)$,
 $I_{\bar{M}(e)}^L(x, z) = \min(I_{K(e)}^L(x), I_{K(e)}^L(z)) - I_{M(e)}^L(x, z)$,
 $I_{\bar{M}(e)}^U(x, z) = \min(I_{K(e)}^U(x), I_{K(e)}^U(z)) - I_{M(e)}^U(x, z)$,
 $F_{\bar{M}(e)}^L(x, z) = \min(F_{K(e)}^L(x), F_{K(e)}^L(z)) - F_{M(e)}^L(x, z)$,
 $F_{\bar{M}(e)}^U(x, z) = \min(F_{K(e)}^U(x), F_{K(e)}^U(z)) - F_{M(e)}^U(x, z)$, for all $x, z \in V, e \in A$.

Definition 3.18 An interval valued neutrosophic soft graph G is a complete interval valued neutrosophic soft graph if $H(e)$ is a complete interval valued neutrosophic graph of G for all $e \in A$, i.e.

$$T_{M(e)}^L(x, z) = \min(T_{K(e)}^L(x), T_{K(e)}^L(z))$$

$$T_{M(e)}^U(x, z) = \min(T_{K(e)}^U(x), T_{K(e)}^U(z))$$

$$\begin{aligned}
 I_{M(e)}^L(x,z) &= \min(I_{K(e)}^L(x), I_{K(e)}^L(z)) \\
 I_{M(e)}^U(x,z) &= \min(T_{K(e)}^L(x), I_{K(e)}^L(z)) \\
 F_{M(e)}^L(x,z) &= \min(F_{K(e)}^L(x), F_{K(e)}^L(z)) \\
 F_{M(e)}^U(x,z) &= \min(T_{K(e)}^L(x), F_{K(e)}^L(z)), \text{ For all } x, z \in V, e \in A.
 \end{aligned}$$

Example 3.19. Consider a simple graph $G^*=(V, E)$ such that $V=\{u_1, u_2, u_3, u_4\}$ and $E=\{u_1u_2, u_2u_3, u_3u_1\}$.

Let $A= \{e_1, e_2, e_3\}$ be a set of parameters. Let (K, A) be an interval valued neutrosophic graph soft sets over V with its approximation function. $K:A \rightarrow P(V)$ defined by

$$K(e_1)=(\{u_1|([0.1, 0.4], [0.1, 0.3], [0.2, 0.3]), u_2|([0.1, 0.3], [0.1, 0.2], [0.1, 0.4]), u_3|([0.1, 0.2], [0.2, 0.3], [0.2, 0.5])\}).$$

$$K(e_2)=(\{u_1|([0.3, 0.5], [0.2, 0.3], [0.3, 0.4]), u_2|([0.2, 0.3], [0.2, 0.3], [0.1, 0.4]), u_3|([0.1, 0.3], [0.2, 0.4], [0.3, 0.5])\}).$$

$$K(e_3)=(\{u_1|([0.4, 0.5], [0.1, 0.3], [0.1, 0.4]), u_2|([0.4, 0.6], [0.1, 0.2], [0.2, 0.3]), u_3|([0.2, 0.3], [0.2, 0.4], [0.1, 0.2]), u_4|([0.3, 0.6], [0.2, 0.3], [0.2, 0.3])\}).$$

Let (M, A) be an interval valued neutrosophic graph soft sets over E with its approximation function. $M:A \rightarrow P(E)$ defined by

$$M(e_1)=\{u_1u_2|([0.1, 0.3], [0.1, 0.3], [0.2, 0.4]), u_2u_3|([0.1, 0.2], [0.2, 0.3], [0.2, 0.5]), u_3u_1|([0.1, 0.2], [0.2, 0.3], [0.2, 0.5])\}.$$

$$M(e_2)=\{u_1u_2|([0.1, 0.3], [0.2, 0.3], [0.3, 0.4]), u_2u_3|([0.1, 0.3], [0.2, 0.4], [0.3, 0.5]), u_3u_1|([0.1, 0.3], [0.2, 0.4], [0.3, 0.5])\}.$$

$$M(e_3)=\{u_1u_2|([0.4, 0.5], [0.1, 0.3], [0.2, 0.4]), u_2u_3|([0.2, 0.3], [0.2, 0.4], [0.2, 0.3]), u_3u_4|([0.2, 0.3], [0.2, 0.4], [0.2, 0.3]), u_4u_1|([0.3, 0.5], [0.2, 0.3], [0.2, 0.4]), u_1u_3|([0.2, 0.3], [0.2, 0.4], [0.1, 0.4]), u_2u_4|([0.2, 0.6], [0.2, 0.4], [0.2, 0.3])\}$$

It is easy to see that $H(e_1), H(e_2), H(e_3)$ are complete interval valued neutrosophic graphs of G corresponding to the parameter e_1, e_2, e_3 respectively as shown in Fig. 3.9.

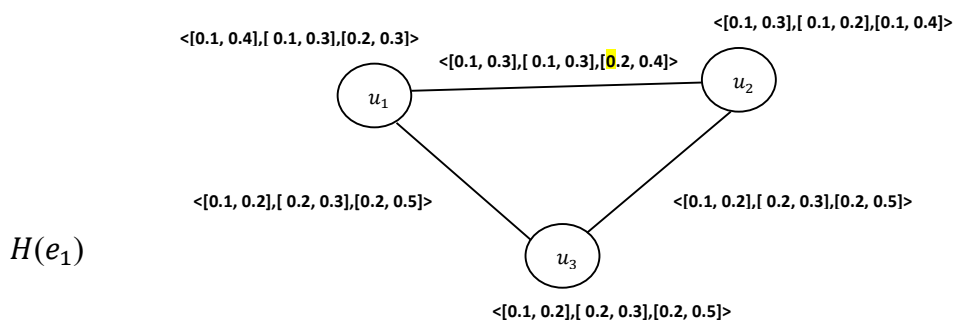

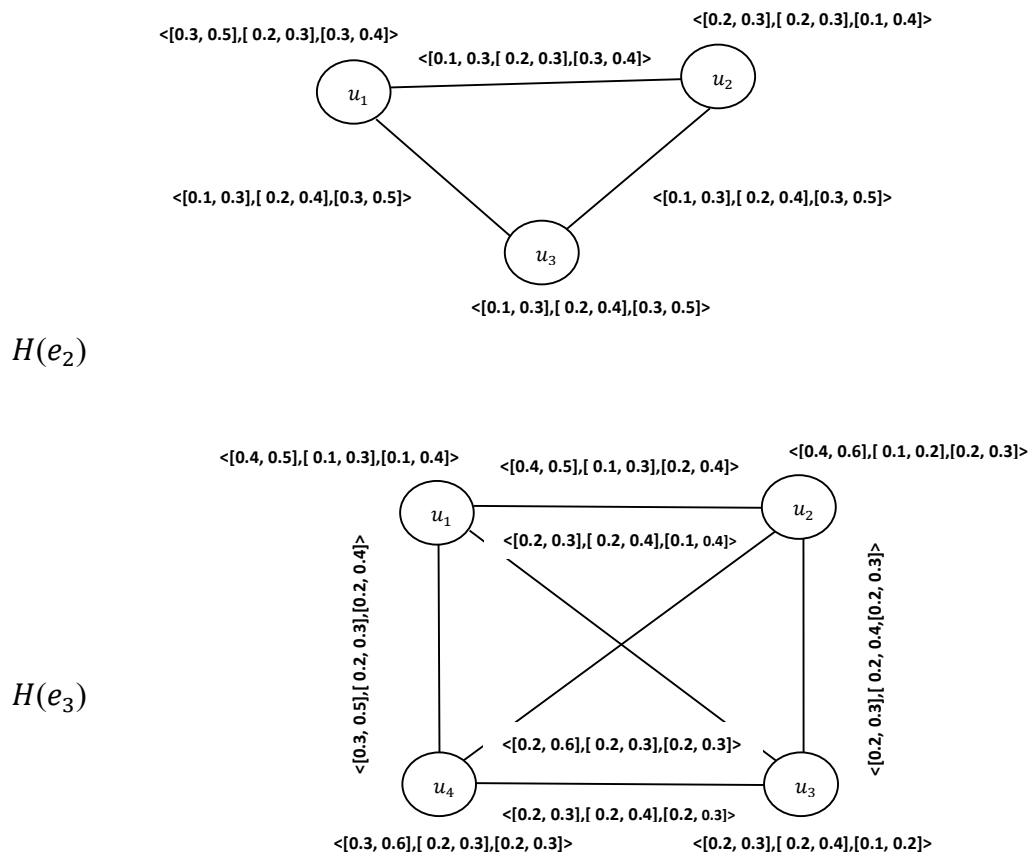

Fig. 3.9: Complete interval valued neutrosophic soft graph $G = \{H(e_1), H(e_2), H(e_3)\}$.

Definition 3.20: An interval valued neutrosophic soft graph G is a strong interval valued neutrosophic soft graph if $H(e)$ is a strong interval valued neutrosophic graph of G for all $e \in A$, i.e.

$$\begin{aligned}
 T_{M(e)}^L(x, z) &= \min(T_{K(e)}^L(x), T_{K(e)}^L(z)) \\
 T_{M(e)}^U(x, z) &= \min(T_{K(e)}^U(x), T_{K(e)}^U(z)) \\
 I_{M(e)}^L(x, z) &= \min(I_{K(e)}^L(x), I_{K(e)}^L(z)) \\
 I_{M(e)}^U(x, z) &= \min(I_{K(e)}^U(x), I_{K(e)}^U(z)) \\
 F_{M(e)}^L(x, z) &= \min(F_{K(e)}^L(x), F_{K(e)}^L(z)) \\
 F_{M(e)}^U(x, z) &= \min(F_{K(e)}^U(x), F_{K(e)}^U(z)), \text{ for all } x, z \in V, e \in A.
 \end{aligned}$$

Example 3.21. Consider a simple graph $G^* = (V, E)$ such that $V = \{u_1, u_2, u_3, u_4\}$ and $E = \{u_1u_2, u_2u_3, u_3u_1\}$.

Let $A = \{e_1, e_2, e_3\}$ be a set of parameters. Let (K, A) be an interval valued neutrosophic graph soft sets over V with its approximation function. $K: A \rightarrow P(V)$ defined by

$$\begin{aligned}
 K(e_1) &= (\{u_1 | ([0.1, 0.4], [0.1, 0.3], [0.2, 0.3]), u_2 | ([0.1, 0.3], [0.1, 0.2], [0.1, 0.4]), \\
 &u_3 | ([0.1, 0.2], [0.2, 0.3], [0.2, 0.5])\}) \\
 K(e_2) &= (\{u_1 | ([0.3, 0.5], [0.2, 0.3], [0.3, 0.4]), u_2 | ([0.2, 0.3], [0.2, 0.3], [0.1, 0.4]), \\
 &u_3 | ([0.1, 0.3], [0.2, 0.4], [0.3, 0.5])\})
 \end{aligned}$$

$$K(e_3) = (\{u_1 | ([0.4, 0.5], [0.1, 0.3], [0.1, 0.4]), u_2 | ([0.4, 0.6], [0.1, 0.2], [0.2, 0.3]), u_3 | ([0.2, 0.3], [0.2, 0.4], [0.1, 0.2]), u_4 | ([0.3, 0.6], [0.2, 0.3], [0.2, 0.3])\})$$

Let (M, A) be an interval valued neutrosophic graph soft sets over E with its approximation function. $M: A \rightarrow P(E)$ defined by

$$M(e_1) = \{u_1 u_2 | ([0.1, 0.3], [0.1, 0.3], [0.2, 0.4]), u_2 u_3 | ([0.1, 0.2], [0.2, 0.3], [0.2, 0.5]), u_3 u_1 | ([0.1, 0.2], [0.2, 0.3], [0.2, 0.5])\}$$

$$M(e_2) = \{u_1 u_2 | ([0.1, 0.3], [0.2, 0.3], [0.3, 0.4]), u_2 u_3 | ([0.1, 0.3], [0.2, 0.4], [0.3, 0.5]), u_3 u_1 | ([0.1, 0.3], [0.2, 0.4], [0.3, 0.5])\}$$

$$M(e_3) = \{u_1 u_2 | ([0.4, 0.6], [0.1, 0.3], [0.2, 0.4]), u_2 u_3 | ([0.2, 0.3], [0.2, 0.4], [0.2, 0.3]), u_3 u_4 | ([0.2, 0.3], [0.2, 0.4], [0.2, 0.3]), u_4 u_1 | ([0.3, 0.5], [0.2, 0.3], [0.2, 0.4])\}$$

It is easy to see that $H(e_1), H(e_2), H(e_3)$ are strong interval valued neutrosophic graphs of G corresponding to the parameters e_1, e_2, e_3 respectively as shown in Fig. 3.10.

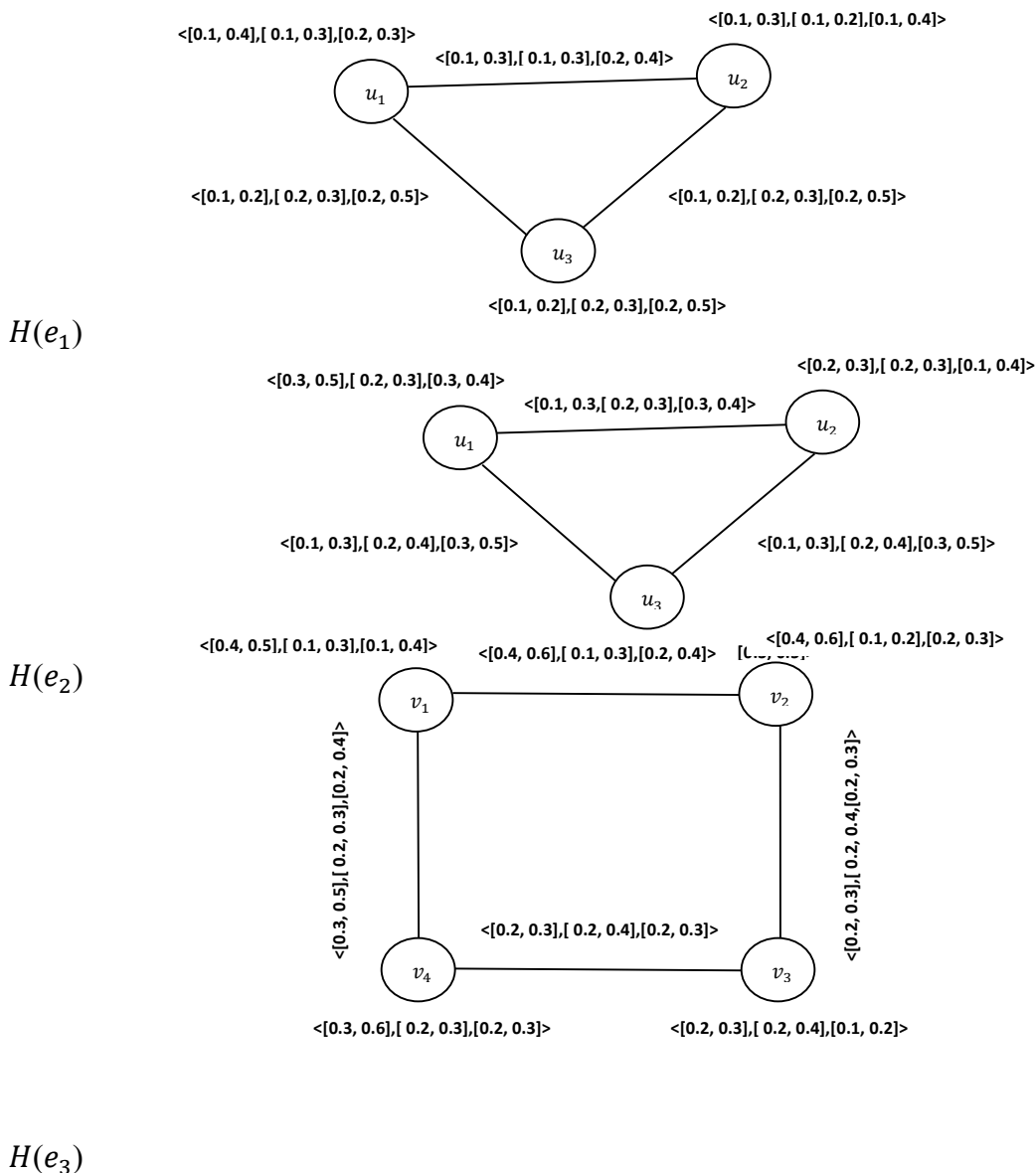

Fig. 3.10: Strong interval valued neutrosophic soft graph $G = \{H(e_1), H(e_2), H(e_3)\}$.

4. APPLICATION

Interval valued neutrosophic soft set has several applications in decision making problems and can be used to deal with uncertainties from our different daily life problems. In this section, we

apply the concept of interval valued neutrosophic soft sets in a decision making problem and then give an algorithm for the selection of optimal object based upon given sets of information.

Suppose that $V=\{h_1,h_2,h_3,h_4,h_5\}$ is the set of five houses under consideration. Mr. X is going to buy one of the houses on the basis of wishing parameters or attributes set $A=\{e_1=\text{large}, e_2=\text{beautiful}, e_3=\text{green surrounding}\}$. (K, A) is the interval valued neutrosophic soft set on V which describes the value of the houses based upon the given parameters $e_1=\text{large}, e_2=\text{beautiful}, e_3=\text{green surrounding}$, respectively.

$$K(e_1)=\{h_1|([0.3, 0.4], [0.2, 0.3], [0.3, 0.4]), h_3|([0.2, 0.3], [0.2, 0.3], [0.1, 0.4]), h_4|([0.2, 0.3], [0.2, 0.4], [0.3, 0.5])\}.$$

$$K(e_2)=\{h_1|([0.2, 0.5], [0.1, 0.3], [0.1, 0.3]), h_2|([0.3, 0.4], [0.1, 0.2], [0.2, 0.3]), h_3|([0.2, 0.3], [0.2, 0.3], [0.3, 0.4]), h_4|([0.3, 0.4], [0.2, 0.3], [0.1, 0.2]), h_5|([0.3, 0.4], [0.1, 0.2], [0.2, 0.4])\}.$$

$$K(e_3)=\{h_1|([0.4, 0.5], [0.1, 0.3], [0.1, 0.4]), h_2|([0.4, 0.6], [0.1, 0.2], [0.2, 0.3]), h_3|([0.2, 0.3], [0.2, 0.4], [0.1, 0.2]), h_4|([0.3, 0.6], [0.2, 0.3], [0.2, 0.3]), h_5|([0.2, 0.3], [0.2, 0.3], [0.2, 0.4])\}.$$

(M, A) is an interval valued neutrosophic soft sets on $E= \{h_1h_2, h_1h_3, h_1h_4, h_1h_5, h_2h_3, h_2h_4, h_2h_5, h_3h_4, h_4h_5\}$ which describe the value of two houses corresponding to the given parameters e_1, e_2 and e_3 .

$$M(e_1)=\{h_1h_3|([0.1, 0.2], [0.2, 0.3], [0.3, 0.4]), h_3h_4|([0.1, 0.2], [0.2, 0.5], [0.3, 0.5]), h_1h_4|([0.2, 0.3], [0.3, 0.4], [0.3, 0.5])\}.$$

$$M(e_2)=\{h_1h_2|([0.2, 0.3], [0.2, 0.3], [0.2, 0.4]), h_1h_4|([0.2, 0.3], [0.2, 0.4], [0.2, 0.4]), h_1h_5|([0.1, 0.3], [0.3, 0.4], [0.3, 0.5]), h_2h_4|([0.2, 0.3], [0.2, 0.4], [0.4, 0.5]), h_4h_5|([0.1, 0.2], [0.2, 0.4], [0.2, 0.5]), h_4h_3|([0.2, 0.3], [0.2, 0.3], [0.3, 0.4])\}.$$

$$M(e_3)=\{h_1h_2|([0.4, 0.6], [0.2, 0.3], [0.3, 0.4]), h_1h_4|([0.3, 0.5], [0.3, 0.4], [0.2, 0.4]), h_2h_3|([0.2, 0.3], [0.2, 0.5], [0.3, 0.4]), h_2h_5|([0.1, 0.2], [0.3, 0.4], [0.4, 0.5]), h_2h_4|([0.2, 0.4], [0.3, 0.4], [0.5, 0.6]), h_3h_4|([0.2, 0.3], [0.4, 0.5], [0.2, 0.3])\}.$$

The interval valued neutrosophic soft sets $H(e_1), H(e_2), H(e_3)$ of interval valued neutrosophic graphs of $G=(K, M, A)$ corresponding to the parameter e_1, e_2, e_3 respectively, as shown in Fig. 3.11.

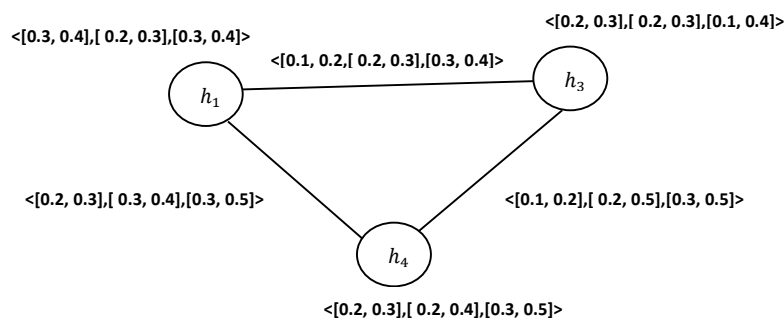

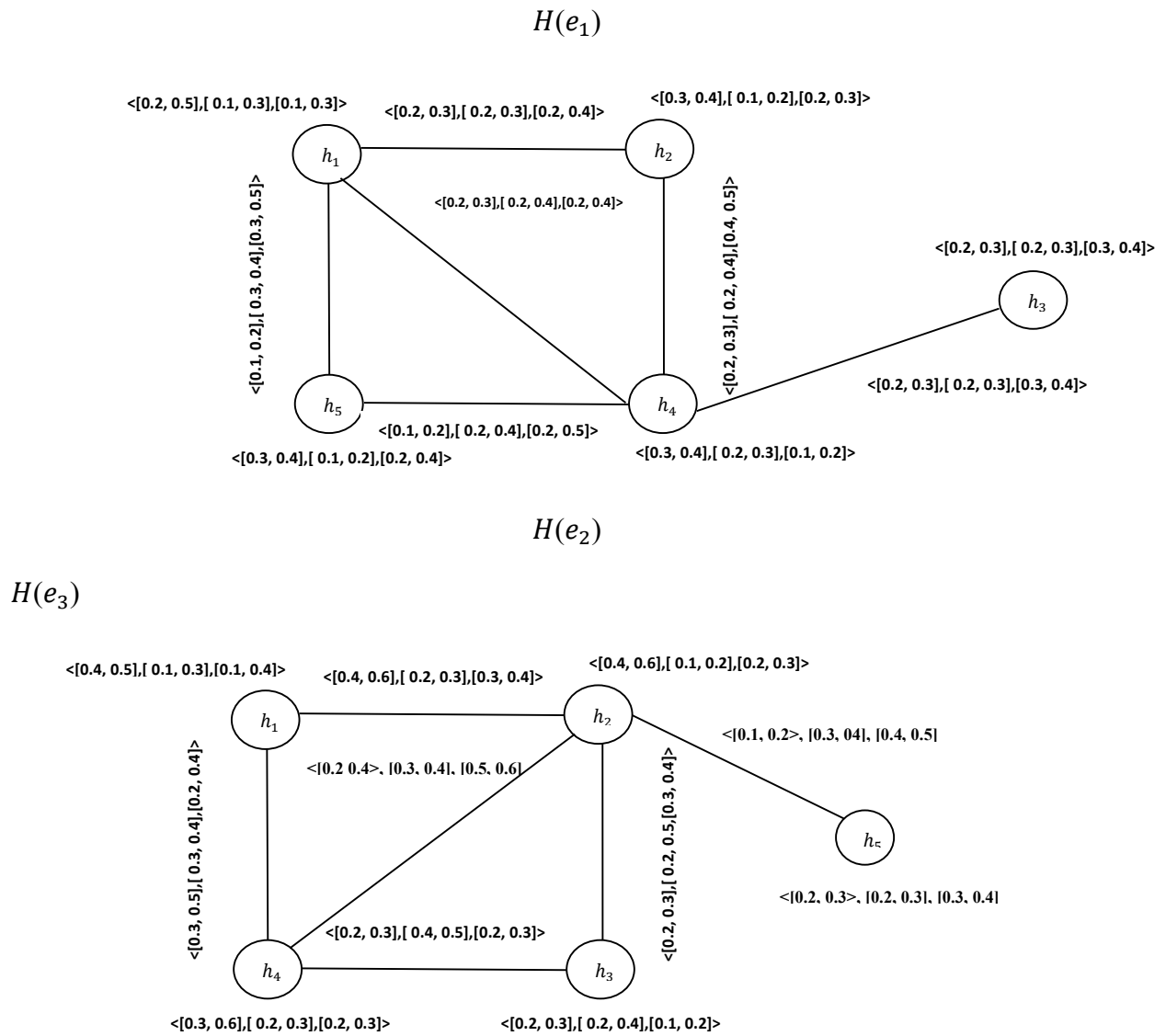

Fig. 3.11: Interval valued neutrosophic soft graph $G = \{ H(e_1), H(e_2), H(e_3) \}$.

The interval valued neutrosophic graphs $H(e_1), H(e_2), H(e_3)$ corresponding to the parameters “large”, “beautiful” and “green surrounding”, respectively are represented by the following incidence matrix.

$H(e_1) =$

$\langle [0, 0], [0, 0], [0, 0] \rangle$	$\langle [0, 0], [0, 0], [0, 0] \rangle$	$\langle [0.1, 0.2], [0.2, 0.3], [0.3, 0.4] \rangle$	$\langle [0.2, 0.3], [0.3, 0.4], [0.3, 0.5] \rangle$
$\langle [0, 0], [0, 0], [0, 0] \rangle$	$\langle [0, 0], [0, 0], [0, 0] \rangle$	$\langle [0, 0], [0, 0], [0, 0] \rangle$	$\langle [0, 0], [0, 0], [0, 0] \rangle$
$\langle [0.1, 0.2], [0.2, 0.3], [0.3, 0.4] \rangle$	$\langle [0, 0], [0, 0], [0, 0] \rangle$	$\langle [0, 0], [0, 0], [0, 0] \rangle$	$\langle [0.1, 0.2], [0.2, 0.5], [0.3, 0.5] \rangle$
$\langle [0.2, 0.3], [0.3, 0.4], [0.3, 0.5] \rangle$	$\langle [0, 0], [0, 0], [0, 0] \rangle$	$\langle [0.1, 0.2], [0.2, 0.5], [0.3, 0.5] \rangle$	$\langle [0, 0], [0, 0], [0, 0] \rangle$
$\langle [0, 0], [0, 0], [0, 0] \rangle$	$\langle [0, 0], [0, 0], [0, 0] \rangle$	$\langle [0, 0], [0, 0], [0, 0] \rangle$	$\langle [0, 0], [0, 0], [0, 0] \rangle$
$\langle [0, 0], [0, 0], [0, 0] \rangle$ $\langle [0, 0], [0, 0], [0, 0] \rangle$ $\langle [0, 0], [0, 0], [0, 0] \rangle$ $\langle [0, 0], [0, 0], [0, 0] \rangle$ $\langle [0, 0], [0, 0], [0, 0] \rangle$			

$$H(e_2) = \begin{matrix} < [0, 0], [0, 0], [0, 0] > & < [0.2, 0.3], [0.2, 0.3], [0.2, 0.4] > & < [0, 0], [0, 0], [0, 0] > & < [0.2, 0.3], [0.2, 0.4], [0.2, 0.4] > \\ < [0.2, 0.3], [0.2, 0.3], [0.2, 0.4] > & < [0, 0], [0, 0], [0, 0] > & < [0, 0], [0, 0], [0, 0] > & < [0.2, 0.3], [0.2, 0.4], [0.4, 0.5] > \\ < [0, 0], [0, 0], [0, 0] > & < [0, 0], [0, 0], [0, 0] > & < [0, 0], [0, 0], [0, 0] > & < [0.2, 0.3], [0.2, 0.3], [0.3, 0.4] > \\ < [0.2, 0.3], [0.2, 0.4], [0.2, 0.4] > & < [0.2, 0.3], [0.2, 0.4], [0.4, 0.5] > & < [0.2, 0.3], [0.2, 0.3], [0.3, 0.4] > & < [0, 0], [0, 0], [0, 0] > \\ < [0.1, 0.3], [0.3, 0.4], [0.3, 0.5] > & < [0, 0], [0, 0], [0, 0] > & < [0, 0], [0, 0], [0, 0] > & < [0.1, 0.2], [0.2, 0.4], [0.2, 0.5] > \\ < [0.1, 0.3], [0.3, 0.4], [0.3, 0.5] > & < [0, 0], [0, 0], [0, 0] > & < [0, 0], [0, 0], [0, 0] > & < [0, 0], [0, 0], [0, 0] > \\ < [0, 0], [0, 0], [0, 0] > & < [0, 0], [0, 0], [0, 0] > & < [0, 0], [0, 0], [0, 0] > & < [0, 0], [0, 0], [0, 0] > \\ < [0, 0], [0, 0], [0, 0] > & < [0, 0], [0, 0], [0, 0] > & < [0, 0], [0, 0], [0, 0] > & < [0, 0], [0, 0], [0, 0] > \\ < [0.1, 0.2], [0.2, 0.4], [0.2, 0.5] > & < [0, 0], [0, 0], [0, 0] > & < [0, 0], [0, 0], [0, 0] > & < [0, 0], [0, 0], [0, 0] > \\ < [0, 0], [0, 0], [0, 0] > & < [0, 0], [0, 0], [0, 0] > & < [0, 0], [0, 0], [0, 0] > & < [0, 0], [0, 0], [0, 0] > \end{matrix}$$

And $H(e_3) =$

$$\begin{matrix} < [0, 0], [0, 0], [0, 0] > & < [0.4, 0.6], [0.2, 0.3], [0.3, 0.4] > & < [0, 0], [0, 0], [0, 0] > & < [0.3, 0.5], [0.3, 0.4], [0.2, 0.4] > \\ < [0.4, 0.6], [0.2, 0.3], [0.3, 0.4] > & < [0, 0], [0, 0], [0, 0] > & < [0.2, 0.3], [0.2, 0.5], [0.3, 0.4] > & < [0.2, 0.4], [0.3, 0.4], [0.5, 0.6] > \\ < [0, 0], [0, 0], [0, 0] > & < [0.2, 0.3], [0.2, 0.5], [0.3, 0.4] > & < [0, 0], [0, 0], [0, 0] > & < [0.2, 0.3], [0.4, 0.5], [0.2, 0.3] > \\ < [0.3, 0.5], [0.3, 0.4], [0.2, 0.4] > & < [0.2, 0.4], [0.3, 0.4], [0.5, 0.6] > & < [0.2, 0.3], [0.4, 0.5], [0.2, 0.3] > & < [0, 0], [0, 0], [0, 0] > \\ < [0, 0], [0, 0], [0, 0] > & < [0.1, 0.2], [0.3, 0.4], [0.4, 0.5] > & < [0, 0], [0, 0], [0, 0] > & < [0, 0], [0, 0], [0, 0] > \\ < [0, 0], [0, 0], [0, 0] > & < [0, 0], [0, 0], [0, 0] > & < [0, 0], [0, 0], [0, 0] > & < [0, 0], [0, 0], [0, 0] > \\ < [0.1, 0.2], [0.3, 0.4], [0.4, 0.5] > & < [0, 0], [0, 0], [0, 0] > & < [0, 0], [0, 0], [0, 0] > & < [0, 0], [0, 0], [0, 0] > \\ < [0, 0], [0, 0], [0, 0] > & < [0, 0], [0, 0], [0, 0] > & < [0, 0], [0, 0], [0, 0] > & < [0, 0], [0, 0], [0, 0] > \\ < [0, 0], [0, 0], [0, 0] > & < [0, 0], [0, 0], [0, 0] > & < [0, 0], [0, 0], [0, 0] > & < [0, 0], [0, 0], [0, 0] > \\ < [0, 0], [0, 0], [0, 0] > & < [0, 0], [0, 0], [0, 0] > & < [0, 0], [0, 0], [0, 0] > & < [0, 0], [0, 0], [0, 0] > \\ < [0, 0], [0, 0], [0, 0] > & < [0, 0], [0, 0], [0, 0] > & < [0, 0], [0, 0], [0, 0] > & < [0, 0], [0, 0], [0, 0] > \end{matrix}$$

After performing some operation (AND or OR); we obtain the resultant interval valued neutrosophic graph $H(e)$, where $e = e_1 \wedge e_2 \wedge e_3$. The incidence matrix of resultant interval neutrosophic soft graph is

$$H(e_3) = \begin{matrix} < [0, 0], [0, 0], [0, 0] > & < [0.2, 0.3], [0.2, 0.3], [0.3, 0.4] > & < [0, 0], [0.2, 0.3], [0.3, 0.4] > & < [0.2, 0.3], [0.3, 0.4], [0.3, 0.5] > \\ < [0, 0], [0.3, 0.4], [0.4, 0.5] > & < [0, 0], [0, 0], [0, 0] > & < [0, 0], [0.2, 0.5], [0.3, 0.4] > & < [0, 0], [0.3, 0.4], [0.5, 0.6] > \\ < [0, 0], [0.2, 0.3], [0.3, 0.4] > & < [0, 0], [0.2, 0.5], [0.3, 0.4] > & < [0, 0], [0, 0], [0, 0] > & < [0.1, 0.2], [0.4, 0.5], [0.2, 0.3] > \\ < [0, 0], [0.3, 0.4], [0.3, 0.5] > & < [0.2, 0.3], [0.3, 0.4], [0.5, 0.6] > & < [0.1, 0.2], [0.4, 0.5], [0.3, 0.5] > & < [0, 0], [0, 0], [0, 0] > \\ < [0, 0], [0.3, 0.4], [0.3, 0.5] > & < [0, 0], [0.3, 0.4], [0.4, 0.5] > & < [0, 0], [0, 0], [0, 0] > & < [0, 0], [0.2, 0.4], [0.2, 0.5] > \\ < [0, 0], [0.3, 0.4], [0.4, 0.5] > & < [0, 0], [0.3, 0.4], [0.4, 0.5] > & < [0, 0], [0, 0], [0, 0] > & < [0, 0], [0.2, 0.4], [0.2, 0.5] > \\ < [0, 0], [0.3, 0.4], [0.4, 0.5] > & < [0, 0], [0, 0], [0, 0] > & < [0, 0], [0, 0], [0, 0] > & < [0, 0], [0, 0], [0, 0] > \\ < [0, 0], [0, 0], [0, 0] > & < [0, 0], [0, 0], [0, 0] > & < [0, 0], [0, 0], [0, 0] > & < [0, 0], [0, 0], [0, 0] > \\ < [0, 0], [0.2, 0.4], [0.2, 0.5] > & < [0, 0], [0, 0], [0, 0] > & < [0, 0], [0, 0], [0, 0] > & < [0, 0], [0, 0], [0, 0] > \\ < [0, 0], [0, 0], [0, 0] > & < [0, 0], [0, 0], [0, 0] > & < [0, 0], [0, 0], [0, 0] > & < [0, 0], [0, 0], [0, 0] > \end{matrix}$$

Sahin (2015) defined the average possible membership degree of element x to interval valued neutrosophic set $A = \langle [T_A^L(x), T_A^U(x)], [I_A^L(x), I_A^U(x)], [F_A^L(x), F_A^U(x)] \rangle$ as follows:

$$S_k(x) = \frac{1}{3} \left[\frac{T_A^L(x) + T_A^U(x)}{2} + 1 - \frac{I_A^L(x) + I_A^U(x)}{2} + 1 - \frac{F_A^L(x) + F_A^U(x)}{2} \right]$$

$$= \frac{T_A^L(x) + T_A^U(x) + 4 - I_A^L(x) - I_A^U(x) - F_A^L(x) - F_A^U(x)}{6}$$

Based on $S_k(x)$ we depicted the Tabular representation of score value of incidence matrix of resultant interval valued neutrosophic graph $H(e)$ with S_k and choice value for each house h_k for $k = 1, 2, 3, 4$.

Table 2. Tabular representation of score values with choice values.

	h_1	h_2	h_3	h_4	h_5	h'_k
h_1	0.666	0.55	0.466	0.5	0.4	2,582
h_2	0.4	0.666	0.433	0.366	0.4	2,265
h_3	0.466	0.433	0.666	0.483	0.666	2,714
h_4	0.416	0.45	0.433	0.666	0.45	2,415
h_5	0.416	0.383	0.666	0.45	0.666	2,581

Clearly, the maximum score value is 2,714, scored by the h_3 Mr. X, will buy the house h_3 .

We present our method as an algorithm that is used in our application.

Algorithm

1. Input the set P of choice of parameters of Mr. X, A is subset of P.
2. Input the interval valued neutrosophic soft sets (K, A) and (M, A).
3. Construct the interval valued neutrosophic soft graph $G = (K, M, A)$.
4. Compute the resultant interval valued neutrosophic soft graph
 $H(e) = \bigcap_k H(e_k)$ fore $= \bigwedge_k e_k \forall k$.
5. Consider the interval valued neutrosophic graph H(e) and its incidence matrix form.
6. Compute the score S_k of $h_k \forall k$.
7. The decision is h_k if $h'_k = \max_i h_k$.
8. If k has more than one value then any one of h_k may be chosen.

5. CONCLUSION

Interval valued neutrosophic soft sets is a generalization of fuzzy soft sets, intuitionistic fuzzy soft sets and neutrosophic soft sets. The neutrosophic set model is an important tool for dealing with real scientific and engineering applications; it can handle not only incomplete information, but also the inconsistent information and indeterminate information which exists in real situations. Interval valued neutrosophic models give more precisions, flexibility and compatibility to the system as compared to the classical, fuzzy and/or intuitionistic fuzzy and single valued neutrosophic models. In this paper, we have introduced certain types of interval valued neutrosophic soft graphs, such as strong interval valued neutrosophic soft graph, complete interval valued neutrosophic soft graphs and complement of strong interval valued neutrosophic soft graphs. We introduced some operations such as Cartesian product, composition, intersection, union and join on an interval valued neutrosophic soft graphs. We presented an application of interval valued neutrosophic soft graphs in decision making. In future studies, we plan to extend our research to regular interval valued neutrosophic soft graphs and irregular interval valued neutrosophic soft graphs.

REFERENCES

- Aydoğdu, A. (2015). On similarity and entropy of single valued neutrosophic sets. *General Mathematics Notes*, 29 (1), 67-74.
- Ansari, A. Q., Biswas, R., & Aggarwal, S. (2012). Neutrosophic classifier: An extension of fuzzy classifier. *Elsevier- Applied Soft Computing*, 13, 563-573 <http://dx.doi.org/10.1016/j.asoc.2012.08.002>
- Ansari, A. Q., Biswas, R., & Aggarwal, S. (2013). Neutrosophication of fuzzy models, *IEEE Workshop On Computational Intelligence: Theories, Applications and Future Directions (hosted by IIT Kanpur)*, 14th July'13.
- Aggarwal, S., Biswas, R., Ansari, A. Q. (2010). Neutrosophic modeling and control. *Computer and Communication Technology (ICCCT), International Conference*, 718 – 723. doi:10.1109/ICCCT.2010.5640435.
- Ansari, A. Q., Biswas, R. & Aggarwal, S. (2013a). Extension to fuzzy logic representation: Moving towards neutrosophic logic - A new laboratory rat, *Fuzzy Systems (FUZZ), IEEE International Conference*, 1–8. DOI:10.1109/FUZZ-IEEE.2013.6622412.
- Atanassov, K. (1986). Intuitionistic fuzzy sets. *Fuzzy Sets and Systems*, vol. 20, pp. 87-96
- Atanassov, K. and Gargov, G. (1989). Interval valued intuitionistic fuzzy sets. *Fuzzy Sets and Systems*, 31, 343-349.
- Atanassov, K. (1999). *Intuitionistic fuzzy sets: theory and applications*. Physica, New York
- Akram, M. & Davvaz, B. (2012). Strong intuitionistic fuzzy graphs. *Filomat*, 26(1), 177–196.
- Akram, M. & Dudek, W. A. (2011). Interval-valued fuzzy graphs. *Computers & Mathematics with Applications*, 61(2), 289–299.
- Akram, M. (2012a). Interval-valued fuzzy line graphs. *Neural Computing and Applications*, vol. 21, 145–150.
- Akram, M. (2011). Bipolar fuzzy graphs. *Information Sciences*, 181(24), 5548–5564.
- Akram, M. (2013). Bipolar fuzzy graphs with applications. *Knowledge Based Systems*, 39, 1–8.
- Akram, M., & Nawaz, S., Operations on soft graphs. *Fuzzy Information and Engineering*, 7(4), 423-449.
- Akram, M. & Nawaz, S. (2015). On fuzzy soft graphs. *Italian Journal of Pure and Applied Mathematics*, 34, 497-514.
- Broumi, S., Smarandache, F. (2014). New distance and similarity measures of interval neutrosophic sets, *Information*

- Fusion (FUSION), 2014 IEEE 17th International Conference, 1 – 7.
- Broumi, S., Smarandache, F. (2014a). Single valued neutrosophic trapezoid linguistic aggregation operators based multi-attribute decision making. *Bulletin of Pure & Applied Sciences- Mathematics and Statistics*, 33(E),135-155. doi: 10.5958/2320-3226.2014.00006.X
- Broumi S, Talea M, Smarandache F and Bakali A. (2016). Single valued neutrosophic graphs: degree, order and size.," IEEE International Conference on Fuzzy Systems (FUZZ), 2444-2451.
- Broumi, S., Talea, M., Bakali, A., Smarandache, F. (2016a). Single valued neutrosophic graphs. *Journal of New Theory*, 10, 2016, 86-101.
- Broumi, S., Talea M, Bakali A, Smarandache, F. (2016b). *Critical Review*, XII (2016) 5-33.
- Broumi, S., Talea M, Bakali A, &Smarandache, F. (2016c). Operations on interval valued neutrosophic graphs. In F. Smarandache, & S. Pramanik (Eds), *New trends in neutrosophic theory and applications* (pp. 231-254). Brussels: Pons Editions.
- Broumi, S., Bakali, A., Talea, M. & Smarandache, F. (2016e). Isolated *single valued neutrosophic graphs*. *Neutrosophic Sets and Systems*, 11, 74-78.
- Broumi, S., Talea, M., Bakali, A., & Smarandache, F. (2016d). Strong *Interval Valued Neutrosophic Graphs*. *Critical Review*, XII, 49-71.
- Bhattacharya, P. (1987). Some remarks on fuzzy graphs. *Pattern Recognition Letters* 6, 297-302.
- Devadoss, A. V, Rajkumar, A., & Praveena, N. J. P. (2013). A Study on Miracles through Holy Bible using Neutrosophic Cognitive Maps (NCMS). *International Journal of Computer Applications*, 69(3), 22-27.
- Deli, I., Ali, M.,Smarandache, F.(2015).Bipolar neutrosophic sets and their application based on multi-criteria decision making problems. *Advanced Mechatronic Systems (ICAMEchS), International Conference*, 249 – 254 DOI: 10.1109/ICAMEchS.2015.7287068.
- Deli, I. (2015). Interval-valued neutrosophic soft sets and its decision making. *International Journal of Machine Learning and Cybernetics*, 1-12.
- Hai-Long, Y., She, G., Yanhonge, & Xiuwu, L. (2016). On single valued neutrosophic relations. *Journal of Intelligent & Fuzzy Systems*, vol. 30, no. 2, 1045-1056.
- Irfan, A.,Shabir, M. & Feng, F. (2016) Representation of graphs based on neighborhoods and soft sets. *Int. J. Mach. Learn. & Cyber*, 1-11, DOI 10.1007/s13042-016-0525-z
- Jiang, Y., Tang, Y., Chen Q, Liu, H., Tang, J. (2010), Interval-valued intuitionistic fuzzy soft sets and their properties. *Computers and Mathematics with Applications*, 60,906-918.
- Karaaslan, F., Davvaz, B. (2018). Properties of single-valued neutrosophic graphs. *Journal of Intelligent & Fuzzy Systems* 34 (1), 57-79
- Molodtsov, D. A. (1999). Soft Set Theory - First Result. *Computers and Mathematics with Applications*, 37, 19-31.
- Maji, P. K., Roy, A. R., and Biswas, R. (2001) Fuzzy soft sets. *Journal of Fuzzy Mathematics*, 9 (3), 589-602.
- Maji, P. K., Biswas R, Roy, A. R. (2001a). Intuitionistic fuzzy soft sets, *The Journal of Fuzzy Mathematics*, 9(3), 677-692.
- Maji, P. K. (2013). Neutrosophic soft set. *Annals of Fuzzy Mathematics and Informatics*, 5, (1),457-168
- Mohamed, I. A.& Mohamed, A. A. (2014). On Strong Interval-Valued Intuitionistic Fuzzy Graph International. *Journal of Fuzzy Mathematics and Systems*,4 (2), 161-168.
- Mohinta, S. and Samanta, TK. (2015). An introduction to fuzzy soft graph. *Mathematica Moravica*, 19(2), 35–48.
- Nagoor, G.A. and Basheer, A. M (2003). Order and size in fuzzy graphs. *Bulletin of Pure and Applied Science*, 22E (1), 145-148
- Nagoor, G. A. & Shajitha, B. S.(2010). Degree, order and size in intuitionistic fuzzy graphs. *International Journal of Algorithms, Computing and Mathematics*, (3)3
- Nagoor,G.A,and Latha,S.R.(2012). On irregular fuzzy graphs. *Applied Mathematical Sciences*, Vol.6, no.11,517-523.
- Shah, N. and Hussain, A. (2016). Neutrosophic soft graphs. *Neutrosophic Sets and Systems*, 11,31-44.
- Shahzadi, S.and Akram, M. (2016). Neutrosophic soft graphs with application. *Journal of intelligent and fuzzy systems*, 32, 1–15.
- Shahzadi, S. and Akram, M. (2016). Intuitionistic fuzzy soft graphs with applications. *J. Appl. Math. Comput.* 1-24.
- Smarandache, F. (2015). Refined literal indeterminacy and the multiplication law of sub-indeterminacies. *Neutrosophic Sets and Systems*, 9, 58-63.
- Smarandache, F.(2015a). Types of Neutrosophic graphs and neutrosophic algebraic structures together with their applications in technology, seminar, Universitatea Transilvania din Brasov, Facultatea de Design de Produs si Mediu, Brasov, Romania 06 June 2015.
- Smarandache, F. (2015b). *Symbolic neutrosophic theory*. Europeanova asbl, Brussels, 195p.
- Smarandache, F.(2006). Neutrosophic set - a generalization of the intuitionistic fuzzy set. *Granular Computing, 2006 IEEE International Conference*. 38 – 42,2006,DOI: 10.1109/GRC.2006.1635754.
- Smarandache, F. (2011). A geometric interpretation of the neutrosophic set — A generalization of the intuitionistic fuzzy set. *Granular Computing (GrC), IEEE International Conference* , 602 – 606. DOI 10.1109/GRC.2011.6122665.
- Şahin, R. (2015). Cross-entropy measure on interval neutrosophic sets and its applications in multicriteria decision making. *Neural Computing and Applications*, 1-11.

- Abdel-Basset, M., Mohamed, M., Smarandache, F., & Chang, V. (2018). Neutrosophic Association Rule Mining Algorithm for Big Data Analysis. *Symmetry*, 10(4), 106.
- Abdel-Basset, M., & Mohamed, M. (2018). The Role of Single Valued Neutrosophic Sets and Rough Sets in Smart City: Imperfect and Incomplete Information Systems. *Measurement*. Volume 124, August 2018, Pages 47-55
- Abdel-Basset, M., Gunasekaran, M., Mohamed, M., & Smarandache, F. A novel method for solving the fully neutrosophic linear programming problems. *Neural Computing and Applications*, 1-11.
- Abdel-Basset, M., Manogaran, G., Gamal, A., & Smarandache, F. (2018). A hybrid approach of neutrosophic sets and DEMATEL method for developing supplier selection criteria. *Design Automation for Embedded Systems*, 1-22.
- Abdel-Basset, M., Mohamed, M., & Chang, V. (2018). NMCDA: A framework for evaluating cloud computing services. *Future Generation Computer Systems*, 86, 12-29.
- Abdel-Basset, M., Mohamed, M., Zhou, Y., & Hezam, I. (2017). Multi-criteria group decision making based on neutrosophic analytic hierarchy process. *Journal of Intelligent & Fuzzy Systems*, 33(6), 4055-4066.
- Abdel-Basset, M.; Mohamed, M.; Smarandache, F. An Extension of Neutrosophic AHP–SWOT Analysis for Strategic Planning and Decision-Making. *Symmetry* 2018, 10, 116.
- Thumbakara, R.K., George, B. (2014). Soft graphs. *General Mathematics Notes*, 21 (2),75-86.
- Vasantha Kandasamy, W. B., and Smarandache, F. (2013). Fuzzy cognitive maps and neutrosophic cognitive maps.
- Vasantha Kandasamy W. B, Ilanthenral, K. & Smarandache, F. (2015). *Neutrosophic graphs: A new dimension to graph theory*. Kindle Edition
- Vasantha Kandasamy, W. B., and Smarandache, F. (2004). Analysis of social aspects of migrant laborers living with HIV/AIDS using Fuzzy Theory and Neutrosophic Cognitive Maps, Xiquan, Phoenix.
- Wang, H., Zhang, Y., & Sunderraman, R. (2005). Truth-value based interval neutrosophic sets. *Granular Computing*, 2005 IEEE International Conference, 1, 274–277. doi: 10.1109/GRC.2005.1547284.
- Wang, H., Smarandache, F., Zhang, Y., & Sunderraman, R. (2010). Single valued neutrosophic sets. *Multispace and Multistructure* 4,410-413.
- Ye, J. (2014). Vector similarity measures of simplified neutrosophic sets and their application in multicriteria decision making. *International Journal of Fuzzy Systems*, 16(2), 204-211.
- Ye, J. (2014a). Single-valued neutrosophic minimum spanning tree and its clustering method. *Journal of Intelligent Systems* 23(3), 311–324.
- Zhang, H., Wang, J. & Chen, X. (2015). An outranking approach for multi-criteria decision-making problems with interval-valued neutrosophic sets. *Neural Computing and Applications*, 1-13.
- Zhang, H.Y., Ji, P., Wang, J. Q. & Chen, X. (2015a). An improved weighted correlation coefficient based on integrated weight for interval neutrosophic sets and its application in multi-criteria decision-making problems. *International Journal of Computational Intelligence Systems*, 8(6). Doi:0.1080/18756891.2015.1099917.
- Zadeh L A. (1965). Fuzzy sets. *Information and Control*, 8 (3),338-353.

Image Processing

Neutrosophic Image Retrieval with Hesitancy Degree

A.A. Salama¹, Mohamed Eisa², Hewayda ElGhawalby³, A.E.Fawzy⁴

¹Port Said University, Faculty of Science, Department of Mathematics and Computer Science
drsalama44@gmail.com

^{2,4}Port Said University, Higher Institute of Management and Computer, Computer Science Department
mmmeisa@yahoo.com

ayafawzy362@gmail.com

³Port Said University, Faculty of Engineering, Physics and Engineering Mathematics Department

ABSTRACT

The aim of this paper is to present texture features for images embedded in the neutrosophic domain with Hesitancy degree. Hesitancy degree is the fourth component of Neutrosophic set. The goal is to extract a set of features to represent the content of each image in the training database to be used for the purpose of retrieving images from the database similar to the image under consideration.

KEYWORDS: Content-Based Image Retrieval (CBIR), Hesitancy Degree, Text-based Image Retrieval (TBIR), Neutrosophic Domain, Neutrosophic Entropy, Neutrosophic Contrast, Neutrosophic Energy, Neutrosophic Homogeneity.

1 INTRODUCTION

With an explosive growth of digital image collections, content-based image retrieval (CBIR) has been emerged as one of the most active problems in computer vision as well as multimedia applications. The target of content-based image retrieval (CBIR) (Datta & Wang, 2005) is to retrieve images relevant to a query of a user, which can be expressed by example. In CBIR, an image is described by automatically extracted low-level visual features, such as color, texture and shape (Ionescu et al., 2007; Ma & Zhang, 1999; Rui et al., 1999). When a user submits one or more query images as examples, a criterion based on this image description ranks the images of an image database according to their similarity with the examples of the query and, finally, the most similar are returned to the Digital image retrieval systems. Since 1990's, Content Based Image Retrieval (CBIR) has attracted great research attention (Jing et al., 2004; Tong & Chang, 2001). Early research was focused on finding the best representation for image features. The current work primarily focuses on using Neutrosophic sets with Hesitancy degrees Transformation methods for CBIR.

The Neutrosophic logic which proposed by Smarandache (2005) is a generalization of fuzzy sets which introduced by Zada (1965). The fundamental concepts of neutrosophic set which are the degree of membership (T), Indeterminacy (I) and the degree of non-membership (F) of each element have been introduced by Smarandache (2002, 1999) and (Albawi et al., 2013; Hanafy et al., 2012; Salama, Eisa et al., 2015; Salama & Elagamy, 2013; Salama, 2015; Salama, Smarandache et al. 2014; Salama, El-Ghareeb et al., 2014; Salama, Abdelfattah et al., 2014; Salama, Eisa et al. 2014; Salama & Broumi, 2014; Salama, El-Ghareeb, Manie, 2014; Salama & Alagamy, 2013. We will now extend the concepts of distances to the case of neutrosophic hesitancy degree. By taking into account the four parameters characterization of neutrosophic sets (Salama & Smarandache, 2014).

2 IMAGE RETRIEVAL TECHNIQUE

2.1 Content-Based Image Retrieval (CBIR)

Content Based Image Retrieval is one of the important methods for image retrieval system. It enhances the accuracy of the image being retrieved. It is applicable for efficient query processing, automatically extract the low-level features such as texture, intensity, shape and color in order to classify the query and retrieve the similar images from the huge scale image collection of database. In CBIR, each image that is stored in the database has its features extracted and compared to the query image features (Ramamurthy et al., 2012). Eakins (Hwang et al., 2012) has divided image features into three levels:

Level 1 - This level deals with primitive features like color, texture, shape or some spatial information about the objects in the picture. This way we can filter images on a more global scale based on form or color. This can be used for finding images that are visually similar to the query image.

Level 2 - This level introduces the logical features or derived attributes which involve some degree of inference about the identity of the objects depicted in the image. So, a typical query in a medical scope would be “Find images of a kidney”.

Level 3 - Most complex of all levels, as it requires complex reasoning about the significance of the objects depicted. In this case the query would look like “Find image of an infected kidney”.

2.1.1 Color features for image retrieval

Color is widely used low-level visual features and it is invariant to image size and orientation (Danish et al., 2013).

- Color Histogram: In CBIR, one of the most popular features is the color histogram in HSV color space, which used in MPEG-7 descriptor. At first, the images converted to the HSV color space, and uniformly quantizing H, S, and V components into 16, 2, and 2 regions respectively generates the 64-bit color histogram (Danish et al., 2013).
- Color moments: To form a 9-dimensional feature vector, the mean μ , standard deviation σ , and skew g are extracted from the R, G, B color spaces. The best-known space color and commonly used for visualization is the RGB space color. It can be depicted as a cube where the horizontal x-axis as red values increasing to the left, y-axis as blue increasing to the lower right and the vertical z-axis as green increasing towards the top (Lee et al., 1996).

2.1.2 Texture feature for image retrieval

In the texture feature extraction, using the gray level co-occurrence matrix for the query image and the first image in the database to extract the texture feature vector (Kong, 2009). The co-occurrence matrix representation is a technique used to give the intensity values and the distribution of the intensities. The features which selected for retrieving texture properties are Energy, Entropy, Inverse difference, Moment of inertia, Mean, Variance, Skewness, Distribution uniformity, Local stationary and Homogeneity (Ingle & Bhatia, 2012).

2.1.3 Shape features for image retrieval

The shape defined as the characteristic surface configuration of an object: an outline or contour. The object can be distinguished from its surroundings by its outline (Danish et al., 2013).

We can divide the shape representations into two categories:

- 1- Boundary-based shape representation: it uses only the outer boundary of the shape. It works by describing the considered region by using its external characteristics. For example, the pixels along the object boundary (Sifuzzaman et al., 2009).
- 2- Region-based shape representation: it uses the entire shape region. It works by describing the considered region using its internal characteristics. For example, the pixels which the region contained (Sifuzzaman et al., 2009).

3 HESITANCY DEGREE

We will now extend the concepts of distances to the case of neutrosophic hesitancy degree.

By taking into account the four parameters characterization of neutrosophic sets

$$A = \{ \langle \mu_A(x), \nu_A(x), \gamma_A(x), \pi_A(x) \rangle, x \in X \} \text{ (Salama, Smarandache et al., 2014).}$$

Definition 3.1 (Salama, Smarandache et al., 2014) :

Let $A = \{ \langle \mu_A(x), \nu_A(x), \gamma_A(x) \rangle, x \in X \}$ and $B = \{ \langle \mu_B(x), \nu_B(x), \gamma_B(x) \rangle, x \in X \}$ on $X = \{x_1, x_2, x_3, \dots, x_n\}$
 For a Neutrosophic set $A = \{ \langle \mu_A(x), \nu_A(x), \gamma_A(x) \rangle, x \in X \}$ in X , we call $\pi_A(x) = 3 - \mu_A(x) - \nu_A(x) - \gamma_A(x)$, the Neutrosophic index of x in A , it is a hesitancy degree of x to A it is obvious that $0 \leq \pi_A(x) \leq 3$.

4 IMAGES IN THE NEUTROSOPHIC DOMAIN WITH HESITANCY DEGREE

The image in the Neutrosophic Domain (ND) is considered as an array of neutrosophic singletons (Salama, Smarandache et al., 2014). Let U be a universe of discourse and W is a set in U which composed of bright pixels. A neutrosophic images P_{NS} is characterized by three sub sets T , I , and F . which can be defined as T is the degree of membership, I is the degree of indeterminacy, and F is the degree of non-membership. In the image, a pixel P is described as $P(T, I, F)$ which belongs to W by it is $t\%$ is true in the bright pixel, $i\%$ is the indeterminate and $f\%$ is false where t varies in T , i varies in I , and f varies in F . In the image domain, the pixel $p(i, j)$ is transformed to $NDP_{NS}(i, j) = \{T(i, j), I(i, j), F(i, j)\}$. Where, $T(i, j)$ belongs to white set, $I(i, j)$ belongs to indeterminate set and $F(i, j)$ belongs to non-white set.

The image in ND can be defined as [2]:

$$P_{NS}(i, j) = \{T(i, j), I(i, j), F(i, j)\} \tag{1}$$

$$T(i, j) = \frac{\overline{g(i, j)} - \overline{g}_{min}}{\overline{g}_{max} - \overline{g}_{min}} \tag{2}$$

$$I(i, j) = 1 - \frac{H_0(i, j) - H_0}{H_{0max} - H_{0min}} \tag{3}$$

$$F(i, j) = 1 - T(i, j) \tag{4}$$

$$\pi(i, j) = 3 - T(i, j) - I(i, j) - F(i, j) \tag{5}$$

$$H_0(i, j) = abs \left(g(i, j) - \overline{g(i, j)} \right) \tag{6}$$

Where $\overline{g(i,j)}$ can be defined as the local mean value of the pixels of window size, and $H_0(i,j)$ can be defined as the homogeneity value of T at (i, j). $H_0(i,j)$ is the absolute value of difference between intensity $g(i,j)$ and its local mean value $\overline{g(i,j)}$.

The second transformation for $NDP_{NS}(i,j) = \{T(i,j), I(i,j), F(i,j), \pi(i,j)\}$

Where $\pi(i,j) = 3 - T(i,j) - I(i,j) - F(i,j)$ in (Salama, Smarandache et al., 2014).

5 TEXTURE FEATURES IN NEUTROSOPHIC DOMAIN

5.1 Neutrosophic Entropy with Hesitancy degree:

Shannon entropy provides an absolute limit on the best possible average length of lossless encoding or compression of an information source.

Conversely, rare events provide more information when observed. Since observation of less probable events occurs more rarely, the net effect is that the entropy received from non-uniformly distributed data is $\log_2(n)$. Entropy is zero when one outcome is certain. Shannon entropy quantifies all these considerations exactly when a probability distribution of the source is known. Entropy only takes into account the probability of observing a specific event, so the information which encapsulates is information about the underlying probability distribution, not the meaning of the events themselves (Shannon, 1948).

Entropy is defined as (Fan et al., 2008):

$$\text{Entropy} = \sum_i \sum_j P(i,j) \log P(i,j)$$

Although, the Neutrosophic Set Entropy was defined in one dimension which presented in (Eisa, 2014), We will define it in two dimensions to be as follows:

$$\begin{aligned} En_{NS} &= En_T + En_I + En_F \\ En_T &= \sum_i \sum_j P_T(i,j) \log P_T(i,j) \\ En_I &= \sum_i \sum_j P_I(i,j) \log P_I(i,j) \\ En_F &= \sum_i \sum_j P_F(i,j) \log P_F(i,j) \\ En_\pi &= 3 - (En_T + En_I + En_F) \end{aligned}$$

Where P contains the histogram counts.

Because, we used the interval between 0 and 1, $\log P(i,j)$ may have negative values.

So, we use the absolute of $En_T, En_I, \text{ and } En_F$

5.2 Neutrosophic Contrast with Hesitancy degree:

Contrast is the difference in luminance or color that makes an object distinguishable. In visual perception of the real world, contrast is determined by the difference in the color and brightness of the object and other objects within the same field of view. The human visual system is more sensitive to contrast than absolute luminance. The maximum contrast of an image is the contrast ratio or dynamic range.

It is the measure of the intensity contrast between a pixel and its neighbor over the whole image, it can be defined as (Sinha & Udai, 2009):

$$Contrast = \sum_i \sum_j (i - j)^2 P(i, j)$$

We will define the Neutrosophic set Contrast to be as follows:

$$contrast_{NS} = contrast_T + contrast_I + contrast_F$$

$$contrast_T = \sum_i \sum_j (i - j)^2 P_T(i, j)$$

$$contrast_I = \sum_i \sum_j (i - j)^2 P_I(i, j)$$

$$contrast_F = \sum_i \sum_j (i - j)^2 P_F(i, j)$$

$$contrast_{\pi} = 3 - (contrast_T + contrast_I + contrast_F)$$

5.3 Neutrosophic Energy with Hesitancy degree:

It is the sum of squared elements. Which defined as (Hearn & Baker, 1994):

$$Energy = \sum_i \sum_j P^2(i, j)$$

We will define the Neutrosophic set Energy to be as follows:

$$Energy_{NS} = Energy_T + Energy_I + Energy_F$$

$$Energy_T = \sum_i \sum_j P_T^2(i, j)$$

$$Energy_I = \sum_i \sum_j P_I^2(i, j)$$

$$Energy_F = \sum_i \sum_j P_F^2(i, j)$$

$$Energy_{\pi} = 3 - (Energy_T + Energy_I + Energy_F)$$

5.4 Neutrosophic homogeneity with hesitancy degree:

Homogeneity describes the properties of a data set, or several datasets. Homogeneity can be studied to several degrees of complexity. For example, considerations of homoscedasticity examine how much the variability of data-values changes throughout a dataset. However, questions of homogeneity apply to all aspects of the statistical distributions, including the location parameter. Homogeneity relates to the validity of the often-convenient assumption that the statistical properties of any one part of an overall dataset are the same as any other part. In meta-analysis, which combines the data from several studies, homogeneity measures the difference or similarities between the several studies.

That is a value which measures the closeness of the distribution of elements. Which defined as (Kuijk, 1991):

$$Homogeneity = \sum_i \sum_j \frac{P(i, j)}{1 + |i - j|}$$

We will define the Neutrosophic set Homogeneity to be as follows:

$$Homogeneity_{NS} = Homogeneity_T + Homogeneity_I + Homogeneity_F$$

$$Homogeneity_T = \sum_i \sum_j \frac{P_T(i, j)}{1 + |i - j|}$$

$$\text{Homogeneity}_T = \sum_i \sum_j \frac{P_T(i,j)}{1 + |i-j|}$$

$$\text{Homogeneity}_F = \sum_i \sum_j \frac{P_F(i,j)}{1 + |i-j|}$$

$$\text{Homogeneity}_N = 3 - (\text{Homogeneity}_T + \text{Homogeneity}_I + \text{Homogeneity}_F)$$

Recently, the Euclidean distance is calculated between the query image and the first image in the database and stored in an array. This process is repeated for the remaining images in the database followed by storing their values respectively. The array is stored now in ascending order and displayed the first 8 closest matches.

6. CONCLUSION AND FUTURE WORK

In this paper we introduced a survey of the Text-Based Image Retrieval (TBIR) and the Content-Based Image Retrieval (CBIR). We also introduced the image in neutrosophic domain with hesitancy degree and the texture feature in neutrosophic domain. In future, we plan to introduce some similarity measurement which may be used to determine the distance between the image under consideration and each image in the database using the features we introduced in this paper. Hence, the images similar to the image under consideration can be retrieved.

REFERENCES

- Albowi, S. A., Salama, A. A. & Eisa M. (2013). New concepts of neutrosophic sets. *International Journal of Mathematics and Computer Applications Research (IJMCAR)*, 3(4), 95-102.
- Cheng, H. D., Guot, Y. & Zhang, Y. (2011). A novel image segmentation approach based on neutrosophic set and improved fuzzy C- means algorithm. *New Mathematics and Natural Computation*, 7(1), 155-171.
- Datta, R., Li, J. & Wang, J. Z. (2005). Content-based image retrieval: approaches and trends of the new age. *Multimedia Information Retrieval*, 253-262.
- Danish, M., Rawat, R. & Sharma, R. (2013). A survey: content –based image retrieval based on color, texture, shape & neuro fuzzy. *Journal of Engineering Research and Applications*, 3(5), 839-844.
- Eisa, M., (2014). A New approach for enhancing image retrieval using neutrosophic set. *International Journal of Computer Applications*, 95 (8), 0975-8887.
- Fan, Z. G., Li, J., Wu, B., & Wu, Y. (2008, October). Local patterns constrained image histograms for image retrieval. In *Image Processing, 2008. ICIP 2008. 15th IEEE International Conference on* (pp. 941-944). IEEE.
- Hearn, D. & Baker, M. P. (1994). *Computer graphics*, Englewood Cliffs, NJ: Prentice Hall, ch. 14, 500-504.
- Hanafy, I., Salama, A. A. & Mahfouz, K. (2012). Correlation of neutrosophic data. *International Refereed Journal of Engineering and Science*, 1(2), 39-43.
- Hwang, K. H., Lee, H., & Choi, D. (2012). Medical image retrieval: past and present. *Healthcare informatics research*, 18(1), 3-9.
- Ingle, D. & Bhatia, Sh. (2012). Content based image retrieval using combined features. *International Journal of Computer Applications*, 44(17), 0975-8887.
- Ionescu, B., Lambert, P., Coquin, D., & Buzuloiu, V. (2007, June). Color-based content retrieval of animation movies: a study. In *Content-Based Multimedia Indexing, 2007. CBMI'07. International Workshop on* (pp. 295-302). IEEE.
- Jing, F., Li, M., Zhang, H. J., & Zhang, B. (2004). Relevance feedback in region-based image retrieval. *IEEE Transactions on Circuits and Systems for Video Technology*, 14(5), 672-681.
- Kong, F. H. (2009, July). Image retrieval using both color and texture features. In *Machine Learning and Cybernetics, 2009 International Conference on* (Vol. 4, pp. 2228-2232). IEEE.
- Kuijk, A. A. (Ed.). (1991). *Advances in computer graphics hardware III*. Springer Science & Business Media.
- Lee, I., Muneesawang, P., & Guan, L. (1996). Automatic relevance feedback for distributed content based image retrieval. *International Congress for Global Science*.

- Ma, W. Y., & Zhang, H. (1999). Content-based image indexing and retrieval. *Handbook of multimedia computing*, 227-254.
- Ramamurthy, B., Chandran, K. R., Meenakshi, V. R., & Shilpa, V. (2012). CBMIR: content based medical image retrieval system using texture and intensity for dental images. In *Eco-friendly Computing and Communication Systems* (pp. 125-134). Springer, Berlin, Heidelberg.
- Rui, Y., Huang, T. S., & Chang, S. F. (1999). Image retrieval: current techniques, promising directions, and open issues. *Journal of visual communication and image representation*, 10(1), 39-62.
- Salama, A. A., Smarandache, F., & Eisa, M. (2014). *Introduction to image processing via neutrosophic techniques. Neutrosophic Sets and Systems*, 5, 59-64.
- Salama, A. A., Eisa, M., ELhafeez, S. A., & Lotfy, M. M. (2015). Review of recommender systems algorithms utilized in social networks based e-Learning systems & neutrosophic system. *Neutrosophic Sets and Systems*, 8, 32-41.
- Salama, A. A., & Elagamy, H. (2013). Neutrosophic filters. *International Journal of Computer Science Engineering and Information Technology Research (IJCEITR)*, 3(1), 307-312.
- Salama, A. A. (2015). Basic structure of some classes of neutrosophic crisp nearly open sets and possible application to GIS topology. *Neutrosophic Sets and Systems*, 7, 18-22.
- Salama, A. A., Smarandache, F. & Alblowi S. A. (2014). The characteristic function of a neutrosophic set. *Neutrosophic Sets and Systems*, 3, 14-17.
- Salama, A. A., El-Ghareeb, H. A. & Manie, A. M. (2014). Introduction to develop some software programs for dealing with neutrosophic sets. *Neutrosophic Sets and Systems*, 3, 51-52.
- Salama, A. A., Abdelfattah, M. & Eisa, M. (2014). Distances, hesitancy degree and flexible querying via neutrosophic sets. *International of Computer Applications*, 101(10), 0975-8887.
- Salama, A. A., Eisa, M. & Abdelmoghny, M. M. (2014). Neutrosophic relations database. *International Journal of Information Science and Intelligent System*, 3(2), 1-3.
- Salama, A. A., & Broumi, S. (2014). Roughness of neutrosophic sets. *Elixir Applied Mathematics*, 74, 26833-26837.
- Salama, A. A., El-Ghareeb, H. A., Manie, A. M. & Lotfy, M. M. (2014). Utilizing neutrosophic set in social network analysis e- learning systems. *International Journal of Information Science and Intelligent Systems*, 3(4), 61-72.
- Salama, A. A., & Alagamy, H. (2013). Neutrosophic filters. *International Journal of computer Science Engineering and Information Technology Research*, 3(1), 307-312.
- Shannon, C. E. (1948). A mathematical theory of communication. *Bell System Technical Journal*, 27, 379-423.
- Sinha, M. N. & Udai, A. D. (2009). Computer graphics. Taha McGraw – Hill Publishing Company Limited.
- Sifuzzaman, M., Islam M. R., & Ali, M. Z. (2009). Application of wavelet transform and its advantage compared to fourier transform. *Journal of Physical Sciences*, 13, 121-134.
- Smarandache, F. (2005). Neutrosophic set-a generalization of the intuitionistic fuzzy set. *International Journal of Pure and Applied Mathematics*, 24(3), 287.
- Smarandache, F. (2002). Neutrosophy and neutrosophic logic, First International Conference on Neutrosophy, Neutrosophic Logic, Set, Probability, and Statistics, University of New Mexico, Gallup, USA, 87301.
- Smarandache, F. (1999). *A unifying field in logics: neutrosophic logic, neutrosophy, neutrosophic set, neutrosophic probability*. American Research Press, Rehoboth, NM, 1-41.
- Tong, S., & Chang, E. (2001, October). Support vector machine active learning for image retrieval. In *Proceedings of the ninth ACM international conference on Multimedia* (pp. 107-118). ACM.
- Zadeh L.A. (1965). Fuzzy sets. *Information and Control*, 8 (3), 338-353.

Algebra and Other Papers

Generalized Neutrosophic Closed Sets

^{1*} R. Dhavaseelan and ²S. Jafari

^{1*}Department of Mathematics, Sona College of Technology,
Salem-636005, Tamil Nadu, India.

²Department of Mathematics, College of Vestsjaelland South,
Herrestraede 11, 4200 Slagelse, Denmark.

e-mail : dhavaseelan.r@gmail.com, jafaripersia@gmail.com

ABSTRACT

In this paper, the concept of generalized neutrosophic closed set is introduced. Further, generalized neutrosophic continuous mapping, generalized neutrosophic irresolute mapping, strongly neutrosophic continuous mapping, perfectly neutrosophic continuous mapping, strongly generalized neutrosophic continuous mapping and perfectly generalized neutrosophic continuous mapping are introduced. Several interesting properties and characterizations are also discussed.

KEYWORDS: Generalized neutrosophic closed sets; generalized neutrosophic continuity; strongly generalized neutrosophic continuity; generalized neutrosophic irresolute; strongly neutrosophic continuity; perfectly neutrosophic continuity.

1 INTRODUCTION AND PRELIMINARIES

The notion of fuzzy set has invaded almost all branches of mathematics since its introduction by Zadeh (1965). Fuzzy sets have applications in many fields such as information theory (Smets (1981)) and control theory (Sugeno (1985)). The notion of fuzzy topological space was introduced and developed by Chang (1968) and since then various notions in classical topology have been extended to fuzzy topological spaces. The idea of "intuitionistic fuzzy set" was first published by Krassimir Atanassov (1983) and developed further by him and his colleagues (Atanassov (1986, 1988); Atanassov and Stoeva (1983)). Intuitionistic fuzzy set is an extension of Zadeh's notion of fuzzy set which itself has extended the classical notion of a set. Later, this concept was generalized to "intuitionistic L - fuzzy sets" by Atanassov and Stoeva (1984). The concept of generalized intuitionistic fuzzy closed set was

first introduced and investigated by Thakur and Chaturvedi (2006) and later independently by Dhavaseelan *et al.* (2010). After the introduction of the concepts of neutrosophy and neutrosophic set by Smarandache Smarandache (1999, 2000), the concepts of neutrosophic crisp set and neutrosophic crisp topological spaces were introduced by Salama and Alblowi (2012).

In this paper, the concept of generalized neutrosophic closed set is introduced. Further, generalized neutrosophic continuous mapping, generalized neutrosophic irresolute mapping, strongly neutrosophic continuous mapping, perfectly neutrosophic continuous mapping, strongly generalized neutrosophic continuous mapping and perfectly generalized neutrosophic continuous mapping are introduced. Several interesting properties and characterizations are also discussed.

Definition 1.1. Let T , I and F be real standard or non standard subsets of $]0^-, 1^+[$, with

$$sup_T = t_{sup}, inf_T = t_{inf}$$

$$sup_I = i_{sup}, inf_I = i_{inf}$$

$$sup_F = f_{sup}, inf_F = f_{inf}$$

$$n - sup = t_{sup} + i_{sup} + f_{sup}$$

$$n - inf = t_{inf} + i_{inf} + f_{inf} . T, I \text{ and } F \text{ are neutrosophic components.}$$

Definition 1.2. Let X be a nonempty fixed set. A neutrosophic set [briefly NS] A is an object having the form $A = \{\langle x, \mu_A(x), \sigma_A(x), \gamma_A(x) \rangle : x \in X\}$, where $\mu_A(x)$, $\sigma_A(x)$ and $\gamma_A(x)$ represent the degree of membership function (namely $\mu_A(x)$), the degree of indeterminacy (namely $\sigma_A(x)$) and the degree of nonmembership (namely $\gamma_A(x)$) respectively of each element $x \in X$ to the set A .

Remark 1.1. (1) A neutrosophic set $A = \{\langle x, \mu_A(x), \sigma_A(x), \gamma_A(x) \rangle : x \in X\}$ can be identified to an ordered triple $\langle \mu_A, \sigma_A, \gamma_A \rangle$ in $]0^-, 1^+[$ on X .

(2) For the sake of simplicity, we shall use the symbol $A = \langle \mu_A, \sigma_A, \gamma_A \rangle$ for the neutrosophic set $A = \{\langle x, \mu_A(x), \sigma_A(x), \gamma_A(x) \rangle : x \in X\}$.

Definition 1.3. Let X be a nonempty set and the neutrosophic sets A and B in the form $A = \{\langle x, \mu_A(x), \sigma_A(x), \gamma_A(x) \rangle : x \in X\}$, $B = \{\langle x, \mu_B(x), \sigma_B(x), \gamma_B(x) \rangle : x \in X\}$. Then

(a) $A \subseteq B$ iff $\mu_A(x) \leq \mu_B(x)$, $\sigma_A(x) \leq \sigma_B(x)$ and $\gamma_A(x) \geq \gamma_B(x)$ for all $x \in X$;

(b) $A = B$ iff $A \subseteq B$ and $B \subseteq A$;

(c) $\bar{A} = \{\langle x, \gamma_A(x), \sigma_A(x), \mu_A(x) \rangle : x \in X\}$; [Complement of A]

(d) $A \cap B = \{\langle x, \mu_A(x) \wedge \mu_B(x), \sigma_A(x) \wedge \sigma_B(x), \gamma_A(x) \vee \gamma_B(x) \rangle : x \in X\}$;

(e) $A \cup B = \{\langle x, \mu_A(x) \vee \mu_B(x), \sigma_A(x) \vee \sigma_B(x), \gamma_A(x) \wedge \gamma_B(x) \rangle : x \in X\}$;

(f) $[]A = \{\langle x, \mu_A(x), \sigma_A(x), 1 - \mu_A(x) \rangle : x \in X\}$;

$$(g) \langle A = \{ \langle x, 1 - \gamma_A(x), \sigma_A(x), \gamma_A(x) \rangle : x \in X \}.$$

Definition 1.4. Let $\{A_i : i \in J\}$ be an arbitrary family of neutrosophic sets in X . Then

$$(a) \bigcap A_i = \{ \langle x, \wedge \mu_{A_i}(x), \wedge \sigma_{A_i}(x), \vee \gamma_{A_i}(x) \rangle : x \in X \};$$

$$(b) \bigcup A_i = \{ \langle x, \vee \mu_{A_i}(x), \vee \sigma_{A_i}(x), \wedge \gamma_{A_i}(x) \rangle : x \in X \}.$$

Since our main purpose is to construct the tools for developing neutrosophic topological spaces, we must introduce the neutrosophic sets 0_N and 1_N in X as follows:

Definition 1.5. $0_N = \{ \langle x, 0, 0, 1 \rangle : x \in X \}$ and $1_N = \{ \langle x, 1, 1, 0 \rangle : x \in X \}$.

2 NEUTROSOPHIC TOPOLOGY

Definition 2.1. A neutrosophic topology (NT) on a nonempty set X is a family T of neutrosophic sets in X satisfying the following axioms:

- (i) $0_N, 1_N \in T$,
- (ii) $G_1 \cap G_2 \in T$ for any $G_1, G_2 \in T$,
- (iii) $\cup G_i \in T$ for arbitrary family $\{G_i \mid i \in \Lambda\} \subseteq T$.

In this case the ordered pair (X, T) or simply X is called a neutrosophic topological space (NTS) and each neutrosophic set in T is called a neutrosophic open set (NOS). The complement \overline{A} of a NOS A in X is called a neutrosophic closed set (NCS) in X .

Definition 2.2. Let A be a neutrosophic set in a neutrosophic topological space X . Then

$Nint(A) = \bigcup \{G \mid G \text{ is a neutrosophic open set in } X \text{ and } G \subseteq A\}$ is called the neutrosophic interior of A ;

$Ncl(A) = \bigcap \{G \mid G \text{ is a neutrosophic closed set in } X \text{ and } G \supseteq A\}$ is called the neutrosophic closure of A .

Corollary 2.1. Let A, B and C be neutrosophic sets in X . Then the basic properties of inclusion and complementation:

- (a) $A \subseteq B$ and $C \subseteq D \Rightarrow A \cup C \subseteq B \cup D$ and $A \cap C \subseteq B \cap D$,
- (b) $A \subseteq B$ and $A \subseteq C \Rightarrow A \subseteq B \cap C$,
- (c) $A \subseteq C$ and $B \subseteq C \Rightarrow A \cup B \subseteq C$,
- (d) $A \subseteq B$ and $B \subseteq C \Rightarrow A \subseteq C$,
- (e) $\overline{A \cup B} = \overline{A} \cap \overline{B}$,
- (f) $\overline{A \cap B} = \overline{A} \cup \overline{B}$,

(g) $A \subseteq B \Rightarrow \overline{B} \subseteq \overline{A}$,

(h) $\overline{\overline{A}} = A$,

(i) $\overline{1_N} = 0_N$,

(j) $\overline{0_N} = 1_N$.

Now we introduce the notions of image and preimage of neutrosophic sets. Let X and Y be two nonempty sets and $f : X \rightarrow Y$ be a function.

Definition 2.3. (a) If $B = \{\langle y, \mu_B(y), \sigma_B(y), \gamma_B(y) \rangle : y \in Y\}$ is a neutrosophic set in Y , then the preimage of B under f , denoted by $f^{-1}(B)$, is the neutrosophic set in X defined by

$$f^{-1}(B) = \{\langle x, f^{-1}(\mu_B)(x), f^{-1}(\sigma_B)(x), f^{-1}(\gamma_B)(x) \rangle : x \in X\}.$$

(b) If $A = \{\langle x, \mu_A(x), \sigma_A(x), \gamma_A(x) \rangle : x \in X\}$ is a neutrosophic set in X , then the image of A under f , denoted by $f(A)$, is the neutrosophic set in Y defined by

$$f(A) = \{\langle y, f(\mu_A)(y), f(\sigma_A)(y), (1 - f(1 - \gamma_A))(y) \rangle : y \in Y\}.$$
 where

$$f(\mu_A)(y) = \begin{cases} \sup_{x \in f^{-1}(y)} \mu_A(x), & \text{if } f^{-1}(y) \neq \emptyset, \\ 0, & \text{otherwise,} \end{cases}$$

$$f(\sigma_A)(y) = \begin{cases} \sup_{x \in f^{-1}(y)} \sigma_A(x), & \text{if } f^{-1}(y) \neq \emptyset, \\ 0, & \text{otherwise,} \end{cases}$$

$$(1 - f(1 - \gamma_A))(y) = \begin{cases} \inf_{x \in f^{-1}(y)} \gamma_A(x), & \text{if } f^{-1}(y) \neq \emptyset, \\ 1, & \text{otherwise,} \end{cases}$$

For the sake of simplicity, let us use the symbol $f_-(\gamma_A)$ for $1 - f(1 - \gamma_A)$.

Corollary 2.2. Let $A, A_i (i \in J)$ be neutrosophic sets in X , $B, B_i (i \in K)$ be neutrosophic sets in Y and $f : X \rightarrow Y$ a function. Then

(a) $A_1 \subseteq A_2 \Rightarrow f(A_1) \subseteq f(A_2)$,

(b) $B_1 \subseteq B_2 \Rightarrow f^{-1}(B_1) \subseteq f^{-1}(B_2)$,

(c) $A \subseteq f^{-1}(f(A))$ { If f is injective, then $A = f^{-1}(f(A))$ } ,

(d) $f(f^{-1}(B)) \subseteq B$ { If f is surjective, then $f(f^{-1}(B)) = B$ } ,

(e) $f^{-1}(\cup B_j) = \cup f^{-1}(B_j)$,

(f) $f^{-1}(\cap B_j) = \cap f^{-1}(B_j)$,

(g) $f(\cup A_i) = \cup f(A_i)$,

- (h) $f(\bigcap A_i) \subseteq \bigcap f(A_i)$ { If f is injective, then $f(\bigcap A_i) = \bigcap f(A_i)$ },
- (i) $f^{-1}(1_N) = 1_N$,
- (j) $f^{-1}(0_N) = 0_N$,
- (k) $f(1_N) = 1_N$, if f is surjective,
- (l) $f(0_N) = 0_N$,
- (m) $\overline{f(A)} \subseteq f(\overline{A})$, if f is surjective,
- (n) $f^{-1}(\overline{B}) = \overline{f^{-1}(B)}$.

3 GENERALIZED NEUTROSOPHIC CLOSED SETS AND GENERALIZED NEUTROSOPHIC CONTINUOUS FUNCTIONS

Definition 3.1. Let (X, T) be a neutrosophic topological space. A neutrosophic set A in (X, T) is said to be a generalized neutrosophic closed set if $Ncl(A) \subseteq G$ whenever $A \subseteq G$ and G is a neutrosophic open set. The complement of a generalized neutrosophic closed set is called a generalized neutrosophic open set.

Definition 3.2. Let (X, T) be a neutrosophic topological space and A be a neutrosophic set in X . Then the neutrosophic generalized closure and neutrosophic generalized interior of A are defined by,

- (i) $NGcl(A) = \bigcap \{G: G \text{ is a generalized neutrosophic closed set in } X \text{ and } A \subseteq G\}$.
- (ii) $NGint(A) = \bigcup \{G: G \text{ is a generalized neutrosophic open set in } X \text{ and } A \supseteq G\}$.

Proposition 3.1. Let (X, T) be any neutrosophic topological space and let A and B be neutrosophic sets in (X, T) . Then the neutrosophic generalized closure operator satisfy the following properties:

- (i) $A \subseteq NGcl(A)$.
- (ii) $NGint(A) \subseteq A$.
- (iii) $A \subseteq B \Rightarrow NGcl(A) \subseteq NGcl(B)$.
- (iv) $A \subseteq B \Rightarrow NGint(A) \subseteq NGint(B)$.
- (v) $NGcl(A \cup B) = NGcl(A) \cup NGcl(B)$.
- (vi) $NGint(A \cap B) = NGint(A) \cap NGint(B)$.
- (vii) $\overline{NGcl(A)} = NGint(\overline{A})$.

(viii) $\overline{NGint(A)} = NGcl(\overline{A})$.

Proof. (i) $NGcl(A) = \bigcap \{G : G \text{ is a generalized neutrosophic closed set in } X \text{ and } A \subseteq G\}$.
Thus, $A \subseteq NGcl(A)$.

(ii) $NGint(A) = \bigcup \{G : G \text{ is a generalized neutrosophic open set in } X \text{ and } A \supseteq G\}$. Thus,
 $NGint(A) \subseteq A$.

(iii) $NGcl(B) = \bigcap \{G : G \text{ is a generalized neutrosophic closed set in } X \text{ and } B \subseteq G\}$,
 $\supseteq \bigcap \{G : G \text{ is a generalized neutrosophic closed set in } X \text{ and } A \subseteq G\}$,
 $\supseteq NGcl(A)$.
Thus, $NGcl(A) \subseteq NGcl(B)$.

(iv) $NGint(B) = \bigcup \{G : G \text{ is a generalized neutrosophic open set in } X \text{ and } B \supseteq G\}$,
 $\supseteq \bigcup \{G : G \text{ is a generalized neutrosophic open set in } X \text{ and } A \supseteq G\}$,
 $\supseteq NGint(A)$.
Thus, $NGint(A) \subseteq NGint(B)$.

(v) $NGcl(A \cup B) = \bigcap \{G : G \text{ is a generalized neutrosophic closed set in } X \text{ and } A \cup B \subseteq G\}$,
 $(\bigcap \{G : G \text{ is a generalized neutrosophic closed set in } X \text{ and } A \subseteq G\}) \cup (\bigcap \{G : G \text{ is a}$
 $\text{generalized neutrosophic closed set in } X \text{ and } B \subseteq G\})$,
 $= NGcl(A) \cup NGcl(B)$.
Thus, $NGcl(A \cup B) = NGcl(A) \cup NGcl(B)$.

(vi) $NGint(A \cap B) = \bigcup \{G : G \text{ is a generalized neutrosophic open set in } X \text{ and } A \cap B \supseteq G\}$,
 $(\bigcup \{G : G \text{ is a generalized neutrosophic open set in } X \text{ and } A \supseteq G\}) \cap (\bigcup \{G : G \text{ is a}$
 $\text{generalized neutrosophic open set in } X \text{ and } B \supseteq G\})$,
 $= NGint(A) \cap NGint(B)$.
Thus, $NGint(A \cap B) = NGint(A) \cap NGint(B)$.

(vii) $NGcl(A) = \bigcap \{G : G \text{ is a generalized neutrosophic closed set in } X \text{ and } A \subseteq G\}$,
 $\overline{NGcl(A)} = \bigcup \{\overline{G} : \overline{G} \text{ is a generalized neutrosophic open set in } X \text{ and } \overline{A} \supseteq \overline{G}\}$,
 $= NGint(\overline{A})$.
Thus, $\overline{NGcl(A)} = NGint(\overline{A})$.

(viii) $NGint(A) = \bigcup \{G : G \text{ is a generalized neutrosophic open set in } X \text{ and } A \supseteq G\}$,
 $\overline{NGint(A)} = \bigcap \{\overline{G} : \overline{G} \text{ is a generalized neutrosophic closed set in } X \text{ and } \overline{A} \subseteq \overline{G}\}$,
 $= NGcl(\overline{A})$. Thus, $\overline{NGint(A)} = NGcl(\overline{A})$.

□

Proposition 3.2. Let (X, T) be a neutrosophic topological space. If B is a generalized neutrosophic closed set and $B \subseteq A \subseteq Ncl(B)$, then A is a generalized neutrosophic closed set.

Proof. Let G be a neutrosophic open set in (X, T) , such that $A \subseteq G$. Since $B \subseteq A$, $B \subseteq G$. Now, B is a generalized neutrosophic closed set and $Ncl(B) \subseteq G$. But $Ncl(A) \subseteq Ncl(B)$. Since $Ncl(A) \subseteq Ncl(B) \subseteq G$, $Ncl(A) \subseteq G$. Hence, A is a generalized neutrosophic closed set. \square

Proposition 3.3. Let (X, T) be a neutrosophic topological space. A neutrosophic set A is a generalized neutrosophic open set if and only if $B \subseteq Nint(A)$, whenever B is a neutrosophic closed set and $B \subseteq A$.

Proof. Let A be a generalized neutrosophic open set and B be a neutrosophic closed set such that $B \subseteq A$. Now, $B \subseteq A \Rightarrow \overline{A} \subseteq \overline{B}$ and since \overline{A} is a generalized neutrosophic closed set, then $Ncl(\overline{A}) \subseteq \overline{B}$. This means that $B = \overline{(\overline{B})} \subseteq \overline{Ncl(\overline{A})}$. But $\overline{Ncl(\overline{A})} = Nint(A)$. Hence, $B \subseteq Nint(A)$.

Conversely, suppose that A is a neutrosophic set such that $B \subseteq Nint(A)$, whenever B is a neutrosophic closed set and $B \subseteq A$. Let $\overline{A} \subseteq B$ whenever B is a neutrosophic open set. Now, $\overline{A} \subseteq B \Rightarrow \overline{B} \subseteq A$. Hence by assumption, $\overline{B} \subseteq Nint(A)$. That is, $\overline{Nint(A)} \subseteq B$. But $\overline{Nint(A)} = Ncl(\overline{A})$. Hence, $Ncl(\overline{A}) \subseteq B$. This means that \overline{A} is a generalized neutrosophic closed set. Therefore, A is a generalized neutrosophic open set. \square

Proposition 3.4. If $Nint(A) \subseteq B \subseteq A$ and if A is a generalized neutrosophic open set, then B is also a generalized neutrosophic open set.

Proof. Now, $\overline{A} \subseteq \overline{B} \subseteq \overline{Nint(A)} = Ncl(\overline{A})$. Since A is a generalized neutrosophic open set, then \overline{A} is a generalized neutrosophic closed set. By Proposition 3.2, \overline{B} is a generalized neutrosophic closed set. That is, B is a generalized neutrosophic open set. \square

Definition 3.3. Let (X, T) and (Y, S) be any two neutrosophic topological spaces.

- (i) A map $f : (X, T) \rightarrow (Y, S)$ is said to be generalized neutrosophic continuous if the inverse image of every neutrosophic closed set in (Y, S) is a generalized neutrosophic closed set in (X, T) .

Equivalently if the inverse image of every neutrosophic open set in (Y, S) is a generalized neutrosophic open set in (X, T) .

- (ii) A map $f : (X, T) \rightarrow (Y, S)$ is said to be generalized neutrosophic irresolute if the inverse image of every generalized neutrosophic closed set in (Y, S) is a generalized neutrosophic closed set in (X, T) .

Equivalently if the inverse image of every generalized neutrosophic open set in (Y, S) is a generalized neutrosophic open set in (X, T) .

- (iii) A map $f : (X, T) \rightarrow (Y, S)$ is said to be strongly neutrosophic continuous if $f^{-1}(A)$ is both neutrosophic open and neutrosophic closed in (X, T) for each neutrosophic set A in (Y, S) .
- (iv) A map $f : (X, T) \rightarrow (Y, S)$ is said to be perfectly neutrosophic continuous if $f^{-1}(A)$ is both neutrosophic open and neutrosophic closed in (X, T) for each neutrosophic open set A in (Y, S) .
- (v) A map $f : (X, T) \rightarrow (Y, S)$ is said to be strongly generalized neutrosophic continuous if the inverse image of every generalized neutrosophic open set in (Y, S) is an neutrosophic open set in (X, T) .
- (vi) A map $f : (X, T) \rightarrow (Y, S)$ is said to be perfectly generalized neutrosophic continuous if the inverse image of every generalized neutrosophic open set in (Y, S) is both neutrosophic open and neutrosophic closed in (X, T) .

Proposition 3.5. Let (X, T) and (Y, S) be any two neutrosophic topological spaces. Let $f : (X, T) \rightarrow (Y, S)$ be a generalized neutrosophic continuous mapping. Then for every neutrosophic set A in X , $f(NGcl(A)) \subseteq Ncl(f(A))$.

Proof. Let A be an neutrosophic set in (X, T) . Since $Ncl(f(A))$ is a neutrosophic closed set and f is a generalized neutrosophic continuous mapping, $f^{-1}(Ncl(f(A)))$ is a generalized neutrosophic closed set and $f^{-1}(Ncl(f(A))) \supseteq A$. Now, $NGcl(A) \subseteq f^{-1}(Ncl(f(A)))$. Therefore, $f(NGcl(A)) \subseteq Ncl(f(A))$. \square

Proposition 3.6. Let (X, T) and (Y, S) be any two neutrosophic topological spaces. Let $f : (X, T) \rightarrow (Y, S)$ be a generalized neutrosophic continuous mapping. Then for every neutrosophic set A in Y , $NGcl(f^{-1}(A)) \subseteq f^{-1}(Ncl(A))$.

Proof. Let A be a neutrosophic set in (Y, S) . Let $B = f^{-1}(A)$. Then, $f(B) = f(f^{-1}(A)) \subseteq A$. By Proposition 3.5., $f(NGcl(f^{-1}(A))) \subseteq Ncl(f(f^{-1}(A)))$. Thus, $NGcl(f^{-1}(A)) \subseteq f^{-1}(Ncl(A))$. \square

Proposition 3.7. Let (X, T) and (Y, S) be any two neutrosophic topological spaces. If A is a generalized neutrosophic closed set in (X, T) and if $f : (X, T) \rightarrow (Y, S)$ is neutrosophic continuous and neutrosophic closed mapping then $f(A)$ is a generalized neutrosophic closed set in (Y, S) .

Proof. Let G be a neutrosophic open set in (Y, S) . If $f(A) \subseteq G$ then $A \subseteq f^{-1}(G)$ in (X, T) . Since A is a generalized neutrosophic closed set and $f^{-1}(G)$ is a neutrosophic open set in (X, T) , $Ncl(A) \subseteq f^{-1}(G)$. That is, $f(Ncl(A)) \subseteq G$. Now, by assumption, $f(Ncl(A))$ is a neutrosophic closed set in (Y, S) and $Ncl(f(A)) \subseteq Ncl(f(Ncl(A))) = f(Ncl(A)) \subseteq G$. Hence, $f(A)$ is a generalized neutrosophic closed set. \square

Proposition 3.8. Let (X, T) and (Y, S) be any two neutrosophic topological spaces. If $f : (X, T) \rightarrow (Y, S)$ is a neutrosophic continuous mapping then it is a generalized neutrosophic continuous mapping.

Proof. Let A be a neutrosophic open set in (Y, S) . Since f is a neutrosophic continuous mapping, $f^{-1}(A)$ is a neutrosophic open set in (X, T) . Every neutrosophic open set is a generalized neutrosophic open set. Now, $f^{-1}(A)$ is a generalized neutrosophic open set in (X, T) . Hence, f is a generalized neutrosophic continuous mapping.

The converse of Proposition 3.8., need not be true as shown in Example 3.1. □

Example 3.1. Let $X = \{a, b, c\}$. Define the neutrosophic sets A and B in X as follows:
 $A = \langle x, (\frac{a}{0.4}, \frac{b}{0.4}, \frac{c}{0.5}), (\frac{a}{0.4}, \frac{b}{0.4}, \frac{c}{0.5}), (\frac{a}{0.2}, \frac{b}{0.4}, \frac{c}{0.3}) \rangle$, $B = \langle x, (\frac{a}{0.4}, \frac{b}{0.5}, \frac{c}{0.6}), (\frac{a}{0.4}, \frac{b}{0.5}, \frac{c}{0.6}), (\frac{a}{0.3}, \frac{b}{0.2}, \frac{c}{0.3}) \rangle$.
 Then the families $T = \{0_N, 1_N, A\}$ and $S = \{0_N, 1_N, B\}$ are neutrosophic topologies on X . Thus, (X, T) and (X, S) are neutrosophic topological spaces. Define $f : (X, T) \rightarrow (X, S)$ as $f(a) = b, f(b) = a, f(c) = c$. **Then f is a generalized neutrosophic continuous mapping.** But, $f^{-1}(B)$ is not a neutrosophic open set in (X, T) for $B \in S$. **Hence, f is not a neutrosophic continuous mapping.**

Proposition 3.9. Let (X, T) and (Y, S) be any two neutrosophic topological spaces. If $f : (X, T) \rightarrow (Y, S)$ is a generalized neutrosophic irresolute mapping then it is a generalized neutrosophic continuous mapping.

Proof. Let A be a neutrosophic open set in (Y, S) . Every neutrosophic open set is a generalized neutrosophic open set. Now, A is a generalized neutrosophic open set. Since f is a generalized neutrosophic irresolute mapping, $f^{-1}(A)$ is a generalized neutrosophic open set in (X, T) . Thus, f is a generalized neutrosophic continuous mapping.

The converse of Proposition 3.9., need not be true as shown in Example 3.2. □

Example 3.2. Let $X = \{a, b, c\}$. Define the neutrosophic sets A, B and C in X as follows:
 $A = \langle x, (\frac{a}{0.4}, \frac{b}{0.5}, \frac{c}{0.5}), (\frac{a}{0.4}, \frac{b}{0.5}, \frac{c}{0.5}), (\frac{a}{0.5}, \frac{b}{0.5}, \frac{c}{0.5}) \rangle$, $B = \langle x, (\frac{a}{0.7}, \frac{b}{0.6}, \frac{c}{0.5}), (\frac{a}{0.7}, \frac{b}{0.6}, \frac{c}{0.5}), (\frac{a}{0.3}, \frac{b}{0.4}, \frac{c}{0.5}) \rangle$
 and $C = \langle x, (\frac{a}{0.5}, \frac{b}{0.5}, \frac{c}{0.5}), (\frac{a}{0.5}, \frac{b}{0.5}, \frac{c}{0.5}), (\frac{a}{0.4}, \frac{b}{0.5}, \frac{c}{0.5}) \rangle$. Then the families $T = \{0_N, 1_N, A, B\}$ and $S = \{0_N, 1_N, C\}$ are neutrosophic topologies on X . Thus, (X, T) and (X, S) are neutrosophic topological spaces. Define $f : (X, T) \rightarrow (X, S)$ as follows: $f(a) = c, f(b) = c, f(c) = c$. **Then f is a generalized neutrosophic continuous mapping.** But for a generalized neutrosophic open set $D = \langle x, (\frac{a}{0.5}, \frac{b}{0.6}, \frac{c}{0.5}), (\frac{a}{0.5}, \frac{b}{0.6}, \frac{c}{0.5}), (\frac{a}{0.4}, \frac{b}{0.4}, \frac{c}{0.4}) \rangle$ in (X, S) , $f^{-1}(D)$ is not a generalized neutrosophic open set in (X, T) . **Thus, f is not a generalized neutrosophic irresolute mapping.**

Proposition 3.10. Let (X, T) and (Y, S) be any two neutrosophic topological spaces. If $f : (X, T) \rightarrow (Y, S)$ is a strongly generalized neutrosophic continuous mapping then f is a neutrosophic continuous mapping.

Proof. Let A be a neutrosophic open set in (Y, S) . Every neutrosophic open set is a generalized neutrosophic open set. Now, A be a generalized neutrosophic open set in (Y, S) . Since f is strongly generalized neutrosophic continuous, $f^{-1}(A)$ is a neutrosophic open set in (X, T) . Hence, f is a neutrosophic continuous mapping.

The converse of Proposition 3.10., need not be true as shown in Example 3.3 □

Example 3.3. Let $X = \{a, b, c\}$. Define the neutrosophic sets A, B and C in X as follows: $A = \langle x, (\frac{a}{0.9}, \frac{b}{0.9}, \frac{c}{0.9}), (\frac{a}{0.9}, \frac{b}{0.9}, \frac{c}{0.9}), (\frac{a}{0.1}, \frac{b}{0.1}, \frac{c}{0.1}) \rangle$, $B = \langle x, (\frac{a}{0.9}, \frac{b}{0.9}, \frac{c}{0.9}), (\frac{a}{0.9}, \frac{b}{0.9}, \frac{c}{0.9}), (\frac{a}{0.1}, \frac{b}{0.1}, \frac{c}{0}) \rangle$ and $C = \langle x, (\frac{a}{0.9}, \frac{b}{0.9}, \frac{c}{0.9}), (\frac{a}{0.9}, \frac{b}{0.9}, \frac{c}{0.9}), (\frac{a}{0.1}, \frac{b}{0}, \frac{c}{0.1}) \rangle$. Then the families $T = \{0_N, 1_N, A, B\}$ and $S = \{0_N, 1_N, C\}$ are neutrosophic topologies on X . Thus, (X, T) and (X, S) are neutrosophic topological spaces. Define $f : (X, T) \rightarrow (X, S)$ as follows: $f(a) = a, f(b) = c, f(c) = b$. **Then f is a neutrosophic continuous mapping.**

Let $D = \langle x, (\frac{a}{0.9}, \frac{b}{0.9}, \frac{c}{0.99}), (\frac{a}{0.9}, \frac{b}{0.9}, \frac{c}{0.99}), (\frac{a}{0.05}, \frac{b}{0}, \frac{c}{0.01}) \rangle$ be a generalized neutrosophic open set in (X, S) . Now, $f^{-1}(D)$ is not a neutrosophic open set in (X, T) . **Thus, f is not a Strongly generalized neutrosophic continuous mapping.**

Proposition 3.11. Let (X, T) and (Y, S) be any two neutrosophic topological spaces. If $f : (X, T) \rightarrow (Y, S)$ is a perfectly generalized neutrosophic continuous mapping then f is a strongly generalized neutrosophic continuous mapping.

Proof. Let A be a generalized neutrosophic open set in (Y, S) . Since f is a perfectly generalized neutrosophic continuous mapping, $f^{-1}(A)$ is a neutrosophic open set in (X, T) . Thus, f is a strongly generalized neutrosophic continuous mapping.

The converse of Proposition 3.11., need not be true as shown in Example 3.4. □

Example 3.4. Let $X = \{a, b, c\}$. Define the neutrosophic sets A_n and B in X as follows: $A_n = \langle x, \mu_{A_n}, \sigma_{A_n}, \gamma_{A_n} : n = 0, 1, 2, \dots \rangle$ where

$$\mu_{A_n} = \begin{cases} (\frac{a}{0}, \frac{b}{0}, \frac{c}{0}), & \alpha = 0; \\ (\frac{a}{1-\alpha}, \frac{b}{1-\alpha}, \frac{c}{1-\alpha}), & 0 < \alpha \leq \frac{4n}{10n+1}; \\ (\frac{a}{1}, \frac{b}{1}, \frac{c}{1}), & \frac{4n}{10n+1} < \alpha \leq 1. \end{cases} \quad \sigma_{A_n} = \begin{cases} (\frac{a}{0}, \frac{b}{0}, \frac{c}{0}), & \alpha = 0; \\ (\frac{a}{1-\alpha}, \frac{b}{1-\alpha}, \frac{c}{1-\alpha}), & 0 < \alpha \leq \frac{4n}{10n+1}; \\ (\frac{a}{1}, \frac{b}{1}, \frac{c}{1}), & \frac{4n}{10n+1} < \alpha \leq 1. \end{cases} \quad \text{and}$$

$$\gamma_{A_n} = \begin{cases} (\frac{a}{1}, \frac{b}{1}, \frac{c}{1}), & \alpha = 0; \\ (\frac{a}{\alpha}, \frac{b}{\alpha}, \frac{c}{\alpha}), & 0 < \alpha \leq \frac{4n}{10n+1}; \\ (\frac{a}{0}, \frac{b}{0}, \frac{c}{0}), & \frac{4n}{10n+1} < \alpha \leq 1. \end{cases} \quad \text{and } B = \langle x, (\frac{a}{0.6}, \frac{b}{0.6}, \frac{c}{0.6}), (\frac{a}{0.6}, \frac{b}{0.6}, \frac{c}{0.5}), (\frac{a}{0.4}, \frac{b}{0.4}, \frac{c}{0.4}) \rangle.$$

Then the families $T = \{0_N, 1_N, A_n, n = 0, 1, 2, \dots\}$ and $S = \{0_N, 1_N, B\}$ are neutrosophic topologies on X . Thus, (X, T) and (X, S) are neutrosophic topological spaces. Define $f : (X, T) \rightarrow (X, S)$ as follows: $f(a) = c, f(b) = c, f(c) = c$. **Then f is a strongly generalized neutrosophic continuous mapping.**

Let $C = \langle x, (\frac{a}{0.7}, \frac{b}{0.7}, \frac{c}{0.7}), (\frac{a}{0.7}, \frac{b}{0.7}, \frac{c}{0.7}), (\frac{a}{0.3}, \frac{b}{0.3}, \frac{c}{0.3}) \rangle$ be a generalized neutrosophic open set in (X, S) . Now, $f^{-1}(C)$ is neutrosophic open and not neutrosophic closed in (X, T) . **Hence, f is not a perfectly generalized neutrosophic continuous mapping.**

Proposition 3.12. Let (X, T) and (Y, S) be any two neutrosophic topological spaces. If $f : (X, T) \rightarrow (Y, S)$ is a strongly neutrosophic continuous mapping then f is a strongly generalized neutrosophic continuous mapping.

Proof. Let A be a generalized neutrosophic open set in (Y, S) . Since f is a strongly neutrosophic continuous mapping, $f^{-1}(A)$ is neutrosophic open and neutrosophic closed in (X, T) . Hence, f is a strongly generalized neutrosophic continuous mapping.

The converse of Proposition 3.12., need not be true as shown in Example 3.5. □

Example 3.5. Let $X = \{a, b, c\}$. Define the neutrosophic sets A_n and B in X as follows:

$A_n = \langle x, \mu_{A_n}, \sigma_{A_n}, \gamma_{A_n} : n = 0, 1, 2, \dots \rangle$ where

$$\mu_{A_n} = \begin{cases} (\frac{a}{0}, \frac{b}{0}, \frac{c}{0}), & \alpha = 0; \\ (\frac{a}{1-\alpha}, \frac{b}{1-\alpha}, \frac{c}{1-\alpha}), & 0 < \alpha \leq \frac{4n}{10n+1}; \\ (\frac{a}{1}, \frac{b}{1}, \frac{c}{1}), & \frac{4n}{10n+1} < \alpha \leq 1. \end{cases}; \sigma_{A_n} = \begin{cases} (\frac{a}{0}, \frac{b}{0}, \frac{c}{0}), & \alpha = 0; \\ (\frac{a}{1-\alpha}, \frac{b}{1-\alpha}, \frac{c}{1-\alpha}), & 0 < \alpha \leq \frac{4n}{10n+1}; \\ (\frac{a}{1}, \frac{b}{1}, \frac{c}{1}), & \frac{4n}{10n+1} < \alpha \leq 1. \end{cases} \text{ and}$$

$$\gamma_{A_n} = \begin{cases} (\frac{a}{1}, \frac{b}{1}, \frac{c}{1}), & \alpha = 0; \\ (\frac{a}{\alpha}, \frac{b}{\alpha}, \frac{c}{\alpha}), & 0 < \alpha \leq \frac{4n}{10n+1}; \\ (\frac{a}{0}, \frac{b}{0}, \frac{c}{0}), & \frac{4n}{10n+1} < \alpha \leq 1. \end{cases} \text{ and } B = \langle x, (\frac{a}{0.6}, \frac{b}{0.6}, \frac{c}{0.6}), (\frac{a}{0.6}, \frac{b}{0.6}, \frac{c}{0.6}), (\frac{a}{0.4}, \frac{b}{0.4}, \frac{c}{0.4}) \rangle.$$

Then the families $T = \{0_N, 1_N, A_n, n = 0, 1, 2, \dots\}$ and $S = \{0_N, 1_N, B\}$ are neutrosophic topologies on X . Thus, (X, T) and (X, S) are neutrosophic topological spaces. Define $f : (X, T) \rightarrow (X, S)$ as follows: $f(a) = c, f(b) = c, f(c) = c$. **Then f is a strongly generalized neutrosophic continuous mapping.**

Let $D = \langle x, (\frac{a}{0.9}, \frac{b}{0.9}, \frac{c}{0.9}), (\frac{a}{0.9}, \frac{b}{0.9}, \frac{c}{0.9}), (\frac{a}{0.1}, \frac{b}{0.1}, \frac{c}{0.1}) \rangle$ be a neutrosophic set in (X, S) . Then $f^{-1}(D)$ is a neutrosophic open set and but not a neutrosophic closed set in (X, T) . **Hence, f is not a strongly neutrosophic continuous mapping.**

Proposition 3.13. Let (X, T) and (Y, S) be any two neutrosophic topological spaces. If $f : (X, T) \rightarrow (Y, S)$ is a strongly neutrosophic continuous mapping then f is a generalized neutrosophic irresolute mapping.

Proof. Let A be a generalized neutrosophic open set in (Y, S) . Since f is a strongly neutrosophic continuous mapping, $f^{-1}(A)$ is neutrosophic open and neutrosophic closed in (X, T) . Since every neutrosophic open set is a generalized neutrosophic open set, $f^{-1}(A)$ is a generalized neutrosophic open set in (X, T) . Hence, f is a generalized neutrosophic irresolute mapping.

The converse of Proposition 3.13., need not be true as shown in Example 3.6. □

Example 3.6. Let $X = \{a, b, c\}$. Define the neutrosophic sets A_n and B in X as follows:

$A_n = \langle x, \mu_{A_n}, \sigma_{A_n}, \gamma_{A_n} : n = 0, 1, 2, \dots \rangle$ where

$$\mu_{A_n} = \begin{cases} (\frac{a}{0}, \frac{b}{0}, \frac{c}{0}), & \alpha = 0; \\ (\frac{a}{1-\alpha}, \frac{b}{1-\alpha}, \frac{c}{1-\alpha}), & 0 < \alpha \leq \frac{4n}{10n+1}; \\ (\frac{a}{1}, \frac{b}{1}, \frac{c}{1}), & \frac{4n}{10n+1} < \alpha \leq 1. \end{cases}; \sigma_{A_n} = \begin{cases} (\frac{a}{0}, \frac{b}{0}, \frac{c}{0}), & \alpha = 0; \\ (\frac{a}{1-\alpha}, \frac{b}{1-\alpha}, \frac{c}{1-\alpha}), & 0 < \alpha \leq \frac{4n}{10n+1}; \\ (\frac{a}{1}, \frac{b}{1}, \frac{c}{1}), & \frac{4n}{10n+1} < \alpha \leq 1. \end{cases} \text{ and}$$

$$\gamma_{A_n} = \begin{cases} (\frac{a}{1}, \frac{b}{1}, \frac{c}{1}), & \alpha = 0; \\ (\frac{a}{\alpha}, \frac{b}{\alpha}, \frac{c}{\alpha}), & 0 < \alpha \leq \frac{4n}{10n+1}; \text{ and } B = \langle x, (\frac{a}{0.6}, \frac{b}{0.6}, \frac{c}{0.6}), (\frac{a}{0.6}, \frac{b}{0.6}, \frac{c}{0.6}), (\frac{a}{0.4}, \frac{b}{0.4}, \frac{c}{0.4}) \rangle. \text{ Then} \\ (\frac{a}{0}, \frac{b}{0}, \frac{c}{0}), & \frac{4n}{10n+1} < \alpha \leq 1. \end{cases}$$

the families $T = \{0_N, 1_N, A_n, n = 0, 1, 2, \dots\}$ and $S = \{0_N, 1_N, B\}$ are neutrosophic topologies on X . Thus, (X, T) and (X, S) are neutrosophic topological spaces. Define $f : (X, T) \rightarrow (X, S)$ as follows: $f(a) = c, f(b) = c, f(c) = c$. **Then f is a generalized neutrosophic irresolute mapping.**

Let $D = \langle x, (\frac{a}{0.9}, \frac{b}{0.9}, \frac{c}{0.9}), (\frac{a}{0.9}, \frac{b}{0.9}, \frac{c}{0.9}), (\frac{a}{0.1}, \frac{b}{0.1}, \frac{c}{0.1}) \rangle$ be a neutrosophic set in (X, S) . Then $f^{-1}(D)$ is neutrosophic open and not neutrosophic closed in (X, T) . **Hence, f is not a strongly neutrosophic continuous mapping.**

Proposition 3.14. Let $(X, T), (Y, S)$ and (Z, R) be any three neutrosophic topological spaces. Let $f : (X, T) \rightarrow (Y, S)$ be a generalized neutrosophic irresolute mapping and $g : (Y, S) \rightarrow (Z, R)$ be a generalized neutrosophic continuous mapping. Then $g \circ f$ is a generalized neutrosophic continuous mapping.

Proof. Let A be a neutrosophic open set in (Z, R) . Since g is a generalized neutrosophic continuous mapping, $g^{-1}(A)$ is a generalized neutrosophic open set in (Y, S) . Since f is a generalized neutrosophic irresolute mapping, $f^{-1}(g^{-1}(A))$ is a generalized neutrosophic open set in (X, T) . Thus, $g \circ f$ is a generalized neutrosophic continuous mapping. \square

Proposition 3.15. Let $(X, T), (Y, S)$ and (Z, R) be any three neutrosophic topological spaces. Let $f : (X, T) \rightarrow (Y, S)$ be a strongly generalized neutrosophic continuous mapping and $g : (Y, S) \rightarrow (Z, R)$ be a generalized neutrosophic continuous mapping. Then $g \circ f$ is a neutrosophic continuous mapping.

Proof. Let A be a neutrosophic closed set in (Z, R) . Since g is a generalized neutrosophic continuous mapping, $g^{-1}(A)$ is a generalized neutrosophic closed set in (Y, S) . Since f is a strongly generalized neutrosophic continuous mapping, $f^{-1}(g^{-1}(A))$ is a neutrosophic closed set in (X, T) . Thus, $g \circ f$ is a neutrosophic continuous mapping. \square

Definition 3.4. Let (X, T) and (Y, S) be any two neutrosophic topological spaces. Let $f : (X, T) \rightarrow (Y, S)$ be a mapping. The graph $g : X \rightarrow X \times Y$ of f is defined by $g(x) = (x, f(x)), \forall x \in X$

Proposition 3.16. Let (X, T) and (Y, S) be any two neutrosophic topological spaces. Let $f : (X, T) \rightarrow (Y, S)$ be a mapping. If the graph $g : X \rightarrow X \times Y$ of f is a strongly neutrosophic continuous mapping then f is also a strongly neutrosophic continuous mapping.

Proof. Let A be a neutrosophic set in (Y, S) . By Definition 3.4., $f^{-1}(A) = 1_{\sim} \cap f^{-1}(A) = g^{-1}(1_{\sim} \times A)$. Since g is a strongly neutrosophic continuous mapping, $g^{-1}(1_{\sim} \times A)$ is both neutrosophic open and neutrosophic closed in (X, T) . Now, $f^{-1}(A)$ is both neutrosophic open and neutrosophic closed in (X, T) . Hence, f is a strongly neutrosophic continuous mapping. \square

Proposition 3.17. Let (X, T) and (Y, S) be any two neutrosophic topological spaces. Let $f : (X, T) \rightarrow (Y, S)$ be a mapping. If the graph $g : X \rightarrow X \times Y$ of f is a perfectly neutrosophic continuous mapping then f is also a perfectly neutrosophic continuous mapping.

Proof. Let A be a neutrosophic set in (Y, S) . By Definition 3.4., $f^{-1}(A) = 1_{\sim} \cap f^{-1}(A) = g^{-1}(1_{\sim} \times A)$. Since g is a perfectly neutrosophic continuous mapping, $g^{-1}(1_{\sim} \times A)$ is both neutrosophic open and neutrosophic closed in (X, T) . Hence, f is a perfectly neutrosophic continuous mapping. \square

REFERENCES

- Atanassov, K. (1983, June) Intuitionistic fuzzy sets, in: V. Sgurev, Ed., *VII ITKR's Session, Sofia (Central Sci. and Techn. Library, Bulg. Academy of Sciences, 1984)*.
- Atanassov, K. (1986). Intuitionistic fuzzy sets. *Fuzzy Sets and Systems* , 20, 87-96.
- Atanassov, K. (1988) Review and new results on Intuitionistic fuzzy sets, *Preprint IM-MFAIS-1-88, Sofia*, 1988.
- Atanassov, K., and Stoeva, S.(1983, August). Intuitionistic fuzzy sets, in: *Polish Syrup. on Interval & Fuzzy Mathematics, Poznan*, 23-26.
- Atanassov, K., and Stoeva, S.(1984) Intuitionistic L-fuzzy sets, in: R. Trappl, Ed., *Cybernetics and System Research, Vol. 2* (Elsevier, Amsterdam) 539-540.
- Chang, C. L. (1968) Fuzzy topological spaces. *Journal of mathematical Analysis and Applications*, 24, 182-190.
- Dhavaseelan, R., E. Roja, R., and M. K. Uma, M.K. (2010) Generalized intuitionistic fuzzy closed sets, *Advances in Fuzzy Mathematics*, 5, (2010) 152-172.
- Salama, A. A. and Alblowi, S. A. (2012). Neutrosophic Set and Neutrosophic Topological Spaces. *IOSR Journal of Mathematics*, 3(4), 31-35.
- Smarandache, F. (2002). Neutrosophy and Neutrosophic Logic , First International Conference on Neutrosophy , Neutrosophic Logic, Set, Probability, and Statistics University of New Mexico, Gallup, NM 87301, USA.
- Smarandache F (1999) *A unifying field in logics. Neutrosophy: Neutrosophic probability, set and logic*. American Research Press, Rehoboth.
- Smets, P. (1981). The degree of belief in a fuzzy event, *Information Sciences* , 25, 1-19.
- Sugeno, M. (1985) An Introductory survey of fuzzy control. *Information Sciences*, 36, 59-83.

Abdel-Basset, M., Mohamed, M., Smarandache, F., & Chang, V. (2018). Neutrosophic Association Rule Mining Algorithm for Big Data Analysis. *Symmetry*, 10(4), 106.

Abdel-Basset, M., & Mohamed, M. (2018). The Role of Single Valued Neutrosophic Sets and Rough Sets in Smart City: Imperfect and Incomplete Information Systems. *Measurement*. Volume 124, August 2018, Pages 47-55

Abdel-Basset, M., Gunasekaran, M., Mohamed, M., & Smarandache, F. A novel method for solving the fully neutrosophic linear programming problems. *Neural Computing and Applications*, 1-11.

Abdel-Basset, M., Manogaran, G., Gamal, A., & Smarandache, F. (2018). A hybrid approach of neutrosophic sets and DEMATEL method for developing supplier selection criteria. *Design Automation for Embedded Systems*, 1-22.

Abdel-Basset, M., Mohamed, M., & Chang, V. (2018). NMCDA: A framework for evaluating cloud computing services. *Future Generation Computer Systems*, 86, 12-29.

Abdel-Basset, M., Mohamed, M., Zhou, Y., & Hezam, I. (2017). Multi-criteria group decision making based on neutrosophic analytic hierarchy process. *Journal of Intelligent & Fuzzy Systems*, 33(6), 4055-4066.

Abdel-Basset, M.; Mohamed, M.; Smarandache, F. An Extension of Neutrosophic AHP–SWOT Analysis for Strategic Planning and Decision-Making. *Symmetry* 2018, 10, 116.

Bipolar Neutrosophic Soft Expert Set Theory

Mehmet Şahin¹, Vakkas Uluçay^{1*}, and Said Broumi³

¹ Department of Mathematics, Gaziantep University, Gaziantep27310-Turkey
E-mail: mesahin@gantep.edu.tr, vluucay27@gmail.com

² Laboratory of Information processing, Faculty of Science Ben M'Sik, University Hassan II, B.P 7955,
Sidi Othman, Casablanca, Morocco.
E-mail: broumisaid78@gmail.com

ABSTRACT

In this paper, we introduce for the first time the concept of bipolar neutrosophic soft expert set and its some operations. Also, the concept of bipolar neutrosophic soft expert set and its basic operations, namely complement, union and intersection. We give examples for these concepts.

KEYWORDS: Soft expert set, neutrosophic soft set, neutrosophic soft expert set, bipolar neutrosophic soft expert set.

Section1. Introduction

In some real life problems in expert system, belief system, information fusion and so on, we must consider the truth-membership as well as the falsity- membership for proper description of an object in uncertain, ambiguous environment. Intuitionistic fuzzy sets introduced by Atanassov (1986). After Atanassov's work, Smarandache (1998) introduced the concept of neutrosophic set which is a mathematical tool for handling problems involving imprecise, indeterminacy and inconsistent data. These sets models have been studied by many authors; on application (Molodtsov1999, Maji 2003, Cheng 2008, Gua 2009, Kharal 2013, Kang 2012, Liu 2014, Liu 2015, Majumdar 2014, Peng 2015, Sahin 2014, Broumi, & Smarandache 2015a, 2015b, Broumi, Ali & Smarandache 2015; Broumi, Talea, Bakali, & Smarandache 2016a,2016b; Broumi, Smarandache, Talea, & Bakali, 2016; Broumi, Talea, Smarandache, & Bakali 2016; Karaaslan 2016, Guo 2015), and so on.

Bosc and Pivert (2013) said that "Bipolarity refers to the propensity of the human mind to reason and make decisions on the basis of positive and negative effects. Positive information states what is possible, satisfactory, permitted, desired, or considered as being acceptable. On the other hand, negative statements express what is impossible, rejected, or forbidden. Negative preferences correspond to constraints, since they specify which values or objects have to be rejected (i.e., those that do not satisfy the constraints), while positive preferences correspond to wishes, as they specify which objects are more desirable than others (i.e., satisfy user wishes) without rejecting those that do not meet the wishes." Therefore, Lee (Lee 2000,2009) introduced the concept of bipolar fuzzy sets which is a generalization of the fuzzy sets. Recently, bipolar fuzzy models have been studied by many authors on algebraic structures such as; Majumder (2012) proposed bipolar valued fuzzy subsemigroup, bipolar valued fuzzy bi-ideal, bipolar valued fuzzy (1, 2) - ideal and bipolar valued fuzzy ideal. Manemaran and Chellappa (2010) gave some applications of bipolar fuzzy sets in groups are called the bipolar fuzzy groups, fuzzy d-ideals of groups under

(T-S) norm. Chen et al. (2014) studied of m-polar fuzzy set and illustrates how many concepts have been defined based on bipolar fuzzy sets.

Alkhalaleh et al. (2011) where the mapping in which the approximate function is defined from fuzzy parameters set, and gave an application of this concept in decision making. Alkhalaleh and Salleh (2011) introduced the concept soft expert sets where user can know the opinion of all expert sets. Sahin et al. (2015) firstly proposed neutrosophic soft expert sets with operations. Until now, there is no study on soft experts in bipolar neutrosophic environment, so there is a need to develop a new mathematical tool called “bipolar neutrosophic soft expert sets. So motivated by the work of Sahin in et al. (2015) and Deli et al (2015), we introduced the concept of bipolar neutrosophic soft expert sets which is an extension of the fuzzy soft expert sets, bipolar fuzzy soft expert sets, intuitionistic fuzzy sets soft expert and neutrosophic soft expert sets.

The paper is organized as follows. In section2, we first recall the necessary background on neutrosophic sets, single valued neutrosophic sets, neutrosophic soft expert sets and bipolar neutrosophic soft set. In section3, we introduce the concept of bipolar neutrosophic soft expert set and its basic operations, namely complement, union and intersection. Finally, we conclude the paper.

Section 2. Preliminaries

In this section we recall some related definitions.

Definition 2.1: (Smarandache 1998) Let U be a space of points (objects), with a generic element in U denoted by u . A neutrosophic sets(N-sets) A in U is characterized by a truth-membership function T_A , a indeterminacy-membership function I_A and a falsity-membership function F_A . $T_A(u)$; $I_A(u)$ and $F_A(u)$ are real standard or nonstandard subsets of $[0, 1]$. It can be written as $A = \{ \langle u, (T_A(u), I_A(u), F_A(u)) \rangle : u \in U, T_A(u), I_A(u), F_A(u) \in [0, 1] \}$. There is no restriction on the sum of $T_A(u)$; $I_A(u)$ and $F_A(u)$, so

$$0 \leq \sup T_A(u) + \sup I_A(u) + \sup F_A(u) \leq 3.$$

Definition 2.2: (Maji, 2013) A neutrosophic set A is contained in another neutrosophic set B i.e. $A \subseteq B$ if $\forall x \in X, T_A(x) \leq T_B(x), I_A(x) \leq I_B(x), F_A(x) \geq F_B(x)$.

Let U be a universe, E a set of parameters, and X a soft experts (agents). Let O be a set of opinion, $Z = E \times X \times O$ and $A \subseteq Z$.

Definition 2.3: (Sahin et al., 2015) A pair (F, A) is called a neutrosophic soft expert set over U , where F is mapping given by

$$F: A \rightarrow P(U)$$

Where $P(U)$ denotes the power neutrosophic set of U .

Set- theoretic operations, for two neutrosophic soft expert sets,

$A_{NSE} = \{ \langle x, T_{F(e)}(x), I_{F(e)}(x), F_{F(e)}(x) \rangle \mid \forall e \in A, x \in U \}$ and $B_{NSE} = \{ \langle x, T_{G(e)}(x), I_{G(e)}(x), F_{G(e)}(x) \rangle \mid \forall e \in A, x \in U \}$ are given as;

1. The subset; $A_{NSE} \subseteq B_{NSE}$ if and only if

$$T_{F(e)}(x) \lesssim T_{G(e)}(x), I_{F(e)}(x) \gtrsim I_{G(e)}(x), F_{F(e)}(x) \gtrsim F_{G(e)}(x) \forall e \in A, x \in U.$$

2. $A_{NSE} = B_{NSE}$ if and only if,

$$T_{F(e)}(x) = T_{G(e)}(x), I_{F(e)}(x) = I_{G(e)}(x), F_{F(e)}(x) = F_{G(e)}(x) \forall e \in A, x \in U.$$

3. The complement of A_{NSE} is denoted by A_{NS}^c and is defined by

$$A_{NSE}^c = \{ \langle x, T_{F^c(x)} = F_{F(x)}, I_{F^c(x)} = I_{F(x)}, F_{F^c(x)} = T_{F(x)} \mid x \in X \}$$

4. The intersection

$$A_{NSE} \cap B_{NSE} = \{ \langle x, \min\{T_{F(e)}(x), T_{G(e)}(x)\}, \max\{I_{F(e)}(x), I_{G(e)}(x)\}, \max\{F_{F(e)}(x), F_{G(e)}(x)\} \rangle : x \in X \}$$

5. The union

$$A_{NSE} \cup B_{NSE} = \{ \langle x, \max\{T_{F(e)}(x), T_{G(e)}(x)\}, \min\{I_{F(e)}(x), I_{G(e)}(x)\}, \min\{F_{F(e)}(x), F_{G(e)}(x)\} \rangle : x \in X \}$$

Definition 2.4: [Deli et a., 2015] A bipolar neutrosophic set A in X is defined as an object of the form

$$A = \{ \langle x, T^+(x), I^+(x), F^+(x), T^-(x), I^-(x), F^-(x) \rangle : x \in X \},$$

where $T^+, I^+, F^+ : X \rightarrow [1, 0]$ and $T^-, I^-, F^- : X \rightarrow [-1, 0]$.

Definition 2.5: (Deli et al. 2015) Let $\tilde{a}_1 = \langle T_1^+, I_1^+, F_1^+, T_1^-, I_1^-, F_1^- \rangle$ and $\tilde{a}_2 = \langle T_2^+, I_2^+, F_2^+, T_2^-, I_2^-, F_2^- \rangle$ be two bipolar neutrosophic number . Then the operations for NNs are defined as below;

- i. $\lambda \tilde{a}_1 = \langle 1 - (1 - T_1^+)^\lambda, (I_1^+)^\lambda, (F_1^+)^\lambda, -(-T_1^-)^\lambda, -(-I_1^-)^\lambda, -(1 - (1 - (-F_1^-))^\lambda) \rangle$
- ii. $\tilde{a}_1^\lambda = \langle (T_1^+)^\lambda, 1 - (1 - I_1^+)^\lambda, 1 - (1 - F_1^+)^\lambda, -(1 - (1 - (-T_1^-))^\lambda), -(-I_1^-)^\lambda, -(-F_1^-)^\lambda \rangle$
- iii. $\tilde{a}_1 + \tilde{a}_2 = \langle T_1^+ + T_2^+ - T_1^+ T_2^+, I_1^+ I_2^+, F_1^+ F_2^+, -T_1^- T_2^-, -(-I_1^- - I_2^- - I_1^- I_2^-), -(-F_1^- - F_2^- - F_1^- F_2^-) \rangle$
- iv. $\tilde{a}_1 \cdot \tilde{a}_2 = \langle T_1^+ T_2^+, I_1^+ + I_2^+ - I_1^+ I_2^+, F_1^+ + F_2^+ - F_1^+ F_2^+, -(-T_1^- - T_2^- - T_2^- T_2^-), -I_1^- I_2^-, -F_1^- F_2^- \rangle$

where $\lambda > 0$.

Definition 2.6: (Deli et al. 2015) Let $\tilde{a}_1 = \langle T_1^+, I_1^+, F_1^+, T_1^-, I_1^-, F_1^- \rangle$ be a bipolar neutrosophic number. Then, the score function $s(\tilde{a}_1)$, accuracy function $a(\tilde{a}_1)$ and certainty function $c(\tilde{a}_1)$ of an NBN are defined as follows:

- i. $\tilde{s}(\tilde{a}_1) = (T_1^+ + 1 - I_1^+ + 1 - F_1^+ + 1 + T_1^- - I_1^- - F_1^-) / 6$
- ii. $\tilde{a}(\tilde{a}_1) = T_1^+ - F_1^+ + T_1^- - F_1^-$

iii. $\tilde{c}(\tilde{a}_1) = T_1^+ - F_1^-$

Definition 2.7: (Deli et al. 2015) $\tilde{a}_1 = \langle T_1^+, I_1^+, F_1^+, T_1^-, I_1^-, F_1^- \rangle$ and $\tilde{a}_2 = \langle T_2^+, I_2^+, F_2^+, T_2^-, I_2^-, F_2^- \rangle$ be two bipolar neutrosophic number. The comparison method can be defined as follows:

- i. if $\tilde{s}(\tilde{a}_1) > \tilde{s}(\tilde{a}_2)$, then \tilde{a}_1 is greater than \tilde{a}_2 , that is, \tilde{a}_1 is superior to \tilde{a}_2 , denoted by $\tilde{a}_1 > \tilde{a}_2$
- ii. $\tilde{s}(\tilde{a}_1) = \tilde{s}(\tilde{a}_2)$ and $\tilde{a}(\tilde{a}_1) > \tilde{a}(\tilde{a}_2)$, then \tilde{a}_1 is greater than \tilde{a}_2 , that is, \tilde{a}_1 is superior to \tilde{a}_2 , denoted by $\tilde{a}_1 < \tilde{a}_2$;
- iii. if $\tilde{s}(\tilde{a}_1) = \tilde{s}(\tilde{a}_2)$, $\tilde{a}(\tilde{a}_1) = \tilde{a}(\tilde{a}_2)$ and $\tilde{c}(\tilde{a}_1) > \tilde{c}(\tilde{a}_2)$, then \tilde{a}_1 is greater than \tilde{a}_2 , that is, \tilde{a}_1 is superior to \tilde{a}_2 , denoted by $\tilde{a}_1 > \tilde{a}_2$;
- iv. if $\tilde{s}(\tilde{a}_1) = \tilde{s}(\tilde{a}_2)$, $\tilde{a}(\tilde{a}_1) = \tilde{a}(\tilde{a}_2)$ and $\tilde{c}(\tilde{a}_1) = \tilde{c}(\tilde{a}_2)$, then \tilde{a}_1 is equal to \tilde{a}_2 , that is, \tilde{a}_1 is indifferent to \tilde{a}_2 , denoted by $\tilde{a}_1 = \tilde{a}_2$.

Section 3. Bipolar Neutrosophic Soft Expert Set

In this section, using the concept of bipolar neutrosophic set now we introduce the concept of bipolar neutrosophic soft expert set and we also give basic properties of this concept.

Let U be a universe, E a set of parameters, X a set of experts (agents), and $O = \{1 = agree, 0 = disagree\}$ a set of opinions. Let $Z = E \times X \times O$ and $\bar{A} \subseteq Z$.

Definition 3.1: A pair (H, \bar{A}) is called a bipolar neutrosophic soft expert set over U , where H is mapping given by

$$H: \bar{A} \rightarrow P(U)$$

where $P(U)$ denotes the power bipolar neutrosophic set of U and

$$(H, \bar{A}) = \left\{ \left\langle u, T_{H(e)}^+(u), I_{H(e)}^+(u), F_{H(e)}^+(u), T_{H(e)}^-(u), I_{H(e)}^-(u), F_{H(e)}^-(u) \right\rangle : \forall e \in A, u \in U \right\},$$

where $T_{H(e)}^+, I_{H(e)}^+, F_{H(e)}^+ : U \rightarrow [1, 0]$ and $T_{H(e)}^-, I_{H(e)}^-, F_{H(e)}^- : U \rightarrow [-1, 0]$.

For definition we consider an example.

Example 3.2: Suppose the following U is the set of notebook under consideration E is the set of parameters. Each parameter is a neutrosophic word or sentence involving neutrosophic words.

$$E = \{\text{cheap ; expensive}\} = \{e_1, e_2\}$$

$X = \{p, q, r\}$ be a set of experts. Suppose that

$$H(e_1, p, 1) = \{ \langle u_1, 0.3, 0.5, 0.7, -0.2, -0.3, -0.4 \rangle, \langle u_3, 0.5, 0.6, 0.3, -0.3, -0.4, -0.1 \rangle \}$$

$$H(e_1, q, 1) = \{ \langle u_2, 0.8, 0.2, 0.3, -0.1, -0.3, -0.5 \rangle, \langle u_3, 0.9, 0.5, 0.7, -0.4, -0.1, -0.2 \rangle \}$$

$$H(e_1, r, 1) = \{ \langle u_1, 0.4, 0.7, 0.6, -0.6, -0.2, -0.4 \rangle \}$$

$$H(e_2, p, 1) = \{ \langle u_1, 0.4, 0.2, 0.3, -0.2, -0.3, -0.1 \rangle, \langle u_2, 0.7, 0.1, 0.3, -0.3, -0.2, -0.5 \rangle \}$$

$$H(e_2, q, 1) = \{ \langle u_3, 0.3, 0.4, 0.2, -0.5, -0.1, -0.4 \rangle \}$$

$$H(e_2, r, 1) = \{ \langle u_2, 0.3, 0.4, 0.9, -0.4, -0.3, -0.1 \rangle \}$$

$$H(e_1, p, 0) = \{ \langle u_2, 0.5, 0.2, 0.3, -0.5, -0.2, -0.3 \rangle \}$$

$$H(e_1, q, 0) = \{ \langle u_1, 0.6, 0.3, 0.5, -0.4, -0.2, -0.6 \rangle \}$$

$$H(e_1, r, 0) = \{ \langle u_2, 0.7, 0.6, 0.4, -0.3, -0.4, -0.5 \rangle, \langle u_3, 0.9, 0.5, 0.7, -0.2, -0.3, -0.5 \rangle \}$$

$$H(e_2, p, 0) = \{ \langle u_3, 0.7, 0.9, 0.6, -0.2, -0.3, -0.4 \rangle \}$$

$$H(e_2, q, 0) = \{ \langle u_1, 0.7, 0.3, 0.6, -0.3, -0.2, -0.4 \rangle, \langle u_2, 0.6, 0.2, 0.5, -0.3, -0.1, -0.4 \rangle \}$$

$$H(e_2, r, 0) = \{ \langle u_1, 0.6, 0.2, 0.5, -0.5, -0.3, -0.2 \rangle, \langle u_3, 0.7, 0.2, 0.8, -0.6, -0.2, -0.1 \rangle \}$$

The bipolar neutrosophic soft expert set (H, \bar{Z}) is a parameterized family $\{H(e_i), i = 1, 2, 3, \dots\}$ of all neutrosophic sets of U and describes a collection of approximation of an object.

Definition 3.3: Let (H, \bar{A}) and (G, \bar{B}) be two bipolar neutrosophic soft expert sets over the common universe U . (H, \bar{A}) is said to be bipolar neutrosophic soft expert subset of (G, \bar{B}) , if $(H, \bar{A}) \subseteq (G, \bar{B})$ if and only if

$$T_{H(e)}^+(u) \leq T_{G(e)}^+(u), I_{H(e)}^+(u) \leq I_{G(e)}^+(u), F_{H(e)}^+(u) \geq F_{G(e)}^+(u),$$

and

$$T_{H(e)}^-(u) \geq T_{G(e)}^-(u), I_{H(e)}^-(u) \geq I_{G(e)}^-(u), F_{H(e)}^-(u) \leq F_{G(e)}^-(u)$$

$$\forall e \in A, u \in U.$$

(H, \bar{A}) is said to be bipolar neutrosophic soft expert superset of (G, \bar{B}) if (G, \bar{B}) is a neutrosophic soft expert subset of (H, \bar{A}) . We denote by $(H, \bar{A}) \supseteq (G, \bar{B})$.

Example 3.4: Suppose that a company produced new types of its products and wishes to take the opinion of some experts about price of these products. Let $U = \{u_1, u_2, u_3\}$ be a set of product, $E = \{e_1, e_2\}$ a set of decision parameters where $e_i (i = 1, 2)$ denotes the decision “cheap”, “expensive” respectively and let $X = \{p, q, r\}$ be a set of experts. Suppose (H, \bar{A}) and (G, \bar{B}) be defined as follows:

$$(H, \bar{A}) =$$

$$\{[(e_1, p, 1), \langle u_1, 0.3, 0.5, 0.6, -0.2, -0.3, -0.4 \rangle, \langle u_2, 0.5, 0.2, 0.3, -0.4, -0.2, -0.5 \rangle],$$

$$[(e_2, p, 0), \langle u_2, 0.2, 0.4, 0.7, -0.5, -0.4, -0.3 \rangle],$$

$$[(e_1, q, 1), \langle u_1, 0.6, 0.3, 0.5, -0.6, -0.2, -0.5 \rangle, \langle u_2, 0.6, 0.2, 0.3, -0.5, -0.4, -0.3 \rangle],$$

$$[(e_1, r, 0), \langle u_1, 0.2, 0.7, 0.3, -0.4, -0.3, -0.5 \rangle],$$

$$[(e_2, r, 1), \langle u_2, 0.3, 0.4, 0.9, -0.3, -0.2, -0.4 \rangle, \langle u_3, 0.7, 0.2, 0.8, -0.5, -0.3, -0.6 \rangle\}].$$

$$(G, \bar{B}) = \{[(e_1, p, 1), \langle u_1, 0.3, 0.5, 0.7, -0.2, -0.3, -0.6 \rangle, \langle u_2, 0.5, 0.2, 0.3, -0.1, -0.2, -0.7 \rangle], \\ [(e_2, p, 0), \langle u_2, 0.2, 0.4, 0.7, -0.2, -0.4, -0.5 \rangle], \\ [(e_1, q, 1), \langle u_1, 0.6, 0.3, 0.5, -0.1, -0.2, -0.8 \rangle, \langle u_2, 0.6, 0.2, 0.3, -0.3, -0.1, -0.4 \rangle]\}.$$

Therefore

$$(H, \bar{A}) \cong (G, \bar{B}).$$

Definition 3.5: Let (H, \bar{A}) and (G, \bar{B}) be two bipolar neutrosophic soft expert sets over the common universe U . (H, \bar{A}) is said to be bipolar neutrosophic soft expert equal (G, \bar{B}) , if $(H, \bar{A}) = (G, \bar{B})$ if and only if

$$T_{H(e)}^+(u) = T_{G(e)}^+(u), I_{H(e)}^+(u) = I_{G(e)}^+(u), F_{H(e)}^+(u) = F_{G(e)}^+(u),$$

and

$$T_{H(e)}^-(u) = T_{G(e)}^-(u), I_{H(e)}^-(u) = I_{G(e)}^-(u), F_{H(e)}^-(u) = F_{G(e)}^-(u)$$

$\forall e \in A, u \in U$.

Definition 3.6: NOT set of set parameters. Let $E = \{e_1, e_2, \dots, e_n\}$ be a set of parameters. The NOT set of E is denoted by $\neg E = \{\neg e_1, \neg e_2, \dots, \neg e_n\}$ where $\neg e_i = \text{not } e_i, \forall i=1, 2, \dots, n$.

Example 3.7: Consider example 3.2. Here $\neg E = \{\text{not cheap, not expensive}\}$

Definition 3.8: Complement of a bipolar neutrosophic soft expert set. The complement of a bipolar neutrosophic soft expert set (H, \bar{A}) denoted by $(H, \bar{A})^c$ and is defined as $(H, \bar{A})^c = (H^c, \neg \bar{A})$ where $H^c = \neg \bar{A} \rightarrow P(U)$ is mapping given by $H^c(u) =$ neutrosophic soft expert complement with

$$T_{H^c(u)}^+ = F_{H(u)}^+, I_{H^c(u)}^+ = I_{H(u)}^+, F_{H^c(u)}^+ = T_{H(u)}^+$$

and

$$T_{H^c(u)}^- = F_{H(u)}^-, I_{H^c(u)}^- = I_{H(u)}^-, F_{H^c(u)}^- = T_{H(u)}^-$$

Example 3.9: Consider the Example 3.2. Then $(H, \bar{Z})^c$ describes the “not price of the notebook” we have

$$(H, \bar{Z})^c = \{(\neg e_1, p, 1), [\langle u_2, 0.3, 0.2, 0.5, -0.3, -0.2, -0.5 \rangle], \\ [(\neg e_1, q, 1), \langle u_1, 0.5, 0.3, 0.6, -0.4, -0.1, -0.3 \rangle], \\ [(\neg e_1, r, 1), \langle u_2, 0.4, 0.6, 0.7, -0.3, -0.4, -0.2 \rangle, \langle u_3, 0.7, 0.5, 0.9, -0.1, -0.2, -0.3 \rangle], \\ [(\neg e_2, p, 1), \langle u_3, 0.6, 0.9, 0.7, -0.4, -0.3, -0.2 \rangle], \\ [(\neg e_2, q, 1), \langle u_1, 0.6, 0.3, 0.7, -0.5, -0.1, -0.3 \rangle, \langle u_2, 0.5, 0.2, 0.6, -0.3, -0.5, -0.6 \rangle], \\ [(\neg e_2, r, 1), \langle u_1, 0.5, 0.2, 0.6, -0.6, -0.2, -0.4 \rangle, \langle u_3, 0.8, 0.2, 0.7, -0.3, -0.4, -0.1 \rangle],$$

$$\begin{aligned}
 & [(\neg e_1, p, 0), \langle u_1, 0.7, 0.5, 0.3, -0.4, -0.2, -0.3 \rangle, \langle u_3, 0.3, 0.6, 0.5, -0.6, -0.3, -0.5 \rangle], \\
 & [(\neg e_1, q, 0), \langle u_2, 0.3, 0.2, 0.8, -0.3, -0.2, -0.7 \rangle, \langle u_3, 0.9, 0.5, 0.7, -0.7, -0.3, -0.5 \rangle], \\
 & [(\neg e_1, r, 0), \langle u_1, 0.6, 0.7, 0.4, -0.4, -0.3, -0.5 \rangle], \\
 & [(\neg e_2, p, 0), \langle u_1, 0.3, 0.2, 0.4, -0.3, -0.5, -0.4 \rangle, \langle u_2, 0.3, 0.1, 0.7, -0.6, -0.5, -0.1 \rangle], \\
 & [(\neg e_2, q, 0), \langle u_3, 0.2, 0.4, 0.3, -0.7, -0.4, -0.3 \rangle], \\
 & [(\neg e_2, r, 0), \langle u_2, 0.9, 0.4, 0.3, -0.8, -0.3, -0.5 \rangle].
 \end{aligned}$$

Definition 3.10: Empty or Null bipolar neutrosophic soft expert set with respect to parameter. A bipolar neutrosophic soft expert set (H, \bar{A}) over the universe U is termed to be empty or null bipolar neutrosophic soft expert set with respect to the parameter \bar{A} if

$$T_{H(e)}^+(u) = T_{G(e)}^+(u) = 0, I_{H(e)}^+(u) = I_{G(e)}^+(u) = 0, F_{H(e)}^+(u) = F_{G(e)}^+(u) = 0,$$

and

$$T_{H(e)}^-(u) = T_{G(e)}^-(u) = 0, I_{H(e)}^-(u) = I_{G(e)}^-(u) = 0, F_{H(e)}^-(u) = F_{G(e)}^-(u) = 0$$

$\forall e \in \bar{A}, u \in U.$

In this case the null bipolar neutrosophic soft expert set (NBNSSES) is denoted by $\Phi_{\bar{A}}$.

Example 3.11: Let $U = \{u_1, u_2, u_3\}$ the set of three handbags be considered as universal set $E = \{quality\} = \{e_1\}$ be the set of parameters that characterizes the handbag and let $X = \{p, q\}$ be a set of experts.

$$\begin{aligned}
 \Phi_{\bar{A}} = (\text{NBNSSES}) = & \{[(e_1, p, 1), \langle u_1, 0, 0, 0, 0, 0 \rangle, \langle u_2, 0, 0, 0, 0, 0 \rangle], \\
 & [(e_1, q, 1), \langle u_1, 0, 0, 0, 0, 0 \rangle, \langle u_2, 0, 0, 0, 0, 0 \rangle], \\
 & [(e_1, p, 0), \langle u_3, 0, 0, 0, 0, 0 \rangle], \\
 & [(e_1, q, 0), \langle u_3, 0, 0, 0, 0, 0 \rangle]\}.
 \end{aligned}$$

Here the (NBNSSES) (H, \bar{A}) is the null bipolar neutrosophic soft expert sets.

Definition 3.12: An agree-bipolar neutrosophic soft expert set $(H, \bar{A})_1$ over U is a bipolar neutrosophic soft expert subset of (H, \bar{A}) defined as follow

$$(H, \bar{A})_1 = \{H_1(u) : u \in E \times X \times \{1\}\}.$$

Example 3.13: Consider Example 3.2. Then the agree-bipolar neutrosophic soft expert set $(H, \bar{A})_1$ over U is

$$\begin{aligned}
 (H, \bar{A})_1 = & \{[(e_1, p, 1), \langle u_1, 0.3, 0.5, 0.7, -0.2, -0.3, -0.4 \rangle, \langle u_3, 0.5, 0.6, 0.3, -0.3, -0.4, -0.1 \rangle], \\
 & [(e_1, q, 1), \langle u_2, 0.8, 0.2, 0.3, -0.1, -0.3, -0.5 \rangle, \langle u_3, 0.9, 0.5, 0.7, -0.4, -0.1, -0.2 \rangle],
 \end{aligned}$$

$$\begin{aligned}
 & [(e_1, r, 1), \langle u_1, 0.4, 0.7, 0.6, -0.6, -0.2, -0.4 \rangle], \\
 & [(e_2, p, 1), \langle u_1, 0.4, 0.2, 0.3, -0.2, -0.3, -0.1 \rangle, \langle u_2, 0.7, 0.1, 0.3, -0.3, -0.2, -0.5 \rangle], \\
 & [(e_2, q, 1), \langle u_3, 0.3, 0.4, 0.2, -0.5, -0.1, -0.4 \rangle], \\
 & [(e_2, r, 1), \langle u_2, 0.3, 0.4, 0.9, -0.4, -0.3, -0.1 \rangle].
 \end{aligned}$$

Definition 3.14: A disagree-bipolar neutrosophic soft expert set $(H, \bar{A})_0$ over U is a bipolar neutrosophic soft expert subset of (H, \bar{A}) defined as follow

$$(H, \bar{A})_0 = \{F_0(u) : u \in E \times X \times \{0\}\}.$$

Example 3.15: Consider Example 3.2. Then the disagree-bipolar neutrosophic soft expert set $(H, \bar{A})_0$ over U is

$$\begin{aligned}
 (H, \bar{A})_0 &= \{[(e_1, p, 0), \langle u_2, 0.5, 0.2, 0.3, -0.5, -0.2, -0.3 \rangle], \\
 & [(e_1, q, 0), \langle u_1, 0.6, 0.3, 0.5, -0.4, -0.2, -0.6 \rangle], \\
 & [(e_1, r, 0), \langle u_2, 0.7, 0.6, 0.4, -0.3, -0.4, -0.5 \rangle, \langle u_3, 0.9, 0.5, 0.7, -0.2, -0.3, -0.5 \rangle], \\
 & [(e_2, p, 0), \langle u_3, 0.7, 0.9, 0.6, -0.2, -0.3, -0.4 \rangle], \\
 & [(e_2, q, 0), \langle u_1, 0.7, 0.3, 0.6, -0.3, -0.2, -0.4 \rangle, \langle u_2, 0.6, 0.2, 0.5, -0.3, -0.1, -0.4 \rangle], \\
 & [(e_2, r, 0), \langle u_1, 0.6, 0.2, 0.5, -0.5, -0.3, -0.2 \rangle, \langle u_3, 0.7, 0.2, 0.8, -0.6, -0.2, -0.1 \rangle]\}.
 \end{aligned}$$

Definition 3.16: Union of two bipolar neutrosophic soft expert sets. Let

$(H, \bar{A}) = \left\{ \langle u, T_{H(e)}^+(u), I_{H(e)}^+(u), F_{H(e)}^+(u), T_{H(e)}^-(u), I_{H(e)}^-(u), F_{H(e)}^-(u) \rangle : \forall e \in A, u \in U \right\}$ and $(G, \bar{B}) = \left\{ \langle u, T_{G(e)}^+(u), I_{G(e)}^+(u), F_{G(e)}^+(u), T_{G(e)}^-(u), I_{G(e)}^-(u), F_{G(e)}^-(u) \rangle : \forall e \in B, u \in U \right\}$ be two bipolar neutrosophic soft expert sets. Then their union is defined as:

$$((H, \bar{A}) \cup (G, \bar{B}))(u) = \left(\begin{array}{l} \max(T_{H(e)}^+(u), T_{G(e)}^+(u)), \frac{I_{H(e)}^+(u) + I_{G(e)}^+(u)}{2}, \min((F_{H(e)}^+(u), F_{G(e)}^+(u)), \\ \min(T_{H(e)}^-(u), T_{G(e)}^-(u)), \frac{I_{H(e)}^-(u) + I_{G(e)}^-(u)}{2}, \max((F_{H(e)}^-(u), F_{G(e)}^-(u)) \end{array} \right)$$

$\forall e \in A, u \in U.$

Example 3.17: Let (H, \bar{A}) and (G, \bar{B}) be two BNSSESs over the common universe U

$$\begin{aligned}
 (H, \bar{A}) &= \{[(e_1, p, 1), \langle u_1, 0.2, 0.5, 0.8, -0.4, -0.3, -0.5 \rangle, \langle u_3, 0.2, 0.6, 0.5, -0.2, -0.1, -0.4 \\
 & \quad \rangle], [(e_1, q, 1), \langle u_1, 0.5, 0.3, 0.6, -0.2, -0.1, -0.3 \rangle, \\
 & \quad \langle u_2, 0.8, 0.2, 0.3, -0.2, -0.3, -0.1 \rangle]\}
 \end{aligned}$$

(G, \bar{B})

$$= \{(e_1, p, 1), \langle u_1, 0.1, 0.6, 0.2, -0.3, -0.1, -0.4 \rangle, \langle u_2, 0.4, 0.5, 0.8, -0.1, -0.3, -0.5 \rangle\}$$

Therefore $(H, \bar{A}) \circ (G, \bar{B}) = (R, \bar{C})$

$$(R, \bar{C}) = \left\{ \left[\begin{array}{l} (e_1, p, 1), \langle u_1, 0.2, 0.55, 0.2, -0.4, -0.2, -0.4 \rangle, \\ \langle u_2, 0.4, 0.5, 0.8 - 0.1, -0.3, -0.5 \rangle, \langle u_3, 0.2, 0.6, 0.5, -0.2, -0.1, -0.4 \rangle \end{array} \right], \right. \\ \left. [(e_1, q, 1), \langle u_1, 0.5, 0.3, 0.6, -0.2, -0.1, -0.3 \rangle, \langle u_2, 0.4, 0.5, 0.8, -0.1, -0.3, -0.5 \rangle] \right\}.$$

Definition 3.18: Intersection of two bipolar neutrosophic soft expert

sets. $(H, \bar{A}) = \left\{ \langle u, T_{H(e)}^+(u), I_{H(e)}^+(u), F_{H(e)}^+(u), T_{H(e)}^-(u), I_{H(e)}^-(u), F_{H(e)}^-(u) \rangle : \forall e \in A, u \in U \right\}$ and $(G, \bar{B}) = \left\{ \langle u, T_{G(e)}^+(u), I_{G(e)}^+(u), F_{G(e)}^+(u), T_{G(e)}^-(u), I_{G(e)}^-(u), F_{G(e)}^-(u) \rangle : \forall e \in B, u \in U \right\}$ be two bipolar neutrosophic soft expert sets. Then their intersection is defined as:

$$((H, \bar{A}) \tilde{\cap} (G, \bar{B}))(u) = \left(\begin{array}{l} \min(T_{H(e)}^+(u), T_{G(e)}^+(u)), \frac{I_{H(e)}^+(u) + I_{G(e)}^+(u)}{2}, \max(F_{H(e)}^+(u), F_{G(e)}^+(u)), \\ \max(T_{H(e)}^-(u), T_{G(e)}^-(u)), \frac{I_{H(e)}^-(u) + I_{G(e)}^-(u)}{2}, \min(F_{H(e)}^-(u), F_{G(e)}^-(u)) \end{array} \right)$$

$\forall e \in A, u \in U.$

Example 3.19: Let (H, \bar{A}) and (G, \bar{B}) be two BNSSESs over the common universe U

$$(H, \bar{A}) = \{ [(e_1, p, 1), \langle u_1, 0.2, 0.5, 0.8, -0.4, -0.3, -0.5 \rangle, \langle u_3, 0.2, 0.6, 0.5, -0.2, -0.1, -0.4 \rangle], [(e_1, q, 1), \langle u_1, 0.5, 0.3, 0.6, -0.2, -0.1, -0.3 \rangle, \langle u_2, 0.8, 0.2, 0.3, -0.2, -0.3, -0.1 \rangle] \}$$

$$(G, \bar{B}) = \{ (e_1, p, 1), \langle u_1, 0.1, 0.6, 0.2, -0.3, -0.1, -0.4 \rangle, \langle u_2, 0.4, 0.5, 0.8, -0.1, -0.3, -0.5 \rangle \}$$

Therefore $(H, \bar{A}) \tilde{\cap} (G, \bar{B}) = (R, \bar{C})$

$$(R, \bar{C}) = \{ [(e_1, p, 1), \langle u_1, 0.1, 0.55, 0.8, -0.3, -0.2, -0.5 \rangle] \}.$$

Proposition 3.20: If (H, \bar{A}) and (G, \bar{B}) are bipolar neutrosophic soft expert sets over U . Then

- i. $(H, \bar{A}) \circ (G, \bar{B}) = (G, \bar{B}) \circ (H, \bar{A})$
- ii. $(H, \bar{A}) \tilde{\cap} (G, \bar{B}) = (G, \bar{B}) \tilde{\cap} (H, \bar{A})$
- iii. $((H, \bar{A})^c)^c = (H, \bar{A})$
- iv. $(H, \bar{A}) \circ \phi = (H, \bar{A}), (H, \bar{A}) \tilde{\cap} \phi = \phi$

Proof: The proof is straightforward.

4. AN APPLICATION OF BIPOLAR NEUTROSOPHIC SOFT EXPERT SET

In this section, we present an application of bipolar neutrosophic soft expert set theory in a decision-making problem which demonstrates that this method can be successfully applied to problems of many fields that contain uncertainty. We suggest the following algorithm to solving bipolar neutrosophic soft expert based decision making method as follows:

1. Input the bipolar neutrosophic soft expert set (F, Z) .
2. Find an agree-multibipolarneutrosophicsoftexpert set and a disagree-bipolarneutrosophicsoftexpert set.
3. Now calculate the bipolar neutrosophic soft expert set [27] the score function $s(u_i) = (T_1^+ + 1 - I_1^+ + 1 - F_1^+ + 1 + T_1^- - I_1^- - F_1^-)/6$ of agree (u_i) and $C_j = \sum_i(u)_{ij}$ for agree- bipolar neutrosophic soft expert set.
4. Now calculate the bipolar neutrosophic soft expert set the score function $s(u_i) = (T_1^+ + 1 - I_1^+ + 1 - F_1^+ + 1 + T_1^- - I_1^- - F_1^-)/6$ of disagree (u_i) and $K_j = \sum_i(u)_{ij}$ for disagree- bipolar neutrosophic soft expert set.
5. Find $s_j = c_j - k_j$.
6. Find u , for which $s(u) = \max u_j$, where $s(u)$ is the optimal choice object. If u has more than one value, then any one of them could be chosen by the school using its option.

Assume that a School wants to fill a position to be chosen by an expert committee. There are three alternatives $U = \{u_1, u_2, u_3\}$, and there are three parameters $E = \{e_1, e_2, e_3\}$ where the parameters e_i ($i = 1, 2, 3$) stand for “education,” “age,” and “experience” respectively. Let $X = \{p, q\}$ be the set of two expert committee members. From those findings we can find the most suitable choice for the decision. After a serious discussion, the experts construct the following bipolar neutrosophic soft expert set:

Step1-

$$\begin{aligned}
 &(F, Z) \\
 &= \left\{ \left[(e_1, p, 1), \left(\frac{u_1}{\langle 0.9, 0.3, 0.4, -0.4, -0.2, -0.7 \rangle}, \frac{u_2}{\langle 0.8, 0.2, 0.6, -0.6, -0.3, -0.1 \rangle}, \frac{u_3}{\langle 0.6, 0.3, 0.5, -0.4, -0.2, -0.3 \rangle} \right) \right], \right. \\
 &\left[(e_1, q, 1), \left(\frac{u_1}{\langle 0.8, 0.1, 0.4, -0.6, -0.2, -0.4 \rangle}, \frac{u_2}{\langle 0.2, 0.1, 0.5, -0.7, -0.2, -0.5 \rangle}, \frac{u_3}{\langle 0.4, 0.2, 0.3, -0.3, -0.1, -0.4 \rangle} \right) \right], \\
 &\left[(e_2, p, 1), \left(\frac{u_1}{\langle 0.6, 0.2, 0.3, -0.3, -0.1, -0.2 \rangle}, \frac{u_2}{\langle 0.4, 0.2, 0.5, -0.1, -0.2, -0.2 \rangle}, \frac{u_3}{\langle 0.7, 0.3, 0.6, -0.5, -0.2, -0.3 \rangle} \right) \right], \\
 &\left[(e_2, q, 1), \left(\frac{u_1}{\langle 0.6, 0.3, 0.1, -0.2, -0.1, -0.3 \rangle}, \frac{u_2}{\langle 0.7, 0.3, 0.1, -0.3, -0.1, -0.4 \rangle}, \frac{u_3}{\langle 0.6, 0.2, 0.5, -0.1, -0.2, -0.1 \rangle} \right) \right], \\
 &\left[(e_3, p, 1), \left(\frac{u_1}{\langle 0.9, 0.4, 0.6, -0.4, -0.3, -0.2 \rangle}, \frac{u_2}{\langle 0.8, 0.4, 0.2, -0.2, -0.2, -0.4 \rangle}, \frac{u_3}{\langle 0.7, 0.3, 0.4, -0.4, -0.3, -0.1 \rangle} \right) \right], \\
 &\left[(e_3, q, 1), \left(\frac{u_1}{\langle 0.8, 0.2, 0.4, -0.6, -0.2, -0.3 \rangle}, \frac{u_2}{\langle 0.6, 0.2, 0.3, -0.2, -0.3, -0.1 \rangle}, \frac{u_3}{\langle 0.5, 0.3, 0.1, -0.1, -0.5, -0.3 \rangle} \right) \right], \\
 &\left[(e_1, p, 0), \left(\frac{u_1}{\langle 0.2, 0.3, 0.4, -0.4, -0.1, -0.1 \rangle}, \frac{u_2}{\langle 0.8, 0.2, 0.6, -0.6, -0.3, -0.1 \rangle}, \frac{u_3}{\langle 0.6, 0.3, 0.5, -0.4, -0.2, -0.3 \rangle} \right) \right], \\
 &\left[(e_1, q, 0), \left(\frac{u_1}{\langle 0.6, 0.2, 0.3, -0.5, -0.2, -0.3 \rangle}, \frac{u_2}{\langle 0.5, 0.2, 0.3, -0.6, -0.1, -0.3 \rangle}, \frac{u_3}{\langle 0.4, 0.1, 0.2, -0.2, -0.3, -0.1 \rangle} \right) \right], \\
 &\left. \left[(e_2, p, 0), \left(\frac{u_1}{\langle 0.7, 0.1, 0.5, -0.4, -0.3, -0.2 \rangle}, \frac{u_2}{\langle 0.9, 0.2, 0.4, -0.4, -0.2, -0.1 \rangle}, \frac{u_3}{\langle 0.7, 0.3, 0.1, -0.1, -0.2, -0.5 \rangle} \right) \right] \right\}
 \end{aligned}$$

$$\left[(e_2, q, 0), \left(\frac{u_1}{\langle 0.4, 0.3, 0.1, -0.2, -0.1, -0.3 \rangle}, \frac{u_2}{\langle 0.7, 0.3, 0.1, -0.3, -0.1, -0.4 \rangle}, \frac{u_3}{\langle 0.6, 0.1, 0.3, -0.2, -0.1, -0.3 \rangle} \right) \right],$$

$$\left[(e_3, p, 0), \left(\frac{u_1}{\langle 0.9, 0.2, 0.4, -0.4, -0.3, -0.2 \rangle}, \frac{u_2}{\langle 0.8, 0.4, 0.2, -0.3, -0.1, -0.4 \rangle}, \frac{u_3}{\langle 0.5, 0.3, 0.4, -0.4, -0.3, -0.1 \rangle} \right) \right],$$

$$\left[(e_3, q, 0), \left(\frac{u_1}{\langle 0.7, 0.1, 0.3, -0.2, -0.1, -0.3 \rangle}, \frac{u_2}{\langle 0.7, 0.2, 0.1, -0.2, -0.3, -0.1 \rangle}, \frac{u_3}{\langle 0.8, 0.3, 0.2, -0.3, -0.1, -0.2 \rangle} \right) \right] \Bigg\}$$

Step 2-Construct the bipolar neutrosophic soft expert tables for each opinion (agree, disagree) of expert.

Table 1. Agree-bipolar neutrosophic soft expert set.

	u_1	u_2	u_3
$(e_1, p, 1)$	$\langle 0.9, 0.3, 0.4, -0.4, -0.2, -0.7 \rangle$	$\langle 0.8, 0.2, 0.6, -0.6, -0.3, -0.1 \rangle$	$\langle 0.6, 0.3, 0.5, -0.4, -0.2, -0.3 \rangle$
$(e_2, p, 1)$	$\langle 0.6, 0.2, 0.3, -0.3, -0.1, -0.2 \rangle$	$\langle 0.4, 0.2, 0.5, -0.1, -0.2, -0.2 \rangle$	$\langle 0.7, 0.3, 0.6, -0.5, -0.2, -0.3 \rangle$
$(e_3, p, 1)$	$\langle 0.9, 0.4, 0.6, -0.4, -0.3, -0.2 \rangle$	$\langle 0.8, 0.4, 0.2, -0.2, -0.2, -0.4 \rangle$	$\langle 0.7, 0.3, 0.4, -0.4, -0.3, -0.1 \rangle$
$(e_1, q, 1)$	$\langle 0.8, 0.1, 0.4, -0.6, -0.2, -0.4 \rangle$	$\langle 0.2, 0.1, 0.5, -0.7, -0.2, -0.5 \rangle$	$\langle 0.4, 0.2, 0.3, -0.3, -0.1, -0.4 \rangle$
$(e_2, q, 1)$	$\langle 0.6, 0.3, 0.1, -0.2, -0.1, -0.3 \rangle$	$\langle 0.7, 0.3, 0.1, -0.3, -0.1, -0.4 \rangle$	$\langle 0.6, 0.2, 0.5, -0.1, -0.2, -0.1 \rangle$
$(e_3, q, 1)$	$\langle 0.8, 0.2, 0.4, -0.6, -0.2, -0.3 \rangle$	$\langle 0.6, 0.2, 0.3, -0.2, -0.3, -0.1 \rangle$	$\langle 0.5, 0.3, 0.1, -0.1, -0.5, -0.3 \rangle$

Table 2. Disagree-bipolar neutrosophic soft expert set.

	u_1	u_2	u_3
$(e_1, p, 0)$	$\langle 0.2, 0.3, 0.4, -0.4, -0.1, -0.1 \rangle$	$\langle 0.8, 0.2, 0.6, -0.6, -0.3, -0.1 \rangle$	$\langle 0.6, 0.3, 0.5, -0.4, -0.2, -0.3 \rangle$
$(e_2, p, 0)$	$\langle 0.7, 0.1, 0.5, -0.4, -0.3, -0.2 \rangle$	$\langle 0.9, 0.2, 0.4, -0.4, -0.2, -0.1 \rangle$	$\langle 0.7, 0.3, 0.1, -0.1, -0.2, -0.5 \rangle$
$(e_3, p, 0)$	$\langle 0.9, 0.2, 0.4, -0.4, -0.3, -0.2 \rangle$	$\langle 0.8, 0.4, 0.2, -0.3, -0.1, -0.4 \rangle$	$\langle 0.5, 0.3, 0.4, -0.4, -0.3, -0.1 \rangle$
$(e_1, q, 0)$	$\langle 0.6, 0.2, 0.3, -0.5, -0.2, -0.3 \rangle$	$\langle 0.5, 0.2, 0.3, -0.6, -0.1, -0.3 \rangle$	$\langle 0.4, 0.1, 0.2, -0.2, -0.3, -0.1 \rangle$
$(e_2, q, 0)$	$\langle 0.4, 0.3, 0.1, -0.2, -0.1, -0.3 \rangle$	$\langle 0.7, 0.3, 0.1, -0.3, -0.1, -0.4 \rangle$	$\langle 0.6, 0.1, 0.3, -0.2, -0.1, -0.3 \rangle$
$(e_3, q, 0)$	$\langle 0.7, 0.1, 0.3, -0.2, -0.1, -0.3 \rangle$	$\langle 0.7, 0.2, 0.1, -0.2, -0.3, -0.1 \rangle$	$\langle 0.8, 0.3, 0.2, -0.3, -0.1, -0.2 \rangle$

Step3-Now calculate the scores of agree (u_i) by using the data in Table 1 to obtain values in Table 3.

$$S(u_1) = \frac{[0.9 + 1 - 0.3 + 1 - 0.4 + 1 + (-0.4) - (-0.2) - (-0.7)]}{6} = 0.6167$$

Table 3: Agree-bipolar neutrosophic soft expert set.

U	(u_1)	(u_2)	(u_3)
$(e_1, p, 1)$	0.6167	0.4667	0.4833
$(e_2, p, 1)$	0.5167	0.5167	0.4667
$(e_3, p, 1)$	0.5	0.6	0.5
$(e_1, q, 1)$	0.55	0.4333	0.5167
$(e_2, q, 1)$	0.5667	0.5833	0.5167
$(e_3, q, 1)$	0.5167	0.55	0.6333
$C_j = \sum_i (u)_{ij}$	$c_1 = 3.2667$	$c_2 = 3.15$	$c_3 = 3.1166$

Step4-Now calculate the scores of disagree (u_i) by using the data in Table 2 to obtain values in Table 4.

$$S(u_1) = \frac{[0.2 + 1 - 0.3 + 1 - 0.4 + 1 + (-0.4) - (-0.1) - (-0.1)]}{6} = 0.3833$$

Table 4: Disagree-bipolar neutrosophic soft expert set.

U	(u_1)	(u_2)	(u_3)
$(e_1, p, 0)$	0.3833	0.4667	0.4833
$(e_2, p, 0)$	0.5333	0.5333	0.65
$(e_3, p, 0)$	0.55	0.5667	0.4667
$(e_1, q, 0)$	0.5167	0.4667	0.55
$(e_2, q, 0)$	0.5333	0.5833	0.5667
$(e_3, q, 0)$	0.5833	0.6	0.55
$k_j = \sum_i (u)_{ij}$	$k_1 = 3.1$	$k_2 = 3.2167$	$k_3 = 3.2667$

Step5-

Table 5: $u_j = c_j - k_j$

j	U	c_j	k_j	s_j
1	(u_1)	3.2667	3.1	0.1667
2	(u_2)	3.15	3.2167	-0.0667
3	(u_3)	3.1166	3.2667	-0.15

From Tables 3 and 4 we are able to calculate the values of $u_j = c_j - k_j$ as in Table 5.

Step 6- Clearly, the maximum score is the score 0.1667, shown in the above for the u_1 . Hence the best decision for experts are to select u_1 , followed by u_2 .

4. FUTURE RESEARCH DIRECTIONS

In this paper, we have introduced the concept of bipolar neutrosophic soft expert set and its basic operations, namely complement, union and intersection of them has been explained with example which has wider application in the field of modern sciences and technology, especially in research areas of computer science including database theory, data mining, neural networks, expert systems, cluster analysis, control theory, and image capturing. Using this concept, we can extend our work in (1) bipolar interval-valued neutrosophic soft expert set (2) On mapping bipolar neutrosophic soft expert sets.

5. CONCLUSION

In this paper, we have introduced the concept of bipolar neutrosophic soft expert set which is more effective and useful and studied some of its properties. Also the basic operations on neutrosophic soft expert set namely complement, union and intersection have been defined.

ACKNOWLEDGMENT

We thank both editors for their useful suggestions.

REFERENCES

- Atanassov, K. (1986). Intuitionistic fuzzy sets. *Fuzzy Sets and Systems*, 20, 87–96.
- Alkhezaleh, S., A. R. Salleh & N. Hassan, (2011). Fuzzy parameterized interval- valued fuzzy soft set. *Applied Mathematical Sciences*, 5(67), 3335-3346.
- Alkhezaleh S. & A. R. Salleh, (2011). Soft expert sets, *Advances in Decision Sciences*, Article ID 757868, 12 pages. doi:10.1155/2011/75786815-28.
- Bosc, P., & Pivert, O. (2013). On a fuzzy bipolar relational algebra, *Information Sciences*, 219, 1–16.
- Broumi, S., & Smarandache, F. (2015a). Single valued neutrosophic soft expert sets and their application in decision making. *Journal of New Theory*, 3, 67-88.
- Broumi, S., & Smarandache, F. (2015b). Possibility single valued neutrosophic soft expert sets and its application in decision making. *Journal of New Theory*, 4, 06-29.
- Broumi, S., Ali, M., & Smarandache, F. (2015). Mappings on neutrosophic soft expert sets. *Journal of New Theory*, 5, 26-42.
- Broumi, S, Talea, M, Bakali, A., & Smarandache, F. (2016a). Single valued neutrosophic graphs. *Journal of New Theory*, 10, 86-101.
- Broumi, S, Talea, M, Bakali, A., & Smarandache, F. (2016b). On bipolar single valued neutrosophic graphs. *Journal of New Theory*, 11, 84-102.
- Broumi, S, Talea, M, Bakali, A., & Smarandache, F. (2016c). Isolated single valued neutrosophic graphs. *Neutrosophic Sets and Systems*, 11, 74-78.
- Broumi, S, Smarandache, F., Talea, M., & Bakali, A. (2016). An introduction to bipolar single valued neutrosophic graph theory. *Applied Mechanics and Materials*, 841, 184-191.
- Broumi, S, Talea, M., Smarandache, F. & Bakali, A. (2016). Single valued neutrosophic graphs: degree, order and size. *IEEE World Congress on Computational Intelligence*, 2444-2451.
- Chen, J., S. Li, S. Ma, & X. Wang, (2014). m -Polar fuzzy sets: An extension of bipolar fuzzy sets, *The Scientific World Journal*. <http://dx.doi.org/10.1155/2014/416530>.
- Cheng H. D. & Guo, Y. (2008). A new neutrosophic approach to image thresholding, *New Mathematics and Natural Computation*, 4(3) 291–308.
- Deli, I., Ali, M., & Smarandache, F. (2015). Bipolar neutrosophic sets and their application based on multi-criteria decision making problems. In *Advanced Mechatronic Systems (ICAMechS), 2015 International Conference on* (pp. 249-254). IEEE.
- Guo Y. & Cheng, H. D. (2009). New neutrosophic approach to image segmentation. *Pattern Recognition*, 42, 587–595.
- Guo, Y., & Sengur, A. (2015). A novel 3D skeleton algorithm based on neutrosophic cost function, *Applied Soft Computing*, 36, 210-217.
- Karaaslan, F. (2016). Possibility neutrosophic soft sets and PNS-decision making method. *Applied Soft Computing*. doi:10.1016/j.asoc.2016.07.013.
- Kang, M. K., & Kang, J. G. (2012). Bipolar fuzzy set theory applied to sub-semigroups with operators in semigroups. *The Pure and Applied Mathematics*, 19(1), 23-35.
- Kharal, A. (2014). A neutrosophic multi-criteria decision making method. *New Mathematics and Natural*

- Computation*, 10(02), 143-162.
- Lee, K. M., (2000). Bipolar-valued fuzzy sets and their operations. Proc. Int. Conf. on Intelligent Technologies, Bangkok, Thailand, 307-312.
- Lee, K. J. (2009). Bipolar fuzzy subalgebras and bipolar fuzzy ideals of BCK/BCI-algebras. *Bulletin of the Malaysian Mathematical Sciences Society*, 32/3, 361-373.
- Liu P. & Wang, Y. (2014). Multiple attribute decision-making method based on single-valued neutrosophic normalized weighted Bonferroni mean. *Neural Computing and Applications*, 25 7/8, 2001-2010.
- Liu P., & Shi, L. (2015). The generalized hybrid weighted average operator based on interval neutrosophic hesitant set and its application to multiple attribute decision making, *Neural Computing and Applications*, 26 /2, 457-471.
- Maji, P. K., Roy, A. R. & Biswas, R. (2003) Soft set theory. *Computers and Mathematics with Applications*, 45(4-5): 555 – 562.
- Maji, P.K., (2013). Neutrosophic soft set. *Computers and Mathematics with Applications*, 45, 555-562
- Majumdar P. & Samanta, S. K. (2014). On similarity and entropy of neutrosophic sets. *Journal of Intelligent & Fuzzy Systems*, 26/3,1245–1252.
- Majumder, S.K. (2012). Bipolar valued fuzzy sets in Γ -semigroups, *Mathematica Aeterna*, 2/3, 203 – 213.
- Manemaran, S. V., & Chellappa, B. (2010). Structures on bipolar fuzzy groups and bipolar fuzzy D-ideals under (T, S) norms. *International Journal of Computer Applications*, 9(12), 7-10.
- Molodtsov, D.A. (1999). Soft set theory-first results. *Computers and Mathematics with Applications*, 37 19-31.
- Peng, J. J., Wang, J. Q., Wang, J., Zhang, H. Y., & Chen, X. H. (2016). Simplified neutrosophic sets and their applications in multi-criteria group decision-making problems. *International Journal of Systems Science*, 47(10), 2342-2358. doi:10.1080/00207721.2014.994050.
- Şahin, M., Alkhezaleh, S., & Uluçay, V. (2015). Neutrosophic soft expert sets. *Applied Mathematics*, 6(01), 116.
- Sahin R. and A. Kucuk, (2014). Subsethood measure for single valued neutrosophic sets, *Journal of Intelligent and Fuzzy Systems*, DOI: 10.3233/IFS-141304.
- Smarandache, F. (1999). A unifying field in logics. Neutrosophy: Neutrosophic probability, set and logic. Rehoboth: American Research Press.
- Abdel-Basset, M., Mohamed, M., Smarandache, F., & Chang, V. (2018). Neutrosophic Association Rule Mining Algorithm for Big Data Analysis. *Symmetry*, 10(4), 106.
- Abdel-Basset, M., & Mohamed, M. (2018). The Role of Single Valued Neutrosophic Sets and Rough Sets in Smart City: Imperfect and Incomplete Information Systems. Measurement. Volume 124, August 2018, Pages 47-55
- Abdel-Basset, M., Gunasekaran, M., Mohamed, M., & Smarandache, F. A novel method for solving the fully neutrosophic linear programming problems. *Neural Computing and Applications*, 1-11.
- Abdel-Basset, M., Manogaran, G., Gamal, A., & Smarandache, F. (2018). A hybrid approach of neutrosophic sets and DEMATEL method for developing supplier selection criteria. *Design Automation for Embedded Systems*, 1-22.
- Abdel-Basset, M., Mohamed, M., & Chang, V. (2018). NMCDA: A framework for evaluating cloud computing services. *Future Generation Computer Systems*, 86, 12-29.
- Abdel-Basset, M., Mohamed, M., Zhou, Y., & Hezam, I. (2017). Multi-criteria group decision making based on neutrosophic analytic hierarchy process. *Journal of Intelligent & Fuzzy Systems*, 33(6), 4055-4066.
- Abdel-Basset, M.; Mohamed, M.; Smarandache, F. An Extension of Neutrosophic AHP–SWOT Analysis for Strategic Planning and Decision-Making. *Symmetry* 2018, 10, 116.

On Neutrosophic α -Supra Open Sets and Neutrosophic α -Supra Continuous Functions

*¹ R. Dhavaseelan, ² M. Ganster, ³S. Jafari and ⁴M. Parimala

^{1*}Department of Mathematics, Sona College of Technology,
Salem-636005, Tamil Nadu, India.

²Department of Mathematics, Graz University of Technology,
Steyrergasse 30, 8010 Graz, Austria.

³Department of Mathematics, College of Vestsjaelland South,
Herrestraede 11, 4200 Slagelse, Denmark

⁴Department of Mathematics, Bannari Amman Institute of Technology
Sathyamangalam-638401, Tamil Nadu, India.

ABSTRACT

In this paper, we introduce and investigate a new class of sets and functions between supra topological spaces called neutrosophic α -supra open set and neutrosophic α -supra continuous function.

KEYWORDS AND PHRASES: Neutrosophic Supra topological spaces, Neutrosophic α -supra open set, Neutrosophic semi-supraopen set, Neutrosophic α -supraopen set, Neutrosophic pre-supraopen set.

1 INTRODUCTION AND PRELIMINARIES

Zadeh (1965) introduced the concept of a fuzzy set and since its advent invaded almost all branches of mathematics and proved to have applications in many fields such as information theory (Smets (1981)) and control theory (Sugeno (1985)). The theory of fuzzy topological space was introduced and developed by Chang (1968) and since then various notions in classical topology have been extended to fuzzy topological spaces. The idea of “intuitionistic fuzzy set” was first published by Atanassov (1983) and many works by the same author

*e-mail : dhavaseelan.r@gmail.com, ganster@weyl.math.tu-graz.ac.at, jafaripersia@gmail.com, rishwanthpari@gmail.com

and his colleagues appeared in the literature (Atanassov (1986, 1988); Atanassov and Stoeva (1983)). Later, this concept was generalized to “intuitionistic L - fuzzy sets” by Atanassov and Stoeva (1984). Utilizing the notion of intuitionistic fuzzy sets, Coker (1997) introduced the notion of intuitionistic fuzzy topological spaces. In 1983, Mashhour et al. introduced the supra topological spaces and studied s -continuous functions and s^* -continuous functions. In 1987, Abd El-Monsef et al. introduced the fuzzy supra topological spaces and studied fuzzy supra-continuous functions and obtained some properties and characterizations. In 1996, Keun Min introduced fuzzy s -continuous, fuzzy s -open and fuzzy s -closed maps and established a number of characterizations. In 2008, Devi et al. introduced the concept of supra α -open set, $s\alpha$ -continuous functions and studied some of the basic properties for this class of functions. In 1999 and 2003, Turanl introduced the concept of intuitionistic fuzzy supra topological space. The concepts of neutrosophy and neutrosophic set are introduced by Smarandache (1999, 2000). Afterwards Salama and Alblowi (2012), introduced the concepts of neutrosophic crisp set and neutrosophic crisp topological spaces.

In this paper, we introduce and investigate a new class of sets and functions between supra topological spaces called neutrosophic α -supra open set and neutrosophic α -supra continuous functions.

Definition 1.1. (Salama and Alblowi (2012)) Let X be a nonempty fixed set. A neutrosophic set [NS for short] A is an object having the form $A = \{\langle x, \mu_A(x), \sigma_A(x), \gamma_A(x) \rangle : x \in X\}$ where $\mu_A(x)$, $\sigma_A(x)$ and $\gamma_A(x)$ which represents the degree of membership function (namely $\mu_A(x)$), the degree of indeterminacy (namely $\sigma_A(x)$) and the degree of nonmembership (namely $\gamma_A(x)$) respectively of each element $x \in X$ to the set A .

Remark 1.1. (Salama and Alblowi (2012))

- (1) A neutrosophic set $A = \{\langle x, \mu_A(x), \sigma_A(x), \gamma_A(x) \rangle : x \in X\}$ can be identified to an ordered triple $\langle \mu_A, \sigma_A, \gamma_A \rangle$ in $]0^-, 1^+[$ on X .
- (2) For the sake of simplicity, we shall use the symbol $A = \langle \mu_A, \sigma_A, \gamma_A \rangle$ for the neutrosophic set $A = \{\langle x, \mu_A(x), \sigma_A(x), \gamma_A(x) \rangle : x \in X\}$.

Definition 1.2. (Salama and Alblowi (2012)) Let X be a nonempty set and the neutrosophic sets A and B in the form

$A = \{\langle x, \mu_A(x), \sigma_A(x), \gamma_A(x) \rangle : x \in X\}$, $B = \{\langle x, \mu_B(x), \sigma_B(x), \gamma_B(x) \rangle : x \in X\}$. Then

- (a) $A \subseteq B$ iff $\mu_A(x) \leq \mu_B(x)$, $\sigma_A(x) \leq \sigma_B(x)$ and $\gamma_A(x) \geq \gamma_B(x)$ for all $x \in X$;
- (b) $A = B$ iff $A \subseteq B$ and $B \subseteq A$;
- (c) $\bar{A} = \{\langle x, \gamma_A(x), \sigma_A(x), \mu_A(x) \rangle : x \in X\}$; [complement of A]
- (d) $A \cap B = \{\langle x, \mu_A(x) \wedge \mu_B(x), \sigma_A(x) \wedge \sigma_B(x), \gamma_A(x) \vee \gamma_B(x) \rangle : x \in X\}$;

$$(e) A \cup B = \{ \langle x, \mu_A(x) \vee \mu_B(x), \sigma_A(x) \vee \sigma_B(x), \gamma_A(x) \wedge \gamma_B(x) \rangle : x \in X \};$$

$$(f) []A = \{ \langle x, \mu_A(x), \sigma_A(x), 1 - \mu_A(x) \rangle : x \in X \};$$

$$(g) \langle \rangle A = \{ \langle x, 1 - \gamma_A(x), \sigma_A(x), \gamma_A(x) \rangle : x \in X \}.$$

Definition 1.3. (Salama and Alblowi (2012)) Let $\{A_i : i \in J\}$ be an arbitrary family of neutrosophic sets in X . Then

$$(a) \bigcap A_i = \{ \langle x, \wedge \mu_{A_i}(x), \wedge \sigma_{A_i}(x), \vee \gamma_{A_i}(x) \rangle : x \in X \};$$

$$(b) \bigcup A_i = \{ \langle x, \vee \mu_{A_i}(x), \vee \sigma_{A_i}(x), \wedge \gamma_{A_i}(x) \rangle : x \in X \}.$$

Since our main purpose is to construct the tools for developing neutrosophic topological spaces, we must introduce the neutrosophic sets 0_N and 1_N in X as follows:

Definition 1.4. (Salama and Alblowi (2012)) $0_N = \{ \langle x, 0, 0, 1 \rangle : x \in X \}$ and $1_N = \{ \langle x, 1, 1, 0 \rangle : x \in X \}$.

Definition 1.5. [10] A neutrosophic topology (NT) on a nonempty set X is a family T of neutrosophic sets in X satisfying the following axioms:

- (i) $0_N, 1_N \in T$,
- (ii) $G_1 \cap G_2 \in T$ for any $G_1, G_2 \in T$,
- (iii) $\cup G_i \in T$ for arbitrary family $\{G_i \mid i \in \Lambda\} \subseteq T$.

In this case the ordered pair (X, T) or simply X is called a neutrosophic topological space (briefly NTS) and each neutrosophic set in T is called a neutrosophic open set (briefly NOS). The complement \bar{A} of a NOS A in X is called a neutrosophic closed set (briefly NCS) in X . Each neutrosophic supra set (briefly, NS) which belongs to (X, T) is called a neutrosophic supra open set (briefly, NSOS) in X . The complement \bar{A} of a NSOS A in X is called a neutrosophic supra closed set (briefly IFSCS) in X .

Definition 1.6. (Dhavaseelan, & Jafari (submitted)) Let A be a neutrosophic set in a neutrosophic topological space X . Then

$Nint(A) = \bigcup \{G \mid G \text{ is a neutrosophic open set in } X \text{ and } G \subseteq A\}$ is called the neutrosophic interior of A ;

$Ncl(A) = \bigcap \{G \mid G \text{ is a neutrosophic closed set in } X \text{ and } G \supseteq A\}$ is called the neutrosophic closure of A .

Definition 1.7. (Dhavaseelan, & Jafari (submitted)) Let X be a nonempty set. If r, t, s be real standard or non standard subsets of $]0^-, 1^+[$ then the neutrosophic set $x_{r,t,s}$ is called a neutrosophic point (briefly NP) in X given by

$$x_{r,t,s}(x_p) = \begin{cases} (r, t, s), & \text{if } x = x_p \\ (0, 0, 1), & \text{if } x \neq x_p \end{cases}$$

for $x_p \in X$ is called the support of $x_{r,t,s}$, where r denotes the degree of membership value, t denotes the degree of indeterminacy and s is the degree of non-membership value of $x_{r,t,s}$.

2 NEUTROSOPHIC α -SUPRA OPEN SETS

Definition 2.1. A family T of neutrosophic sets on X is called a neutrosophic supratopology (briefly NST) on X if $0_N \in T$, $1_N \in T$ and T is closed under arbitrary suprema. Then we call the pair (X, T) a neutrosophic supratopological space (briefly NSTS).

Each member of T is called a neutrosophic supraopen set and the complement of a neutrosophic supraopen set is called a neutrosophic supraclosed set. The neutrosophic supra-closure of a neutrosophic set A is denoted by $s-Ncl(A)$. Here $s-Ncl(A)$ is the intersection of all neutrosophic supraclosed sets containing A . The neutrosophic suprainterior of A will be denoted by $s-Nint(A)$. Here, $s-Nint(A)$ is the union of all neutrosophic supraopen sets contained in A .

Definition 2.2. Let A be a neutrosophic set in a neutrosophic supratopological space X is called

- (a) neutrosophic semi-supraopen set iff $A \subseteq s - Ncl(s - Nint(A))$,
- (b) neutrosophic α -supraopen set iff $A \subseteq s - Nint(s - Ncl(s - Nint(A)))$,
- (c) neutrosophic pre-supraopen set iff $A \subseteq s - Nint(s - Ncl(A))$.

Definition 2.3. Let f be a function from an ordinary set X into an ordinary set Y . If $B = \{\langle y, \mu_B(y), \sigma_B(y), \gamma_B(y) \rangle : y \in Y\}$ is a neutrosophic supratopology in Y , then the inverse image of B under f is a neutrosophic supratopology defined by $f^{-1}(B) = \{\langle x, f^{-1}(\mu_B)(x), f^{-1}(\sigma_B)(x), f^{-1}(\gamma_B)(x) \rangle : x \in X\}$.

The image of neutrosophic supratopology $A = \{\langle y, \mu_A(y), \sigma_A(y), \gamma_A(y) \rangle : y \in Y\}$ under f is a neutrosophic supratopology defined by $f(A) = \{\langle y, f(\mu_A)(y), f(\sigma_A)(y), f(\gamma_A)(y) \rangle : y \in Y\}$.

Definition 2.4. Let (X, T) be a neutrosophic supra topological space. a neutrosophic set A is called a neutrosophic α -supra open set (briefly, $N\alpha$ SOS) if $A \subseteq s - Nint(s - Ncl(s - Nint(A)))$. The complement of a neutrosophic α -supra open set is called a neutrosophic α -supra closed set.

Theorem 2.1. Every neutrosophic supra open set is neutrosophic α -supra open.

Proof. Let A be a neutrosophic supra open set in (X, T) . Since $A \subseteq s - Ncl(A)$, we get $A \subseteq s - Ncl(s - Nint(A))$. Then $s - Nint(A) \subseteq s - Nint(s - Ncl(s - Nint(A)))$. Hence $A \subseteq s - Nint(s - Ncl(s - Nint(A)))$. \square

The converse of the above theorem need not be true as shown by the following example.

Example 2.1. Let $X = \{a, b\}$. Define the neutrosophic sets A and B in X as follows:

$$A = \langle x, (\frac{a}{0.3}, \frac{b}{0.4}), (\frac{a}{0.3}, \frac{b}{0.4}), (\frac{a}{0.4}, \frac{b}{0.5}) \rangle, B = \langle x, (\frac{a}{0.4}, \frac{b}{0.2}), (\frac{a}{0.4}, \frac{b}{0.2}), (\frac{a}{0.5}, \frac{b}{0.3}) \rangle.$$

We have $T = \{0_N, 1_N, A, B, A \cup B\}$. Let $C = \langle x, (\frac{a}{0.4}, \frac{b}{0.6}), (\frac{a}{0.4}, \frac{b}{0.6}), (\frac{a}{0.3}, \frac{b}{0.4}) \rangle$. Then C is neutrosophic α -supra open but not neutrosophic supra open.

Theorem 2.2. Every neutrosophic α -supra open set is neutrosophic semi-supra open.

Proof. Let A be a neutrosophic α -supra open set in (X, T) . Then, $A \subseteq s\text{-Nint}(s\text{-Ncl}(s\text{-Nint}(A)))$. It is obvious that $s\text{-Nint}(s\text{-Ncl}(s\text{-Nint}(A))) \subseteq s\text{-Ncl}(s\text{-Nint}(A))$. Hence $A \subseteq s\text{-Ncl}(s\text{-Nint}(A))$. \square

The converse of the above theorem need not be true as shown by the following example.

Example 2.2. Let $X = \{a, b\}$. Define the neutrosophic sets A and B in X as follows:

$$A = \langle x, (\frac{a}{0.3}, \frac{b}{0.5}), (\frac{a}{0.3}, \frac{b}{0.5}), (\frac{a}{0.4}, \frac{b}{0.5}) \rangle, B = \langle x, (\frac{a}{0.4}, \frac{b}{0.3}), (\frac{a}{0.4}, \frac{b}{0.3}), (\frac{a}{0.5}, \frac{b}{0.4}) \rangle.$$

We have $T = \{0_N, 1_N, A, B, A \cup B\}$. Let $C = \langle x, (\frac{a}{0.4}, \frac{b}{0.4}), (\frac{a}{0.4}, \frac{b}{0.4}), (\frac{a}{0.5}, \frac{b}{0.4}) \rangle$. Then C is neutrosophic semi-supra open but not neutrosophic α -supra open.

Theorem 2.3. Every neutrosophic α -supra open set is neutrosophic pre-supra open.

Proof. Let A be a neutrosophic α -supra open set in (X, T) . Then, $A \subseteq s\text{-Nint}(s\text{-Ncl}(s\text{-Nint}(A)))$. It is obvious that $A \subseteq s\text{-Nint}(s\text{-Ncl}(A))$. \square

The converse of the above theorem need not be true as shown by the following example.

Example 2.3. In Example 2.2, let $C = \langle x, (\frac{a}{0.4}, \frac{b}{0.5}), (\frac{a}{0.4}, \frac{b}{0.5}), (\frac{a}{0.5}, \frac{b}{0.4}) \rangle$. Here C is neutrosophic pre-supra open but not neutrosophic α -supra open.

Theorem 2.4. (i) Arbitrary union of neutrosophic α -supra open sets is always neutrosophic α -supra open set.

(ii) Finite intersection of neutrosophic α -supra open sets may fail to be neutrosophic α -supra open set.

Proof. (i) Let $\{A_\lambda : \lambda \in \Lambda\}$ be a family of neutrosophic α -supra open set in a topological space X . Then for any $\lambda \in \Lambda$, we have $A_\lambda \subseteq s\text{-Nint}(s\text{-Ncl}(s\text{-Nint}(A_\lambda)))$. Hence $\cup_{\lambda \in \Lambda} A_\lambda \subseteq \cup_{\lambda \in \Lambda} (s\text{-Nint}(s\text{-Ncl}(s\text{-Nint}(A_\lambda)))) \subseteq s\text{-Nint}(\cup_{\lambda \in \Lambda} (s\text{-Ncl}(s\text{-Nint}(A_\lambda)))) \subseteq s\text{-Nint}(s\text{-Ncl}(s\text{-Nint}(\cup_{\lambda \in \Lambda} A_\lambda)))$. Therefore, $\cup_{\lambda \in \Lambda} A_\lambda$ is a neutrosophic α -supra open set.

(ii) Let $X = \{a, b\}$. Define the neutrosophic sets A and B in X as follows:

$$A = \langle x, (\frac{a}{0.3}, \frac{b}{0.4}), (\frac{a}{0.3}, \frac{b}{0.4}), (\frac{a}{0.4}, \frac{b}{0.5}) \rangle, B = \langle x, (\frac{a}{0.2}, \frac{b}{0.4}), (\frac{a}{0.2}, \frac{b}{0.4}), (\frac{a}{0.5}, \frac{b}{0.3}) \rangle \text{ and } T = \{0_N, 1_N, A, B, A \cup B\}. \text{ Let } C = \langle x, (\frac{a}{0.4}, \frac{b}{0.6}), (\frac{a}{0.4}, \frac{b}{0.6}), (\frac{a}{0.3}, \frac{b}{0.4}) \rangle. \text{ Here } B \text{ and } C \text{ are neutrosophic } \alpha\text{-supra open but } B \cap C \text{ is not neutrosophic } \alpha\text{-supra open.}$$

□

Theorem 2.5. (i) Arbitrary intersection of neutrosophic α -supra closed sets is always neutrosophic α -supra closed set.

(ii) Finite union of neutrosophic α -supra closed sets may fail to be neutrosophic α -supra closed set.

Proof. (i) The proof follows immediately from Theorem 2.4

(ii) Let $X = \{a, b\}$. Define the neutrosophic sets A and B in X as follows:

$$A = \langle x, (\frac{a}{0.3}, \frac{b}{0.5}), (\frac{a}{0.3}, \frac{b}{0.5}), (\frac{a}{0.6}, \frac{b}{0.5}) \rangle, B = \langle x, (\frac{a}{0.6}, \frac{b}{0.3}), (\frac{a}{0.6}, \frac{b}{0.3}), (\frac{a}{0.3}, \frac{b}{0.4}) \rangle \text{ and } T = \{0_N, 1_N, A, B, A \cup B\}. \text{ Let } C = \langle x, (\frac{a}{0.3}, \frac{b}{0.5}), (\frac{a}{0.3}, \frac{b}{0.5}), (\frac{a}{0.4}, \frac{b}{0.5}) \rangle \text{ and } D = \langle x, (\frac{a}{0.3}, \frac{b}{0.4}), (\frac{a}{0.3}, \frac{b}{0.4}), (\frac{a}{0.6}, \frac{b}{0.2}) \rangle. \text{ Here } C \text{ and } D \text{ are neutrosophic } \alpha\text{-supra closed but } C \cup D \text{ is not neutrosophic } \alpha\text{-supra closed.}$$

□

Definition 2.5. The neutrosophic α -supra-closure of a set A is denoted by $\alpha s\text{-}Ncl(A) = \cup\{G : G \text{ is a } N\alpha\text{SOS in } X \text{ and } G \subseteq A\}$.

The neutrosophic α -supra-interior of a set A is denoted by $\alpha s\text{-}Nint(A) = \cap\{G : G \text{ is a } N\alpha\text{SCS in } X \text{ and } G \supseteq A\}$.

Remark 2.1. It is clear that $\alpha s\text{-}Nint(A)$ is a neutrosophic α -supra open set and $\alpha s\text{-}Ncl(A)$ is a neutrosophic α -supra closed set.

Theorem 2.6. Let X be a neutrosophic supratopological spaces. If A and B are two subsets of X , then

$$(i) \overline{\alpha s - Nint(A)} = \alpha s\text{-}Ncl(\overline{A})$$

$$(ii) \overline{\alpha s - Ncl(A)} = \alpha s\text{-}Nint(\overline{A})$$

$$(iii) \text{ If } A \subseteq B, \text{ then } \alpha s\text{-}Ncl(A) \subseteq \alpha s\text{-}Ncl(B) \text{ and } \alpha s\text{-}Nint(A) \subseteq \alpha s\text{-}Nint(B)$$

Proof. It is obvious. □

Theorem 2.7. Let X be a neutrosophic supratopological spaces. If A and B are two neutrosophic subsets of X , then

$$(i) \alpha s\text{-}Nint(A) \cup \alpha s\text{-}Nint(B) \subseteq \alpha s\text{-}Nint(A \cup B)$$

$$(ii) \alpha s\text{-}Nint(A \cap B) \subseteq \alpha s\text{-}Nint(A) \cap \alpha s\text{-}Nint(B)$$

(iii) If $A \subseteq B$, then $\alpha s\text{-}Ncl(A) \subseteq \alpha s\text{-}Ncl(B)$ and $\alpha s\text{-}Nint(A) \subseteq \alpha s\text{-}Nint(B)$

Proof. It is obvious. □

Theorem 2.8. (i) The intersection of a neutrosophic α -supra open set and a neutrosophic α -supra open set is neutrosophic α -supra open.

(ii) The intersection of a neutrosophic α -supra open set and a neutrosophic pre-supra open set is neutrosophic pre-supra open.

Proof. It is obvious. □

3 NEUTROSOPHIC α -SUPRA CONTINUOUS FUNCTIONS

Definition 3.1. Let (X, T) and (Y, S) be two neutrosophic α -supra topological spaces. A map $f : (X, T) \rightarrow (Y, S)$ is called neutrosophic α -supra continuous function if the inverse image of each neutrosophic open set in Y is a neutrosophic α -supra open set in X .

Theorem 3.1. Every neutrosophic supra continuous function is neutrosophic α -supra continuous function.

Proof. Let $f : (X, T) \rightarrow (Y, S)$ be a neutrosophic supra continuous function and A is a neutrosophic open set in Y . Then $f^{-1}(A)$ is a neutrosophic open set in X . Therefore, $f^{-1}(A)$ is a neutrosophic supra open set in X which is a neutrosophic α supra open set in X . Hence f is a neutrosophic α -supra continuous function. □

Remark 3.1. Every neutrosophic α -supra continuous function need not be neutrosophic supra continuous function.

Theorem 3.2. Let (X, T) and (Y, S) be two neutrosophic supra topological spaces. Let f be a map from X into Y . Then the following are equivalent:

- (i) f is a neutrosophic supra α -continuous function.
- (ii) the inverse image of a closed sets in Y is a neutrosophic supra α -closed set in X .
- (iii) $\alpha s\text{-}Ncl(f^{-1}(A)) \subseteq f^{-1}(Ncl(A))$ for every neutrosophic set A in Y .
- (iv) $f(\alpha s\text{-}Ncl(A)) \subseteq Ncl(f(A))$ for every neutrosophic set A in X .
- (v) $f^{-1}(Nint(B)) \subseteq \alpha s\text{-}Nint(f^{-1}(B))$ for every neutrosophic set B in Y .

Proof. (i) \Rightarrow (ii) : Let A be a neutrosophic closed set in Y , then \overline{A} is neutrosophic open in Y . Thus, $f^{-1}(\overline{A}) = \overline{f^{-1}(A)}$ is neutrosophic αs -open in X . It follows that $f^{-1}(A)$ is a neutrosophic αs -closed set of X .

(ii) \Rightarrow (iii): Let A be any subset of X . Since $Ncl(A)$ is closed in Y , then it follows that

$f^{-1}(Ncl(A))$ is neutrosophic αs -closed in X .

Therefore, $f^{-1}(Ncl(A)) = \alpha s\text{-}Ncl(f^{-1}(Ncl(A))) \supseteq \alpha s\text{-}Ncl(f^{-1}(A))$.

(iii) \Rightarrow (iv) : Let A be any neutrosophic subset of X . By (iii) we obtain, $f^{-1}(Ncl(f(A))) \supseteq \alpha s\text{-}Ncl(f^{-1}(f(A))) \supseteq \alpha s\text{-}Ncl(A)$ and hence $f(\alpha s\text{-}Ncl(A)) \subseteq Ncl(f(A))$.

(iv) \Rightarrow (v) : Let $f(\alpha s\text{-}Ncl(A)) \subseteq Ncl(f(A))$ for every neutrosophic set A in X .

Then $\alpha s\text{-}Ncl(A) \subseteq f^{-1}(Ncl(f(A)))$, $X - \alpha s\text{-}Ncl(A) \supseteq \overline{f^{-1}(Ncl(f(A)))}$ and $\alpha s\text{-}Nint(\overline{A}) \supseteq f^{-1}(Nint(\overline{f(A)}))$. Then $\alpha s\text{-}Nint(f^{-1}(B)) \supseteq f^{-1}(Nint(B))$. Therefore $f^{-1}(Nint(B)) \subseteq s\text{-}Nint(f^{-1}(B))$, for every B in Y .

(v) \Rightarrow (i) : Let A be a neutrosophic open set in Y . Therefore, $f^{-1}(Nint(A)) \subseteq \alpha s\text{-}Nint(f^{-1}(A))$, hence $f^{-1}(A) \subseteq \alpha s\text{-}Nint(f^{-1}(A))$. But by other hand, we know that, $\alpha s\text{-}Nint(f^{-1}(A)) \subseteq f^{-1}(A)$. Then $f^{-1}(A) = \alpha s\text{-}Nint(f^{-1}(A))$. Therefore, $f^{-1}(A)$ is a neutrosophic αs -open set. □

Theorem 3.3. If a function $f : (X, T) \rightarrow (Y, S)$ is neutrosophic αs -continuous and $g : (Y, S) \rightarrow (Z, R)$ is continuous, then $(g \circ f)$ is αs -continuous.

Proof. Obvious. □

Theorem 3.4. Let $f : (X, T) \rightarrow (Y, S)$ be a neutrosophic αs -continuous function, if one of the following holds:

(i) $f^{-1}(\alpha s\text{-}Nint(A)) \subseteq Nint(f^{-1}(A))$ for every neutrosophic set A in Y .

(ii) $Ncl(f^{-1}(A)) \subseteq f^{-1}(\alpha s\text{-}Ncl(A))$ for every neutrosophic set A in Y .

(iii) $f(Ncl(B)) \subseteq \alpha s\text{-}Ncl(f(B))$ for every neutrosophic set B in X .

Proof. Let A be any open set of Y . If condition (i) is satisfied, then $f^{-1}(\alpha s\text{-}Nint(A)) \subseteq Nint(f^{-1}(A))$. We have $f^{-1}(A) \subseteq Nint(f^{-1}(A))$. Therefore $f^{-1}(A)$ is a neutrosophic supra open set. Every neutrosophic supra open set is neutrosophic supra α -open set. Hence f is a neutrosophic αs -continuous function. If condition (ii) is satisfied, then we can easily prove that f is a neutrosophic αs -continuous function. If condition (iii) is satisfied, and A is any open set of Y . Then $f^{-1}(A)$ is a set in X and $f(Ncl(f^{-1}(A))) \subseteq \alpha s\text{-}Ncl(f(f^{-1}(A)))$. This implies $f(Ncl(f^{-1}(A))) \subseteq \alpha s\text{-}Ncl(A)$. This is nothing but condition (ii). Hence f is a neutrosophic αs -continuous function. □

REFERENCES

- M. E. Abd El-Monsef, M. E., & Ramadan, A. E. (1987). *On fuzzy supra topological spaces, Indian Journal of Pure and Applied Mathematics*, 18(4), 322-329.

- Atanassov, K. (1983, June) Intuitionistic fuzzy sets, in: V. Sgurev, Ed., *VII ITKR's Session, Sofia (Central Sci. and Techn. Library, Bulg. Academy of Sciences, 1984)*.
- Atanassov, K. (1986). Intuitionistic fuzzy sets. *Fuzzy Sets and Systems* , 20, 87-96.
- Atanassov, K. (1988) Review and new results on Intuitionistic fuzzy sets, *Preprint IM-MFAIS-1-88, Sofia*, 1988.
- Atanassov, K., and Stoeva, S.(1983, August). Intuitionistic fuzzy sets, in: *Polish Syrup. on Interval & Fuzzy Mathematics, Poznan*, 23-26.
- Atanassov, K., and Stoeva, S.(1984) Intuitionistic L-fuzzy sets, in: R. Trappl, Ed., *Cybernetics and System Research, Vol. 2* (Elsevier, Amsterdam) 539-540.
- D. Coker, D. (1997). An introduction to intuitionistic fuzzy topological spaces. *Fuzzy sets and systems*, 88, 81-89.
- Chang, C. L. (1968) Fuzzy topological spaces. *Journal of mathematical Analysis and Applications*, 24, 182-190.
- Devi, R., Sampathkumar S., & Caldas, M. (2008). On supra α -open sets and $S\alpha$ -continuous functions. *General Mathematics*, 16(2), 7784.
- Dhavaseelan, R., and S. Jafari, S. Generalized Neutrosophic closed sets. Submitted.
- Mashhour, A. S., Allam, A. A., Mahmoud, F. S., & Khedr, F. H. (1983). On supra topological spaces. *Indian Journal of Pure and Applied Mathematics*, 14(4), 502-510.
- Salama, A. A. and Alblowi, S. A. (2012). Neutrosophic Set and Neutrosophic Topological Spaces. *IOSR Journal of Mathematics*, 3(4), 31-35.
- Smarandache, F. (2002). Neutrosophy and Neutrosophic Logic , First International Conference on Neutrosophy , Neutrosophic Logic, Set, Probability, and Statistics University of New Mexico, Gallup, NM 87301, USA.
- Smarandache F (1999) *A unifying field in logics. Neutrosophy: Neutrosophic probability, set and logic*. American Research Press, Rehoboth.
- Smets, P. (1981). The degree of belief in a fuzzy event, *Information Sciences* , 25, 1-19.
- Sugeno, M. (1985) An Introductory survey of fuzzy control. *Information Sciences*, 36, 59-83.
- Turanl, N. (1999). n Intuitionistic Fuzzy Supratopological Spaces. *International Conference on Modeling and Simulation, Spain*, 2, 69-77.
- N. Turanl, N. (2003). An over view of intuitionistic fuzzy supra topological spaces. *Hacettepe Journal of Mathematics and Statistics*, 32, 17-26.
- Won Keun Min, W. K. (1996). On fuzzy s-continuous functions. *Kangweon-Kyungki Math. J.*, 4(1), 77-82.
- Zadeh, L. A. (1965). Fuzzy sets. *Information and Control*, 8, 338-353.

- Abdel-Basset, M., Mohamed, M., Smarandache, F., & Chang, V. (2018). Neutrosophic Association Rule Mining Algorithm for Big Data Analysis. *Symmetry*, 10(4), 106.
- Abdel-Basset, M., & Mohamed, M. (2018). The Role of Single Valued Neutrosophic Sets and Rough Sets in Smart City: Imperfect and Incomplete Information Systems. *Measurement*. Volume 124, August 2018, Pages 47-55
- Abdel-Basset, M., Gunasekaran, M., Mohamed, M., & Smarandache, F. A novel method for solving the fully neutrosophic linear programming problems. *Neural Computing and Applications*, 1-11.
- Abdel-Basset, M., Manogaran, G., Gamal, A., & Smarandache, F. (2018). A hybrid approach of neutrosophic sets and DEMATEL method for developing supplier selection criteria. *Design Automation for Embedded Systems*, 1-22.
- Abdel-Basset, M., Mohamed, M., & Chang, V. (2018). NMCDA: A framework for evaluating cloud computing services. *Future Generation Computer Systems*, 86, 12-29.
- Abdel-Basset, M., Mohamed, M., Zhou, Y., & Hezam, I. (2017). Multi-criteria group decision making based on neutrosophic analytic hierarchy process. *Journal of Intelligent & Fuzzy Systems*, 33(6), 4055-4066.
- Abdel-Basset, M.; Mohamed, M.; Smarandache, F. An Extension of Neutrosophic AHP–SWOT Analysis for Strategic Planning and Decision-Making. *Symmetry* 2018, 10, 116.

Neutrosophic Contra-continuous Multi-functions

^{1*} S. Jafari and ² N. Rajesh

¹Department of Mathematics, College of Vestsjaelland South,
Herrestraede 11, 4200 Slagelse, Denmark.

e-mail : dhavaseelan.r@gmail.com, jafaripersia@gmail.com

^{2*}Department of Mathematics, Sona College of Technology,
Salem-636005, Tamil Nadu, India.

ABSTRACT

This paper is devoted to the concepts of neutrosophic upper and neutrosophic lower contra-continuous multifunctions and also some of their characterizations are considered..

1 INTRODUCTION

In the last three decades, the theory of multifunctions has advanced in a variety of ways and applications of this theory can be found, specially in functional analysis and fixed point theory. In recent years, several authors have studied some new forms of contra-continuity for functions and multifunctions. In the present paper, we study the notions of neutrosophic upper and neutrosophic lower contra-continuous multifunctions. Also, some characterizations and properties of such notions are discussed. Since initiation of the theory of neutrosophic sets by Smarandache (1999), this theory has found wide applications in economics, engineering, medicine, information sciences, programming, optimization, graphs etc. Also, neutrosophic multifunctions arise in many applications, for example, the budget multifunctions occurs in decision theory, noncooperative games, artificial intelligence, economic theory, medicine, information sciences, fixed point theory. In this paper, we present the concepts of neutrosophic upper and neutrosophic lower contra-continuous multifunctions and also some characterizations of them are given.

2 Preliminaries

Definition 2.1. (Smarandache (1999)) *Let X be a non-empty fixed set. A neutrosophic set A is an object having the form $A = \langle x, \mu_A(x), \sigma_A(x), \gamma_A(x) \rangle$, where $\mu_A(x)$, $\sigma_A(x)$ and*

$\gamma_A(x)$ which represent the degree of member ship function, the degree of indeterminacy, and the degree of non-membership, respectively of each element $x \in X$ to the set A .

Definition 2.2. (Salama and Alblowi (2012)) A neutrosophic topology on a nonempty set X is a family τ of neutrosophic subsets of X which satisfies the following three conditions:

1. $0, 1 \in \tau$,
2. If $g, h \in \tau$, their $g \wedge h \in \tau$,
3. If $f_i \in \tau$ for each $i \in I$, then $\bigvee_{i \in I} f_i \in \tau$.

The pair (X, τ) is called a neutrosophic topological space.

Definition 2.3. Members of τ are called neutrosophic open sets and complement of neutrosophic open sets are called neutrosophic closed sets, where the complement of a neutrosophic set A , denoted by A^c , is $1 - A$.

3 NEUTROSOPHIC UPPER AND LOWER CONTRA-CONTINUOUS MULTIFUNCTIONS

Definition 3.1. Let (X, τ) be a topological space in the classical sense and (Y, σ) be a neutrosophic topological space. Then $F : (X, \tau) \rightarrow (Y, \sigma)$ is called a neutrosophic multifunction if and only if for each $x \in X$, $F(x)$ is a neutrosophic set in Y .

Definition 3.2. For a neutrosophic multifunction $F : (X, \tau) \rightarrow (Y, \sigma)$, the upper inverse $F^+(\lambda)$ and lower inverse $F^-(\lambda)$ of a neutrosophic set λ in Y are defined as follows:
 $F^+(\lambda) = \{x \in X : F(x) \subset \lambda\}$ and $F^-(\lambda) = \{x \in X : F(x) \supset \lambda\}$.

Lemma 3.3. For a fuzzy multifunction $F : (X, \tau) \rightarrow (Y, \sigma)$, we have $F^-(1 - \lambda) = X - F^+(\lambda)$ for any neutrosophic set λ in Y .

Definition 3.4. A neutrosophic multifunction $F : (X, \tau) \rightarrow (Y, \sigma)$ is called neutrosophic lower contra-continuous if for any neutrosophic closed set A in Y with $x \in F^-(A)$, there exists an open set B in X containing x such that $B \subset F^-(A)$.

Definition 3.5. A neutrosophic multifunction $F : (X, \tau) \rightarrow (Y, \sigma)$ is called neutrosophic upper contra-continuous if for each neutrosophic closed set A in Y with $x \in F^+(A)$, there exists an open set B in X containing x such that $B \subset F^+(A)$.

Theorem 3.6. The following are equivalent for a neutrosophic multifunction $F : (X, \tau) \rightarrow (Y, \sigma)$:

1. F is neutrosophic upper contra-continuous,
2. For each neutrosophic closed set A and $x \in X$ such that $F(x) \subset A$, there exists an open set B containing x such that if $y \in B$, then $F(y) \subset A$,

3. $F^+(A)$ is open for any neutrosophic closed set A in Y ,
4. $F^-(B)$ is closed for any neutrosophic open set B in Y .

Proof. (1) \Rightarrow (2): Obvious.

(1) \Rightarrow (3): Let A be any neutrosophic closed set in Y and $x \in F^+(A)$. By (1), there exists an open set A_x containing x such that $A_x \subset F^+(A)$. Thus, $x \in \text{Int}(F^+(A))$ and hence $F^+(A)$ is an open set in X .

(3) \Rightarrow (4): Let A be a neutrosophic open set in Y . Then $Y \setminus A$ is a neutrosophic closed set in Y . By (3), $F^+(Y \setminus A)$ is open. Since $F^+(Y \setminus A) = X \setminus F^-(A)$, then $F^-(A)$ is closed in X .

(4) \Rightarrow (3): It is similar to that of (3) \Rightarrow (4).

(3) \Rightarrow (1): Let A be any neutrosophic closed set in Y and $x \in F^+(A)$. By (3), $F^+(A)$ is an open set in X . Take $B = F^+(A)$. Then, $B \subset F^+(A)$. Thus, F is neutrosophic upper contra-continuous. \square

Definition 3.7. The set $\bigwedge\{A \in \tau : B \subset A\}$ is called the neutrosophic kernel of a neutrosophic set A in a neutrosophic topological space (X, τ) and is denoted by $Ker(A)$.

Lemma 3.8. If $A \in \tau$ rfor a neutrosophic set A in a neutrosophic topological space (X, τ) , then $A = Ker(A)$.

Theorem 3.9. Let $F : (X, \tau) \rightarrow (Y, \sigma)$ be a neutrosophic multifunction. If $\text{Cl}(F^-(A)) \subset F^-(Ker(A))$ for any neutrosophic set A in Y , then F is neutrosophic upper contra-continuous.

Proof. Suppose that $\text{Cl}(F^-(A)) \subset F^-(Ker(A))$ for every neutrosophic set A in Y . Let $B \in \sigma$. By Lemma 3.8, $\text{Cl}(F^-(B)) \subset F^-(Ker(B)) = F^-(B)$. This implies that $\text{Cl}(F^-(B)) = F^-(B)$ and hence $F^-(B)$ is closed in X . Thus, by Theorem 3.6, F is neutrosophic upper contra-continuous. \square

Definition 3.10. A neutrosophic multifunction $F : (X, \tau) \rightarrow (Y, \sigma)$ is called

1. neutrosophic lower semi-continuous if for any neutrosophic open subset $A \subset Y$ with $x \in F^-(A)$, there exists an open set B in X containing x such that $B \subset F^-(A)$.
2. neutrosophic upper semi-continuous if for any neutrosophic open subset $A \subset Y$ with $x \in F^+(A)$, there exists an open set B in X containing x such that $B \subset F^+(A)$.

Remark 3.11. The notions of neutrosophic upper contra-continuous multifunctions and neutrosophic upper semi-continuous multifunctions are independent as shown in the following examples.

Example 3.12. Let $X = \{a, b, c\}$, $\tau = \{X, \emptyset, \{a\}\}$ and $Y = [0, 1]$, $\sigma = \{Y, 0, A, B, C\}$, where $A(y) = \langle 0.5, 0, 0.5 \rangle$, $B(y) = \langle 0.6, 0, 0.4 \rangle$ and $C(y) = \langle 0.7, 0, 0.3 \rangle$ for $y \in Y$. Define a neutrosophic multifunction as follows: $F(a) = A$, $F(b) = B$, $F(c) = C$. Then the neutrosophic multifunction $F : (X, \tau) \rightarrow (Y, \sigma)$ is neutrosophic upper contra-continuous but it is not neutrosophic upper semi-continuous.

Example 3.13. Let $X = \{a, b, c\}$, $\tau = \{X, \emptyset, \{b, c\}\}$ and $Y = [0, 1]$, $\sigma = \{Y, 0, A, B, C\}$, where $A(y) = \langle 0.3, 0, 0.7 \rangle$, $B(y) = \langle 0.2, 0, 0.8 \rangle$, $C(y) = \langle 0.6, 0, 0.4 \rangle$, $D(y) = \langle 0.4, 0, 0.6 \rangle$, and $E(y) = \langle 0.5, 0, 0.5 \rangle$ for $y \in Y$. Define a neutrosophic multifunction as follows: $F(a) = D$, $F(b) = E$, $F(c) = C$. Then the neutrosophic multifunction $F : (X, \tau) \rightarrow (Y, \sigma)$ is neutrosophic upper semi-continuous, but it is not neutrosophic upper contra-continuous.

Theorem 3.14. The following are equivalent for a neutrosophic multifunction $F : (X, \tau) \rightarrow (Y, \sigma)$:

1. F is neutrosophic lower contra-continuous,
2. For each neutrosophic closed set A and $x \in X$ such that $F(x)qA$, there exists an open set B containing x such that if $y \in B$, then $F(y)qA$,
3. $F^-(A)$ is open for any neutrosophic closed set A in Y ,
4. $F^+(B)$ is closed for any neutrosophic open set B in Y .

Proof. It is similar to that of Theorem 3.6. □

Theorem 3.15. For a neutrosophic multifunction $F : (X, \tau) \rightarrow (Y, \sigma)$, if $\text{Cl}(F^+(A)) \subset F^+(\text{Ker}(A))$ for every neutrosophic set A in Y , then F is neutrosophic lower contra-continuous.

Proof. Suppose that $\text{Cl}(F^+(A)) \subset F^+(\text{Ker}(A))$ for every neutrosophic set A in Y . Let $A \in \sigma$. We have $\text{Cl}(F^+(A)) \subset F^+(\text{Ker}(A)) = F^+(A)$. Thus, $\text{Cl}(F^+(A)) = F^+(A)$ and hence $F^+(A)$ is closed in X . Then F is neutrosophic lower contra-continuous. □

Definition 3.16. Given a family $\{F_i : (X, \tau) \rightarrow (Y, \sigma) : i \in I\}$ of neutrosophic multifunctions, we define the union $\bigvee_{i \in I} F_i$ and the intersection $\bigwedge_{i \in I} F_i$ as follows: $\bigvee_{i \in I} F_i : (X, \tau) \rightarrow (Y, \sigma)$, $(\bigvee_{i \in I} F_i)(x) = \bigvee_{i \in I} F_i(x)$ and $\bigwedge_{i \in I} F_i : (X, \tau) \rightarrow (Y, \sigma)$, $(\bigwedge_{i \in I} F_i)(x) = \bigwedge_{i \in I} F_i(x)$.

Theorem 3.17. If $F_i : X \rightarrow Y$ are neutrosophic upper contra-continuous multifunctions for $i = 1, 2, \dots, n$, then $\bigvee_{i \in I}^n F_i$ is a neutrosophic upper contra-continuous multifunction.

Proof. Let A be a neutrosophic closed set of Y . We will show that $(\bigvee_{i \in I}^n F_i)^+(A) = \{x \in X : \bigvee_{i \in I}^n F_i(x) \subset A\}$ is open in X . Let $x \in (\bigvee_{i \in I}^n F_i)^+(A)$. Then $F_i(x) \subset A$ for $i = 1, 2, \dots, n$. Since $F_i : X \rightarrow Y$ is neutrosophic upper contra-continuous multifunction for $i = 1, 2, \dots, n$, then there exists an open set U_x containing x such that for all $z \in U_x$, $F_i(z) \subset A$. Let $U = \bigcup_{i \in I} U_x$. Then $U \subset (\bigvee_{i \in I}^n F_i)^+(A)$. Thus, $(\bigvee_{i \in I}^n F_i)^+(A)$ is open and hence $\bigvee_{i \in I}^n F_i$ is a neutrosophic upper contra-continuous multifunction. □

Lemma 3.18. Let $\{A_i\}_{i \in I}$ be a family of neutrosophic sets in a neutrosophic topological space X . Then a neutrosophic point x is quasi-coincident with $\bigvee A_i$ if and only if there exists an $i_0 \in I$ such that xqA_{i_0} .

Theorem 3.19. *If $F_i : X \rightarrow Y$ are neutrosophic lower contra-continuous multifunctions for $i = 1, 2, \dots, n$, then $\bigvee_{i \in I}^n F_i$ is a neutrosophic lower contra-continuous multifunction.*

Proof. Let A be a neutrosophic closed set of Y . We will show that $(\bigvee_{i \in I}^n F_i)^-(A) = \{x \in X : (\bigvee_{i \in I}^n F_i)(x)qA\}$ is open in X . Let $x \in (\bigvee_{i \in I}^n F_i)^-(A)$. Then $(\bigvee_{i \in I}^n F_i)(x)qA$ and hence $F_{i_0}(x)qA$ for an i_0 . Since $F_i : X \rightarrow Y$ is neutrosophic lower contra-continuous multifunction, there exists an open set U_x containing x such that for all $z \in U_x$, $F_{i_0}(z)qA$. Then $(\bigvee_{i \in I}^n F_i)(z)qA$ and hence $U_x \subset (\bigvee_{i \in I}^n F_i)^-(A)$. Thus, $(\bigvee_{i \in I}^n F_i)^-(A)$ is open and hence $\bigvee_{i \in I}^n F_i$ is a neutrosophic lower contra-continuous multifunction. \square

Theorem 3.20. *Let $F : (X, \tau) \rightarrow (Y, \sigma)$ be a neutrosophic multifunction and $\{U_i : i \in I\}$ be an open cover for X . Then the following are equivalent:*

1. $F_i = F|_{U_i}$ is a neutrosophic lower contra-continuous multifunction for all $i \in I$,
2. F is neutrosophic lower contra-continuous.

Proof. (1) \Rightarrow (2): Let $x \in X$ and A be a neutrosophic closed set in Y with $x \in F^-(A)$. Since $\{U_i : i \in I\}$ is an open cover for X , then $x \in U_{i_0}$ for an $i_0 \in I$. We have $F(x) = F_{i_0}(x)$ and hence $x \in F_{i_0}^-(A)$. Since $F|_{U_{i_0}}$ is neutrosophic lower contra-continuous, there exists an open set $B = G \cap U_{i_0}$ in U_{i_0} such that $x \in B$ and $F^-(A) \cap U_{i_0} = F|_{U_{i_0}}(A) \supset B = G \cap U_{i_0}$, where G is open in X . We have $x \in B = G \cap U_{i_0} \subset F|_{U_{i_0}}^-(A) = F^-(A) \cap U_{i_0} \subset F^-(A)$. Hence, F is neutrosophic lower contra-continuous.

(2) \Rightarrow (1): Let $x \in X$ and $x \in U_i$. Let A be a neutrosophic closed set in Y with $F_i(x)qA$. Since F is lower contra-continuous and $F(x) = F_i(x)$, there exists an open set U containing x such that $U \subset F^-(A)$. Take $B = U_i \cap U$. Then B is open in U_i containing x . We have $B \subset F^-i(A)$. Thus F_i is a neutrosophic lower contra-continuous. \square

Theorem 3.21. *Let $F : (X, \tau) \rightarrow (Y, \sigma)$ be a neutrosophic multifunction and $\{U_i : i \in I\}$ be an open cover for X . Then the following are equivalent:*

1. $F_i = F|_{U_i}$ is a neutrosophic upper contra-continuous multifunction for all $i \in I$,
2. F is neutrosophic upper contra-continuous.

Proof. It is similar to that of Theorem 3.20. \square

Recall that for a multifunction $F_1 : (X, \tau) \rightarrow (Y, \sigma)$ and a neutrosophic multifunction $F_2 : (Y, \sigma) \rightarrow (Z, \eta)$, the neutrosophic multifunction $F_2 \circ F_1 : (X, \tau) \rightarrow (Z, \eta)$ is defined by $(F_2 \circ F_1)(x) = F_2(F_1(x))$ for $x \in X$.

Definition 3.22. *Let X and Y be topological spaces. A multifunction $F : (X, \tau) \rightarrow (Y, \sigma)$ is called*

1. lower semi-continuous if for any open subset $A \subset Y$ with $x \in F^-(A)$, there exists an open set B in X containing x such that $B \subset F^-(A)$.
2. upper semi-continuous if for any open subset $A \subset Y$ with $x \in F^+(A)$, there exists an open set B in X containing x such that $B \subset F^+(A)$.

Theorem 3.23. *If $F_1 : X \rightarrow Y$ is an upper semi-continuous multifunction, where X and Y are topological spaces and $F_2 : Y \rightarrow Z$ is a neutrosophic upper contra-continuous multifunction, where Z is a neutrosophic topological space, then $F_2 \circ F_1$ is neutrosophic upper contra-continuous.*

Proof. Let $x \in X$ and A be a neutrosophic closed set in Z . We have $(F_2 \circ F_1)^+(A) = F_1^+(F_2^+(A))$. Since F_2 is neutrosophic upper contra-continuous, $F_2^+(A)$ is open in Y . Since F_1 is upper semi-continuous, $F_1^+(F_2^+(A)) = (F_2 \circ F_1)^+(A)$ is open in X . Thus, $F_2 \circ F_1$ is neutrosophic upper contra-continuous. \square

Definition 3.24. *A neutrosophic set A in a neutrosophic topological space X is called:*

1. a neutrosophic cl-neighbourhood of a neutrosophic point x in X if there exists a neutrosophic closed set B in X such that $x \in B \subset A$.
2. a neutrosophic cl-neighbourhood of a neutrosophic set B in X if there exists a neutrosophic closed set C in X such that $B \subset C \subset A$.

Theorem 3.25. *If $F : (X, \tau) \rightarrow (Y, \sigma)$ is a neutrosophic upper contra-continuous multifunction, then for each point x of X and each neutrosophic cl-neighbourhood A of $F(x)$, $F^+(A)$ is a neighbourhood of x .*

Proof. Let $x \in X$ and A be a neutrosophic cl-neighbourhood of $F(x)$. There exists a neutrosophic closed set B in Y such that $F(x) \subset B \subset A$. We have $x \in F^+(B) \subset F^+(A)$. Since $F^+(B)$ is an open set, $F^+(A)$ is a neighbourhood of x . \square

Remark 3.26. *A subset A of a topological space (X, τ) can be considered as a neutrosophic set with characteristic function defined by*

$$A(x) = \begin{cases} 1 & \text{if } x \in A \\ 0 & \text{if } x \notin A. \end{cases}$$

Let (Y, σ) be a neutrosophic topological space. The neutrosophic sets of the form $A \times B$ with $A \in \tau$ and $B \in \sigma$ form a basis for the product neutrosophic topology $\tau \times \sigma$ on $X \times Y$, where for any $(x, y) \in X \times Y$, $(A \times B)(x, y) = \min\{A(x), B(y)\}$.

Definition 3.27. *For a neutrosophic multifunction $F : (X, \tau) \rightarrow (Y, \sigma)$, the neutrosophic graph multifunction $G_F : X \rightarrow X \times Y$ of F is defined by $G_F(x) = x_1 \times F(x)$ for every $x \in X$.*

Theorem 3.28. *If the neutrosophic graph multifunction G_F of a neutrosophic multifunction $F : (X, \tau) \rightarrow (Y, \sigma)$ is neutrosophic lower contra-continuous, then F is neutrosophic lower contra-continuous.*

Proof. Suppose that G_F is neutrosophic lower contra-continuous and $x \in X$. Let A be a neutrosophic closed set in Y such that $F(x)qA$. Then there exists $y \in Y$ such that $(F(x))(y) + A(y) > 1$. Then $(G_F(x))(x, y) + (X \times A)(x, y) = (F(x))(y) + A(y) > 1$. Hence, $G_F(x)q(X \times A)$. Since G_F is neutrosophic lower contra-continuous, there exists an open set B in X such that $x \in B$ and $G_F(b)q(X \times A)$ for all $b \in B$. Let there exists $b_0 \in B$ such that $F(b_0)qA$. Then for all $y \in Y$, $(F(b_0))(y) + A(y) < 1$. For any $(a, c) \in X \times Y$, we have $(G_F(b_0))(a, c) \subset (F(b_0))(c)$ and $(X \times A)(a, c) \subset A(c)$. Since for all $y \in Y$, $(F(b_0))(y) + A(y) < 1$, $(G_F(b_0))(a, c) + (X \times A)(a, c) < 1$. Thus, $G_F(b_0)q(X \times A)$, where $b_0 \in B$. This is a contradiction since $G_F(b)q(X \times A)$ for all $b \in B$. Hence, F is neutrosophic lower contra-continuous. \square

Theorem 3.29. *If the neutrosophic graph multifunction G_F of a neutrosophic multifunction $F : X \rightarrow Y$ is neutrosophic upper contra-continuous, then F is neutrosophic upper contra-continuous.*

Proof. Suppose that G_F is neutrosophic upper contra-continuous and let $x \in X$. Let A be neutrosophic closed in Y with $F(x) \subset A$. Then $G_F(x) \subset X \times A$. Since G_F is neutrosophic upper contra-continuous, there exists an open set B containing x such that $G_F(B) \subset X \times A$. For any $b \in B$ and $y \in Y$, we have $(F(b))(y) = (G_F(b))(b, y) \subset (X \times A)(b, y) = A(y)$. Then $(F(b))(y) \subset A(y)$ for all $y \in Y$. Thus, $F(b) \subset A$ for any $b \in B$. Hence, F is neutrosophic upper contra-continuous. \square

Theorem 3.30. *Let $F : (X, \tau) \rightarrow (Y, \sigma)$ be a neutrosophic multifunction. Then the following are equivalent:*

1. F is neutrosophic lower contra-continuous,
2. For any $x \in X$ and any net $(x_i)_{i \in I}$ converging to x in X and each neutrosophic closed set B in Y with $x \in F^-(B)$, the net $(x_i)_{i \in I}$ is eventually in $F^-(B)$.

Proof. (1) \Rightarrow (2): Let (x_i) be a net converging to x in X and B be any neutrosophic closed set in Y with $x \in F^-(B)$. Since F is neutrosophic lower contra-continuous, there exists an open set $A \subset X$ containing x such that $A \subset F^-(B)$. Since $x_i \rightarrow x$, there exists an index $i_0 \in I$ such that $x_i \in A$ for every $i \geq i_0$. We have $x_i \in A \subset F^-(B)$ for all $i \geq i_0$. Hence, $(x_i)_{i \in I}$ is eventually in $F^-(B)$.

(2) \Rightarrow (1): Suppose that F is not neutrosophic lower contra-continuous. There exists a point x and a neutrosophic closed set A with $x \in F^-(A)$ such that $B \not\subset F^-(A)$ for any open set $B \subset X$ containing x . Let $x_i \in B$ and $x_i \notin F^-(A)$ for each open set $B \subset X$ containing x . Then the neighborhood net (x_i) converges to x but $(x_i)_{i \in I}$ is not eventually in $F^-(A)$. This is a contradiction. \square

Theorem 3.31. *Let $F : (X, \tau) \rightarrow (Y, \sigma)$ be a neutrosophic multifunction. Then the following are equivalent:*

1. F is neutrosophic upper contra-continuous,
2. For any $x \in X$ and any net (x_i) converging to x in X and any neutrosophic closed set B in Y with $x \in F^+(B)$, the net (x_i) is eventually in $F^+(B)$.

Proof. The proof is similar to that of Theorem 3.30. □

Theorem 3.32. *The set of all points of X at which a neutrosophic multifunction $F : (X, \tau) \rightarrow (Y, \sigma)$ is not neutrosophic upper contra-continuous is identical with the union of the frontier of the upper inverse image of neutrosophic closed sets containing $F(x)$.*

Proof. Suppose F is not neutrosophic upper contra-continuous at $x \in X$. Then there exists a neutrosophic closed set A in Y containing $F(x)$ such that $A \cap (X \setminus F^+(B)) \neq \emptyset$ for every open set A containing x . We have $x \in \text{Cl}(X \setminus F^+(B)) = X \setminus \text{Int}(F^+(B))$ and $x \in F^+(B)$. Thus, $x \in \text{Fr}(F^+(B))$. Conversely, let B be a neutrosophic closed set in Y containing $F(x)$ with $x \in \text{Fr}(F^+(B))$. Suppose that F is neutrosophic upper contra-continuous at x . There exists an open set A containing x such that $A \subset F^+(B)$. We have $x \in \text{Int}(F^+(B))$. This is a contradiction. Thus, F is not neutrosophic upper contra-continuous at x . □

Theorem 3.33. *The set of all points of X at which a neutrosophic multifunction $F : (X, \tau) \rightarrow (Y, \sigma)$ is not neutrosophic lower contra-continuous is identical with the union of the frontier of the lower inverse image of neutrosophic closed sets which are quasi-coincident with $F(x)$.*

Proof. It is similar to that of Theorem 3.32. □

Definition 3.34. *A neutrosophic topological space X is called neutrosophic strongly S-closed if every neutrosophic closed cover of X has a finite subcover.*

Theorem 3.35. *Let $F : (X, \tau) \rightarrow (Y, \sigma)$ be a neutrosophic upper contra-continuous surjective multifunction. Suppose that $F(x)$ is neutrosophic strongly S-closed for each $x \in X$. If X is compact, then Y is neutrosophic strongly S-closed.*

Proof. Let $\{A_k\}_{k \in I}$ be a neutrosophic closed cover of Y . Since $F(x)$ is neutrosophic strongly S-closed for any $x \in X$, there exists a finite subset I_x of I such that $F(x) \subset \bigvee_{k \in I_x} A_k$. Take $A_x = \bigvee_{k \in I_x} A_k$. Since F is neutrosophic upper contra-continuous, there exists a neutrosophic open set U_x of X containing x such that $F(U_x) \subset A_x$. Then $\{U_x\}_{x \in X}$ is an open cover of X . Since X is compact, there exist $x_1, x_2, x_3, \dots, x_n$ in X such that $X = \bigcup_{i=1}^n U_{x_i}$. We have $Y = F(X) = F(\bigcup_{i=1}^n U_{x_i}) \leq \bigvee_{i=1}^n F(U_{x_i}) \leq \bigvee_{i=1}^n U_{x_i} A_{x_i} = \bigvee_{i=1}^n \bigvee_{k \in I_{x_i}} U_k$. Thus, Y is neutrosophic strongly S-closed. □

REFERENCES

Salama, A. A. and Alblowi, S. A. (2012). Neutrosophic Set and Neutrosophic Topological Spaces. *IOSR Journal of Mathematics*, 3(4), 31-35.

Smarandache F (1999) *A unifying field in logics. Neutrosophy: Neutrosophic probability, set and logic*. American Research Press, Rehoboth.

A Novel Extension of Neutrosophic Sets and Its Application in *BCK/BCI*-Algebras

Seok-Zun Song¹, Madad Khan², Florentin Smarandache³, and Young Bae Jun^{4,*}

¹Department of Mathematics, Jeju National University, Jeju 63243, Korea.

E-mail: szsong@jejunu.ac.kr

²Department of Mathematics, COMSATS Institute of Information Technology, Abbottabad, Pakistan.

E-mail: madadmth@yahoo.com

³ Mathematics & Science Department, University of New Mexico, 705 Gurley Ave., Gallup, NM 87301, USA.

E-mail: fsmarandache@gmail.com

⁴Department of Mathematics Education, Gyeongsang National University, Jinju 52828, Korea.

E-mail: skywine@gmail.com

Corresponding author's e-mail*: skywine@gmail.com

ABSTRACT

Generalized neutrosophic set is introduced, and applied it to BCK/BCI-algebras. The notions of generalized neutrosophic subalgebras and generalized neutrosophic ideals in BCK/BCI-algebras are introduced, and related properties are investigated. Characterizations of generalized neutrosophic subalgebra/ideal are considered. Relation between generalized neutrosophic subalgebra and generalized neutrosophic ideal is discussed. In a BCK-algebra, conditions for a generalized neutrosophic subalgebra to be a generalized neutrosophic ideal are provided. Conditions for a generalized neutrosophic set to be a generalized neutrosophic ideal are also provided. Homomorphic image and preimage of generalized neutrosophic ideal are considered.

KEYWORDS: Generalized neutrosophic set, generalized neutrosophic subalgebra, generalized neutrosophic ideal.

1 Introduction

Zadeh (1965) introduced the degree of membership/truth (t) in 1965 and defined the fuzzy set. As a generalization of fuzzy sets, Atanassov (1986) introduced the degree of nonmembership/falsehood (f) in 1986 and defined the intuitionistic fuzzy set. Smarandache introduced the degree of indeterminacy/neutrality (i) as independent component in 1995 (published in 1998) and defined the neutrosophic set on three components

$$(t, i, f) = (\text{truth, indeterminacy, falsehood}).$$

For more detail, refer to the site

<http://fs.gallup.unm.edu/FlorentinSmarandache.htm>.

The concept of neutrosophic set (NS) developed by Smarandache (1999) and Smarandache (2005) is a more general platform which extends the concepts of the classic set and fuzzy set, intuitionistic fuzzy set and interval valued intuitionistic fuzzy set. Neutrosophic set theory is applied to various part (refer to the site <http://fs.gallup.unm.edu/neutrosophy.htm>). Agboola and Davvaz (2015) introduced the concept of neutrosophic *BCI/BCK*-algebras, and presented elementary properties of neutrosophic *BCI/BCK*-algebras. Saeid and Jun (2017) gave relations between an $(\in, \in \vee q)$ -neutrosophic subalgebra and a $(q, \in \vee q)$ -neutrosophic subalgebra, and discussed characterization of an $(\in, \in \vee q)$ -neutrosophic subalgebra by using neutrosophic \in -subsets. They provided conditions for an $(\in, \in \vee q)$ -neutrosophic subalgebra to be a $(q, \in \vee q)$ -neutrosophic subalgebra, and investigated properties on neutrosophic q -subsets and neutrosophic $\in \vee q$ -subsets. Jun (2017) considered neutrosophic subalgebras of several types in *BCK/BCI*-algebras.

In this paper, we consider a generalization of Smarandache's neutrosophic sets. We introduce the notion of generalized neutrosophic sets and apply it to *BCK/BCI*-algebras. We introduce the notions of generalized neutrosophic subalgebras and generalized neutrosophic ideals in *BCK/BCI*-algebras, and investigate related properties. We consider characterizations of generalized neutrosophic subalgebra/ideal, and discussed relation between generalized neutrosophic subalgebra and generalized neutrosophic ideal. We provide conditions for a generalized neutrosophic subalgebra to be a generalized neutrosophic ideal in a *BCK*-algebra. We also provide conditions for a generalized neutrosophic set to be a generalized neutrosophic ideal, and consider homomorphic image and preimage of generalized neutrosophic ideal.

2 PRELIMINARIES

By a *BCI-algebra* we mean an algebra $(X, *, 0)$ of type $(2, 0)$ satisfying the conditions:

$$(a1) \quad ((x * y) * (x * z)) * (z * y) = 0,$$

$$(a2) \quad (x * (x * y)) * y = 0,$$

$$(a3) \quad x * x = 0,$$

$$(a4) \quad x * y = y * x = 0 \Rightarrow x = y,$$

for all $x, y, z \in X$. If a *BCI*-algebra X satisfies the condition

$$(a5) \quad 0 * x = 0 \text{ for all } x \in X,$$

then we say that X is a *BCK-algebra*. A partial ordering " \leq " on X is defined by

$$(\forall x, y \in X) (x \leq y \iff x * y = 0).$$

In a *BCK/BCI*-algebra X , the following properties are satisfied:

$$(\forall x \in X) (x * 0 = x), \tag{2.1}$$

$$(\forall x, y, z \in X) ((x * y) * z = (x * z) * y). \tag{2.2}$$

A nonempty subset S of a BCK/BCI -algebra X is called a *subalgebra* of X if $x * y \in S$ for all $x, y \in S$. A nonempty subset I of a BCK/BCI -algebra X is called an *ideal* of X if

$$0 \in I, \tag{2.3}$$

$$(\forall x, y \in X) (x * y \in I, y \in I \Rightarrow x \in I). \tag{2.4}$$

We refer the reader to the books (Meng & Jun, 1994) and (Huang, 2006) for further information regarding BCK/BCI -algebras.

For any family $\{a_i \mid i \in \Lambda\}$ of real numbers, we define

$$\bigvee \{a_i \mid i \in \Lambda\} := \begin{cases} \max\{a_i \mid i \in \Lambda\} & \text{if } \Lambda \text{ is finite,} \\ \sup\{a_i \mid i \in \Lambda\} & \text{otherwise.} \end{cases}$$

$$\bigwedge \{a_i \mid i \in \Lambda\} := \begin{cases} \min\{a_i \mid i \in \Lambda\} & \text{if } \Lambda \text{ is finite,} \\ \inf\{a_i \mid i \in \Lambda\} & \text{otherwise.} \end{cases}$$

If $\Lambda = \{1, 2\}$, we will also use $a_1 \vee a_2$ and $a_1 \wedge a_2$ instead of $\bigvee \{a_i \mid i \in \Lambda\}$ and $\bigwedge \{a_i \mid i \in \Lambda\}$, respectively.

By a *fuzzy set* in a nonempty set X we mean a function $\mu : X \rightarrow [0, 1]$, and the *complement* of μ , denoted by μ^c , is the fuzzy set in X given by $\mu^c(x) = 1 - \mu(x)$ for all $x \in X$. A fuzzy set μ in a BCK/BCI -algebra X is called a *fuzzy subalgebra* of X if $\mu(x * y) \geq \mu(x) \wedge \mu(y)$ for all $x, y \in X$. A fuzzy set μ in a BCK/BCI -algebra X is called a *fuzzy ideal* of X if

$$(\forall x \in X) (\mu(0) \geq \mu(x)), \tag{2.5}$$

$$(\forall x, y \in X) (\mu(x) \geq \mu(x * y) \wedge \mu(y)). \tag{2.6}$$

Let X be a non-empty set. A neutrosophic set (NS) in X (Smarandache, 1999) is a structure of the form:

$$A := \{\langle x; A_T(x), A_I(x), A_F(x) \rangle \mid x \in X\}$$

where $A_T : X \rightarrow [0, 1]$ is a truth membership function, $A_I : X \rightarrow [0, 1]$ is an indeterminate membership function, and $A_F : X \rightarrow [0, 1]$ is a false membership function. For the sake of simplicity, we shall use the symbol $A = (A_T, A_I, A_F)$ for the neutrosophic set

$$A := \{\langle x; A_T(x), A_I(x), A_F(x) \rangle \mid x \in X\}.$$

3 GENERALIZED NEUTROSOPHIC SETS

Definition 3.1. A *generalized neutrosophic set* (GNS) in a non-empty set X is a structure of the form:

$$A := \{\langle x; A_T(x), A_{IT}(x), A_{IF}(x), A_F(x) \rangle \mid x \in X, A_{IT}(x) + A_{IF}(x) \leq 1\}$$

where $A_T : X \rightarrow [0, 1]$ is a truth membership function, $A_F : X \rightarrow [0, 1]$ is a false membership function, $A_{IT} : X \rightarrow [0, 1]$ is an indeterminate membership function which is familiar with truth membership function, and $A_{IF} : X \rightarrow [0, 1]$ is an indeterminate membership function which is familiar with false membership function.

Example 3.2. Let $X = \{a, b, c\}$ be a set. Then

$$A = \{\langle a; 0.4, 0.6, 0.3, 0.7 \rangle, \langle b; 0.6, 0.2, 0.5, 0.7 \rangle, \langle c; 0.1, 0.3, 0.5, 0.6 \rangle\}$$

is a GNS in X . But

$$B = \{\langle a; 0.4, 0.6, 0.3, 0.7 \rangle, \langle b; 0.6, 0.3, 0.9, 0.7 \rangle, \langle c; 0.1, 0.3, 0.5, 0.6 \rangle\}$$

is not a GNS in X since $B_{IT}(b) + B_{IF}(b) = 0.3 + 0.9 = 1.2 > 1$.

For the sake of simplicity, we shall use the symbol $A = (A_T, A_{IT}, A_{IF}, A_F)$ for the generalized neutrosophic set

$$A := \{\langle x; A_T(x), A_{IT}(x), A_{IF}(x), A_F(x) \rangle \mid x \in X, A_{IT}(x) + A_{IF}(x) \leq 1\}.$$

Note that every GNS $A = (A_T, A_{IT}, A_{IF}, A_F)$ in X satisfies the condition:

$$(\forall x \in X) (0 \leq A_T(x) + A_{IT}(x) + A_{IF}(x) + A_F(x) \leq 3).$$

If $A = (A_T, A_{IT}, A_{IF}, A_F)$ is a GNS in X , then $\Box A = (A_T, A_{IT}, A_{IT}^c, A_T^c)$ and $\Diamond A = (A_F^c, A_{IF}^c, A_{IF}, A_F)$ are also GNSs in X .

Example 3.3. Given a set $X = \{0, 1, 2, 3, 4\}$, we know that

$$A = \{\langle 0; 0.4, 0.6, 0.3, 0.7 \rangle, \langle 1; 0.6, 0.2, 0.5, 0.7 \rangle, \langle 2; 0.1, 0.3, 0.5, 0.6 \rangle, \\ \langle 3; 0.9, 0.1, 0.8, 0.6 \rangle, \langle 4; 0.3, 0.6, 0.2, 0.9 \rangle\}$$

is a GNS in X . Then

$$\Box A = \{\langle 0; 0.4, 0.6, 0.4, 0.6 \rangle, \langle 1; 0.6, 0.2, 0.8, 0.4 \rangle, \langle 2; 0.1, 0.3, 0.7, 0.9 \rangle, \\ \langle 3; 0.9, 0.1, 0.9, 0.1 \rangle, \langle 4; 0.3, 0.6, 0.4, 0.7 \rangle\}$$

and

$$\Diamond A = \{\langle 0; 0.3, 0.7, 0.3, 0.7 \rangle, \langle 1; 0.3, 0.5, 0.5, 0.7 \rangle, \langle 2; 0.4, 0.5, 0.5, 0.6 \rangle, \\ \langle 3; 0.4, 0.2, 0.8, 0.6 \rangle, \langle 4; 0.1, 0.8, 0.2, 0.9 \rangle\}$$

are GNSs in X .

4 APPLICATIONS IN *BCK/BCI*-ALGEBRAS

In what follows, let X denote a *BCK/BCI*-algebra unless otherwise specified.

Definition 4.1. A GNS $A = (A_T, A_{IT}, A_{IF}, A_F)$ in X is called a *generalized neutrosophic subalgebra* of X if the following conditions are valid.

$$(\forall x, y \in X) \left(\begin{array}{l} A_T(x * y) \geq A_T(x) \wedge A_T(y) \\ A_{IT}(x * y) \geq A_{IT}(x) \wedge A_{IT}(y) \\ A_{IF}(x * y) \leq A_{IF}(x) \vee A_{IF}(y) \\ A_F(x * y) \leq A_F(x) \vee A_F(y) \end{array} \right). \quad (4.1)$$

Example 4.2. Consider a *BCK*-algebra $X = \{0, 1, 2, 3\}$ with the Cayley table which is given in Table 1.

Table 1: Cayley table for the binary operation “*”

*	0	1	2	3
0	0	0	0	0
1	1	0	0	1
2	2	1	0	2
3	3	3	3	0

Then the GNS

$$A = \{ \langle 0; 0.6, 0.7, 0.2, 0.3 \rangle, \langle 1; 0.6, 0.6, 0.3, 0.3 \rangle, \\ \langle 2; 0.4, 0.5, 0.4, 0.7 \rangle, \langle 3; 0.6, 0.3, 0.6, 0.5 \rangle \}$$

in X is a generalized neutrosophic subalgebra of X .

Given a GNS $A = (A_T, A_{IT}, A_{IF}, A_F)$ in X and $\alpha_T, \alpha_{IT}, \beta_F, \beta_{IF} \in [0, 1]$, consider the following sets.

$$\begin{aligned} U(T, \alpha_T) &:= \{x \in X \mid A_T(x) \geq \alpha_T\}, \\ U(IT, \alpha_{IT}) &:= \{x \in X \mid A_{IT}(x) \geq \alpha_{IT}\}, \\ L(F, \beta_F) &:= \{x \in X \mid A_F(x) \leq \beta_F\}, \\ L(IF, \beta_{IF}) &:= \{x \in X \mid A_{IF}(x) \leq \beta_{IF}\}. \end{aligned}$$

Theorem 4.3. *If a GNS $A = (A_T, A_{IT}, A_{IF}, A_F)$ is a generalized neutrosophic subalgebra of X , then the set $U(T, \alpha_T)$, $U(IT, \alpha_{IT})$, $L(F, \beta_F)$ and $L(IF, \beta_{IF})$ are subalgebras of X for all $\alpha_T, \alpha_{IT}, \beta_F, \beta_{IF} \in [0, 1]$ whenever they are non-empty.*

Proof. Assume that $U(T, \alpha_T)$, $U(IT, \alpha_{IT})$, $L(F, \beta_F)$ and $L(IF, \beta_{IF})$ are nonempty for all $\alpha_T, \alpha_{IT}, \beta_F, \beta_{IF} \in [0, 1]$. Let $x, y \in X$. If $x, y \in U(T, \alpha_T)$, then $A_T(x) \geq \alpha_T$ and $A_T(y) \geq \alpha_T$. It follows that

$$A_T(x * y) \geq A_T(x) \wedge A_T(y) \geq \alpha_T$$

and so that $x * y \in U(T, \alpha_T)$. Hence $U(T, \alpha_T)$ is a subalgebra of X . Similarly, if $x, y \in U(IT, \alpha_{IT})$, then $x * y \in U(IT, \alpha_{IT})$, that is, $U(IT, \alpha_{IT})$ is a subalgebra of X . Suppose that $x, y \in L(F, \beta_F)$. Then $A_F(x) \leq \beta_F$ and $A_F(y) \leq \beta_F$, which imply that

$$A_F(x * y) \leq A_F(x) \vee A_F(y) \leq \beta_F,$$

that is, $x * y \in L(F, \beta_F)$. Hence $L(F, \beta_F)$ is a subalgebra of X . Similarly we can verify that $L(IF, \beta_{IF})$ is a subalgebra of X . \square

Corollary 4.4. *If a GNS $A = (A_T, A_{IT}, A_{IF}, A_F)$ is a generalized neutrosophic subalgebra of X , then the set*

$$A(\alpha_T, \alpha_{IT}, \beta_F, \beta_{IF}) := \{x \in X \mid A_T(x) \geq \alpha_T, A_{IT}(x) \geq \alpha_{IT}, A_F(x) \leq \beta_F, A_{IF}(x) \leq \beta_{IF}\}$$

is a subalgebra of X for all $\alpha_T, \alpha_{IT}, \beta_F, \beta_{IF} \in [0, 1]$.

Proof. Straightforward. \square

Theorem 4.5. *Let $A = (A_T, A_{IT}, A_{IF}, A_F)$ be a GNS in X such that $U(T, \alpha_T)$, $U(IT, \alpha_{IT})$, $L(F, \beta_F)$ and $L(IF, \beta_{IF})$ are subalgebras of X for all $\alpha_T, \alpha_{IT}, \beta_F, \beta_{IF} \in [0, 1]$ whenever they are non-empty. Then $A = (A_T, A_{IT}, A_{IF}, A_F)$ is a generalized neutrosophic subalgebra of X .*

Proof. Assume that $U(T, \alpha_T)$, $U(IT, \alpha_{IT})$, $L(F, \beta_F)$ and $L(IF, \beta_{IF})$ are subalgebras for all $\alpha_T, \alpha_{IT}, \beta_F, \beta_{IF} \in [0, 1]$. If there exist $x, y \in X$ such that

$$A_T(x * y) < A_T(x) \wedge A_T(y),$$

then $x, y \in U(T, t_\alpha)$ and $x * y \notin U(T, t_\alpha)$ for $t_\alpha = A_T(x) \wedge A_T(y)$. This is a contradiction, and so

$$A_T(x * y) \geq A_T(x) \wedge A_T(y)$$

for all $x, y \in X$. Similarly, we can prove

$$A_{IT}(x * y) \geq A_{IT}(x) \wedge A_{IT}(y)$$

for all $x, y \in X$. Suppose that

$$A_{IF}(x * y) > A_{IF}(x) \vee A_{IF}(y)$$

for some $x, y \in X$. Then there exists $f_\beta \in [0, 1)$ such that

$$A_{IF}(x * y) > f_\beta \geq A_{IF}(x) \vee A_{IF}(y),$$

which induces a contradiction since $x, y \in L(IF, f_\beta)$ and $x * y \notin L(IF, f_\beta)$. Thus

$$A_{IF}(x * y) \leq A_{IF}(x) \vee A_{IF}(y)$$

for all $x, y \in X$. Similar way shows that

$$A_F(x * y) \leq A_F(x) \vee A_F(y)$$

for all $x, y \in X$. Therefore $A = (A_T, A_{IT}, A_{IF}, A_F)$ is a generalized neutrosophic subalgebra of X . \square

Since $[0, 1]$ is a completely distributive lattice under the usual ordering, we have the following theorem.

Theorem 4.6. *The family of generalized neutrosophic subalgebras of X forms a complete distributive lattice under the inclusion.*

Proposition 4.7. *Every generalized neutrosophic subalgebra $A = (A_T, A_{IT}, A_{IF}, A_F)$ of X satisfies the following assertions:*

- (1) $(\forall x \in X) (A_T(0) \geq A_T(x), A_{IT}(0) \geq A_{IT}(x)),$
- (2) $(\forall x \in X) (A_{IF}(0) \leq A_{IF}(x), A_F(0) \leq A_F(x)).$

Proof. Since $x * x = 0$ for all $x \in X$, it is straightforward. \square

Theorem 4.8. *Let $A = (A_T, A_{IT}, A_{IF}, A_F)$ be a GNS in X . If there exists a sequence $\{a_n\}$ in X such that $\lim_{n \rightarrow \infty} A_T(a_n) = 1 = \lim_{n \rightarrow \infty} A_{IT}(a_n)$ and $\lim_{n \rightarrow \infty} A_F(a_n) = 0 = \lim_{n \rightarrow \infty} A_{IF}(a_n)$, then $A_T(0) = 1 = A_{IT}(0)$ and $A_F(0) = 0 = A_{IF}(0)$.*

Proof. Using Proposition 4.7, we know that $A_T(0) \geq A_T(a_n)$, $A_{IT}(0) \geq A_{IT}(a_n)$, $A_{IF}(0) \leq A_{IF}(a_n)$ and $A_F(0) \leq A_F(a_n)$ for every positive integer n . It follows that

$$\begin{aligned} 1 &\geq A_T(0) \geq \lim_{n \rightarrow \infty} A_T(a_n) = 1, \\ 1 &\geq A_{IT}(0) \geq \lim_{n \rightarrow \infty} A_{IT}(a_n) = 1, \\ 0 &\leq A_{IF}(0) \leq \lim_{n \rightarrow \infty} A_{IF}(a_n) = 0, \\ 0 &\leq A_F(0) \leq \lim_{n \rightarrow \infty} A_F(a_n) = 0. \end{aligned}$$

Thus $A_T(0) = 1 = A_{IT}(0)$ and $A_F(0) = 0 = A_{IF}(0)$. \square

Proposition 4.9. *If every GNS $A = (A_T, A_{IT}, A_{IF}, A_F)$ in X satisfies:*

$$(\forall x, y \in X) \left(\begin{array}{l} A_T(x * y) \geq A_T(y), \quad A_{IT}(x * y) \geq A_{IT}(y) \\ A_{IF}(x * y) \leq A_{IF}(y), \quad A_F(x * y) \leq A_F(y) \end{array} \right), \quad (4.2)$$

then $A = (A_T, A_{IT}, A_{IF}, A_F)$ is constant on X .

Proof. Using (2.1) and (4.2), we have $A_T(x) = A_T(x * 0) \geq A_T(0)$, $A_{IT}(x) = A_{IT}(x * 0) \geq A_{IT}(0)$, $A_{IF}(x) = A_{IF}(x * 0) \leq A_{IF}(0)$, and $A_F(x) = A_F(x * 0) \leq A_F(0)$. It follows from Proposition 4.7 that $A_T(x) = A_T(0)$, $A_{IT}(x) = A_{IT}(0)$, $A_{IF}(x) = A_{IF}(0)$ and $A_F(x) = A_F(0)$ for all $x \in X$. Hence $A = (A_T, A_{IT}, A_{IF}, A_F)$ is constant on X . \square

A mapping $f : X \rightarrow Y$ of *BCK/BCI*-algebras is called a *homomorphism* (?) if $f(x * y) = f(x) * f(y)$ for all $x, y \in X$. Note that if $f : X \rightarrow Y$ is a homomorphism, then $f(0) = 0$. Let $f : X \rightarrow Y$ be a homomorphism of *BCK/BCI*-algebras. For any GNS $A = (A_T, A_{IT}, A_{IF}, A_F)$ in Y , we define a new GNS $A^f = (A_T^f, A_{IT}^f, A_{IF}^f, A_F^f)$ in X , which is called the *induced GNS*, by

$$(\forall x \in X) \left(\begin{array}{l} A_T^f(x) = A_T(f(x)), \quad A_{IT}^f(x) = A_{IT}(f(x)) \\ A_{IF}^f(x) = A_{IF}(f(x)), \quad A_F^f(x) = A_F(f(x)) \end{array} \right). \quad (4.3)$$

Theorem 4.10. *Let $f : X \rightarrow Y$ be a homomorphism of *BCK/BCI*-algebras. If a GNS $A = (A_T, A_{IT}, A_{IF}, A_F)$ in Y is a generalized neutrosophic subalgebra of Y , then the induced GNS $A^f = (A_T^f, A_{IT}^f, A_{IF}^f, A_F^f)$ in X is a generalized neutrosophic subalgebra of X .*

Proof. For any $x, y \in X$, we have

$$\begin{aligned} A_T^f(x * y) &= A_T(f(x * y)) = A_T(f(x) * f(y)) \\ &\geq A_T(f(x)) \wedge A_T(f(y)) = A_T^f(x) \wedge A_T^f(y), \end{aligned}$$

$$\begin{aligned} A_{IT}^f(x * y) &= A_{IT}(f(x * y)) = A_{IT}(f(x) * f(y)) \\ &\geq A_{IT}(f(x)) \wedge A_{IT}(f(y)) = A_{IT}^f(x) \wedge A_{IT}^f(y), \end{aligned}$$

$$\begin{aligned} A_{IF}^f(x * y) &= A_{IF}(f(x * y)) = A_{IF}(f(x) * f(y)) \\ &\leq A_{IF}(f(x)) \vee A_{IF}(f(y)) = A_{IF}^f(x) \vee A_{IF}^f(y), \end{aligned}$$

and

$$\begin{aligned} A_F^f(x * y) &= A_F(f(x * y)) = A_F(f(x) * f(y)) \\ &\leq A_F(f(x)) \vee A_F(f(y)) = A_F^f(x) \vee A_F^f(y). \end{aligned}$$

Therefore $A^f = (A_T^f, A_{IT}^f, A_{IF}^f, A_F^f)$ is a generalized neutrosophic subalgebra of X . \square

Theorem 4.11. *Let $f : X \rightarrow Y$ be an onto homomorphism of BCK/BCI-algebras and let $A = (A_T, A_{IT}, A_{IF}, A_F)$ be a GNS in Y . If the induced GNS $A^f = (A_T^f, A_{IT}^f, A_{IF}^f, A_F^f)$ in X is a generalized neutrosophic subalgebra of X , then $A = (A_T, A_{IT}, A_{IF}, A_F)$ is a generalized neutrosophic subalgebra of Y .*

Proof. Let $x, y \in Y$. Then $f(a) = x$ and $f(b) = y$ for some $a, b \in X$. Then

$$\begin{aligned} A_T(x * y) &= A_T(f(a) * f(b)) = A_T(f(a * b)) = A_T^f(a * b) \\ &\geq A_T^f(a) \wedge A_T^f(b) = A_T(f(a)) \wedge A_T(f(b)) \\ &= A_T(x) \wedge A_T(y), \end{aligned}$$

$$\begin{aligned} A_{IT}(x * y) &= A_{IT}(f(a) * f(b)) = A_{IT}(f(a * b)) = A_{IT}^f(a * b) \\ &\geq A_{IT}^f(a) \wedge A_{IT}^f(b) = A_{IT}(f(a)) \wedge A_{IT}(f(b)) \\ &= A_{IT}(x) \wedge A_{IT}(y), \end{aligned}$$

$$\begin{aligned} A_{IF}(x * y) &= A_{IF}(f(a) * f(b)) = A_{IF}(f(a * b)) = A_{IF}^f(a * b) \\ &\leq A_{IF}^f(a) \vee A_{IF}^f(b) = A_{IF}(f(a)) \vee A_{IF}(f(b)) \\ &= A_{IF}(x) \vee A_{IF}(y), \end{aligned}$$

and

$$\begin{aligned} A_F(x * y) &= A_F(f(a) * f(b)) = A_F(f(a * b)) = A_F^f(a * b) \\ &\leq A_F^f(a) \vee A_F^f(b) = A_F(f(a)) \vee A_F(f(b)) \\ &= A_F(x) \vee A_F(y). \end{aligned}$$

Hence $A = (A_T, A_{IT}, A_{IF}, A_F)$ is a generalized neutrosophic subalgebra of Y . □

Definition 4.12. A GNS $A = (A_T, A_{IT}, A_{IF}, A_F)$ in X is called a *generalized neutrosophic ideal* of X if the following conditions are valid.

$$(\forall x \in X) \left(\begin{array}{l} A_T(0) \geq A_T(x), A_{IT}(0) \geq A_{IT}(x) \\ A_{IF}(0) \leq A_{IF}(x), A_F(0) \leq A_F(x) \end{array} \right), \quad (4.4)$$

$$(\forall x, y \in X) \left(\begin{array}{l} A_T(x) \geq A_T(x * y) \wedge A_T(y) \\ A_{IT}(x) \geq A_{IT}(x * y) \wedge A_{IT}(y) \\ A_{IF}(x) \leq A_{IF}(x * y) \vee A_{IF}(y) \\ A_F(x) \leq A_F(x * y) \vee A_F(y) \end{array} \right). \quad (4.5)$$

Example 4.13. Consider a BCK-algebra $X = \{0, 1, 2, 3\}$ with the Cayley table which is given in Table 2.

Table 2: Cayley table for the binary operation “*”

*	0	1	2	3	4
0	0	0	0	0	0
1	1	0	1	0	0
2	2	2	0	0	0
3	3	3	3	0	0
4	4	3	4	1	0

Let

$$A = \{\langle 0; 0.8, 0.7, 0.2, 0.1 \rangle, \langle 1; 0.3, 0.6, 0.2, 0.6 \rangle, \langle 2; 0.8, 0.4, 0.5, 0.3 \rangle, \langle 3; 0.3, 0.2, 0.7, 0.8 \rangle, \langle 4; 0.3, 0.2, 0.7, 0.8 \rangle\}.$$

be a GNS in X . By routine calculations, we know that A is a generalized neutrosophic ideal of X .

Lemma 4.14. *Every generalized neutrosophic ideal $A = (A_T, A_{IT}, A_{IF}, A_F)$ of X satisfies:*

$$(\forall x, y \in X) \left(x \leq y \Rightarrow \begin{cases} A_T(x) \geq A_T(y), & A_{IT}(x) \geq A_{IT}(y) \\ A_{IF}(x) \leq A_{IF}(y), & A_F(x) \leq A_F(y) \end{cases} \right). \quad (4.6)$$

Proof. Let $x, y \in X$ be such that $x \leq y$. Then $x * y = 0$, and so

$$\begin{aligned} A_T(x) &\geq A_T(x * y) \wedge A_T(y) = A_T(0) \wedge A_T(y) = A_T(y), \\ A_{IT}(x) &\geq A_{IT}(x * y) \wedge A_{IT}(y) = A_{IT}(0) \wedge A_{IT}(y) = A_{IT}(y), \\ A_{IF}(x) &\leq A_{IF}(x * y) \vee A_{IF}(y) = A_{IF}(0) \vee A_{IF}(y) = A_{IF}(y), \\ A_F(x) &\leq A_F(x * y) \vee A_F(y) = A_F(0) \vee A_F(y) = A_F(y). \end{aligned}$$

This completes the proof. □

Lemma 4.15. *Let $A = (A_T, A_{IT}, A_{IF}, A_F)$ be a generalized neutrosophic ideal of X . If the inequality $x * y \leq z$ holds in X , then $A_T(x) \geq A_T(y) \wedge A_T(z)$, $A_{IT}(x) \geq A_{IT}(y) \wedge A_{IT}(z)$, $A_{IF}(x) \leq A_{IF}(y) \vee A_{IF}(z)$ and $A_F(x) \leq A_F(y) \vee A_F(z)$.*

Proof. Let $x, y, z \in X$ be such that $x * y \leq z$, Then $(x * y) * z = 0$, and so

$$\begin{aligned} A_T(x) &\geq \bigwedge \{A_T(x * y), A_T(y)\} \\ &\geq \bigwedge \left\{ \bigwedge \{A_T((x * y) * z), A_T(z)\}, A_T(y) \right\} \\ &= \bigwedge \left\{ \bigwedge \{A_T(0), A_T(z)\}, A_T(y) \right\} \\ &= \bigwedge \{A_T(y), A_T(z)\}, \end{aligned}$$

$$\begin{aligned}
 A_{IT}(x) &\geq \bigwedge \{A_{IT}(x * y), A_{IT}(y)\} \\
 &\geq \bigwedge \left\{ \bigwedge \{A_{IT}((x * y) * z), A_{IT}(z)\}, A_{IT}(y) \right\} \\
 &= \bigwedge \left\{ \bigwedge \{A_{IT}(0), A_{IT}(z)\}, A_{IT}(y) \right\} \\
 &= \bigwedge \{A_{IT}(y), A_{IT}(z)\},
 \end{aligned}$$

$$\begin{aligned}
 A_{IF}(x) &\leq \bigvee \{A_{IF}(x * y), A_{IF}(y)\} \\
 &\leq \bigvee \left\{ \bigvee \{A_{IF}((x * y) * z), A_{IF}(z)\}, A_{IF}(y) \right\} \\
 &= \bigvee \left\{ \bigvee \{A_{IF}(0), A_{IF}(z)\}, A_{IF}(y) \right\} \\
 &= \bigvee \{A_{IF}(y), A_{IF}(z)\},
 \end{aligned}$$

and

$$\begin{aligned}
 A_F(x) &\leq \bigvee \{A_F(x * y), A_F(y)\} \\
 &\leq \bigvee \left\{ \bigvee \{A_F((x * y) * z), A_F(z)\}, A_F(y) \right\} \\
 &= \bigvee \left\{ \bigvee \{A_F(0), A_F(z)\}, A_F(y) \right\} \\
 &= \bigvee \{A_F(y), A_F(z)\}.
 \end{aligned}$$

This completes the proof. □

Proposition 4.16. *Let $A = (A_T, A_{IT}, A_{IF}, A_F)$ be a generalized neutrosophic ideal of X . If the inequality*

$$(\cdots ((x * a_1) * a_2) * \cdots) * a_n = 0$$

holds in X , then

$$\begin{aligned}
 A_T(x) &\geq \bigwedge \{A_T(a_i) \mid i = 1, 2, \dots, n\}, \\
 A_{IT}(x) &\geq \bigwedge \{A_{IT}(a_i) \mid i = 1, 2, \dots, n\}, \\
 A_{IF}(x) &\leq \bigvee \{A_{IF}(a_i) \mid i = 1, 2, \dots, n\}, \\
 A_F(x) &\leq \bigvee \{A_F(a_i) \mid i = 1, 2, \dots, n\}.
 \end{aligned}$$

Proof. It is straightforward by using induction on n and Lemmas 4.14 and 4.15. □

Theorem 4.17. *In a BCK-algebra X , every generalized neutrosophic ideal is a generalized neutrosophic subalgebra.*

Proof. Let $A = (A_T, A_{IT}, A_{IF}, A_F)$ be a generalized neutrosophic ideal of a BCK -algebra X . Since $x * y \leq x$ for all $x, y \in X$, we have $A_T(x * y) \geq A_T(x)$, $A_{IT}(x * y) \geq A_{IT}(x)$, $A_{IF}(x * y) \leq A_{IF}(x)$ and $A_F(x * y) \leq A_F(x)$ by Lemma 4.14. It follows from (4.5) that

$$A_T(x * y) \geq A_T(x) \geq A_T(x * y) \wedge A_T(y) \geq A_T(x) \wedge A_T(y),$$

$$A_{IT}(x * y) \geq A_{IT}(x) \geq A_{IT}(x * y) \wedge A_{IT}(y) \geq A_{IT}(x) \wedge A_{IT}(y),$$

$$A_{IF}(x * y) \leq A_{IF}(x) \leq A_{IF}(x * y) \vee A_{IF}(y) \leq A_{IF}(x) \vee A_{IF}(y),$$

and

$$A_F(x * y) \leq A_F(x) \leq A_F(x * y) \vee A_F(y) \leq A_F(x) \vee A_F(y).$$

Therefore $A = (A_T, A_{IT}, A_{IF}, A_F)$ is a generalized neutrosophic subalgebra of X . □

The converse of Theorem 4.17 is not true. For example, the generalized neutrosophic subalgebra A in Example 4.2 is not a generalized neutrosophic ideal of X since

$$A_T(2) = 0.4 \not\geq 0.6 = A_T(2 * 1) \wedge A_T(1)$$

and/or

$$A_F(2) = 0.7 \not\leq 0.3 = A_F(2 * 1) \vee A_F(1).$$

We give a condition for a generalized neutrosophic subalgebra to be a generalized neutrosophic ideal.

Theorem 4.18. *Let $A = (A_T, A_{IT}, A_{IF}, A_F)$ be a generalized neutrosophic subalgebra of X such that*

$$\begin{aligned} A_T(x) &\geq A_T(y) \wedge A_T(z), \\ A_{IT}(x) &\geq A_{IT}(y) \wedge A_{IT}(z), \\ A_{IF}(x) &\leq A_{IF}(y) \vee A_{IF}(z), \\ A_F(x) &\leq A_F(y) \vee A_F(z) \end{aligned}$$

*for all $x, y, z \in X$ satisfying the inequality $x * y \leq z$. Then $A = (A_T, A_{IT}, A_{IF}, A_F)$ is a generalized neutrosophic ideal of X .*

Proof. Recall that $A_T(0) \geq A_T(x)$, $A_{IT}(0) \geq A_{IT}(x)$, $A_{IF}(0) \leq A_{IF}(x)$ and $A_F(0) \leq A_F(x)$ for all $x \in X$ by Proposition 4.7. Let $x, y \in X$. Since $x * (x * y) \leq y$, it follows from the hypothesis that

$$\begin{aligned} A_T(x) &\geq A_T(x * y) \wedge A_T(y), \\ A_{IT}(x) &\geq A_{IT}(x * y) \wedge A_{IT}(y), \\ A_{IF}(x) &\leq A_{IF}(x * y) \vee A_{IF}(y), \\ A_F(x) &\leq A_F(x * y) \vee A_F(y). \end{aligned}$$

Hence $A = (A_T, A_{IT}, A_{IF}, A_F)$ is a generalized neutrosophic ideal of X . □

Theorem 4.19. *A GNS $A = (A_T, A_{IT}, A_{IF}, A_F)$ in X is a generalized neutrosophic ideal of X if and only if the fuzzy sets A_T, A_{IT}, A_{IF}^c and A_F^c are fuzzy ideals of X .*

Proof. Assume that $A = (A_T, A_{IT}, A_{IF}, A_F)$ is a generalized neutrosophic ideal of X . Clearly, A_T and A_{IT} are fuzzy ideals of X . For every $x, y \in X$, we have

$$A_{IF}^c(0) = 1 - A_{IF}(0) \geq 1 - A_{IF}(x) = A_{IF}^c(x),$$

$$A_F^c(0) = 1 - A_F(0) \geq 1 - A_F(x) = A_F^c(x),$$

$$\begin{aligned} A_{IF}^c(x) &= 1 - A_{IF}(x) \geq 1 - A_{IF}(x * y) \vee A_{IF}(y) \\ &= \bigwedge \{1 - A_{IF}(x * y), 1 - A_{IF}(y)\} \\ &= \bigwedge \{A_{IF}^c(x * y), A_{IF}^c(y)\} \end{aligned}$$

and

$$\begin{aligned} A_F^c(x) &= 1 - A_F(x) \geq 1 - A_F(x * y) \vee A_F(y) \\ &= \bigwedge \{1 - A_F(x * y), 1 - A_F(y)\} \\ &= \bigwedge \{A_F^c(x * y), A_F^c(y)\}. \end{aligned}$$

Therefore A_T, A_{IT}, A_{IF}^c and A_F^c are fuzzy ideals of X .

Conversely, let $A = (A_T, A_{IT}, A_{IF}, A_F)$ be a GNS in X for which A_T, A_{IT}, A_{IF}^c and A_F^c are fuzzy ideals of X . For every $x \in X$, we have $A_T(0) \geq A_T(x), A_{IT}(0) \geq A_{IT}(x),$

$$1 - A_{IF}(0) = A_{IF}^c(0) \geq A_{IF}^c(x) = 1 - A_{IF}(x), \text{ that is, } A_{IF}(0) \leq A_{IF}(x)$$

and

$$1 - A_F(0) = A_F^c(0) \geq A_F^c(x) = 1 - A_F(x), \text{ that is, } A_F(0) \leq A_F(x).$$

Let $x, y \in X$. Then

$$A_T(x) \geq A_T(x * y) \wedge A_T(y),$$

$$A_{IT}(x) \geq A_{IT}(x * y) \wedge A_{IT}(y),$$

$$\begin{aligned} 1 - A_{IF}(x) &= A_{IF}^c(x) \geq A_{IF}^c(x * y) \wedge A_{IF}^c(y) \\ &= \bigwedge \{1 - A_{IF}(x * y), 1 - A_{IF}(y)\} \\ &= 1 - \bigvee \{A_{IF}(x * y), A_{IF}(y)\}, \end{aligned}$$

and

$$\begin{aligned} 1 - A_F(x) &= A_F^c(x) \geq A_F^c(x * y) \wedge A_F^c(y) \\ &= \bigwedge \{1 - A_F(x * y), 1 - A_F(y)\} \\ &= 1 - \bigvee \{A_F(x * y), A_F(y)\}, \end{aligned}$$

that is, $A_{IF}(x) \leq A_{IF}(x * y) \vee A_{IF}(y)$ and $A_F(x) \leq A_F(x * y) \vee A_F(y)$. Hence $A = (A_T, A_{IT}, A_{IF}, A_F)$ is a generalized neutrosophic ideal of X . \square

Theorem 4.20. *If a GNS $A = (A_T, A_{IT}, A_{IF}, A_F)$ in X is a generalized neutrosophic ideal of X , then $\square A = (A_T, A_{IT}, A_{IT}^c, A_T^c)$ and $\diamond A = (A_{IF}^c, A_F^c, A_F, A_{IF})$ are generalized neutrosophic ideals of X .*

Proof. Assume that $A = (A_T, A_{IT}, A_{IF}, A_F)$ is a generalized neutrosophic ideal of X and let $x, y \in X$. Note that $\square A = (A_T, A_{IT}, A_{IT}^c, A_T^c)$ and $\diamond A = (A_{IF}^c, A_F^c, A_F, A_{IF})$ are GNSs in X . Let $x, y \in X$. Then

$$\begin{aligned} A_{IT}^c(x * y) &= 1 - A_{IT}(x * y) \leq 1 - \bigwedge \{A_{IT}(x), A_{IT}(y)\} \\ &= \bigvee \{1 - A_{IT}(x), 1 - A_{IT}(y)\} \\ &= \bigvee \{A_{IT}^c(x), A_{IT}^c(y)\}, \end{aligned}$$

$$\begin{aligned} A_T^c(x * y) &= 1 - A_T(x * y) \leq 1 - \bigwedge \{A_T(x), A_T(y)\} \\ &= \bigvee \{1 - A_T(x), 1 - A_T(y)\} \\ &= \bigvee \{A_T^c(x), A_T^c(y)\}, \end{aligned}$$

$$\begin{aligned} A_{IF}^c(x * y) &= 1 - A_{IF}(x * y) \geq 1 - \bigvee \{A_{IF}(x), A_{IF}(y)\} \\ &= \bigwedge \{1 - A_{IF}(x), 1 - A_{IF}(y)\} \\ &= \bigwedge \{A_{IF}^c(x), A_{IF}^c(y)\} \end{aligned}$$

and

$$\begin{aligned} A_F^c(x * y) &= 1 - A_F(x * y) \geq 1 - \bigvee \{A_F(x), A_F(y)\} \\ &= \bigwedge \{1 - A_F(x), 1 - A_F(y)\} \\ &= \bigwedge \{A_F^c(x), A_F^c(y)\}. \end{aligned}$$

Therefore $\square A = (A_T, A_{IT}, A_{IT}^c, A_T^c)$ and $\diamond A = (A_{IF}^c, A_F^c, A_F, A_{IF})$ are generalized neutrosophic ideals of X . \square

Theorem 4.21. *If a GNS $A = (A_T, A_{IT}, A_{IF}, A_F)$ is a generalized neutrosophic ideal of X , then the set $U(T, \alpha_T)$, $U(IT, \alpha_{IT})$, $L(F, \beta_F)$ and $L(IF, \beta_{IF})$ are ideals of X for all $\alpha_T, \alpha_{IT}, \beta_F, \beta_{IF} \in [0, 1]$ whenever they are non-empty.*

Proof. Assume that $U(T, \alpha_T)$, $U(IT, \alpha_{IT})$, $L(F, \beta_F)$ and $L(IF, \beta_{IF})$ are nonempty for all $\alpha_T, \alpha_{IT}, \beta_F, \beta_{IF} \in [0, 1]$. It is clear that $0 \in U(T, \alpha_T)$, $0 \in U(IT, \alpha_{IT})$, $0 \in L(F, \beta_F)$ and $0 \in L(IF, \beta_{IF})$. Let $x, y \in X$. If $x * y \in U(T, \alpha_T)$ and $y \in U(T, \alpha_T)$, then $A_T(x * y) \geq \alpha_T$ and $A_T(y) \geq \alpha_T$. Hence

$$A_T(x) \geq A_T(x * y) \wedge A_T(y) \geq \alpha_T,$$

and so $x \in U(T, \alpha_T)$. Similarly, if $x * y \in U(IT, \alpha_{IT})$ and $y \in U(IT, \alpha_{IT})$, then $x \in U(IT, \alpha_{IT})$. If $x * y \in L(F, \beta_F)$ and $y \in L(F, \beta_F)$, then $A_F(x * y) \leq \beta_F$ and $A_F(y) \leq \beta_F$. Hence

$$A_F(x) \leq A_F(x * y) \vee A_F(y) \leq \beta_F,$$

and so $x \in L(F, \beta_F)$. Similarly, if $x * y \in L(IF, \beta_{IF})$ and $y \in L(IF, \beta_{IF})$, then $x \in L(IF, \beta_{IF})$. This completes the proof. \square

Theorem 4.22. *Let $A = (A_T, A_{IT}, A_{IF}, A_F)$ be a GNS in X such that $U(T, \alpha_T)$, $U(IT, \alpha_{IT})$, $L(F, \beta_F)$ and $L(IF, \beta_{IF})$ are ideals of X for all $\alpha_T, \alpha_{IT}, \beta_F, \beta_{IF} \in [0, 1]$. Then $A = (A_T, A_{IT}, A_{IF}, A_F)$ is a generalized neutrosophic ideal of X .*

Proof. Let $\alpha_T, \alpha_{IT}, \beta_F, \beta_{IF} \in [0, 1]$ be such that $U(T, \alpha_T)$, $U(IT, \alpha_{IT})$, $L(F, \beta_F)$ and $L(IF, \beta_{IF})$ are ideals of X . For any $x \in X$, let $A_T(x) = \alpha_T$, $A_{IT}(x) = \alpha_{IT}$, $A_{IF}(x) = \beta_{IF}$ and $A_F(x) = \beta_F$. Since $0 \in U(T, \alpha_T)$, $0 \in U(IT, \alpha_{IT})$, $0 \in L(F, \beta_F)$ and $0 \in L(IF, \beta_{IF})$, we have $A_T(0) \geq \alpha_T = A_T(x)$, $A_{IT}(0) \geq \alpha_{IT} = A_{IT}(x)$, $A_{IF}(0) \leq \beta_{IF} = A_{IF}(x)$ and $A_F(0) \leq \beta_F = A_F(x)$. If there exist $a, b \in X$ such that $A_T(a * b) < A_T(a) \wedge A_T(b)$, then $a, b \in U(T, \alpha_0)$ and $a * b \notin U(T, \alpha_0)$ where $\alpha_0 := A_T(a) \wedge A_T(b)$. This is a contradiction, and hence $A_T(x * y) \geq A_T(x) \wedge A_T(y)$ for all $x, y \in X$. Similarly, we can verify $A_{IT}(x * y) \geq A_{IT}(x) \wedge A_{IT}(y)$ for all $x, y \in X$. Suppose that $A_{IF}(a * b) > A_{IF}(a) \vee A_{IF}(b)$ for some $a, b \in X$. Taking $\beta_0 := A_{IF}(a) \vee A_{IF}(b)$ induces $a, b \in L(IF, \beta_{IF})$ and $a * b \notin L(IF, \beta_{IF})$, a contradiction. Thus $A_{IF}(x * y) \leq A_{IF}(x) \vee A_{IF}(y)$ for all $x, y \in X$. Similarly we have $A_F(x * y) \leq A_F(x) \vee A_F(y)$ for all $x, y \in X$. Consequently, $A = (A_T, A_{IT}, A_{IF}, A_F)$ is a generalized neutrosophic ideal of X . \square

Let Λ be a nonempty subset of $[0, 1]$.

Theorem 4.23. *Let $\{I_t \mid t \in \Lambda\}$ be a collection of ideals of X such that*

- (1) $X = \bigcup_{t \in \Lambda} I_t$,
- (2) $(\forall s, t \in \Lambda) (s > t \iff I_s \subset I_t)$.

Let $A = (A_T, A_{IT}, A_{IF}, A_F)$ be a GNS in X given as follows:

$$(\forall x \in X) \begin{pmatrix} A_T(x) = \bigvee \{t \in \Lambda \mid x \in I_t\} = A_{IT}(x) \\ A_{IF}(x) = \bigwedge \{t \in \Lambda \mid x \in I_t\} = A_F(x) \end{pmatrix}. \quad (4.7)$$

Then $A = (A_T, A_{IT}, A_{IF}, A_F)$ is a generalized neutrosophic ideal of X .

Proof. According to Theorem 4.22, it is sufficient to show that $U(T, t)$, $U(IT, t)$, $L(F, s)$ and $L(IF, s)$ are ideals of X for every $t \in [0, A_T(0) = A_{IT}(0)]$ and $s \in [A_{IF}(0) = A_F(0), 1]$. In order to prove $U(T, t)$ and $U(IT, t)$ are ideals of X , we consider two cases:

(i) $t = \bigvee\{q \in \Lambda \mid q < t\}$,

(ii) $t \neq \bigvee\{q \in \Lambda \mid q < t\}$.

For the first case, we have

$$x \in U(T, t) \iff (\forall q < t)(x \in I_q) \iff x \in \bigcap_{q < t} I_q,$$

$$x \in U(IT, t) \iff (\forall q < t)(x \in I_q) \iff x \in \bigcap_{q < t} I_q.$$

Hence $U(T, t) = \bigcap_{q < t} I_q = U(IT, t)$, and so $U(T, t)$ and $U(IT, t)$ are ideals of X . For the second case, we claim that $U(T, t) = \bigcup_{q \geq t} I_q = U(IT, t)$. If $x \in \bigcup_{q \geq t} I_q$, then $x \in I_q$ for some $q \geq t$. It follows that $A_{IT}(x) = A_T(x) \geq q \geq t$ and so that $x \in U(T, t)$ and $x \in U(IT, t)$. This shows that $\bigcup_{q \geq t} I_q \subseteq U(T, t) = U(IT, t)$. Now, assume that $x \notin \bigcup_{q \geq t} I_q$. Then $x \notin I_q$ for all $q \geq t$. Since $t \neq \bigvee\{q \in \Lambda \mid q < t\}$, there exists $\varepsilon > 0$ such that $(t - \varepsilon, t) \cap \Lambda = \emptyset$. Hence $x \notin I_q$ for all $q > t - \varepsilon$, which means that if $x \in I_q$, then $q \leq t - \varepsilon$. Thus $A_{IT}(x) = A_T(x) \leq t - \varepsilon < t$, and so $x \notin U(T, t) = U(IT, t)$. Therefore $U(T, t) = U(IT, t) \subseteq \bigcup_{q \geq t} I_q$. Consequently, $U(T, t) = U(IT, t) = \bigcup_{q \geq t} I_q$ which is an ideal of X . Next we show that $L(F, s)$ and $L(IF, s)$ are ideals of X . We consider two cases as follows:

(iii) $s = \bigwedge\{r \in \Lambda \mid s < r\}$,

(iv) $s \neq \bigwedge\{r \in \Lambda \mid s < r\}$.

Case (iii) implies that

$$x \in L(IF, s) \iff (\forall s < r)(x \in I_r) \iff x \in \bigcap_{s < r} I_r,$$

$$x \in U(F, s) \iff (\forall s < r)(x \in I_r) \iff x \in \bigcap_{s < r} I_r.$$

It follows that $L(IF, s) = L(F, s) = \bigcap_{s < r} I_r$, which is an ideal of X . Case (iv) induces $(s, s + \varepsilon) \cap \Lambda = \emptyset$ for some $\varepsilon > 0$. If $x \in \bigcup_{s \geq r} I_r$, then $x \in I_r$ for some $r \leq s$, and so $A_{IF}(x) = A_F(x) \leq r \leq s$, that is, $x \in L(IF, s)$ and $x \in L(F, s)$. Hence $\bigcup_{s \geq r} I_r \subseteq L(IF, s) = L(F, s)$. If $x \notin \bigcup_{s \geq r} I_r$, then $x \notin I_r$ for all $r \leq s$ which implies that $x \notin I_r$ for all $r \leq s + \varepsilon$, that is, if $x \in I_r$ then $r \geq s + \varepsilon$. Hence $A_{IF}(x) = A_F(x) \geq s + \varepsilon > s$, and so $x \notin L(A_{IF}, s) = L(A_F, s)$. Hence $L(A_{IF}, s) = L(A_F, s) = \bigcup_{s \geq r} I_r$ which is an ideal of X . This completes the proof. \square

Theorem 4.24. *Let $f : X \rightarrow Y$ be a homomorphism of BCK/BCI-algebras. If a GNS $A = (A_T, A_{IT}, A_{IF}, A_F)$ in Y is a generalized neutrosophic ideal of Y , then the new GNS $A^f = (A_T^f, A_{IT}^f, A_{IF}^f, A_F^f)$ in X is a generalized neutrosophic ideal of X .*

Proof. We first have

$$\begin{aligned} A_T^f(0) &= A_T(f(0)) = A_T(0) \geq A_T(f(x)) = A_T^f(x), \\ A_{IT}^f(0) &= A_{IT}(f(0)) = A_{IT}(0) \geq A_{IT}(f(x)) = A_{IT}^f(x), \\ A_{IF}^f(0) &= A_{IF}(f(0)) = A_{IF}(0) \leq A_{IF}(f(x)) = A_{IF}^f(x), \\ A_F^f(0) &= A_F(f(0)) = A_F(0) \leq A_F(f(x)) = A_F^f(x) \end{aligned}$$

for all $x \in X$. Let $x, y \in X$. Then

$$\begin{aligned} A_T^f(x) &= A_T(f(x)) \geq A_T(f(x) * f(y)) \wedge A_T(f(y)) \\ &= A_T(f(x * y)) \wedge A_T(f(y)) \\ &= A_T^f(x * y) \wedge A_T^f(y), \end{aligned}$$

$$\begin{aligned} A_{IT}^f(x) &= A_{IT}(f(x)) \geq A_{IT}(f(x) * f(y)) \wedge A_{IT}(f(y)) \\ &= A_{IT}(f(x * y)) \wedge A_{IT}(f(y)) \\ &= A_{IT}^f(x * y) \wedge A_{IT}^f(y), \end{aligned}$$

$$\begin{aligned} A_{IF}^f(x) &= A_{IF}(f(x)) \leq A_{IF}(f(x) * f(y)) \vee A_{IF}(f(y)) \\ &= A_{IF}(f(x * y)) \vee A_{IF}(f(y)) \\ &= A_{IF}^f(x * y) \vee A_{IF}^f(y) \end{aligned}$$

and

$$\begin{aligned} A_F^f(x) &= A_F(f(x)) \leq A_F(f(x) * f(y)) \vee A_F(f(y)) \\ &= A_F(f(x * y)) \vee A_F(f(y)) \\ &= A_F^f(x * y) \vee A_F^f(y). \end{aligned}$$

Therefore $A^f = (A_T^f, A_{IT}^f, A_{IF}^f, A_F^f)$ in X is a generalized neutrosophic ideal of X . □

Theorem 4.25. *Let $f : X \rightarrow Y$ be an onto homomorphism of BCK/BCI-algebras and let $A = (A_T, A_{IT}, A_{IF}, A_F)$ be a GNS in Y . If the induced GNS $A^f = (A_T^f, A_{IT}^f, A_{IF}^f, A_F^f)$ in X is a generalized neutrosophic ideal of X , then $A = (A_T, A_{IT}, A_{IF}, A_F)$ is a generalized neutrosophic ideal of Y .*

Proof. For any $x \in Y$, there exists $a \in X$ such that $f(a) = x$. Then

$$\begin{aligned} A_T(0) &= A_T(f(0)) = A_T^f(0) \geq A_T^f(a) = A_T(f(a)) = A_T(x), \\ A_{IT}(0) &= A_{IT}(f(0)) = A_{IT}^f(0) \geq A_{IT}^f(a) = A_{IT}(f(a)) = A_{IT}(x), \\ A_{IF}(0) &= A_{IF}(f(0)) = A_{IF}^f(0) \leq A_{IF}^f(a) = A_{IF}(f(a)) = A_{IF}(x), \\ A_F(0) &= A_F(f(0)) = A_F^f(0) \leq A_F^f(a) = A_F(f(a)) = A_F(x). \end{aligned}$$

Let $x, y \in Y$. Then $f(a) = x$ and $f(b) = y$ for some $a, b \in X$. It follows that

$$\begin{aligned} A_T(x) &= A_T(f(a)) = A_T^f(a) \\ &\geq A_T^f(a * b) \wedge A_T^f(b) \\ &= A_T(f(a * b)) \wedge A_T(f(b)) \\ &= A_T(f(a) * f(b)) \wedge A_T(f(b)) \\ &= A_T(x * y) \wedge A_T(y), \end{aligned}$$

$$\begin{aligned} A_{IT}(x) &= A_{IT}(f(a)) = A_{IT}^f(a) \\ &\geq A_{IT}^f(a * b) \wedge A_{IT}^f(b) \\ &= A_{IT}(f(a * b)) \wedge A_{IT}(f(b)) \\ &= A_{IT}(f(a) * f(b)) \wedge A_{IT}(f(b)) \\ &= A_{IT}(x * y) \wedge A_{IT}(y), \end{aligned}$$

$$\begin{aligned} A_{IF}(x) &= A_{IF}(f(a)) = A_{IF}^f(a) \\ &\leq A_{IF}^f(a * b) \vee A_{IF}^f(b) \\ &= A_{IF}(f(a * b)) \vee A_{IF}(f(b)) \\ &= A_{IF}(f(a) * f(b)) \vee A_{IF}(f(b)) \\ &= A_{IF}(x * y) \vee A_{IF}(y), \end{aligned}$$

and

$$\begin{aligned} A_F(x) &= A_F(f(a)) = A_F^f(a) \\ &\leq A_F^f(a * b) \vee A_F^f(b) \\ &= A_F(f(a * b)) \vee A_F(f(b)) \\ &= A_F(f(a) * f(b)) \vee A_F(f(b)) \\ &= A_F(x * y) \vee A_F(y). \end{aligned}$$

Therefore $A = (A_T, A_{IT}, A_{IF}, A_F)$ is a generalized neutrosophic ideal of Y . □

REFERENCES

- Abdel-Basset, M., Mohamed, M., Smarandache, F., & Chang, V. (2018). Neutrosophic Association Rule Mining Algorithm for Big Data Analysis. *Symmetry*, 10(4), 106.
- Abdel-Basset, M., & Mohamed, M. (2018). The Role of Single Valued Neutrosophic Sets and Rough Sets in Smart City: Imperfect and Incomplete Information Systems. Measurement. Volume 124, August 2018, Pages 47-55
- Abdel-Basset, M., Gunasekaran, M., Mohamed, M., & Smarandache, F. A novel method for solving the fully neutrosophic linear programming problems. *Neural Computing and Applications*, 1-11.
- Abdel-Basset, M., Manogaran, G., Gamal, A., & Smarandache, F. (2018). A hybrid approach of neutrosophic sets and DEMATEL method for developing supplier selection criteria. *Design Automation for Embedded Systems*, 1-22.
- Abdel-Basset, M., Mohamed, M., & Chang, V. (2018). NMCDA: A framework for evaluating cloud computing services. *Future Generation Computer Systems*, 86, 12-29.
- Abdel-Basset, M., Mohamed, M., Zhou, Y., & Hezam, I. (2017). Multi-criteria group decision making based on neutrosophic analytic hierarchy process. *Journal of Intelligent & Fuzzy Systems*, 33(6), 4055-4066.
- Abdel-Basset, M.; Mohamed, M.; Smarandache, F. An Extension of Neutrosophic AHP–SWOT Analysis for Strategic Planning and Decision-Making. *Symmetry* 2018, 10, 116.
- Agboola, A. A. A., & Davvaz, B. (2015). Introduction to neutrosophic BCI/BCK -algebras. *International Journal of Mathematics and Mathematical Sciences*. doi: 10.1155/2015/370267
- Atanassov, K. (1986). Intuitionistic fuzzy sets. *Fuzzy Sets and Systems*, 20(1), 87–96.
- Huang, Y. S. (2006). *BCI-algebra*. Beijing: Science Press.
- Jun, Y. B. (2017). Neutrosophic subalgebras of several types in BCK/BCI -algebras. *Annals of Fuzzy Mathematics and Informatics*, 14(1), 75–86.
- Meng, J., & Jun, Y. B. (1994). *BCK-algebras*. Seoul: Kyung Moon Sa Co.
- Saeid, A. B., & Y.B, J. (2017). Neutrosophic subalgebras of BCK/BCI -algebras based on neutrosophic points. *Annals of Fuzzy Mathematics and Informatics*, 14(1), 87–97.
- Smarandache, F. (1999). *A unifying field in logics. Neutrosophy: Neutrosophic probability, set and logic*. Rehoboth: American Research Press.
- Smarandache, F. (2005). Neutrosophic set, a generalization of intuitionistic fuzzy sets. *International Journal of Pure and Applied Mathematics*, 24(5), 287–297.
- Zadeh, L. (1965). Fuzzy sets. *Information and Control*, 8(3), 338–353.

Neutrosophic Resolvable and Neutrosophic Irresolvable Spaces

¹*M. Caldas, ²R. Dhavaseelan, ³M. Ganster and ⁴S. Jafari

¹Departamento De Matematica, Universidade Federal Fluminense, Rua Mario Santos Braga, s/N, 24020-140, Niteroi, RJ BRASIL.

²Department of Mathematics, Sona College of Technology, Salem-636005, Tamil Nadu, INDIA.

³Department of Mathematics, Graz University of Technology Steyrergasse 30, 8010 Graz, AUSTRIA.

⁴College of Vestsjaelland South, Herrestraede 11, 4200 Slagelse, DENMARK.

e-mail : gmamccs@vm.uff.br, dhavaseelan.r@gmail.com, ganster@weyl.math.tu-graz.ac.at, jafaripersia@gmail.com

ABSTRACT

In this paper, the concepts of neutrosophic resolvable, neutrosophic irresolvable, neutrosophic open hereditarily irresolvable spaces and maximally neutrosophic irresolvable spaces are introduced. Also we study several properties of the neutrosophic open hereditarily irresolvable spaces besides giving characterization of these spaces by means of somewhat neutrosophic continuous functions and somewhat neutrosophic open functions.

KEYWORDS: Neutrosophic resolvable, neutrosophic irresolvable, neutrosophic submaximal, neutrosophic open hereditarily irresolvable space, somewhat neutrosophic continuous and somewhat neutrosophic open functions.

1 INTRODUCTION

Zadeh (1965) introduced the important and useful concept of a fuzzy set which has invaded almost all branches of mathematics. The theory of fuzzy topological spaces was introduced and developed by Chang (1968) and since then various notions in classical topology have been extended to fuzzy topological spaces. The idea of “intuitionistic fuzzy set” was first published by Atanasov (1983) and some research works appeared in the literature (Atanassov (1986, 1988); Atanassov and Stoeva (1983)). Smarandache introduced the concepts of neutrosophy and neutrosophic set (Smarandache, (1999, 2002)). The concepts of neutrosophic crisp sets and neutrosophic crisp topological spaces were introduced by Salama and Alblowi (2012). The concept of fuzzy resolvable and fuzzy irresolvable spaces were introduced by G. Thangaraj and G.

Balasubramanian (2009). The concepts of resolvability and irresolvability in intuitionistic fuzzy topological spaces were introduced by Dhavaseelan et al. (2011).

In this paper, the concepts of neutrosophic resolvable, neutrosophic irresolvable, neutrosophic open hereditarily irresolvable spaces and maximally neutrosophic irresolvable spaces are introduced. Further, we study several interesting properties of the neutrosophic open hereditarily irresolvable spaces and present characterizations of these spaces by means of somewhat neutrosophic continuous functions and somewhat neutrosophic open functions. Some basic properties and related examples are given.

2 PRELIMINARIES

Definition 2.1. (Smarandache, (1999, 2002)) Let T, I, F be real standard or non standard subsets of $]0^-, 1^+[$, with $sup_T = t_{sup}, inf_T = t_{inf}$
 $sup_I = i_{sup}, inf_I = i_{inf}$
 $sup_F = f_{sup}, inf_F = f_{inf}$
 $n - sup = t_{sup} + i_{sup} + f_{sup}$
 $n - inf = t_{inf} + i_{inf} + f_{inf}$. T, I, F are neutrosophic components.

Definition 2.2. (Smarandache, (1999, 2002)) Let X be a nonempty fixed set. A neutrosophic set A is an object having the form $A = \{ \langle x, \mu_A(x), \sigma_A(x), \gamma_A(x) \rangle : x \in X \}$, where $\mu_A(x), \sigma_A(x)$ and $\gamma_A(x)$ represents the degree of membership function (i.e., $\mu_A(x)$), the degree of indeterminacy (namely $\sigma_A(x)$) and the degree of nonmembership (i.e., $\gamma_A(x)$) of each element $x \in X$ to the set A , respectively.

Remark 2.1. (Smarandache, (1999, 2002))

- (1) A neutrosophic set $A = \{ \langle x, \mu_A(x), \sigma_A(x), \gamma_A(x) \rangle : x \in X \}$ can be identified to an ordered triple $\langle \mu_A, \sigma_A, \gamma_A \rangle$ in $]0^-, 1^+[$ on X .
- (2) For the sake of simplicity, we shall use the symbol $A = \langle \mu_A, \sigma_A, \gamma_A \rangle$ for the neutrosophic set $A = \{ \langle x, \mu_A(x), \sigma_A(x), \gamma_A(x) \rangle : x \in X \}$.

Definition 2.3. (Salama and Alblowi (2012)) Let X be a nonempty set and the neutrosophic sets A and B be in the form

$A = \{ \langle x, \mu_A(x), \sigma_A(x), \gamma_A(x) \rangle : x \in X \}$, $B = \{ \langle x, \mu_B(x), \sigma_B(x), \gamma_B(x) \rangle : x \in X \}$. Then

- (a) $A \subseteq B$ iff $\mu_A(x) \leq \mu_B(x)$, $\sigma_A(x) \leq \sigma_B(x)$ and $\gamma_A(x) \geq \gamma_B(x)$ for all $x \in X$;
- (b) $A = B$ iff $A \subseteq B$ and $B \subseteq A$;
- (c) $\bar{A} = \{ \langle x, \gamma_A(x), \sigma_A(x), \mu_A(x) \rangle : x \in X \}$; [Complement of A]
- (d) $A \cap B = \{ \langle x, \mu_A(x) \wedge \mu_B(x), \sigma_A(x) \wedge \sigma_B(x), \gamma_A(x) \vee \gamma_B(x) \rangle : x \in X \}$;
- (e) $A \cup B = \{ \langle x, \mu_A(x) \vee \mu_B(x), \sigma_A(x) \vee \sigma_B(x), \gamma_A(x) \wedge \gamma_B(x) \rangle : x \in X \}$;
- (f) $[A = \{ \langle x, \mu_A(x), \sigma_A(x), 1 - \mu_A(x) \rangle : x \in X \}$;
- (g) $\langle A = \{ \langle x, 1 - \gamma_A(x), \sigma_A(x), \gamma_A(x) \rangle : x \in X \}$.

Definition 2.4. (Salama and Alblowi (2012)) Let $\{A_i : i \in J\}$ be an arbitrary family of neutrosophic sets in X . Then

$$(a) \bigcap A_i = \{ \langle x, \wedge \mu_{A_i}(x), \wedge \sigma_{A_i}(x), \vee \gamma_{A_i}(x) \rangle : x \in X \}.$$

$$(b) \bigcup A_i = \{ \langle x, \vee \mu_{A_i}(x), \vee \sigma_{A_i}(x), \wedge \gamma_{A_i}(x) \rangle : x \in X \}.$$

Definition 2.5. (Salama and Alblowi (2012)) $0_N = \{ \langle x, 0, 0, 1 \rangle : x \in X \}$ and $1_N = \{ \langle x, 1, 1, 0 \rangle : x \in X \}$.

Definition 2.6. (Dhavaseelan and S. Jafari (20xx)) A neutrosophic topology (NT) on a nonempty set X is a family T of neutrosophic sets in X satisfying the following axioms:

$$(i) 0_N, 1_N \in T,$$

$$(ii) G_1 \cap G_2 \in T \text{ for any } G_1, G_2 \in T,$$

$$(iii) \bigcup G_i \in T \text{ for arbitrary family } \{G_i \mid i \in \Lambda\} \subseteq T.$$

In this case, the ordered pair (X, T) or simply X is called a neutrosophic topological space and each neutrosophic set in T is called a neutrosophic open set. The complement \bar{A} of a neutrosophic open set A in X is called a neutrosophic closed set in X .

Definition 2.7. [8] Let A be a neutrosophic set in a neutrosophic topological space X . Then

$Nint(A) = \bigcup \{G \mid G \text{ is a neutrosophic open set in } X \text{ and } G \subseteq A\}$ is called the neutrosophic interior of A ;

$Ncl(A) = \bigcap \{G \mid G \text{ is a neutrosophic closed set in } X \text{ and } G \supseteq A\}$ is called the neutrosophic closure of A .

Definition 2.8. [7] An intuitionistic fuzzy topological space (X, T) is called intuitionistic fuzzy resolvable if there exists an intuitionistic fuzzy dense set A in (X, T) such that $IFcl(\bar{A}) = 1_{\sim}$. Otherwise (X, T) is called intuitionistic fuzzy irresolvable.

3 NEUTROSOPHIC RESOLVABLE AND NEUTROSOPHIC IRRESOLVABLE

Definition 3.1. A neutrosophic set A in neutrosophic topological space (X, T) is called neutrosophic dense if there exists no neutrosophic closed set B in (X, T) such that $A \subset B \subset 1_N$

Definition 3.2. A neutrosophic topological space (X, T) is called neutrosophic resolvable if there exists a neutrosophic dense set A in (X, T) such that $Ncl(\bar{A}) = 1_N$. Otherwise (X, T) is called neutrosophic irresolvable.

Example 3.1. Let $X = \{a, b, c\}$. Define the neutrosophic sets A , B and C as follows.

$$A = \langle x, (\frac{a}{0.6}, \frac{b}{0.6}, \frac{c}{0.5}), (\frac{a}{0.6}, \frac{b}{0.6}, \frac{c}{0.5}), (\frac{a}{0.3}, \frac{b}{0.3}, \frac{c}{0.5}) \rangle,$$

$$B = \langle x, (\frac{a}{0.4}, \frac{b}{0.4}, \frac{c}{0.5}), (\frac{a}{0.4}, \frac{b}{0.4}, \frac{c}{0.5}), (\frac{a}{0.5}, \frac{b}{0.5}, \frac{c}{0.4}) \rangle,$$

and

$$C = \langle x, (\frac{a}{0.3}, \frac{b}{0.3}, \frac{c}{0.4}), (\frac{a}{0.3}, \frac{b}{0.3}, \frac{c}{0.4}), (\frac{a}{0.7}, \frac{b}{0.7}, \frac{c}{0.6}) \rangle.$$

Observe that $T = \{0_N, 1_N, A\}$ is a neutrosophic topology on X . Thus (X, T) is a neutrosophic topological space. Now $Nint(B) = 0_N, Nint(C) = 0_N, Nint(\overline{B}) = 0_N, Nint(\overline{C}) = A, Ncl(B) = 1_N, Ncl(C) = 1_N, Ncl(\overline{B}) = 1_N$ and $Ncl(\overline{C}) = \overline{A}$. Hence there exists a neutrosophic dense set B in (X, T) such that $Ncl(\overline{B}) = 1_N$. Therefore the neutrosophic topological space (X, T) is called a neutrosophic resolvable.

Example 3.2. Let $X = \{a, b, c\}$. Define the neutrosophic sets A, B and C as follows.

$$A = \langle x, (\frac{a}{0.6}, \frac{b}{0.5}, \frac{c}{0.5}), (\frac{a}{0.6}, \frac{b}{0.5}, \frac{c}{0.5}), (\frac{a}{0.4}, \frac{b}{0.5}, \frac{c}{0.5}) \rangle,$$

$$B = \langle x, (\frac{a}{0.7}, \frac{b}{0.8}, \frac{c}{0.6}), (\frac{a}{0.7}, \frac{b}{0.8}, \frac{c}{0.6}), (\frac{a}{0.3}, \frac{b}{0.1}, \frac{c}{0.3}) \rangle,$$

and

$$C = \langle x, (\frac{a}{0.6}, \frac{b}{0.5}, \frac{c}{0.5}), (\frac{a}{0.6}, \frac{b}{0.5}, \frac{c}{0.5}), (\frac{a}{0.4}, \frac{b}{0.4}, \frac{c}{0.4}) \rangle.$$

It can be seen that $T = \{0_N, 1_N, A\}$ is a neutrosophic topology on X . Thus (X, T) is a neutrosophic topological space. Now $Nint(B) = A, Nint(C) = A, Ncl(B) = 1_N, Ncl(C) = 1_N$ and $Ncl(B) = 1_N$. Thus B and C are neutrosophic dense set in (X, T) such that $Ncl(\overline{B}) = \overline{A}$ and $Ncl(\overline{C}) = \overline{A}$. Hence the neutrosophic topological space (X, T) is called a neutrosophic irresolvable.

Proposition 3.1. A neutrosophic topological space (X, T) is a neutrosophic resolvable space iff (X, T) has a pair of neutrosophic dense set A_1 and A_2 such that $A_1 \subseteq \overline{A_2}$.

Proof. Let (X, T) be a neutrosophic topological space and (X, T) a neutrosophic resolvable space. Suppose that for all neutrosophic dense sets A_i and A_j , we have $A_i \not\subseteq \overline{A_j}$. Then $A_i \supset \overline{A_j}$. Then $Ncl(A_i) \supset Ncl(\overline{A_j})$ which implies that $1_N \supset Ncl(\overline{A_j})$. Then $Ncl(\overline{A_j}) \neq 1_N$. Also $A_j \supset \overline{A_i}$, then $Ncl(A_j) \supset Ncl(\overline{A_i})$ which implies that $1_N \supset Ncl(\overline{A_i})$. Therefore $Ncl(\overline{A_i}) \neq 1_N$. Hence $Ncl(A_i) = 1_N$, but $Ncl(\overline{A_i}) \neq 1_N$ for all neutrosophic set A_i in (X, T) which is a contradiction. Hence (X, T) has a pair of neutrosophic dense set A_1 and A_2 such that $A_1 \subseteq \overline{A_2}$.

Conversely, suppose that the neutrosophic topological space (X, T) has a pair of neutrosophic dense set A_1 and A_2 such that $A_1 \subseteq \overline{A_2}$. Suppose that (X, T) is a neutrosophic irresolvable space. Then for all neutrosophic dense sets A_1 and A_2 in (X, T) , we have $Ncl(\overline{A_1}) \neq 1_N$. Then $Ncl(\overline{A_2}) \neq 1_N$ implies that there exists a neutrosophic closed set B in (X, T) such that $\overline{A_2} \subset B \subset 1_N$. Then $A_1 \subseteq \overline{A_2} \subset B \subset 1_N$ implies that $A_1 \subset B \subset 1_N$. But this is a contradiction. Hence (X, T) is a neutrosophic resolvable space. \square

Proposition 3.2. If (X, T) is neutrosophic irresolvable iff $Nint(A) \neq 0_N$ for all neutrosophic dense set A in (X, T) .

Proof. Since (X, T) is a neutrosophic irresolvable space for all neutrosophic dense set A in (X, T) , $Ncl(\overline{A}) \neq 1_N$. Then $\overline{Nint(A)} \neq 1_N$ which implies $Nint(A) \neq 0_N$.

Conversely $Nint(A) \neq 0_N$, for all neutrosophic dense set A in (X, T) . Suppose that (X, T) is neutrosophic resolvable. Then there exists a neutrosophic dense set A in (X, T) such that $Ncl(\overline{A}) = 1_N$. This implies that $\overline{Nint(A)} = 1_N$ which again implies $Nint(A) = 0_N$. But this is a contradiction. Hence (X, T) is neutrosophic irresolvable space. \square

Definition 3.3. A neutrosophic topological space (X, T) is called a neutrosophic submaximal space if for each neutrosophic set A in (X, T) , $Ncl(A) = 1_N$.

Proposition 3.3. If the neutrosophic topological space (X, T) is neutrosophic submaximal, then (X, T) is neutrosophic irresolvable.

Proof. Let (X, T) be a neutrosophic submaximal space. Assume that (X, T) is a neutrosophic resolvable space. Let A be a neutrosophic dense set in (X, T) . Then $Ncl(\overline{A}) = 1_N$. Hence $\overline{Nint(A)} = 1_N$ which implies that $Nint(A) = 0_N$. Then $A \not\subseteq T$. This is a contradiction. Hence (X, T) is neutrosophic irresolvable space.

The converse of Proposition 3.3 is not true. See Example 3.2. □

Definition 3.4. A neutrosophic topological space (X, T) is called a maximal neutrosophic irresolvable space if (X, T) is neutrosophic irresolvable and every neutrosophic dense set A of (X, T) is neutrosophic open.

Example 3.3. Let $X = \{a, b, c\}$. Define the neutrosophic sets $A, B, A \cap B$ and $A \cup B$ as follows.

$$\begin{aligned} A &= \langle x, (\frac{a}{0.5}, \frac{b}{0.4}, \frac{c}{0.5}), (\frac{a}{0.5}, \frac{b}{0.4}, \frac{c}{0.5}), (\frac{a}{0.4}, \frac{b}{0.4}, \frac{c}{0.4}) \rangle, \\ B &= \langle x, (\frac{a}{0.4}, \frac{b}{0.5}, \frac{c}{0.5}), (\frac{a}{0.4}, \frac{b}{0.5}, \frac{c}{0.5}), (\frac{a}{0.5}, \frac{b}{0.5}, \frac{c}{0.5}) \rangle, \\ A \cap B &= \langle x, (\frac{a}{0.4}, \frac{b}{0.4}, \frac{c}{0.5}), (\frac{a}{0.4}, \frac{b}{0.4}, \frac{c}{0.5}), (\frac{a}{0.5}, \frac{b}{0.5}, \frac{c}{0.5}) \rangle, \end{aligned}$$

and

$$A \cup B = \langle x, (\frac{a}{0.5}, \frac{b}{0.5}, \frac{c}{0.5}), (\frac{a}{0.5}, \frac{b}{0.5}, \frac{c}{0.5}), (\frac{a}{0.4}, \frac{b}{0.4}, \frac{c}{0.4}) \rangle.$$

It is obvious that $T = \{0_N, 1_N, A, B, A \cap B, A \cup B\}$ is a neutrosophic topology on X . Thus (X, T) is a neutrosophic topological space. Now $Nint(\overline{A}) = 0_N$, $Nint(\overline{B}) = \bigcup\{0_N, B, A \cap B\} = B$, $Nint(\overline{A \cup B}) = 0_N$, $Nint(\overline{A \cap B}) = \bigcup\{0_N, B, A \cap B\} = B$ and $Ncl(A) = 1_N, Ncl(B) = \overline{B}$, $Ncl(A \cup B) = 1_N$, $Ncl(A \cap B) = \overline{B}$, $Ncl(\overline{A \cup B}) = \bigcap\{1_N, \overline{A \cup B}, \overline{B}, \overline{A \cap B}\} = \overline{A \cup B}$, $Ncl(\overline{A}) = \bigcap\{1_N, \overline{A}, \overline{A \cap B}\} = \overline{A}$, $Ncl(0_N) \neq 1_N$. Hence (X, T) is a neutrosophic irresolvable and every neutrosophic dense set of (X, T) is neutrosophic open. Therefore, (X, T) is a maximally neutrosophic irresolvable space.

4 NEUTROSOPHIC OPEN HEREDITARILY IRRESOLVABLE

Definition 4.1. (X, T) is said to be neutrosophic open hereditarily irresolvable if $Nint(Ncl(A)) \neq 0_N$ and $Nint(A) \neq 0_N$, for any neutrosophic set A in (X, T) .

Example 4.1. Let $X = \{a, b, c\}$. Define the neutrosophic sets A_1, A_2 and A_3 as follows.

$$\begin{aligned} A_1 &= \langle x, (\frac{a}{0.4}, \frac{b}{0.4}, \frac{c}{0.4}), (\frac{a}{0.4}, \frac{b}{0.4}, \frac{c}{0.4}), (\frac{a}{0.5}, \frac{b}{0.5}, \frac{c}{0.5}) \rangle, \\ A_2 &= \langle x, (\frac{a}{0.6}, \frac{b}{0.5}, \frac{c}{0.4}), (\frac{a}{0.6}, \frac{b}{0.5}, \frac{c}{0.4}), (\frac{a}{0.4}, \frac{b}{0.5}, \frac{c}{0.4}) \rangle, \end{aligned}$$

and

$$A_3 = \langle x, (\frac{a}{0.4}, \frac{b}{0.4}, \frac{c}{0.5}), (\frac{a}{0.4}, \frac{b}{0.4}, \frac{c}{0.5}), (\frac{a}{0.4}, \frac{b}{0.4}, \frac{c}{0.5}) \rangle.$$

Clearly $T = \{0_N, 1_N, A_1, A_2\}$ is a neutrosophic topology on X . Thus (X, T) is a neutrosophic topological space. Now $Ncl(A_1) = \overline{A_1}$; $Ncl(A_2) = 1_N$ and $Nint(A_3) = A_1$. Also $Nint(Ncl(A_1)) = Nint(\overline{A_1}) = \overline{A_1} \neq 0_N$ and $Nint(A_1) = A_1 \neq 0_N$, $Nint(Ncl(A_2)) = Nint(1_N) = 1_N \neq 0_N$ and $Nint(A_2) = A_2 \neq 0_N$, $Nint(Ncl(A_3)) = Nint(\overline{A_1}) = \overline{A_1} \neq 0_N$ and $Nint(A_3) = A_1 \neq 0_N$ and $Nint(Ncl(\overline{A_3})) = Nint(\overline{A_1}) = \overline{A_1} \neq 0_N$ and $Nint(\overline{A_3}) = A_1 \neq 0_N$. Hence if $Nint(Ncl(A)) \neq 0_N$, then $Nint(A) \neq 0_N$ for any non zero neutrosophic set A in (X, T) . Thus, (X, T) is a neutrosophic open hereditarily irresolvable space.

Proposition 4.1. Let (X, T) be a neutrosophic topological space. If (X, T) is neutrosophic open hereditarily irresolvable, then (X, T) is neutrosophic irresolvable

Proof. Let A be a neutrosophic dense set in (X, T) . Then $Ncl(A) = 1_N$ which implies that $Nint(Ncl(A)) = 1_N \neq 0_N$. Since (X, T) is neutrosophic open hereditarily irresolvable, we have $Nint(A) \neq 0_N$. Therefore by Proposition 3.2 $Nint(A) \neq 0_N$ for all neutrosophic dense set in (X, T) implies that (X, T) is neutrosophic irresolvable.

The converse of Proposition 4.1 is not true. See Example 4.2 □

Example 4.2. Let $X = \{a, b, c\}$. Define the neutrosophic sets A, B and C as follows.

$$A = \langle x, (\frac{a}{0.3}, \frac{b}{0.3}, \frac{c}{0.4}), (\frac{a}{0.3}, \frac{b}{0.3}, \frac{c}{0.4}), (\frac{a}{0.5}, \frac{b}{0.5}, \frac{c}{0.5}) \rangle,$$

$$B = \langle x, (\frac{a}{0.4}, \frac{b}{0.5}, \frac{c}{0.4}), (\frac{a}{0.4}, \frac{b}{0.5}, \frac{c}{0.4}), (\frac{a}{0.4}, \frac{b}{0.4}, \frac{c}{0.4}) \rangle,$$

and

$$C = \langle x, (\frac{a}{0.4}, \frac{b}{0.4}, \frac{c}{0.4}), (\frac{a}{0.4}, \frac{b}{0.4}, \frac{c}{0.4}), (\frac{a}{0.3}, \frac{b}{0.3}, \frac{c}{0.3}) \rangle.$$

It is obvious that $T = \{0_N, 1_N, A, B\}$ is a neutrosophic topology on X . Thus (X, T) is a neutrosophic topological space. Now C and 1_N are neutrosophic dense sets in (X, T) . Then $Nint(C) = A \neq 0_N$ and $Nint(1_N) \neq 0_N$. Hence (X, T) is a neutrosophic irresolvable. But $Nint(Ncl(\overline{C})) = Nint(\overline{A}) = A \neq 0_N$ and $Nint(\overline{C}) = 0_N$. Therefore, (X, T) is not a neutrosophic open hereditarily irresolvable space.

Proposition 4.2. Let (X, T) be a neutrosophic open hereditarily irresolvable. Then $Nint(A) \not\subseteq \overline{Nint(B)}$ for any two neutrosophic dense sets A and B in (X, T) .

Proof. Let A and B be any two neutrosophic dense sets in (X, T) . Then $Ncl(A) = 1_N$ and $Ncl(B) = 1_N$ implies that $Nint(Ncl(A)) \neq 0_N$ and $Nint(Ncl(B)) \neq 0_N$. Since (X, T) is neutrosophic open hereditarily irresolvable, $Nint(A) \neq 0_N$ and $Nint(B) \neq 0_N$. Hence by Proposition 3.1, $A \not\subseteq \overline{B}$. Therefore $Nint(A) \subseteq A \not\subseteq \overline{B} \subseteq \overline{Nint(B)}$. Hence we have $Nint(A) \not\subseteq \overline{Nint(B)}$ for any two neutrosophic dense sets A and B in (X, T) . □

Proposition 4.3. Let (X, T) be a neutrosophic topological space. If (X, T) is neutrosophic open hereditarily irresolvable, then $Nint(A) = 0_N$ for any nonzero neutrosophic dense set A in (X, T) which implies that $Nint(Ncl(A)) = 0_N$.

Proof. Let A be a neutrosophic set in (X, T) such that $Nint(A) = 0_N$. We claim that $Nint(Ncl(A)) = 0_N$. Suppose that $Nint(Ncl(A)) \neq 0_N$. Since (X, T) is neutrosophic open hereditarily irresolvable, we have $Nint(A) \neq 0_N$ which is a contradiction to $Nint(A) = 0_N$. Hence $Nint(Ncl(A)) = 0_N$. □

Proposition 4.4. Let (X, T) be a neutrosophic topological space. If (X, T) is neutrosophic open hereditarily irresolvable, then $Ncl(A) = 1_N$ for any nonzero neutrosophic dense set A in (X, T) which implies that $Ncl(Nint(A)) = 0_N$.

Proof. Let A be a neutrosophic set in (X, T) such that $Ncl(A) = 1_N$. Then we have $\overline{Ncl(A)} = 0_N$ which implies that $Nint(\overline{A}) = 0_N$. Since (X, T) is neutrosophic open hereditarily irresolvable by Proposition 4.3. We have $Nint(Ncl(\overline{A})) = 0_N$. Therefore $\overline{Ncl(Nint(A))} = 0_N$ implies that $Ncl(Nint(A)) = 1_N$. \square

5 SOMEWHAT NEUTROSOPHIC CONTINUOUS AND SOMEWHAT NEUTROSOPHIC OPEN

Definition 5.1. Let (X, T) and (Y, S) be any two neutrosophic topological spaces. A function $f : (X, T) \rightarrow (Y, S)$ is called somewhat neutrosophic continuous if for $A \in S$ and $f^{-1}(A) \neq 0_N$, there exists a $B \in T$ such that $B \neq 0_N$ and $B \subseteq f^{-1}(A)$.

Definition 5.2. Let (X, T) and (Y, S) be any two neutrosophic topological spaces. A function $f : (X, T) \rightarrow (Y, S)$ is called somewhat neutrosophic open if for $A \in T$ and $A \neq 0_N$, there exists a $B \in S$ such that $B \neq 0_N$ and $B \subseteq f(A)$.

Proposition 5.1. Let (X, T) and (Y, S) be any two neutrosophic topological spaces. If the function $f : (X, T) \rightarrow (Y, S)$ is somewhat neutrosophic continuous and injective. If $Nint(A) = 0_N$ for any nonzero neutrosophic set A in (X, T) , then $Nint(f(A)) = 0_N$ in (Y, S) .

Proof. Let A be a nonzero neutrosophic set in (X, T) such that $Nint(A) = 0_N$. Now we prove that $Nint(f(A)) = 0_N$. Suppose that $Nint(f(A)) \neq 0_N$ in (Y, S) . Then there exists a nonzero neutrosophic set B in (Y, S) such that $B \subseteq f(A)$. Thus, we have $f^{-1}(B) \subseteq f^{-1}(f(A))$. Since f is somewhat neutrosophic continuous, there exists a $C \in T$ such that $C \neq 0_N$ and $C \subseteq f^{-1}(B)$. Hence $C \subseteq f^{-1}(B) \subseteq A$ which implies that $Nint(A) \neq 0_N$. This is a contradiction. Hence $Nint(f(A)) = 0_N$ in (Y, S) . \square

Proposition 5.2. Let (X, T) and (Y, S) be any two neutrosophic topological spaces. If the function $f : (X, T) \rightarrow (Y, S)$ is somewhat neutrosophic continuous, injective and $Nint(Ncl(A)) = 0_N$ for any nonzero neutrosophic set A in (X, T) , then $Nint(Ncl(f(A))) = 0_N$ in (Y, S) .

Proof. Let A be a nonzero neutrosophic set in (X, T) such that $Nint(Ncl(A)) = 0_N$. We claim that $Nint(Ncl(f(A))) = 0_N$ in (Y, S) . Suppose that $Nint(Ncl(f(A))) \neq 0_N$ in (Y, S) . Then $Ncl(f(A)) \neq 0_N$ and $\overline{Ncl(f(A))} \neq 0_N$. Now $\overline{Ncl(f(A))} \neq 0_N \in S$. Since f is somewhat neutrosophic continuous, there exists a $B \in T$, such that $B \neq 0_N$ and $B \subseteq f^{-1}(\overline{Ncl(f(A))})$. Observe that $B \subseteq \overline{f^{-1}(Ncl(f(A)))}$ which implies that $f^{-1}(Ncl(f(A))) \subseteq \overline{B}$. Since f is injective, thus $A \subseteq f^{-1}(f(A)) \subseteq f^{-1}(Ncl(f(A))) \subseteq \overline{B}$ which implies that $A \subseteq \overline{B}$. Therefore $B \subseteq \overline{A}$. This implies that $Nint(\overline{A}) \neq 0_N$. Let $Nint(\overline{A}) = C \neq 0_N$. Then we have $Ncl(Nint(\overline{A})) = Ncl(C) \neq 1_N$ which implies that $Nint(Ncl(A)) \neq 0_N$. But this is a contradiction. Hence $Nint(Ncl(f(A))) = 0_N$ in (Y, S) . \square

Proposition 5.3. Let (X, T) and (Y, S) be any two neutrosophic topological spaces. If the function $f : (X, T) \rightarrow (Y, S)$ is somewhat neutrosophic open and $Nint(A) = 0_N$ for any nonzero neutrosophic set A in (Y, S) , then $Nint(f^{-1}(A)) = 0_N$ in (X, T) .

Proof. Let A be a nonzero neutrosophic set in (Y, S) such that $Nint(A) = 0_N$. We claim that $Nint(f^{-1}(A)) = 0_N$ in (X, T) . Suppose that $Nint(f^{-1}(A)) \neq 0_N$ in (X, T) . Then there exists a nonzero neutrosophic open set B in (X, T) such that $B \subseteq f^{-1}(A)$. Thus, we have $f(B) \subseteq f(f^{-1}(A)) \subseteq A$. This implies that $f(B) \subseteq A$. Since f is somewhat neutrosophic open, there exists a $C \in S$ such that $C \neq 0_N$ and $C \subseteq f(B)$. Therefore $C \subseteq f(B) \subseteq A$ which implies that $C \subseteq A$. Hence $Nint(A) \neq 0_N$ which is a contradiction. Hence $Nint(f^{-1}(A)) = 0_N$ in (X, T) . \square

Proposition 5.4. Let (X, T) and (Y, S) be any two neutrosophic topological spaces. Let (X, T) be a neutrosophic open hereditarily irresolvable space. If $f : (X, T) \rightarrow (Y, S)$ is somewhat neutrosophic open, somewhat neutrosophic continuous and a bijective function, then (Y, S) is a neutrosophic open hereditarily space.

Proof. Let A be a nonzero neutrosophic set in (Y, S) such that $Nint(A) = 0_N$. Now $Nint(A) = 0_N$ and f is somewhat neutrosophic open which implies $Nint(f^{-1}(A)) = 0_N$ in (X, T) by Proposition 5.3. Since (X, T) is a neutrosophic open hereditarily irresolvable space, we have $Nint(Ncl(f^{-1}(A))) = 0_N$ in (X, T) by Proposition 4.3. Since $Nint(Ncl(f^{-1}(A))) = 0_N$ and f is somewhat neutrosophic continuous by Proposition 5.2, we have that $Nint(Ncl(f(f^{-1}(A)))) = 0_N$. Since f is onto, thus $NintNcl(A) = 0_N$. Hence by Proposition 4.3. (Y, S) is a neutrosophic open hereditarily irresolvable space. \square

References

- Atanassov, K. (1983, June). Intuitionistic fuzzy sets, in: V. Sgurev, Ed., *VII ITKR's Session, Sofia (Central Sci. and Techn. Library, Bulg. Academy of Sciences, 1984)*.
- Atanassov, K. (1986). Intuitionistic fuzzy sets. *Fuzzy Sets and Systems*, 20, 87-96.
- Atanassov, K. (1983, August). Review and new results on intuitionistic fuzzy sets, *Preprint IM-MFAIS-1-88, Sofia*, 1988.
- Atanassov, K., and Stoeva, S.(1983, August). Intuitionistic fuzzy sets, in: *Polish Syrup. on Interval & Fuzzy Mathematics, Poznan*, 23-26.
- Chang, C. L. (1968). Fuzzy topological spaces. *Journal of mathematical Analysis and Applications*, 24, 182-190.
- Coker, D.(1997). An introduction to intuitionistic fuzzy topological spaces. *Fuzzy Sets and Systems*, 88, 81-89.
- Dhavaseelan, R., E. Roja. E. & Uma, M. K.(2011). Intuitionistic fuzzy resolvable and intuitionistic fuzzy irresolvable spaces, *Scientia Magna*, 7, 59-67.

Dhavaseelan, R., & Jafari, S. (20xx) Generalized neutrosophic closed sets. (submitted).

Salama, A. A. and Alblowi, S. A. (2012). Neutrosophic set and neutrosophic topological spaces. *IOSR Journal of Mathematics*, 3(4), 31-35.

Smarandache, F. (2002). Neutrosophy and Neutrosophic Logic , First International Conference on Neutrosophy , Neutrosophic Logic, Set, Probability, and Statistics University of New Mexico, Gallup, NM 87301, USA.

Smarandache F (1999) *A unifying field in logics. Neutrosophy: Neutrosophic probability, set and logic.* American Research Press, Rehoboth.

G. Thangaraj G., & Balasubramanian, G. (2009). On fuzzy resolvable and fuzzy irresolvable spaces. *Fuzzy Sets Rough Sets and Multivalued Operations and Applications*, 1(2), 173-180.

L. A. Zadeh, L. A. (1965). Fuzzy sets. *Information and Control*, 8, 338-353.

Neutrosophic Rare α -Continuity

^{1*} R.Dhavaseelan, ²S. Jafari, ³R. M. Latif and ⁴F. Smarandache

^{1*}Department of Mathematics, Sona College of Technology, Salem-636005, Tamil Nadu, India.

²Department of Mathematics, College of Vestsjaelland South,
Herrestraede 11, 4200 Slagelse, Denmark.

³Department of Mathematics & Natural Sciences,
Prince Mohammed Bin Fahd University, P. O. Box 1664 Al Khobar 31952, KSA.

⁴Mathematics & Science Department, University of New Mexico,
705 Gurley Ave, Gallup, NM 87301, USA.

e-mail : ¹dhavaseelan.r@gmail.com, ²jafaripersia@gmail.com,

³ rlatif@pmu.edu.sa, ⁴ fsmarandache@gmail.com

ABSTRACT

In this paper, we introduce the concepts of neutrosophic rare α -continuous, neutrosophic rarely continuous, neutrosophic rarely pre-continuous, neutrosophic rarely semi-continuous are introduced and studied in light of the concept of rare set in neutrosophic setting.

KEYWORDS: Neutrosophic rare set; neutrosophic rarely α -continuous; neutrosophic rarely pre-continuous; neutrosophic almost α -continuous; neutrosophic weekly α -continuous; neutrosophic rarely semi-continuous.

1 INTRODUCTION AND PRELIMINARIES

The study of fuzzy sets was initiated by Zadeh (1965). Thereafter the paper of Chang (1968) paved the way for the subsequent tremendous growth of the numerous fuzzy topological concepts. Currently Fuzzy Topology has been observed to be very beneficial in fixing many realistic problems. Several mathematicians have tried almost all the pivotal concepts of General Topology for extension to the fuzzy settings. In 1981, Azad gave fuzzy version of the concepts given by Levine 1961; 1963 and thus initiated the study of weak forms of several notions in fuzzy topological spaces. Popa (1979) introduced the notion of rare continuity as a generalization of weak continuity (Levine, 1961) which has been further investigated by Long and Herrington (1982) and Jafari (1995; 1997). Noiri (1987) introduced and

investigated weakly α -continuity as a generalization of weak continuity. He also introduced and investigated almost α -continuity (Noiri, 1988). The concepts of Rarely α -continuity was introduced by Jafari (2005). The concepts of fuzzy rare α -continuity and intuitionistic fuzzy rare α -continuity were introduced by Dhavaseelan and Jafari (n.d.-b, n.d.-c). After the advent of the concepts of neutrosophy and neutrosophic set introduced by Smarandachethe (1999; 2002), the concepts of neutrosophic crisp set and neutrosophic crisp topological spaces were introduced by Salama and Alblowi (2012).

The purpose of the present paper is to introduce and study the concepts of neutrosophic rare α -continuous functions, neutrosophic rarely continuous functions, neutrosophic rarely pre-continuous functions and neutrosophic rarely semi-continuous functions in light of the concept of rare set in a neutrosophic setting.

Definition 1.1. Let X be a nonempty fixed set. A neutrosophic set [briefly NS] A is an object having the form $A = \{\langle x, \mu_A(x), \sigma_A(x), \gamma_A(x) \rangle : x \in X\}$, where $\mu_A(x)$, $\sigma_A(x)$ and $\gamma_A(x)$ which represents the degree of membership function ($\mu_A(x)$), the degree of indeterminacy (namely $\sigma_A(x)$) and the degree of nonmembership ($\gamma_A(x)$), respectively, of each element $x \in X$ to the set A .

Remark 1.1. (1) A neutrosophic set $A = \{\langle x, \mu_A(x), \sigma_A(x), \gamma_A(x) \rangle : x \in X\}$ can be identified to an ordered triple $\langle \mu_A, \sigma_A, \gamma_A \rangle$ in $]0^-, 1^+[$ on X .

(2) For the sake of simplicity, we shall use the symbol $A = \langle \mu_A, \sigma_A, \gamma_A \rangle$ for the neutrosophic set $A = \{\langle x, \mu_A(x), \sigma_A(x), \gamma_A(x) \rangle : x \in X\}$.

Definition 1.2. Let X be a nonempty set and the neutrosophic sets A and B in the form $A = \{\langle x, \mu_A(x), \sigma_A(x), \gamma_A(x) \rangle : x \in X\}$, $B = \{\langle x, \mu_B(x), \sigma_B(x), \gamma_B(x) \rangle : x \in X\}$. Then

- (a) $A \subseteq B$ iff $\mu_A(x) \leq \mu_B(x)$, $\sigma_A(x) \leq \sigma_B(x)$ and $\gamma_A(x) \geq \gamma_B(x)$ for all $x \in X$;
- (b) $A = B$ iff $A \subseteq B$ and $B \subseteq A$;
- (c) $\bar{A} = \{\langle x, \gamma_A(x), \sigma_A(x), \mu_A(x) \rangle : x \in X\}$; [complement of A]
- (d) $A \cap B = \{\langle x, \mu_A(x) \wedge \mu_B(x), \sigma_A(x) \wedge \sigma_B(x), \gamma_A(x) \vee \gamma_B(x) \rangle : x \in X\}$;
- (e) $A \cup B = \{\langle x, \mu_A(x) \vee \mu_B(x), \sigma_A(x) \vee \sigma_B(x), \gamma_A(x) \wedge \gamma_B(x) \rangle : x \in X\}$;
- (f) $[]A = \{\langle x, \mu_A(x), \sigma_A(x), 1 - \mu_A(x) \rangle : x \in X\}$;
- (g) $\langle \rangle A = \{\langle x, 1 - \gamma_A(x), \sigma_A(x), \gamma_A(x) \rangle : x \in X\}$.

Definition 1.3. Let $\{A_i : i \in J\}$ be an arbitrary family of neutrosophic sets in X . Then

- (a) $\bigcap A_i = \{\langle x, \wedge \mu_{A_i}(x), \wedge \sigma_{A_i}(x), \vee \gamma_{A_i}(x) \rangle : x \in X\}$;
- (b) $\bigcup A_i = \{\langle x, \vee \mu_{A_i}(x), \vee \sigma_{A_i}(x), \wedge \gamma_{A_i}(x) \rangle : x \in X\}$.

Since our main purpose is to construct the tools for developing neutrosophic topological spaces, we must introduce the neutrosophic sets 0_N and 1_N in X as follows:

Definition 1.4. $0_N = \{\langle x, 0, 0, 1 \rangle : x \in X\}$ and $1_N = \{\langle x, 1, 1, 0 \rangle : x \in X\}$.

Definition 1.5. (Dhavaseelan & Jafari, n.d.-a) A neutrosophic topology (briefly NT) on a nonempty set X is a family T of neutrosophic sets in X satisfying the following axioms:

- (i) $0_N, 1_N \in T$,
- (ii) $G_1 \cap G_2 \in T$ for any $G_1, G_2 \in T$,
- (iii) $\cup G_i \in T$ for arbitrary family $\{G_i \mid i \in \Lambda\} \subseteq T$.

In this case the ordered pair (X, T) or simply X is called a neutrosophic topological space (briefly NTS) and each neutrosophic set in T is called a neutrosophic open set (briefly NOS). The complement \bar{A} of a NOS A in X is called a neutrosophic closed set (briefly NCS) in X .

Definition 1.6. (Dhavaseelan & Jafari, n.d.-a) Let A be a neutrosophic set in a neutrosophic topological space X . Then

$Nint(A) = \cup\{G \mid G \text{ is a neutrosophic open set in } X \text{ and } G \subseteq A\}$ is called the neutrosophic interior of A ;

$Ncl(A) = \cap\{G \mid G \text{ is a neutrosophic closed set in } X \text{ and } G \supseteq A\}$ is called the neutrosophic closure of A .

Definition 1.7. (Dhavaseelan & Jafari, n.d.-a) Let X be a nonempty set. If r, t, s be real standard or non standard subsets of $]0^-, 1^+[$, then the neutrosophic set $x_{r,t,s}$ is called a neutrosophic point (briefly NP) in X given by

$$x_{r,t,s}(x_p) = \begin{cases} (r, t, s), & \text{if } x = x_p \\ (0, 0, 1), & \text{if } x \neq x_p \end{cases}$$

for $x_p \in X$ is called the support of $x_{r,t,s}$, where r denotes the degree of membership value, t the degree of indeterminacy and s the degree of non-membership value of $x_{r,t,s}$.

Definition 1.8. (Dhavaseelan & Jafari, n.d.-b) An intuitionistic fuzzy set R is called intuitionistic fuzzy rare set if $IFint(R) = 0_\sim$.

Definition 1.9. (Dhavaseelan & Jafari, n.d.-b) An intuitionistic fuzzy set R is called intuitionistic fuzzy nowhere dense set if $IFint(IFcl(R)) = 0_\sim$.

2 MAIN RESULTS

Definition 2.1. A neutrosophic set A in a neutrosophic topological space (X, T) is called

- 1) a neutrosophic semiopen set (briefly NSOS) if $A \subseteq Ncl(Nint(A))$.
- 2) a neutrosophic α open set (briefly $N\alpha OS$) if $A \subseteq Nint(Ncl(Nint(A)))$.
- 3) a neutrosophic preopen set (briefly NPOS) if $A \subseteq Nint(Ncl(A))$.
- 4) a neutrosophic regular open set (briefly NROS) if $A = Nint(Ncl(A))$.
- 5) a neutrosophic semipreopen or β open set (briefly $N\beta OS$) if $A \subseteq Ncl(Nint(Ncl(A)))$.

A neutrosophic set A is called a neutrosophic semiclosed set, neutrosophic α -closed set, neutrosophic preclosed set, neutrosophic regular closed set and neutrosophic β -closed set (briefly NSCS, $N\alpha CS$, NPCS, NRCS and $N\beta CS$, resp.), if the complement of A is a neutrosophic semiopen set, neutrosophic α -open set, neutrosophic preopen set, neutrosophic regular open set, and neutrosophic β -open set, respectively.

Definition 2.2. Let a neutrosophic set A of a neutrosophic topological space (X, T) . Then neutrosophic α -closure of A (briefly $Ncl_\alpha(A)$) is defined as $Ncl_\alpha(A) = \bigcap \{K \mid K \text{ is a neutrosophic } \alpha \text{ closed set in } X \text{ and } A \subseteq K\}$.

Definition 2.3. (Jun & Song, 2005) Let a neutrosophic set A of a neutrosophic topological space (X, T) . Then neutrosophic α interior of A (briefly $Nint_\alpha(A)$) is defined as $Nint_\alpha(A) = \bigcup \{K \mid K \text{ is a neutrosophic } \alpha \text{ open set in } X \text{ and } K \subseteq A\}$.

Definition 2.4. A neutrosophic set R is called neutrosophic rare set if $Nint(R) = 0_N$.

Definition 2.5. A neutrosophic set R is called neutrosophic nowhere dense set if $Nint(Ncl(R)) = 0_N$.

Definition 2.6. Let (X, T) and (Y, S) be two neutrosophic topological spaces. A function $f : (X, T) \rightarrow (Y, S)$ is called

- (i) neutrosophic α -continuous if for each neutrosophic point $x_{r,t,s}$ in X and each neutrosophic open set G in Y containing $f(x_{r,t,s})$, there exists a neutrosophic α open set U in X such that $f(U) \leq G$.
- (ii) neutrosophic almost α -continuous if for each neutrosophic point $x_{r,t,s}$ in X and each neutrosophic open set G containing $f(x_{r,t,s})$, there exists a neutrosophic α open set U such that $f(U) \leq Nint(Ncl(G))$.
- (iii) neutrosophic weakly α -continuous if for each neutrosophic point $x_{r,t,s}$ in X and each neutrosophic open set G containing $f(x_{r,t,s})$, there exists a neutrosophic α open set U such that $f(U) \leq Ncl(G)$.

Definition 2.7. Let (X, T) and (Y, S) be two neutrosophic topological spaces. A function $f : (X, T) \rightarrow (Y, S)$ is called

- (i) neutrosophic rarely α -continuous if for each neutrosophic point $x_{r,t,s}$ in X and each neutrosophic open set G in (Y, S) containing $f(x_{r,t,s})$, there exist a neutrosophic rare set R with $G \cap Ncl(R) = 0_N$ and neutrosophic α open set U in (X, T) such that $f(U) \leq G \cup R$.
- (ii) neutrosophic rarely continuous if for each neutrosophic point $x_{r,t,s}$ in X and each neutrosophic open set G in (Y, S) containing $f(x_{r,t,s})$, there exist a neutrosophic rare set R with $G \cap Ncl(R) = 0_N$ and neutrosophic open set U in (X, T) such that $f(U) \leq G \cup R$.
- (iii) neutrosophic rarely precontinuous if for each neutrosophic point $x_{r,t,s}$ in X and each neutrosophic open set G in (Y, S) containing $f(x_{r,t,s})$, there exist a neutrosophic rare set R with $G \cap Ncl(R) = 0_N$ and neutrosophic preopen set U in (X, T) such that $f(U) \leq G \cup R$.
- (iv) neutrosophic rarely semi-continuous if for each neutrosophic point $x_{r,t,s}$ in X and each neutrosophic open set G in (Y, S) containing $f(x_{r,t,s})$, there exist a neutrosophic rare set R with $G \cap Ncl(R) = 0_N$ and neutrosophic semiopen set U in (X, T) such that $f(U) \leq G \cup R$.

Example 2.1. Let $X = \{a, b, c\}$. Define the neutrosophic sets A, B and C as follows:

$A = \langle x, (\frac{a}{0}, \frac{b}{0}, \frac{c}{1}), (\frac{a}{0}, \frac{b}{0}, \frac{c}{1}), (\frac{a}{1}, \frac{b}{1}, \frac{c}{0}) \rangle$, $B = \langle x, (\frac{a}{1}, \frac{b}{0}, \frac{c}{0}), (\frac{a}{1}, \frac{b}{0}, \frac{c}{0}), (\frac{a}{0}, \frac{b}{1}, \frac{c}{1}) \rangle$ and $C = \langle x, (\frac{a}{0}, \frac{b}{1}, \frac{c}{0}), (\frac{a}{0}, \frac{b}{1}, \frac{c}{0}), (\frac{a}{1}, \frac{b}{0}, \frac{c}{1}) \rangle$. Then $T = \{0_N, 1_N, C\}$ and $S = \{0_N, 1_N, A, B, A \cup B\}$ are neutrosophic topologies on X . Let (X, T) and (X, S) be neutrosophic topological spaces. Define $f : (X, T) \rightarrow (X, S)$ as a identity function. Clearly f is neutrosophic rarely α -continuous.

Proposition 2.1. Let (X, T) and (Y, S) be any two neutrosophic topological spaces. For a function $f : (X, T) \rightarrow (Y, S)$ the following statements are equivalent:

- (i) The function f is neutrosophic rarely α -continuous at $x_{r,t,s}$ in (X, T) .
- (ii) For each neutrosophic open set G containing $f(x_{r,t,s})$, there exists a neutrosophic α open set U in (X, T) such that $Nint(f(U) \cap \overline{G}) = 0_N$.
- (iii) For each neutrosophic open set G containing $f(x_{r,t,s})$, there exists a neutrosophic α open set U in (X, T) such that $Nint(f(U)) \leq Ncl(G)$.
- (iv) For each neutrosophic open set G in (Y, S) containing $f(x_{r,t,s})$, there exists a neutrosophic rare set R with $G \cap Ncl(R) = 0_N$ such that $x_{r,t,s} \in Nint_\alpha(f^{-1}(G \cup R))$.
- (v) For each neutrosophic open set G in (Y, S) containing $f(x_{r,t,s})$, there exists a neutrosophic rare set R with $Ncl(G) \cap R = 0_N$ such that $x_{r,t,s} \in Nint_\alpha(f^{-1}(Ncl(G) \cup R))$.
- (vi) For each neutrosophic regular open set G in (Y, S) containing $f(x_{r,t,s})$, there exists a neutrosophic rare set R with $Ncl(G) \cap R = 0_N$ such that $x_{r,t,s} \in Nint_\alpha(f^{-1}(G \cup R))$.

Proof. (i) \Rightarrow (ii) Let G be a neutrosophic open set in (Y, S) containing $f(x_{r,t,s})$. By $f(x_{r,t,s}) \in G \leq Nint(Ncl(G))$ and $Nint(Ncl(G))$ containing $f(x_{r,t,s})$, there exists a neutrosophic rare set R with $Nint(Ncl(G)) \cap Ncl(R) = 0_N$ and a neutrosophic α open set U in (X, T) containing $x_{r,t,s}$ such that $f(U) \leq Nint(Ncl(G)) \cup R$. We have $Nint(f(U) \cap \overline{G})Nint(\overline{G}) \leq Nint(Ncl(G) \cup R) \cap \overline{(Ncl(G))} \leq Ncl(G) \cup Nint(R) \cap \overline{(Ncl(G))} = 0_N$.

(ii) \Rightarrow (iii) Obvious.

(iii) \Rightarrow (i) Let G be a neutrosophic open set in (Y, S) containing $f(x_{r,t,s})$. Then by (iii), there exists a neutrosophic α -open set U containing $x_{r,t,s}$ such that $Nint(f(U) \leq Ncl(G)$. We have $f(U) = (f(U) \cap \overline{(Nint(f(U)))}) \cup Nint(f(U)) < (f(U) \cap \overline{(Nint(f(U)))}) \cup Ncl(G) = (f(U) \cap \overline{(Nint(f(U)))}) \cup G \cup (Ncl(G) \cap \overline{G}) = (f(U) \cap \overline{(Nint(f(U)))}) \cap \overline{G} \cup G \cup (Ncl(G) \cap \overline{G})$. Set $R_1 = f(U) \cap \overline{(Nint(f(U)))} \cap \overline{G}$ and $R_2 = Ncl(G) \cap \overline{G}$. Then R_1 and R_2 are neutrosophic rare sets. More $R = R_1 \cup R_2$ is a neutrosophic set such that $Ncl(R) \cap G = 0_N$ and $f(U) \leq G \cup R$. This show that f is neutrosophic rarely α -continuous.

(i) \Rightarrow (iv) Suppose that G be a neutrosophic open set in (Y, S) containing $f(x_{r,t,s})$. Then there exists a neutrosophic rare set R with $G \cap Ncl(R) = 0_N$ and U be a neutrosophic α -open set in (X, T) containing $x_{r,t,s}$ such that $f(U) \leq G \cup R$. It follows that $x_{r,t,s} \in U \leq f^{-1}(G \cup R)$. This implies that $x_{r,t,s} \in Nint_\alpha(f^{-1}(G \cup R))$.

(iv) \Rightarrow (v) Suppose that G be a neutrosophic open set in (Y, S) containing $f(x_{r,t,s})$. Then there exists a neutrosophic rare set R with $G \cap Ncl(R) = 0_N$ such that $x_{r,t,s} \in Nint_\alpha(f^{-1}(G \cup R))$. Since $G \cap Ncl(R) = 0_N, R \leq \overline{G}$, where $\overline{G} = \overline{(Ncl(G))} \cup (Ncl(G) \cap \overline{G})$. Now, we have $R \leq R \cup \overline{(Ncl(G))} \cup (Ncl(G) \cap \overline{G})$. Now, $R_1 = R \cap \overline{(Ncl(G))}$. It follows that R_1 is a neutrosophic rare set with $Ncl(G) \cap R_1 = 0_N$. Therefore $x_{r,t,s} \in Nint_\alpha(f^{-1}(G \cup R)) \leq Nint_\alpha(f^{-1}(G \cup R_1))$.

(v) \Rightarrow (vi) Assume that G be a neutrosophic regular open set in (Y, S) containing $f(x_{r,t,s})$. Then there exists a neutrosophic rare set R with $Ncl(G) \cap R = 0_N$ such that $x_{r,t,s} \in Nint_\alpha(f^{-1}(Ncl(G) \cup R))$. Now $R_1 = R \cup (Ncl(G) \cup \overline{G})$. It follows that R_1 is a neutrosophic rare set and $(G \cap Ncl(R_1)) = 0_N$. Hence $x_{r,t,s} \in Nint_\alpha(f^{-1}(Ncl(G) \cup R)) = Nint_\alpha(f^{-1}(G \cup (Ncl(G) \cap \overline{G})) \cup R) = Nint_\alpha(f^{-1}(G \cup R_1))$. Therefore $x_{r,t,s} \in Nint_\alpha(f^{-1}(G \cup R_1))$.

(vi) \Rightarrow (ii) Let G be a neutrosophic open set in (Y, S) containing $f(x_{r,t,s})$. By $f(x_{r,t,s}) \in G \leq Nint(Ncl(G))$ and the fact that $Nint(Ncl(G))$ is a neutrosophic regular open in (Y, S) , there exists a neutrosophic rare set R and $Nint(Ncl(G)) \cap Ncl(R) = 0_N$, such that $x_{r,t,s} \in Nint_\alpha(f^{-1}(Nint(Ncl(G)) \cup R))$. Let $U = Nint_\alpha(f^{-1}(Nint(Ncl(G)) \cup R))$. Hence U is a neutrosophic α -open set in (X, T) containing $x_{r,t,s}$ and therefore $f(U) \leq Nint(Ncl(G)) \cup R$. Hence, we have $Nint(f(U) \cap \overline{G}) = 0_N$. □

Proposition 2.2. Let (X, T) and (Y, S) be any two neutrosophic topological space. Then a function $f : (X, T) \rightarrow (Y, S)$ is a neutrosophic rarely α -continuous if and only if $f^{-1}(G) \leq Nint_\alpha(f^{-1}(G \cup R))$ for every neutrosophic open set G in (Y, S) , where R is a neutrosophic rare set with $Ncl(R) \cap G = 0_N$.

Proof. Suppose that G be a neutrosophic rarely α -open set in (Y, S) containing $f(x_{r,t,s})$. Then $G \cap Ncl(R) = 0_N$ and U be a neutrosophic α -open set in (X, T) containing $x_{r,t,s}$, such that $f(U) \leq G \cup R$. It follows that $x_{r,t,s} \in U \leq f^{-1}(G \cup R)$. This implies that $f^{-1}(G) \leq Nint_\alpha(f^{-1}(G \cup R))$. \square

Definition 2.8. A function $f : (X, T) \rightarrow (Y, S)$ is neutrosophic $I\alpha$ -continuous at $x_{r,t,s}$ in (X, T) if for each neutrosophic open set G in (Y, S) containing $f(x_{r,t,s})$, there exists a neutrosophic α -open set U containing $x_{r,t,s}$, such that $Nint(f(U)) \leq G$.

If f has this property at each neutrosophic point $x_{r,t,s}$ in (X, T) , then we say that f is neutrosophic $I\alpha$ -continuous on (X, T) .

Example 2.2. Let $X = \{a, b, c\}$. Define the neutrosophic sets A and B as follows:

$A = \langle x, (\frac{a}{0}, \frac{b}{1}, \frac{c}{0}), (\frac{a}{0}, \frac{b}{1}, \frac{c}{0}), (\frac{a}{1}, \frac{b}{0}, \frac{c}{1}) \rangle$ and $B = \langle x, (\frac{a}{1}, \frac{b}{0}, \frac{c}{0}), (\frac{a}{1}, \frac{b}{0}, \frac{c}{0}), (\frac{a}{0}, \frac{b}{1}, \frac{c}{1}) \rangle$. Then $T = \{0_N, 1_N, A\}$ and $S = \{0_N, 1_N, B\}$ are neutrosophic topologies on X . Let (X, T) and (X, S) be neutrosophic topological spaces. Let $f : (X, T) \rightarrow (X, S)$ as defined by $f(a) = f(b) = b$ and $f(c) = c$ is neutrosophic $I\alpha$ -continuous.

Proposition 2.3. Let (Y, S) be a neutrosophic regular space. Then the function $f : (X, T) \rightarrow (Y, S)$ is neutrosophic $I\alpha$ continuous on X if and only if f is neutrosophic rarely α -continuous on X .

Proof. \Rightarrow It is obvious.

\Leftarrow Let f be neutrosophic rarely α -continuous on (X, T) . Suppose that $f(x_{r,t,s}) \in G$, where G is a neutrosophic open set in (Y, S) and a neutrosophic point $x_{r,t,s}$ in X . By the neutrosophic regularity of (Y, S) , there exists a neutrosophic open set G_1 in (Y, S) such that G_1 containing $f(x_{r,t,s})$ and $Ncl(G_1) \leq G$. Since f is neutrosophic rarely α -continuous, then there exists a neutrosophic α open set U , such that $Nint(f(U)) \leq Ncl(G_1)$. This implies that $Nint(f(U)) \leq G$ which means that f is neutrosophic $I\alpha$ -continuous on X . \square

Definition 2.9. A function $f : (X, T) \rightarrow (Y, S)$ is called neutrosophic pre- α -open if for every neutrosophic α -open set U in X such that $f(U)$ is a neutrosophic α -open in Y .

Proposition 2.4. If a function $f : (X, T) \rightarrow (Y, S)$ is a neutrosophic pre- α -open and neutrosophic rarely α -continuous then f is neutrosophic almost α -continuous.

Proof. suppose that a neutrosophic point $x_{r,t,s}$ in X and a neutrosophic open set G in Y , containing $f(x_{r,t,s})$. Since f is neutrosophic rarely α -continuous at $x_{r,t,s}$, then there exists a neutrosophic α -open set U in X such that $Nint(f(U)) \subset Ncl(G)$. Since f is neutrosophic pre- α -open, we have $f(U)$ in Y . This implies that $f(U) \subset Nint(Ncl(Nint(f(U)))) \subset Nint(Ncl(G))$. Hence f is neutrosophic almost α -continuous. \square

For a function $f : X \rightarrow Y$, the graph $g : X \rightarrow X \times Y$ of f is defined by $g(x) = (x, f(x))$, for each $x \in X$.

Proposition 2.5. Let $f : (X, T) \rightarrow (Y, S)$ be any function. If the $g : X \rightarrow X \times Y$ of f is neutrosophic rarely α -continuous then f is also neutrosophic rarely α -continuous.

Proof. Suppose that a neutrosophic point $x_{r,t,s}$ in X and a neutrosophic open set W in Y , containing $g(x_{r,t,s})$. It follows that there exists neutrosophic open sets 1_X and V in X and Y respectively, such that $(x_{r,t,s}, f(x_{r,t,s})) \in 1_X \times V \subset W$. Since f is neutrosophic rarely α -continuous, there exists a neutrosophic α -open set G such that $Nint(f(G)) \subset Ncl(V)$. Let $E = 1_X \cap G$. It follows that E be a neutrosophic α -open set in X and we have $Nint(g(E)) \subset Nint(1_X \times f(G)) \subset 1_X \times Ncl(V) \subset Ncl(W)$. Therefore g is neutrosophic rarely α -continuous. \square

REFERENCES

- Azad, K. (1981). On fuzzy semicontinuity, fuzzy almost continuity and fuzzy weakly continuity. *Journal of Mathematical Analysis and Applications*, 82(1), 14–32.
- Chang, C.-L. (1968). Fuzzy topological spaces. *Journal of mathematical Analysis and Applications*, 24(1), 182–190.
- Dhavaseelan, D., & Jafari, S. (n.d.-a). Generalized neutrosophic contra-continuity. *submitted*.
- Dhavaseelan, D., & Jafari, S. (n.d.-b). Intuitionistic fuzzy rare α -continuity. *submitted*.
- Dhavaseelan, D., & Jafari, S. (n.d.-c). A note on fuzzy rare α -continuity. *submitted*.
- Jafari, S. (1995). A note on rarely continuous functions, univ. *Bacâu. Stud. Cerc. St. Ser. Mat*, 5, 29–34.
- Jafari, S. (1997). On some properties of rarely continuous functions, univ. *Bacâu. Stud. Cerc. St. Ser. Mat*, 7, 65–73.
- Jafari, S. (2005). Rare $[\alpha]$ -continuity. *Bulletin of the Malaysian Mathematical Sciences Society*, 28(2).
- Jun, Y. B., & Song, S. (2005). Intuitionistic fuzzy semi-preopen sets and intuitionistic fuzzy semi-precontinuous mappings. *Journal of Applied Mathematics and Computing*, 19(1/2), 467.
- Levine, N. (1961). A decomposition of continuity in topological spaces. *The American Mathematical Monthly*, 68(1), 44–46.
- Levine, N. (1963). Semi-open sets and semi-continuity in topological spaces. *The American Mathematical Monthly*, 70(1), 36–41.
- Long, P., & Herrington, L. (1982). Properties of rarely continuous functions. *Glasnik Mat*, 17(37), 147–153.
- Noiri, T. (1987). Weakly α -continuous functions. *International Journal of Mathematics and Mathematical Sciences*, 10(3), 483–490.
- Noiri, T. (1988). Almost α -continuous functions. *Kyungpook Math. J.*, 28(1), 71–77.

- Popa, V. (1979). Sur certain decomposition de la continuité dans les espaces topologiques. *Glasnik Mat. Setr III*, 14(34), 359–362.
- Salama, A., & Alblowi, S. (2012). Neutrosophic set and neutrosophic topological spaces. *IOSR Journal of Mathematics (IOSR-JM)*, 3(4), 31–35.
- Smarandache, F. (1999). *A unifying field in logics. neutrosophy: Neutrosophic probability, set and logic*. Rehoboth: American Research Press.
- Smarandache, F. (2002). Neutrosophy and neutrosophic logic. In *Neutrosophy and neutrosophic logic*. University of New Mexico, Gallup, NM 87301, USA.
- Zadeh, L. (1965). Fuzzy sets. *Information and Control*, 8(3), 338–353.

Neutrosophic Semi-Continuous Multifunctions

R. Dhavaseelan¹, S. Jafari², N. Rajesh³, F. Smarandache⁴

¹Department of Mathematics, Sona College of Technology, Salem-636005,
Tamil Nadu, India.,

Email: dhavaseelan.r@gmail.com.

²College of Vestsjaelland South, Herrestraede 11,
4200 Slagelse, Denmark.

Email: jafaripersia@gmail.com.

³Department of Mathematics, Rajah Serfoji Govt. College,
Thanjavur-613005, Tamilnadu, India.

Email: nrajesh_topology@yahoo.co.in.

⁴Mathematics & Science Department, University of New Mexico,
705 Gurley Ave, Gallup, NM 87301, USA.

Email: fsmarandache@gmail.com

ABSTRACT

In this paper we introduce the concepts of neutrosophic upper and neutrosophic lower semi-continuous multifunctions and study some of their basic properties.

KEYWORDS: Neutrosophic topological space, semi-continuous multifunctions.

1 INTRODUCTION

There is no doubt that the theory of multifunctions plays an important role in functional analysis and fixed point theory. It also has a wide range of applications in economic theory, decision theory, non-cooperative games, artificial intelligence, medicine and information sciences. Inspired by the research works of Smarandache (1999; 2001; 2007), we introduce and study the notions of neutrosophic upper and neutrosophic lower semi-continuous multifunctions in this paper. Further, we present some characterizations and properties of such notions.

2 PRELIMINARIES

Throughout this paper, by (X, τ) or simply by X we will mean a topological space in the classical sense, and (Y, τ_1) or simply Y will stand for a neutrosophic topological space as defined by Salama and Alblowi (2012).

Definition 1. *Smarandache (1999, 2001, 2007) Let X be a non-empty fixed set. A neutrosophic set A is an object having the form $A = \langle x, \mu_A(x), \sigma_A(x), \gamma_A(x) \rangle$, where $\mu_A(x)$, $\sigma_A(x)$ and $\gamma_A(x)$ are represent the degree of member ship function, the degree of indeterminacy, and the degree of non-membership, respectively of each element $x \in X$ to the set A .*

Definition 2. *(Salama & Alblowi, 2012) A neutrosophic topology on a nonempty set X is a family τ of neutrosophic subsets of X which satisfies the following three conditions:*

1. $0, 1 \in \tau$,
2. If $g, h \in \tau$, their $g \wedge h \in \tau$,
3. If $f_i \in \tau$ for each $i \in I$, then $\bigvee_{i \in I} f_i \in \tau$.

The pair (X, τ) is called a neutrosophic topological space.

Definition 3. *Members of τ are called neutrosophic open sets, denoted by $NO(X)$, and complement of neutrosophic open sets are called neutrosophic closed sets, where the complement of a neutrosophic set A , denoted by A^c , is $1 - A$.*

Neutrosophic sets in Y will be denoted by $\lambda, \gamma, \delta, \rho$, etc., and although subsets of X will be denoted by A, B, U, V , etc. A neutrosophic point in Y with support $y \in Y$ and value α ($0 < \alpha \leq 1$) is denoted by y_α . A neutrosophic set λ in Y is said to be quasi-coincident (q-coincident) with a neutrosophic set μ , denoted by $\lambda q \mu$, if and only if there exists $y \in Y$ such that $\lambda(y) + \mu(y) > 1$. A neutrosophic set λ of Y is called a neutrosophic neighbourhood of a fuzzy point y_α in Y if there exists a neutrosophic open set μ in Y such that $y_\alpha \in \mu \leq \lambda$. The intersection of all neutrosophic closed sets of Y containing λ is called the neutrosophic closure of λ and is denoted by $Cl(\lambda)$. The union of all neutrosophic open sets contained in λ is called the neutrosophic interior of λ and is denoted by $Int(\lambda)$. The family of all open sets of a topological space X is denoted by $O(X)$ and $O(X, x)$ denoted the family $\{A \in O(X) | x \in A\}$, where x is a point of X .

Definition 4. *Let (X, τ) be a topological space in the classical sense and (Y, τ_1) be an neutrosophic topological space. $F : (X, \tau) \rightarrow (Y, \tau_1)$ is called a neutrosophic multifunction if and only if for each $x \in X$, $F(x)$ is a neutrosophic set in Y .*

Definition 5. For a neutrosophic multifunction $F : (X, \tau) \rightarrow (Y, \tau_1)$, the upper inverse $F^+(\lambda)$ and lower inverse $F^-(\lambda)$ of a neutrosophic set λ in Y are defined as follows:

$$F^+(\lambda) = \{x \in X | F(x) \leq \lambda\} \text{ and } F^-(\lambda) = \{x \in X | F(x) q \lambda\}.$$

Lemma 1. For a neutrosophic multifunction $F : (X, \tau) \rightarrow (Y, \tau_1)$, we have $F^-(1 - \lambda) = X - F^+(\lambda)$, for any neutrosophic set λ in Y .

3 NEUTROSOPHIC SEMICONTINUOUS MULTIFUNCTIONS

Definition 6. A neutrosophic multifunction $F : (X, \tau) \rightarrow (Y, \tau_1)$ is said to be

1. neutrosophic upper semicontinuous at a point $x \in X$ if for each $\lambda \in NO(Y)$ containing $F(x)$ (therefore, $F(x) \leq \lambda$), there exists $U \in O(X, x)$ such that $F(U) \leq \lambda$ (therefore $U \subset F^+(\lambda)$).
2. neutrosophic lower semicontinuous at a point $x \in X$ if for each $\lambda \in NO(Y)$ with $F(x) q \lambda$, there exists $U \in O(X, x)$ such that $U \subseteq F^-(\lambda)$.
3. neutrosophic upper semicontinuous (neutrosophic lower semicontinuous) if it is neutrosophic upper semicontinuous (neutrosophic lower semicontinuous) at each point $x \in X$.

Theorem 1. The following assertions are equivalent for a neutrosophic multifunction $F : (X, \tau) \rightarrow (Y, \tau_1)$:

1. F is neutrosophic upper semicontinuous;
2. For each point x of X and each neutrosophic neighbourhood λ of $F(x)$, $F^+(\lambda)$ is a neighbourhood of x ;
3. For each point x of X and each neutrosophic neighbourhood λ of $F(x)$, there exists a neighbourhood U of x such that $F(U) \leq \lambda$;
4. $F^+(\lambda) \in O(X)$ for each $\lambda \in NO(Y)$;
5. $F^-(\delta)$ is a closed set in X for each neutrosophic closed set δ of Y ;
6. $Cl(F^-(\mu)) \subseteq F^-(Cl(\mu))$ for each neutrosophic set μ of Y .

Proof. (1) \Rightarrow (2) Let $x \in X$ and μ be a neutrosophic neighbourhood of $F(x)$. Then there exists $\lambda \in NO(Y)$ such that $F(x) \leq \lambda \leq \mu$. By (1), there exists $U \in O(X, x)$ such that $F(U) \leq \lambda$. Therefore $x \in U \subseteq F^+(\mu)$ and hence $F^+(\mu)$ is a neighbourhood of x .

(2) \Rightarrow (3) Let $x \in X$ and λ be a neutrosophic neighbourhood of $F(x)$. Put $U = F^+(\lambda)$. Then

by (2), U is neighbourhood of x and $F(U) = \bigvee_{x \in U} F(x) \leq \lambda$.

(3) \Rightarrow (4) Let $\lambda \in NO(Y)$, we want to show that $F^+(\lambda) \in O(X)$. So let $x \in F^+(\lambda)$. Then there exists a neighbourhood G of x such that $F(G) \leq \lambda$. Therefore for some $U \in O(X, x)$, $U \subseteq G$ and $F(U) \leq \lambda$. Therefore we get $x \in U \subseteq F^+(\lambda)$ and hence $F^+(\lambda) \in O(X)$.

(4) \Rightarrow (5) Let δ be a neutrosophic closed set in Y . So, we have $X \setminus F^-(\delta) = F^+(1 - \delta) \in O(X)$ and hence $F^-(\delta)$ is closed set in X .

(5) \Rightarrow (6) Let μ be any neutrosophic set in Y . Since $Cl(\mu)$ is neutrosophic closed set in Y , $F^-(Cl(\mu))$ is closed set in X and $F^-(\mu) \subseteq F^-(Cl(\mu))$. Therefore, we obtain $Cl(F^-(\mu)) \subseteq F^-(Cl(\mu))$.

(6) \Rightarrow (1) Let $x \in X$ and $\lambda \in NO(Y)$ with $F(x) \leq \lambda$. Now $F^-(1 - \lambda) = \{x \in X | F(x)q(1 - \lambda)\}$. So, for x not belongs to $F^-(1 - \lambda)$. Then, we must have $F(x)h(1 - \lambda)$ and this implies $F(x) \leq 1 - (1 - \lambda) = \lambda$ which is true. Therefore $x \notin F^-(1 - \lambda)$ by (6), $x \notin Cl(F^-(1 - \lambda))$ and there exists $U \in O(X, x)$ such that $U \cap F^-(1 - \lambda) = \emptyset$. Therefore, we obtain $F(U) = \bigvee_{x \in U} F(x) \leq \lambda$.

This proves F is neutrosophic upper semicontinuous. \square

Theorem 2. *The following statements are equivalent for a neutrosophic multifunction $F : (X, \tau) \rightarrow (Y, \tau_1)$:*

1. F is neutrosophic lower semicontinuous;
2. For each $\lambda \in NO(Y)$ and each $x \in F^-(\lambda)$, there exists $U \in O(X, x)$ such that $U \subseteq F^-(\lambda)$;
3. $F^-(\lambda) \in O(X)$ for every $\lambda \in NO(Y)$.
4. $F^+(\delta)$ is a closed set in X for every neutrosophic closed set δ of Y ;
5. $Cl(F^+(\mu)) \subseteq F^+(Cl(\mu))$ for every neutrosophic set μ of Y ;
6. $F(Cl(A)) \leq Cl(F(A))$ for every subset A of X ;

Proof. (1) \Rightarrow (2) Let $\lambda \in NO(Y)$ and $x \in F^-(\lambda)$ with $F(x)q\lambda$. Then by properties-1, there exists $U \in O(X, x)$ such that $U \subseteq F^-(\lambda)$.

(2) \Rightarrow (3) Let $\lambda \in NO(Y)$ and $x \in F^-(\lambda)$. Then by (2), there exists $U \in O(X, x)$ such that $U \subseteq F^-(\lambda)$. Therefore, we have $x \in U \subseteq ClInt(U) \subseteq ClInt(F^-(\lambda))$ and hence $F^-(\lambda) \in O(X)$.

(3) \Rightarrow (4) Let δ be a neutrosophic closed in Y . So we have $X \setminus F^+(\delta) = F^-(1 - \delta) \in O(X)$ and hence $F^+(\delta)$ is closed set in X .

(4) \Rightarrow (5) Let μ be any neutrosophic set in Y . Since $Cl(\mu)$ is neutrosophic closed set in Y , then by (4), we have $F^+(Cl(\mu))$ is closed set in X and $F^+(\mu) \subseteq F^+(Cl(\mu))$. Therefore, we obtain $Cl(F^+(\mu)) \subseteq F^+(Cl(\mu))$.

(5) \Rightarrow (6) Let A be any subset of X . By (5), $Cl(A) \subseteq ClF^+(F(A)) \subseteq F^+(Cl(F(A)))$.

Therefore we obtain $\text{Cl}(A) \subseteq F^+(\text{Cl } F(A))$. This implies that $F(\text{Cl}(A)) \leq \text{Cl } F(A)$.

(6) \Rightarrow (5) Let μ be any neutrosophic set in Y . By (6), $F(\text{Cl } F^+(\mu)) \leq \text{Cl}(F(F^+(\mu)))$ and hence $\text{Cl}(F^+(\mu)) \subseteq F^+(\text{Cl}(F(F^+(\mu)))) \subseteq F^+(\text{Cl}(\mu))$. Therefore $\text{Cl}(F^+(\mu)) \subseteq F^+(\text{Cl}(\mu))$.

(5) \Rightarrow (1) Let $x \in X$ and $\lambda \in \text{NO}(Y)$ with $F(x)q\lambda$. Now, $F^+(1-\lambda) = \{x \in X | F(x) \leq 1-\lambda\}$. So, for x not belongs to $F^+(1-\lambda)$, then we have $F(x) \not\leq 1-\lambda$ and this implies that $F(x)q\lambda$. Therefore, $x \notin F^+(1-\lambda)$. Since $1-\lambda$ is neutrosophic closed set in Y , by (5), $x \notin \text{Cl}(F^+(1-\lambda))$ and there exists $U \in O(X, x)$ such that $\emptyset = U \cap F^+(1-\lambda) = U \cap (X \setminus F^-(\lambda))$. Therefore, we obtain $U \subseteq F^-(\lambda)$. This proves F is neutrosophic lower semicontinuous. \square

Definition 7. For a given neutrosophic multifunction $F : (X, \tau) \rightarrow (Y, \tau_1)$, a neutrosophic multifunction $\text{Cl}(F) : (X, \tau) \rightarrow (Y, \tau_1)$ is defined as $(\text{Cl } F)(x) = \text{Cl } F(x)$ for each $x \in X$.

We use $\text{Cl } F$ and the following Lemma to obtain a characterization of lower neutrosophic semicontinuous multifunction.

Lemma 2. If $F : (X, \tau) \rightarrow (Y, \tau_1)$ is a neutrosophic multifunction, then $(\text{Cl } F)^-(\lambda) = F^-(\lambda)$ for each $\lambda \in \text{NO}(Y)$.

Proof. Let $\lambda \in \text{NO}(Y)$ and $x \in (\text{Cl } F)^-(\lambda)$. This means that $(\text{Cl } F)(x)q\lambda$. Since $\lambda \in \text{NO}(Y)$, we have $F(x)q\lambda$ and hence $x \in F^-(\lambda)$. Therefore $(\text{Cl } F)^-(\lambda) \subseteq F^-(\lambda) \dots (*)$.

Conversely, let $x \in F^-(\lambda)$ since $\lambda \in \text{NO}(Y)$ then $F(x)q\lambda \subseteq (\text{Cl } F)(x)q\lambda$ and hence $x \in (\text{Cl } F)^-(\lambda)$. Therefore $F^-(\lambda) \subseteq (\text{Cl } F)^-(\lambda) \dots (**)$.

From (*) and (**), we get $(\text{Cl } F)^-(\lambda) = F^-(\lambda)$. \square

Theorem 3. A neutrosophic multifunction $F : (X, \tau) \rightarrow (Y, \tau_1)$ is neutrosophic lower semi-continuous if and only if $\text{Cl } F : (X, \tau) \rightarrow (Y, \tau_1)$ is neutrosophic lower semicontinuous.

Proof. Suppose F is neutrosophic lower semicontinuous. Let $\lambda \in \text{NO}(Y)$ and $F(x)q\lambda$. This means that $x \in F^-(\lambda)$. Then there exists $U \in O(X, x)$ such that $U \subseteq F^-(\lambda)$. Therefore, we have $x \in U \subseteq \text{Int}(U) \subseteq \text{Int } F^-(\lambda)$ and hence $F^-(\lambda) \in O(X)$. Then by Lemma 2, we have $U \subseteq F^-(\lambda) = (\text{Cl } F)^-(\lambda)$ and $(\text{Cl } F)^-(\lambda) \in O(X)$, and hence $(\text{Cl } F)(x)q\lambda$. Therefore $\text{Cl } F$ is fuzzy lower semicontinuous. Conversely, suppose $\text{Cl } F$ is neutrosophic lower semicontinuous. If for each $\lambda \in \text{NO}(Y)$ with $(\text{Cl } F)(x)q\lambda$ and $x \in (\text{Cl } F)^-(\lambda)$ then there exists $U \in O(X, x)$ such that $U \subseteq (\text{Cl } F)^-(\lambda)$. By Lemma 2 and Theorem 2, we have $U \subseteq (\text{Cl } F)^-(\lambda) = F^-(\lambda)$ and $F^-(\lambda) \in O(X)$. Therefore F is neutrosophic lower semicontinuous. \square

Definition 8. Given a family $\{F_i : (X, \tau) \rightarrow (Y, \sigma) : i \in I\}$ of neutrosophic multifunctions, we define the union $\bigvee_{i \in I} F_i$ and the intersection $\bigwedge_{i \in I} F_i$ as follows: $\bigvee_{i \in I} F_i : (X, \tau) \rightarrow (Y, \sigma)$, $(\bigvee_{i \in I} F_i)(x) = \bigvee_{i \in I} F_i(x)$ and $\bigwedge_{i \in I} F_i : (X, \tau) \rightarrow (Y, \sigma)$, $(\bigwedge_{i \in I} F_i)(x) = \bigwedge_{i \in I} F_i(x)$.

Theorem 4. If $F_i : X \rightarrow Y$ are neutrosophic upper semi-continuous multifunctions for $i = 1, 2, \dots, n$, then $\bigvee_{i \in I}^n F_i$ is a neutrosophic upper semi-continuous multifunction.

Proof. Let A be a neutrosophic open set of Y . We will show that $(\bigvee_{i \in I}^n F_i)^+(A) = \{x \in X : \bigvee_{i \in I}^n F_i(x) \subset A\}$ is open in X . Let $x \in (\bigvee_{i \in I}^n F_i)^+(A)$. Then $F_i(x) \subset A$ for $i = 1, 2, \dots, n$. Since $F_i : X \rightarrow Y$ is neutrosophic upper semi-continuous multifunction for $i = 1, 2, \dots, n$, then there exists an open set U_x containing x such that for all $z \in U_x$, $F_i(z) \subset A$. Let $U = \bigcup_{i \in I}^n U_x$. Then $U \subset (\bigvee_{i \in I}^n F_i)^+(A)$. Thus, $(\bigvee_{i \in I}^n F_i)^+(A)$ is open and hence $\bigvee_{i \in I}^n F_i$ is a neutrosophic upper semi-continuous multifunction. \square

Lemma 3. *Let $\{A_i\}_{i \in I}$ be a family of neutrosophic sets in a neutrosophic topological space X . Then a neutrosophic point x is quasi-coincident with $\bigvee A_i$ if and only if there exists an $i_0 \in I$ such that xqA_{i_0} .*

Theorem 5. *If $F_i : X \rightarrow Y$ are neutrosophic lower semi-continuous multifunctions for $i = 1, 2, \dots, n$, then $\bigvee_{i \in I}^n F_i$ is a neutrosophic lower semi-continuous multifunction.*

Proof. Let A be a neutrosophic open set of Y . We will show that $(\bigvee_{i \in I}^n F_i)^-(A) = \{x \in X : (\bigvee_{i \in I}^n F_i)(x)qA\}$ is open in X . Let $x \in (\bigvee_{i \in I}^n F_i)^-(A)$. Then $(\bigvee_{i \in I}^n F_i)(x)qA$ and hence $F_{i_0}(x)qA$ for an i_0 . Since $F_i : X \rightarrow Y$ is neutrosophic lower semi-continuous multifunction, there exists an open set U_x containing x such that for all $z \in U_x$, $F_{i_0}(z)qA$. Then $(\bigvee_{i \in I}^n F_i)(z)qA$ and hence $U \subset (\bigvee_{i \in I}^n F_i)^-(A)$. Thus, $(\bigvee_{i \in I}^n F_i)^-(A)$ is open and hence $\bigvee_{i \in I}^n F_i$ is a neutrosophic lower semi-continuous multifunction. \square

Theorem 6. *Let $F : (X, \tau) \rightarrow (Y, \sigma)$ be a neutrosophic multifunction and $\{U_i : i \in I\}$ be an open cover for X . Then the following are equivalent:*

1. $F_i = F|_{U_i}$ is a neutrosophic lower semi-continuous multifunction for all $i \in I$,
2. F is neutrosophic lower semi-continuous.

Proof. (1) \Rightarrow (2): Let $x \in X$ and A be a neutrosophic open set in Y with $x \in F^-(A)$. Since $\{U_i : i \in I\}$ is an open cover for X , then $x \in U_{i_0}$ for an $i_0 \in I$. We have $F(x) = F_{i_0}(x)$ and hence $x \in F_{i_0}^-(A)$. Since $F|_{U_{i_0}}$ is neutrosophic lower semi-continuous, there exists an open set $B = G \cap U_{i_0}$ in U_{i_0} such that $x \in B$ and $F^-(A) \cap U_{i_0} = F|_{U_{i_0}}(A) \supset B = G \cap U_{i_0}$, where G is open in X . We have $x \in B = G \cap U_{i_0} \subset F|_{U_{i_0}}^-(A) = F^-(A) \cap U_{i_0} \subset F^-(A)$. Hence, F is neutrosophic lower semi-continuous.

(2) \Rightarrow (1): Let $x \in X$ and $x \in U_i$. Let A be a neutrosophic open set in Y with $F_i(x)qA$. Since F is lower semi-continuous and $F(x) = F_i(x)$, there exists an open set U containing x such that $U \subset F^-(A)$. Take $B = U_i \cap U$. Then B is open in U_i containing x . We have $B \subset F^{-i}(A)$. Thus F_i is a neutrosophic lower semi-continuous. \square

Theorem 7. *Let $F : (X, \tau) \rightarrow (Y, \sigma)$ be a neutrosophic multifunction and $\{U_i : i \in I\}$ be an open cover for X . Then the following are equivalent:*

1. $F_i = F|_{U_i}$ is a neutrosophic upper semi-continuous multifunction for all $i \in I$,
2. F is neutrosophic upper semi-continuous.

Proof. It is similar to that of Theorem 6. □

Remark 8. A subset A of a topological space (X, τ) can be considered as a neutrosophic set with characteristic function defined by

$$A(x) = \begin{cases} 1 & \text{if } x \in A \\ 0 & \text{if } x \notin A. \end{cases}$$

Let (Y, σ) be a neutrosophic topological space. The neutrosophic sets of the form $A \times B$ with $A \in \tau$ and $B \in \sigma$ form a basis for the product neutrosophic topology $\tau \times \sigma$ on $X \times Y$, where for any $(x, y) \in X \times Y$, $(A \times B)(x, y) = \min\{A(x), B(y)\}$.

Definition 9. For a neutrosophic multifunction $F : (X, \tau) \rightarrow (Y, \sigma)$, the neutrosophic graph multifunction $G_F : X \rightarrow X \times Y$ of F is defined by $G_F(x) = x_1 \times F(x)$ for every $x \in X$.

Theorem 9. If the neutrosophic graph multifunction G_F of a neutrosophic multifunction $F : (X, \tau) \rightarrow (Y, \sigma)$ is neutrosophic lower semi-continuous, then F is neutrosophic lower semi-continuous.

Proof. Suppose that G_F is neutrosophic lower semi-continuous and $x \in X$. Let A be a neutrosophic open set in Y such that $F(x)qA$. Then there exists $y \in Y$ such that $(F(x))(y) + A(y) > 1$. Then $(G_F(x))(x, y) + (X \times A)(x, y) = (F(x))(y) + A(y) > 1$. Hence, $G_F(x)q(X \times A)$. Since G_F is neutrosophic lower semi-continuous, there exists an open set B in X such that $x \in B$ and $G_F(b)q(X \times A)$ for all $b \in B$. Let there exists $b_0 \in B$ such that $F(b_0)qA$. Then for all $y \in Y$, $(F(b_0))(y) + A(y) < 1$. For any $(a, c) \in X \times Y$, we have $(G_F(b_0))(a, c) \subset (F(b_0))(c)$ and $(X \times A)(a, c) \subset A(c)$. Since for all $y \in Y$, $(F(b_0))(y) + A(y) < 1$, $(G_F(b_0))(a, c) + (X \times A)(a, c) < 1$. Thus, $G_F(b_0)q(X \times A)$, where $b_0 \in B$. This is a contradiction since $G_F(b)q(X \times A)$ for all $b \in B$. Hence, F is neutrosophic lower semi-continuous. □

Theorem 10. If the neutrosophic graph multifunction G_F of a neutrosophic multifunction $F : X \rightarrow Y$ is neutrosophic upper semi-continuous, then F is neutrosophic upper semi-continuous.

Proof. Suppose that G_F is neutrosophic upper semi-continuous and let $x \in X$. Let A be neutrosophic open in Y with $F(x) \subset A$. Then $G_F(x) \subset X \times A$. Since G_F is neutrosophic upper semi-continuous, there exists an open set B containing x such that $G_F(B) \subset X \times A$. For any $b \in B$ and $y \in Y$, we have $(F(b))(y) = (G_F(b))(b, y) \subset (X \times A)(b, y) = A(y)$. Then $(F(b))(y) \subset A(y)$ for all $y \in Y$. Thus, $F(b) \subset A$ for any $b \in B$. Hence, F is neutrosophic upper semi-continuous. □

Theorem 11. *Let $F : (X, \tau) \rightarrow (Y, \sigma)$ be a neutrosophic multifunction. Then the following are equivalent:*

1. F is neutrosophic lower semi-continuous,
2. For any $x \in X$ and any net $(x_i)_{i \in I}$ converging to x in X and each neutrosophic open set B in Y with $x \in F^-(B)$, the net $(x_i)_{i \in I}$ is eventually in $F^-(B)$.

Proof. (1) \Rightarrow (2): Let (x_i) be a net converging to x in X and B be any neutrosophic open set in Y with $x \in F^-(B)$. Since F is neutrosophic lower semi-continuous, there exists an open set $A \subset X$ containing x such that $A \subset F^-(B)$. Since $x_i \rightarrow x$, there exists an index $i_0 \in I$ such that $x_i \in A$ for every $i \geq i_0$. We have $x_i \in A \subset F^-(B)$ for all $i \geq i_0$. Hence, $(x_i)_{i \in I}$ is eventually in $F^-(B)$.

(2) \Rightarrow (1): Suppose that F is not neutrosophic lower semi-continuous. There exists a point x and a neutrosophic open set A with $x \in F^-(A)$ such that $B \not\subset F^-(A)$ for any open set $B \subset X$ containing x . Let $x_i \in B$ and $x_i \notin F^-(A)$ for each open set $B \subset X$ containing x . Then the neighborhood net (x_i) converges to x but $(x_i)_{i \in I}$ is not eventually in $F^-(A)$. This is a contradiction. \square

Theorem 12. *Let $F : (X, \tau) \rightarrow (Y, \sigma)$ be a neutrosophic multifunction. Then the following are equivalent:*

1. F is neutrosophic upper semi-continuous,
2. For any $x \in X$ and any net (x_i) converging to x in X and any neutrosophic open set B in Y with $x \in F^+(B)$, the net (x_i) is eventually in $F^+(B)$.

Proof. The proof is similar to that of Theorem 11. \square

Theorem 13. *The set of all points of X at which a neutrosophic multifunction $F : (X, \tau) \rightarrow (Y, \sigma)$ is not neutrosophic upper semi-continuous is identical with the union of the frontier of the upper inverse image of neutrosophic open sets containing $F(x)$.*

Proof. Suppose F is not neutrosophic upper semi-continuous at $x \in X$. Then there exists a neutrosophic open set A in Y containing $F(x)$ such that $A \cap (X \setminus F^+(B)) \neq \emptyset$ for every open set A containing x . We have $x \in \text{Cl}(X \setminus F^+(B)) = X \setminus \text{Int}(F^+(B))$ and $x \in F^+(B)$. Thus, $x \in \text{Fr}(F^+(B))$. Conversely, let B be a neutrosophic open set in Y containing $F(x)$ with $x \in \text{Fr}(F^+(B))$. Suppose that F is neutrosophic upper semi-continuous at x . There exists an open set A containing x such that $A \subset F^+(B)$. We have $x \in \text{Int}(F^+(B))$. This is a contradiction. Thus, F is not neutrosophic upper semi-continuous at x . \square

Theorem 14. *The set of all points of X at which a neutrosophic multifunction $F : (X, \tau) \rightarrow (Y, \sigma)$ is not neutrosophic lower semi-continuous is identical with the union of the frontier of the lower inverse image of neutrosophic closed sets which are quasi-coincident with $F(x)$.*

Proof. It is similar to that of Theorem 13. □

Definition 10. A neutrosophic set λ of a neutrosophic topological space Y is said to be neutrosophic compact relative to Y if every cover $\{\lambda_\alpha\}_{\alpha \in \Delta}$ of λ by neutrosophic open sets of Y has a finite subcover $\{\lambda_i\}_{i=1}^n$ of λ .

Definition 11. A neutrosophic set λ of a neutrosophic topological space Y is said to be neutrosophic Lindelof relative to Y if every cover $\{\lambda_\alpha\}_{\alpha \in \Delta}$ of λ by neutrosophic open sets of Y has a countable subcover $\{\lambda_n\}_{n \in \mathbb{N}}$ of λ .

Definition 12. A neutrosophic topological space Y is said to be neutrosophic compact if χ_Y (characteristic function of Y) is neutrosophic compact relative to Y .

Definition 13. A neutrosophic topological space Y is said to be neutrosophic Lindelof if χ_Y (characteristic function of Y) is neutrosophic Lindelof relative to Y .

Definition 14. A neutrosophic multifunction $F : (X, \tau) \rightarrow (Y, \tau_1)$ is said to be punctually neutrosophic compact (resp. punctually neutrosophic Lindelof) if for each $x \in X$, $F(x)$ is neutrosophic compact (resp. neutrosophic Lindelof).

Theorem 15. Let the neutrosophic multifunction $F : (X, \tau) \rightarrow (Y, \tau_1)$ be a neutrosophic upper semicontinuous and F is punctually neutrosophic compact. If A is compact relative to X , then $F(A)$ is neutrosophic compact relative to Y .

Proof. Let $\{\lambda_\alpha | \alpha \in \Delta\}$ be any cover of $F(Z)$ by neutrosophic open sets of Y . We claim that $F(A)$ is neutrosophic compact relative to Y . For each $x \in A$, there exists a finite subset $\Delta(x)$ of Δ such that $F(x) \leq \cup\{\lambda_\alpha | \alpha \in \Delta(x)\}$. Put $\lambda(x) = \cup\{\lambda_\alpha | \alpha \in \Delta(x)\}$. Then $F(x) \leq \lambda(x) \in NO(Y)$ and there exists $U(x) \in O(X, x)$ such that $F(U(x)) \leq \lambda(x)$. Since $\{U(x) | x \in A\}$ is an open cover of A there exists a finite number of A , say, x_1, x_2, \dots, x_n such that $A \subseteq \cup\{U(x_i) | i = 1, 2, \dots, n\}$. Therefore we obtain $F(A) \leq F(\bigcup_{i=1}^n U(x_i)) \leq \bigcup_{i=1}^n F(U(x_i)) \leq \bigcup_{i=1}^n \lambda(x_i) \leq \bigcup_{i=1}^n (\bigcup_{\alpha \in \Delta(x_i)} \lambda_\alpha)$. This shows that $F(A)$ is neutrosophic compact relative to Y . □

Theorem 16. Let the neutrosophic multifunction $F : (X, \tau) \rightarrow (Y, \tau_1)$ be a neutrosophic upper semicontinuous and F is punctually neutrosophic Lindelof. If A is Lindelof relative to X , then $F(A)$ is neutrosophic Lindelof relative to Y .

Proof. The proof is similar to that of Theorem 15 □

REFERENCES

- Abdel-Basset, M., Mohamed, M., Smarandache, F., & Chang, V. (2018). Neutrosophic Association Rule Mining Algorithm for Big Data Analysis. *Symmetry*, 10(4), 106.
- Abdel-Basset, M., & Mohamed, M. (2018). The Role of Single Valued Neutrosophic Sets and Rough Sets in Smart City: Imperfect and Incomplete Information Systems. *Measurement*. Volume 124, August 2018, Pages 47-55
- Abdel-Basset, M., Gunasekaran, M., Mohamed, M., & Smarandache, F. A novel method for solving the fully neutrosophic linear programming problems. *Neural Computing and Applications*, 1-11.
- Abdel-Basset, M., Manogaran, G., Gamal, A., & Smarandache, F. (2018). A hybrid approach of neutrosophic sets and DEMATEL method for developing supplier selection criteria. *Design Automation for Embedded Systems*, 1-22.
- Abdel-Basset, M., Mohamed, M., & Chang, V. (2018). NMCDA: A framework for evaluating cloud computing services. *Future Generation Computer Systems*, 86, 12-29.
- Abdel-Basset, M., Mohamed, M., Zhou, Y., & Hezam, I. (2017). Multi-criteria group decision making based on neutrosophic analytic hierarchy process. *Journal of Intelligent & Fuzzy Systems*, 33(6), 4055-4066.
- Abdel-Basset, M.; Mohamed, M.; Smarandache, F. An Extension of Neutrosophic AHP–SWOT Analysis for Strategic Planning and Decision-Making. *Symmetry* 2018, 10, 116.
- Salama, A., & Alblowi, S. (2012). Neutrosophic set and neutrosophic topological spaces. *IOSR Journal of Mathematics (IOSR-JM)*, 3(4), 31–35.
- Smarandache, F. (1999). *Neutrosophy: A unifying field in logics: Neutrosophic logic. neutrosophy, neutrosophic set, neutrosophic probability*. Rehoboth: American Research Press.
- Smarandache, F. (Ed.). (2001). *Neutrosophy , neutrosophic logic, set, probability, and statistics*. University of New Mexico, Gallup, NM 87301, USA: University of New Mexico, Gallup.
- Smarandache, F. (2007). *A unifying field in logics: Neutrosophic logic. neutrosophy, neutrosophic set, neutrosophic probability*. ProQuest Information & Learning.

Generalized Neutrosophic Contra-Continuity

^{1*} R. Dhavaseelan, ²S. Jafari, ³C. Özel and ⁴M. A. Al-Shumrani

^{1*}Department of Mathematics, Sona College of Technology,
Salem-636005, Tamil Nadu, India.

²Department of Mathematics, College of Vestsjaelland South,
Herrestraede 11, 4200 Slagelse, Denmark

^{3,4}Department of Mathematics, King Abdulaziz University,
P. O. Box: 80203 Jeddeh 21589, K. S. A.

e-mail : ¹ dhavaseelan.r@gmail.com, ² jafaripersia@gmail.com.

³ cozel@kau.edu.sa, ⁴ maalshumrani@kau.edu.sa

ABSTRACT

In this paper, the concepts of generalized neutrosophic contra-continuous function, generalized neutrosophic contra-irresolute function and strongly generalized neutrosophic contra-continuous function are introduced. Some interesting properties are also studied.

KEYWORDS: Generalized neutrosophic contra-continuity, strongly generalized neutrosophic contra-continuity, generalized neutrosophic contra-irresolute.

1 INTRODUCTION

The notion of a fuzzy set has influenced almost all branches of mathematics since its introduction by Zadeh (1965). Fuzzy sets have applications in many fields such as information theory (Smets, 1981) and control theory (Sugeno, 1985). The theory of fuzzy topological space was introduced and developed by Chang (1968) and since then various notions in classical topology have been extended to fuzzy topological space. The idea of “intuitionistic fuzzy set” was first published by Atanassov (1983) and many

works by the same author and his colleagues appeared in the literature (Atanassov (1986, 1988); Atanassov and Stoeva (1983)). Later, this concept was generalized to "intuitionistic L-fuzzy sets" by Atanassov and Stoeva (1984). The concepts of "fuzzy contra-continuity" was introduced by Ekici and Kerre (2006). The concepts of generalized intuitionistic fuzzy closed set was introduced by Dhavaseelan et al. (2010) and also discussed contra-continuity (Dhavaseelan et al. (2012)). After the introduction of the concepts of neutrosophy and neutrosophic set by Smarandache (1999, 2000), the concepts of neutrosophic crisp sets and neutrosophic crisp topological spaces were introduced by Salama and Alblowi (2012).

In this paper, the concepts of generalized neutrosophic contra-continuous function, generalized neutrosophic contra-irresolute function and strongly generalized neutrosophic contra-continuous function are introduced by using the concept studied in (Dhavaseelan et al. (20xx)). Several interesting properties and characterizations are discussed. Further, interrelations among the concepts introduced are established with interesting counter examples.

2 NEUTROSOPHIC TOPOLOGY

Definition 2.1. Let T, I, F be real standard or non standard subsets of $]0^-, 1^+[$, with

$$sup_T = t_{sup}, inf_T = t_{inf}$$

$$sup_I = i_{sup}, inf_I = i_{inf}$$

$$sup_F = f_{sup}, inf_F = f_{inf}$$

$$n - sup = t_{sup} + i_{sup} + f_{sup}$$

$$n - inf = t_{inf} + i_{inf} + f_{inf} . T, I, F \text{ are neutrosophic components.}$$

Definition 2.2. Let X be a nonempty fixed set. A neutrosophic set [NS for short] A is an object having the form $A = \{ \langle x, \mu_A(x), \sigma_A(x), \gamma_A(x) \rangle : x \in X \}$, where $\mu_A(x)$, $\sigma_A(x)$ and $\gamma_A(x)$ which represents the degree of membership function (namely $\mu_A(x)$), the degree of indeterminacy (namely $\sigma_A(x)$) and the degree of nonmembership (namely $\gamma_A(x)$) respectively of each element $x \in X$ to the set A .

Remark 2.1. (1) A neutrosophic set $A = \{ \langle x, \mu_A(x), \sigma_A(x), \gamma_A(x) \rangle : x \in X \}$ can be identified to an ordered triple $\langle \mu_A, \sigma_A, \gamma_A \rangle$ in $]0^-, 1^+[$ on X .

(2) For the sake of simplicity, we shall use the symbol $A = \langle \mu_A, \sigma_A, \gamma_A \rangle$ for the neutrosophic set $A = \{ \langle x, \mu_A(x), \sigma_A(x), \gamma_A(x) \rangle : x \in X \}$.

Definition 2.3. Let X be a nonempty set and the neutrosophic sets A and B in the form

$$A = \{\langle x, \mu_A(x), \sigma_A(x), \gamma_A(x) \rangle : x \in X\}, B = \{\langle x, \mu_B(x), \sigma_B(x), \gamma_B(x) \rangle : x \in X\}. \text{ Then}$$

- (a) $A \subseteq B$ iff $\mu_A(x) \leq \mu_B(x)$, $\sigma_A(x) \leq \sigma_B(x)$ and $\gamma_A(x) \geq \gamma_B(x)$ for all $x \in X$;
- (b) $A = B$ iff $A \subseteq B$ and $B \subseteq A$;
- (c) $\bar{A} = \{\langle x, \gamma_A(x), \sigma_A(x), \mu_A(x) \rangle : x \in X\}$; [Complement of A]
- (d) $A \cap B = \{\langle x, \mu_A(x) \wedge \mu_B(x), \sigma_A(x) \wedge \sigma_B(x), \gamma_A(x) \vee \gamma_B(x) \rangle : x \in X\}$;
- (e) $A \cup B = \{\langle x, \mu_A(x) \vee \mu_B(x), \sigma_A(x) \vee \sigma_B(x), \gamma_A(x) \wedge \gamma_B(x) \rangle : x \in X\}$;
- (f) $[]A = \{\langle x, \mu_A(x), \sigma_A(x), 1 - \mu_A(x) \rangle : x \in X\}$;
- (g) $\langle \rangle A = \{\langle x, 1 - \gamma_A(x), \sigma_A(x), \gamma_A(x) \rangle : x \in X\}$.

Definition 2.4. Let $\{A_i : i \in J\}$ be an arbitrary family of neutrosophic sets in X . Then

- (a) $\bigcap A_i = \{\langle x, \wedge \mu_{A_i}(x), \wedge \sigma_{A_i}(x), \vee \gamma_{A_i}(x) \rangle : x \in X\}$;
- (b) $\bigcup A_i = \{\langle x, \vee \mu_{A_i}(x), \vee \sigma_{A_i}(x), \wedge \gamma_{A_i}(x) \rangle : x \in X\}$.

Since our main purpose is to construct the tools for developing neutrosophic topological spaces, we must introduce the neutrosophic sets 0_N and 1_N in X as follows:

Definition 2.5. $0_N = \{\langle x, 0, 0, 1 \rangle : x \in X\}$ and $1_N = \{\langle x, 1, 1, 0 \rangle : x \in X\}$.

Definition 2.6. [9] A neutrosophic topology (NT) on a nonempty set X is a family T of neutrosophic sets in X satisfying the following axioms:

- (i) $0_N, 1_N \in T$,
- (ii) $G_1 \cap G_2 \in T$ for any $G_1, G_2 \in T$,
- (iii) $\cup G_i \in T$ for arbitrary family $\{G_i \mid i \in \Lambda\} \subseteq T$.

In this case the ordered pair (X, T) or simply X is called a neutrosophic topological space (NTS) and each neutrosophic set in T is called a neutrosophic open set (NOS). The complement \bar{A} of a NOS A in X is called a neutrosophic closed set (NCS) in X .

Definition 2.7. [9] Let A be a neutrosophic set in a neutrosophic topological space X . Then

$Nint(A) = \bigcup\{G \mid G \text{ is a neutrosophic open set in } X \text{ and } G \subseteq A\}$ is called the neutrosophic interior of A ;

$Ncl(A) = \bigcap\{G \mid G \text{ is a neutrosophic closed set in } X \text{ and } G \supseteq A\}$ is called the neutrosophic closure of A .

Definition 2.8. Let X be a nonempty set. If r, t, s are real standard or non standard subsets of $]0^-, 1^+[$ then the neutrosophic set $x_{r,t,s}$ is called a neutrosophic point (in short NP) in X given by

$$x_{r,t,s}(x_p) = \begin{cases} (r, t, s), & \text{if } x = x_p \\ (0, 0, 1), & \text{if } x \neq x_p \end{cases}$$

For $x_p \in X$, it is called the support of $x_{r,t,s}$, where r denotes the degree of membership value, t denotes the degree of indeterminacy and s is the degree of non-membership value of $x_{r,t,s}$.

3 GENERALIZED NEUTROSOPHIC CONTRA-CONTINUOUS FUNCTIONS

Definition 3.1. Let (X, T) and (Y, S) be any two neutrosophic topological spaces.

- (i) A function $f : (X, T) \rightarrow (Y, S)$ is called neutrosophic contra-continuous if the inverse image of every neutrosophic open set in (Y, S) is a neutrosophic closed set in (X, T) .

Equivalently if the inverse image of every neutrosophic closed set in (Y, S) is a neutrosophic open set in (X, T) .

- (ii) A function $f : (X, T) \rightarrow (Y, S)$ is called generalized neutrosophic contra-continuous if the inverse image of every neutrosophic open set in (Y, S) is a generalized neutrosophic closed set in (X, T) .

Equivalently if the inverse image of every neutrosophic closed set in (Y, S) is a generalized neutrosophic open set in (X, T) .

- (iii) A function $f : (X, T) \rightarrow (Y, S)$ is called generalized neutrosophic contra-irresolute if the inverse image of every generalized neutrosophic closed set in (Y, S) is a

generalized neutrosophic open set in (X, T) .

Equivalently if the inverse image of every generalized neutrosophic open set in (Y, S) is a generalized neutrosophic closed set in (X, T) .

- (iv) A function $f : (X, T) \rightarrow (Y, S)$ is called strongly generalized neutrosophic contra-continuous if the inverse image of every generalized neutrosophic open set in (Y, S) is a neutrosophic closed set in (X, T) .

Equivalently if the inverse image of every generalized neutrosophic closed set in (Y, S) is a neutrosophic open set in (X, T) .

Proposition 3.1. Let $f : (X, T) \rightarrow (Y, S)$ be a bijective function. Then f is a generalized neutrosophic contra-continuous function if $Ncl(f(A)) \subseteq f(NGint(A))$ for every neutrosophic set A in (X, T) .

Proof. Let A be a neutrosophic closed set in (Y, S) . Then $Ncl(A) = A$ and $f^{-1}(A)$ is a neutrosophic set in (X, T) . By hypothesis, $Ncl(f(f^{-1}(A))) \subseteq f(NGint(f^{-1}(A)))$. Since f is onto, $f(f^{-1}(A)) = A$. Therefore, $A = Ncl(A) = Ncl(f(f^{-1}(A))) \subseteq f(NGint(f^{-1}(A)))$. Now, $A \subseteq f(NGint(f^{-1}(A)))$, $f^{-1}(A) \subseteq f^{-1}(f(NGint(f^{-1}(A)))) = NGint(f^{-1}(A)) \subseteq f^{-1}(A)$. Hence, $f^{-1}(A)$ is a generalized neutrosophic open set in (X, T) . Thus, f is a generalized neutrosophic contra-continuous function. \square

Proposition 3.2. Let (X, T) and (Y, S) be any two neutrosophic topological spaces. Let $f : (X, T) \rightarrow (Y, S)$ be a function. Suppose that one of the following properties hold.

- (i) $f(NGcl(A)) \subseteq Nint(f(A))$, for each neutrosophic set A in (X, T) .
- (ii) $NGcl(f^{-1}(B)) \subseteq f^{-1}(Nint(B))$, for each neutrosophic set B in (Y, S) .
- (iii) $f^{-1}(Ncl(B)) \subseteq NGint(f^{-1}(B))$, for each neutrosophic set B in (Y, S) .

Then f is a generalized neutrosophic contra-continuous function.

Proof. (i) \Rightarrow (ii) Let B be a neutrosophic set in (Y, S) , then $A = f^{-1}(B)$ is a neutrosophic set in (X, T) . By hypothesis, $f(NGcl(A)) \subseteq Nint(f(A))$, $f(NGcl(f^{-1}(B))) \subseteq Nint(f(f^{-1}(B))) \subseteq Nint(B)$. Now, $f(NGcl(f^{-1}(B))) \subseteq Nint(B)$. Therefore, $NGcl(f^{-1}(B)) \subseteq f^{-1}(Nint(B))$.

(ii) \Rightarrow (iii) Let B be a neutrosophic set in (Y, S) , then $f^{-1}(B)$ is a neutrosophic set in (X, T) . By hypothesis, $NGcl(f^{-1}(B)) \subseteq f^{-1}(Nint(B))$. Taking complement $\overline{NGcl(f^{-1}(B))} \supseteq \overline{f^{-1}(Nint(B))}$, $NGint(\overline{f^{-1}(B)}) \supseteq f^{-1}(\overline{Nint(B)})$, $NGint(f^{-1}(\overline{B})) \supseteq f^{-1}(Ncl(\overline{B}))$.

Suppose that (iii) holds. Let A be a neutrosophic closed set in (Y, S) . Then $Ncl(A) = A$ and $f^{-1}(A)$ is a neutrosophic set in (X, T) . Now, $f^{-1}(A) = f^{-1}(Ncl(A)) \subseteq NGint(f^{-1}(A)) \subseteq f^{-1}(A)$. Therefore, $f^{-1}(A)$ is a generalized neutrosophic open set in (X, T) . Thus, f is a generalized neutrosophic contra-continuous function. \square

Proposition 3.3. Let (X, T) and (Y, S) be any two neutrosophic topological spaces. Let $f : (X, T) \rightarrow (Y, S)$ be a function. Suppose that one of the following properties hold.

- (i) $f^{-1}(NGcl(B)) \subseteq NGint(NGcl(f^{-1}(B)))$ for each neutrosophic set B in (Y, S) .
- (ii) $NGcl(NGint(f^{-1}(B))) \subseteq f^{-1}(NGint(B))$ for each neutrosophic set B in (Y, S) .
- (iii) $f(NGcl(NGint(A))) \subseteq NGint(f(A))$ for each neutrosophic set A in (X, T) .
- (iv) $f(NGcl(A)) \subseteq NGint(f(A))$ for each neutrosophic set A in (X, T) .

Then f is a generalized neutrosophic contra-continuous function.

Proof. (i) \Rightarrow (ii) Let B be a neutrosophic set in (Y, S) . Then $f^{-1}(B)$ is a neutrosophic set in (X, T) . By hypothesis, $f^{-1}(NGcl(B)) \subseteq NGint(NGcl(f^{-1}(B)))$. Taking complement $\overline{f^{-1}(NGcl(B))} \supseteq \overline{NGint(NGcl(f^{-1}(B)))}$, $f^{-1}(\overline{NGcl(B)}) \supseteq \overline{NGcl(NGcl(f^{-1}(B)))}$, $f^{-1}(NGint(\overline{B})) \supseteq NGcl(NGint(\overline{f^{-1}(B)}))$, $f^{-1}(NGint(\overline{B})) \supseteq NGcl(NGint(f^{-1}(\overline{B})))$. Thus, $NGcl(NGint(f^{-1}(\overline{B}))) \subseteq f^{-1}(NGint(\overline{B}))$.

(ii) \Rightarrow (iii) Let A be a neutrosophic set in (X, T) . Put $B = f(A)$, then $A \subseteq f^{-1}(B)$. By hypothesis, $NGcl(NGint(A)) \subseteq NGcl(NGint(f^{-1}(B))) \subseteq f^{-1}(NGint(B))$, $NGcl(NGint(A)) \subseteq f^{-1}(NGint(B))$. Therefore, $f(NGcl(NGint(A))) \subseteq NGint(B) = NGint(f(A))$. This means that $f(NGcl(NGint(A))) \subseteq NGint(f(A))$.

(iii) \Rightarrow (iv) Let A be any generalized neutrosophic open set of (X, T) . Then $NGint(A) = A$. By hypothesis, $f(NGcl(A)) = f(NGcl(NGint(A))) \subseteq NGint(f(A))$. Thus, $f(NGcl(A)) \subseteq NGint(f(A))$.

Suppose that **(iv)** holds. Let B be a neutrosophic open set in (Y, S) . Then, $f^{-1}(B) = A$ is a neutrosophic set in (X, T) . By hypothesis, $f(NGcl(A)) \subseteq NGint(f(A))$. Now, $f(NGcl(A)) \subseteq NGint(f(A)) \subseteq f(A)$, $f(NGcl(A)) \subseteq f(A)$, $NGcl(A) \subseteq f^{-1}(f(A)) = A$. This means that $NGcl(A) \subseteq A$. But $A \subseteq NGcl(A)$. Hence $A = NGcl(A)$. Thus, A is a generalized neutrosophic closed set in (X, T) . Hence, f is a generalized neutrosophic contra-continuous function. \square

Proposition 3.4. Let (X, T) and (Y, S) be any two neutrosophic topological spaces. If $f : (X, T) \rightarrow (Y, S)$ is a neutrosophic contra-continuous function then it is a generalized neutrosophic contra-continuous function.

Proof. Let A be a neutrosophic open set in (Y, S) . Since f is a neutrosophic contra-continuous function, $f^{-1}(A)$ is a neutrosophic closed set in (X, T) . Every neutrosophic closed set is a generalized neutrosophic closed set. Now, $f^{-1}(A)$ is a generalized neutrosophic closed set. Hence, f is a generalized neutrosophic contra-continuous function.

The converse of Proposition 3.4., need not be true. See Example 3.1. \square

Example 3.1. Let $X = \{a, b, c\}$. Define the neutrosophic sets A and B in X as follows:

$$A = \langle x, (\frac{a}{0.4}, \frac{b}{0.5}, \frac{c}{0.4}), (\frac{a}{0.4}, \frac{b}{0.5}, \frac{c}{0.4}), (\frac{a}{0.4}, \frac{b}{0.4}, \frac{c}{0.4}) \rangle, \text{ and}$$

$$B = \langle x, (\frac{a}{0.3}, \frac{b}{0.4}, \frac{c}{0.3}), (\frac{a}{0.3}, \frac{b}{0.4}, \frac{c}{0.3}), (\frac{a}{0.5}, \frac{b}{0.6}, \frac{c}{0.7}) \rangle.$$

Then the families $T = \{0_N, 1_N, A\}$ and $S = \{0_N, 1_N, B\}$ are neutrosophic topologies on X . Thus, (X, T) and (X, S) are neutrosophic topological spaces. Define $f : (X, T) \rightarrow (X, S)$ by $f(a) = b, f(b) = a, f(c) = c$. Then f is a generalized neutrosophic contra-continuous function. Now, $f^{-1}(B)$ is not a neutrosophic closed set in (X, T) for $B \in S$. Hence, f is not a neutrosophic contra-continuous function.

Proposition 3.5. Let (X, T) and (Y, S) be any two neutrosophic topological spaces. If $f : (X, T) \rightarrow (Y, S)$ is a generalized neutrosophic contra-irresolute function then it is a generalized neutrosophic contra-continuous function.

Proof. Let A be a neutrosophic open set in (Y, S) . Every neutrosophic open set is a generalized neutrosophic open set. Since f is a generalized neutrosophic contra-irresolute function, $f^{-1}(A)$ is a generalized neutrosophic closed set in (X, T) . Thus, f is a generalized neutrosophic contra-continuous function.

The converse of Proposition 3.5 need not be true as shown in Example 3.2. \square

Example 3.2. Let $X = \{a, b, c\}$. Define the neutrosophic sets A,B and C in X as follows: $A = \langle x, (\frac{a}{0.4}, \frac{b}{0.4}, \frac{c}{0.5}), (\frac{a}{0.4}, \frac{b}{0.4}, \frac{c}{0.5}), (\frac{a}{0.5}, \frac{b}{0.5}, \frac{c}{0.5}) \rangle$,
 $B = \langle x, (\frac{a}{0.7}, \frac{b}{0.6}, \frac{c}{0.5}), (\frac{a}{0.7}, \frac{b}{0.6}, \frac{c}{0.5}), (\frac{a}{0.3}, \frac{b}{0.4}, \frac{c}{0.5}) \rangle$ and
 $C = \langle x, (\frac{a}{0.4}, \frac{b}{0.5}, \frac{c}{0.5}), (\frac{a}{0.4}, \frac{b}{0.5}, \frac{c}{0.5}), (\frac{a}{0.4}, \frac{b}{0.5}, \frac{c}{0.5}) \rangle$.

Then the families $T = \{0_N, 1_N, A, B\}$ and $S = \{0_N, 1_N, C\}$ are neutrosophic topologies on X. Thus, (X, T) and (X, S) are neutrosophic topological spaces. Define $f : (X, T) \rightarrow (X, S)$ as follows: $f(a) = b, f(b) = a, f(c) = c$. Then f is a generalized neutrosophic contra-continuous function. Let $D = \langle x, (\frac{a}{0.3}, \frac{b}{0.4}, \frac{c}{0.5}), (\frac{a}{0.3}, \frac{b}{0.4}, \frac{c}{0.5}), (\frac{a}{0.5}, \frac{b}{0.5}, \frac{c}{0.5}) \rangle$ be a generalized neutrosophic closed set in (X, S) , $f^{-1}(D)$ is not a generalized neutrosophic open set in (X, T) . Hence, f is not a generalized neutrosophic contra-irresolute function.

Proposition 3.6. Let (X, T) and (Y, S) be any two neutrosophic topological spaces. If $f : (X, T) \rightarrow (Y, S)$ is a strongly generalized neutrosophic contra-continuous function then f is a neutrosophic contra-continuous function.

Proof. Let A be a neutrosophic open set in (Y, S) . Every neutrosophic open set is a generalized neutrosophic open set. Thus A is a generalized neutrosophic open set in (Y, S) . Since f is a strongly generalized neutrosophic contra-continuous function, $f^{-1}(A)$ is a neutrosophic closed set in (X, T) . Hence, f is a neutrosophic contra-continuous function.

The converse of Proposition 3.6 need not be true as it is shown in Example 3.3. \square

Example 3.3. Let $X = \{a, b, c\}$. Define the neutrosophic sets A,B and C as follows:
 $A = \langle x, (\frac{a}{0.3}, \frac{b}{0.2}, \frac{c}{0.2}), (\frac{a}{0.3}, \frac{b}{0.2}, \frac{c}{0.2}), (\frac{a}{0.4}, \frac{b}{0.5}, \frac{c}{0.5}) \rangle$,
 $B = \langle x, (\frac{a}{0.1}, \frac{b}{0.1}, \frac{c}{0.1}), (\frac{a}{0.1}, \frac{b}{0.1}, \frac{c}{0.1}), (\frac{a}{0.9}, \frac{b}{0.9}, \frac{c}{0.9}) \rangle$ and
 $C = \langle x, (\frac{a}{0.9}, \frac{b}{0.9}, \frac{c}{0.9}), (\frac{a}{0.9}, \frac{b}{0.9}, \frac{c}{0.9}), (\frac{a}{0.1}, \frac{b}{0.1}, \frac{c}{0.1}) \rangle$.

The families $T = \{0_N, 1_N, A, B\}$ and $S = \{0_N, 1_N, C\}$ are neutrosophic topologies on X. Thus, (X, T) and (X, S) are neutrosophic topological spaces. Define $f : (X, T) \rightarrow (X, S)$ as follows: $f(a) = a, f(b) = b, f(c) = b$. Then f is a neutrosophic contra-continuous function. But, for a generalized neutrosophic open set $D = \langle x, (\frac{a}{0.9}, \frac{b}{0.99}, \frac{c}{0.9}), (\frac{a}{0.9}, \frac{b}{0.99}, \frac{c}{0.9}) \rangle$, in (X, S) , $f^{-1}(D)$ is not a neutrosophic closed set in (X, T) . Hence, f is not a strongly generalized neutrosophic contra-continuous function.

Proposition 3.7. Let (X, T) and (Y, S) be any two neutrosophic topological spaces. If $f : (X, T) \rightarrow (Y, S)$ is a strongly generalized neutrosophic contra-continuous function then f is a generalized neutrosophic contra-continuous function.

Proof. Let A be a neutrosophic open set in (Y, S) . Every neutrosophic open set is a generalized neutrosophic open set. Therefore A is a generalized neutrosophic open set in (Y, S) . Since f is a strongly generalized neutrosophic contra-continuous function, $f^{-1}(A)$ is a neutrosophic closed set in (X, T) . Every neutrosophic closed set is a generalized neutrosophic closed set. Hence, f is a generalized neutrosophic contra-continuous function.

The converse of Proposition 3.7 need not be true. See Example 3.4. □

Example 3.4. Let $X = \{a, b, c\}$. Define the neutrosophic sets A, B and C as follows:

$$A = \langle x, (\frac{a}{0.4}, \frac{b}{0.5}, \frac{c}{0.5}), (\frac{a}{0.4}, \frac{b}{0.5}, \frac{c}{0.5}), (\frac{a}{0.5}, \frac{b}{0.5}, \frac{c}{0.5}) \rangle,$$

$$B = \langle x, (\frac{a}{0.6}, \frac{b}{0.7}, \frac{c}{0.5}), (\frac{a}{0.6}, \frac{b}{0.7}, \frac{c}{0.5}), (\frac{a}{0.4}, \frac{b}{0.3}, \frac{c}{0.5}) \rangle \text{ and}$$

$$C = \langle x, (\frac{a}{0.4}, \frac{b}{0.4}, \frac{c}{0.5}), (\frac{a}{0.4}, \frac{b}{0.4}, \frac{c}{0.5}), (\frac{a}{0.4}, \frac{b}{0.4}, \frac{c}{0.5}) \rangle.$$

The families $T = \{0_N, 1_N, A, B\}$ and $S = \{0_N, 1_N, C\}$ are neutrosophic topologies on X . Thus, (X, T) and (X, S) are neutrosophic topological spaces. Define $f : (X, T) \rightarrow (X, S)$ as follows: $f(a) = c, f(b) = c, f(c) = c$. Then f is a generalized neutrosophic contra-continuous function. Let $D = \langle x, (\frac{a}{0.4}, \frac{b}{0.5}, \frac{c}{0.5}), (\frac{a}{0.4}, \frac{b}{0.5}, \frac{c}{0.5}), (\frac{a}{0.4}, \frac{b}{0.4}, \frac{c}{0.3}) \rangle$ be a generalized neutrosophic open set in (X, S) , then $f^{-1}(D)$ is not a neutrosophic closed set in (X, T) . Hence, f is not a strongly generalized neutrosophic contra-continuous function.

Proposition 3.8. Let (X, T) and (Y, S) be any two neutrosophic topological spaces. If $f : (X, T) \rightarrow (Y, S)$ is a strongly generalized neutrosophic contra-continuous function, then f is a generalized neutrosophic contra-irresolute function.

Proof. Let A be a generalized neutrosophic open set in (Y, S) . Since f is a strongly generalized neutrosophic contra-continuous function, $f^{-1}(A)$ is a neutrosophic closed set in (X, T) . Every neutrosophic closed set is a generalized neutrosophic closed set. Now, $f^{-1}(A)$ is a generalized neutrosophic closed set in (X, T) . Hence, f is a generalized neutrosophic contra-irresolute function.

The converse of Proposition 3.8 need not be true as it is shown in Example 3.5. □

Example 3.5. Let $X = \{a, b, c\}$. Define the neutrosophic sets A, B and C as follows:

$$A = \langle x, (\frac{a}{0.4}, \frac{b}{0.4}, \frac{c}{0.5}), (\frac{a}{0.4}, \frac{b}{0.4}, \frac{c}{0.5}), (\frac{a}{0.5}, \frac{b}{0.5}, \frac{c}{0.5}) \rangle,$$

$$B = \langle x, (\frac{a}{0.7}, \frac{b}{0.6}, \frac{c}{0.5}), (\frac{a}{0.7}, \frac{b}{0.6}, \frac{c}{0.5}), (\frac{a}{0.3}, \frac{b}{0.4}, \frac{c}{0.5}) \rangle \text{ and}$$

$$C = \langle x, (\frac{a}{0.4}, \frac{b}{0.5}, \frac{c}{0.5}), (\frac{a}{0.4}, \frac{b}{0.5}, \frac{c}{0.5}), (\frac{a}{0.4}, \frac{b}{0.5}, \frac{c}{0.5}) \rangle.$$

The families $T = \{0_N, 1_N, A, B\}$ and $S = \{0_N, 1_N, C\}$ are neutrosophic topologies on

X. Thus, (X, T) and (X, S) are neutrosophic topological spaces. Define $f : (X, T) \rightarrow (X, S)$ as follows: $f(a) = b, f(b) = a, f(c) = c$. Then f is a generalized neutrosophic contra-irresolute function. But, for a generalized neutrosophic closed set $D = \langle x, (\frac{a}{0.3}, \frac{b}{0.4}, \frac{c}{0.5}), (\frac{a}{0.3}, \frac{b}{0.4}, \frac{c}{0.5}), (\frac{a}{0.5}, \frac{b}{0.5}, \frac{c}{0.5}) \rangle$ in (X, S) . $f^{-1}(D)$ is not a neutrosophic open set in (X, T) . Hence, f is not a strongly generalized neutrosophic contra-continuous function.

Proposition 3.9. Let $(X, T), (Y, S)$ and (Z, R) be any three neutrosophic topological spaces. Let $f : (X, T) \rightarrow (Y, S)$ and $g : (Y, S) \rightarrow (Z, R)$ be functions. If f is a generalized neutrosophic contra-irresolute function and g is a generalized neutrosophic contra-continuous function, then $g \circ f$ is a generalized neutrosophic continuous function.

Proof. Let A be a neutrosophic open set in (Z, R) . Since g is a generalized neutrosophic contra-continuous function, $g^{-1}(A)$ is a generalized neutrosophic closed set in (Y, S) . Since f is a generalized neutrosophic contra-irresolute function, $f^{-1}(g^{-1}(A))$ is a generalized neutrosophic open set in (X, T) . Hence, $g \circ f$ is a generalized neutrosophic continuous function. \square

Proposition 3.10. Let $(X, T), (Y, S)$ and (Z, R) be any three neutrosophic topological spaces. Let $f : (X, T) \rightarrow (Y, S)$ and $g : (Y, S) \rightarrow (Z, R)$ be functions. If f is a generalized neutrosophic contra-irresolute function and g is a generalized neutrosophic continuous function, then $g \circ f$ is a generalized neutrosophic contra-continuous function.

Proof. Let A be a neutrosophic open set in (Z, R) . Since g is a generalized neutrosophic continuous function, $g^{-1}(A)$ is a generalized neutrosophic open set in (Y, S) . Since f is a generalized neutrosophic contra-irresolute function, $f^{-1}(g^{-1}(A))$ is a generalized neutrosophic closed set in (X, T) . Hence, $g \circ f$ is a generalized neutrosophic contra-continuous function. \square

Proposition 3.11. Let $(X, T), (Y, S)$ and (Z, R) be any three neutrosophic topological spaces. Let $f : (X, T) \rightarrow (Y, S)$ and $g : (Y, S) \rightarrow (Z, R)$ be functions. If f is a generalized neutrosophic irresolute function and g is a generalized neutrosophic contra-continuous function, then $g \circ f$ is a generalized neutrosophic contra-continuous function.

Proof. Let A be a neutrosophic open set in (Z, R) . Since g is a generalized neutrosophic contra-continuous function, $g^{-1}(A)$ is a generalized neutrosophic closed set in (Y, S) . Since f is a generalized neutrosophic irresolute function, $f^{-1}(g^{-1}(A))$ is a generalized

neutrosophic closed set in (X, T) . Hence, $g \circ f$ is a generalized neutrosophic contra-continuous function. \square

Proposition 3.12. Let (X, T) , (Y, S) and (Z, R) be any three neutrosophic topological spaces. Let $f : (X, T) \rightarrow (Y, S)$ and $g : (Y, S) \rightarrow (Z, R)$ be functions. If f is a strongly generalized neutrosophic contra-continuous function and g is a generalized neutrosophic contra-continuous function, then $g \circ f$ is a neutrosophic continuous function.

Proof. Let A be a neutrosophic open set in (Z, R) . Since g is a generalized neutrosophic contra-continuous function, $g^{-1}(A)$ is a generalized neutrosophic closed set in (Y, S) . Since f is a strongly generalized neutrosophic contra-continuous function, $f^{-1}(g^{-1}(A))$ is a neutrosophic open set in (X, T) . Hence, $g \circ f$ is a neutrosophic continuous function. \square

Proposition 3.13. Let (X, T) , (Y, S) and (Z, R) be any three neutrosophic topological spaces. Let $f : (X, T) \rightarrow (Y, S)$ and $g : (Y, S) \rightarrow (Z, R)$ be functions. If f is a strongly generalized neutrosophic contra-continuous function and g is a generalized neutrosophic continuous function, then $g \circ f$ is a neutrosophic contra-continuous function.

Proof. Let A be a neutrosophic open set in (Z, R) . Since g is a generalized neutrosophic continuous function, $g^{-1}(A)$ is a generalized neutrosophic open set in (Y, S) . Since f is a strongly generalized neutrosophic contra-continuous function, $f^{-1}(g^{-1}(A))$ is a neutrosophic closed set in (X, T) . Hence, $g \circ f$ is a neutrosophic contra-continuous function. \square

Proposition 3.14. Let (X, T) , (Y, S) and (Z, R) be any three neutrosophic topological spaces. Let $f : (X, T) \rightarrow (Y, S)$ and $g : (Y, S) \rightarrow (Z, R)$ be functions. If f is a strongly generalized neutrosophic continuous function and g is generalized neutrosophic contra-continuous function, then $g \circ f$ is a neutrosophic contra-continuous function.

Proof. Let A be a neutrosophic open set in (Z, R) . Since g is a generalized neutrosophic contra-continuous function, $g^{-1}(A)$ is a generalized neutrosophic closed set in (Y, S) . Since f is a strongly generalized neutrosophic continuous function, $f^{-1}(g^{-1}(A))$ is a neutrosophic closed set in (X, T) . Hence, $g \circ f$ is a neutrosophic contra-continuous function. \square

Proposition 3.15. Let (X, T) , (Y, S) and (Z, R) be any three neutrosophic topological spaces. Let $f : (X, T) \rightarrow (Y, S)$ and $g : (Y, S) \rightarrow (Z, R)$ be functions and (Y, S)

be a neutrosophic $T_{\frac{1}{2}}$ space if f and g are generalized neutrosophic contra-continuous functions, then $g \circ f$ is a generalized neutrosophic continuous function.

Proof. Let A be a neutrosophic open set in (Z, R) . Since g is a generalized neutrosophic contra-continuous function, $g^{-1}(A)$ is a generalized neutrosophic closed set in (Y, S) . Since (Y, S) is a neutrosophic $T_{\frac{1}{2}}$ space, $g^{-1}(A)$ is a neutrosophic closed set in (Y, S) . Since f is a generalized neutrosophic contra-continuous function, $f^{-1}(g^{-1}(A))$ is a generalized neutrosophic open set in (X, T) . Hence, $g \circ f$ is a generalized neutrosophic continuous function.

The Proposition 3.15., need not be true, if (Y, S) is not a neutrosophic $T_{\frac{1}{2}}$ as shown in Example 3.6. □

Example 3.6. Let $X = \{a, b, c\}$. Define the neutrosophic sets A, B, C and D as follows:

$$A = \langle x, (\frac{a}{0.3}, \frac{b}{0.3}, \frac{c}{0.4}), (\frac{a}{0.3}, \frac{b}{0.3}, \frac{c}{0.4}), (\frac{a}{0.4}, \frac{b}{0.5}, \frac{c}{0.5}) \rangle,$$

$$B = \langle x, (\frac{a}{0.6}, \frac{b}{0.6}, \frac{c}{0.6}), (\frac{a}{0.6}, \frac{b}{0.6}, \frac{c}{0.6}), (\frac{a}{0.3}, \frac{b}{0.3}, \frac{c}{0.3}) \rangle,$$

$$C = \langle x, (\frac{a}{0.4}, \frac{b}{0.5}, \frac{c}{0.4}), (\frac{a}{0.4}, \frac{b}{0.5}, \frac{c}{0.4}), (\frac{a}{0.4}, \frac{b}{0.4}, \frac{c}{0.4}) \rangle \text{ and}$$

$$D = \langle x, (\frac{a}{0.3}, \frac{b}{0.4}, \frac{c}{0.3}), (\frac{a}{0.3}, \frac{b}{0.4}, \frac{c}{0.3}), (\frac{a}{0.5}, \frac{b}{0.6}, \frac{c}{0.7}) \rangle.$$

Observe that the families $T = \{0_N, 1_N, A, B\}$, $S = \{0_N, 1_N, C\}$ and $R = \{0_N, 1_N, D\}$ are neutrosophic topologies on X . Thus, (X, T) , (X, S) and (X, R) are neutrosophic topological spaces. Define $f : (X, T) \rightarrow (X, S)$ by $f(a) = a, f(b) = b, f(c) = b$ and $g : (X, S) \rightarrow (X, R)$ by $g(a) = b, g(b) = a, g(c) = c$. Then f and g are generalized neutrosophic contra-continuous functions. Let D be a neutrosophic open set in (X, R) . $f^{-1}(g^{-1}(D))$ is not a generalized neutrosophic open set in (X, T) . Therefore, $g \circ f$ is not a generalized neutrosophic continuous function. Further (X, S) is not neutrosophic $T_{\frac{1}{2}}$.

Proposition 3.16. Let $(X, T), (Y, S)$ and (Z, R) be any three neutrosophic topological spaces. Let $f : (X, T) \rightarrow (Y, S)$ and $g : (Y, S) \rightarrow (Z, R)$ be functions and (Y, S) be neutrosophic $T_{\frac{1}{2}}$. If f is a neutrosophic contra-continuous function and g is a generalized neutrosophic contra-irresolute function, then $g \circ f$ is a strongly generalized neutrosophic continuous function.

Proof. Let A be a generalized neutrosophic open in (Z, R) . Since g is a generalized neutrosophic contra-irresolute function, $g^{-1}(A)$ is a generalized neutrosophic closed set in (Y, S) . Since (Y, S) is a neutrosophic $T_{\frac{1}{2}}$ space, $g^{-1}(A)$ is a neutrosophic closed set in (Y, S) . Since f is a neutrosophic contra-continuous function, $f^{-1}(g^{-1}(A))$ is a

neutrosophic open set in (X, T) . Hence, $g \circ f$ is a strongly generalized neutrosophic continuous function.

If (Y, S) is not a neutrosophic $T_{\frac{1}{2}}$ space, then Proposition 3.16 need not be true as it is shown in Example 3.7. □

Example 3.7. Let $X = \{a, b, c\}$. Define the neutrosophic sets A,B,C and D as follows:

$$A = \langle x, (\frac{a}{0.9}, \frac{b}{0.9}, \frac{c}{0.9}), (\frac{a}{0.9}, \frac{b}{0.9}, \frac{c}{0.9}), (\frac{a}{0.1}, \frac{b}{0.1}, \frac{c}{0.1}) \rangle,$$

$$B = \langle x, (\frac{a}{0.4}, \frac{b}{0.4}, \frac{c}{0.4}), (\frac{a}{0.4}, \frac{b}{0.4}, \frac{c}{0.4}), (\frac{a}{0.4}, \frac{b}{0.4}, \frac{c}{0.5}) \rangle,$$

$$C = \langle x, (\frac{a}{0.4}, \frac{b}{0.5}, \frac{c}{0.5}), (\frac{a}{0.4}, \frac{b}{0.5}, \frac{c}{0.5}), (\frac{a}{0.4}, \frac{b}{0.4}, \frac{c}{0.5}) \rangle \text{ and}$$

$$D = \langle x, (\frac{a}{0.4}, \frac{b}{0.2}, \frac{c}{0.3}), (\frac{a}{0.4}, \frac{b}{0.2}, \frac{c}{0.3}), (\frac{a}{0.6}, \frac{b}{0.8}, \frac{c}{0.7}) \rangle.$$

The families $T = \{0_N, 1_N, A, B\}$, $S = \{0_N, 1_N, C\}$ and $R = \{0_N, 1_N, D\}$ are neutrosophic topologies on X. Thus, (X, T) , (X, S) and (X, R) are neutrosophic topological spaces. Define $f : (X, T) \rightarrow (X, S)$ as $f(a) = a, f(b) = a, f(c) = b$ and $g : (X, S) \rightarrow (X, R)$ by $g(a) = c, g(b) = a, g(c) = b$. Then f is neutrosophic contra-continuous function and g is a generalized neutrosophic contra-irresolute function. But, for the generalized neutrosophic open set D in (X, R) , $f^{-1}(g^{-1}(D))$ is not a neutrosophic open set in (X, T) . Hence $g \circ f$ is not a strongly generalized neutrosophic continuous function. Moreover, (X, S) is not a neutrosophic $T_{\frac{1}{2}}$ space.

Proposition 3.17. Let (X, T) and (Y, S) be any two neutrosophic topological spaces. For a function $f : (X, T) \rightarrow (Y, S)$, the following statements are equivalent:

- (i) f is a generalized neutrosophic contra-continuous function;
- (ii) For each neutrosophic point $x_{r,t,s}$ of X and for each neutrosophic closed set B of (Y, S) containing $f(x_{r,t,s})$, there exists a generalized neutrosophic open set A of (X, T) containing $x_{r,t,s}$, such that $A \subseteq f^{-1}(B)$;
- (iii) For each neutrosophic point $x_{r,t,s}$ of X and for each neutrosophic closed set B of (Y, S) containing $f(x_{r,t,s})$, there exists a generalized neutrosophic open set A of (X, T) containing $x_{r,t,s}$, such that $f(A) \subseteq B$.

Proof. (i) \Rightarrow (ii) Let f be a generalized neutrosophic contra-continuous function. Let B be a neutrosophic closed set in (Y, S) and $x_{r,t,s}$ a neutrosophic point of X such that $f(x_{r,t,s}) \in B$. Then $x_{r,t,s} \in f^{-1}(B) = NGint(f^{-1}(B))$. Let $A = NGint(f^{-1}(B))$, then A is a generalized neutrosophic open set and $A = NGint(f^{-1}(B)) \subseteq f^{-1}(B)$. This implies that $A \subseteq f^{-1}(B)$.

(ii) \Rightarrow (iii) Let B be a neutrosophic closed set in (Y, S) and let $x_{r,t,s}$ be a neutrosophic point in X , such that $f(x_{r,t,s}) \in B$. Then $x_{r,t,s} \in f^{-1}(B)$. By hypothesis, $f^{-1}(B)$ is a generalized neutrosophic open set in (X, T) and $A \subseteq f^{-1}(B)$. This implies that $f(A) \subseteq f(f^{-1}(B)) \subseteq B$. Thus, $f(A) \subseteq B$

(iii) \Rightarrow (i) Let B be a neutrosophic closed set in (Y, S) and let $x_{r,t,s}$ be a neutrosophic point in X , such that $f(x_{r,t,s}) \in B$. Then $x_{r,t,s} \in f^{-1}(B)$. By hypothesis, there exists a generalized neutrosophic open set A of (X, T) , such that $x_{r,t,s} \in A$ and $f(A) \subseteq B$. This implies, $x_{r,t,s} \in A \subseteq f^{-1}(f(A)) \subseteq f^{-1}(B)$. Since A is generalized neutrosophic open, $A = NGint(A) \subseteq NGint(f^{-1}(B))$. Therefore, $x_{r,t,s} \in NGint(f^{-1}(B))$, $f^{-1}(B) = \bigcup_{x_{r,t,s} \in f^{-1}(B)} (x_{r,t,s}) \subseteq NGint(f^{-1}(B)) \subseteq f^{-1}(B)$. Hence, $f^{-1}(B)$ is a generalized neutrosophic open set in (X, T) . Thus, f is generalized neutrosophic contra-continuous function. □

Proposition 3.18. Let (X, T) and (Y, S) be any two neutrosophic topological spaces. Let $f : (X, T) \rightarrow (Y, S)$ be any function. If the graph $g : X \rightarrow X \times Y$ of f is a generalized neutrosophic contra-continuous function, then f is also a generalized neutrosophic contra-continuous function.

Proof. Let A be a neutrosophic open set in (Y, S) . By definition $f^{-1}(A) = 1_N \cap f^{-1}(A) = g^{-1}(1_N \times A)$. Since g is a generalized neutrosophic contra-continuous function, $g^{-1}(1_N \times A)$ is a generalized neutrosophic closed set in (X, T) . Now, $f^{-1}(A)$ is a generalized neutrosophic closed set in (X, T) . Thus, f is a generalized neutrosophic contra-continuous function. □

Proposition 3.19. Let (X, T) and (Y, S) be any two neutrosophic topological spaces. Let $f : (X, T) \rightarrow (Y, S)$ be any function. If the graph $g : X \rightarrow X \times Y$ of f is a strongly generalized neutrosophic contra-continuous function, then f is also a strongly generalized neutrosophic contra-continuous function.

Proof. Let A be a generalized neutrosophic open set in (Y, S) . By definition $f^{-1}(A) = 1_N \cap f^{-1}(A) = g^{-1}(1_N \times A)$. Since g is strongly generalized neutrosophic contra-continuous, $g^{-1}(1_N \times A)$ is a neutrosophic closed set in (X, T) . Now, $f^{-1}(A)$ is a neutrosophic closed set in (X, T) . Thus, f is a strongly generalized neutrosophic contra-continuous function. □

Proposition 3.20. Let (X, T) and (Y, S) be any two neutrosophic topological spaces. Let $f : (X, T) \rightarrow (Y, S)$ be any function. If the graph $g : X \rightarrow X \times Y$ of f is a generalized neutrosophic contra-irresolute function, then f is also a generalized neutrosophic contra-irresolute function.

Proof. Let A be a generalized neutrosophic open set in (Y, S) . By definition $f^{-1}(A) = 1_N \cap f^{-1}(A) = g^{-1}(1_N \times A)$. Since g is a generalized neutrosophic contra-irresolute function, $g^{-1}(1_N \times A)$ is a generalized neutrosophic closed set in (X, T) . Now, $f^{-1}(A)$ is a generalized neutrosophic closed set in (X, T) . Thus, f is a generalized neutrosophic contra-irresolute function. \square

4 INTERRELATION

From the above results proved, we have a diagram of implications as shown below.

In the diagram \textcircled{A} , \textcircled{B} , \textcircled{C} and \textcircled{D} denote a neutrosophic contra-continuous function, generalized neutrosophic contra-continuous function, generalized neutrosophic contra-irresolute function and strongly generalized neutrosophic contra-continuous function respectively.

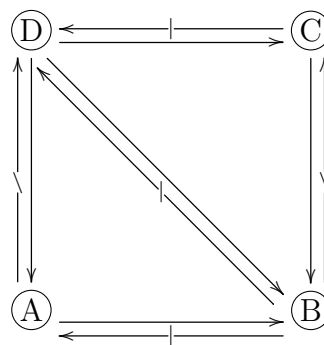

REFERENCES

Atanassov, K. (1983, June) Intuitionistic fuzzy sets, in: V. Sgurev, Ed., VII ITKR's Session, Sofia (Central Sci. and Techn. Library, Bulg. Academy of Sciences, 1984).

Atanassov, K. (1986). Intuitionistic fuzzy sets. *Fuzzy Sets and Systems* , 20, 87-96.

- Atanassov, K. (1988) Review and new results on intuitionistic fuzzy sets, *Preprint IM-MFAIS-1-88, Sofia*, 1988.
- Atanassov, K., and Stoeva, S.(1983, August). Intuitionistic fuzzy sets, in: *Polish Syrup. on Interval & Fuzzy Mathematics, Poznan*, 23-26.
- Atanassov, K., and Stoeva, S.(1984) Intuitionistic L-fuzzy sets, in: *R. Trappl, Ed., Cybernetics and System Research, Vol. 2* (Elsevier, Amsterdam) 539-540.
- Chang, C. L. (1968) Fuzzy topological spaces. *Journal of Mathematical Analysis and Applications*, 24, 182-190.
- Dhavaseelan, R., E. Roja. E., and Uma, M. K.(2010). Generalized intuitionistic fuzzy closed sets. *Advances in Fuzzy Mathematics*, 5, 152-172.
- Dhavaseelan, R., E. Roja. E. & Uma, M. K.(2012). Generalized intuitionistic fuzzy contra-continuous functions, *The Journal of Fuzzy Mathematics*, 20(4), 1-16.
- Dhavaseelan, R., and S. Jafari, S. Generalized neutrosophic closed sets. Submitted.
- Ekici, E. & Kerre, E. (2006). On fuzzy contra-continuous. *Advances in Fuzzy System*, 1, 35-44.
- Salama, A. A. and S. A. Alblowi, S. A. (2012). Neutrosophic set and neutrosophic topological spaces. *IOSR Journal of Mathematics*, 3(4), 31-35.
- Smarandache, F. (2002). Neutrosophy and neutrosophic logic , First International Conference on Neutrosophy , Neutrosophic Logic, Set, Probability, and Statistics University of New Mexico, Gallup, NM 87301, USA.
- Smarandache F (1999) *A unifying field in logics. Neutrosophy: Neutrosophic probability, set and logic*. American Research Press, Rehoboth.
- Smets, P. (1981). The degree of belief in a fuzzy event, *Information Sciences* , 25, 1-19.
- Sugeno, M. (1985) An introductory survey of fuzzy control. *Information Sciences*, 36, 59-83.
- Zadeh, L. A. (1965). Fuzzy sets. *Information and Control*, 8, 338-353.

On Neutrosophic Supra *Pre*-Continuous Functions in Neutrosophic Topological Spaces

M. Parimala¹, M. Karthika², R. Dhavaseelan³, S. Jafari⁴

¹Department of Mathematics, Bannari Amman Institute of Technology,
Sathyamangalam-638401, Tamil Nadu, India.
Email: rishwanthpari@gmail.com.

²Department of Mathematics, Bannari Amman Institute of Technology,
Sathyamangalam-638401, Tamil Nadu, India.
Email: karthikamuthusamy1991@gmail.com.

³Department of Mathematics, Sona College of Technology, Salem-636005,
Tamil Nadu, India.,
Email: dhavaseelan.r@gmail.com.

⁴College of Vestsjaelland South, Herrestraede 11,
4200 Slagelse, Denmark.
Email: jafaripersia@gmail.com.

ABSTRACT

In this paper, we introduce and investigate a new class of sets and functions between topological space called neutrosophic supra pre-continuous functions. Furthermore, the concepts of neutrosophic supra pre-open maps and neutrosophic supra pre-closed maps in terms of neutrosophic supra pre-open sets and neutrosophic supra pre-closed sets, respectively, are introduced and several properties of them are investigated.

KEYWORDS: Neutrosophic supra topological spaces, neutrosophic supra *pre*-open sets and neutrosophic supra *pre*-continuous maps.

1 INTRODUCTION AND PRELIMINARIES

Intuitionistic fuzzy set is defined by Atanassov (1986) as a generalization of the concept of fuzzy set given by Zadeh (1965). Using the notation of intuitionistic fuzzy sets, Çoker

(1997) introduced the notation of intuitionistic fuzzy topological spaces. The supra topological spaces and studied s-continuous functions and s^* -continuous functions were introduced by Mashhour, Allam, Mahmoud, and Khedr (1983). El-Monsef and Ramadan (1987) introduced the fuzzy supra topological spaces and studied fuzzy supra continuous functions and obtained some properties and characterizations. Min (1996) introduced fuzzy s-continuous, fuzzy s-open and fuzzy s-closed maps and established a number of characterizations. Devi, Sampathkumar, and Caldas (2008) introduced the concept of supra α -open set, and Mashhour et al. (1983) introduced, the notion of supra-semi open set, supra semi-continuous functions and studied some of the basic properties for this class of functions. Turnal (2003) introduced the concept of intuitionistic fuzzy supra topological space. After the introduction of the neutrosophic set concept (Salama & Alblowi, 2012; Smarandache, 1999). The concepts of Neutrosophic Set and Neutrosophic Topological Spaces was introduced by (Salama & Alblowi, 2012).

In this paper, we introduce and investigate a new class of sets and functions between topological space called neutrosophic supra semi-open set and neutrosophic supra semi-open continuous functions respectively.

Definition 1. Let T, I, F be real standard or non standard subsets of $]0^-, 1^+[$, with $sup_T = t_{sup}, inf_T = t_{inf}$
 $sup_I = i_{sup}, inf_I = i_{inf}$
 $sup_F = f_{sup}, inf_F = f_{inf}$
 $n - sup = t_{sup} + i_{sup} + f_{sup}$
 $n - inf = t_{inf} + i_{inf} + f_{inf}$. T, I, F are neutrosophic components.

Definition 2. Let X be a nonempty fixed set. A neutrosophic set [NS for short] A is an object having the form $A = \{\langle x, \mu_A(x), \sigma_A(x), \gamma_A(x) \rangle : x \in X\}$ where $\mu_A(x), \sigma_A(x)$ and $\gamma_A(x)$ which represents the degree of membership function (namely $\mu_A(x)$), the degree of indeterminacy (namely $\sigma_A(x)$) and the degree of nonmembership (namely $\gamma_A(x)$) respectively of each element $x \in X$ to the set A .

Remark 1. (1) A neutrosophic set $A = \{\langle x, \mu_A(x), \sigma_A(x), \gamma_A(x) \rangle : x \in X\}$ can be identified to an ordered triple $\langle \mu_A, \sigma_A, \gamma_A \rangle$ in $]0^-, 1^+[$ on X .

(2) For the sake of simplicity, we shall use the symbol $A = \langle \mu_A, \sigma_A, \gamma_A \rangle$ for the neutrosophic set $A = \{\langle x, \mu_A(x), \sigma_A(x), \gamma_A(x) \rangle : x \in X\}$.

Definition 3. Let X be a nonempty set and the neutrosophic sets A and B in the form $A = \{\langle x, \mu_A(x), \sigma_A(x), \gamma_A(x) \rangle : x \in X\}$, $B = \{\langle x, \mu_B(x), \sigma_B(x), \gamma_B(x) \rangle : x \in X\}$. Then

- (a) $A \subseteq B$ iff $\mu_A(x) \leq \mu_B(x)$, $\sigma_A(x) \leq \sigma_B(x)$ and $\gamma_A(x) \geq \gamma_B(x)$ for all $x \in X$;
- (b) $A = B$ iff $A \subseteq B$ and $B \subseteq A$;

- (c) $\bar{A} = \{\langle x, \gamma_A(x), \sigma_A(x), \mu_A(x) \rangle : x \in X\}$; [Complement of A]
- (d) $A \cap B = \{\langle x, \mu_A(x) \wedge \mu_B(x), \sigma_A(x) \wedge \sigma_B(x), \gamma_A(x) \vee \gamma_B(x) \rangle : x \in X\}$;
- (e) $A \cup B = \{\langle x, \mu_A(x) \vee \mu_B(x), \sigma_A(x) \vee \sigma_B(x), \gamma_A(x) \wedge \gamma_B(x) \rangle : x \in X\}$;
- (f) $[]A = \{\langle x, \mu_A(x), \sigma_A(x), 1 - \mu_A(x) \rangle : x \in X\}$;
- (g) $\langle \rangle A = \{\langle x, 1 - \gamma_A(x), \sigma_A(x), \gamma_A(x) \rangle : x \in X\}$.

Definition 4. Let $\{A_i : i \in J\}$ be an arbitrary family of neutrosophic sets in X. Then

- (a) $\bigcap A_i = \{\langle x, \wedge \mu_{A_i}(x), \wedge \sigma_{A_i}(x), \vee \gamma_{A_i}(x) \rangle : x \in X\}$;
- (b) $\bigcup A_i = \{\langle x, \vee \mu_{A_i}(x), \vee \sigma_{A_i}(x), \wedge \gamma_{A_i}(x) \rangle : x \in X\}$.

Since our main purpose is to construct the tools for developing neutrosophic topological spaces, we must introduce the neutrosophic sets 0_N and 1_N in X as follows:

Definition 5. (Dhavaseelan & Jafari, in press) $0_N = \{\langle x, 0, 0, 1 \rangle : x \in X\}$ and $1_N = \{\langle x, 1, 1, 0 \rangle : x \in X\}$.

Definition 6. (Dhavaseelan & Jafari, in press) A neutrosophic topology (NT) on a nonempty set X is a family T of neutrosophic sets in X satisfying the following axioms:

- (i) $0_N, 1_N \in T$,
- (ii) $G_1 \cap G_2 \in T$ for any $G_1, G_2 \in T$,
- (iii) $\cup G_i \in T$ for arbitrary family $\{G_i \mid i \in \Lambda\} \subseteq T$.

In this case the ordered pair (X, T) or simply X is called a neutrosophic topological space (NTS) and each neutrosophic set in T is called a neutrosophic open set (NOS). The complement \bar{A} of a NOS A in X is called a neutrosophic closed set (NCS) in X.

Definition 7. (Dhavaseelan & Jafari, in press) Let A be a neutrosophic set in a neutrosophic topological space X. Then

$Nint(A) = \bigcup \{G \mid G \text{ is a neutrosophic open set in X and } G \subseteq A\}$ is called the neutrosophic interior of A;

$Ncl(A) = \bigcap \{G \mid G \text{ is a neutrosophic closed set in X and } G \supseteq A\}$ is called the neutrosophic closure of A.

Definition 8. Let X be a nonempty set. If r, t, s be real standard or non standard subsets of $]0^-, 1^+[$ then the neutrosophic set $x_{r,t,s}$ is called a neutrosophic point(in short NP)in X given by

$$x_{r,t,s}(x_p) = \begin{cases} (r, t, s), & \text{if } x = x_p \\ (0, 0, 1), & \text{if } x \neq x_p \end{cases}$$

for $x_p \in X$ is called the support of $x_{r,t,s}$. where r denotes the degree of membership value, t denotes the degree of indeterminacy and s is the degree of non-membership value of $x_{r,t,s}$.

Now we shall define the image and preimage of neutrosophic sets. Let X and Y be two nonempty sets and $f : X \rightarrow Y$ be a function.

Definition 9. (Dhavaseelan & Jafari, in press)

(a) If $B = \{\langle y, \mu_B(y), \sigma_B(y), \gamma_B(y) \rangle : y \in Y\}$ is a neutrosophic set in Y , then the preimage of B under f , denoted by $f^{-1}(B)$, is the neutrosophic set in X defined by

$$f^{-1}(B) = \{\langle x, f^{-1}(\mu_B)(x), f^{-1}(\sigma_B)(x), f^{-1}(\gamma_B)(x) \rangle : x \in X\}.$$

(b) If $A = \{\langle x, \mu_A(x), \sigma_A(x), \gamma_A(x) \rangle : x \in X\}$ is a neutrosophic set in X , then the image of A under f , denoted by $f(A)$, is the neutrosophic set in Y defined by

$$f(A) = \{\langle y, f(\mu_A)(y), f(\sigma_A)(y), (1 - f(1 - \gamma_A))(y) \rangle : y \in Y\}. \text{ where}$$

$$f(\mu_A)(y) = \begin{cases} \sup_{x \in f^{-1}(y)} \mu_A(x), & \text{if } f^{-1}(y) \neq \emptyset, \\ 0, & \text{otherwise,} \end{cases}$$

$$f(\sigma_A)(y) = \begin{cases} \sup_{x \in f^{-1}(y)} \sigma_A(x), & \text{if } f^{-1}(y) \neq \emptyset, \\ 0, & \text{otherwise,} \end{cases}$$

$$(1 - f(1 - \gamma_A))(y) = \begin{cases} \inf_{x \in f^{-1}(y)} \gamma_A(x), & \text{if } f^{-1}(y) \neq \emptyset, \\ 1, & \text{otherwise,} \end{cases}$$

For the sake of simplicity, let us use the symbol $f_-(\gamma_A)$ for $1 - f(1 - \gamma_A)$.

Corollary 1. (Dhavaseelan & Jafari, in press) Let $A, A_i (i \in J)$ be neutrosophic sets in X , $B, B_i (i \in K)$ be neutrosophic sets in Y and $f : X \rightarrow Y$ a function. Then

(a) $A_1 \subseteq A_2 \Rightarrow f(A_1) \subseteq f(A_2)$,

(b) $B_1 \subseteq B_2 \Rightarrow f^{-1}(B_1) \subseteq f^{-1}(B_2)$,

(c) $A \subseteq f^{-1}(f(A))$ { If f is injective, then $A = f^{-1}(f(A))$ } ,

(d) $f(f^{-1}(B)) \subseteq B$ { If f is surjective, then $f(f^{-1}(B)) = B$ } ,

(e) $f^{-1}(\cup B_j) = \cup f^{-1}(B_j)$,

(f) $f^{-1}(\cap B_j) = \cap f^{-1}(B_j)$,

(g) $f(\cup A_i) = \cup f(A_i)$,

(h) $f(\cap A_i) \subseteq \cap f(A_i)$ { If f is injective, then $f(\cap A_i) = \cap f(A_i)$ } ,

- (i) $f^{-1}(1_N) = 1_N$,
- (j) $f^{-1}(0_N) = 0_N$,
- (k) $f(1_N) = 1_N$, if f is surjective
- (l) $f(0_N) = 0_N$,
- (m) $\overline{f(A)} \subseteq f(\overline{A})$, if f is surjective,
- (n) $f^{-1}(\overline{B}) = \overline{f^{-1}(B)}$.

2 NEUTROSOPHIC SUPRA *PRE*-OPEN SET.

In this section, we introduce a new class of open sets called neutrosophic supra *pre*-open sets and study some of their basic properties.

Definition 2.1. Let (X, τ) be an neutrosophic supra topological space. A set A is called an neutrosophic supra *pre*-open set (briefly NSPOS) if $A \subseteq s\text{-Nint}(s\text{-Ncl}(A))$. The complement of an neutrosophic supra *pre*-open set is called an neutrosophic supra *pre*-closed set (briefly NSPCS).

Theorem 2.2. Every neutrosophic supra-open set is neutrosophic supra *pre*-open.

Proof. Let A be an neutrosophic supra-open set in (X, τ) . Then $A \subseteq s\text{-Nint}(A)$, we get $A \subseteq s\text{-Nint}(s\text{-Ncl}(A))$ then $s\text{-Nint}(A) \subseteq s\text{-Nint}(s\text{-Ncl}(A))$. Hence A is neutrosophic supra *pre*-open in (X, τ) .

The converse of the above theorem need not be true as shown by the following example.

Example 2.3.

Let

$X = \{a, b\}$, $A = \{x, \langle 0.5, 0.2 \rangle, \langle 0.5, 0.2 \rangle, \langle 0.3, 0.4 \rangle\}$, $B = \{x, \langle 0.3, 0.4 \rangle, \langle 0.3, 0.4 \rangle, \langle 0.6, 0.5 \rangle\}$ and $C = \{x, \langle 0.3, 0.4 \rangle, \langle 0.3, 0.4 \rangle, \langle 0.2, 0.5 \rangle\}$, $\tau = \{0_\sim, 1_\sim, A, B, A \cup B\}$. Then C is called neutrosophic supra *pre*-open set but it is not neutrosophic supra -open set.

Theorem 2.4. Every neutrosophic supra α -open set is neutrosophic supra *pre*-open

Proof. Let A be an neutrosophic supra α -open set in (X, τ) . Then

$A \subseteq s\text{-Nint}(s\text{-Ncl}(s\text{-Nint}(A)))$, it is obvious that $s\text{-Nint}(s\text{-Ncl}(s\text{-Nint}(A))) \subseteq s\text{-Nint}(s\text{-Ncl}(A))$ and $A \subseteq s\text{-Nint}(s\text{-Ncl}(A))$. Hence A is neutrosophic supra *pre*-open in (X, τ) .

The converse of the above theorem need not be true as shown by the following example.

Example 2.5.

Let $X = \{a, b\}$, $A = \{x, \langle 0.3, 0.5 \rangle, \langle 0.3, 0.5 \rangle, \langle 0.4, 0.5 \rangle\}$, $B = \{x, \langle 0.4, 0.3 \rangle, \langle 0.4, 0.3 \rangle, \langle 0.5, 0.4 \rangle\}$ and $C = \{x, \langle 0.4, 0.5 \rangle, \langle 0.4, 0.5 \rangle, \langle 0.5, 0.4 \rangle\}$,

$\tau = \{0_{\sim}, 1_{\sim}, A, B, A \cup B\}$. Then C is called neutrosophic supra *pre*-open set but it is not neutrosophic supra α -open set.

Theorem 2.6. Every neutrosophic supra *pre*-open set is neutrosophic supra β -open

Proof. Let A be an neutrosophic supra *pre*-open set in (X, τ) . It is obvious that $s-Nint(s-Ncl(A)) \subseteq s-Ncl(s-Nint(s-Ncl(A)))$. Then $A \subseteq s-Nint(s-Ncl(A))$. Hence $A \subseteq s-Ncl(s-Nint(s-Ncl(A)))$.

The converse of the above theorem need not be true as shown by the following example.

Example 2.7.

Let $X = \{a, b\}$, $A = \{x, \langle 0.2, 0.3 \rangle, \langle 0.2, 0.3 \rangle, \langle 0.5, 0.3 \rangle\}$,
 $B = \{x, \langle 0.1, 0.2 \rangle, \langle 0.1, 0.2 \rangle, \langle 0.6, 0.5 \rangle\}$ and $C = \{x, \langle 0.2, 0.3 \rangle, \langle 0.2, 0.3 \rangle, \langle 0.2, 0.3 \rangle\}$,
 $\tau = \{0_{\sim}, 1_{\sim}, A, B, A \cup B\}$. Then C is called neutrosophic supra *pre*-open set but it is not neutrosophic supra *pre*-open set.

Theorem 2.8. Every neutrosophic supra *pre*-open set is neutrosophic supra b -open

Proof. Let A be an neutrosophic supra *pre*-open set in (X, τ) . It is obvious that $s-Nint(s-Ncl(A)) \subseteq s-Nint(s-Ncl(A)) \cup s-Ncl(s-Nint(A))$. Then $A \subseteq s-Nint(s-Ncl(A))$ Then $A \subseteq s-Nint(s-Ncl(A))$. Hence $A \subseteq s-Nint(s-Ncl(A)) \cup s-Ncl(s-Nint(A))$.

The converse of the above theorem need not be true as shown by the following example.

Example 2.9.

Let
 $X = \{a, b\}$, $A = \{x, \langle 0.5, 0.2 \rangle, \langle 0.5, 0.4 \rangle, \langle 0.3, 0.4 \rangle\}$, $B = \{x, \langle 0.3, 0.4 \rangle, \langle 0.3, 0.4 \rangle, \langle 0.6, 0.5 \rangle\}$
and $C = \{x, \langle 0.3, 0.4 \rangle, \langle 0.3, 0.4 \rangle, \langle 0.4, 0.4 \rangle\}$, $\tau = \{0_{\sim}, 1_{\sim}, A, B, A \cup B\}$. Then C is called neutrosophic supra *pre*-open set but it is not neutrosophic supra *pre*-open set.

Theorem 2.10.

- (i) Arbitrary union of neutrosophic supra *pre*-open sets is always neutrosophic supra *pre*-open.
- (ii) Finite intersection of neutrosophic supra *pre*-open sets may fail to be neutrosophic supra *pre*-open.

Proof.

- (i) Let A and B be neutrosophic supra *pre*-open sets. Then $A \subseteq s-Nint(s-Ncl(A))$ and $B \subseteq s-Nint(s-Ncl(B))$. Then $A \cup B \subseteq s-Nint(s-Ncl(A))$. Therefore, $A \cup B$ is neutrosophic supra *pre*-open sets.

- (ii) Let $X = \{a, b\}$, $A = \{x, \langle 0.3, 0.4 \rangle, \langle 0.3, 0.4 \rangle, \langle 0.2, 0.5 \rangle\}$,
 $B = \{x, \langle 0.3, 0.4 \rangle, \langle 0.3, 0.4 \rangle, \langle 0.4, 0.4 \rangle\}$

and $\tau = \{0_{\sim}, 1_{\sim}, A, B, A \cup B\}$.

Hence A and B are neutrosophic supra *pre*-open but $A \cap B$ is not neutrosophic supra *pre*-open set.

Theorem 2.11.

- (i) Arbitrary intersection of neutrosophic supra *pre*-closed sets is always neutrosophic supra *pre*-closed.
- (ii) Finite union of neutrosophic supra *pre*-closed sets may fail to be neutrosophic supra *pre*-closed.

Proof.

- (i) This proof immediately from Theorem 2.10
- (ii) Let $X = \{a, b\}$, $A = \{x, \langle 0.2, 0.3 \rangle, \langle 0.2, 0.3 \rangle, \langle 0.2, 0.4 \rangle\}$, $B = \{x, \langle 0.5, 0.4 \rangle, \langle 0.5, 0.4 \rangle, \langle 0.4, 0.5 \rangle\}$ and $\tau = \{0_{\sim}, 1_{\sim}, A, B, A \cup B\}$. Hence A and B are neutrosophic supra *pre*-closed but $A \cup B$ is not neutrosophic supra *pre*-closed set.

Definition 2.12. The neutrosophic supra *pre*-closure of a set A , denoted by $s\text{-pre-Ncl}(A)$, is the intersection of neutrosophic supra *pre*-closed sets including A . The neutrosophic supra *pre*-interior of a set A , denoted by $s\text{-pre-Nint}(A)$, is the union of neutrosophic supra *pre*-open sets included in A .

Remark 2. It is clear that $s\text{-pre-Nint}(A)$ is an neutrosophic supra *pre*-open set and $s\text{-pre-Ncl}(A)$ is an neutrosophic supra *pre*-closed set.

Theorem 2.14.

- (i) $A \subseteq s\text{-pre-Ncl}(A)$; and $A = s\text{-pre-Ncl}(A)$ iff A is an neutrosophic supra *pre*-closed set;
- (ii) $s\text{-pre-Nint}(A) \subseteq A$; and $s\text{-pre-Nint}(A) = A$ iff A is an neutrosophic supra *pre*-open set;
- (iii) $X - s\text{-pre-Nint}(A) = s\text{-pre-Ncl}(X - A)$;
- (iv) $X - s\text{-pre-Ncl}(A) = s\text{-pre-Nint}(X - A)$.

Proof. It is obvious.

Theorem 2.15.

$$(i) \ s\text{-pre-Nint}(A) \cup s\text{-pre-Nint}(B) \subseteq s\text{-pre-Nint}(A \cup B);$$

$$(i) \ s\text{-pre-Ncl}(A \cap B) \subseteq s\text{-pre-Ncl}(A) \cap s\text{-pre-Ncl}(B).$$

Proof It is obvious.

The inclusions in (i) and (ii) in Theorem 2.15 can not be replaced by equalities. Let $X = \{a, b\}$, $A = \{x, \langle 0.3, 0.4 \rangle, \langle 0.3, 0.4 \rangle, \langle 0.2, 0.5 \rangle\}$, $B = \{x, \langle 0.3, 0.4 \rangle, \langle 0.3, 0.4 \rangle, \langle 0.4, 0.4 \rangle\}$ and $\tau = \{0_{\sim}, 1_{\sim}, A, B, A \cup B\}$, where

$$s\text{-pre-Nint}(A) = \{x, \langle 0.2, 0.5 \rangle, \langle 0.2, 0.5 \rangle, \langle 0.3, 0.4 \rangle\},$$

$$s\text{-pre-Nint}(B) = \{x, \langle 0.5, 0.4 \rangle, \langle 0.5, 0.4 \rangle, \langle 0.4, 0.5 \rangle\} \text{ and}$$

$$s\text{-pre-Nint}(A \cup B) = \{x, \langle 0.5, 0.5 \rangle, \langle 0.5, 0.5 \rangle, \langle 0.3, 0.4 \rangle\}.$$

Then $s\text{-pre-Ncl}(A) \cap s\text{-pre-Ncl}(B) = \{x, \langle 0.3, 0.4 \rangle, \langle 0.3, 0.4 \rangle, \langle 0.2, 0.5 \rangle\}$ and $s\text{-pre-Ncl}(A) = s\text{-pre-Ncl}(B) = 1_{\sim}$.

Proposition 2.16.

- (i) The intersection of a neutrosophic supra open set and a neutrosophic supra *pre*-open set is a neutrosophic supra *pre*-open set
- (ii) The intersection of a neutrosophic supra α -open set and a neutrosophic supra *pre*-open set is a neutrosophic supra *pre*-open set

3 NEUTROSOPHIC SUPRA *PRE*-CONTINUOUS MAPPINGS.

In this section, we introduce a new type of continuous mappings called a neutrosophic supra *pre*-continuous mappings and obtain some of their properties and characterizations.

Definition 3.1. Let (X, τ) and (Y, σ) be the two topological sets and μ be an associated neutrosophic supra topology with τ . A map $f : (X, \tau) \rightarrow (Y, \sigma)$ is called a neutrosophic supra *pre*-continuous mapping if the inverse image of each open set in Y is a neutrosophic supra *pre*-open set in X .

Theorem 3.2. Every neutrosophic supra continuous map is a neutrosophic supra *pre*-continuous map.

Proof. Let $f : (X, \tau) \rightarrow (Y, \sigma)$ be a neutrosophic supra continuous map and A is an open set in Y . Then $f^{-1}(A)$ is an open set in X . Since μ is associated with τ , then $\tau \subseteq \mu$. Therefore, $f^{-1}(A)$ is a neutrosophic supra open set in X which is a neutrosophic supra *pre*-open set in X . Hence f is a neutrosophic supra *pre*-continuous map.

The converse of the above theorem is not true as shown in the following example.

Example 3.3. Let $X = \{a, b\}$, $Y = \{u, v\}$ and

$$A = \{\langle 0.5, 0.2 \rangle, \langle 0.5, 0.2 \rangle, \langle 0.3, 0.4 \rangle\},$$

$$B = \{\langle 0.3, 0.4 \rangle, \langle 0.3, 0.4 \rangle, \langle 0.6, 0.5 \rangle\},$$

$$C = \{\langle 0.5, 0.4 \rangle, \langle 0.5, 0.4 \rangle, \langle 0.3, 0.4 \rangle\},$$

$D = \{\langle 0.5, 0.4 \rangle, \langle 0.5, 0.4 \rangle, \langle 0.6, 0.5 \rangle\}$. Then $\tau = \{0_{\sim}, 1_{\sim}, A, B, A \cup B\}$ be an neutrosophic supra topology on X.

Then the neutrosophic supra topology σ on Y is defined as follows:

$\sigma = \{0_{\sim}, 1_{\sim}, C, D, C \cup D\}$. Define a mapping $f(X, \tau) \longrightarrow (Y, \sigma)$ by $f(a) = u$ and $f(b) = v$. The inverse image of the open set in Y is not an neutrosophic supra open in X but it is an neutrosophic supra *pre*-open. Then f is an neutrosophic supra *pre*-continuous map but may not be an neutrosophic supra continuous map.

The following example shows that neutrosophic supra *pre*-continuous map but may not be an neutrosophic supra α -continuous map.

Example 3.4. Let $X = \{a, b\}$ and $Y = \{u, v\}$,

$$\tau = \{0_{\sim}, 1_{\sim}, \{\langle 0.5, 0.2 \rangle, \langle 0.5, 0.2 \rangle, \langle 0.3, 0.4 \rangle\},$$

$\{\langle 0.3, 0.4 \rangle, \langle 0.3, 0.4 \rangle, \langle 0.6, 0.5 \rangle\}, \{\langle 0.5, 0.4 \rangle, \langle 0.5, 0.4 \rangle, \langle 0.3, 0.4 \rangle\}$ be a neutrosophic supra topology on X.

Then the neutrosophic supra topology σ on Y is defined as follows:

$$\sigma = \{0_{\sim}, 1_{\sim}, \{\langle 0.5, 0.4 \rangle, \langle 0.5, 0.4 \rangle, \langle 0.3, 0.4 \rangle\}, \{\langle 0.5, 0.4 \rangle, \langle 0.5, 0.4 \rangle, \langle 0.6, 0.5 \rangle\}, \{\langle 0.5, 0.4 \rangle, \langle 0.5, 0.4 \rangle, \langle 0.3, 0.4 \rangle\}.$$

Define a mapping $f : (X, \tau) \longrightarrow (Y, \sigma)$ by $f(a) = u$ and $f(b) = v$. The inverse image of the open set in Y is not an neutrosophic supra α -open in X but it is an neutrosophic supra *pre*-open. Then f is an neutrosophic supra *pre*-continuous map but may not be an neutrosophic supra α -continuous map.

The following example shows that neutrosophic supra *b*-continuous map but may not be an neutrosophic supra *pre*-continuous map.

Example 3.5. Let $X = \{a, b\}$ and $Y = \{u, v\}$,

$$\tau = \{0_{\sim}, 1_{\sim}, \{\langle 0.5, 0.2 \rangle, \langle 0.5, 0.2 \rangle, \langle 0.3, 0.4 \rangle\}, \{\langle 0.3, 0.4 \rangle, \langle 0.3, 0.4 \rangle, \langle 0.6, 0.5 \rangle\},$$

$\{\langle 0.5, 0.4 \rangle, \langle 0.5, 0.4 \rangle, \langle 0.3, 0.4 \rangle\}$ be a neutrosophic supra topology on X. Then the neutrosophic supra topology σ on Y is defined as follows:

$$\sigma = \{0_{\sim}, 1_{\sim}, \{\langle 0.5, 0.2 \rangle, \langle 0.5, 0.2 \rangle, \langle 0.3, 0.4 \rangle\}, \{\langle 0.3, 0.4 \rangle, \langle 0.3, 0.4 \rangle, \langle 0.6, 0.5 \rangle\}, \{\langle 0.5, 0.4 \rangle, \langle 0.5, 0.4 \rangle, \langle 0.3, 0.4 \rangle\}.$$

Define a mapping $f : (X, \tau) \longrightarrow (Y, \sigma)$ by $f(a) = u$ and $f(b) = v$. The inverse image of the open set in Y is not an neutrosophic supra *pre*-open in X but it is an neutrosophic supra *b*-open. Then f is an neutrosophic supra *b*-continuous map but may not be an neutrosophic supra *pre*-continuous map.

The following example shows that neutrosophic supra β -continuous map but may not be an neutrosophic supra *pre*-continuous map.

Example 3.6. Let $X = \{a, b\}$ and $Y = \{u, v\}$,

$$\tau = \{0_{\sim}, 1_{\sim}, \{\langle 0.5, 0.2 \rangle, \langle 0.5, 0.2 \rangle, \langle 0.3, 0.4 \rangle\}, \{\langle 0.3, 0.4 \rangle, \langle 0.3, 0.4 \rangle, \langle 0.6, 0.5 \rangle\},$$

$\{\langle 0.5, 0.4 \rangle, \langle 0.5, 0.4 \rangle, \langle 0.3, 0.4 \rangle\}$ be a neutrosophic supra topology on X. Then the neutro-

sophic supra topology σ on Y is defined as follows:

$\sigma = \{0_{\sim}, 1_{\sim}, \{\langle 0.5, 0.2 \rangle, \langle 0.5, 0.2 \rangle, \langle 0.3, 0.4 \rangle\}, \{\langle 0.3, 0.4 \rangle, \langle 0.3, 0.4 \rangle, \langle 0.6, 0.5 \rangle\}\},$
 $\{\langle 0.5, 0.4 \rangle, \langle 0.5, 0.4 \rangle, \langle 0.3, 0.4 \rangle\}$. Define a mapping $f : (X, \tau) \longrightarrow (Y, \sigma)$ by $f(a) = u$ and $f(b) = v$. The inverse image of the open set in Y is not an neutrosophic supra *pre*-open in X but it is an neutrosophic supra β -open. Then f is an neutrosophic supra β -continuous map but may not be an neutrosophic supra *pre*-continuous map.

From the above discussion we have the following diagram in which the converses of the implications need not be true (cts. is the abbreviation of continuity).

Theorem 3.7. Let (X, τ) and (Y, σ) be the two topological spaces and μ be an associated neutrosophic supra topology with τ . Let f be a map from X into Y . Then the following are equivalent:

- (i) f is an neutrosophic supra *pre*-continuous map.
- (ii) The inverse image of a closed sets in Y is an neutrosophic supra *pre*-closed set in X ;
- (iii) $s\text{-pre-Ncl}(f^{-1}(A)) \subseteq f^{-1}(Ncl(A))$ for every set A in Y ;
- (iv) $f(s\text{-pre-Ncl}(A)) \subseteq Ncl(f(A))$ for every set A in X ;
- (v) $f^{-1}(Nint(B)) \subseteq s\text{-pre-Nint}(f^{-1}(B))$ for every set B in Y .

Proof. (i) \Rightarrow (ii): Let A be a closed set in Y , then $Y - A$ is open set in Y . Then $f^{-1}(Y - A) = X - f^{-1}(A)$ is *s-pre*-open set in X . It follows that $f^{-1}(A)$ is a supra *pre*-closed subset of X .

(ii) \Rightarrow (iii): Let A be any subset of Y . Since $Ncl(A)$ is closed in Y , then it follows that $f^{-1}(Ncl(A))$ is supra *pre*-closed set in X . Therefore $s\text{-pre-Ncl}(f^{-1}(A)) \subseteq (f^{-1}(Ncl(A)))$.

(iii) \Rightarrow (iv): Let A be any subset of X . By (iii) we have $f^{-1}(Ncl(f(A))) \supseteq s\text{-pre-Ncl}(f^{-1}(f(A))) \supseteq s\text{-pre-Ncl}(A)$ and hence $f(s\text{-pre-Ncl}(A)) \subseteq Ncl(f(A))$.

(iv) \Rightarrow (v): Let B be any subset of Y . By (4) we have $f^{-1}(s\text{-pre-Ncl}(X - f^{-1}(B))) \subseteq Ncl(f(X - f^{-1}(B)))$ and $f(X - s\text{-pre-Nint}(f^{-1}(B))) \subseteq Ncl(Y - B) = Y - Nint(B)$. Therefore we have $X - s\text{-pre-Nint}(f^{-1}(B)) \subseteq f^{-1}(Y - Nint(B))$ and hence $f^{-1}(Nint(B)) \subseteq s\text{-pre-Nint}(f^{-1}(B))$.

(v) \Rightarrow (i): Let B be a open set in Y and $f^{-1}(Nint(B)) \subseteq s\text{-pre-Nint}(f^{-1}(B))$, hence $f^{-1}(B) \subseteq s\text{-pre-Nint}(f^{-1}(B))$. Then $f^{-1}(B) = s\text{-pre-Nint}(f^{-1}(B))$. But, $s\text{-pre-Nint}(f^{-1}(B)) \subseteq f^{-1}(B)$. Hence $f^{-1}(B) = s\text{-pre-Nint}(f^{-1}(B))$. Therefore $f^{-1}(B)$ is an neutrosophic supra *pre*-open set in Y .

Theorem 3.8. If a map $f : (X, \tau) \rightarrow (Y, \sigma)$ is a *s-pre*-continuous and $g : (Y, \sigma) \rightarrow (Z, \eta)$ is continuous, then $(g \circ f)$ is *s-pre*-continuous.

Proof. It is Obvious.

Theorem 3.9. Let $f : (X, \tau) \rightarrow (Y, \sigma)$ be an neutrosophic *s-pre*-continuous map if one of the following holds:

- (i) $f^{-1}(s\text{-pre-Nint}(B)) \subseteq Nint(f^{-1}(B))$ for every set B in Y ,
- (ii) $Ncl(f^{-1}(A)) \subseteq f^{-1}(s\text{-pre-Ncl}(B))$ for every set B in Y ,
- (iii) $f(Ncl(A)) \subseteq s\text{-pre-Ncl}(f(B))$ for every A in X .

Proof. Let B be any open set of Y , if the condition (i) is satisfied, then $f^{-1}(s\text{-pre-Nint}(B)) \subseteq Nint(f^{-1}(B))$. We get, $f^{-1}(B) \subseteq Nint(f^{-1}(B))$. Therefore $f^{-1}(B)$ is a neutrosophic open set. Every neutrosophic open set is neutrosophic supra *pre*-open set. Hence f is an neutrosophic *s-pre*-continuous .

If condition (ii) is satisfied, then we can easily prove that f is an neutrosophic supra *pre*-continuous.

Let condition (iii) is satisfied and B be any open set in Y . Then $f^{-1}(B)$ is a set in X and then we can easily prove that f is an neutrosophic *s-pre*-continuous function. If condition (iii) is satisfied, and B is any open set of Y . Then $f^{-1}(B)$ is a set in X and $f(Ncl(f^{-1}(B))) \subseteq s\text{-pre-Ncl}(f(f^{-1}(B)))$. This implies $f(Ncl(f^{-1}(B))) \subseteq s\text{-pre-Ncl}(B)$. This is nothing but condition (ii). Hence f is an neutrosophic *s-pre*-continuous.

4 NEUTROSOPHIC SUPRA *PRE*-OPEN MAPS AND NEUTROSOPHIC SUPRA *PRE*-CLOSED MAPS.

Definition 4.1.

A map $f : X \rightarrow Y$ is called neutrosophic supra *pre*-open (res.neutrosophic supra *pre*-closed) if the image of each open (resp.closed) set in X , is neutrosophic supra *pre*-open(resp.neutrosophic supra *pre*-closed)in Y .

Theorem 4.2.

A map $f : X \rightarrow Y$ is called an neutrosophic supra *pre*-open if and only if $f(Nint(A)) \subseteq s\text{-pre-Nint}(f(A))$ for every set A in X .

Proof. Suppose that f is an neutrosophic supra *pre*-open map. Since $Nint(A) \subseteq f(A)$. By hypothesis $f(Nint(A))$ is a neutrosophic supra *pre*-open set and $s\text{-pre-Nint}(f(A))$ is the largest neutrosophic supra *pre*-open set contained in $f(A)$, then $f(Nint(A)) \subseteq s\text{-pre-Nint}(f(A))$

Conversely, let A be a open set in X . Then $f(Nint(A)) \subseteq s\text{-pre-Nint}(f(A))$. Since $Nint(A) = A$, then $f(A) \subseteq s\text{-pre-Nint}(f(A))$. Therefore $f(A)$ is an neutrosophic supra *pre*-open set in Y and f is an neutrosophic supra *pre*-open.

Theorem 4.3. A map $f : X \rightarrow Y$ is called a neutrosophic supra *pre*-closed if and only if $f(Ncl(A)) \subseteq s\text{-pre-Ncl}(f(A))$ for every set A in X .

Proof. Suppose that f is an neutrosophic supra *pre*-closed map. Since for each set A in X , $Ncl(A)$ is closed set in X , then $f(Ncl(A))$ is an neutrosophic supra *pre*-closed set in Y .

Also, since $f(A) \subseteq f(Ncl(A))$, then $s\text{-pre-}Ncl(f(A)) \subseteq f(Ncl(A))$.

Conversely, let A be a closed set in X . Since $s\text{-pre-}Ncl(f(A))$ is the smallest neutrosophic supra pre -closed set containing $f(A)$, then $f(A) \subseteq s\text{-pre-}Ncl(f(A)) \subseteq f(Ncl(A)) = f(A)$. Thus $f(A) = s\text{-pre-}Ncl(f(A))$. Hence $f(A)$ is an neutrosophic supra pre -closed set in Y . Therefore f is a neutrosophic supra pre -closed map.

Theorem 4.4. Let $f : X \rightarrow Y$ and $g : Y \rightarrow Z$ be two maps.

- (i) If $g \circ f$ is an neutrosophic supra pre -open and f is continuous surjective, then g is an neutrosophic semi-supra pre -open.
- (ii) If $g \circ f$ is open and g is an neutrosophic supra pre continuous injective, then f is neutrosophic supra pre -open.

Theorem 4.5 Let $f : X \rightarrow Y$ be a map. Then the following are equivalent;

- (i) f is an neutrosophic supra pre -open map;
- (ii) f is an neutrosophic supra pre -closed map;
- (iii) f is an neutrosophic supra pre -continuous map.

Proof. (i) \implies (ii). Suppose B is a closed set in X . Then $X - B$ is an open set in X . By (1), $f(X - B)$ is an neutrosophic supra pre -open set in Y . Since f is bijective, then $f(X - B) = Y - f(B)$. Hence $f(B)$ is an neutrosophic supra pre -closed set in Y . Therefore f is an neutrosophic supra pre -closed map.

(ii) \implies (iii). Let f is an neutrosophic supra pre -closed map and B be closed set X . Since f is bijective, then $(f^{-1})^{-1}(B) = f(B)$ is an neutrosophic supra pre -closed set in Y . By Theorem 3.7 f is an neutrosophic supra pre -continuous map.

(iii) \implies (i). Let A be an open set in X . Since f^{-1} is an neutrosophic supra pre -continuous map, then $(f^{-1})^{-1}(A) = f(A)$ is an neutrosophic supra pre -open set in Y . Hence f is an neutrosophic supra pre -open.

REFERENCES

- Atanassov, K. T. (1986). Intuitionistic fuzzy sets. *Fuzzy sets and Systems*, 20(1), 87–96.
- Çoker, D. (1997). An introduction to intuitionistic fuzzy topological spaces. *Fuzzy sets and systems*, 88(1), 81–89.
- Devi, R., Sampathkumar, S., & Caldas, M. (2008). On supra α -open sets and $s\alpha$ -continuous maps. *General Mathematics*, 16(2), 77–84.

- Dhavaseelan, R., & Jafari, S. (in press). Generalized neutrosophic closed sets. In S. Florentin & S. Pramanik (Eds.), *New trends in neutrosophy theory and applications* (Vol. 2). Pons asbl.
- El-Monsef, M. A., & Ramadan, A. (1987). On fuzzy supratopological spaces. *Indian Journal of Pure and Applied Mathematics*, 18(4), 322–329.
- Mashhour, A., Allam, A., Mahmoud, F., & Khedr, F. (1983). On supratopological spaces. *Indian Journal of Pure and Applied Mathematics*, 14(4), 502–510.
- Min, W. K. (1996). On fuzzy s- continuous functions. *Korean Journal of Mathematics*, 4(1), 77-82.
- Salama, A., & Alblowi, S. (2012). Neutrosophic set and neutrosophic topological spaces. *IOSR Journal of Mathematics (IOSR-JM)*, 3(4), 31–35.
- Smarandache, F. (1999). *Neutrosophy: A unifying field in logics: Neutrosophic logic. neutrosophy, neutrosophic set, neutrosophic probability*. Rehoboth: American Research Press.
- Turnal, N. (2003). An over view of intuitionstic fuzzy supra topological spaces. *Hacettepe Journal of Mathematics and Statistics*, 32, 17-26.
- Zadeh, L. (1965). Fuzzy sets. *Information and Control*, 8(3), 338 - 353.

Single Valued Neutrosophic Finite State Machine and Switchboard State Machine

Tahir Mahmood¹, Qaisar Khan^{1,*}, Kifayat Ullah², Naeem Jan³

^{1,1,*2,3} Department of Mathematics, International Islamic University, Islamabad, Pakistan

E-mail: tahirbakhat@yahoo.com

E-mail: qaisarkan421@gmail.com

E-mail: kifayat.phdma72@iiu.edu.pk

Corresponding author's email^{1*}: qaisarkan421@gmail.com

ABSTRACT

Using single valued neutrosophic set we introduced the notion of single valued neutrosophic finite state machine, single valued neutrosophic successor, single valued neutrosophic subsystem and single valued submachine, single valued neutrosophic switchboard state machine, homomorphism and strong homomorphism between single valued neutrosophic switchboard state machine and discussed some related results and properties.

KEYWORDS: Single valued neutrosophic set, single valued neutrosophic state machine, single valued neutrosophic switchboard state machine, homomorphism and strong homomorphism.

1. INTRODUCTION

Fuzzy set was introduced by Zadeh (1965) which is the generalization of mathematical logic. Fuzzy set is a new mathematical tool to describe the uncertainty. There was so many generalizations of fuzzy set namely interval valued fuzzy set (Turksen, 1986), intuitionistic fuzzy set (Atanassov, 1986, 1989), vague set (Gau, & Buehrer, 1993) etc. Interval valued fuzzy was introduced by Turksen in 1986. Intuitionistic fuzzy set was introduced by Atanassov in 1986. Intuitionistic fuzzy set was the generalization of Zadeh fuzzy set and is provably equivalent to interval valued fuzzy where the lower bound of the interval is called membership degree and upper bound of the interval is non-membership degree. The concept of vague set was given by Gau and Buehrer. Buttillo and Bustince show that vague set are intuitionistic fuzzy set (Bustince, & Burillo, 1996). Bipolar fuzzy set was introduced by W. R. Zhang (1998). Jun et al. (2012) introduced the concept of cubic set. Cubic set is an ordered pair of interval-valued fuzzy set and fuzzy set. These all are mathematical modeling to solve the problems in our daily life. These tools have its own inherent problems to solve these types of uncertainty while the cubic set is more informative tool to solve this uncertainty. After the introduction of all fuzzy set extensions Florentin Smarandache (Smarandache, 1998, 1999) introduced the concept of neutrosophy and neutrosophic sets which was the generalization of fuzzy sets, intuitionistic fuzzy sets, interval valued fuzzy set and all extensions of fuzzy sets defined above. The words "neutrosophy" Etymologically, "neutro-sophy" (noun) comes from French neuter Latin neuter, neutral, and Greek sophia, skill/wisdom means knowledge of neutral thought. Neutrosophy is a branch of philosophy introduced by which studies the origin and scope of neutralities, as well as thier interaction with ideational spectra. This theory considers every notion or idea <A> together with its opposite or negation <anti A> and with their spectrum of neutralities <neut A> in between them (i.e. notions or ideas supporting neither < A> nor <anti A>). The <neutA> and <anti A> ideas together are referred to as <nonA>. Neutrosophy is a generalization of Hegel's dialectics (the last one is based on <A> and <antiA> only). While a

"neutrosophic" (adjective), means having the nature of, or having the characteristic of Neutrosophy. A neutrosophic set A is characterized by a truth membership function T_A , Indeterminacy membership function I_A and Falsity membership function F_A . Where T_A, I_A and F_A are real standard and nonstandard subsets of $]^{-}0,1^{+}[$. The neutrosophic sets is suitable for real life problem, but it is difficult to apply in scientific problems. The difference between neutrosophic sets and intuitionistic fuzzy sets is that in neutrosophic sets the degree of indeterminacy is defined independently. To apply neutrosophic set in real life and in scientific problems Wang et al. introduced the concept of single valued neutrosophic set and interval neutrosophic set (Wang et al., 2005, 2010) which are subclasses of neutrosophic set. In which membership function, indeterminacy membership function, falsity membership was taken in the closed interval $[0, 1]$ rather than the nonstandard unit interval. Malik et al. (1994a, 1994b, 1994c, 1997) given the concept and notion of fuzzy finite state machine, submachine of fuzzy finite state machine, subsystem of fuzzy finite state machine, product of fuzzy finite state machine and discussed some related properties. Kumbhojkar & Chaudhari (2002) introduced covering of fuzzy finite state machine. Sato & Kuroki (2002) introduced fuzzy finite switchboard state machine. Jun (2005) generalized the concept of malik et al. (1994a, 1994b, 1994c, 1997) and introduced the concept of intuitionistic fuzzy finite state machine, submachines of intuitionistic fuzzy finite state machine (2006), intuitionistic successor and discussed some related properties (Jun, 2005). Jun (2006) introduced the concept of intuitionistic fuzzy finite switchboard state machine, commutative intuitionistic fuzzy finite state machine and strong homomorphism (Jun, 2006). Jun & Kavikumar (2011) also introduced the concept of bipolar fuzzy finite state machine.

The paper is arranged as follows, section 2 contains preliminaries, section 3 contains the main result single valued neutrosophic finite state machine and related results, section 4 contained Single valued finite switchboard state machine homomorphism, strong homomorphism and related properties. At the end conclusion and references are given.

Section 2. PRELIMINARIES

For basic definition and results the reader should refer to study [10-13, 18].

Definition 1: (Malik et al., 1994a)

A fuzzy finite state machine is a triple $F = (M, U, \lambda)$. Where M and U are finite non-empty sets called the set of states and the set of input symbols respectively, λ is a fuzzy function in $M \times U \times M$ into $[0, 1]$.

Definition 2: (Jun, 2005)

An intuitionistic fuzzy finite state machine is a triple $F = (M, U, C)$. Where M and U are finite non-empty sets called the set of states and the set of input symbols respectively, $C = (\tau_C, \nu_C)$ is an intuitionistic fuzzy set in $M \times U \times M$ into $[0, 1]$.

Definition 3: (Malik et al., 1994b)

Let $F = (M, U, \lambda)$ be a fuzzy finite state machine and $r, s \in M$. Then r is called an immediate successor of $s \in M$ if there exists $x \in U$ such that $\lambda(s, x, r) > 0$. We say that r is called fuzzy successor of s , if there exists $\lambda^*(s, x, r) > 0$.

Definition 4: (Wang et al., 2010)

A single valued neutrosophic set N in X is an object of the form

$$N = \{(\chi_N(x), \psi_N(x), \omega_N(x)) \forall x \in X\}.$$

Where $\chi_N(x), \psi_N(x), \omega_N(x)$ are functions from X into $[0,1]$.

3. SINGLE VALUED NEUTROSOPHIC FINITE STATE MACHINE

Definition 5. A triple $F = (M, U, N)$ is called single valued neutrosophic finite state machine (SVNFSM) for short), where M and U are finite sets. The elements of M is called states and the elements of U is called input symbols. Where is N is a single valued neutrosophic set in $M \times U \times M$. Let the set of all words of finite length of the elements of U is denoted by U^* . The empty word in U^* is denoted by Λ and $|a|$ denote the length of a for every $a \in U^*$.

Definition 6. Let $F = (M, U, N)$ be a SVNFSM. Define a SVNS $N^* = (\chi_{N^*}, \psi_{N^*}, \omega_{N^*})$ in $M \times U^* \times M$ by

$$\begin{aligned} \chi_{N^*}(u, \Lambda, v) &= \begin{cases} 1 & \text{if } u = v \\ 0 & \text{if } u \neq v \end{cases} \\ \psi_{N^*}(u, \Lambda, v) &= \begin{cases} 0 & \text{if } u = v \\ 1 & \text{if } u \neq v \end{cases} \\ \omega_{N^*}(u, \Lambda, v) &= \begin{cases} 0 & \text{if } u = v \\ 1 & \text{if } u \neq v \end{cases} \\ \chi_{N^*}(u, ab, v) &= \bigvee_{w \in M} [\chi_{N^*}(u, a, w) \wedge \chi_N(w, b, v)] \\ \psi_{N^*}(u, ab, v) &= \bigwedge_{w \in M} [\chi_{N^*}(u, a, w) \vee \chi_N(w, b, v)] \\ \omega_{N^*}(u, ab, v) &= \bigwedge_{w \in M} [\chi_{N^*}(u, a, w) \vee \chi_N(w, b, v)] \end{aligned}$$

for all $u, v \in M$ and $a \in U^*$ and $b \in U$.

Lemma 1. Let $F = (M, U, N)$ be SVNFSM. Then

$$\begin{aligned} \chi_{N^*}(u, ab, v) &= \bigvee_{w \in M} [\chi_{N^*}(u, a, w) \wedge \chi_{N^*}(w, b, v)] \\ \psi_{N^*}(u, ab, v) &= \bigwedge_{w \in M} [\chi_{N^*}(u, a, w) \vee \chi_{N^*}(w, b, v)] \\ \omega_{N^*}(u, ab, v) &= \bigwedge_{w \in M} [\chi_{N^*}(u, a, w) \vee \chi_{N^*}(w, b, v)] \end{aligned}$$

for all $u, v \in M$ and $a, b \in U^*$.

Proof. Let $u, v \in M$ and $a, b \in U^*$. Suppose $|b| = n$. We prove the result by induction. If $n = 0$, then $b = \Lambda$ and so $ab = a\Lambda = a$.

$$\begin{aligned} &\bigvee_{w \in M} [\chi_{N^*}(u, a, w) \wedge \chi_{N^*}(w, b, v)] \\ &\bigwedge_{w \in M} [\chi_{N^*}(u, a, w) \wedge \chi_{N^*}(w, \Lambda, v)] \\ &\chi_{N^*}(u, a, v) = \chi_{N^*}(u, ab, v) \end{aligned}$$

and

$$\begin{aligned} &\bigwedge_{w \in M} [\psi_{N^*}(u, a, w) \vee \psi_{N^*}(w, b, v)] \\ &\bigwedge_{w \in M} [\psi_{N^*}(u, a, w) \vee \psi_{N^*}(w, \Lambda, v)] \end{aligned}$$

$$\psi_{N^*}(u, a, v) = \psi_{N^*}(u, ab, v)$$

and

$$\begin{aligned} & \wedge_{w \in M} [\omega_{N^*}(u, a, w) \vee \omega_{N^*}(w, b, v)] \\ & \wedge_{w \in M} [\omega_{N^*}(u, a, w) \vee \omega_{N^*}(w, \Lambda, v)] \\ & \omega_{N^*}(u, a, v) = \omega_{N^*}(u, ab, v) \end{aligned}$$

Hence the result is true for $n=0$. Let us assume that the result is true for all $c \in U^*$ such that $|c|=n-1, n > 0$. Then $b = cd$, where $c \in U^*$ and $d \in U, |c|=n-1, n > 0$. Then

$$\begin{aligned} \chi_{N^*}(u, ab, v) &= \chi_{N^*}(u, acd, v) = \vee_{w \in M} [\chi_{N^*}(u, ac, w) \wedge \chi_N(w, d, v)] \\ &= \vee_{w \in M} [\vee_{z \in M} (\chi_{N^*}(u, a, z) \wedge \chi_{N^*}(z, c, w)) \wedge \chi_N(w, d, v)] \\ &= \vee_{w, z \in M} [\chi_{N^*}(u, a, z) \wedge \chi_{N^*}(z, c, w) \wedge \chi_N(w, d, v)] \\ &= \vee_{z \in M} [\chi_{N^*}(u, a, z) \wedge (\vee_{w \in M} (\chi_{N^*}(z, c, w) \wedge \chi_N(w, d, v)))] \\ &= \vee_{z \in M} [\chi_{N^*}(u, a, z) \wedge \chi_{N^*}(z, cd, v)] \\ &= \vee_{z \in M} [\chi_{N^*}(u, a, z) \wedge \chi_{N^*}(z, b, v)] \end{aligned}$$

and

$$\begin{aligned} \psi_{N^*}(u, ab, v) &= \psi_{N^*}(u, acd, v) = \wedge_{w \in M} [\psi_{N^*}(u, ac, w) \vee \psi_N(w, d, v)] \\ &= \wedge_{w \in M} [\wedge_{z \in M} (\psi_{N^*}(u, a, z) \vee \psi_{N^*}(z, c, w)) \vee \psi_N(w, d, v)] \\ &= \wedge_{w, z \in M} [\psi_{N^*}(u, a, z) \vee \psi_{N^*}(z, c, w) \vee \psi_N(w, d, v)] \\ &= \wedge_{z \in M} [\psi_{N^*}(u, a, z) \vee (\vee_{w \in M} \psi_{N^*}(z, c, w) \vee \psi_N(w, d, v))] \\ &= \wedge_{z \in M} [\psi_{N^*}(u, a, z) \vee \psi_{N^*}(z, cd, v)] \\ &= \wedge_{z \in M} [\psi_{N^*}(u, a, z) \vee \psi_{N^*}(z, b, v)] \end{aligned}$$

and

$$\begin{aligned} \omega_{N^*}(u, ab, v) &= \omega_{N^*}(u, acd, v) = \wedge_{w \in M} [\omega_{N^*}(u, ac, w) \vee \omega_N(w, d, v)] \\ &= \wedge_{w \in M} [\wedge_{z \in M} (\omega_{N^*}(u, a, z) \vee \omega_{N^*}(z, c, w)) \vee \omega_N(w, d, v)] \\ &= \wedge_{w, z \in M} [\omega_{N^*}(u, a, z) \vee \omega_{N^*}(z, c, w) \vee \omega_N(w, d, v)] \\ &= \wedge_{z \in M} [\omega_{N^*}(u, a, z) \vee (\wedge_{w \in M} (\omega_{N^*}(z, c, w) \vee \omega_N(w, d, v)))] \\ &= \wedge_{z \in M} [\omega_{N^*}(u, a, z) \vee \omega_{N^*}(z, cd, v)] \\ &= \wedge_{z \in M} [\omega_{N^*}(u, a, z) \vee \omega_{N^*}(z, b, v)] \end{aligned}$$

Therefore, the result is true for $|b|=n, n > 0$.

Definition 7. Let $F = (M, U, N)$ be a SVNFSM and $u, v \in M$. Then v is called single valued

neutrosophic immediate successor of u if there exists $x \in U$ such that $\chi_N(u, x, v) > 0, \psi_N(u, x, v) < 1$ and $\omega_N(u, x, v) < 1$. We say that v is called single valued neutrosophic successor of u if there exists $x \in U$ such that $\chi_{N^*}(u, x, v) > 0, \psi_{N^*}(u, x, v) < 1$ and $\omega_{N^*}(u, x, v) < 1$. The set of all single valued neutrosophic successor of u is denoted by $SVNS(u)$. The set of all single valued neutrosophic successor of N is denote by

$$SVNS(N) = \cup \{SVNS(u) \mid u \in N\}$$

where N is any subset of M .

Proposition 1. Let $F = (M, U, N)$ be a SVNFSM. For any $u, v \in M$, the following hold:

- (i) $u \in SVNS(u)$
- (ii) if $u \in SVNS(v)$ and $w \in SVNS(u)$, then $r \in SVNS(v)$.

Proof. (i) Since $\chi_{N^*}(u, \Lambda, u) = 1 > 0$, $\psi_{N^*}(u, \Lambda, u) = 0 < 1$ and $\omega_{N^*}(u, \Lambda, u) = 0 < 1$
 (ii) Let $v \in SVNS(u)$ and $w \in SVNS(v)$. Then there exists $a, b \in U^?$ such that $\chi_{N^*}(u, a, v) > 0, \psi_{N^*}(u, a, v) < 1$, and $\omega_{N^*}(u, a, v) < 1, \chi_{N^*}(v, b, w) > 0, \psi_{N^*}(v, b, w) < 1$ and $\omega_{N^*}(v, b, w) < 1$. Using lemma (1), we have

$$\begin{aligned} \chi_{N^*}(u, ab, w) &= \vee_{z \in M} [\chi_{N^*}(u, a, z) \wedge \chi_{N^*}(z, b, w)] \\ &\geq \chi_{N^*}(u, a, v) \wedge \chi_{N^*}(v, b, w) > 0 \end{aligned}$$

And

$$\begin{aligned} \psi_{N^*}(u, ab, w) &= \wedge_{z \in M} [\psi_{N^*}(u, a, z) \vee \psi_{N^*}(z, b, w)] \\ &\leq \psi_{N^*}(u, a, v) \vee \psi_{N^*}(v, b, w) < 1 \end{aligned}$$

and

$$\begin{aligned} \omega_{N^*}(u, ab, w) &= \wedge_{z \in M} [\omega_{N^*}(u, a, z) \vee \omega_{N^*}(z, b, w)] \\ &\leq \omega_{N^*}(u, a, v) \vee \omega_{N^*}(v, b, w) < 1 \end{aligned}$$

Hence $w \in SVNS(v)$.

Proposition 2. Let $F = (M, U, N)$ be SVNFSM. For any subsets C and D the following assertions hold.

- (i) If $C \subseteq D$, then $SVNS(C) \subseteq SVNS(D)$.
- (ii) $C \subseteq SVNS(C)$.
- (iii) $SVNS(SVNS(C)) = SVNS(C)$.
- (iv) $SVNS(C \cup D) = SVNS(C) \cup SVNS(D)$.
- (v) $SVNS(C \cap D) \subseteq SVNS(C) \cap SVNS(D)$

Proof. The proofs of (i),(ii),(iv), and (v) are simple and straightforward.

(iii) Obviously $SVNS(C) \subseteq SVNS(SVNS(C))$. If $u \in SVNS(SVNS(C))$, then $u \in SVNS(v)$ for

some $v \in SVNS(C)$. From $v \in SVNS(C)$, there exists $w \in C$ such that $v \in SVNS(w)$. it follows from proposition (1) that $u \in SVNS(w) \subseteq SVNS(C)$ so that $SVNS(SVNS(C)) \subseteq SVNS(C)$. Hence (iii) is valid.

Definition 8. Let $F = (M, U, N)$ be SVNFSM. We say that φ satisfies the single valued neutrosophic exchange property if, for all $u, v \in M$ and $G \subseteq M$, whenever $v \in SVNS(G \cup \{u\})$ and $v \notin SVNS(G)$ then $u \in SVNS(G \cup \{v\})$.

Theorem 1. Let $F = (M, U, N)$ be a SVNFSM. Then the following assertions are equivalent.

- (i) F satisfies the single valued neutrosophic exchange property.
- (ii) (for all $u, v \in M$) $(v \in SVNS(u)) \Leftrightarrow u \in SVNS(v)$.

Proof. Suppose that φ satisfies the Single valued neutrosophic exchange property. Let $u, v \in M$ be such that $v \in SVNS(u) = SVNS(\varphi \cup \{u\})$. Note that $v \notin SVNS(\varphi)$ and so $u \in SVNS(\varphi \cup \{v\}) = SVNS(v)$. Similarly if $u \in SVNS(v)$ then $v \in SVNS(u)$. Conversely assume that (ii) is valid. Let $u, v \in M$ and $G \subseteq M$. If $v \in SVNS(G \cup \{u\})$, then $v \in SVNS(u)$. It follows from (ii) that

$$u \in SVNS(v) \subseteq SVNS(G \cup \{v\}).$$

Therefore φ satisfies the single valued exchange property.

Definition 9. Let $F = (M, U, N)$ be a SVNFSM. Let $M^* = (\chi_{M^*}, \psi_{M^*}, \omega_{M^*})$ be a single valued neutrosophic set in M . Then (M, M^*, U, N) is called single valued neutrosophic submachine of F if for all $u, v \in M$ and $x \in U$,

$$\begin{aligned} \chi_{M^*}(u) &\geq \chi_{M^*}(v) \wedge \chi_N(v, x, u), \\ \psi_{M^*}(u) &\leq \psi_{M^*}(v) \vee \psi_N(v, x, u), \\ \omega_{M^*}(u) &\leq \omega_{M^*}(v) \vee \omega_N(v, x, u) \end{aligned}$$

Example 1. Let $M = \{u, v\}$, $U = \{x\}$, $\chi_N(u, x, v) = 0.75, \psi_N(u, x, v)$ and $\omega_N(u, x, v) = 0.5$ for all $u, v \in M$. Let $M^* = (\chi_{M^*}, \psi_{M^*}, \omega_{M^*})$ be given by $\chi_{M^*}(u) = 0.5 = \psi_{M^*}(u)$,

$\omega_{M^*}(u) = 0.15$. Then

$$\begin{aligned} \chi_{M^*}(u) \wedge \chi_N(u, x, v) &= 0.5 \wedge 0.75 = 0.5 = \chi_{M^*}(v) \\ \psi_{M^*}(u) \wedge \psi_N(u, x, v) &= 0.5 \vee 0.75 = 0.75 > \psi_{M^*}(v) \\ \omega_{M^*}(u) \vee \omega_N(u, x, v) &= 0.15 \vee 0.5 = 0.5 > \omega_{M^*}(v) \end{aligned}$$

Therefore M^* is a single valued neutrosophic subsystem.

Theorem 2. Let $F = (M, U, N)$ be a SVNFSM and let $M^* = (\chi_{M^*}, \psi_{M^*}, \omega_{M^*})$ be a single valued neutrosophic set in M . Then M^* is a single valued neutrosophic subsystem of M iff

$$\begin{aligned} \chi_{M^*}(u) &\geq \chi_{M^*}(v) \wedge \chi_{N^*}(v, x, u) \\ \psi_{M^*}(u) &\leq \psi_{M^*}(v) \vee \psi_{N^*}(v, x, u) \end{aligned}$$

$$\omega_{M^*}(u) \leq \omega_{M^*}(v) \vee \omega_{N^*}(v, x, u)$$

for all $u, v \in M$ and $x \in M^*$.

Proof. Let us assume that M^* is a single valued neutrosophic subsystem of F . Let $u, v \in M$ and $x \in M^*$. We prove the result by induction on $|x| = n$. If $n = 0$, we have $x = \Lambda$. Now if $v = u$, then

$$\chi_{M^*}(u) \wedge \chi_{N^*}(u, \Lambda, u) = \chi_{M^*}(u)$$

$$\psi_{M^*}(u) \vee \psi_{N^*}(u, \Lambda, u) = \psi_{M^*}(u)$$

and

$$\omega_{M^*}(u) \vee \omega_{N^*}(u, \Lambda, u) = \omega_{M^*}(u)$$

If $u \neq v$, then

$$\chi_{M^*}(v) \wedge \chi_{N^*}(v, x, u) = 0 \leq \chi_{M^*}(u)$$

$$\psi_{M^*}(v) \vee \psi_{N^*}(v, x, u) = 1 \geq \psi_{M^*}(u)$$

and

$$\omega_{M^*}(u) \vee \omega_{N^*}(u, \Lambda, u) = 1 \geq \omega_{M^*}(u)$$

Hence for $n = 0$ the result is true. Now let us assume that the result is true for all $b \in M^*$ with $|b| = n - 1, n > 0$. Let $x = bc$ with $c \in M$. Then

$$\begin{aligned} \chi_{M^*}(v) \wedge \chi_{N^*}(v, x, u) &= \chi_{M^*}(v) \wedge \chi_{N^*}(v, bc, u) \\ &= \chi_{M^*}(v) \wedge \left(\bigvee_{w \in M} [\chi_{N^*}(v, b, w) \wedge \chi_N(w, c, u)] \right) \\ &= \bigvee_{w \in M} \left(\chi_{M^*}(v) \wedge \chi_{N^*}(v, b, w) \wedge \chi_N(w, c, u) \right) \\ &\leq \bigvee_{w \in M} [\chi_{M^*}(w) \wedge \chi_N(w, c, u)] \leq \chi_{M^*}(v) \end{aligned}$$

and

$$\begin{aligned} \psi_{M^*}(v) \vee \psi_{N^*}(v, x, u) &= \psi_{M^*}(v) \vee \psi_{N^*}(v, bc, u) \\ &= \psi_{M^*}(v) \vee \left(\bigwedge_{w \in M} [\psi_{N^*}(v, b, w) \vee \psi_N(w, c, u)] \right) \\ &= \bigwedge_{w \in M} \left(\psi_{M^*}(v) \vee \psi_{N^*}(v, b, w) \vee \psi_N(w, c, u) \right) \\ &\geq \bigwedge_{w \in M} [\psi_{M^*}(w) \vee \psi_N(w, c, u)] \geq \psi_{M^*}(v) \end{aligned}$$

and

$$\begin{aligned} \omega_{M^*}(v) \vee \omega_{N^*}(v, x, u) &= \omega_{M^*}(v) \vee \omega_{N^*}(v, bc, u) \\ &= \omega_{M^*}(v) \vee \left(\bigwedge_{w \in M} [\omega_{N^*}(v, b, w) \vee \omega_N(w, c, u)] \right) \\ &= \bigwedge_{w \in M} \left(\omega_{M^*}(v) \vee \omega_{N^*}(v, b, w) \vee \omega_N(w, c, u) \right) \\ &\geq \bigwedge_{w \in M} [\omega_{M^*}(w) \vee \omega_N(w, c, u)] \geq \omega_{M^*}(v) \end{aligned}$$

the converse of the above theorem is trivial.

Definition 10. Let $F = (M, U, N)$ be a SVNFSM. Let $G \subseteq M$. Let $C = (\chi_C, \psi_C, \omega_C)$ be a single valued neutrosophic set in $G \times U \times G$ and let $\square = (G, U, C)$ be a SVNFSM. Then \square is called single valued neutrosophic submachine of F , if

- (i) $N_{|G \times U \times G} = C$ that is $\chi_{N_{|G \times U \times G}} = \chi_C$, $\psi_{N_{|G \times U \times G}} = \psi_C$ and $\omega_{N_{|G \times U \times G}} = \omega_C$
- (ii) $SVNS(G) \subseteq G$

We assume that $\varphi = (\varphi, U, C)$ is a single valued neutrosophic submachine of F . Obviously, if ξ is a single valued neutrosophic submachine of \square and \square is single valued submachine of F , Then ξ is a single valued submachine of F .

Definition 11. Let $F = (M, U, N)$ be a SVNFSM. Then it is said to be strongly single valued neutrosophic connected if $v \in SVNS(u)$ for every $u, v \in M$. A single valued neutrosophic submachine $\square = (G, U, C)$ of a *SVNfsm* is said to be proper if $\square \neq \varphi$ and $\square \neq M$.

Theorem 3. Let $F = (M, U, N)$ be a SVNFSM and let $\square_i = (G_i, U, C_i), i \in I$, be a family of single valued neutrosophic submachine of F . Then we have the following,

- (i) $\bigcap_{i \in I} \square_i = (\bigcap_{i \in I} G_i, U, \bigcap_{i \in I} C_i)$ is a single valued neutrosophic submachine of F .
- (ii) $\bigcup_{i \in I} \square_i = (\bigcup_{i \in I} G_i, U, D)$ is a single valued neutrosophic submachine of F , where

$D = (\chi_D, \psi_D, \omega_D)$ is given by

$$\chi_D = \chi_{N_{|\bigcup_{i \in I} G_i \times U \times \bigcup_{i \in I} G_i}}, \quad \psi_D = \psi_{N_{|\bigcup_{i \in I} G_i \times U \times \bigcup_{i \in I} G_i}} \quad \text{and} \quad \omega_D = \omega_{N_{|\bigcup_{i \in I} G_i \times U \times \bigcup_{i \in I} G_i}}$$

Proof (i) Let $(u, a, v) \in \bigcap_{i \in I} G_i \times U \times \bigcap_{i \in I} G_i$. Then,

$$(\bigwedge_{i \in I} \chi_{C_i})(u, a, v) = \bigwedge_{i \in I} \chi_{C_i}(u, a, v) = \bigwedge_{i \in I} \chi_N(u, a, v) = \chi_N(u, a, v)$$

$$(\bigvee_{i \in I} \psi_{C_i})(u, a, v) = \bigvee_{i \in I} \psi_{C_i}(u, a, v) = \bigvee_{i \in I} \psi_N(u, a, v) = \psi_N(u, a, v)$$

and

$$(\bigvee_{i \in I} \omega_{C_i})(u, a, v) = \bigvee_{i \in I} \omega_{C_i}(u, a, v) = \bigvee_{i \in I} \omega_N(u, a, v) = \omega_N(u, a, v)$$

Therefore $N_{|\bigcup_{i \in I} G_i \times U \times \bigcup_{i \in I} G_i} = \bigcap_{i \in I} C_i$. Now

$$SVNS(\bigcap_{i \in I} G_i) \subseteq \bigcap_{i \in I} SVNS(G_i) \subseteq \bigcap_{i \in I} G_i.$$

Hence $\bigcap_{i \in I} \square_i$ is a single valued neutrosophic submachine of F .

- (ii) Since $SVNS(\bigcup_{i \in I} G_i) = \bigcup_{i \in I} SVNS(G_i) \subseteq \bigcup_{i \in I} G_i$, $\bigcup_{i \in I} \square_i$ is a submachine of F .

Theorem 4. A *SVNFSM* $F = (M, U, N)$ is strongly single valved neutrosophic connected iff F has no proper single valued neutrosophic submachine.

Proof. Assume that $F = (M, U, N)$ is strongly single valued neutrosophic connected. Let $\square = (G, U, C)$ be a single valued neutrosophic submachine of F such that $G \neq \varphi$. Then there exists $u \in G$. If $v \in SVNS(u)$ since F is strongly single valued neutrosophic connected. It follows that $v \in SVNS(u) \subseteq SVNS(G) \subseteq G$ so that $G = M$. Hence $\square = F$, that is F has no proper single valued neutrosophic submachine. Conversely assume that F has no proper single valued neutrosophic

submachines. Let $u, v \in M$ and let $\square = (SVNS(u), U, C)$, where $C = (\chi_C, \psi_C, \omega_C)$ is given by

$$\chi_C = \chi_{N_{|SVNS(u) \times U \times SVNS(u)}}, \quad \psi_C = \psi_{N_{|SVNS(u) \times U \times SVNS(u)}}, \quad \text{and} \quad \omega_C = \omega_{N_{|SVNS(u) \times U \times SVNS(u)}}$$

Then \square is a single valued neutrosophic submachine of F and $SVNS(u) \neq \emptyset$, and so $SVNS(u) = M$. Thus $v \in SVNS(u)$, and therefore F is strongly single valued neutrosophic connected.

4. SINGLE VALUED NEUTROSOPHIC FINITE SWITCHBOARD STATE MACHINE

Definition 12. An SVNFSM $M = (N, U, S)$ is said to be switching if it satisfies:

$$\chi_S(r, a, s) = \chi_S(s, a, r), \quad \psi_S(r, a, s) = \psi_S(s, a, r)$$

and

$$\omega_S(r, a, s) = \omega_S(s, a, r)$$

for all $r, s \in N$ and $a \in U$.

An SVNFSM $M = (N, U, S)$ is said to be commutative if it satisfies:

$$\chi_S(r, ab, s) = \chi_S(r, ba, s), \quad \psi_S(r, ab, s) = \psi_S(r, ba, s)$$

and

$$\omega_S(r, ab, s) = \omega_S(r, ba, s)$$

for all $r, s \in N$ and $a, b \in U$.

If an SVNFSM $M = (N, U, S)$ is both switching and commutative, then it is called single valued neutrosophic finite switchboard state machine (SVNFSSM for short).

Proposition 3. If $M = (N, U, S)$ is a commutative SVNFSM, then

$$\chi_{S^*}(r, ba, s) = \chi_{S^*}(r, ab, s), \quad \psi_{S^*}(r, ba, s) = \psi_{S^*}(r, ab, s)$$

and

$$\omega_{S^*}(r, ba, s) = \omega_{S^*}(r, ab, s).$$

for all $r, s \in N$ and $a \in U, b \in U^*$.

Proof. Let $r, s \in N$ and $a, b \in U^*$. We prove the result by induction on $|b| = k$. If $k = 0$, then $b = \zeta$, hence

$$\begin{aligned} \chi_{S^*}(r, ba, s) &= \chi_{S^*}(r, \zeta a, s) = \chi_{S^*}(r, a, s) = \chi_{S^*}(r, a\zeta, s) = \chi_{S^*}(r, ab, s), \\ \psi_{S^*}(r, ba, s) &= \psi_{S^*}(r, \zeta a, s) = \psi_{S^*}(r, a, s) = \psi_{S^*}(r, a\zeta, s) = \psi_{S^*}(r, ab, s) \end{aligned}$$

and

$$\omega_{S^*}(r, ba, s) = \omega_{S^*}(r, \zeta a, s) = \omega_{S^*}(r, a, s) = \omega_{S^*}(r, a\zeta, s) = \omega_{S^*}(r, ab, s)$$

Therefore the result is true for $k = 0$. Suppose that the result is true for $|c| = k - 1$. That is for all $c \in U^*$ with $|c| = k - 1, k > 0$. Let $d \in U$ be such that $b = cd$. Then

$$\begin{aligned}
 \chi_{S^*}(r, ba, s) &= \chi_{S^*}(r, cda, s) = \bigvee_{v \in N} [\chi_{S^*}(r, c, v) \wedge \chi_{S^*}(v, da, s)] \\
 &= \bigvee_{v \in N} [\chi_{S^*}(r, c, v) \wedge \chi_{S^*}(v, ad, s)] \\
 &= \chi_{S^*}(r, cad, s) \\
 &= \bigvee_{v \in N} [\chi_{S^*}(r, ca, v) \wedge \chi_S(v, d, s)] \\
 &= \bigvee_{v \in N} [\chi_{S^*}(r, ac, v) \wedge \chi_S(v, d, s)] \\
 &= \chi_{S^*}(r, acd, s) = \chi_{S^*}(r, ab, s), \\
 \psi_{S^*}(r, ba, s) &= \psi_{S^*}(r, cda, s) = \bigwedge_{v \in N} [\psi_{S^*}(r, c, v) \vee \psi_{S^*}(v, da, s)] \\
 &= \bigwedge_{v \in N} [\psi_{S^*}(r, c, v) \vee \psi_{S^*}(v, ad, s)] \\
 &= \psi_{S^*}(r, cad, s) \\
 &= \bigwedge_{v \in N} [\psi_{S^*}(r, ca, v) \vee \psi_S(v, d, s)] \\
 &= \bigwedge_{v \in N} [\psi_{S^*}(r, ac, v) \vee \psi_S(v, d, s)] \\
 &= \psi_{S^*}(r, acd, s) = \psi_{S^*}(r, ab, s)
 \end{aligned}$$

and

$$\begin{aligned}
 \omega_{S^*}(r, ba, s) &= \omega_{S^*}(r, cda, s) = \bigwedge_{v \in N} [\omega_{S^*}(r, c, v) \vee \omega_{S^*}(v, da, s)] \\
 &= \bigwedge_{v \in N} [\omega_{S^*}(r, c, v) \vee \omega_{S^*}(v, ad, s)] \\
 &= \omega_{S^*}(r, cad, s) \\
 &= \bigwedge_{v \in N} [\omega_{S^*}(r, ca, v) \vee \omega_S(v, d, s)] \\
 &= \bigwedge_{v \in N} [\omega_{S^*}(r, ac, v) \vee \omega_S(v, d, s)] \\
 &= \omega_{S^*}(r, acd, s) = \omega_{S^*}(r, ab, s)
 \end{aligned}$$

Hence the result is true for $|b| = k$. Thus completes the proof.

Proposition 4. If $M = (N, U, S)$ is an SVNFSM, then

$$\chi_{S^*}(r, a, s) = \chi_{S^*}(s, a, r), \psi_{S^*}(r, a, s) = \psi_{S^*}(s, a, r)$$

and

$$\omega_{S^*}(r, a, s) = \omega_{S^*}(s, a, r).$$

for all $r, s \in N$ and $a \in U^*$.

Proof. Let $r, s \in N$ and $a \in U^*$. We prove the result by induction on $|a| = k$. If $k = 0$, then $b = \zeta$, hence

$$\begin{aligned}
 \chi_{S^*}(r, a, s) &= \chi_{S^*}(r, \zeta, s) = \chi_{S^*}(s, \zeta, r) = \chi_{S^*}(s, a, r), \\
 \psi_{S^*}(r, a, s) &= \psi_{S^*}(r, \zeta, s) = \psi_{S^*}(s, \zeta, r) = \psi_{S^*}(s, a, r)
 \end{aligned}$$

and

$$\omega_{S^*}(r, a, s) = \omega_{S^*}(r, \zeta, s) = \omega_{S^*}(s, \zeta, r) = \omega_{S^*}(s, a, r)$$

Therefore the result is true for $k=0$. Assume that the result is true for $|b|=k-1$. That is for all $b \in U^*$ with $|b|=k-1, k > 0$, we have

$$\chi_{S^*}(r, b, s) = \chi_{S^*}(s, b, r), \psi_{S^*}(r, b, s) = \psi_{S^*}(s, b, r)$$

and

$$\omega_{S^*}(r, b, s) = \omega_{S^*}(s, b, r).$$

Let $x \in U$ and $b \in U^*$ be such that $a = bx$. Then

$$\begin{aligned} \chi_{S^*}(r, a, s) &= \chi_{S^*}(r, bx, s) = \bigvee_{v \in N} [\chi_{S^*}(r, b, v) \wedge \chi_S(v, x, s)] \\ &= \bigvee_{v \in N} [\chi_{S^*}(v, b, r) \wedge \chi_S(s, x, r)] \\ &= \bigvee_{v \in N} [\chi_{S^*}(v, b, r) \wedge \chi_{S^*}(s, x, r)] \\ &= \bigvee_{v \in N} [\chi_{S^*}(s, x, r) \wedge \chi_{S^*}(r, b, v)] \\ &= \chi_{S^*}(s, xb, r) = \chi_{S^*}(s, bx, r) = \chi_{S^*}(s, a, r), \end{aligned}$$

$$\begin{aligned} \psi_{S^*}(r, a, s) &= \psi_{S^*}(r, bx, s) = \bigwedge_{v \in N} [\psi_{S^*}(r, b, v) \vee \psi_S(v, x, s)] \\ &= \bigwedge_{v \in N} [\psi_{S^*}(v, b, r) \vee \psi_S(s, x, r)] \\ &= \bigwedge_{v \in N} [\psi_{S^*}(v, b, r) \vee \psi_{S^*}(s, x, r)] \\ &= \bigwedge_{v \in N} [\psi_{S^*}(s, x, r) \vee \psi_{S^*}(r, b, v)] \\ &= \psi_{S^*}(s, xb, r) = \psi_{S^*}(s, bx, r) = \psi_{S^*}(s, a, r) \end{aligned}$$

and

$$\begin{aligned} \omega_{S^*}(r, a, s) &= \omega_{S^*}(r, bx, s) = \bigwedge_{v \in N} [\omega_{S^*}(r, b, v) \vee \omega_S(v, x, s)] \\ &= \bigwedge_{v \in N} [\omega_{S^*}(v, b, r) \vee \omega_S(s, x, r)] \\ &= \bigwedge_{v \in N} [\omega_{S^*}(v, b, r) \vee \omega_{S^*}(s, x, r)] \\ &= \bigwedge_{v \in N} [\omega_{S^*}(s, x, r) \vee \omega_{S^*}(r, b, v)] \\ &= \omega_{S^*}(s, xb, r) = \omega_{S^*}(s, bx, r) = \omega_{S^*}(s, a, r) \end{aligned}$$

This shows that the result is true for $|b|=k$.

Proposition 5. If $M = (N, U, S)$ is an SVNFSM, then

$$\alpha_{S^*}(r, ab, s) = \alpha_{S^*}(r, ba, s), \beta_{S^*}(r, ab, s) = \beta_{S^*}(r, ba, s)$$

and

$$\gamma_{S^*}(r, ab, s) = \gamma_{S^*}(r, ba, s).$$

for all c and $a, b \in U^*$.

Proof. Let $r, s \in N$ and $a, b \in U^*$. We prove the result by induction on $|b|=k$. If $k=0$, then

$b = \zeta$, hence

$$\begin{aligned}\chi_{S^*}(r, ab, s) &= \chi_{S^*}(r, a\zeta, s) = \chi_{S^*}(r, a, s) = \chi_{S^*}(r, \zeta a, s) = \chi_{S^*}(r, ba, s), \\ \psi_{S^*}(r, ab, s) &= \psi_{S^*}(r, a\zeta, s) = \psi_{S^*}(r, a, s) = \psi_{S^*}(r, \zeta a, s) = \psi_{S^*}(r, ba, s)\end{aligned}$$

and

$$\omega_{S^*}(r, ab, s) = \omega_{S^*}(r, a\zeta, s) = \omega_{S^*}(r, a, s) = \omega_{S^*}(r, \zeta a, s) = \omega_{S^*}(r, ba, s)$$

Therefore the result is true for $k = 0$. Suppose that the result is true for $|c| = k - 1$. That is for all $c \in U^*$ with $|c| = k - 1, k > 0$. Let $d \in U$ be such that $b = cd$. Then

$$\begin{aligned}\chi_{S^*}(r, ab, s) &= \chi_{S^*}(r, acd, s) = \bigvee_{v \in N} \left[\chi_{S^*}(r, ac, v) \wedge \chi_S(v, d, s) \right] \\ &= \bigvee_{v \in N} \left[\chi_{S^*}(r, ca, v) \wedge \chi_S(v, d, s) \right] \\ &= \bigvee_{v \in N} \left[\chi_{S^*}(v, ca, r) \wedge \chi_S(s, d, v) \right] \\ &= \bigvee_{v \in N} \left[\chi_S(s, d, v) \wedge \chi_{S^*}(v, ca, r) \right] \\ &= \chi_{S^*}(s, dca, r) = \bigvee_{v \in N} \left[\chi_{S^*}(s, dc, v) \wedge \chi_{S^*}(v, a, r) \right] \\ &= \bigvee_{v \in N} \left[\chi_{S^*}(s, cd, v) \wedge \chi_{S^*}(v, a, r) \right] = \chi_{S^*}(s, cda, r) \\ &= \chi_{S^*}(r, cda, s) = \chi_{S^*}(r, ba, s),\end{aligned}$$

$$\begin{aligned}\psi_{S^*}(r, ab, s) &= \psi_{S^*}(r, acd, s) = \bigwedge_{v \in N} \left[\psi_{S^*}(r, ac, v) \vee \psi_S(v, d, s) \right] \\ &= \bigwedge_{v \in N} \left[\psi_{S^*}(r, ca, v) \vee \psi_S(v, d, s) \right] \\ &= \bigwedge_{v \in N} \left[\psi_{S^*}(v, ca, r) \vee \psi_S(s, d, v) \right] \\ &= \bigwedge_{v \in N} \left[\psi_S(s, d, v) \vee \psi_{S^*}(v, ca, r) \right] \\ &= \psi_{S^*}(s, dca, r) = \bigwedge_{v \in N} \left[\psi_{S^*}(s, dc, v) \vee \psi_{S^*}(v, a, r) \right] \\ &= \bigwedge_{v \in N} \left[\psi_{S^*}(s, cd, v) \vee \psi_{S^*}(v, a, r) \right] = \psi_{S^*}(s, cda, r) \\ &= \psi_{S^*}(r, cda, s) = \psi_{S^*}(r, ba, s)\end{aligned}$$

and

$$\begin{aligned}
 \omega_{S^*}(r, ab, s) &= \omega_{S^*}(r, acd, s) = \bigwedge_{v \in N} [\omega_{S^*}(r, ac, v) \vee \omega_S(v, d, s)] \\
 &= \bigwedge_{v \in N} [\omega_{S^*}(r, ca, v) \vee \omega_S(v, d, s)] \\
 &= \bigwedge_{v \in N} [\omega_{S^*}(v, ca, r) \vee \omega_S(s, d, v)] \\
 &= \bigwedge_{v \in N} [\omega_S(s, d, v) \vee \omega_{S^*}(v, ca, r)] \\
 &= \omega_{S^*}(s, dca, r) = \bigwedge_{v \in N} [\omega_{S^*}(s, dc, v) \vee \omega_{S^*}(v, a, r)] \\
 &= \bigwedge_{v \in N} [\omega_{S^*}(s, cd, v) \vee \omega_{S^*}(v, a, r)] = \omega_{S^*}(s, cda, r) \\
 &= \omega_{S^*}(r, cda, s) = \omega_{S^*}(r, ba, s)
 \end{aligned}$$

This shows that the result is true for $|b| = k$.

Definition 13. Let $M_S = (N_1, U_1, S)$ and $M_T = (N_2, U_2, T)$ be two SVNFSMs. A pair (α, β) of mappings $\alpha : N_1 \rightarrow N_2$ and $\beta : U_1 \rightarrow U_2$ is called homomorphism, written as $(\alpha, \beta) : M_S \rightarrow M_T$, if it satisfies:

$$\chi_S(r, a, s) \leq \chi_T(\alpha(r), \beta(a), \alpha(s)), \psi_S(r, a, s) \geq \psi_T(\alpha(r), \beta(a), \alpha(s))$$

and

$$\omega_S(r, a, s) \geq \omega_T(\alpha(r), \beta(a), \alpha(s))$$

for all $r, s \in N_1$ and $a \in U_1$.

Definition 14. Let $M_S = (N_1, U_1, S)$ and $M_T = (N_2, U_2, T)$ be two SVNFSMs. A pair (α, β) of mappings $\alpha : N_1 \rightarrow N_2$ and $\beta : U_1 \rightarrow U_2$ is called a strong homomorphism, written as $(\alpha, \beta) : M_S \rightarrow M_T$, if it satisfies:

$$\begin{aligned}
 \chi_T(\alpha(r), \beta(a), \alpha(s)) &= \vee \{ \chi_S(r, a, v) \mid v \in N_1, \alpha(v) = \alpha(s) \}, \\
 \psi_T(\alpha(r), \beta(a), \alpha(s)) &= \wedge \{ \psi_S(r, a, v) \mid v \in N_1, \alpha(v) = \alpha(s) \}
 \end{aligned}$$

and

$$\omega_T(\alpha(r), \beta(a), \alpha(s)) = \wedge \{ \omega_S(r, a, v) \mid v \in N_1, \alpha(v) = \alpha(s) \}$$

for all $r, s \in N_1$ and $a \in U_1$. If $U_1 = U_2$ and ϵ is the identity map, then we simply write $\alpha : M_S \rightarrow M_T$ and say that \mathcal{A} is a homomorphism or strong homomorphism accordingly. If (α, β) is a strong homomorphism with \mathcal{A} is one-one, then

$$\chi_T(\alpha(r), \beta(a), \alpha(s)) = \chi_S(r, a, s), \psi_T(\alpha(r), \beta(a), \alpha(s)) = \psi_S(r, a, s)$$

and

$$\omega_T(\alpha(r), \beta(a), \alpha(s)) = \omega_S(r, a, s)$$

for all $r, s \in N_1$ and $a \in U_1$.

Theorem 5. Let $M_S = (N_1, U_1, S)$ and $M_T = (N_2, U_2, T)$ be two SVNFSMs. Let $(\alpha, \beta) : M_S \rightarrow M_T$ be an onto strong homomorphism. If M_S is a commutative, then so is M_T .

Proof. Let $r_2, s_2 \in N_2$. Then there are $r_1, s_1 \in N_1$ such that $\alpha(r_1) = r_2$ and $\alpha(s_1) = s_2$. Let $x_2, y_2 \in U_2$. Then there exists $x_1, y_1 \in U_1$ such that $\beta(x_1) = x_2$ and $\beta(y_1) = y_2$. Since M_S is commutative, we have

$$\begin{aligned}
 \chi_{T^*}(r_2, x_2 y_2, s_2) &= \chi_{T^*}(\alpha(r_1), \beta(x_1) \beta(y_1), \alpha(s_1)) \\
 &= \chi_{T^*}(\alpha(r_1), \beta(x_1, y_1), \alpha(s_1)) \\
 &= \vee \{ \chi_{S^*}(r_1, x_1 y_1, v_1) \mid v_1 \in N_1, \alpha(v_1) = \alpha(s_1) \} \\
 &= \vee \{ \chi_{S^*}(r_1, y_1 x_1, v_1) \mid v_1 \in N_1, \alpha(v_1) = \alpha(s_1) \} \\
 &= \chi_{T^*}(\alpha(r_1), \beta(y_1 x_1), \alpha(s_1)) \\
 &= \chi_{T^*}(r_2, y_2 x_2, s_2), \\
 \psi_{T^*}(r_2, x_2 y_2, s_2) &= \psi_{T^*}(\alpha(r_1), \beta(x_1) \beta(y_1), \alpha(s_1)) \\
 &= \psi_{T^*}(\alpha(r_1), \beta(x_1, y_1), \alpha(s_1)) \\
 &= \wedge \{ \psi_{S^*}(r_1, x_1 y_1, v_1) \mid v_1 \in N_1, \alpha(v_1) = \alpha(s_1) \} \\
 &= \wedge \{ \psi_{S^*}(r_1, y_1 x_1, v_1) \mid v_1 \in N_1, \alpha(v_1) = \alpha(s_1) \} \\
 &= \psi_{T^*}(\alpha(r_1), \beta(y_1 x_1), \alpha(s_1)) \\
 &= \psi_{T^*}(\alpha(r_1), \beta(y_1) \beta(x_1), \alpha(s_1)) \\
 &= \psi_{T^*}(r_2, y_2 x_2, s_2)
 \end{aligned}$$

and

$$\begin{aligned}
 \omega_{T^*}(r_2, x_2 y_2, s_2) &= \omega_{T^*}(\alpha(r_1), \beta(x_1) \beta(y_1), \alpha(s_1)) \\
 &= \omega_{T^*}(\alpha(r_1), \beta(x_1, y_1), \alpha(s_1)) \\
 &= \wedge \{ \omega_{S^*}(r_1, x_1 y_1, v_1) \mid v_1 \in N_1, \alpha(v_1) = \alpha(s_1) \} \\
 &= \wedge \{ \omega_{S^*}(r_1, y_1 x_1, v_1) \mid v_1 \in N_1, v(v_1) = \alpha(s_1) \} \\
 &= \omega_{T^*}(\alpha(r_1), \beta(y_1 x_1), \alpha(s_1)) \\
 &= \omega_{T^*}(\alpha(r_1), \beta(y_1) \beta(x_1), \alpha(s_1)) \\
 &= \omega_{T^*}(r_2, y_2 x_2, s_2)
 \end{aligned}$$

Hence M_T is a commutative SVNFSM. This completes the proof.

Proposition 6. Let $M_S = (N_1, U_1, S)$ and $M_T = (N_2, U_2, T)$ be two SVNFSMs. Let $(\alpha, \beta) : M_S \rightarrow M_T$ be a strong homomorphism. Then

$$\begin{aligned}
 (\forall u, v \in N_1)(\forall a \in U_1)(\chi_T(\alpha(u), \beta(a), \alpha(v)) > 0 \\
 \Rightarrow (\exists w \in N_1)(\chi_S(u, a, v) > 0, \alpha(w) = v(v)), \\
 (\forall u, v \in N_1)(\forall a \in U_1)(\psi_T(\alpha(u), \beta(a), \alpha(v)) < 1 \\
 \Rightarrow (\exists w \in N_1)(\psi_S(u, a, v) < 1, \alpha(w) = v(v)),
 \end{aligned}$$

and

$$\begin{aligned}
 (\forall u, v \in N_1)(\forall a \in U_1)(\omega_T(\alpha(u), \alpha(a), \alpha(v)) < 1 \\
 \Rightarrow (\exists w \in N_1)(\omega_S(u, a, v) < 1, v(w) = \alpha(v)).
 \end{aligned}$$

Moreover,

$$\begin{aligned}
 (\forall z \in N_1)(\alpha(z) = v(u) \Rightarrow \chi_S(u, a, w) \geq \chi_S(z, a, r), \\
 \psi_S(u, a, w) \leq \psi_S(z, a, r) \text{ and } \omega_S(u, a, w) \leq \omega_S(z, a, r).
 \end{aligned}$$

Proof. Let $u, v, z \in N_1$ and $a \in U_1$. Assume that $\chi_T(\alpha(u), \beta(a), \alpha(v)) > 0$, $(\psi_T(\alpha(u), \beta(a), \alpha(v)) < 1$ and $(\omega_T(\alpha(u), \beta(a), \alpha(v)) < 1$. Then

$$\begin{aligned} & \vee\{\chi_S(u, a, v_1) \mid v_1 \in N_1, \alpha(v_1) = \alpha(v)\} > 0 \\ & \wedge\{\psi_S(u, a, v_1) \mid v_1 \in N_1, \alpha(v_1) = \alpha(v)\} < 1 \end{aligned}$$

and

$$\wedge\{\omega_S(u, a, v_1) \mid v_1 \in N_1, \alpha(v_1) = \alpha(v)\} < 1$$

Since N_1 is finite, it follows that there exists $w \in N_1$ such that $\alpha(w) = \alpha(v)$,

$$\begin{aligned} \chi_S(u, a, w) &= \vee\{\chi_S(u, a, v_1) \mid v_1 \in N_1, \alpha(v_1) = \alpha(w)\} > 0, \\ \psi_S(u, a, w) &= \wedge\{\psi_S(u, a, v_1) \mid v_1 \in N_1, \alpha(v_1) = \alpha(w)\} < 1 \end{aligned}$$

and

$$\omega_S(u, a, w) = \wedge\{\omega_S(u, a, v_1) \mid v_1 \in N_1, \alpha(v_1) = \alpha(w)\} < 1$$

Now suppose that $\alpha(z) = \alpha(u)$ for every $z \in N_1$. Then

$$\begin{aligned} \chi_S(u, a, w) &= \chi_T(\alpha(u), \beta(a), \alpha(v)) = \chi_T(\alpha(z), \beta(a), \alpha(v)) \\ &= \vee\{\chi_S(z, a, v_1) \mid v_1 \in N_1, \alpha(v_1) = \alpha(v)\} \geq \chi_S(z, a, v), \end{aligned}$$

$$\begin{aligned} \psi_S(u, a, w) &= \psi_T(\alpha(u), \beta(a), \alpha(v)) = \psi_T(\alpha(z), \beta(a), \alpha(v)) \\ &= \wedge\{\psi_S(z, a, v_1) \mid v_1 \in N_1, \alpha(v_1) = \alpha(v)\} \leq \psi_S(z, a, v) \end{aligned}$$

and

$$\begin{aligned} \omega_S(u, a, w) &= \omega_T(\alpha(u), \beta(a), \alpha(v)) = \omega_T(\alpha(z), \beta(a), \alpha(v)) \\ &= \wedge\{\omega_S(z, a, v_1) \mid v_1 \in N_1, \alpha(v_1) = \alpha(v)\} \leq \omega_S(z, a, v) \end{aligned}$$

Which is the required proof.

Lemma 2. Let $M_S = (N_1, U_1, S)$ and $M_T = (N_2, U_2, T)$ be two SVNFSMs. Let $(\alpha, \beta): M_S \rightarrow M_T$ be a homomorphism. Define a mapping $\beta^*: U_1^* \rightarrow U_2^*$ by $\beta^*(\zeta) = \zeta$ and $\beta^*(xy) = \beta^*(x)\beta^*(y)$ for all $x \in U_1^*$ and $y \in U_1$. Then $\beta^*(ab) = \beta^*(a)\beta^*(b)$ for all $a, b \in U_1^*$.

Proof Let $a, b \in U_1^*$. We prove the result by induction on $|b| = k$. If $k = 0$, then $b = \zeta$. Therefore $ab = a\zeta = a$. Hence

$$\beta^*(ab) = \beta^*(a) = \beta^*(a)\zeta = \beta^*(a)\beta^*(\zeta) = \beta^*(a)\beta^*(b)$$

Which shows that the result is true for $k = 0$. Let us assume that the result is true for each $c \in U_1^*$ such that $|c| = k - 1$. That is

$$\beta^*(ab) = \beta^*(a)\beta^*(b)$$

Let $b = cd$, where $c \in U_1^*$ and $d \in U_1$ be such that $|c| = k - 1, k > 0$. Then

$$\beta^*(ab) = \beta^*(acd) = \beta^*(ac)\beta^*(d) = \beta^*(a)\beta^*(c)\beta^*(d) = \beta^*(a)\beta^*(cd) = \beta^*(a)\beta^*(b).$$

Therefore, the result is true for $|b| = k$.

Theorem 6. Let $M_S = (N_1, U_1, S)$ and $M_T = (N_2, U_2, T)$ be two SVNFSMs. Let $(\alpha, \beta): M_S \rightarrow M_T$ be a homomorphism. Then

$$\chi_{S^*}(r, a, s) \leq \chi_{T^*}(\alpha(r), \beta^*(a), \alpha(s)), \psi_{S^*}(r, a, s) \geq \psi_{T^*}(\alpha(r), \beta^*(a), \alpha(s))$$

and

$$\psi_{S^*}(r, a, s) \geq \psi_{T^*}(\alpha(r), \beta^*(a), \alpha(s))$$

for all $r, s \in N_1$ and $a \in U_1^*$.

Proof. Let $r, s \in N_1$ and $a \in U_1^*$. We prove the result by induction on $|a| = k$. If $k = 0$, then $a = \zeta$ and so $\psi^*(a) = \psi^*(\zeta) = \zeta$. If $r = s$, then

$$\chi_{S^*}(r, a, s) = \chi_{S^*}(r, \zeta, s) = 1 = \chi_{T^*}(\alpha(r), \zeta, \alpha(s)) = \chi_{T^*}(\alpha(r), \beta^*(a), \alpha(s)),$$

$$\psi_{S^*}(r, a, s) = \psi_{S^*}(r, \zeta, s) = 0 = \psi_{T^*}(\alpha(r), \zeta, \alpha(s)) = \psi_{T^*}(\alpha(r), \beta^*(a), \alpha(s))$$

and

$$\omega_{S^*}(r, a, s) = \omega_{S^*}(r, \zeta, s) = 0 = \omega_{T^*}(\alpha(r), \zeta, \alpha(s)) = \omega_{T^*}(\alpha(r), \beta^*(a), \alpha(s))$$

If $r \neq s$, then

$$\chi_{S^*}(r, a, s) = \chi_{S^*}(r, \zeta, s) = 0 \leq \chi_{T^*}(\alpha(r), \beta^*(a), \alpha(s)),$$

$$\psi_{S^*}(r, a, s) = \psi_{S^*}(r, \zeta, s) = 1 \geq \psi_{T^*}(\alpha(r), \beta^*(a), \alpha(s))$$

and

$$\omega_{S^*}(r, a, s) = \omega_{S^*}(r, \zeta, s) = 1 \geq \omega_{T^*}(\alpha(r), \beta^*(a), \alpha(s))$$

Therefore the result is true for $k = 0$. Let us assume that the result is true for all $b \in U_1^*$ such that $|b| = k - 1, k > 0$. Let $a = bc$ where $b \in U_1^*, c \in U_1$ and $|b| = k - 1$. Then

$$\begin{aligned} \chi_{S^*}(r, a, s) &= \chi_{S^*}(r, bc, s) = \bigvee_{v \in N_1} [\chi_{S^*}(r, b, v) \wedge \chi_{S^*}(v, c, s)] \\ &\leq \bigvee_{v \in N_1} [\chi_{T^*}(\alpha(r), \beta^*(b), \alpha(v)) \wedge \chi_{T^*}(\alpha(v), \beta(c), \alpha(s))] \\ &\leq \bigvee_{v^\circ \in N_1} [\chi_{T^*}(\alpha(r), \beta^*(b), v^\circ) \wedge \chi_{T^*}(v^\circ, \beta(c), \alpha(s))] \\ &= \chi_{T^*}(\alpha(r), \beta^*(b)\beta(c), \alpha(s)) \\ &= \chi_{T^*}(\alpha(r), \beta^*(bc), \alpha(s)) \\ &= \chi_{T^*}(\alpha(r), \beta^*(a), \alpha(s)), \\ \psi_{S^*}(r, a, s) &= \psi_{S^*}(r, bc, s) = \bigwedge_{v \in N_1} [\psi_{S^*}(r, b, v) \vee \psi_{S^*}(v, c, s)] \\ &\geq \bigwedge_{v \in N_1} [\psi_{T^*}(\alpha(r), \beta^*(b), \alpha(v)) \vee \psi_{T^*}(\alpha(v), \beta(c), \alpha(s))] \\ &\geq \bigwedge_{v^\circ \in N_1} [\psi_{T^*}(\alpha(r), \beta^*(b), v^\circ) \vee \psi_{T^*}(v^\circ, \beta(c), v(s))] \\ &= \psi_{T^*}(\alpha(r), \beta^*(b)\beta(c), \alpha(s)) \\ &= \psi_{T^*}(\alpha(r), \beta^*(bc), \alpha(s)) \\ &= \psi_{T^*}(\alpha(r), \beta^*(a), \alpha(s)) \end{aligned}$$

and

$$\begin{aligned}
 \omega_{S^*}(r, a, s) &= \omega_{S^*}(r, bc, s) = \wedge_{v \in N_1} [\omega_{S^*}(r, b, v) \vee \omega_{S^*}(v, c, s)] \\
 &\geq \wedge_{v \in N_1} [\omega_{T^*}(\alpha(r), \beta^*(b), \alpha(v)) \vee \omega_{T^*}(\alpha(v), \beta(c), \alpha(s))] \\
 &\geq \wedge_{v^\circ \in N_1} [\omega_{T^*}(\alpha(r), \beta^*(b), v^\circ) \vee \omega_{T^*}(v^\circ, \beta(c), \alpha(s))] \\
 &= \omega_{T^*}(\alpha(r), \beta^*(b)\beta(c), \alpha(s)) \\
 &= \omega_{T^*}(\alpha(r), \beta^*(bc), \alpha(s)) \\
 &= \omega_{T^*}(\alpha(r), \beta^*(a), \alpha(s))
 \end{aligned}$$

Which is the required proof.

Theorem 7. Let $M_S = (N_1, U_1, S)$ and $M_T = (N_2, U_2, T)$ be two SVNFSMs. Let $(\alpha, \beta): M_S \rightarrow M_T$ be a strong homomorphism. If α is one-one, then

$$\chi_{S^*}(r, a, s) = \chi_{T^*}(\alpha(r), \beta^*(a), \alpha(s)), \psi_{S^*}(r, a, s) = \psi_{T^*}(\alpha(r), \beta^*(a), \alpha(s))$$

and

$$\omega_{S^*}(r, a, s) = \omega_{T^*}(\alpha(r), \beta^*(a), \alpha(s))$$

for all $r, s \in N_1$ and $a \in U_1^*$.

Proof. Let us assume that α is 1-1 and for $r, s \in N_1$ and $a \in U_1^*$. Let $|a| = k$. We prove the result by induction on $|a| = k$. If $k = 0$, then $a = \zeta$ and $\beta^*(\zeta) = \zeta$. Since $\alpha(r) = \alpha(s)$ if and only if $r = s$, we get

$$\chi_{S^*}(r, a, s) = \chi_{S^*}(r, \zeta, s) = 1$$

if and only if

$$\chi_{T^*}(\alpha(r), \beta^*(a), \alpha(s)) = \chi_{T^*}(\alpha(r), \beta^*(\zeta), \alpha(s)) = 1,$$

$$\psi_{S^*}(r, a, s) = \psi_{S^*}(r, \zeta, s) = 0$$

if and only if

$$\psi_{T^*}(\alpha(r), \beta^*(a), \alpha(s)) = \psi_{T^*}(\alpha(r), \beta^*(\zeta), \alpha(s)) = 0,$$

and

$$\omega_{S^*}(r, a, s) = \omega_{S^*}(r, \zeta, s) = 0$$

if and only if

$$\omega_{T^*}(\alpha(r), \beta^*(a), \alpha(s)) = \omega_{T^*}(\alpha(r), \beta^*(\zeta), \alpha(s)) = 0$$

Let us assume that the result is true for all $b \in U_1^*$ such that $|b| = k - 1, k > 0$. Let $a = bc$, where $|b| = k - 1, k > 0$ and $b \in U_1^*, c \in U_1$. Then

$$\begin{aligned}
 \chi_{T^*}(\alpha(r), \beta^*(a), \alpha(s)) &= \chi_{T^*}(\alpha(r), \beta^*(bc), \alpha(s)) = \chi_{T^*}(\alpha(r), \beta^*(b)\beta(c), \alpha(s)) \\
 &= \bigvee_{v \in N_1} [\chi_{T^*}(\alpha(r), \beta^*(b), \alpha(v)) \wedge \chi_T(\alpha(v), \beta(c), \alpha(s))] \\
 &= \bigvee_{v \in N_1} [\chi_{S^*}(r, b, v) \wedge \chi_S(v, c, s)] \\
 &= \chi_{S^*}(r, bc, s) = \chi_{S^*}(r, a, s), \\
 \psi_{T^*}(\alpha(r), \beta^*(a), \alpha(s)) &= \psi_{T^*}(\alpha(r), \beta^*(bc), \alpha(s)) = \psi_{T^*}(\alpha(r), \beta^*(b)\beta(c), \alpha(s)) \\
 &= \bigwedge_{v \in N_1} [\psi_{T^*}(\alpha(r), \beta^*(b), \alpha(v)) \vee \psi_T(\alpha(v), \beta(c), \alpha(s))] \\
 &= \bigwedge_{v \in N_1} [\psi_{S^*}(r, b, v) \vee \psi_S(v, c, s)] \\
 &= \psi_{S^*}(r, bc, s) = \psi_{S^*}(r, a, s)
 \end{aligned}$$

and

$$\begin{aligned}
 \omega_{T^*}(\alpha(r), \beta^*(a), \alpha(s)) &= \omega_{T^*}(\alpha(r), \beta^*(bc), \alpha(s)) = \omega_{T^*}(\alpha(r), \beta^*(b)\beta(c), \alpha(s)) \\
 &= \bigwedge_{v \in N_1} [\omega_{T^*}(\alpha(r), \beta^*(b), \alpha(v)) \vee \omega_T(\alpha(v), \beta(c), \alpha(s))] \\
 &= \bigwedge_{v \in N_1} [\omega_{S^*}(r, b, v) \vee \omega_S(v, c, s)] \\
 &= \omega_{S^*}(r, bc, s) = \omega_{S^*}(r, a, s)
 \end{aligned}$$

Which is the required proof.

CONCLUSION

Using the notion of single valued neutrosophic set we introduced the notion of single valued neutrosophic finite state machine, single valued neutrosophic successors, single valued neutrosophic subsystem, and single valued neutrosophic submachines. which are the generalization of fuzzy finite state machine and intuitionistic fuzzy finite state machine. We also defined single valued neutrosophic switchboard state machine, homomorphism and strong homomorphism between single valued neutrosophic switchboard state machine and discussed some related results and properties.

In future we shall apply the concept of neutrosophic set to automata theory.

REFERENCES

- Atanassov, K. T. (1986). Intuitionistic fuzzy sets. *Fuzzy Sets and Systems*, 20, 87-96.
- Atanassov, K. T. (1989). More on intuitionistic fuzzy sets. *Fuzzy sets and systems*, 33(1), 37-45.
- Bustince, H., & Burillo, P. (1996). Vague sets are intuitionistic fuzzy sets. *Fuzzy sets and systems*, 79 (3), 403-405.
- Gau, W. L., & Buehrer, D. J. (1993). Vague sets. *IEEE transactions on systems, man, and cybernetics*, 23(2), 610-614.
- Jun, Y. B. (2005). Intuitionistic fuzzy finite state machines. *Journal of Applied Mathematics and Computing*, 17(1-2), 109-120.
- Jun, Y. B. (2006). Intuitionistic fuzzy finite switchboard state machines. *Journal of Applied Mathematics and Computing*, 20(1-2), 315-325.
- Jun, Y. B., & Kavikumar, J. (2011). Bipolar fuzzy finite state machines. *Bull. Malays. Math. Sci. Soc.*, 34(1), 181-188.

- Jun, Y. B., Kim, C. S., & Yang, K. O. (2012). Cubic sets. *Annals of Fuzzy Mathematics and Informatics*, 4(1), 83-98.
- Kumbhojkar, H. V., & Chaudhari, S. R. (2002). On covering of products of fuzzy finite state machines. *Fuzzy Sets and Systems*, 125(2), 215-222.
- Malik, D. S., Mordeson, J. N., & Sen, M. K. (1994a). Semigroups of fuzzy finite state machines. *Advances in fuzzy theory and technology*, 2, 87-98.
- Malik, D. S., Mordeson, J. N., & Sen, M. K. (1994b). Submachines of fuzzy finite state machines. *The Journal of fuzzy mathematics*, 2 (4), 781-792.
- Malik, D. S., Mordeson, J. N., & Sen, M. K. (1994c). On subsystems of a fuzzy finite state machine. *Fuzzy Sets and Systems*, 68(1), 83-92.
- Malik, D. S., Mordeson, J. N., & Sen, M. K. (1997). Products of fuzzy finite state machines. *Fuzzy Sets and Systems*, 92(1), 95-102.
- Smarandache, F. (1998). Neutrosophy: neutrosophic probability set and logic: analytic synthesis & synthetic analysis.
- Smarandache, F. (1999). A Unifying Field in Logics: Neutrosophic Logic. In *Philosophy* (pp. 1-141). American Research Press.
- Sato, Y., & Kuroki, N. (2002). Fuzzy finite switchboard state machines. *Journal of Fuzzy Mathematics*, 10(4), 863-874.
- Turksen, I. B. (1986). Interval valued fuzzy sets based on normal forms. *Fuzzy sets and systems*, 20 (2), 191-210.
- Wang, H., Smarandache, F., Zhang, Y. Q., & Sunderraman, R. (2010). Single valued neutrosophic sets. *Multispace and Multistructure*, 4, 410-413.
- Wang, H., Smarandache, F., Sunderraman, R., & Zhang, Y. Q. (2005). Interval Neutrosophic Sets and Logic: Theory and Applications in Computing: Theory and Applications in Computing (Vol. 5).
- Zadeh, L. A. (1965). Fuzzy sets. *Information and control*, 8(3), 338-353.
- Zhang, W. R. (1998, May). (Yin)(Yang) bipolar fuzzy sets. In *Fuzzy Systems Proceedings, 1998. IEEE World Congress on Computational Intelligence., The 1998 IEEE International Conference on* (Vol. 1, pp. 835-840). IEEE.

Neutrosophic Sets: An Overview

Said Broumi^{1,*}, Assia Bakali², Mohamed Talea³, Florentin Smarandache⁴, Vakkas Uluçay⁵, Mehmet Sahin⁶, Arindam Dey⁷, Mamouni Dhar⁸, Rui-Pu Tan⁹, Ayoub Bahnasse¹⁰, Surapati Pramanik¹¹

^{1,3} Laboratory of Information Processing, Faculty of Science Ben M'Sik, University Hassan II, B.P 7955, Sidi Othman, Casablanca, Morocco.

Email: broumisaid78@gmail.com, taleamohamed@yahoo.fr

²Ecole Royale Navale, Boulevard Sour Jdid, B.P 16303 Casablanca, Morocco.

Email: assiabakali@yahoo.fr

⁴Department of Mathematics, University of New Mexico, 705 Gurley Avenue, Gallup, NM 87301, USA

Email: fsmarandache@gmail.com

^{5,6}Department of Mathematics, Gaziantep University, Gaziantep 27310-Turkey

Email: vulucay27@gmail.com, mesahin@gantep.edu.tr.

⁷Saroj Mohan Institute of Technology, West Bengal, India

Email: arindam84nit@gmail.com

⁸Department of Mathematics Science College Kokrajhar-783370, Assam, India

E-mail: mamonidhar@gmail.com

⁹School of Economics and Management of Fuzhou University, China.

E-mail: tanruipu@fjxu.edu.cn, tanruipu123@163.com

¹⁰ Laboratory of Information Processing, Faculty of Science Ben M'Sik, University Hassan II, B.P 7955, Sidi Othman, Casablanca, Morocco. Email: a.bahnasse@gmail.com

¹¹Department of Mathematics, Nandalal Ghosh B.T. College, Panpur, P.O.-Narayanpur, District –North 24 Parganas, Pin code-743126, West Bengal, India. ^{1*}E-mail: sura_pati@yahoo.co.in

ABSTRACT

In this study, we give some concepts concerning the neutrosophic sets, single valued neutrosophic sets, interval-valued neutrosophic sets, bipolar neutrosophic sets, neutrosophic hesitant fuzzy sets, inter-valued neutrosophic hesitant fuzzy sets, refined neutrosophic sets, bipolar neutrosophic refined sets, multi-valued neutrosophic sets, simplified neutrosophic linguistic sets, neutrosophic over/off/under sets, rough neutrosophic sets, rough bipolar neutrosophic sets, rough neutrosophic hyper-complex set, and their basic operations. Then we introduce triangular neutrosophic numbers, trapezoidal neutrosophic fuzzy number and their basic operations. Also some comparative studies between the existing neutrosophic sets and neutrosophic number are provided.

KEYWORDS: Neutrosophic sets (NSs), Single valued neutrosophic sets (SVNSs), Interval-valued neutrosophic sets (IVNSs), Bipolar neutrosophic sets (BNSs), Neutrosophic hesitant fuzzy sets (NHFSs), Interval valued neutrosophic hesitant fuzzy sets (IVNHFSs), Refined neutrosophic sets (RNSs), Bipolar neutrosophic refined sets (BNRSs), Multi-valued neutrosophic sets (MVNSs), Simplified neutrosophic linguistic sets, Neutrosophic numbers, Neutrosophic over/off/under sets, Rough neutrosophic sets, Bipolar rough neutrosophic sets, Rough neutrosophic sets, Bipolar rough neutrosophic sets, Rough neutrosophic hyper-complex set

1. INTRODUCTION

The concept of fuzzy sets was introduced by L. Zadeh (1965). Since then the fuzzy sets and fuzzy logic are used widely in many applications involving uncertainty. But it is observed that there still remain some situations which cannot be covered by fuzzy sets and so the concept of interval valued fuzzy sets (Zadeh, 1975) came into force to capture those situations, Although Fuzzy set theory is very successful in handling uncertainties arising from vagueness or partial belongingness of an element in a set, it cannot model all

sorts of uncertainties prevailing in different real physical problems such as problems involving incomplete information. Further generalization of the fuzzy set was made by Atanassov (1986), which is known as intuitionistic fuzzy sets (IFS). In IFS, instead of one membership grade, there is also a non-membership grade attached with each element. Further there is a restriction that the sum of these two grades is less or equal to unity. The conception of IFS can be viewed as an appropriate/ alternative approach in case where available information is not sufficient to define the impreciseness by the conventional fuzzy sets. Later on intuitionistic fuzzy sets were extended to interval valued intuitionistic fuzzy sets (Atanassov & Gargov, 1989). Neutrosophic sets (NSs) proposed by (Smarandache, 1998, 1999, 2002, 2005, 2006, 2010) which is a generalization of fuzzy sets and intuitionistic fuzzy set, is a powerful tool to deal with incomplete, indeterminate and inconsistent information which exist in the real world. Neutrosophic sets are characterized by truth membership function (T), indeterminacy membership function (I) and falsity membership function (F). This theory is very important in many application areas since indeterminacy is quantified explicitly and the truth membership function, indeterminacy membership function and falsity membership functions are independent. Wang, Smarandache, Zhang, & Sunderraman (2010) introduced the concept of single valued neutrosophic set. The single-valued neutrosophic set can independently express truth-membership degree, indeterminacy-membership degree and falsity-membership degree and deals with incomplete, indeterminate and inconsistent information. All the factors described by the single-valued neutrosophic set are very suitable for human thinking due to the imperfection of knowledge that human receives or observes from the external world.

Single valued neutrosophic set has been developing rapidly due to its wide range of theoretical elegance and application areas; see for examples (Sodenkamp, 2013; Kharal, 2014; Broumi & Smarandache, 2014; Broumi & Smarandache, 2013; Hai-Long, Zhi-Lian, Yanhong, & Xiuwu, 2016; Biswas, Pramanik, & Giri, 2016a, 2016b, 2016c; 2017; Ye, 2014a, 2014b, 2014c, 2015a, 2016).

Wang, Smarandache, Zhang, & Sunderraman (2005) proposed the concept of interval neutrosophic set (INS) which is an extension of neutrosophic set. The interval neutrosophic set (INS) can represent uncertain, imprecise, incomplete and inconsistent information which exists in real world.

Single valued neutrosophic number is an extension of fuzzy numbers and intuitionistic fuzzy numbers. Single valued fuzzy number is a special case of single valued neutrosophic set and is of importance for decision making problems. Ye (2015b) and Biswas, Pramanik, and Giri (2014) studied the concept of trapezoidal neutrosophic fuzzy number as a generalized representation of trapezoidal fuzzy numbers, trapezoidal intuitionistic fuzzy numbers, triangular fuzzy numbers and triangular intuitionistic fuzzy numbers and applied them for dealing with multi-attribute decision making (MADM) problems. Deli & Subas (2017) and Biswas et al. (2016b) studied the ranking of single valued neutrosophic trapezoidal numbers and applied the concept to solve MADM problems. Liang, Wang, & Zhang (2017) presented a multi-criteria decision-making method based on single-valued trapezoidal neutrosophic preference relations with complete weight information.

Ye (2014b) proposed the concept of single valued neutrosophic hesitant fuzzy sets (SVNHFS). As a combination of hesitant fuzzy sets (HFS) and single valued neutrosophic sets (SVNs), the single valued neutrosophic hesitant fuzzy set (SVNHF) is an important concept to handle uncertainty and vague information existing in real life which consists of three membership functions and encompass the fuzzy set (FS), intuitionistic fuzzy sets (IFS), hesitant fuzzy set (HFs), dual hesitant fuzzy set (DHF) and single valued neutrosophic set (SVNS). Theoretical development and applications of such concepts can be found in (Wang & Li, 2016; Ye, 2016). Peng, Wang, Wu, Wang, & Chen, 2014; Peng & Wang, 2015) introduced the concept of multi-valued neutrosophic set as a new branch of NSs which is the same concept of neutrosophic hesitant fuzzy set. Multi-valued neutrosophic sets can be applied in addressing problems with uncertain, imprecise, incomplete and inconsistent information existing in real scientific and engineering applications.

Tian, Wang, Zhang, Chen, & Wang (2016) defined the concept of simplified neutrosophic linguistic sets which combine the concept of simplified neutrosophic sets and linguistic term sets. Simplified neutrosophic

linguistic sets have enabled great progress in describing linguistic information to some extent. It may be considered to be an innovative construct.

Deli, Ali, and Smarandache (2015a) defined the concept of bipolar neutrosophic set and its score, certainty and accuracy functions. In the same study, Deli et al. (2015a) proposed the A_w and G_w operators to aggregate the bipolar neutrosophic information. Furthermore, based on the A_w and G_w operators and the score, certainty and accuracy functions, Deli et al. (2015a) developed a bipolar neutrosophic multiple criteria decision-making approach, in which the evaluation values of alternatives on the attributes assume the form of bipolar neutrosophic numbers. Some theoretical and applications using bipolar neutrosophic sets are studied by several authors (Uluçay, Deli, & Şahin, 2016; Dey, Pramanik, & Giri, 2016a; Pramanik, Dey, Giri, & Smarandache, 2017;).

Maji (2013) defined neutrosophic soft set. The development of decision making algorithms using neutrosophic soft set theory has been reported in the literature (Deli & Broumi, 2015; Dey, Pramanik, & Giri, 2015, 2016b, 2016c; Pramanik & Dalapati (2016), Das, Kumar, Kar, & Pal, 2017).

Broumi, Smarandache, and Dhar (2014a, 2014b) defined rough neutrosophic set and proved its basic properties. Some theoretical advancement and applications have been reported in the literature (Mondal & Pramanik, 2014, 2015a, 2015b, 2015c, 2015d, 2015e, 2015f, 2015g, 2015h); Mondal, Pramanik, and Smarandache (2016a, 2016b, 2016c, 2016d); Pramanik & Mondal (2015a, 2015b, 2015c); Pramanik, Roy, Roy, & Smarandache (2017); Pramanik, Roy, & Roy (2017).

Ali, Deli, and Smarandache (2016) and Jun, Smarandache, and Kim (2017) proposed neutrosophic cubic set by extending the concept of cubic set. Some studies in neutrosophic cubic set environment have been reported in the literature (Banerjee, Giri, Pramanik, & Smarandache (2017); Pramanik, Dey, Giri, & Smarandache (2017b); Pramanik, Dalapati, Alam, & Roy (2017a, 2017b); Pramanik, Dalapati, Alam, Roy & Smarandache (2017); Ye (2017); Lu & Ye (2017).

Another extension of neutrosophic set namely, neutrosophic refined set and its application was studied by several researchers (Deli, Broumi, & Smarandache, 2015b; Broumi & Smarandache, 2014b; Broumi, & Deli, 2014; Uluçay, Deli, & Şahin, 2016, Pramanik, S., Banerjee, D., & Giri, 2016a, 2016b; Mondal & Pramanik, 2015h, 2015i.; Ye & Smarandache, 2016., Chen, Ye, & Du, 2017).

Later on, several extensions of neutrosophic set have been proposed in the literature by researchers to deal with different type of problems such as bipolar neutrosophic refined sets (Deli & Şubaş, 2016), tri-complex rough neutrosophic set (Mondal & Pramanik, 2015g), rough neutrosophic hyper-complex set (Mondal, Pramanik & Smarandache, 2016d), rough bipolar neutrosophic set. (Pramanik & Mondal, 2016) simplified neutrosophic linguistic sets (SNLS) (Tian, Wang, Zhang, Chen, & Wang, 2016), quadripartitioned single valued neutrosophic sets (Chatterjee, Majumdar, Samanta, 2016). Smarandache (2016a, 2016b) proposed new version of neutrosophic sets such as neutrosophic off/under/over sets. To have a glimpse of new trends of neutrosophic theory and applications, readers can see the latest editorial book (Smarandache & Pramanik, 2016). Interested readers can find a variety of applications of single valued neutrosophic sets and their hybrid extensions in the website of the Journal “Neutrosophic Sets and Systems” namely, <http://fs.gallup.unm.edu/nss>.

BASIC AND FUNDAMENTAL CONCEPTS

2.1. Neutrosophic sets (Smarandache, 1998)

Let ξ be the universe. A neutrosophic set (NS) A in ξ is characterized by a truth membership function T_A , an indeterminacy membership function I_A and a falsity membership function F_A where T_A, I_A and F_A are real standard elements of $[0,1]$. It can be written as

$$A = \{ \langle x, (T_A(x), I_A(x), F_A(x)) \rangle : x \in E, T_A, I_A, F_A \in]^{-}0, 1^{+}[\}$$

There is no restriction on the sum of $T_A(x), I_A(x)$ and $F_A(x)$ and so $0^{-} \leq T_A(x) + I_A(x) + F_A(x) \leq 3^{+}$

2.2 Single valued neutrosophic sets (Wang et al., 2010)

Let X be a space of points (objects) with generic elements in ξ denoted by x . A single valued neutrosophic set A (SVNS) is characterized by truth-membership function $T_A(x)$, an indeterminacy-membership function $I_A(x)$, and a falsity-membership function $F_A(x)$. For each point x in ξ , $T_A(x), I_A(x), F_A(x) \in [0, 1]$. A SVNS A can be written as

$$A = \{ \langle x: T_A(x), I_A(x), F_A(x) \rangle, x \in \xi \}$$

2.3 Interval valued neutrosophic sets (Wang et al., 2005)

Let ξ be a space of points (objects) with generic elements in X denoted by x . An interval valued neutrosophic set A (IVNS A) is characterized by an interval truth-membership function $T_A(x) = [T_A^L, T_A^U]$, an interval indeterminacy-membership function $I_A(x) = [I_A^L, I_A^U]$, and an interval falsity-membership function $F_A(x) = [F_A^L, F_A^U]$. For each point $x \in X$ $T_A(x), I_A(x), F_A(x) \subset [0, 1]$. An IVNS A can be written as

$$A = \{ \langle x: T_A(x), I_A(x), F_A(x) \rangle, x \in \xi \}$$

Numerical Example: Assume that $X = \{x_1, x_2, x_3\}$, x_1 is capability, x_2 trustworthiness, x_3 price. The values of x_1, x_2 and x_3 are in $[0, 1]$. They are obtained from questionnaire of some domain experts and the result can be obtained as the degree of good, degree of indeterminacy and the degree of poor. Then an interval neutrosophic set can be obtained as

$$A = \left\{ \begin{array}{l} \langle x_1, [0.5, 0.3], [0.1, 0.6], [0.4, 0.2] \rangle, \\ \langle x_2, [0.3, 0.2], [0.4, 0.3], [0.4, 0.5] \rangle, \\ \langle x_3, [0.6, 0.3], [0.4, 0.1], [0.5, 0.4] \rangle \end{array} \right.$$

2.3 Bipolar neutrosophic sets (Deli et al., 2015)

A bipolar neutrosophic set A in ξ is defined as an object of the form

$A = \{ \langle x, T^p(x), I^p(x), F^p(x), T^n(x), I^n(x), F^n(x) \rangle : x \in \xi \}$, where $T^p, I^p, F^p: \xi \rightarrow [1, 0]$ and $T^n, I^n, F^n: \xi \rightarrow [-1, 0]$. The positive membership degree $T^p(x), I^p(x), F^p(x)$ denote the truth membership, indeterminate membership and false membership of an element $\in \xi$ corresponding to a bipolar neutrosophic set A and the negative membership degree $T^n(x), I^n(x), F^n(x)$ denotes the truth membership, indeterminate membership and false membership of an element $\in \xi$ to some implicit counter-property corresponding to a bipolar neutrosophic set A .

An empty bipolar neutrosophic set $\tilde{A}_1 = \langle T_1^p, I_1^p, F_1^p, T_1^n, I_1^n, F_1^n \rangle$ is defined as $T_1^p = 0, I_1^p = 0, F_1^p = 1$ and $T_1^n = -1, I_1^n = 0, F_1^n = 0$.

Numerical Example: Let $X = \{x_1, x_2, x_3\}$ then

$$A = \begin{cases} \langle x_1, 0.5, 0.3, 0.1, -0.6, -0.4, -0.01 \rangle, \\ \langle x_2, 0.3, 0.2, 0.4, -0.03, -0.004, -0.05 \rangle, \\ \langle x_3, 0.6, 0.5, 0.4, -0.1, -0.5, -0.004 \rangle \end{cases}$$

is a bipolar neutrosophic number.

2.4 Neutrosophic hesitant fuzzy set (Ye, 2014)

Let ξ be a non-empty fixed set, a neutrosophic hesitant fuzzy set (NHFS) on X is expressed by: $N = \{ \langle x, \tilde{t}(x), \tilde{i}(x), \tilde{f}(x) \rangle | x \in \xi \}$, where $\tilde{t}(x) = \{ \tilde{\gamma} | \tilde{\gamma} \in \tilde{t}(x) \}$, $\tilde{i}(x) = \{ \tilde{\delta} | \tilde{\delta} \in \tilde{i}(x) \}$ and $\tilde{f}(x) = \{ \tilde{\vartheta} | \tilde{\vartheta} \in \tilde{f}(x) \}$ are three sets with some values in interval $[0,1]$, which represents the possible truth-membership hesitant degrees, indeterminacy-membership hesitant degrees, and falsity-membership hesitant degrees of the element $x \in \xi$ to the set N , and satisfies these limits :

$$\tilde{\gamma} \in [0,1], \tilde{\delta} \in [0,1], \tilde{\vartheta} \in [0,1] \text{ and } 0 \leq \sup \tilde{\gamma}^+ + \sup \tilde{\delta}^+ + \sup \tilde{\vartheta}^+ \leq 3$$

where $\tilde{\gamma}^+ = \bigcup_{\tilde{\gamma} \in \tilde{t}(x)} \max\{\tilde{\gamma}\}$, $\tilde{\delta}^+ = \bigcup_{\tilde{\delta} \in \tilde{i}(x)} \max\{\tilde{\delta}\}$ and $\tilde{\vartheta}^+ = \bigcup_{\tilde{\vartheta} \in \tilde{f}(x)} \max\{\tilde{\vartheta}\}$ for $x \in X$.

The $\tilde{n} = \{ \tilde{t}(x), \tilde{i}(x), \tilde{f}(x) \}$ is called a neutrosophic hesitant fuzzy element (NHFE) which is the

basic unit of the NHFS and is denoted by the symbol $\tilde{n} = \{ \tilde{t}, \tilde{i}, \tilde{f} \}$.

2.5 Interval neutrosophic hesitant fuzzy set (Ye, 2016)

Let ξ be a fixed set, an INHFS on ξ is defined as

$$N = \{ \langle x, \tilde{t}(x), \tilde{i}(x), \tilde{f}(x) \rangle | x \in \xi \}.$$

Here $\tilde{t}(x)$, $\tilde{i}(x)$ and $\tilde{f}(x)$ are sets of some different interval values in $[0, 1]$, representing the possible truth-membership hesitant degrees, indeterminacy-membership hesitant degrees, and falsity-membership hesitant degrees of the element $x \in \xi$ to the set N , respectively. Then $\tilde{t}(x)$ reads $\tilde{t}(x) = \{ \tilde{\gamma} | \tilde{\gamma} \in \tilde{t}(x) \}$, where $\tilde{\gamma} = [\tilde{\gamma}^L, \tilde{\gamma}^U]$ is an interval number, $\tilde{\gamma}^L = \inf \tilde{\gamma}$ and $\tilde{\gamma}^U = \sup \tilde{\gamma}$ represent the lower and upper limits of $\tilde{\gamma}$, respectively; $\tilde{i}(x)$ reads $\tilde{i}(x) = \{ \tilde{\delta} | \tilde{\delta} \in \tilde{i}(x) \}$, where $\tilde{\delta} = [\tilde{\delta}^L, \tilde{\delta}^U]$ is an interval number, $\tilde{\delta}^L = \inf \tilde{\delta}$ and $\tilde{\delta}^U = \sup \tilde{\delta}$ represent the lower and upper limits of $\tilde{\delta}$, respectively; $\tilde{f}(x)$ reads $\tilde{f}(x) = \{ \tilde{\vartheta} | \tilde{\vartheta} \in \tilde{f}(x) \}$, where $\tilde{\vartheta} = [\tilde{\vartheta}^L, \tilde{\vartheta}^U]$ is an interval number, $\tilde{\vartheta}^L = \inf \tilde{\vartheta}$ and $\tilde{\vartheta}^U = \sup \tilde{\vartheta}$ represent the lower and upper limits of $\tilde{\vartheta}$, respectively. Hence, there is the condition

$$0 \leq \sup \tilde{\gamma}^+ + \sup \tilde{\delta}^+ + \sup \tilde{\vartheta}^+ \leq 3$$

where $\tilde{\gamma}^+ = \bigcup_{\tilde{\gamma} \in \tilde{t}(x)} \max\{\tilde{\gamma}\}$, $\tilde{\delta}^+ = \bigcup_{\tilde{\delta} \in \tilde{i}(x)} \max\{\tilde{\delta}\}$ and $\tilde{\vartheta}^+ = \bigcup_{\tilde{\vartheta} \in \tilde{f}(x)} \max\{\tilde{\vartheta}\}$ for $x \in X$.

For convenience, $\tilde{n} = \{ \tilde{t}(x), \tilde{i}(x), \tilde{f}(x) \}$ is called an interval neutrosophic hesitant fuzzy element (INHFE), which is denoted by the simplified symbol $\tilde{n} = \{ \tilde{t}, \tilde{i}, \tilde{f} \}$.

2.6 Multi-valued neutrosophic sets (Wang & Li, 2015; Peng & Wang, 2015)

Let X be a space of points (objects) with generic elements in X denoted by x , then multi-valued neutrosophic sets A in X is characterized by a truth-membership function $\tilde{T}_A(x)$, an indeterminacy-membership function $\tilde{I}_A(x)$, and a falsity-membership function $\tilde{F}_A(x)$. Multi-valued neutrosophic sets can be defined as the following form:

$$A = \{ \langle x, \tilde{T}_A(x), \tilde{I}_A(x), \tilde{F}_A(x) \rangle \mid x \in X \},$$

where $\tilde{T}_A(x) \in [0,1]$, $\tilde{I}_A(x) \in [0,1]$, $\tilde{F}_A(x) \in [0,1]$, are sets of finite discrete values, and satisfies the condition $0 \leq \gamma, \eta, \xi \leq 1$, $0 \leq \gamma^+ + \eta^+ + \xi^+ \leq 3$, $\gamma \in \tilde{T}_A(x)$, $\eta \in \tilde{I}_A(x)$, $\xi \in \tilde{F}_A(x)$, $\gamma^+ = \sup \tilde{T}_A(x)$, $\eta^+ = \sup \tilde{I}_A(x)$, $\xi^+ = \sup \tilde{F}_A(x)$. For the sake of simplicity, $A = \langle \tilde{T}_A, \tilde{I}_A, \tilde{F}_A \rangle$ is called as multi-valued neutrosophic number.

If $\tilde{T}_A(x)$, $\tilde{I}_A(x)$, $\tilde{F}_A(x)$ has only one value, the multi-valued neutrosophic sets is single valued neutrosophic sets. If $\tilde{T}_A(x) = \emptyset$, the multi-valued neutrosophic sets is double hesitant fuzzy sets. If $\tilde{T}_A(x) = \tilde{F}_A(x) = \emptyset$, the multi-valued neutrosophic sets is hesitant fuzzy sets.

Numerical example: Investment company have four options (to invest): the car company, the food company, the computer company, and the arms company, and it considers three criteria: the risk control capability, the growth potential, and the environmental impact. Then the decision matrix based on the multi-valued neutrosophic numbers is R .

$$R = \begin{bmatrix} \langle \{0.4, 0.5\}, \{0.2\}, \{0.3\} \rangle & \langle \{0.4\}, \{0.2, 0.3\}, \{0.3\} \rangle & \langle \{0.2\}, \{0.2\}, \{0.5\} \rangle \\ \langle \{0.6\}, \{0.1, 0.2\}, \{0.2\} \rangle & \langle \{0.6\}, \{0.1\}, \{0.2\} \rangle & \langle \{0.5\}, \{0.2\}, \{0.1, 0.2\} \rangle \\ \langle \{0.3, 0.4\}, \{0.2\}, \{0.3\} \rangle & \langle \{0.5\}, \{0.2\}, \{0.3\} \rangle & \langle \{0.5\}, \{0.2, 0.3\}, \{0.2\} \rangle \\ \langle \{0.7\}, \{0.1, 0.2\}, \{0.1\} \rangle & \langle \{0.6\}, \{0.2\}, \{0.3\} \rangle & \langle \{0.4\}, \{0.3\}, \{0.2\} \rangle \end{bmatrix}.$$

2.7 Neutrosophic overset/ underset/offset (Smarandache, 2016a)

2.7.1. Definition of neutrosophic overset: Let ξ be a universe of discourse and the neutrosophic set $A \subset \xi$. Let $T_A(x)$, $I_A(x)$, $F_A(x)$ be the functions that describe the degree of membership, indeterminate membership and non-membership respectively of a generic element $x \in \xi$ with respect to the neutrosophic set A . A neutrosophic overset (NOVs) A on the universe of discourse ξ is defined as:

$$A = \{ (x, T_A(x), I_A(x), F_A(x)), x \in \xi \text{ and } T(x), I(x), F(x) \in [0, \Omega] \}, \text{ where}$$

$T(x), I(x), F(x): \xi \rightarrow [0, \Omega]$, $0 < 1 < \Omega$ and Ω is called over limit. Then there exist at least one element in A such that it has at least one neutrosophic component > 1 , and no element has neutrosophic component < 0 .

2.7.2 Definition of neutrosophic underset: Let ξ be a universe of discourse and the neutrosophic set $A \subset \xi$. Let $T_A(x)$, $I_A(x)$, $F_A(x)$ be the functions that describe the degree of membership, indeterminate membership and non-membership respectively of a generic element $x \in \xi$ with respect to the neutrosophic set A. A neutrosophic under set (NUs) A on the universe of discourse ξ is defined as:

$$A = \{(x, T_A(x), I_A(x), F_A(x)), x \in \xi \text{ and } T(x), I(x), F(x) \in [\Psi, 1]\}$$

Where

$T(x), I(x), F(x): \xi \rightarrow [\Psi, 1]$, $\Psi < 0 < 1$ and Ψ is called lowerlimit. Then there exist at least one element in A such that it has at least one neutrosophic component < 0 , and no element has neutrosophic component > 1 .

2.7.3 Definition of neutrosophic offset: Let ξ be a universe of discourse and the neutrosophic set $A \subset \xi$. Let $T_A(x)$, $I_A(x)$, $F_A(x)$ be the functions that describe the degree of membership, indeterminate membership and non-membership respectively of a generic element $x \in \xi$ with respect to the neutrosophic set A. A neutrosophic offset (NOFFs) A on the universe of discourse ξ is defined as:

$$A = \{(x, T_A(x), I_A(x), F_A(x)), x \in \xi \text{ and } T(x), I(x), F(x) \in [\Psi, \Omega]\}, \text{ where}$$

$T(x), I(x), F(x): \xi \rightarrow [\Psi, 1]$, $\Psi < 0 < 1 < \Omega$ and Ψ is called underlimit while Ω is called overlimit. Then there exists some elements in A such that at least one neutrosophic component > 1 , and at least another neutrosophic component < 0 .

Numerical example: $A = \{(x_1, \langle 1.2, 0.4, 0.1 \rangle), (x_2, \langle 0.2, 0.3, -0.7 \rangle)\}$, since $T(x_1) = 1.2 > 1$, $F(x_2) = -0.7 < 0$.

2.7.4 Some operations of neutrosophic over/off/under sets

Definition 1: The complement of a neutrosophic overset/ underset/offset A is denoted by $C(A)$ and is defined by

$$C(A) = \{(x, \langle F_A(x), \Psi + \Omega - I_A(x), T_A(x) \rangle), x \in \xi\}.$$

Definition 2: The intersection of two neutrosophic overset/ underset/offset A and B is a neutrosophic overset/ underset/offset denoted C and is denoted by

$C = A \cap B$ and is defined by

$$C = A \cap B = \{(x, \langle \min(T_A(x), T_B(x)), \max(I_A(x), I_B(x)), \max(F_A(x), F_B(x)) \rangle), x \in \xi\}.$$

Definition 3: The union of two overset/ underset/offset A and B is a neutrosophic overset/ underset/offset denoted C and is denoted by

$C = A \cup B$ and is defined by

$$C = A \cup B = \{ (x, \langle \max(T_A(x), T_B(x)), \min(I_A(x), I_B(x)), \min(F_A(x), F_B(x)) \rangle), x \in \xi \}.$$

Let ξ be a universe of discourse and A the neutrosophic set $A \subset U$. Let $T_A(x), I_A(x), F_A(x)$ be the functions that describe the degree of membership, indeterminate membership and non-membership respectively of a generic element $x \in \xi$ with respect to the neutrosophic set A . A neutrosophic overset (NOV) A on the universe of discourse U is defined as:

$$A = \{ (x, T_A(x), I_A(x), F_A(x)), x \in \xi \text{ and } T(x), I(x), F(x) \in [0, \Omega] \}, \text{ where}$$

$T(x), I(x), F(x): \xi \rightarrow [0, \Omega]$, $0 < 1 < \Omega$ and Ω is called overlmit. Then there exist at least one element in A such that it has at least one neutrosophic component > 1 , and no element has neutrosophic component < 0 .

2. OPERATIONS ON SOME NEUTROSOPHIC NUMBERS AND NEUTROSOPHIC SETS

2.1 Single valued neutrosophic number

Let $\tilde{A}_1 = (T_1, I_1, F_1)$ and $\tilde{A}_2 = (T_2, I_2, F_2)$ be two single valued neutrosophic number. Then, the operations for SVNNs are defined as below;

- i. $\tilde{A}_1 \oplus \tilde{A}_2 = \langle T_1 + T_2 - T_1 T_2, I_1 I_2, F_1 F_2 \rangle$
- ii. $\tilde{A}_1 \otimes \tilde{A}_2 = \langle T_1 T_2, I_1 + I_2 - I_1 I_2, F_1 + F_2 - F_1 F_2 \rangle$
- iii. $\lambda \tilde{A}_1 = \langle 1 - (1 - T_1)^\lambda, I_1^\lambda, F_1^\lambda \rangle$
- iv. $\tilde{A}_1^\lambda = (T_1^\lambda, 1 - (1 - I_1)^\lambda, 1 - (1 - F_1)^\lambda)$ where $\lambda > 0$

It is to be noted here that 0_n may be defined as follow:

$$0_n = \{ \langle x, (0, 1, 1) \rangle : x \in X \}.$$

2.2 Neutrosophic hesitant fuzzy set (Ye, 2014)

For two NHFEs $\tilde{n}_1 = \{ \tilde{t}_1, \tilde{i}_1, \tilde{f}_1 \}$, $\tilde{n}_2 = \{ \tilde{t}_2, \tilde{i}_2, \tilde{f}_2 \}$ and a positive scale > 0 , the operations can be defined as follows:

- (1) $\tilde{n}_1 \oplus \tilde{n}_2 = \{ \tilde{t}_1 \oplus \tilde{t}_2, \tilde{i}_1 \otimes \tilde{i}_2, \tilde{f}_1 \otimes \tilde{f}_2 \} = \cup_{\tilde{\gamma}_1 \in \tilde{t}_1, \tilde{\delta}_1 \in \tilde{i}_1, \tilde{\vartheta}_1 \in \tilde{f}_1, \tilde{\gamma}_2 \in \tilde{t}_2, \tilde{\delta}_2 \in \tilde{i}_2, \tilde{\vartheta}_2 \in \tilde{f}_2} \{ \tilde{\gamma}_1 + \tilde{\gamma}_2 - \tilde{\gamma}_1 \cdot \tilde{\gamma}_2, \tilde{\delta}_1 \cdot \tilde{\delta}_2, \tilde{\vartheta}_1 \cdot \tilde{\vartheta}_2 \}$
- (2) $\tilde{n}_1 \otimes \tilde{n}_2 = \{ \tilde{t}_1 \otimes \tilde{t}_2, \tilde{i}_1 \oplus \tilde{i}_2, \tilde{f}_1 \oplus \tilde{f}_2 \} = \cup_{\tilde{\gamma}_1 \in \tilde{t}_1, \tilde{\delta}_1 \in \tilde{i}_1, \tilde{\vartheta}_1 \in \tilde{f}_1, \tilde{\gamma}_2 \in \tilde{t}_2, \tilde{\delta}_2 \in \tilde{i}_2, \tilde{\vartheta}_2 \in \tilde{f}_2} \{ \tilde{\gamma}_1 \cdot \tilde{\gamma}_2, \tilde{\delta}_1 + \tilde{\delta}_2 - \tilde{\delta}_1 \cdot \tilde{\delta}_2, \tilde{\vartheta}_1 + \tilde{\vartheta}_2 - \tilde{\vartheta}_1 \cdot \tilde{\vartheta}_2 \}$
- (3) $k \tilde{n}_1 = \cup_{\tilde{\gamma}_1 \in \tilde{t}_1, \tilde{\delta}_1 \in \tilde{i}_1, \tilde{\vartheta}_1 \in \tilde{f}_1} \{ 1 - (1 - \tilde{\gamma}_1)^k, \tilde{\delta}_1^k, \tilde{\vartheta}_1^k \}$
- (4) $\tilde{n}_1^k = \cup_{\tilde{\gamma}_1 \in \tilde{t}_1, \tilde{\delta}_1 \in \tilde{i}_1, \tilde{\vartheta}_1 \in \tilde{f}_1} \{ \tilde{\gamma}_1^k, 1 - (1 - \tilde{\delta}_1)^k, 1 - (1 - \tilde{\vartheta}_1)^k \}.$

2.3 Interval neutrosophic hesitant fuzzy set [Ye, 2016]

For two INHFEs $\tilde{n}_1 = \{ \tilde{t}_1, \tilde{i}_1, \tilde{f}_1 \}$, $\tilde{n}_2 = \{ \tilde{t}_2, \tilde{i}_2, \tilde{f}_2 \}$ and a positive scale > 0 , the following operations can be given as follows:

$$\begin{aligned}
 (1) \quad \tilde{n}_1 \oplus \tilde{n}_2 &= \{\tilde{t}_1 \oplus \tilde{t}_2, \tilde{l}_1 \otimes \tilde{l}_2, \tilde{f}_1 \otimes \tilde{f}_2\} = \cup_{\tilde{\gamma}_1 \in \tilde{t}_1, \tilde{\delta}_1 \in \tilde{l}_1, \tilde{\vartheta}_1 \in \tilde{f}_1, \tilde{\gamma}_2 \in \tilde{t}_2, \tilde{\delta}_2 \in \tilde{l}_2, \tilde{\vartheta}_2 \in \tilde{f}_2} \{[\tilde{\gamma}_1^L + \tilde{\gamma}_2^L - \tilde{\gamma}_1^U \cdot \tilde{\gamma}_2^U, \tilde{\gamma}_1^U + \tilde{\gamma}_2^U - \tilde{\gamma}_1^L \cdot \tilde{\gamma}_2^L], [\tilde{\delta}_1^L \cdot \tilde{\delta}_2^L, \tilde{\delta}_1^U \cdot \tilde{\delta}_2^U], [\tilde{\vartheta}_1^L \cdot \tilde{\vartheta}_2^L, \tilde{\vartheta}_1^U \cdot \tilde{\vartheta}_2^U]\} \\
 (2) \quad \tilde{n}_1 \otimes \tilde{n}_2 &= \{\tilde{t}_1 \otimes \tilde{t}_2, \tilde{l}_1 \oplus \tilde{l}_2, \tilde{f}_1 \oplus \tilde{f}_2\} = \cup_{\tilde{\gamma}_1 \in \tilde{t}_1, \tilde{\delta}_1 \in \tilde{l}_1, \tilde{\vartheta}_1 \in \tilde{f}_1, \tilde{\gamma}_2 \in \tilde{t}_2, \tilde{\delta}_2 \in \tilde{l}_2, \tilde{\vartheta}_2 \in \tilde{f}_2} \{[\tilde{\gamma}_1^L \cdot \tilde{\gamma}_2^L, \tilde{\gamma}_1^U \cdot \tilde{\gamma}_2^U], [\tilde{\delta}_1^L + \tilde{\delta}_2^L - \tilde{\delta}_1^U \cdot \tilde{\delta}_2^U, \tilde{\delta}_1^U + \tilde{\delta}_2^U - \tilde{\delta}_1^L \cdot \tilde{\delta}_2^L], [\tilde{\vartheta}_1^L + \tilde{\vartheta}_2^L - \tilde{\vartheta}_1^U \cdot \tilde{\vartheta}_2^U, \tilde{\vartheta}_1^U + \tilde{\vartheta}_2^U - \tilde{\vartheta}_1^L \cdot \tilde{\vartheta}_2^L]\} \\
 (3) \quad k\tilde{n}_1 &= \cup_{\tilde{\gamma}_1 \in \tilde{t}_1, \tilde{\delta}_1 \in \tilde{l}_1, \tilde{\vartheta}_1 \in \tilde{f}_1} \{[1 - (1 - \tilde{\gamma}_1^L)^k, 1 - (1 - \tilde{\gamma}_1^U)^k], [(\tilde{\delta}_1^L)^k, (\tilde{\delta}_1^U)^k], [(\tilde{\vartheta}_1^L)^k, (\tilde{\vartheta}_1^U)^k]\} \\
 (4) \quad \tilde{n}_1^k &= \cup_{\tilde{\gamma}_1 \in \tilde{t}_1, \tilde{\delta}_1 \in \tilde{l}_1, \tilde{\vartheta}_1 \in \tilde{f}_1} \{[(\tilde{\gamma}_1^L)^k, (\tilde{\gamma}_1^U)^k], [1 - (1 - \tilde{\delta}_1^L)^k, 1 - (1 - \tilde{\delta}_1^U)^k], [1 - (1 - \tilde{\vartheta}_1^L)^k, 1 - (1 - \tilde{\vartheta}_1^U)^k]\}.
 \end{aligned}$$

4. SCORE FUNCTION, ACCURACY FUNCTION AND CERTAINTY FUNCTION OF NEUTROSOPHIC NUMBERS

A convenient method for comparing of single valued neutrosophic number is described as follows:

Let $\tilde{A}_1 = (T_1, I_1, F_1)$ be a single valued neutrosophic number. Then, the score function $s(\tilde{A}_1)$, accuracy function $a(\tilde{A}_1)$ and certainty function $c(\tilde{A}_1)$ of a SVNN are defined as follows:

$$(i) \quad s(\tilde{A}_1) = \frac{2 + T_1 - I_1 - F_1}{3}$$

$$(ii) \quad a(\tilde{A}_1) = T_1 - F_1$$

$$(iii) \quad c(\tilde{A}_1) = T_1.$$

5. RANKING OF NEUTROSOPHIC NUMBERS

Suppose that $\tilde{A}_1 = (T_1, I_1, F_1)$ and $\tilde{A}_2 = (T_2, I_2, F_2)$ are two single valued neutrosophic numbers. Then, the ranking method is defined as follows:

- i. If $s(\tilde{A}_1) > s(\tilde{A}_2)$, then \tilde{A}_1 is greater than \tilde{A}_2 , that is, \tilde{A}_1 is superior to \tilde{A}_2 , denoted by $\tilde{A}_1 > \tilde{A}_2$
- ii. If $s(\tilde{A}_1) = s(\tilde{A}_2)$, and $a(\tilde{A}_1) > a(\tilde{A}_2)$ then \tilde{A}_1 is greater than \tilde{A}_2 , that is, \tilde{A}_1 is superior to \tilde{A}_2 , denoted by $\tilde{A}_1 > \tilde{A}_2$
- iii. If $s(\tilde{A}_1) = s(\tilde{A}_2)$, $a(\tilde{A}_1) = a(\tilde{A}_2)$, and $c(\tilde{A}_1) > c(\tilde{A}_2)$ then \tilde{A}_1 is greater than \tilde{A}_2 , that is, \tilde{A}_1 is superior to \tilde{A}_2 , denoted by $\tilde{A}_1 > \tilde{A}_2$
- iv. If $s(\tilde{A}_1) = s(\tilde{A}_2)$, $a(\tilde{A}_1) = a(\tilde{A}_2)$, and $c(\tilde{A}_1) = c(\tilde{A}_2)$ then \tilde{A}_1 is equal to \tilde{A}_2 , that is, \tilde{A}_1 is indifferent to \tilde{A}_2 , denoted by $\tilde{A}_1 = \tilde{A}_2$

6. DIFFERENT TYPES OF NEUTROSOPHIC NUMBERS AND RELATED TERMS ASSOCIATED WITH THEM

6.1 Single valued-triangular neutrosophic numbers (Ye 2015b)

A single valued triangular neutrosophic number (SVTrN-number) $\tilde{a} = \langle (a_1, b_1, c_1); T_a, I_a, F_a \rangle$ is a special neutrosophic set on the real number set R , whose truth membership, indeterminacy-membership, and a falsity-membership are given as follows:

$$T_a(x) = \begin{cases} \frac{(x-a_1)T_a}{(b_1-a_1)} & (a_1 \leq x \leq b_1) \\ T_a & (x = b_1) \\ \frac{(c_1-x)T_a}{(c_1-b_1)} & (b_1 \leq x \leq c_1) \\ 0 & \text{otherwise} \end{cases}$$

$$I_a(x) = \begin{cases} \frac{(b_1-x+I_a(x-a_1))}{(b_1-a_1)} & (a_1 \leq x \leq b_1) \\ I_a & (x = b_1) \\ \frac{(x-b_1+I_a(c_1-x))}{(c_1-b_1)} & (b_1 \leq x \leq c_1) \\ 1 & \text{otherwise} \end{cases}$$

$$F_a(x) = \begin{cases} \frac{(b_1-x+F_a(x-a_1))}{(b_1-a_1)} & (a_1 \leq x \leq b_1) \\ F_a & (x = b_1) \\ \frac{(x-c_1+F_a(c_1-x))}{(c_1-b_1)} & (b_1 \leq x \leq c_1) \\ 1 & \text{otherwise} \end{cases}$$

where $0 \leq T_a \leq 1$; $0 \leq I_a \leq 1$; $0 \leq F_a \leq 1$ and $0 \leq T_a + I_a + F_a \leq 3$; $a_1, b_1, c_1 \in R$

Numerical Example:

Let $\tilde{a} = \langle (2, 4, 6); 0.3, 0.4, 0.5 \rangle$ be a single valued triangular neutrosophic number, then the truth membership, indeterminacy membership and falsity membership are expressed as follows

$$T_a(x) = \begin{cases} \frac{0.3(x-2)}{2}, 2 \leq x < 4 \\ 0.3, x = 4 \\ 0.3(5-x), 4 < x \leq 5 \\ 0, \text{otherwise} \end{cases}$$

$$I_a(x) = \begin{cases} \frac{4-x+0.3(x-2)}{2}, 2 \leq x < 4 \\ 0.4, x = 4 \\ x-4+0.4(5-x), 4 < x \leq 5 \\ 1, \text{otherwise} \end{cases}$$

$$F_a(x) = \begin{cases} \frac{4-x+0.5(x-2)}{2}, & 2 \leq x < 4 \\ 0.5, & x = 4 \\ x-4+0.4(5-x), & 4 < x \leq 5 \\ 1, & \text{otherwise} \end{cases}$$

6.1.1 Operations on singled valued triangular neutrosophic numbers

Let $\tilde{A}_1 = \langle (a_1, a_2, a_3); T_1, I_1, F_1 \rangle$ and $\tilde{A}_2 = \langle (b_1, b_2, b_3); T_2, I_2, F_2 \rangle$ be two single valued triangular neutrosophic numbers. Then, the operations for SVTrN-numbers are defined as below;

(i) $\tilde{A}_1 \oplus \tilde{A}_2 = \langle (a_1 + b_1, a_2 + b_2, a_3 + b_3); \min(T_1, T_2), \max(I_1, I_2), \max(F_1, F_2) \rangle$

(ii) $\tilde{A}_1 \otimes \tilde{A}_2 = \langle (a_1 b_1, a_2 b_2, a_3 b_3); \min(T_1, T_2), \max(I_1, I_2), \max(F_1, F_2) \rangle$

(iii) $\lambda \tilde{A}_1 = \langle (\lambda a_1, \lambda a_2, \lambda a_3); \min(T_1, T_2), \max(I_1, I_2), \max(F_1, F_2) \rangle$

6.1.2 Score function and accuracy function of single valued triangular neutrosophic numbers

The convenient method for comparing of two single valued triangular neutrosophic numbers is described as follows:

Let $\tilde{A}_1 = \langle (a_1, a_2, a_3); T_1, I_1, F_1 \rangle$ be a single valued triangular neutrosophic number. Then, the score function $s(\tilde{A}_1)$ and accuracy function $a(\tilde{A}_1)$ of a SVTrN-numbers are defined as follows:

(i) $s(\tilde{A}_1) = \left(\frac{1}{12}\right) [a_1 + 2a_2 + a_3] \times [2 + T_1 - I_1 - F_1]$

(ii) $a(\tilde{A}_1) = \left(\frac{1}{12}\right) [a_1 + 2a_2 + a_3] \times [2 + T_1 - I_1 + F_1]$

6.1.3 Ranking of single valued triangular neutrosophic numbers

Let \tilde{A}_1 and \tilde{A}_2 be two SVTrN-numbers. The ranking of \tilde{A}_1 and \tilde{A}_2 by score function and accuracy function is defined as follows:

(i) If $s(\tilde{A}_1) < s(\tilde{A}_2)$, then $\tilde{A}_1 < \tilde{A}_2$

(ii) If $s(\tilde{A}_1) = s(\tilde{A}_2)$ and if

(1) $a(\tilde{A}_1) < a(\tilde{A}_2)$, then $\tilde{A}_1 < \tilde{A}_2$

(2) $a(\tilde{A}_1) > a(\tilde{A}_2)$, then $\tilde{A}_1 > \tilde{A}_2$

(3) $a(\tilde{A}_1) = a(\tilde{A}_2)$, then $\tilde{A}_1 = \tilde{A}_2$.

6.2 Single valued-trapezoidal neutrosophic numbers (Deli & Subas, 2017)

A single valued trapezoidal neutrosophic number (SVTN-number) $\tilde{a} = \langle (a_1, b_1, c_1, d_1); T_a, I_a, F_a \rangle$ is a special neutrosophic set on the real number set R , whose truth membership, indeterminacy-membership, and a falsity-membership are given as follows

$$T_a(x) = \begin{cases} \frac{(x-a_1)T_a}{(b_1-a_1)} & (a_1 \leq x \leq b_1) \\ T_a & (b_1 \leq x \leq c_1) \\ \frac{(d_1-x)T_a}{(d_1-c_1)} & (c_1 \leq x \leq d_1) \\ 0 & \text{otherwise} \end{cases}$$

$$I_a(x) = \begin{cases} \frac{(b_1-x+I_a(x-a_1))}{(b_1-a_1)} & (a_1 \leq x \leq b_1) \\ I_a & (b_1 \leq x \leq c_1) \\ \frac{(x-c_1+I_a(d_1-x))}{(d_1-c_1)} & (c_1 \leq x \leq d_1) \\ 1 & \text{otherwise} \end{cases}$$

$$F_a(x) = \begin{cases} \frac{(b_1-x+F_a(x-a_1))}{(b_1-a_1)} & (a_1 \leq x \leq b_1) \\ F_a & (b_1 \leq x \leq c_1) \\ \frac{(x-c_1+F_a(d_1-x))}{(d_1-c_1)} & (c_1 \leq x \leq d_1) \\ 1 & \text{otherwise} \end{cases}$$

where $0 \leq T_a \leq 1$; $0 \leq I_a \leq 1$; $0 \leq F_a \leq 1$ and $0 \leq T_a + I_a + F_a \leq 3$; $a_1, b_1, c_1, d_1 \in R$.

Numerical example:

Let $\tilde{a} = \langle (1, 2, 5, 6); 0.8, 0.6, 0.4 \rangle$ be a single valued trapezoidal neutrosophic number. Then the truth membership, indeterminacy membership and falsity membership are expressed as follows:

$$T_a(x) = \begin{cases} 0.8(x-1), 1 \leq x < 2 \\ 0.8, 2 \leq x \leq 5 \\ 0.8(6-x), 5 < x \leq 6 \\ 0, \text{otherwise} \end{cases} \quad I_a(x) = \begin{cases} 1.4-0.4x, 1 \leq x < 2 \\ 0.6, 2 \leq x \leq 5 \\ 0.8x-1.4, 5 < x \leq 6 \\ 1, \text{otherwise} \end{cases}$$

$$F_a(x) = \begin{cases} 1.6-0.6x, 1 \leq x < 2 \\ 0.4, 2 \leq x \leq 5 \\ 0.6x-2.6, 5 < x \leq 6 \\ 1, \text{otherwise} \end{cases}$$

6.2.1 Operation on single valued trapezoidal neutrosophic numbers.

Let $\tilde{A}_1 = \langle (a_1, a_2, a_3, a_4); T_1, I_1, F_1 \rangle$ and $\tilde{A}_2 = \langle (b_1, b_2, b_3, b_4); T_2, I_2, F_2 \rangle$ be two single valued trapezoidal neutrosophic numbers. Then, the operations for SVTN-numbers are defined as below;

$$(i) \tilde{A}_1 \oplus \tilde{A}_2 = \langle (a_1 + b_1, a_2 + b_2, a_3 + b_3, a_4 + b_4); \min(T_1, T_2), \max(I_1, I_2), \max(F_1, F_2) \rangle$$

$$(ii) \tilde{A}_1 \otimes \tilde{A}_2 = \langle (a_1 b_1, a_2 b_2, a_3 b_3, a_4 b_4); \min(T_1, T_2), \max(I_1, I_2), \max(F_1, F_2) \rangle$$

$$(iii) \lambda \tilde{A}_1 = \langle (\lambda a_1, \lambda a_2, \lambda a_3, \lambda a_4); \min(T_1, T_2), \max(I_1, I_2), \max(F_1, F_2) \rangle$$

6.2.2 Score function and accuracy function of single valued trapezoidal neutrosophic numbers

The convenient method for comparing of two single valued **trapezoidal** neutrosophic numbers is described as follows:

Let $\tilde{A}_1 = \langle (a_1, a_2, a_3, a_4); T_1, I_1, F_1 \rangle$ be a single valued trapezoidal neutrosophic number. Then, the score function $s(\tilde{A}_1)$ and accuracy function $a(\tilde{A}_1)$ of a SVTN-numbers are defined as follows:

$$(i) s(\tilde{A}_1) = \left(\frac{1}{12}\right) [a_1 + a_2 + a_3 + a_4] \times [2 + T_1 - I_1 - F_1]$$

$$(ii) a(\tilde{A}_1) = \left(\frac{1}{12}\right) [a_1 + a_2 + a_3 + a_4] \times [2 + T_1 - I_1 + F_1]$$

6.2.3 Ranking of single valued trapezoidal neutrosophic numbers

Let \tilde{A}_1 and \tilde{A}_2 be two SVTN-numbers. The ranking of \tilde{A}_1 and \tilde{A}_2 by score function is defined as follows:

$$(i) \text{ If } s(\tilde{A}_1) < s(\tilde{A}_2) \text{ then } \tilde{A}_1 < \tilde{A}_2$$

$$(ii) \text{ If } s(\tilde{A}_1) = s(\tilde{A}_2) \text{ and if}$$

$$(1) a(\tilde{A}_1) < a(\tilde{A}_2) \text{ then } \tilde{A}_1 < \tilde{A}_2$$

$$(2) a(\tilde{A}_1) > a(\tilde{A}_2) \text{ then } \tilde{A}_1 > \tilde{A}_2$$

$$(3) a(\tilde{A}_1) = a(\tilde{A}_2) \text{ then } \tilde{A}_1 = \tilde{A}_2$$

Later on, Liang et al. (2017) redefined the score function, accuracy function and certainty function as follows:

Let $\tilde{a} = \langle [a_1, a_2, a_3, a_4], (T_{\tilde{a}}, I_{\tilde{a}}, F_{\tilde{a}}) \rangle$ be a SVTNN. Then, the score function, accuracy function, and certainty function of SVTNN \tilde{a} are defined, respectively, as:

$$E(\tilde{a}) = \text{COG}(K) \times \frac{(2+T_{\tilde{a}} - I_{\tilde{a}} - F_{\tilde{a}})}{3}$$

$$A(\tilde{a}) = \text{COG}(K) \times (T_{\tilde{a}} - F_{\tilde{a}})$$

$$C(\tilde{a}) = \text{COG}(K) \times T_{\tilde{a}}$$

where (COG) denotes the center of gravity of K and can be defined as follows:

$$\text{COG(K)} = \begin{cases} a & \text{if } a_1 = a_2 = a_3 = a_4 \\ \frac{1}{3} \left[a_1 + a_2 + a_3 + a_4 - \frac{a_4 a_3 - a_2 a_1}{a_4 + a_3 - a_2 - a_1} \right] & \text{otherwise} \end{cases}$$

6.3 Interval valued neutrosophic number

6.3.1 Operations on interval valued neutrosophic number

Let $\tilde{A}_1 = \langle [T_1^L, T_1^U], [I_1^L, I_1^U], [F_1^L, F_1^U] \rangle$ and $\tilde{A}_2 = \langle [T_2^L, T_2^U], [I_2^L, I_2^U], [F_2^L, F_2^U] \rangle$ be two interval valued neutrosophic numbers. Then, the operations for IVNNs are defined as below;

$$(i) \tilde{A}_1 \oplus \tilde{A}_2 = \langle [T_1^L + T_2^L - T_1^L T_2^L, T_1^U + T_2^U - T_1^U T_2^U], [I_1^L I_2^L, I_1^U I_2^U], [F_1^L F_2^L, F_1^U F_2^U] \rangle$$

$$(ii) \tilde{A}_1 \otimes \tilde{A}_2 = \langle [T_1^L T_2^L, T_1^U T_2^U], [I_1^L + I_2^L - I_1^L I_2^L, I_1^U + I_2^U - I_1^U I_2^U], [F_1^L + F_2^L - F_1^L F_2^L, F_1^U + F_2^U - F_1^U F_2^U] \rangle$$

$$(iii) \lambda \tilde{A} = \langle [1 - (1 - T_1^L)^\lambda, 1 - (1 - T_1^U)^\lambda], [(I_1^L)^\lambda, (I_1^U)^\lambda], [(F_1^L)^\lambda, (F_1^U)^\lambda] \rangle$$

$$(iv) \tilde{A}_1^\lambda = \langle [(T_1^L)^\lambda, (T_1^U)^\lambda], [1 - (1 - I_1^L)^\lambda, 1 - (1 - I_1^U)^\lambda], [1 - (1 - F_1^L)^\lambda, 1 - (1 - F_1^U)^\lambda] \rangle \text{ where } \lambda > 0$$

An interval valued neutrosophic number $\tilde{A}_1 = \langle [T_1^L, T_1^U], [I_1^L, I_1^U], [F_1^L, F_1^U] \rangle$ is said to be empty if and only if

$$T_1^L = 0, T_1^U = 0, I_1^L = 1, I_1^U = 1, \text{ and } F_1^L = F_1^U \text{ and is denoted by}$$

$$0_n = \{ \langle x, \langle [0, 0], [1, 1], [1, 1] \rangle : x \in X \}$$

6.3.2 Score function and accuracy functions of interval valued neutrosophic number

The convenient method for comparing of interval valued neutrosophic numbers is described as follows:

Let $\tilde{A}_1 = \langle [T_1^L, T_1^U], [I_1^L, I_1^U], [F_1^L, F_1^U] \rangle$ be a single valued neutrosophic number. Then, the score function $s(\tilde{A}_1)$ and accuracy function $H(\tilde{A}_1)$ of an IVNN are defined as follows:

$$(i) s(\tilde{A}_1) = \left(\frac{1}{4} \right) \times [2 + T_1^L + T_1^U - 2I_1^L - 2I_1^U - F_1^L - F_1^U]$$

$$(ii) H(\tilde{A}_1) = \frac{T_1^L + T_1^U - I_1^U(1 - T_1^U) - I_1^L(1 - T_1^L) - F_1^U(1 - I_1^U) - F_1^L(1 - I_1^L)}{2}$$

6.3.3 Ranking of interval valued neutrosophic numbers

Let $\tilde{A}_1 = \langle [T_1^L, T_1^U], [I_1^L, I_1^U], [F_1^L, F_1^U] \rangle$ and $\tilde{A}_2 = \langle [T_2^L, T_2^U], [I_2^L, I_2^U], [F_2^L, F_2^U] \rangle$ are two interval valued neutrosophic numbers. Then, the ranking method for comparing two IVNS is defined as follows:

- v. If $s(\tilde{A}_1) > s(\tilde{A}_2)$, then \tilde{A}_1 is greater than \tilde{A}_2 , that is, \tilde{A}_1 is superior to \tilde{A}_2 , denoted by $\tilde{A}_1 > \tilde{A}_2$

- vi. If $s(\tilde{A}_1) = s(\tilde{A}_2)$, and $H(\tilde{A}_1) > H(\tilde{A}_2)$ then \tilde{A}_1 is greater than \tilde{A}_2 , that is, \tilde{A}_1 is superior to \tilde{A}_2 , denoted by $\tilde{A}_1 > \tilde{A}_2$.

6.4 Bipolar neutrosophic Number

6.4.1 Operation on bipolar neutrosophic numbers

Let $\tilde{A}_1 = \langle T_1^p, I_1^p, F_1^p, T_1^n, I_1^n, F_1^n \rangle$ and $\tilde{A}_2 = \langle T_2^p, I_2^p, F_2^p, T_2^n, I_2^n, F_2^n \rangle$ be two bipolar neutrosophic numbers and $\lambda > 0$. Then, the operations of these numbers defined as below;

$$(i) \tilde{A}_1 \oplus \tilde{A}_2 = \langle T_1^p + T_2^p - T_1^p T_2^p, I_1^p I_2^p, F_1^p F_2^p, -T_1^n T_2^n, -(I_1^p - I_2^p - I_1^p I_2^p), -(F_1^p - F_2^p - F_1^p F_2^p) \rangle$$

$$(ii) \tilde{A}_1 \otimes \tilde{A}_2 = \langle T_1^p T_2^p, I_1^p + I_2^p - I_1^p I_2^p, F_1^p + F_2^p - F_1^p F_2^p, -T_1^n - T_2^n - T_1^n T_2^n, -I_1^n I_2^n, -F_1^n F_2^n \rangle$$

$$(iii) \lambda \tilde{A}_1 = \langle 1 - (1 - T_1^p)^\lambda, (I_1^p)^\lambda, (F_1^p)^\lambda, -(T_1^n)^\lambda, -(I_1^n)^\lambda, -(1 - (1 - F_1^n)^\lambda) \rangle$$

$$(iv) \tilde{A}_1^\lambda = \langle (T_1^p)^\lambda, 1 - (1 - I_1^p)^\lambda, 1 - (1 - F_1^p)^\lambda, -(1 - (1 - (T_1^n)^\lambda)), -(I_1^n)^\lambda, -(F_1^n)^\lambda \rangle \text{ where } \lambda > 0.$$

6.4.2 Score function, accuracy function and certainty function of bipolar neutrosophic number

In order to make comparison between two BNNs. Deli et al. (2015) introduced a concept of score function. The score function is applied to compare the grades of BNS. This function shows that greater is the value, the greater is the bipolar neutrosophic sets and by using this concept paths can be ranked. Let $\tilde{A} = \langle T^p, I^p, F^p, T^n, I^n, F^n \rangle$ be a bipolar neutrosophic number. Then, the score function $s(\tilde{A})$, accuracy function $a(\tilde{A})$ and certainty function $c(\tilde{A})$ of an BNN are defined as follows:

$$(i) s(\tilde{A}) = \left(\frac{1}{6}\right) \times [T^p + 1 - I^p + 1 - F^p + 1 + T^n - I^n - F^n]$$

$$(ii) a(\tilde{A}) = T^p - F^p + T^n - F^n$$

$$(iii) c(\tilde{A}) = T^p - F^n$$

6.4.3 Comparison of bipolar neutrosophic numbers

Let $\tilde{A}_1 = \langle T_1^p, I_1^p, F_1^p, T_1^n, I_1^n, F_1^n \rangle$ and $\tilde{A}_2 = \langle T_2^p, I_2^p, F_2^p, T_2^n, I_2^n, F_2^n \rangle$ be two bipolar neutrosophic numbers. then

- vii. If $s(\tilde{A}_1) > s(\tilde{A}_2)$, then \tilde{A}_1 is greater than \tilde{A}_2 , that is, \tilde{A}_1 is superior to \tilde{A}_2 , denoted by $\tilde{A}_1 > \tilde{A}_2$
- viii. If $s(\tilde{A}_1) = s(\tilde{A}_2)$, and $a(\tilde{A}_1) > a(\tilde{A}_2)$ then \tilde{A}_1 is greater than \tilde{A}_2 , that is, \tilde{A}_1 is superior to \tilde{A}_2 , denoted by $\tilde{A}_1 > \tilde{A}_2$

- ix. If $s(\tilde{A}_1) = s(\tilde{A}_2)$, $a(\tilde{A}_1) = a(\tilde{A}_2)$, and $c(\tilde{A}_1) > c(\tilde{A}_2)$ then \tilde{A}_1 is greater than \tilde{A}_2 , that is, \tilde{A}_1 is superior to \tilde{A}_2 , denoted by $\tilde{A}_1 > \tilde{A}_2$
- x. If $s(\tilde{A}_1) = s(\tilde{A}_2)$, $a(\tilde{A}_1) = a(\tilde{A}_2)$, and $c(\tilde{A}_1) = c(\tilde{A}_2)$ then \tilde{A}_1 is equal to \tilde{A}_2 , that is, \tilde{A}_1 is indifferent to \tilde{A}_2 , denoted by $\tilde{A}_1 = \tilde{A}_2$.

7. TRAPEZOIDAL NEUTROSOPHIC SETS (Ye, 2015b; Biswas et al., 2014)

Assume that X be the finite universe of discourse and $F [0, 1]$ be the set of all trapezoidal fuzzy numbers on $[0, 1]$. A trapezoidal fuzzy neutrosophic set (TrFNS) \tilde{A} in X is represented as:

$$\tilde{A} = \{x: \tilde{T}_A(x), \tilde{I}_A(x), \tilde{F}_A(x)\}, x \in X\}, \text{ where } \tilde{T}_A(x): X \rightarrow F[0,1], \tilde{I}_A(x): X \rightarrow F[0,1] \text{ and } \tilde{F}_A(x): X \rightarrow F[0,1].$$

The trapezoidal fuzzy numbers $\tilde{T}_A(x) = (T_A^1(x), T_A^2(x), T_A^3(x), T_A^4(x))$, $\tilde{I}_A(x) = (I_A^1(x), I_A^2(x), I_A^3(x), I_A^4(x))$ and $\tilde{F}_A(x) = (F_A^1(x), F_A^2(x), F_A^3(x), F_A^4(x))$, respectively, denote the truth-membership, indeterminacy-membership and a falsity-membership degree of x in \tilde{A} and for every $x \in X$, $0 \leq T_A^4(x) + I_A^4(x) + F_A^4(x) \leq 3$.

For notational convenience, the trapezoidal fuzzy neutrosophic value (TrFNv) \tilde{A} is denoted by $\tilde{A} = \langle (a_1, a_2, a_3, a_4), (b_1, b_2, b_3, b_4), (c_1, c_2, c_3, c_4) \rangle$ where,

$$(T_A^1(x), T_A^2(x), T_A^3(x), T_A^4(x)) = (a_1, a_2, a_3, a_4),$$

$$(I_A^1(x), I_A^2(x), I_A^3(x), I_A^4(x)) = (b_1, b_2, b_3, b_4), \text{ and}$$

$$(F_A^1(x), F_A^2(x), F_A^3(x), F_A^4(x)) = (c_1, c_2, c_3, c_4)$$

The parameters satisfy the following relations $a_1 \leq a_2 \leq a_3 \leq a_4$, $b_1 \leq b_2 \leq b_3 \leq b_4$ and $c_1 \leq c_2 \leq c_3 \leq c_4$.

The truth membership function is defined as follows

$$\tilde{T}_A(x) = \begin{cases} \frac{x-a_1}{a_2-a_1}, & a_1 \leq x \leq a_2 \\ 1, & a_2 \leq x \leq a_3 \\ \frac{x-a_1}{a_2-a_1}, & a_3 \leq x \leq a_4 \\ 0, & \text{otherwise} \end{cases}$$

The indeterminacy membership function is defined as follows:

$$\tilde{I}_A(x) = \begin{cases} \frac{x-b_1}{b_2-b_1}, & b_1 \leq x \leq b_2 \\ 1, & b_2 \leq x \leq b_3 \\ \frac{b_4-x}{b_4-b_3}, & b_3 \leq x \leq b_4 \\ 0, & \text{otherwise} \end{cases}$$

and the falsity membership function is defined as follows:

$$\tilde{F}_A(x) = \begin{cases} \frac{x-c_1}{c_2-c_1}, & c_1 \leq x \leq c_2 \\ 1, & c_2 \leq x \leq c_3 \\ \frac{c_4-x}{c_4-c_3}, & c_3 \leq x \leq c_4 \\ 0, & \text{otherwise} \end{cases}$$

A trapezoidal neutrosophic number $\tilde{A} = \langle (a_1, a_2, a_3, a_4), (b_1, b_2, b_3, b_4), (c_1, c_2, c_3, c_4) \rangle$ is said to be zero triangular fuzzy neutrosophic number if and only if

$$(a_1, a_2, a_3, a_4) = (0, 0, 0, 0), (b_1, b_2, b_3, b_4) = (1, 1, 1, 1) \text{ and } (c_1, c_2, c_3, c_4) = (1, 1, 1, 1).$$

Remark: The trapezoidal fuzzy neutrosophic number is a particular case of trapezoidal neutrosophic number when all the three vector are equal: $(a_1, a_2, a_3, a_4) = (b_1, b_2, b_3, b_4) = (c_1, c_2, c_3, c_4)$.

7.1 Operation on trapezoidal fuzzy neutrosophic value

Let $\tilde{A}_1 = \langle (a_1, a_2, a_3, a_4), (b_1, b_2, b_3, b_4), (c_1, c_2, c_3, c_4) \rangle$ and $\tilde{A}_2 = \langle (e_1, e_2, e_3, e_4), (f_1, f_2, f_3, f_4), (g_1, g_2, g_3, g_4) \rangle$ be two TrFNVs in the set of real numbers, and $\lambda > 0$. Then, the operational rules are defined as follows;

$$(i) \tilde{A}_1 \oplus \tilde{A}_2 = \left\langle \begin{pmatrix} a_1 + e_1 - a_1 e_1, a_2 + e_2 - a_2 e_2, \\ a_3 + e_3 - a_3 e_3, a_4 + e_4 - a_4 e_4 \end{pmatrix}, \right. \\ \left. (b_1 f_1, b_2 f_2, b_3 f_3, b_4 f_4), \right. \\ \left. (c_1 g_1, c_2 g_2, c_3 g_3, c_4 g_4) \right\rangle$$

$$(ii) \tilde{A}_1 \otimes \tilde{A}_2 = \left\langle \begin{pmatrix} a_1 e_1, a_2 e_2, a_3 e_3, a_4 e_4, \\ b_1 + f_1 - b_1 f_1, b_2 + f_2 - b_2 f_2, \\ b_3 + f_3 - b_3 f_3, b_4 + f_4 - b_4 f_4 \end{pmatrix}, \right. \\ \left. \begin{pmatrix} c_1 + g_1 - c_1 g_1, c_2 + g_2 - c_2 g_2, \\ c_3 + g_3 - c_3 g_3, c_4 + g_4 - c_4 g_4 \end{pmatrix} \right\rangle$$

$$(iii) \lambda \tilde{A} = \left\langle \left(\begin{array}{l} (1-(1-a_1)^\lambda, 1-(1-a_2)^\lambda) \\ (1-(1-a_3)^\lambda, 1-(1-a_4)^\lambda) \\ (b_1^\lambda, b_2^\lambda, b_3^\lambda, b_4^\lambda), (c_1^\lambda, c_2^\lambda, c_3^\lambda, c_4^\lambda) \end{array} \right) \right\rangle$$

$$(iv) \tilde{A}_1^\lambda = \left\langle \left(\begin{array}{l} (a_1^\lambda, a_2^\lambda, a_3^\lambda, a_4^\lambda), \\ ((1-(1-b_1)^\lambda, 1-(1-b_2)^\lambda), 1-(1-b_3)^\lambda), 1-(1-b_4)^\lambda) \\ ((1-(1-c_1)^\lambda, 1-(1-c_2)^\lambda), 1-(1-c_3)^\lambda), 1-(1-c_4)^\lambda) \end{array} \right) \right\rangle \text{ where } \lambda > 0.$$

Ye (2015b) presented the following definitions of score function and accuracy function. The score function S and the accuracy function H are applied to compare the grades of TrFNSs. These functions show that greater is the value, the greater is the TrFNS.

7.2 Score function and accuracy function of trapezoidal fuzzy neutrosophic value

Let $\tilde{A}_1 = \langle (a_1, a_2, a_3, a_4), (b_1, b_2, b_3, b_4), (c_1, c_2, c_3, c_4) \rangle$ be a TrFNV. Then, the score function $s(\tilde{A}_1)$ and an accuracy function $H(\tilde{A}_1)$ of TrFNV are defined as follows:

$$(i) s(\tilde{A}_1) = \frac{1}{12} [8 + (a_1 + a_2 + a_3 + a_4) - (b_1 + b_2 + b_3 + b_4) - (c_1 + c_2 + c_3 + c_4)]$$

$$(ii) H(\tilde{A}_1) = \frac{1}{4} [(a_1 + a_2 + a_3 + a_4) - (c_1 + c_2 + c_3 + c_4)].$$

In order to make a comparison between two TrFNV, Ye (2015b) presented the order relations between two TrFNVs.

7.3 Ranking of trapezoidal fuzzy neutrosophic value

Let $\tilde{A}_1 = \langle (a_1, a_2, a_3, a_4), (b_1, b_2, b_3, b_4), (c_1, c_2, c_3, c_4) \rangle$ and $\tilde{A}_2 = \langle (e_1, e_2, e_3, e_4), (f_1, f_2, f_3, f_4), (g_1, g_2, g_3, g_4) \rangle$ be two TrFNVs in the set of real numbers. Then, we define a ranking method as follows:

- xi. If $s(\tilde{A}_1) > s(\tilde{A}_2)$, then \tilde{A}_1 is greater than \tilde{A}_2 , that is, \tilde{A}_1 is superior to \tilde{A}_2 , denoted by $\tilde{A}_1 > \tilde{A}_2$
- xii. If $s(\tilde{A}_1) = s(\tilde{A}_2)$, and $H(\tilde{A}_1) > H(\tilde{A}_2)$ then \tilde{A}_1 is greater than \tilde{A}_2 , that is, \tilde{A}_1 is superior to \tilde{A}_2 , denoted by $\tilde{A}_1 > \tilde{A}_2$.

8. TRIANGULAR FUZZY NEUTROSOPHIC SETS (Biswas et al., 2014)

Assume that X be the finite universe of discourse and F [0, 1] be the set of all triangular fuzzy numbers on [0, 1]. A triangular fuzzy neutrosophic set (TFNS) \tilde{A} in X is represented

$$\tilde{A} = \{ \langle x: \tilde{T}_A(x), \tilde{I}_A(x), \tilde{F}_A(x) \rangle, x \in X \},$$

where $\tilde{T}_A(x): X \rightarrow F[0,1]$, $\tilde{I}_A(x): X \rightarrow F[0,1]$ and $\tilde{F}_A(x): X \rightarrow F[0,1]$. The triangular fuzzy numbers

$$\tilde{T}_A(x) = (T_A^1(x), T_A^2(x), T_A^3(x)), \quad \tilde{I}_A(x) = (I_A^1(x), I_A^2(x), I_A^3(x)) \text{ and}$$

$\tilde{F}_A(x) = (F_A^1(x), F_A^2(x), F_A^3(x))$, respectively, denote the truth-membership, indeterminacy-membership and a falsity-membership degree of x in \tilde{A} and for every $x \in X$

$$0 \leq T_A^3(x) + I_A^3(x) + F_A^3(x) \leq 3.$$

For notational convenience, the triangular fuzzy neutrosophic value (TFNV) \tilde{A} is denoted by $\tilde{A} = \langle (a, b, c), (e, f, g), (r, s, t) \rangle$ where, $(T_A^1(x), T_A^2(x), T_A^3(x)) = (a, b, c)$,

$$(I_A^1(x), I_A^2(x), I_A^3(x)) = (e, f, g), \text{ and } (F_A^1(x), F_A^2(x), F_A^3(x)) = (r, s, t).$$

8.1 Zero triangular fuzzy neutrosophic number

A triangular fuzzy neutrosophic number $\tilde{A} = \langle (a, b, c), (e, f, g), (r, s, t) \rangle$ is said to be zero triangular fuzzy neutrosophic number if and only if

$$(a, b, c) = (0, 0, 0), (e, f, g) = (1, 1, 1) \text{ and } (r, s, t) = (1, 1, 1)$$

8.2 Operation on triangular fuzzy neutrosophic value

Let $\tilde{A}_1 = \langle (a_1, b_1, c_1), (e_1, f_1, g_1), (r_1, s_1, t_1) \rangle$ and $\tilde{A}_2 = \langle (a_2, b_2, c_2), (e_2, f_2, g_2), (r_2, s_2, t_2) \rangle$ be two TFNVs in the set of real numbers, and $\lambda > 0$. Then, the operational rules are defined as follows;

$$(i) \tilde{A}_1 \oplus \tilde{A}_2 = \left\langle (a_1 + a_2 - a_1 a_2, b_1 + b_2 - b_1 b_2, c_1 + c_2 - c_1 c_2), (e_1 e_2, f_1 f_2, g_1 g_2), (r_1 r_2, s_1 s_2, t_1 t_2) \right\rangle$$

$$(ii) \tilde{A}_1 \otimes \tilde{A}_2 = \left\langle (a_1 a_2, b_1 b_2, c_1 c_2), (e_1 + e_2 - e_1 e_2, f_1 + f_2 - f_1 f_2, g_1 + g_2 - g_1 g_2), (r_1 + r_2 - r_1 r_2, s_1 + s_2 - s_1 s_2, t_1 + t_2 - t_1 t_2) \right\rangle$$

$$(iii) \lambda \tilde{A} = \left\langle ((1 - (1 - a_1)^\lambda, 1 - (1 - b_1)^\lambda, 1 - (1 - c_1)^\lambda), (e_1^\lambda, f_1^\lambda, g_1^\lambda), (r_1^\lambda, s_1^\lambda, t_1^\lambda)) \right\rangle$$

$$(iv) \tilde{A}_1^\lambda = \left\langle (a_1^\lambda, b_1^\lambda, c_1^\lambda), ((1 - (1 - e_1)^\lambda, 1 - (1 - f_1)^\lambda, 1 - (1 - g_1)^\lambda), ((1 - (1 - r_1)^\lambda, 1 - (1 - s_1)^\lambda, 1 - (1 - t_1)^\lambda)) \right\rangle \text{ where } \lambda > 0.$$

Ye (2015b) introduced the concept of score function and accuracy function TFNS. The score function S and the accuracy function H are applied to compare the grades of TFNS. These functions show that greater is the value, the greater is the TFNS.

8.3 Score function and accuracy function of triangular fuzzy neutrosophic value

Let $\tilde{A}_1 = \langle (a_1, b_1, c_1), (e_1, f_1, g_1), (r_1, s_1, t_1) \rangle$ be a TFNV. Then, the score function $s(\tilde{A}_1)$ and an accuracy function $H(\tilde{A}_1)$ of TFNV are defined as follows:

$$(i) \quad s(\tilde{A}_1) = \frac{1}{12} [8 + (a_1 + 2b_1 + c_1) - (e_1 + 2f_1 + g_1) - (r_1 + 2s_1 + t_1)]$$

$$(ii) \quad H(\tilde{A}_1) = \frac{1}{4} [(a_1 + 2b_1 + c_1) - (r_1 + 2s_1 + t_1)]$$

In order to make a comparison between two TFNVs, Ye (2015b) presented the order relations between two TFNVs.

8.4 Ranking of triangular fuzzy neutrosophic values

Let $\tilde{A}_1 = \langle (a_1, b_1, c_1), (e_1, f_1, g_1), (r_1, s_1, t_1) \rangle$ and $\tilde{A}_2 = \langle (a_2, b_2, c_2), (e_2, f_2, g_2), (r_2, s_2, t_2) \rangle$ be two TFNVs in the set of real numbers. Then, the ranking method is defined as follows:

- i. If $s(\tilde{A}_1) > s(\tilde{A}_2)$, then \tilde{A}_1 is greater than \tilde{A}_2 , that is, \tilde{A}_1 is superior to \tilde{A}_2 , denoted by $\tilde{A}_1 > \tilde{A}_2$
- ii. If $s(\tilde{A}_1) = s(\tilde{A}_2)$, and $H(\tilde{A}_1) > H(\tilde{A}_2)$ then \tilde{A}_1 is greater than \tilde{A}_2 , that is, \tilde{A}_1 is superior to \tilde{A}_2 , denoted by $\tilde{A}_1 > \tilde{A}_2$.

9. DIFFERENCE BETWEEN TRAPEZOIDAL INTUITIONISTIC FUZZY NUMBER AND TRAPEZOIDAL NEUTROSOPHIC FUZZY NUMBER

9.1 Trapezoidal intuitionistic fuzzy number (Nayagam, Jeevaraj, & Sivaraman, 2016)

Definition 1. A trapezoidal intuitionistic fuzzy number $\tilde{a} = \langle (\underline{a}, a_1, a_2, \bar{a}); w_{\tilde{a}}, u_{\tilde{a}} \rangle$ is a convex intuitionistic fuzzy set on the set \mathfrak{R} of real numbers, whose membership and non-membership functions are follows

$$\mu_{\tilde{a}}(x) = \begin{cases} (x - \underline{a})w_{\tilde{a}} / (a_1 - \underline{a}) & (\underline{a} \leq x < a_1) \\ w_{\tilde{a}} & (a_1 \leq x \leq a_2) \\ (\bar{a} - x)w_{\tilde{a}} / (\bar{a} - a_2) & (a_2 < x \leq \bar{a}) \\ 0 & (x < \underline{a}, x > \bar{a}), \end{cases}$$

$$\nu_{\tilde{a}}(x) = \begin{cases} [a_1 - x + u_{\tilde{a}}(x - \underline{a})] / (a_1 - \underline{a}) & (\underline{a} \leq x < a_1) \\ u_{\tilde{a}} & (a_1 \leq x \leq a_2) \\ [x - a_2 + u_{\tilde{a}}(\bar{a} - x)] / (\bar{a} - a_2) & (a_2 < x \leq \bar{a}) \\ 1 & (x < \underline{a}, x > \bar{a}). \end{cases}$$

where $0 \leq w_{\tilde{a}} \leq 1$, $0 \leq u_{\tilde{a}} \leq 1$ and $0 \leq w_{\tilde{a}} + u_{\tilde{a}} \leq 1$, $w_{\tilde{a}}$ and $u_{\tilde{a}}$ respectively represent the maximum membership degree and the minimum membership degree of \tilde{a} , $\pi_{\tilde{a}}(x) = 1 - \mu_{\tilde{a}}(x) - \nu_{\tilde{a}}(x)$ is called as the intuitionistic fuzzy index of an element x in \tilde{a} . a_1 and a_2 respectively represent the minimum and maximum values of the most probable value of the fuzzy number \tilde{a} , \underline{a} represents the minimum value of the \tilde{a} , and \bar{a} represents the maximum value of the \tilde{a} .

9.2 Trapezoidal neutrosophic fuzzy number

Definition 2. Let X be a universe of discourse, then a trapezoidal fuzzy neutrosophic set \tilde{N} in X is defined as the following form:

$$\tilde{N} = \{ \langle x, T_{\tilde{N}}(x), I_{\tilde{N}}(x), F_{\tilde{N}}(x) \rangle | x \in X \},$$

where $T_{\tilde{N}}(x) \subset [0, 1]$, $I_{\tilde{N}}(x) \subset [0, 1]$ and $F_{\tilde{N}}(x) \subset [0, 1]$ are three trapezoidal fuzzy neutrosophic numbers, $T_{\tilde{N}}(x) = (t_{\tilde{N}}^1(x), t_{\tilde{N}}^2(x), t_{\tilde{N}}^3(x), t_{\tilde{N}}^4(x)) : X \rightarrow [0, 1]$, $I_{\tilde{N}}(x) = (i_{\tilde{N}}^1(x), i_{\tilde{N}}^2(x), i_{\tilde{N}}^3(x), i_{\tilde{N}}^4(x)) : X \rightarrow [0, 1]$,

and $F_{\tilde{N}}(x) = (f_{\tilde{N}}^1(x), f_{\tilde{N}}^2(x), f_{\tilde{N}}^3(x), f_{\tilde{N}}^4(x)) : X \rightarrow [0, 1]$ with the condition $0 \leq t_{\tilde{N}}^4(x) + i_{\tilde{N}}^4(x) + f_{\tilde{N}}^4(x) \leq 3, x \in X$.

9.3 Difference and comparison between trapezoidal intuitionistic fuzzy number and trapezoidal neutrosophic fuzzy number

The difference and comparison between the trapezoidal intuitionistic fuzzy number and trapezoidal neutrosophic fuzzy number are represented in the following way:

First, we give the graphical representation of trapezoidal neutrosophic fuzzy number (TrNFN) and trapezoidal intuitionistic fuzzy number (TrIFN), as shown in Figure 1,

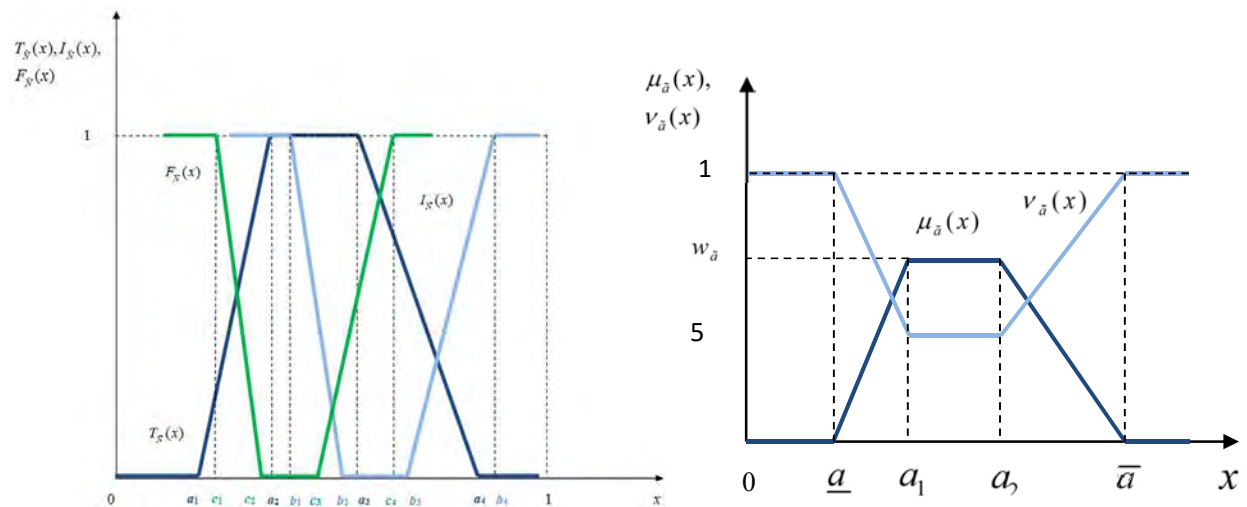

(a) Graphical representation of TrNFN (b) Graphical representation of TrIFN

Fig.1 Graphical representation of trapezoidal neutrosophic fuzzy number and trapezoidal intuitionistic fuzzy number

It can be observed from the Fig. 1, there are some differences between trapezoidal intuitionistic fuzzy number and trapezoidal neutrosophic fuzzy number. On one hand, the membership degree, non-membership degree and hesitancy of trapezoidal intuitionistic fuzzy number are mutually constrained, and the maximum value of the sum of them is not more than 1. However, the truth membership, indeterminacy membership and falsity membership functions of trapezoidal neutrosophic fuzzy number are independent, and their values are between 0 and 3. And the maximum value of their sum is not more than 3. On the other hand, trapezoidal neutrosophic fuzzy number is a generalized representation of trapezoidal fuzzy number and trapezoidal intuitionistic fuzzy number, and trapezoidal intuitionistic fuzzy number is a special case of trapezoidal neutrosophic fuzzy number.

10. DIFFERENCE BETWEEN TRIANGULAR FUZZY NUMBERS, INTUITIONISTIC TRIANGULAR FUZZY NUMBER AND SINGLED VALUED NEUTROSOPHIC SET

Fuzzy sets have been introduced by Zadeh (1965) in order to deal with imprecise numerical quantities in a practical way. A fuzzy number (Kaufmann& Gupta, 1988) is a generalization of a regular, real number in the sense that it does not refer to one single value but rather to a connected set of possible values, where each possible value has its own weight between 0 and 1. This weight is called the membership function. A fuzzy number is thus a special case of a convex, normalized fuzzy set of the real line .

10.1 Triangular fuzzy number (Lee, 2005)

A triangular fuzzy number $A=[a_1, a_2, a_3]$ is expressed by the following membership function

$$\mu_A(x) = \begin{cases} \frac{x-a_1}{a_2-a_1}, & a_1 \leq x \leq a_2 \\ \frac{a_3-x}{a_3-a_2}, & a_2 \leq x \leq a_3 \\ 0, & otherwise \end{cases}$$

10.2 Triangular intuitionistic fuzzy number (Li, Nan, & Zhang, 2012)

A TIFN (See Fig. 2) A is a subset of IFS in R with the following membership functions and non-membership function as follows

$$\mu_A(x) = \begin{cases} \frac{x-a_1}{a_2-a_1}, & a_1 \leq x \leq a_2 \\ \frac{a_3-x}{a_3-a_2}, & a_2 \leq x \leq a_3 \\ 0, & otherwise \end{cases} \quad \gamma_A(x) = \begin{cases} \frac{a_2-x}{a_2-a'_1}, & a'_1 \leq x \leq a_2 \\ \frac{x-a_2}{a'_3-a_2}, & a_2 \leq x \leq a'_3 \\ 1, & otherwise \end{cases}$$

where $a'_1 \leq a_1 \leq a_2 \leq a_3 \leq a'_3$

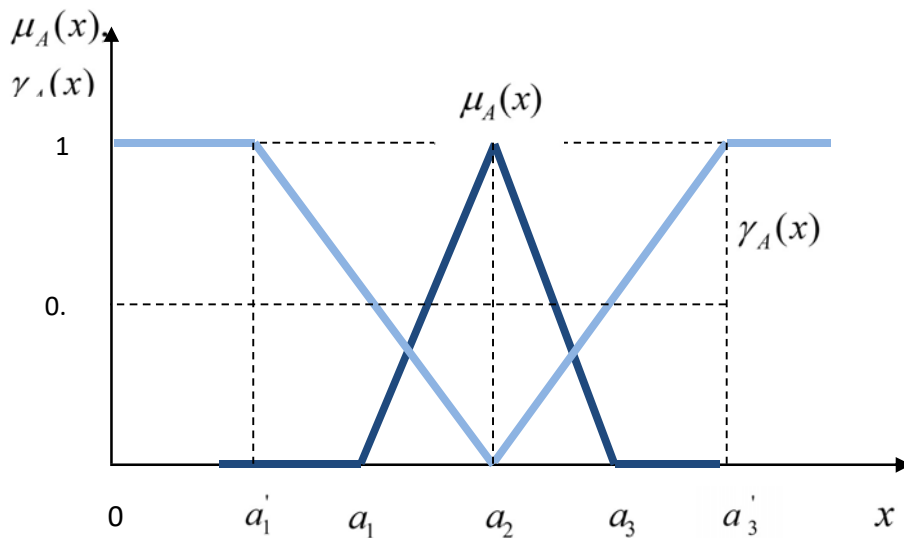

Fig.2. Graphical representation of triangular intuitionistic fuzzy numbers.

It can be observed from the membership functions that in case of triangular intuitionistic fuzzy number, membership and non-membership degrees are triangular fuzzy numbers. Further it can be noted that the neutrosophic components are best suited in the presentation of indeterminacy and inconsistent information whereas intuitionistic fuzzy sets cannot handle indeterminacy and inconsistent information.

The difference between the fuzzy numbers and single valued neutrosophic set can be understood clearly with the help of an example. Suppose it is raining continuously for few days in a locality. Then one can guess whether there would be a flood like situation in that area. Observing the rainfall of this year and recalling the incidents of previous years one can only give his judgment on the basis of guess in terms of yes or no but still there remains an indeterminate situation and that indeterminate situation is expressed nicely by the single valued neutrosophic set.

Triangular fuzzy numbers (TFNs) and single valued neutrosophic numbers (SVNNs) are both generalizations of fuzzy numbers that are each characterized by three components. TFNs and SVNNs have been widely used to represent uncertain and vague information in various areas such as engineering, medicine, communication science and decision science. However, SVNNs are far more accurate and convenient to be used to represent the uncertainty and hesitancy that exists in information, as compared to TFNs. SVNNs are characterized by three components, each of which clearly represents the degree of truth membership, indeterminacy membership and falsity membership of a the SVNNs with respect to a an attribute. Therefore, we are able to tell the belongingness of a SVNN to the set of attributes that are being studied, by just looking at the structure of the SVNN. This provides a clear, concise and comprehensive method of representation of the different components of the membership of the number. This is in contrast to the structure of the TFN which only provides us with the maximum, minimum and initial values of the TFN, all of which can only tell us the path of the TFN, but does not tell us anything about the degree of non-belongingness of the TFN with respect to the set of attributes that are being studied. Furthermore, the

structure of the TFN is not able to capture the hesitancy that naturally exists within the user in the process of assigning membership values. These reasons clearly show the advantages of SVNNS compared to TFNs.

11. REFINED NEUTROSOPHIC SETS (Smarandache, 2013; Deli et al., 2015b)

Refined neutrosophic sets can be expressed as follows:

Let E be a universe. A neutrosophic refined set (NRS) A on E can be defined as follows

$$A = \left\{ \left\langle x, (T_A^1(x), T_A^2(x), \dots, T_A^p(x)), (I_A^1(x), I_A^2(x), \dots, I_A^p(x)), (F_A^1(x), F_A^2(x), \dots, F_A^p(x)) \right\rangle \right\}$$

Where $T_A^1(x), T_A^2(x), \dots, T_A^p(x) : E \rightarrow [0, 1]$, $I_A^1(x), I_A^2(x), \dots, I_A^p(x) : E \rightarrow [0, 1]$ and $F_A^1(x), F_A^2(x), \dots, F_A^p(x) : E \rightarrow [0, 1]$

12. BIPOLAR NEUTROSOPHIC REFINED SETS

Bipolar neutrosophic refined sets (Deli et al., 2015a) can be described as follows:

Let E be a universe. A bipolar neutrosophic refined set (BNRS) A on E can be defined as follows:

$$A = \left\{ \left\langle x, (T_A^{1+}(x), T_A^{2+}(x), \dots, T_A^{p+}(x), T_A^{1-}(x), T_A^{2-}(x), \dots, T_A^{p-}(x)), (I_A^{1+}(x), I_A^{2+}(x), \dots, I_A^{p+}(x), I_A^{1-}(x), I_A^{2-}(x), \dots, I_A^{p-}(x)), (F_A^{1+}(x), F_A^{2+}(x), \dots, F_A^{p+}(x), F_A^{1-}(x), F_A^{2-}(x), \dots, F_A^{p-}(x)) \right\rangle : x \in X \right\}, \text{ where}$$

$$(T_A^{1+}(x), T_A^{2+}(x), \dots, T_A^{p+}(x), T_A^{1-}(x), T_A^{2-}(x), \dots, T_A^{p-}(x)) : E \rightarrow [0, 1],$$

$$(I_A^{1+}(x), I_A^{2+}(x), \dots, I_A^{p+}(x), I_A^{1-}(x), I_A^{2-}(x), \dots, I_A^{p-}(x)) : E \rightarrow [0, 1] \text{ and}$$

$$(F_A^{1+}(x), F_A^{2+}(x), \dots, F_A^{p+}(x), F_A^{1-}(x), F_A^{2-}(x), \dots, F_A^{p-}(x)) : E \rightarrow [0, 1] \text{ such that } 0 \leq T_A^i(x) + I_A^i(x) + F_A^i(x) \leq 3 \quad (i = 1, 2, 3, \dots, p)$$

$$(T_A^{1+}(x), T_A^{2+}(x), \dots, T_A^{p+}(x), T_A^{1-}(x), T_A^{2-}(x), \dots, T_A^{p-}(x)) (I_A^{1+}(x), I_A^{2+}(x), \dots, I_A^{p+}(x), I_A^{1-}(x), I_A^{2-}(x), \dots, I_A^{p-}(x))$$

$(F_A^{1+}(x), F_A^{2+}(x), \dots, F_A^{p+}(x), F_A^{1-}(x), F_A^{2-}(x), \dots, F_A^{p-}(x))$ is respectively the truth membership sequence, indeterminacy membership sequence and falsity membership sequence of the element x. Also, P is called the dimension of BNRS.

The set of all bipolar neutrosophic refined sets on E is denoted by BNRS(E).

13 MULTI-VALUED NEUTROSOPHIC SETS (Peng & Wang, 2015)

13.1 Operation on multi-valued neutrosophic numbers

Let $A = \langle \tilde{T}_A(x), \tilde{I}_A(x), \tilde{F}_A(x) \rangle$, $B = \langle \tilde{T}_B(x), \tilde{I}_B(x), \tilde{F}_B(x) \rangle$ are two multi-valued neutrosophic numbers. If $\forall \tilde{T}_A^a \in \tilde{T}_A$, $\forall \tilde{T}_B^b \in \tilde{T}_B$, $\forall \tilde{I}_A^a \in \tilde{I}_A$, $\forall \tilde{I}_B^b \in \tilde{I}_B$, $\forall \tilde{F}_A^a \in \tilde{F}_A$, $\forall \tilde{F}_B^b \in \tilde{F}_B$, and $\tilde{I}_A^a > \tilde{I}_B^b$, $\tilde{F}_A^a > \tilde{F}_B^b$, $\tilde{T}_A^a > \tilde{T}_B^b$, then B is superior to A, denoted as $A \prec B$.

Let $A = \langle \tilde{T}_A(x), \tilde{I}_A(x), \tilde{F}_A(x) \rangle, B = \langle \tilde{T}_B(x), \tilde{I}_B(x), \tilde{F}_B(x) \rangle$ are any two MVNNs, and $\lambda > 0$. The operations for MVNNs are defined as follows.

- (1) $\lambda A = \left\langle \bigcup_{\gamma_A \in \tilde{T}_A} \{1 - (1 - \gamma_A)^\lambda\}, \bigcup_{\eta_A \in \tilde{I}_A} \{(\eta_A)^\lambda\}, \bigcup_{\xi_A \in \tilde{F}_A} \{(\xi_A)^\lambda\} \right\rangle$;
- (2) $A^\lambda = \left\langle \bigcup_{\gamma_A \in \tilde{T}_A} \{(\gamma_A)^\lambda\}, \bigcup_{\eta_A \in \tilde{I}_A} \{1 - (1 - \eta_A)^\lambda\}, \bigcup_{\xi_A \in \tilde{F}_A} \{1 - (1 - \xi_A)^\lambda\} \right\rangle$;
- (3) $A + B = \left\langle \bigcup_{\gamma_A \in \tilde{T}_A, \gamma_B \in \tilde{T}_B} \{\gamma_A + \gamma_B - \gamma_A \cdot \gamma_B\}, \bigcup_{\eta_A \in \tilde{I}_A, \eta_B \in \tilde{I}_B} \{\eta_A \cdot \eta_B\}, \bigcup_{\xi_A \in \tilde{F}_A, \xi_B \in \tilde{F}_B} \{\xi_A \cdot \xi_B\} \right\rangle$;
- (4) $A \cdot B = \left\langle \bigcup_{\gamma_A \in \tilde{T}_A, \gamma_B \in \tilde{T}_B} \{\gamma_A \cdot \gamma_B\}, \bigcup_{\eta_A \in \tilde{I}_A, \eta_B \in \tilde{I}_B} \{\eta_A + \eta_B - \eta_A \cdot \eta_B\}, \bigcup_{\xi_A \in \tilde{F}_A, \xi_B \in \tilde{F}_B} \{\xi_A + \xi_B - \xi_A \cdot \xi_B\} \right\rangle$;

13.2 Score function, accuracy function and certainty function of multi-valued neutrosophic number

- (1) $s(A) = \frac{1}{l_{\tilde{T}_A} \cdot l_{\tilde{I}_A} \cdot l_{\tilde{F}_A}} \times \sum_{\gamma_i \in \tilde{T}_A, \eta_j \in \tilde{I}_A, \xi_k \in \tilde{F}_A} (\gamma_i + 1 - \eta_j + 1 - \xi_k) / 3$;
- (2) $a(A) = \frac{1}{l_{\tilde{T}_A} \cdot l_{\tilde{F}_A}} \times \sum_{\gamma_i \in \tilde{T}_A, \xi_k \in \tilde{F}_A} (\gamma_i - \xi_k)$;
- (3) $c(A) = \frac{1}{l_{\tilde{T}_A}} \times \sum_{\gamma_i \in \tilde{T}_A} \gamma_i$;

13.3 Comparison of multi-valued neutrosophic numbers

Let $A = \langle \tilde{T}_A(x), \tilde{I}_A(x), \tilde{F}_A(x) \rangle, B = \langle \tilde{T}_B(x), \tilde{I}_B(x), \tilde{F}_B(x) \rangle$ are two multi-valued neutrosophic numbers. Then the comparison method can be defined as follows:

- i. If $s(A) > s(B)$, then A is greater than B , that is, A is superior to B , denoted by $A \succ B$.
- ii. If $s(A) = s(B)$ and $a(A) > a(B)$, then A is greater than B , that is, A is superior to B , denoted by $A \succ B$.
- iii. If $s(A) = s(B)$, $a(A) = a(B)$ and $c(A) > c(B)$, then A is greater than B , that is, A is superior to B , denoted by $A \succ B$.
- iv. If $s(A) = s(B)$, $a(A) = a(B)$ and $c(A) = c(B)$, then A is equal to B , that is, A is indifferent to B , denoted by $A \sim B$.

14. Simplified neutrosophic linguistic sets (SNLSs) (Tian et al., 2016)

14.1 SNLSs

Definition 1. Let X be a space of points (objects) with a generic element in X , denoted by x and $H = \{h_0, h_1, h_2, \dots, h_{2t}\}$ be a finite and totally ordered discrete term set, where t is a nonnegative real number. A SNLS A in X is characterized as

$$A = \{ \langle x, h_{\theta(x)}, (t(x), i(x), f(x)) \rangle \mid x \in X \},$$

where $h_{\theta(x)} \in H$, $t(x) \in [0, 1]$, $i(x) \in [0, 1]$, $f(x) \in [0, 1]$, with the condition $0 \leq t(x) + i(x) + f(x) \leq 3$ for any $x \in X$. And $t_A(x)$, $i_A(x)$ and $f_A(x)$ represent, respectively, the degree of truth-membership, indeterminacy-

membership and falsity-membership of the element x in X to the linguistic term $h_{\theta(x)}$. In addition, if $\|X\|=1$, a SNLS will be degenerated to a SNLN, denoted by $A = \langle h_{\theta}, (t, i, f) \rangle$. And A will be degenerated to a linguistic term if $t=1, i=0$, and $f=0$.

14.2 Operations of SNLNs

Let $a_i = \langle h_{\theta_i}, (t_i, i_i, f_i) \rangle$ and $a_j = \langle h_{\theta_j}, (t_j, i_j, f_j) \rangle$ be two SNLNs, f^* be a linguistic scale function and $\lambda \geq 0$. Then the following operations of SNLNs can be defined.

- (1) $a_i \oplus a_j = \left\langle f^{*-1}(f^*(h_{\theta_i}) + f^*(h_{\theta_j})), \left(\frac{f^*(h_{\theta_i})t_i + f^*(h_{\theta_j})t_j}{f^*(h_{\theta_i}) + f^*(h_{\theta_j})}, \frac{f^*(h_{\theta_i})i_i + f^*(h_{\theta_j})i_j}{f^*(h_{\theta_i}) + f^*(h_{\theta_j})}, \frac{f^*(h_{\theta_i})f_i + f^*(h_{\theta_j})f_j}{f^*(h_{\theta_i}) + f^*(h_{\theta_j})} \right) \right\rangle$;
- (2) $a_i \otimes a_j = \left\langle f^{*-1}(f^*(h_{\theta_i})f^*(h_{\theta_j})), (t_i t_j, i_i + i_j - i_i i_j, f_i + f_j - f_i f_j) \right\rangle$;
- (3) $\lambda a_i = \left\langle f^{*-1}(\lambda f^*(h_{\theta_i})), (t_i, i_i, f_i) \right\rangle$;
- (4) $a_i^\lambda = \left\langle f^{*-1}((f^*(h_{\theta_i}))^\lambda), (t_i^\lambda, 1 - (1 - i_i)^\lambda, 1 - (1 - f_i)^\lambda) \right\rangle$;
- (5) $neg(a_i) = \left\langle f^{*-1}(f^*(h_{2t_i}) - f^*(h_{\theta_i})), (f_i, 1 - i_i, t_i) \right\rangle$;

15. COMPARISON ANALYSIS

Refined neutrosophic set is a generalization of fuzzy set, intuitionistic fuzzy set, neutrosophic set, interval-valued neutrosophic set, neutrosophic hesitant fuzzy set and interval-valued neutrosophic hesitant fuzzy set. Also differences and similarities between these sets are given in Table 1.

Table 1. Comparison of fuzzy set and interval-valued neutrosophic set theory

	Fuzzy	intuitionistic fuzzy	Interval-Valued neutrosophic	Interval- Valued neutrosophic HesitantFuzzy Set	Neutrosophic	Neutrosophic HesitantFuzzy Set	Neutrosophic refined
Domain	Universe of discourse	Universe of discourse	Universe of discourse	Universe of discourse	Universe of discourse	Universe of discourse	Universe of discourse
Co-domain	Single-value in [0,1]	Two-value in [0,1]	Unipolar interval in [0,1]	Unipolar interval in [0,1]	[0,1] ³	[0,1] ³	[0,1] ³
Number	Yes	Yes	Yes	Yes	Yes	No	No
Membership function	regular	regular	Regular	irregular	regular	irregular	Regular
Uncertainty	Yes	Yes	Yes	Yes	Yes	Yes	Yes
True	Yes	Yes	Yes	Yes	Yes	Yes	Yes
Falsity	No	Yes	Yes	Yes	Yes	Yes	Yes
Indeterminacy	No	No	Yes	Yes	Yes	Yes	Yes
Negativity	No	No	No	No	Yes in [0,1]	No	No
Membership valued	Membership valued	Singlevalued	Interval-valued	Singlevalued	Singlevalued	Singlevalued	Multi-valued

Bosc and Pivert (2013) said that “Bipolarity refers to the propensity of the human mind to reason and make decisions on the basis of positive and negative effects. Positive information states what is possible, satisfactory, permitted, desired, or considered as being acceptable. On the other hand, negative statements express what is impossible, rejected, or forbidden. Negative preferences correspond to constraints, since they specify which values or objects have to be rejected (i.e., those that do not satisfy the constraints), while positive preferences correspond to wishes, as they specify which objects are more desirable than others (i.e., satisfy user wishes) without rejecting those that do not meet the wishes.” Therefore, Lee (2000, 2009) introduced the concept of bipolar fuzzy sets which is a generalization of the fuzzy sets. Bipolar neutrosophic refined sets which is an extension of the fuzzy sets, bipolar fuzzy sets, intuitionistic fuzzy sets and bipolar neutrosophic sets. Also differences and similarities between these sets are given in Table 2.

Table 2. Comparison of bipolar fuzzy set and its various extensions

	Bipolar Fuzzy	Bipolar Intuitionistic fuzzy	Bipolar Interval- Valued neutrosophic	Bipolar Neutrosophic	Bipolar neutrosophic refined
Domain	Universe of discourse	Universe of discourse	Universe of discourse	Universe of discourse	Universe of discourse
Co-domain	Single-value in $[-1,1]$	Two-value in $[-1,1]$	Unipolar interval in $[-1,1]$	Bipolar $[-1,1]^3$	Bipolar $[-1,1]^3$
Number	Yes	Yes	Yes	Yes	Yes
Uncertainty	Yes	Yes	Yes	Yes	Yes
True	Yes	Yes	Yes	Yes	Yes
Falsity	No	Yes	Yes	Yes	Yes
Membership valued	Singlevalued	Singlevalued	Singlevalued	Singlevalued	Multi valued

Table 3. Comparison of different types of neutrosophic sets

	SVNS	IVNS	BNSs	Multi-valued neutrosophic sets	Trapezoidal Neutrosophic sets	Triangular Fuzzy Neutrosophic sets	SNLSs
Domain	Universe of discourse	Universe of discourse	Universe of discourse	Universe of discourse	Universe of discourse	Universe of discourse	Universe of discourse
Co-domain	$[0,1]^3$	Unipolar Interval in $[0,1]$	Bipolar $[-1,1]^3$	$[0,1]^3$	$[0,1]^3$	$[0,1]^3$	$[0, 2t]$ or $[-t, t]$
Number	Yes	Yes	Yes	Yes	Yes	Yes	No
Uncertainty	Yes	Yes	Yes	Yes	Yes	Yes	Yes
True	Yes	Yes	Yes	Yes	Yes	Yes	Yes
Falsity	Yes	Yes	Yes	Yes	Yes	Yes	Yes
Indeterminacy	Yes	Yes	Yes	Yes	Yes	Yes	Yes

CONCLUSIONS

NSs are characterized by truth, indeterminacy, and falsity membership functions which are independent in nature. NSs can handle incomplete, indeterminate, and inconsistent information quite well, whereas IFSs and FSs can only handle incomplete or partial information. However, SVN, subclass of NSs gain much popularity to apply in concrete areas such as real engineering and scientific problems. Many extensions of NSs have been appeared in the literature. Some of them are discussed in the paper. New hybrid sets derived from neutrosophic sets gain popularity as new research topics. Extensions of neutrosophic sets have been developed by many researchers. This paper presents some of their basic operations. Then, we investigate their properties and the relation between defined numbers and function on neutrosophic sets. We present comparison between bipolar fuzzy sets and its various extensions. We also present the comparison between different types of neutrosophic sets and numbers. The paper can be extended to review different types of neutrosophic hybrid sets and their theoretical development and applications in real world problems.

REFERENCES

- Ali, M., Deli, I., & Smarandache, F. (2016). The theory of neutrosophic cubic sets and their applications in pattern recognition. *Journal of Intelligent and Fuzzy Systems*, 30 (4) (2016), 1957-1963.
- Atanassov, K. T. (1986). Intuitionistic fuzzy sets. *Fuzzy Sets and Systems*, 20(1), 87-96.
- Atanassov, K., & Gargov, G. (1989). Interval valued intuitionistic fuzzy sets. *Fuzzy Sets and Systems*, 31(3), 343-349.
- Banerjee, D., Giri, B. C., Pramanik, S., & Smarandache, F. (2017). GRA for multi attribute decision making in neutrosophic cubic set environment. *Neutrosophic Sets and Systems*, 15, 60-69.
- Biswas, P., Pramanik, S., & Giri, B.C. (2014). Cosine similarity measure based multi-attribute decision-making with trapezoidal fuzzy neutrosophic numbers. *Neutrosophic Sets and Systems*, 8, 46-56.
- Biswas, P., Pramanik, S., & Giri, B.C. (2016a). TOPSIS method for multi-attribute group decision making under single-valued neutrosophic environment. *Neural Computing and Applications* 27(3), 727-737.
- Biswas, P., Pramanik, S., & Giri, B. C. (2016b). Value and ambiguity index based ranking method of single-valued trapezoidal neutrosophic numbers and its application to multi-attribute decision making. *Neutrosophic Sets and Systems* 12, 127-138.
- Biswas, P., Pramanik, S., & Giri, B. C. (2016c). Aggregation of triangular fuzzy neutrosophic set information and its application to multi-attribute decision making. *Neutrosophic Sets and Systems* 12, 20-40.
- Biswas, P., Pramanik, S., & Giri, B. C. (2016d). GRA method of multiple attribute decision making with single valued neutrosophic hesitant fuzzy set information. In F. Smarandache, & S. Pramanik (Eds), *New trends in neutrosophic theory and applications* (pp. 55-63). Brussels: Pons Editions.
- Biswas, P., Pramanik, S., & Giri, B. C. (2016e). Some distance measures of single valued neutrosophic hesitant fuzzy sets and their applications to multiple attribute decision making. In F. Smarandache, & S. Pramanik (Eds), *New trends in neutrosophic theory and applications* (pp. 55-63). Brussels: Pons Editions.
- Bosc, P., & Pivert, O. (2013). On a fuzzy bipolar relational algebra, *Information Sciences*, 219, 1–16.
- Broumi, S., & Deli, I. (2014). Correlation measure for neutrosophic refined sets and its application in medical diagnosis. *Palestine Journal of Mathematics*, 3, 11–19.
- Broumi, S., Smarandache, F. (2014a). Single valued neutrosophic trapezoid linguistic aggregation operators based multi-attribute decision making. *Bulletin of Pure & Applied Sciences- Mathematics and Statistics*, 135-155. doi: 10.5958/2320-3226.2014.00006.X
- Broumi, S.; Smarandache, F. (2014b). Neutrosophic refined similarity measure based on cosine function. *Neutrosophic Sets and Systems*, 6, 42–48.
- Broumi, S.; Smarandache, F. (2013). Several similarity measures of neutrosophic sets. *Neutrosophic Sets and Systems*, 1, 54–62.
- Broumi, S., Smarandache, F., & Dhar, M. (2014b). Rough neutrosophic sets. *Italian Journal of Pure and Applied Mathematics*, 32, 493–502.
- Broumi, S., Smarandache, F., & Dhar, M. (2014c). Rough neutrosophic sets. *Neutrosophic Sets and Systems*, 3, 60-66.
- Broumi, S., Talea, M., Smarandache, F. (2016). Single valued neutrosophic graphs: degree, order and size,” IEEE International Conference on Fuzzy Systems (FUZZ), 2444-2451.

- Chatterjee, R., Majumdar, P., Samanta, S. K. (2016). On some similarity measures and entropy on quadripartitioned single valued neutrosophic sets. *Journal of Intelligent & Fuzzy Systems*, 30 (4), 2475-2485.
- Chen, J., Ye, J., & Du, S. (2017). Vector similarity measures between refined simplified neutrosophic sets and their multiple attribute decision-making method. *Symmetry*, 9(8), 153; doi:10.3390/sym9080153
- Das, S., Kumar, S., Kar, S., & Pal, T. (2017). Group decision making using neutrosophic soft matrix: An algorithmic approach. *Journal of King Saud University - Computer and Information Sciences*. <https://doi.org/10.1016/j.jksuci.2017.05.001>.
- Deli, I. & Broumi, S. (2015). Neutrosophic soft matrices and NSM-decision making. *Journal of Intelligent and Fuzzy Systems*, 28(5), 2233-2241.
- Deli, I., Ali, M., & Smarandache, F. (2015a). Bipolar neutrosophic sets and their applications based on multicriteria decision making problems. *Advanced Mechatronic Systems, (ICAMEchs), International Conference*, 249-254. doi: [10.1109/ICAMEchs.2015.7287068](https://doi.org/10.1109/ICAMEchs.2015.7287068)
- Deli, I., Broumi, S. & Smarandache, F. (2015b). On neutrosophic refined sets and their applications in medical diagnosis. *Journal of New Theory*, 6,88-89.
- Deli, İ., & Şubaş, Y. (2016). Bipolar neutrosophic refined sets and their applications in medical diagnosis. *International Conference on Natural Science and Engineering (ICNASE'16)*,1121-1132.
- Deli, I. & Y. Subas, Y. (2017). A ranking method of single valued neutrosophic numbers and its application to multi-attribute decision making problems. *International Journal of Machine Learning and Cybernetics*, 8 (4), 1309-1322.
- Dey, P.P., S. Pramanik, & Giri, B. C. (2015). Generalized neutrosophic soft multi-attribute group decision making based on TOPSIS. *Critical Review*, 11, 41-55.
- Dey, P.P., S. Pramanik, & Giri, B.C. 2016a. *TOPSIS for solving multi-attribute decision making problems under bi-polar neutrosophic environment*. In F. Smarandache, & S. Pramanik (Eds), *New trends in neutrosophic theory and applications* (pp. 65-77). Brussels: Pons Editions.
- Dey, P.P., S. Pramanik, & Giri, B. C. (2016b). Neutrosophic soft multi-attribute group decision making based on grey relational analysis method. *Journal of New Results in Science*, 10, 25-37.
- Dey, P.P., S. Pramanik, & Giri, B. C. (2016c). Neutrosophic soft multi-attribute decision making based on grey relational projection method. *Neutrosophic Sets and Systems* 11, 98-106.
- Hai-Long, Y., Zhi-Lian, G., Yanhong, S., & Xiuwu, L. (2016). On single valued neutrosophic relations. *Journal of Intelligent and Fuzzy Systems*, 30(2), 1045-1056. doi: 10.3233/IFS-151827.
- Jun, Y. B., Smarandache, F., & Kim, C. S. (2017). Neutrosophic cubic sets. *New Mathematics and Natural Computation*, 13 (1) (2017), 41-54.
- Kharal, A (2014). A neutrosophic multi-criteria decision making method. *New Mathematics and Natural Computation*, 10(2), 143-162.
- Kaufmann, A., & Gupta, M. M. (1988). *Fuzzy mathematical models in engineering and management science*, Elsevier Science Publishers, B.V.
- Lee, K.H. (2005). *First course on fuzzy theory and applications*. Springer: Berlin.
- Lee, K. M. (2000). Bipolar-valued fuzzy sets and their operations. *Proc. Int. Conf. on Intelligent Technologies*, Bangkok, Thailand, 307-312.
- Lee, K. J. (2009). Bipolar fuzzy sub algebras and bipolar fuzzy ideals of BCK/BCI-algebras. *Bulletin of the Malaysian Mathematical Sciences Society*, (2)32(3), 361-373.
- Liang, R., Wang, J. & Zhang, H. (2017). A multi-criteria decision-making method based on single-valued trapezoidal neutrosophic preference relations with complete weight information. *Neural Computing and Applications*. <https://doi.org/10.1007/s00521-017-2925-8>.
- Lu, Z. & Ye, J. (2017). Cosine measures of neutrosophic cubic sets for multiple attribute decision-making. *Symmetry*, 9(7), 121; doi:10.3390/sym9070121.
- Maji, P. K. (2013). Neutrosophic soft set. *Annals of Fuzzy Mathematics and Informatics* 5 (1), 157-168.
- Mondal, K., & Pramanik, S. (2014). Multi-criteria group decision making approach for teacher recruitment in higher education under simplified Neutrosophic environment. *Neutrosophic Sets and Systems*, 6, 28-34.
- Mondal, K., & Pramanik, S. (2015a). Neutrosophic decision making model of school choice. *Neutrosophic Sets and Systems*, 7, 62-68.
- Mondal, K., & Pramanik, S. (2015b). Rough neutrosophic multi-attribute decision-making based on grey relational analysis. *Neutrosophic Sets and Systems*, 7, 8-17.
- Mondal, K., & Pramanik, S. (2015c). Rough neutrosophic multi-attribute decision-making based on rough accuracy score function. *Neutrosophic Sets and Systems*, 8, 14-21.

- Mondal, K., & Pramanik, S. (2015d). Neutrosophic tangent similarity measure and its application to multiple attribute decision making. *Neutrosophic Sets and Systems*, 9, 80-87.
- Mondal, K., & Pramanik, S. (2015e). Neutrosophic refined similarity measure based on tangent function and its application to multi attribute decision making. *Journal of New Theory*, 8, 41-50.
- Mondal, K., Pramanik, S. (2015f). Decision making based on some similarity measures under interval rough neutrosophic environment. *Neutrosophic Sets and Systems*, 10, 46-57.
- Mondal, K., Pramanik, S. (2015g). Tri-complex rough neutrosophic similarity measure and its application in multi-attribute decision making. *Critical Review*, 11, 26-40.
- Mondal, K., Pramanik, S. (2015h). Neutrosophic refined similarity measure based on tangent function and its application to multi attribute decision making. *Journal of New Theory*, 8, 41-50.
- Mondal, K., Pramanik, S., (2015i) Neutrosophic refined similarity measure based on cotangent function and its application to multi-attribute decision making. *Global Journal of Advanced Research*, 2(2),486-494.
- Mondal, K., Pramanik, S., & Smarandache, F. (2016a). Several trigonometric Hamming similarity measures of rough neutrosophic sets and their applications in decision making. In F. Smarandache, & S. Pramanik (Eds), *New trends in neutrosophic theory and application* (pp. 93-103). Brussels, Belgium: Pons Editions.
- Mondal, K., Pramanik, S., & Smarandache, F. (2016b). Multi-attribute decision making based on rough neutrosophic variational coefficient similarity measure. *Neutrosophic Sets and Systems*, 13, 3-17.
- Mondal, K., Pramanik, S., & Smarandache, F. (2016c). Rough neutrosophic TOPSIS for multi-attribute group decision making. *Neutrosophic Sets and Systems*, 13, 105-117.
- Mondal, K., Pramanik, S., & Smarandache, F. (2016d). Rough neutrosophic hyper-complex set and its application to multi-attribute decision making. *Critical Review*, 13, 111-126.
- Nayagam, V.L.G., Jeevaraj, S., & Sivaraman, G. (2016). Complete ranking of intuitionistic fuzzy numbers. *Fuzzy Information and Engineering*, 8 (2), 237-254.
- Peng, J. J., and Wang, J. (2015). Multi-valued neutrosophic sets and its application in multi-criteria decision-making problems. *Neutrosophic Sets and Systems*, 10, 3-17.
- Peng, J. J., Wang, J., Wu, X., Wang, J. & Chen, X. (2014). Multi-valued neutrosophic sets and power aggregation operators with their applications in multi-criteria group decision-making problems. *International Journal of Computational Intelligence Systems*, 8 (2), 345-363.
- Pramanik, S., Banerjee, D., & Giri, B.C. (2016a). TOPSIS approach for multi attribute group decision making in refined neutrosophic environment. In F. Smarandache, & S. Pramanik (Eds.), *New trends in neutrosophic theory and applications* (pp. 79-91). Brussels: Pons Editions.
- Pramanik, S, Banerjee, D., & B.C. Giri. (2016b). Multi – criteria group decision making model in neutrosophic refined set and its application. *Global Journal of Engineering Science and Research Management*, 3(6), 12-18. doi:10.5281/zenodo.55307.
- Pramanik, S., Biswas, P., & Giri, B. C. (2017). Hybrid vector similarity measures and their applications to multi-attribute decision making under neutrosophic environment. *Neural Computing and Applications*, 28 (5), 1163-1176. doi:10.1007/s00521015-2125-3.
- Pramanik, S., & Dalapati, S. (2016). GRA based multi criteria decision making in generalized neutrosophic soft set environment, *Global Journal of Engineering Science and Research Management*, 3(5), (2016), 153-169.
- Pramanik, S., Dalapati, S, Alam, S., & Roy, T. K. (2017a). Some operations and properties of neutrosophic cubic soft set. *Global Journal of Research and Review*, 4(2), 1-8. doi: 10.21767/2393-8854.100014.
- Pramanik, S.; Dalapati, S.; Alam, S., & Roy, T.K. (2017b). NC-TODIM-based MAGDM under a neutrosophic cubic set environment. *Information*, 8, 149. doi:[10.3390/info8040149](https://doi.org/10.3390/info8040149).
- Pramanik, S., Dalapati, S, Alam, S., Roy, T. K., & Smarandache, F. (2017). Neutrosophic cubic MCGDM method based on similarity measure. *Neutrosophic Sets and Systems*, 16, 44-56.
- Pramanik, S., Dey, P. P., & Giri, B. C. (In Press), Hybrid vector similarity measure of single valued refined neutrosophic sets to multi-attribute decision making problems. In F. Smarandache, & S. Pramanik (Eds), *New trends in neutrosophic theory and applications, vol. II*. Brussels: Pons Editions.
- Pramanik, S., Dey, P. P., Giri, B. C., & Smarandache, F. (2017a). Bipolar neutrosophic projection based models for solving multi-attribute decision making problems. *Neutrosophic Sets and Systems*, 15, 70-79.
- Pramanik, S., Dey, P. P., Giri, B. C., & Smarandache, F. (2017b). An extended TOPSIS for multi-attribute decision making problems with neutrosophic cubic information. *Neutrosophic Sets and Systems*, 17, 70-79.
- Pramanik, S., & Mondal, K. (2015a). Cosine similarity measure of rough neutrosophic sets and its application in medical diagnosis. *Global Journal of Advanced Research*, 2(1), 212-220.

- Pramanik, S., & Mondal, K. (2015b). Some rough neutrosophic similarity measure and their application to multi attribute decision making. *Global Journal of Engineering Science and Research Management*, 2(7) (2015) 61-74.
- Pramanik, S., & Mondal, K. (2015c). Cotangent similarity measure of rough neutrosophic sets and its application to medical diagnosis. *Journal of New Theory*, 4, 90-102.
- Pramanik, S., & Mondal, K. (2016). Rough bipolar neutrosophic set. *Global Journal of Engineering Science and Research Management*, 3(6), 71-81.
- Pramanik, S., Roy, R., Roy, T. K., & Smarandache, F. (2017). Multi criteria decision making using correlation coefficient under rough neutrosophic environment. *Neutrosophic Sets and Systems*, 17, 29-36.
- Pramanik, S., Roy, R., Roy, & T. K. (In Press). Multi criteria decision making based on projection and bidirectional projection measures of rough neutrosophic sets. In F. Smarandache, & S. Pramanik (Eds), *New trends in neutrosophic theory and application, vol.-ii*. Brussels, Belgium: Pons Editions.
- Pramanik, S., & Roy, T. K. (2014). Neutrosophic game theoretic approach to Indo-Pak conflict over Jammu-Kashmir. *Neutrosophic Sets and Systems*, 2, 82-101.
- Sahin, R. & Liu, P. (2016). Distance and similarity measure for multiple attribute with single –valued neutrosophic hesitant fuzzy information. In F. Smarandache, & S. Pramanik (Eds.), *New trends in neutrosophic theory and applications* (pp. 35-54). Brussels: Pons Editions.
- Smarandache, F. (1998). *Neutrosophy: neutrosophic probability, set, and logic: analytic synthesis & synthetic analysis*. Rehoboth: American Research Press.
- Smarandache, F. (1999). A unifying field in logics. *Neutrosophy: Neutrosophic probability, set and logic*. Rehoboth: American Research Press.
- Smarandache, F., (2002). A unifying field in logics: neutrosophic logics. *Multiple Valued Logic*, 8(3), 385-438.
- Smarandache, F. (2005). Neutrosophic set, a generalization of intuitionistic fuzzy sets, *International Journal of Pure and Applied Mathematics*, 24, 287-297.
- Smarandache, F. (2006). Neutrosophic set- a generalization of intuitionistic fuzzy set. *Granular Computing, 2006 IEEE, International Conference*, 38-42. doi:10.1109/GRC.2006.1635754.
- Smarandache, F. (2010). Neutrosophic set-a generalization of intuitionistic fuzzy set. *Journal of Defence Resources Management*, 1(1), 107-116.
- Smarandache, F. (2013). n-Valued refined neutrosophic logic and its applications in Physics. *Progress in Physics*, 4, 143-146. <https://arxiv.org/ftp/arxiv/papers/1407/1407.1041.pdf>
- Smarandache, F.(2016a). Operators on single valued neutrosophic sets, neutrosophic undersets, and neutrosophic offsets. *Journal of Mathematics and Informatics*, 5, 63-67.
- Smarandache, F.(2016b). *Neutrosophic overset, neutrosophic underset, neutrosophic offset, similarly for neutrosophicover-/under-/offlogic, probability, and statistic*. Pons Editions, Brussels.
- Smarandache, F. & Pramanik, S. (Eds). (2016). *New trends in neutrosophic theory and applications*. Brussels: Pons Editions.
- Sodenkamp, M. (2013). *Models, methods and applications of group multiple-criteria decision analysis in complex and uncertain systems*. Dissertation, University of Paderborn, Germany.
- Tian, Z. P., Wang, J., Zhang, H. Y., Chen, X. H., & Wang, J. Q. (2016). Simplified neutrosophic linguistic normalized weighted Bonferroni mean operator and its application to multi-criteria decision-making problems. *Filomat*, 30 (12): 3339-3360.
- Uluçay, V, Deli, I, & Şahin, M. (2016). Similarity measures of bipolar neutrosophic sets and their application to multiple criteria decision making. *Neural Computing and Applications*. <https://doi.org/10.1007/s00521-016-2479-1>
- Wang, J.J. and Li, X. E. (2015). TODIM method with multi-valued neutrosophic sets. *Control and Decision*, 30, 1139-1142. (in Chinese)
- Wang, H., Smarandache, F., Zhang, Y.Q., & Sunderraman, R. (2005). *Interval neutrosophic sets and logic: theory and applications in computing*. Arizona, Hexis.
- Wang, H., Smarandache F., Zhang, Y.Q., & Sunderraman, R. (2010). Single valued neutrosophic sets. *Multispace and Multistructure*, 4, 410-413.
- Ye, J. (2014a). Single valued neutrosophic minimum spanning tree and its clustering method. *Journal of Intelligent Systems*, 23(3): 311–324.
- Ye, J. (2014 b). Multiple-attribute decision-making method under a single-valued neutrosophic hesitant fuzzy environment, *Journal of Intelligent Systems*, DOI: 10.1515/jisys-2014-0001.
- Ye, J.(2014c). Vector similarity measures of simplified neutrosophic sets and their application in multicriteria decision making. *International Journal of Fuzzy Systems, Vol. 16, No. 2*, pp.204-211.

- Ye, J. (2015a). Improved cosine similarity measures of simplified neutrosophic sets for medical diagnoses. *Artificial Intelligence in Medicine*, 63(3), 171–179.
- Ye, J. (2015b). Trapezoidal neutrosophic set and its application to multiple attribute decision-making, *Neural Computing and Applications*, 26, 1157-1166.
- Ye, J. (2016). Correlation coefficients of interval neutrosophic hesitant fuzzy sets and its application in a multiple attribute decision making method. *Informatica*, 27(1), 179-202.
- Ye, J. (2017). Linguistic neutrosophic cubic numbers and their multiple attribute decision-making method. *Information*, 8(3), 110; doi:[10.3390/info8030110](https://doi.org/10.3390/info8030110).
- Ye, J., Smarandache, F. (2016). Similarity measure of refined single-valued neutrosophic sets and its multicriteria decision making method. *Neutrosophic Sets and Systems*, 12, 41–44.
- Zadeh, L. (1965). Fuzzy sets. *Information and Control*, 5, 338-353.

Entropy, Neuro-Entropy and Anti-Entropy for Neutrosophic Information

Vasile Patrascu

Tarom Information Technology, Bucharest, Romania
e-mail: patrascu.v@gmail.com

ABSTRACT

This article shows a deca-valued representation of neutrosophic information. For this representation the following neutrosophic features were defined and used: truth, falsity, weak truth, weak falsity, ignorance, contradiction, saturation, neutrality, ambiguity and hesitation. In the context created by these ten features emerged the possibility but also the necessity of defining three neutrosophic concepts: entropy, neutro-entropy and anti-entropy. Possibility appeared due to the refining of neutrosophic representation. The necessity appeared because all of these features cannot be classified by taking into account only certainty (entropy) and uncertainty (anti-entropy). There is a requirement for a third concept (neutro-entropy) that refers to neutrality.

KEYWORDS: Neutrosophic information, entropy, neutro-entropy, anti-entropy, non-entropy.

1. INTRODUCTION

The neutrosophic representation of information was proposed by Smarandache (1999, 2002, 2005, 2007, 2009, 2010, 2013) and represents a generalization for the fuzzy representation proposed by Zadeh (1965) and in the same time, it represents an extension for intuitionistic fuzzy one proposed by Atanassov (1983, 1986). The neutrosophic representation is defined by three parameters: degree of truth μ , degree of falsity ν and degree of indeterminacy or neutrality ω . In this paper, we present two deca-valued representations for neutrosophic information. There will be shown computing formulas for the following ten features of neutrosophic information: truth, falsity, weak truth, weak falsity, ignorance, contradiction, saturation, neutrality, ambiguity and hesitation. With these features we will then construct the entropy, the neutro-entropy and the anti-entropy. These are equivalent to Smarandache's refinement (2013), and in this case one has: T1, T2; I1, I2, I3, I4, I5, I6; F1, F2 respectively. Further, the paper has the following structure: Section 2 presents two variants for penta-valued representation of bifuzzy information. These representations are later developed in two variants for deca-valued representation of neutrosophic information. Also, there are presented formulae for bifuzzy entropy and non-entropy. Section 3 presents two deca-valued representation of neutrosophic information and underlines three concepts for neutrosophic information: entropy, neutro-entropy and anti-entropy. If the entropy and non-entropy are already known, the neutro-entropy and anti-entropy are new concepts and were defined as sub-components of the non-entropy. For this definition there were used four components of the neutrosophic information, namely the pair weak truth with weak falsity and the pair truth with falsity. In other words, non-entropy is divided in anti-entropy and neutro-entropy. Section 4 presents some conclusions while the section 5 is the references section.

2. THE PENTA-VALUED REPRESENTATION OF BIFUZZY INFORMATION

The bifuzzy information is defined by the degree of truth μ and degree of falsity ν . This is the primary representation. Starting from the primary representation, we can construct other derived forms (Patrascu, 2008, 2012). In the next we will present two variants.

2.1 Variant (I) for penta-valued representation of bifuzzy information

For the penta-valued construction, we need to define two auxiliary parameters.

The net truth:

$$\tau = \mu - \nu \quad (1)$$

The definedness:

$$\delta = \mu + \nu - 1 \quad (2)$$

In the next we will define the main indexes.

The bifuzzy index of ignorance:

$$\pi = \max(-\delta, 0) \quad (3)$$

The bifuzzy index of contradiction:

$$\kappa = \max(\delta, 0) \quad (4)$$

The bifuzzy index of ambiguity:

$$\alpha = 1 - |\tau| - |\delta| \quad (5)$$

The bifuzzy index of truth:

$$\tau^+ = \max(\tau, 0) \quad (6)$$

The bifuzzy index of falsity:

$$\tau^- = \max(-\tau, 0) \quad (7)$$

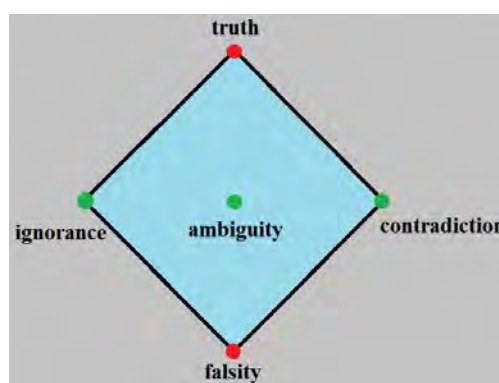

Fig. 1. The five features of bifuzzy information.

On this way, we obtained the first variant for penta-valued representation of bifuzzy information. There exist the following equalities:

$$\pi \cdot \kappa = 0 \quad (8)$$

$$\tau^+ \cdot \tau^- = 0 \quad (9)$$

The five indexes defined by formulae (3), (4), (5), (6), (7) verify the condition of partition of unity, namely:

$$\tau^+ + \tau^- + \alpha + \pi + \kappa = 1 \tag{10}$$

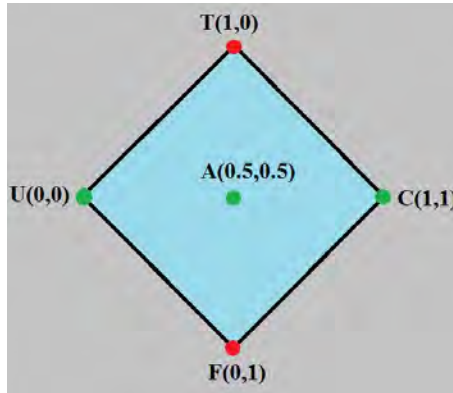

Fig. 2. The five prototypes of bifuzzy information.

From (10) it results the bifuzzy entropy (uncertainty) and bifuzzy non-entropy (certainty) formulae.

The bifuzzy entropy:

$$entropy = \alpha + \pi + \kappa \tag{11}$$

The ambiguity, ignorance and contradiction are components of entropy (see figure 1).

The non-entropy is obtained by negation of entropy, namely:

$$non_entropy = 1 - entropy \tag{12}$$

From (10), (11) and (12) it results that the bifuzzy non-entropy is defined by:

$$non_entropy = \tau^+ + \tau^- \tag{13}$$

The truth and falsity are components of the non-entropy (certainty). The graphic of the constructed structure can be seen in figure 3.

The formulae (3), (4), (5), (6), (7) represent the transformation of the primary space into a penta-valued one. The next formulae defined the inverse transform from the penta-valued space to the bivalued one (μ, ν) .

$$\mu = \tau^+ + \kappa + \frac{\alpha}{2} \tag{14}$$

$$\nu = \tau^- + \kappa + \frac{\alpha}{2} \tag{15}$$

The two formulae (14) and (15) are equivalent with the following:

$$\begin{bmatrix} \mu \\ \nu \end{bmatrix} = \tau^+ \begin{bmatrix} 1 \\ 0 \end{bmatrix} + \tau^- \begin{bmatrix} 0 \\ 1 \end{bmatrix} + \kappa \begin{bmatrix} 1 \\ 1 \end{bmatrix} + \alpha \begin{bmatrix} 0.5 \\ 0.5 \end{bmatrix} + \pi \begin{bmatrix} 0 \\ 0 \end{bmatrix} \tag{16}$$

$$\begin{bmatrix} \mu \\ \nu \end{bmatrix} = \tau^+ \cdot T + \tau^- \cdot F + \kappa \cdot C + \alpha \cdot A + \pi \cdot U \tag{17}$$

where T, F, C, A, U are the prototypes shown in figure 2.

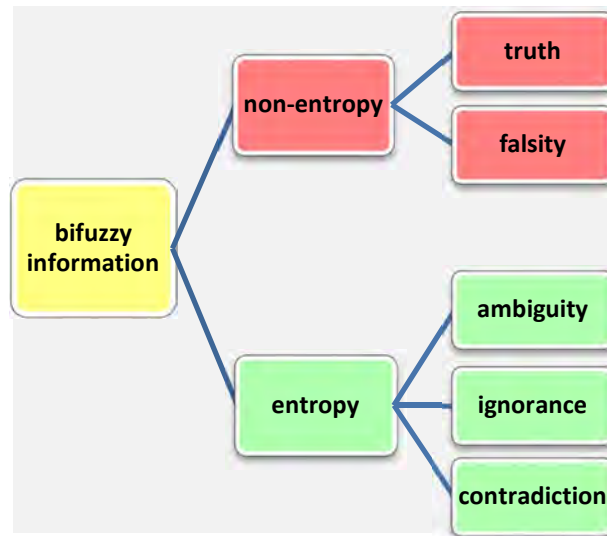

Fig. 3. The structure of the bifuzzy information.

2.2 Variant (II) for penta-valued representation of bifuzzy information

We will trace the same steps that we have used for the variant (I). We will use the same two auxiliary parameters:

The net truth:

$$\tau = \mu - \nu \quad (18)$$

The definedness:

$$\delta = \mu + \nu - 1 \quad (19)$$

In the next, we will define the main indexes.

The bifuzzy index of ignorance:

$$\pi = \max(-\delta, 0) \left(1 - \frac{|\tau|}{2}\right) \quad (20)$$

The bifuzzy index of contradiction:

$$\kappa = \max(\delta, 0) \left(1 - \frac{|\tau|}{2}\right) \quad (21)$$

The bifuzzy index of ambiguity:

$$\alpha = 1 - |\tau| - |\delta| + |\tau| \cdot |\delta| = (1 - |\tau|) \cdot (1 - |\delta|) \quad (22)$$

The bifuzzy index of truth:

$$\tau^+ = \max(\tau, 0) \left(1 - \frac{|\delta|}{2}\right) \quad (23)$$

The bifuzzy index of falsity:

$$\tau^- = \max(-\tau, 0) \left(1 - \frac{|\delta|}{2}\right) \quad (24)$$

On this way, we obtained the second variant for penta-valued representation of bifuzzy information. There exist the following equalities:

$$\pi \cdot \kappa = 0 \tag{25}$$

$$\tau^+ \cdot \tau^- = 0 \tag{26}$$

The five indexes defined by formulae (23), (24), (22), (20) and (21) verify the condition of partition of unity, namely:

$$\tau^+ \left(1 - \frac{|\delta|}{2}\right) + \tau^- \left(1 - \frac{|\delta|}{2}\right) + \alpha + \pi \left(1 - \frac{|\tau|}{2}\right) + \kappa \left(1 - \frac{|\tau|}{2}\right) = 1 \tag{27}$$

From (27) it results the bifuzzy entropy (uncertainty) and bifuzzy non-entropy (certainty) formulae.

The bifuzzy entropy:

$$entropy = \alpha + \pi \left(1 - \frac{|\tau|}{2}\right) + \kappa \left(1 - \frac{|\tau|}{2}\right) \tag{28}$$

The non-entropy is obtained by negation of entropy, namely:

$$non_entropy = 1 - entropy \tag{29}$$

From (27), (28) and (29) it results that the bifuzzy non-entropy is defined by:

$$non_entropy = \tau^+ \left(1 - \frac{|\delta|}{2}\right) + \tau^- \left(1 - \frac{|\delta|}{2}\right) \tag{30}$$

The truth and falsity are components of the non-entropy (certainty).

The formulae (20), (21), (22), (23), (24) represent the second variant for transformation of the primary space into a penta-valued one.

3. THE DECA-VALUED REPRESENTATION OF NEUTROSOPHIC INFORMATION

In this section we present a deca-valued representation of neutrosophic information having as primary source the triplet (μ, ω, ν) . This triplet defined the degree of truth, the degree of indeterminacy and the degree of falsity. We start with the penta-valued partion of the bifuzzy information and we divide each term in a sum with two other terms. For this, we will use the following formula (Patrascu, 2008):

$$x = x \circ \omega + x \bullet \bar{\omega}$$

where “ \circ ” and “ \bullet ” are two conjugate Frank t_norm (Frank, 1979), (Patrascu, 2008). In this paper we will use the Godel t-norm and Lukasiewicz t-norm (Moisil, 1965, 1972, 1975), namely:

$$x \circ y = \min(x, y)$$

$$x \bullet y = \max(x + y - 1, 0)$$

Having two variants for penta-valued representation of bifuzzy information, we will obtain two variants for deca-valued representation for neutrosophic one.

3.1 Variant (I) for deca-valued representation of neutrosophic information

In this subsection, we will use the formulae (3), (4), (5), (6) and (7) that belong to the variant (I) of the bifuzzy information representation.

We decompose the bifuzzy index of truth given by (6) into the next two terms:

$$\tau^+ = \tau^+ \circ \bar{\omega} + \tau^+ \bullet \omega$$

that is equivalent with:

$$\tau^+ = \min(\tau^+, \bar{\omega}) + \tau^+ - \min(\tau^+, \bar{\omega}) \quad (31)$$

and we obtain:

- the neutrosophic index of truth

$$t = \min(\tau^+, \bar{\omega}) \quad (32)$$

- the neutrosophic index of weak truth

$$t_w = \tau^+ - \min(\tau^+, \bar{\omega}) \quad (33)$$

We decompose the bifuzzy index of falsity given by (7) into the next two terms:

$$\tau^- = \tau^- \circ \bar{\omega} + \tau^- \bullet \omega$$

that is equivalent with:

$$\tau^- = \min(\tau^-, \bar{\omega}) + \tau^- - \min(\tau^-, \bar{\omega}) \quad (34)$$

and we obtain:

- the neutrosophic index of falsity:

$$f = \min(\tau^-, \bar{\omega}) \quad (35)$$

- the neutrosophic index of weak falsity

$$f_w = \tau^- - \min(\tau^-, \bar{\omega}) \quad (36)$$

where

$$\bar{\omega} = 1 - \omega \quad (37)$$

We decompose the bifuzzy index of ignorance given by (3) into the next two terms:

$$\pi = \pi \circ \omega + \pi \bullet \bar{\omega}$$

that is equivalent with:

$$\pi = \min(\pi, \omega) + \pi - \min(\pi, \omega) \quad (38)$$

and we obtain:

- the neutrosophic index of neutrality

$$n = \min(\pi, \omega) \quad (39)$$

- the neutrosophic index of ignorance

$$u = \pi - \min(\pi, \omega) \quad (40)$$

We decompose the bifuzzy index of contradiction given by (4) into the next two terms:

$$\kappa = \kappa \circ \omega + \kappa \bullet \bar{\omega}$$

that is equivalent with:

$$\kappa = \min(\kappa, \omega) + \kappa - \min(\kappa, \omega) \quad (41)$$

and we obtain:

- the neutrosophic index of saturation

$$s = \min(\kappa, \omega) \quad (42)$$

- the neutrosophic index of contradiction

$$c = \kappa - \min(\kappa, \omega) \quad (43)$$

We decompose the bifuzzy index of ambiguity into the two terms using the formula (5), namely:

$$\alpha = 2 - |\tau| - \bar{\omega} - |\delta| - \omega \quad (44)$$

It results, immediately:

$$\alpha = 2 - \min(|\tau|, \bar{\omega}) - \max(|\tau|, \bar{\omega}) - \min(|\delta|, \omega) - \max(|\delta|, \omega) \quad (45)$$

and we obtain:

- the neutrosophic index of ambiguity

$$a = 1 - \min(|\tau|, \bar{\omega}) - \max(|\delta|, \omega) \quad (46)$$

- the neutrosophic index of hesitation

$$h = 1 - \max(|\tau|, \bar{\omega}) - \min(|\delta|, \omega) \quad (47)$$

For ambiguity and hesitation we have the following equivalent formulae:

$$a = \min(\alpha + |\tau|, \bar{\omega}) - \min(|\tau|, \bar{\omega})$$

$$h = \min(\alpha + |\delta|, \omega) - \min(|\delta|, \omega)$$

Finally, we constructed the first variant for deca-valued representation for neutrosophic information. The ten parameters define a partition of unity, namely:

$$t + t_w + f + f_w + c + u + n + s + a + h = 1 \quad (48)$$

After how we constructed the ten indexes we learn there exist the following relations:

$$t + t_w + f + f_w = |\tau| \quad (49)$$

$$c + u + n + s = |\delta| \quad (50)$$

$$a + h = \alpha \quad (51)$$

$$(t + t_w) \cdot (f + f_w) = 0 \quad (52)$$

$$(u + n) \cdot (c + s) = 0 \quad (53)$$

From the ten parameters, only four of them can be different from zero while at least six of them are zero. The formulae (32), (33), (35), (36), (39), (40) (42), (43), (46), (47) define the first variant of the transformation from the ternary space to the deca-valued one. The next formulae define the inverse transform:

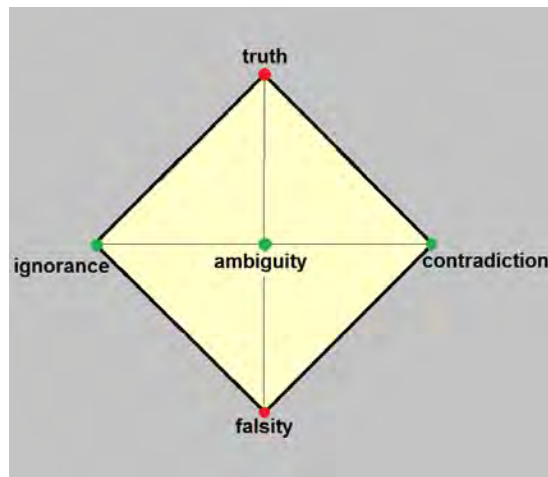

Fig. 4. The bottom square of the neutrosophic cube.

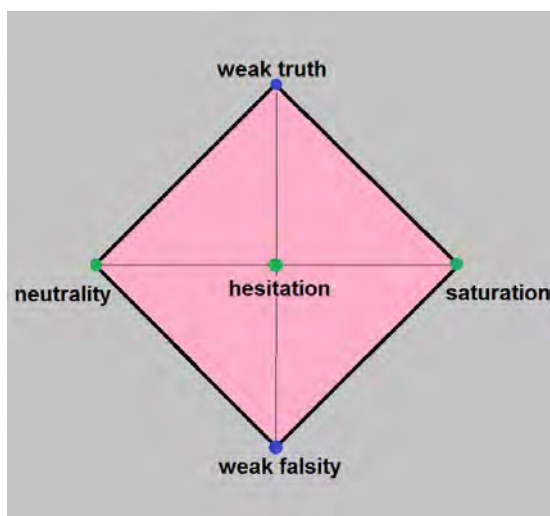

Fig. 5. The top square of the neutrosophic cube.

$$\mu = t + t_w + c + s + \frac{a}{2} + \frac{h}{2} \quad (54)$$

$$\omega = n + t_w + f_w + s + h \quad (55)$$

$$\nu = f + f_w + c + s + \frac{a}{2} + \frac{h}{2} \quad (56)$$

There exist the following equivalent formulae:

$$\begin{bmatrix} \mu \\ \omega \\ \nu \end{bmatrix} = t \begin{bmatrix} 1 \\ 0 \\ 0 \end{bmatrix} + t_w \begin{bmatrix} 1 \\ 1 \\ 0 \end{bmatrix} + f \begin{bmatrix} 0 \\ 0 \\ 1 \end{bmatrix} + f_w \begin{bmatrix} 0 \\ 1 \\ 1 \end{bmatrix} + c \begin{bmatrix} 1 \\ 0 \\ 1 \end{bmatrix} + n \begin{bmatrix} 0 \\ 1 \\ 0 \end{bmatrix} + s \begin{bmatrix} 1 \\ 1 \\ 1 \end{bmatrix} + a \begin{bmatrix} 0.5 \\ 0 \\ 0.5 \end{bmatrix} + h \begin{bmatrix} 0.5 \\ 1 \\ 0.5 \end{bmatrix} + u \begin{bmatrix} 0 \\ 0 \\ 0 \end{bmatrix} \quad (57)$$

$$\begin{bmatrix} \mu \\ \omega \\ \nu \end{bmatrix} = t \cdot T + t_w \cdot T_w + f \cdot F + f_w \cdot F_w + c \cdot C + n \cdot N + s \cdot S + a \cdot A + h \cdot H + u \cdot U \quad (58)$$

$$anti_entropy = t + f \tag{63}$$

Finally, we come to decompose the non-entropy in two parts, non-entropy and anti-entropy, existing the next formula:

$$non_entropy = anti_entropy + neutro_entropy \tag{64}$$

In figure 8, we can see the detailed structure of the neutrosophic information.

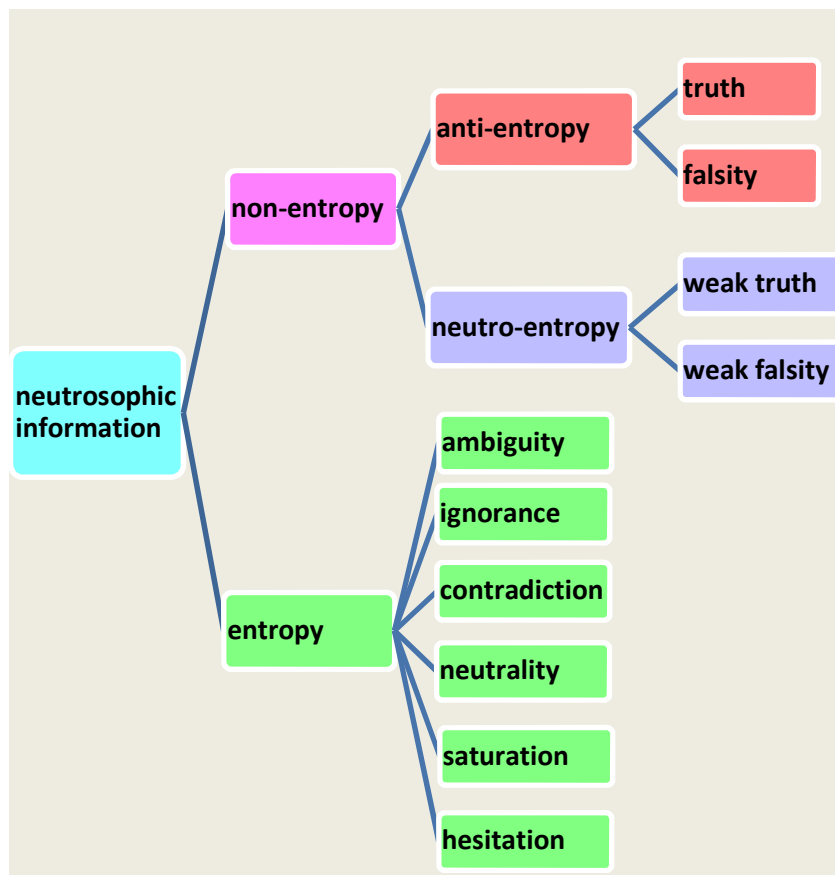

Fig. 8. The structure of the neutrosophic information

Once again, it highlights the principle laid down by Smarandache (1999), principle that led to the development theory of neutrosophy, namely, for each entity *A* there is an opposite entity *anti_A* and between these two, there exists the third entity, more precisely, one situated in the middle, *neut_A*. In addition, *anti_A* and *neut_A* together form *non_A*. In the particular case of the neutrosophic entropy, among these three components exists the partition of unity, namely:

$$entropy + neutro_entropy + anti_entropy = 1 \tag{65}$$

3.3 Variant (II) for deca-valued representation of neutrosophic information

In this subsection we will use the formulae (20), (21), (22), (23) and (24) that belong to the variant (II) of bifuzzy information representation.

We decompose the bifuzzy index of truth, given by (23) into the next two terms:

$$\tau^+ = \tau^+ \circ \bar{\omega} + \tau^+ \bullet \omega$$

that is equivalent with:

$$\tau^+ = \min(\tau^+, \bar{\omega}) + \tau^+ - \min(\tau^+, \bar{\omega}) \quad (66)$$

and we obtain:

- the neutrosophic index of truth

$$t = \min(\tau^+, \bar{\omega}) \left(1 - \frac{|\delta|}{2}\right) \quad (67)$$

- the neutrosophic index of weak truth

$$t_w = (\tau^+ - \min(\tau^+, \bar{\omega})) \left(1 - \frac{|\delta|}{2}\right) \quad (68)$$

We decompose the bifuzzy index of falsity given by (24) into the next two terms:

$$\tau^- = \tau^- \circ \bar{\omega} + \tau^- \bullet \omega$$

that is equivalent with:

$$\tau^- = \min(\tau^-, \bar{\omega}) + \tau^- - \min(\tau^-, \bar{\omega}) \quad (69)$$

and we obtain:

- the neutrosophic index of falsity:

$$f = \min(\tau^-, \bar{\omega}) \left(1 - \frac{|\delta|}{2}\right) \quad (70)$$

- the neutrosophic index of weak falsity

$$f_w = (\tau^- - \min(\tau^-, \bar{\omega})) \left(1 - \frac{|\delta|}{2}\right) \quad (71)$$

where

$$\bar{\omega} = 1 - \omega \quad (72)$$

We decompose the bifuzzy index of ignorance given by (20) into the next two terms:

$$\pi = \pi \circ \omega + \pi \bullet \bar{\omega}$$

that is equivalent with:

$$\pi = \min(\pi, \omega) + \pi - \min(\pi, \omega) \quad (73)$$

and we obtain:

- the neutrosophic index of neutrality

$$n = \min(\pi, \omega) \left(1 - \frac{|\tau|}{2}\right) \quad (74)$$

- the neutrosophic index of ignorance

$$u = (\pi - \min(\pi, \omega)) \left(1 - \frac{|\tau|}{2}\right) \quad (75)$$

We decompose the bifuzzy index of contradiction given by (21) into the next two terms:

$$\kappa = \kappa \circ \omega + \kappa \bullet \bar{\omega}$$

that is equivalent with:

$$\kappa = \min(\kappa, \omega) + \kappa - \min(\kappa, \omega) \quad (76)$$

and we obtain:

- the neutrosophic index of saturation

$$s = \min(\kappa, \omega) \left(1 - \frac{|\tau|}{2}\right) \quad (77)$$

- the neutrosophic index of contradiction

$$c = (\kappa - \min(\kappa, \omega)) \left(1 - \frac{|\tau|}{2}\right) \quad (78)$$

We decompose the bifuzzy index of ambiguity given by (22) into two terms. Firstly, using formula (22) we obtain the following equivalent form:

$$\alpha = 2 - |\tau| \left(1 - \frac{|\delta|}{2}\right) - \bar{\omega} - |\delta| \left(1 - \frac{|\tau|}{2}\right) - \omega \quad (79)$$

Then, it results, immediately:

$$\begin{aligned} \alpha = 2 - \min\left(|\tau| \left(1 - \frac{|\delta|}{2}\right), \bar{\omega}\right) - \max\left(|\tau| \left(1 - \frac{|\delta|}{2}\right), \bar{\omega}\right) - \min\left(|\delta| \left(1 - \frac{|\tau|}{2}\right), \omega\right) \\ - \max\left(|\delta| \left(1 - \frac{|\tau|}{2}\right), \omega\right) \end{aligned} \quad (80)$$

and we obtain:

- the neutrosophic index of ambiguity

$$a = 1 - \min\left(|\tau| \left(1 - \frac{|\delta|}{2}\right), \bar{\omega}\right) - \max\left(|\delta| \left(1 - \frac{|\tau|}{2}\right), \omega\right) \quad (81)$$

- the neutrosophic index of hesitation

$$h = 1 - \max\left(|\tau| \left(1 - \frac{|\delta|}{2}\right), \bar{\omega}\right) - \min\left(|\delta| \left(1 - \frac{|\tau|}{2}\right), \omega\right) \quad (82)$$

For ambiguity and hesitation we have the following equivalent formulae:

$$a = \min\left(\alpha + |\tau| \left(1 - \frac{|\delta|}{2}\right), \bar{\omega}\right) - \min\left(|\tau| \left(1 - \frac{|\delta|}{2}\right), \bar{\omega}\right)$$

$$h = \min\left(\alpha + |\delta| \left(1 - \frac{|\tau|}{2}\right), \omega\right) - \min\left(|\delta| \left(1 - \frac{|\tau|}{2}\right), \omega\right)$$

Finally, we constructed the second variant for deca-valued representation of neutrosophic information. The ten parameters define a partition of unity.

$$t + t_w + f + f_w + c + u + n + s + a + h = 1 \quad (83)$$

After how we constructed the ten indexes we learn there exist the following relations:

$$t + t_w + f + f_w = |\tau| \left(1 - \frac{|\delta|}{2}\right) \quad (84)$$

$$n + s + c + u = \delta \left(1 - \frac{|\tau|}{2}\right) \quad (85)$$

$$a + h = \alpha \quad (86)$$

$$(t + t_w) \cdot (f + f_w) = 0 \quad (87)$$

$$(u + n) \cdot (c + s) = 0 \quad (88)$$

From the ten parameters only four of them can be different from zero while at least six of them are zero.

The formulae (67), (68), (70), (71), (74), (75) (77), (78), (81), (82) define another transformation from the ternary primary space to the deca-valued one. Hence, it results the following formulae for entropy, non-entropy, neutro-entropy and anti-entropy:

$$entropy = 1 - |\tau| \left(1 - \frac{|\delta|}{2}\right) \quad (89)$$

$$non_entropy = |\tau| \left(1 - \frac{|\delta|}{2}\right) \quad (90)$$

$$neutro_entropy = (|\tau| - \min(|\tau|, \bar{\omega})) \left(1 - \frac{|\delta|}{2}\right) \quad (91)$$

$$anti_entropy = \min(|\tau|, \bar{\omega}) \left(1 - \frac{|\delta|}{2}\right) \quad (92)$$

And again there exist the following relation:

$$non_entropy = anti_entropy + neutro_entropy \quad (93)$$

$$entropy + neutro_entropy + anti_entropy = 1 \quad (94)$$

4. CONCLUSION

This approach presents a multi-valued representation of the neutrosophic information. It highlights the link between the bifuzzy information and neutrosophic one. The constructed deca-valued structures show the neutrosophic information complexity. These deca-valued structures led to construction of two new concepts for the neutrosophic information: neutro-entropy and anti-entropy. These two concepts are added to the two existing: entropy and non-entropy. Thus, we obtained the following triad: entropy, neutro-entropy and anti-entropy. For the moment, neutro-entropy was defined for neutrosophic information but it is possible that in the future this concept will be defined for other research fields such as biology. For now, in biology, it was defined anti-entropy and from the start was stated that this is different from non-entropy (Bailly & Longo, 2009), (Longo & Montevil, 2011).

5. REFERENCES

- Atanassov, K. T. (1983). *Intuitionistic fuzzy sets*. VII ITKR's Session, Sofia, June.
- Atanassov, K. T. (1986). Intuitionistic fuzzy sets. *Fuzzy sets and Systems*, 20(1), 87-96.
- Bailly, F. & Longo, G. (2009). Biological Organization and Anti-Entropy. *Journal Biological Systems*, 17(1), 63-96.
- Frank, M. J. (1979). On the simultaneous associativity of $f(x, y)$ and $x + y - f(x, y)$. *Aeq. Math.*, 19, 194-226.
- Longo, G. & Montevil, M. (2011). The Inert vs. the living state of matter: extended criticality, time geometry, anti-entropy - an overview. *Frontiers in Physiology*, *Frontiers*, 3, (39).
<https://doi.org/10.3389/fphys.2012.00039>
- Moisil, Gr. C. (1965). *Old and New essays on non-classical logics*. Bucharest: Ed. Stiintifica.
- Moisil, Gr. C. (1972). *Essai sur les logiques non-chrysippiennes*. Bucharest: Ed. Academiei.
- Moisil, Gr. C. (1975). *Lectures on the logic of fuzzy reasoning*. Bucharest: Ed. Stiintifica.
- Patrascu, V. (2013). *Neutrosophic information in the framework of multivalued representation*. The 21th Conference on Applied and Industrial Mathematics, CAIM 2013, Bucharest, Romania, September 19-22.
- Patrascu, V. (2014). Multi-valued representation of neutrosophic information. *Proceedings of the 14th International Conference on Information Processing and Management of Uncertainty in Knowledge-Based Systems (IPMU'14)*, Montpellier, France, Volume Part I, CCIS 442, pp. 304-316, Springer International Publishing Switzerland.
- Patrascu, V. (2008). A new penta-valued logic based knowledge representation. *Proc. of the 12th Inter. Conf. on Information Processing and Management of Uncertainty in Knowledge-Based Systems (IPMU'08)*, pp. 17-22, Malaga, Spain.
- Patrascu, V. (2012). Bi-fuzziness, incompleteness, inconsistency, truth and falsity based on saturation and ignorance functions. A New Approach of Penta-Valued Knowledge Representation. *The 23rd Midwest Artificial Intelligence and Cognitive Science Conference MAICS 2012*, pp. 112-118, Cincinnati, OH, USA.
- Smarandache, F. (1999). *A unifying field in logics: Neutrosophic logic. Neutrosophy, neutrosophic set, probability, and statistics*. Rehoboth: American Research Press.
- Smarandache, F. (2002). A unifying field in logics: Neutrosophic logic. *Multiple-valued Logic, An international journal*, 8(3), 385-438.
- Smarandache, F. (2005). Neutrosophic Set - A Generalization of the intuitionistic fuzzy set. *International Journal of Pure and Applied Mathematics*, 24(3), 287-297.
- Smarandache, F. & Osman, S. (2007). *Neutrosophy in Arabic philosophy*. Renaissance High Press.
- Smarandache, F. & Christianto, V. (2009). n-Ary fuzzy logic and neutrosophic logic operators. *Studies in Logic, Grammar and Rethoric*, 17(30), 127-143.
- Smarandache, F. (2009). N-Norm and N-Conorm in Neutrosophic Logic and Set, and the Neutrosophic Topologies. *Technical Sciences and Applied Mathematics, AFA Journal*, 5-11.
- Smarandache, F. (2010). Neutrosophic Set - A Generalization of the intuitionistic fuzzy set. *Journal of Defense Resources Management*, 1(1), 107-116.
- Smarandache, F. (2013). n-Valued Refined Neutrosophic Logic and Its Applications to Physics. *Progress in Physics*, 4, 143-146.
- Smarandache, F. (2013). Neutrosophic measure and neutrosophic integral. *Neutrosophic Sets and Systems*, 1, 3-7.
- L. Zadeh, L. (1965). Fuzzy sets. *Information and Control*, 8, 338-353.

A Lattice Theoretic Look: A Negated Approach to Adjectival (Intersective, Neutrosophic and Private) Phrases and More

Selçuk Topal^{1*} and Florentin Smarandache²

1* Department of Mathematics, Bitlis Eren University, Bitlis, 35100, TURKEY. s.topal@beu.edu.tr

2 Mathematics & Science Department, University of New Mexico, 7||05 Gurley Ave., Gallup, NM 87301, USA. smarand@unm.edu

Corresponding author's email^{1*}: s.topal@beu.edu.tr

ABSTRACT

This paper is an extended version of "A Lattice Theoretic Look: A Negated Approach to Adjectival (Intersective, Neutrosophic and Private) Phrases" in INISTA 2017. Firstly, some new negations of intersective adjectival phrases and their set-theoretic semantics such as non-red non-cars and red non-cars are presented. Secondly, a lattice structure is built on positive and negative nouns and their positive and negative intersective adjectival phrases. Thirdly, a richer lattice is obtained from previous one by adding neutrosophic prefixes neut and anti to intersective adjectival phrases. Finally, the richest lattice is constructed via extending the previous lattice structures by private adjectives (fake, counterfeit). These lattice classes are called Neutrosophic Linguistic Lattices (NLL). In the last part of the paper (Section 4 does not take place in the paper introduced in INISTA 2017), noun and adjective based positive and negative sub-lattices of NLL are introduced.

KEYWORDS: Logic of natural languages; neutrosophy; pre-orders, orders and lattices; adjectives; noun phrases; negation

1. INTRODUCTION

Lattice theory, one of the fundamental sub-fields of the foundations of mathematics and mathematical logic, is a powerful tool of many areas such as Linguistics, Chemistry, Physics, and Information Science. In information science, it is essential to make data understandable and meaningful. Mathematical structures are the most effective tools for transferring human natural phrases and sentences to computer environment as meaningful data. Especially, with a set theoretical view, lattice applications of mathematical models in linguistics are a common occurrence. Fundamentally, Natural Logic (Moss, 2010), (van Benthem, 2008) is a human reasoning discipline that explores inference patterns and logics in natural language. These patterns and logics are constructed on relations between syntax and semantics of sentences and phrases. In order to explore and identify the entailment relations among sentences by mathematical structures, it is first necessary to determine the relations between words and clauses themselves. We would like to find new connections between natural logic and neutrosophic by discovering the phrases and neutrosophic clauses. In this sense, we will associate phrases and negated phrases to neutrosophic concepts. Recently, a theory called Neutrosophy, introduced by Smarandache (Smarandache, 1998, 2004,2015) has widespread mathematics, philosophy and applied sciences coverage. Mathematically, it offers a system which is an extension of intuitionistic fuzzy system. Neutrosophy considers an entity, A in relation to its opposite, $anti-A$ and that which is *not* A , $non-A$, and that which is neither A nor $anti-A$, denoted by $neut-A$. Up to section 3.3, we will obtain various negated versions of phrases (intersective adjectival) because Neutrosophy considers opposite property of concepts and we would like to associate the phrases and Neutrosophic phrases. We will present the first *NLL* in section 3.3. Notice that all models and interpretations of phrases will be finite throughout the paper. The research problem of this paper is to put forth lattice structures of neutrosophic phrases for purpose of exploring relations between the phrases on the mathematical level. The results of the paper may help to prove soundness and completeness theorems of possible logics obtained by sentences formed by neutrosophic phrases. The original contribution of this paper is that none of the

lattices and sub-lattices of such phrases have never been studied. Relevant studies have not gone beyond simple names and adjectives (intersective and private). The phrases allow us to study the details of lattice theory, in addition to lattices such as sub-lattices and even ideals and filters because the expressive power of neutrosophic phrases present much richer structures.

2. NEGATING INTERSECTIVE ADJECTIVAL PHRASES

Phrases such as *red cars* can be interpreted the intersection of the set of *red things* with the set of *cars* and get the set of *red cars*. In the sense of model-theoretic semantics, the interpretation of a phrase such as *red cars* would be the intersection of the interpretation of *cars* with a set of *red individuals* (the region *b* in Figure 1). Such adjectives are called intersective adjectives or intersecting adjectives. As to negational interpretation, Keenan and Faltz told that “similarly, intersective adjectives, like common nouns, are negatable by non-: non-Albanian (cf. non-student) “in their book (Keenan & Faltz, 2012). In this sense, *non-red cars* would interpret the intersection of the of *non-red things* and the set of *cars*. Negating intersective adjectives without nouns (*red things*) would be complements of the set of *red things*, in other words, *non-red things*. We mean by “*non-red things*”: the things are which are *not red*. Remark that the conceptual field of “*non-red things*” does not guarantee that *these individuals* have to have a color property or something else. It is changeable under incorporating situations, but we will might say something about it in another paper. On the other hand, negating nouns (*cars*) would be complements of the set of *cars*, in other words, *non-cars*. We mean by non-cars that the things are which are not cars. Adhering to the spirit of intersective adjectivity, we can explore new meanings and their interpretations from negated intersective adjectival phrases by intersecting negated (or not) adjectives with negated (or not) nouns. As was in the book, *non-red cars* is the intersection the set of things that are not red with cars. In other words, *non-red cars* are the cars but not red (the region *c* in Figure 1). Another candidate for the negated case, *non-red non-cars* refers to intersect the set of non-red things (things that are not red) with non-cars (the region *d* in Figure 1). The last one, *red non-cars* has meaning that is the set of intersection of the set of red things and the set of non-cars (the region *a* in Figure 1). $\overline{red}x$ is called *noun level partially semantic complement*. $\overline{red}x$ is called *adjective level partially semantic complement*. $\overline{red}x$ is called *full phrasal semantic complement*. In summary, we obtain *non-red cars*, *red non-cars* and *non-red non-cars* from *red cars* we already had.

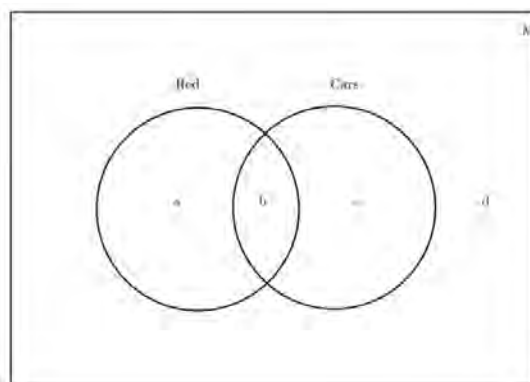

Fig. 1: An example of *cars* and *red* in a discourse universe

The intersective theory and conjunctives suit well into Boolean semantics (Keenan & Faltz, 2012), (Roelofsen, 2013) which proposes very close relationship between *and* and *or* in natural language, as conjunction and disjunction in propositional and predicate logics that have been applied to natural language semantics. In these logics, the relationship between conjunction and disjunction corresponds to the relationship between the set-theoretic notions of intersection and union (Champollion, 2016), (Hardegree, 1994). On the other hand, correlative conjunctions might help to interpret negated intersective adjectival phrases within Boolean semantics because the conjunctions are paired conjunctions (neither/nor, either/or, both/and,) that link words, phrases, and clauses. We might reassessment those negated intersective adjectival phrases in perspective of correlative conjunctions. “*neither A nor B* “and “*both non-A and non-*

"B" can be used interchangeably where A is an intersective adjective and B is a noun. Therefore, we say "neither red (things) nor pencils" and "both non-red (things) and non-pencils" equivalent sentences. An evidence for the interchangeability comes from equivalent statements in propositional logic, that is, $\neg(R \vee C)$ is logically equivalent to $\neg R \wedge \neg C$ (Champollion, 2016). Other negated statements would be $\neg R \wedge C$ and $R \wedge \neg C$. Semantically, $\neg R \wedge \neg C$ is full phrasal semantic complement of $R \vee C$, and also $\neg R \wedge C$ and $R \wedge \neg C$ are partially semantic complements of $R \vee C$. We will explore full and partially semantic complements of several adjectival phrases. We will generally negate the phrases and nouns by adding prefix "non", "anti" and "neut". We will use interpretation function $[[\]]$ from set of phrases (Ph) to power set of universe ($P(M)$) (set of individuals) to express phrases with understanding of a set-theoretic viewpoint. Hence, $[[p]] \subseteq M$ for every $p \in Ph$. For an adjective (negated or not) and a plural noun n (negated or not, $a n$ will be interpreted as $[[a]] \cap [[n]]$). If n is a positive plural noun, $non-n$ is interpreted as $[[non - n]] = \overline{[[n]]} = M \setminus [[n]]$ and, similarly, if a is a positive adjective, $non-a$ is interpreted as $[[non - a]] = \overline{[[a]]} = M \setminus [[a]]$. When we will add *non-to* both nouns and adjectives as prefix, "anti" and "neut" will be added in front of only adjectives. Some adjectives themselves have negational meaning such as *fake*. Semantics of phrases with *anti*, *neut* and *fake* will be mentioned in next sections.

3. LATTICE THEORETIC LOOK

We will give some fundamental definitions before we start to construct lattice structures from these adjectival phrases. A lattice is an algebraic structure that consists of a partially ordered set in which every two elements have a unique supremum (a least upper bound or join) and a unique infimum (a greatest lower bound or meet) (Davey & Priestley, 2002). The most classical example is on sets by interpreting set intersection as meet and union as join. For any set A , the power set of A can be ordered via subset inclusion to obtain a lattice bounded by A and the empty set. We will give two new definitions in subsection 3.2 to begin constructing lattice structures.

Remark 1. We will use the letter a and *red* for intersective adjectives, and the letter x , n and *cars* for common plural nouns in the name of abbreviation and space saving throughout the paper.

3.1 Individuals

Each element of $[[a x]]$ and $[[\overline{a} x]]$ is a distinct individual and belongs to $[[x]]$. It is already known that $[[a x]] \cap [[\overline{a} x]] = \emptyset$ and $[[a x]] \cup [[\overline{a} x]] = [[x]]$. It means that no common elements exist in $[[a x]]$ and $[[\overline{a} x]]$. Hence, every element of these sets can be considered as individual objects such as Larry, John, Meg, ... etc. Uchida and Cassimatis (Uchida & Cassimatis, 2014) already gave a lattice structure on power set of all of individuals (a domain or a universe).

3.2. Lattice \mathcal{L}_{IA}

Intersective adjectives (*red*) provide some properties for nouns (*cars*). Excluding (complementing) a property from an intersective adjective phrase also provide another property for nouns. In this direction, "*red*" is a property for a noun, "*non-red*" is another property for the noun as well. *red* and *non-red* have discrete meaning and sets as can be seen in Figure 1. Naturally, every set of restricted objects with a

property (*red cars*) is a subset of those objects without the properties (*cars*). $[[red x]]$ and $[[\overline{red} x]]$ are always subsets of $[[x]]$. Neither $[[red x]] \leq_* [[\overline{red} x]]$ nor $[[\overline{red} x]] \leq_* [[red x]]$ since

$[[red x]] \cap [[\overline{red} x]]$ by assuming $[[\overline{red} x]] \neq \emptyset$ and $[[red x]] \neq \emptyset$. Without loss of generality, for

negative (complement) of the noun x and the intersective adjective red (positive and negative) are $\bar{x}, red \bar{x}$ and $\bar{red} \bar{x}$. $[[red \bar{x}]]$ and $[[\bar{red} \bar{x}]]$ are always subsets of $[[\bar{x}]]$. Neither $[[red \bar{x}]] \leq_* [[\bar{red} \bar{x}]]$ nor $[[\bar{red} \bar{x}] \leq_* [[red \bar{x}]]$ since $[[red \bar{x}]] \cap [[\bar{red} \bar{x}]] = \emptyset$ by assuming $[[red \bar{x}]] \neq \emptyset$ and $[[\bar{red} \bar{x}]] \neq \emptyset$. On the other hand, $[[x]] \cap [[\bar{x}]] = \emptyset$ and $[[x]] \cup^* [[\bar{x}]] = M$ (M is the universe of discourse) and also $[[red x]], [[\bar{red} x]], [[red \bar{x}]]$ and $[[\bar{red} \bar{x}]]$ are by two discrete. We do not allow $[[red x]] \cup^* [[\bar{red} x]]$ and $[[red x]] \cup^* [[\bar{red} \bar{x}]]$ and $[[\bar{red} x]] \cup^* [[red \bar{x}]]$ and $[[red \bar{x}]] \cup^* [[\bar{red} \bar{x}]]$ to take places in the lattice in Figure 2 because we try to build the lattice from phrases only in our language. To do this, we define a set operation \cup^* and an order relation \leq_* as follows:

Definition 2. We define a binary set operator \cup^* for our languages as the follow: Let S be a set of sets and $A, B \in S$. $A \cup^* B = C \Leftrightarrow C$ is the smallest set which includes both A and B , and also $C \in S$.

Definition 3. We define a partial order \leq_* on sets as the follow:

$$A \leq_* B \text{ if } B = A \cup^* B$$

$$A \leq_* B \text{ if } A = A \cap B$$

Example 4. Let $A = \{1, 2\}, B = \{2, 3\}, C = \{1, 2, 4\}, D = \{1, 2, 3, 4\}$ and $S = \{A, B, C, D\}$.

$$A \cup^* A = A, A \cup^* C = C, A \cup^* B = D, B \cup^* C = D, C \cup^* D = D, C \leq_* C, A \leq_* C, A \leq_* D, B \leq_* D, C \leq_* D.$$

Notice that \leq_* is a reflexive, transitive relation (pre-order) and \cup^* is a reflexive, symmetric relation.

Figure 3 illustrates a diagram on $cars$ and red . The diagram does not contain sets $\{b, d\}, \{a, b\}, \{a, c\}$ and $\{c, d\}$ because the sets do not represent linguistically any phrases in the language. Because of this reason,

$\{a\} \cup^* \{c\}$ and $\{a\} \cup^* \{b\}$ and $\{d\} \cup^* \{c\}$ and $\{a, b, c, d\} = M$. This structure builds a lattice up by \cup^* and \cap that is the classical set intersection operation.

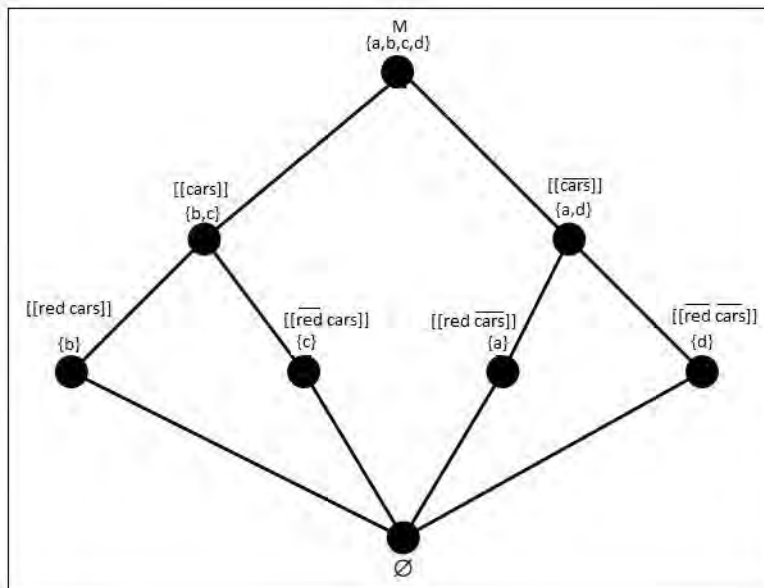

Fig. 2: Lattice on cars and red

$\mathcal{L}_{IA} = (L, \emptyset, \cap, \cup^*)$ is a lattice where $L = \{M, x, \bar{x}, red\ x, red\ \bar{x}, red\ \bar{\bar{x}}, red\ \bar{\bar{\bar{x}}}\}$. Remark that

$\mathcal{L}_{IA} = (L, \emptyset, \cap, \cup^*) = (L, \emptyset, \leq_*)$. We call this lattice briefly \mathcal{L}_{IA} .

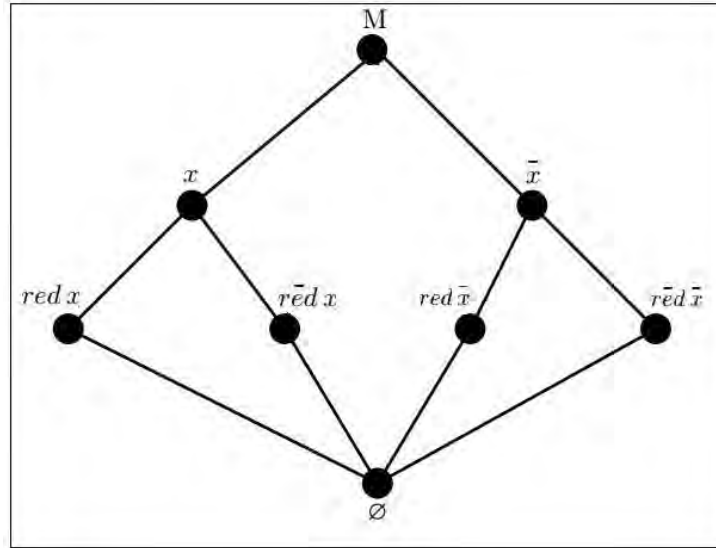

Fig. 3: Hasse Diagram of lattice of $\mathcal{L}_{IA} = (L, \emptyset, \cap, \cup^*)$

3.3 Lattice \mathcal{L}_{IA}^N

In this section, we present first NLL. [4] Let A be the color white. Then,

$$non - A = \{black, red, yellow, blue, \dots\},$$

anti-A points at black, and

$$neut - A = \{red, yellow, blue, \dots\}.$$

In our interpretation base, anti-black cars ($black\ cars^a$) is a specific set of cars which is a subset of set non-black cars ($black\ cars^{\bar{}}$). neut-black cars ($black\ cars^n$) is a subset of $black\ cars^{\bar{}}$ which is obtained by excluding sets black cars and $black\ cars^a$ from $black\ cars^{\bar{}}$. Similarly, anti-black cars ($black\ cars^{\bar{a}}$) is a specific set of $cars^{\bar{}}$ which is a subset of set non-black non-cars ($black\ cars^{\bar{\bar{}}}$). $neut - black\ cars^{\bar{}}$ ($black\ cars^{\bar{n}}$) is a subset of $black\ cars^{\bar{\bar{}}}$ which is obtained by excluding sets of $black\ cars^{\bar{}}$ and $black\ cars^{\bar{a}}$ from $black\ cars^{\bar{\bar{}}}$. The new structure represents an extended lattice equipped with \leq_* as can be seen in Figure 4. We call this lattice \mathcal{L}_{IA}^N .

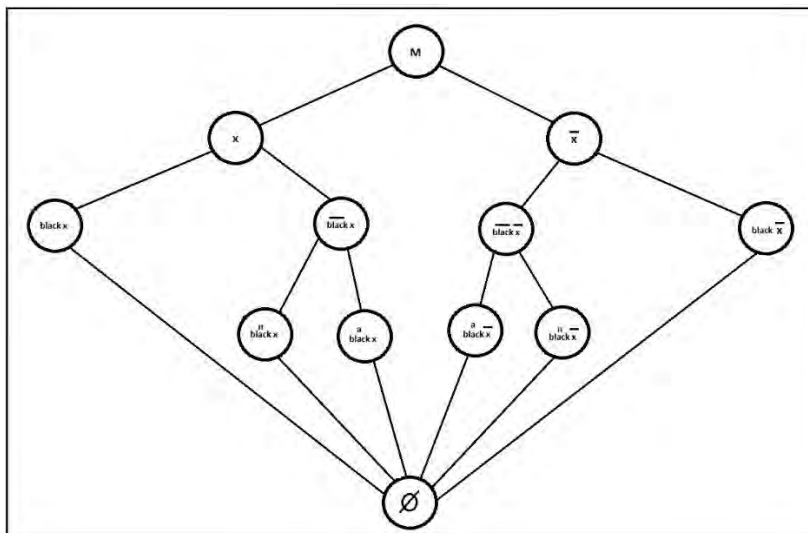

Fig. 4: The Lattice \mathcal{L}_{IA}^N

3.4 Lattice $\mathcal{L}_{IA}^N(F)$

Another *NLL* is an extended version of \mathcal{L}_{IA}^N by private adjectives. Those adjectives have negative effects on nouns such fake and counterfeit. The adjectives are representative elements of, called private, a special class of adjectives (Chatzikyriakidis & Luo, 2013), (Partee, 2007), (Hoffher & Matushansky 2010).

Chatzikyriakidis and Luo (Chatzikyriakidis & Luo, 2013), treated transition from the adjectival phrase to noun as *Private Adj(N) ⇒ ¬N* in inferential base. Furthermore, they gave an equivalence: “

real_gun(g) if and only if “*¬fake_gun(g)* where $[[g \text{ is a real gun}]] = \text{real_gun}(g)$ and

$[[f \text{ is not a real gun}]] = \neg \text{real_gun}(f)$ in order to constitute a modern type-theoretical setting.

Considering these facts, fake car is not a car (real) and plural form: fake cars are not cars. Hence, set of fake cars is a subset of set of non-cars in our treatment. On the one hand, compositions with private adjectives and intersective adjectival phrases do not affect the intersective adjectives negatively but nouns as usual. Then, interpretation of “fake red cars” would be intersection of set of red things and set of non-cars. Applying “non” to private adjectival phrases,

non-fake cars are cars(real), $[[\text{non} - \text{fake cars}]] = [[\text{cars}]]$ whereas $[[\text{fake cars}]] \subseteq [[\text{non} - \text{cars}]]$.

non-fake cars will be not given a place in the lattice. Remark that phrase “non-fake non-cars” is ambiguous since fake is not a intersective adjective. We will not consider this phrase in our lattice. x is incomparable

both $\overline{\text{black } x}$ and $\overline{\text{black } \overline{x}}$ except \overline{x} as can be seen in Figure 5. So, we cannot determine that set of *fake cars* is a subset or superset of a set of any adjectival phrases. But we know that

$[[\text{fake cars}]] \subseteq [[\text{non} - \text{cars}]]$. Then, we can see easily $[[\text{fake black cars}]] \subseteq [[\text{blacks non} - \text{cars}]]$ by

using $[[\text{fake cars}]] \cap [[\text{black things}]] \subseteq [[\text{cars}]] \cap [[\text{black things}]]$. Without loss of generality, set of

fake black cars is a subset of set *black non-cars* and also set of fake *non-black cars* is a subset of set *non-black non-cars*. Continuing with neut and anti, set of *fake neut black cars* is a subset of set of neut *black non-cars* and also *fake anti-black cars* is a subset of set of *anti-black non-cars*. These phrases build the

lattice $\mathcal{L}_{IA}^N(F)$ in Fig. 5.

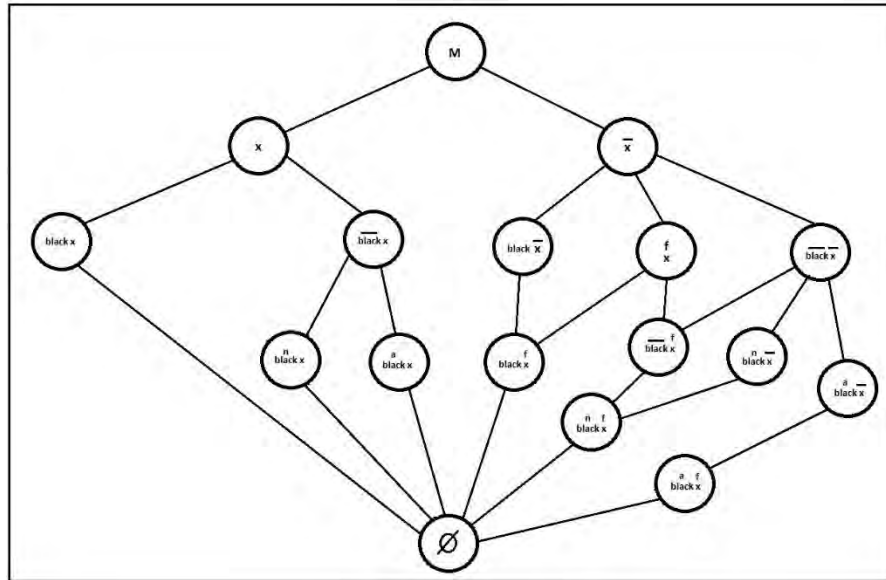

Fig. 5: The lattice $\mathcal{L}_{IA}^N(F)$

Notice that if M and empty set are removed from the structures, the structures will lose of the feature of lattice. The structures will be hold neither join nor meet semi-lattice property as well. On the other hand, set of $\{black\ x, black\ x, black\ x, black\ x\}$ equipped with \leq_* is the only one sub-lattice of $\mathcal{L}_{IA}^N(F)$ without using M and empty set.

4. NOUN AND ADJECTIVE BASED POSITIVE AND NEGATIVE SUB-LATTICES

In this section, we introduce some new concepts and definitions of sub-lattices of $\mathcal{L}_{IA}^N(F)$.

Definition 5. Noun based positive sub-lattice (NBPSL): An NBPSL is a sub-lattice of $\mathcal{L}_{IA}^N(F)$ which consists of positive noun phrases, and M and \emptyset only.

Remark 6. As can be seen in Fig. 6, elements of the biggest NBPSL lattice of $\mathcal{L}_{IA}^N(F)$ consists of $M, x, black\ x, black\ x, black\ x, black\ x$ and \emptyset .

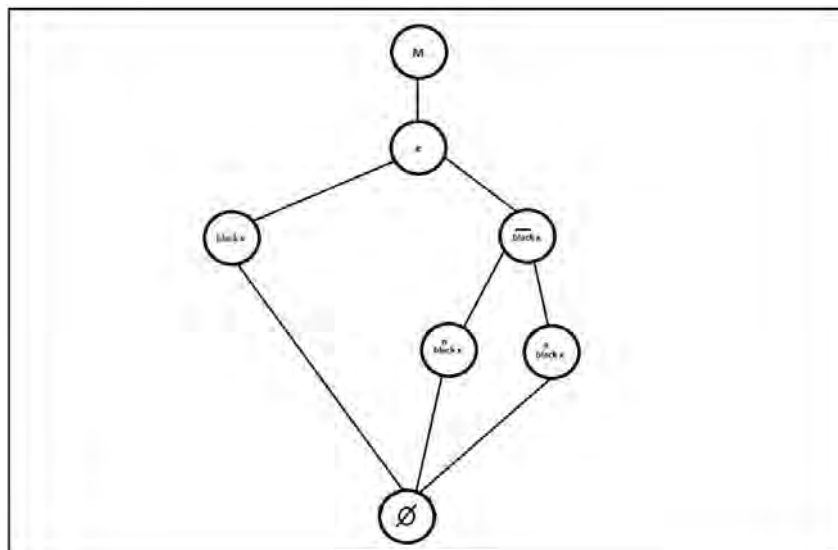

Fig. 6: The biggest NBNSL sub-lattice of $\mathcal{L}_{IA}^N(F)$

Definition 7. Noun based negative sub-lattice (NBPSL): An *NBPSL* is a sub-lattice of $\mathcal{L}_{IA}^N(F)$ which consists of negative noun phrases, and M and \emptyset only.

Remark 8. x is a positive noun and both $\overset{f}{x}$ and $\overset{-}{x}$ are negative nouns.

Remark 9. As can be seen in Fig. 7, elements of the biggest *NBNSL* sub-lattice of $\mathcal{L}_{IA}^N(F)$ consists of $M, \overset{f}{x}, \overset{-}{x}, \overset{n}{black} \overset{f}{x}, \overset{-}{black} \overset{f}{x}, \overset{n}{black} \overset{-}{x}, \overset{-}{black} \overset{-}{x}, \overset{f}{black} \overset{-}{x}, \overset{-}{black} \overset{-}{x}$ and \emptyset .

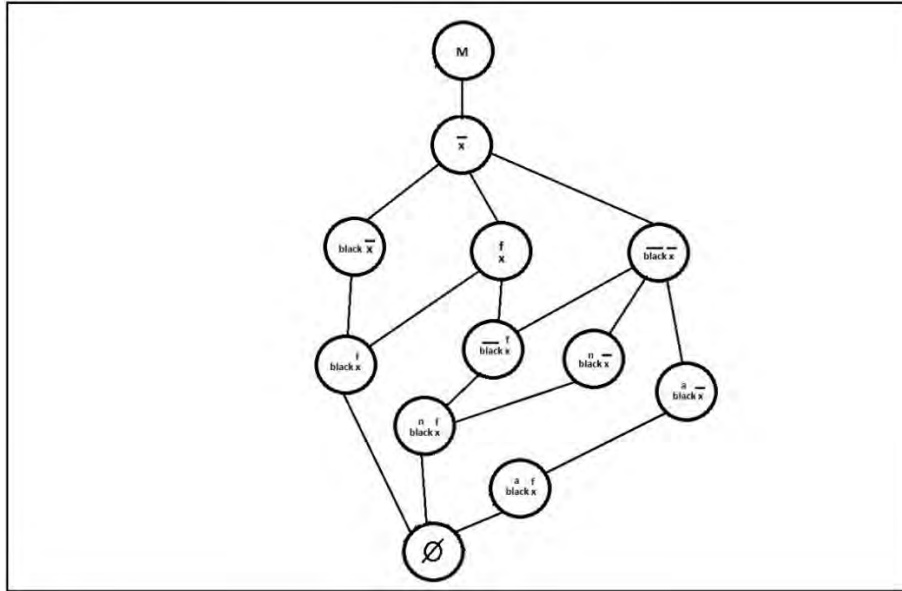

Fig. 7: The biggest NBNSL sub-lattice of $\mathcal{L}_{IA}^N(F)$

Definition 10. Adjective based positive sub-lattice (ABPSL): An *ABPSL* is a sub-lattice of $\mathcal{L}_{IA}^N(F)$ which consists of noun phrases with positive adjectives, and M and \emptyset only.

Remark 11. *black* is a positive adjective. $\overset{-}{black}$, $\overset{a}{black}$ and $\overset{n}{black}$ are negative adjectives.

Remark 12. As can be seen in Fig. 8, elements of the biggest *ABPSL* sub-lattice of $\mathcal{L}_{IA}^N(F)$ consists of $M, \overset{f}{black} \overset{-}{x}, \overset{-}{black} \overset{-}{x}, \overset{f}{black} \overset{a}{x}$ and \emptyset .

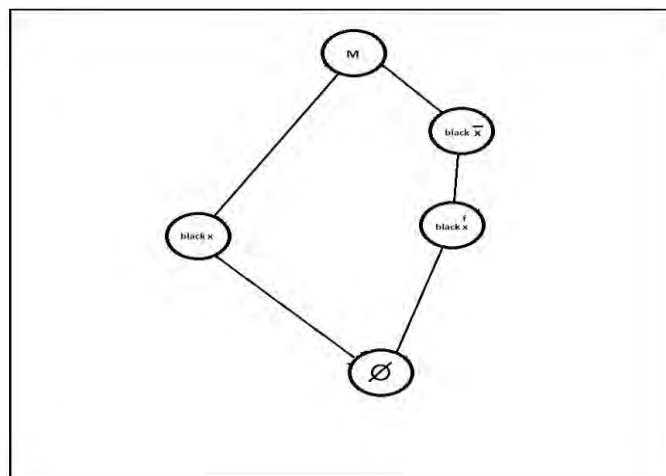

Fig. 8: The biggest ABPSL sub-lattice of $\mathcal{L}_{IA}^N(F)$

Definition 13. Adjective based negative sub-lattice (ABNSL): An **ABNSL** is a sub-lattice of $\mathcal{L}_{IA}^N(F)$ which consists of noun phrases with negative adjectives, and M and \emptyset only.

Remark 14. As can be seen in Fig. 9 elements of the biggest **ABNSL** lattice of $\mathcal{L}_{IA}^N(F)$ consists of M , $\overline{\text{black } x}$, ${}^n \text{black } x$, ${}^a \text{black } x$, $\overline{\text{fake } x}$, ${}^n \text{fake } x$, ${}^a \text{fake } x$, $\overline{\overline{\text{black } x}}$, ${}^n \overline{\text{black } x}$, ${}^a \overline{\text{black } x}$ and \emptyset .

Remark 15: Both NBPSL and NBNSL are both an ideal and a filter of $\mathcal{L}_{IA}^N(F)$.

Remark 16: Both ABPSL and ABNSL are both an ideal of $\mathcal{L}_{IA}^N(F)$ but not the filters.

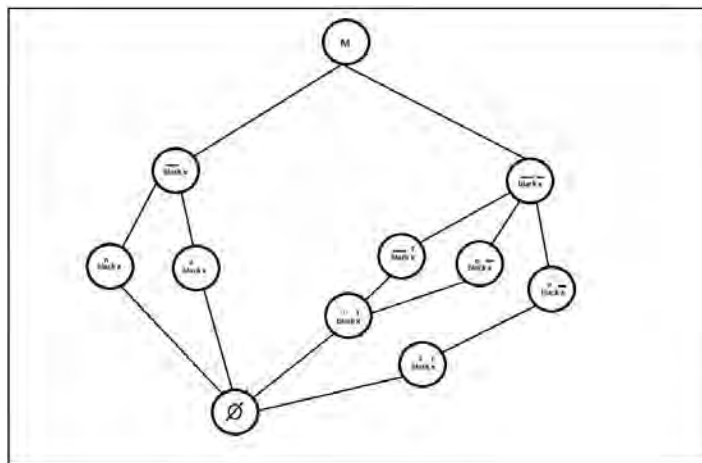

Fig. 9: The biggest **ABNSL** sub-lattice of $\mathcal{L}_{IA}^N(F)$

5. CONCLUSION AND FUTURE WORK

In this paper, we have proposed some new negated versions of set and model theoretical semantics of intersective adjectival phrases (plural). After we first have obtained the lattice structure \mathcal{L}_{IA} , two lattices \mathcal{L}_{IA}^N and $\mathcal{L}_{IA}^N(F)$ have been built from the proposed phrases by adding “neut”, “anti” and “fake” step by step. We also have introduced some sub-lattices of $\mathcal{L}_{IA}^N(F)$. Some of these sub-lattices are ideals and (or) filters of $\mathcal{L}_{IA}^N(F)$. It might be interesting that lattices in this paper can be extended with incorporating coordinates such as *light red cars* and *red cars*. Some decidable logics might be investigated by extending syllogistic logics with the phrases (Moss, 2010), (van Benthem, 2008), (van Rooij, 2010). Another possible work in future, this idea can be extended to complex neutrosophic set, bipolar neutrosophic set, interval neutrosophic set (Ali & Smarandache, 2017), (Deli, Ali & Smarandache, 2015), (Ali, Deli & Smarandache, 2015), (Thanh, Ali & Son, 2017). Another application of this paper could be on lattices of computable infinite sets (Çevik, 2016, 2013a, 2013b, 2012) if one considers domains on infinite sets. We hope that linguists, computer scientists and logicians might be interested in results in this paper and the results will help with other results in several areas.

REFERENCES

- Moss L.S. (2010). Natural Logic and Semantics. In: Aloni M., Bastiaanse H., de Jager T., Schulz K. (eds) Logic, Language and Meaning. Lecture Notes in Computer Science, vol 6042. Springer, Berlin, Heidelberg.
- Ali, M., & Smarandache, F. (2017). Complex neutrosophic set. *Neural Computing and Applications*, 28(7), 1817-1834.
- Ali, M., Deli, I., & Smarandache, F. (2016). The theory of neutrosophic cubic sets and their

applications in pattern recognition. *Journal of Intelligent & Fuzzy Systems*, 30(4), 1957-1963.

Çevik, A. (2012). *Hesaplanabilirlik Kuramı ve Turing Derecelerine Giriş*, Gaziosmanpaşa Üniversitesi Bilimsel Araştırma Dergisi, Volume 1, 1-20.

Çevik, A. (2013a). Antibasis theorems for classes and the jump hierarchy. *Archive for Mathematical Logic*, 1-6.

Çevik, A. (2013b). *On the possibility of supertasks*, Beytulhikme An International Journal of Philosophy, 5, 171-180.

Çevik, A. (2016). choice classes. *Mathematical Logic Quarterly*, 62(6), 563-574.

Champollion, L. (2016). Ten men and women got married today: Noun coordination and the intersective theory of conjunction. *Journal of Semantics*, 33(3), 561-622.

Chatzikyriakidis, S., & Luo, Z. (2013). *Adjectives in a modern type-theoretical setting*. In Formal Grammar (pp. 159-174). Springer Berlin Heidelberg.

Davey, B. A., & Priestley, H. A. (2002). *Introduction to lattices and order*. Cambridge university press.

Deli, I., Ali, M., & Smarandache, F. (2015, August). Bipolar neutrosophic sets and their application based on multi-criteria decision-making problems. In Advanced Mechatronic Systems (ICAMechS), 2015 International Conference on (pp. 249-254). IEEE.

Hardegree, G. M. (1994). *Symbolic logic: A first course*. McGraw-Hill.

Hoffner, P. C., & Matushansky, O. (Eds.). (2010). *Adjectives: formal analyses in syntax and semantics* (Vol. 153). John Benjamins Publishing.

Keenan, E. L., & Faltz, L. M. (2012). *Boolean semantics for natural language* (Vol. 23). Springer Science & Business Media.

Partee, B. (2007). Compositionality and coercion in semantics: The dynamics of adjective meaning. *Cognitive foundations of Interpretation*, 145-161.

Roelofsen, F. (2013). Algebraic foundations for the semantic treatment of inquisitive content. *Synthese*, 190(1), 79-102.

Smarandache, F. (1998). Invisible paradox. *Neutrosophy/Neutrosophic Probability, Set, and Logic*", Am. Res. Press, Rehoboth, 22-23.

Smarandache, F. (2004). Matter, antimatter, and unmatter. CDS-CERN (pp. 173-177). EXT-2005-142.

Smarandache, F. (2015). Neutrosophic actions, prevalence order, refinement of neutrosophic entities, and neutrosophic literal logical operators. A Publication of Society for Mathematics of Uncertainty, 11.

Thanh, N.D., Ali, M. & Son, (2017). A Novel Clustering Algorithm in a Neutrosophic Recommender System for Medical Diagnosis, L.H. Cogn Comput 9: 526. <https://doi.org/10.1007/s12559-017-9462-8>

- Abdel-Basset, M., Mohamed, M., Smarandache, F., & Chang, V. (2018). Neutrosophic Association Rule Mining Algorithm for Big Data Analysis. *Symmetry*, 10(4), 106.
- Abdel-Basset, M., & Mohamed, M. (2018). The Role of Single Valued Neutrosophic Sets and Rough Sets in Smart City: Imperfect and Incomplete Information Systems. *Measurement*. Volume 124, August 2018, Pages 47-55
- Abdel-Basset, M., Gunasekaran, M., Mohamed, M., & Smarandache, F. A novel method for solving the fully neutrosophic linear programming problems. *Neural Computing and Applications*, 1-11.
- Abdel-Basset, M., Manogaran, G., Gamal, A., & Smarandache, F. (2018). A hybrid approach of neutrosophic sets and DEMATEL method for developing supplier selection criteria. *Design Automation for Embedded Systems*, 1-22.
- Abdel-Basset, M., Mohamed, M., & Chang, V. (2018). NMCDA: A framework for evaluating cloud computing services. *Future Generation Computer Systems*, 86, 12-29.
- Abdel-Basset, M., Mohamed, M., Zhou, Y., & Hezam, I. (2017). Multi-criteria group decision making based on neutrosophic analytic hierarchy process. *Journal of Intelligent & Fuzzy Systems*, 33(6), 4055-4066.
- Abdel-Basset, M.; Mohamed, M.; Smarandache, F. An Extension of Neutrosophic AHP–SWOT Analysis for Strategic Planning and Decision-Making. *Symmetry* 2018, 10, 116.
- Uchida, H., & Cassimatis, N. L. (2014). Quantifiers as Terms and Lattice-Based Semantics. <https://pdfs.semanticscholar.org/9dbc/eb5c1175338f3b8dff285fb727bbdbcd8325.pdf>.
- van Benthem, J. (2008). A brief history of natural logic. London College Publications 9781904987444.
- van Rooij, R. (2010). Extending syllogistic reasoning. In *Logic, Language and Meaning* (pp. 124-132). Springer, Berlin, Heidelberg.
- Winter, Y., & Zwarts, J. (2012) On the event semantics of nominals and adjectives: The one argument hypothesis, *Proceedings of Sinn and Bedeutung*, 16.

Neutrosophic theory and applications have been expanding in all directions at an astonishing rate especially after the introduction the journal entitled “Neutrosophic Sets and Systems”. New theories, techniques, algorithms have been rapidly developed. One of the most striking trends in the neutrosophic theory is the hybridization of neutrosophic set with other potential sets such as rough set, bipolar set, soft set, hesitant fuzzy set, etc. The different hybrid structure such as rough neutrosophic set, single valued neutrosophic rough set, bipolar neutrosophic set, single valued neutrosophic hesitant fuzzy set, etc. are proposed in the literature in a short period of time. Neutrosophic set has been a very important tool in all various areas of data mining, decision making, engineering, social sciences, and some more.

The second volume of “New Trends in Neutrosophic Theories and Applications” focuses on theories, methods, algorithms for decision making and also applications involving neutrosophic information. Some topics deal with data mining, decision making, graph theory, probability theory, topology, and some more.

ISBN 978-1-59973-559-7



9 781599 735597 >