

Florentin Smarandache

Neutrosophic Precalculus

and

Neutrosophic Calculus

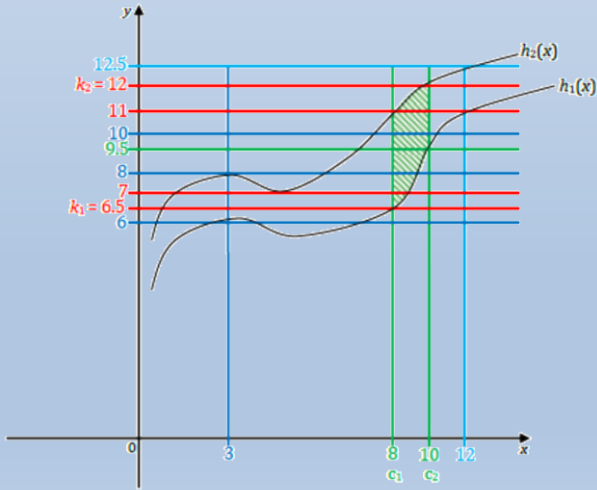

Florentin Smarandache

Neutrosophic Precalculus and Neutrosophic Calculus

EuropaNova
Brussels, 2015

EuropaNova asbl
Clos du Parnasse, 3E
1000, Bruxelles
Belgium
E-mail: info@europanova.be
<http://www.europanova.be/>

ISBN: 978-1-59973-352-4
© EuropaNova asbl,
The Author, 2015.

Peer Reviewers:

Mumtaz Ali
Department of Mathematics
Quaid-i-Azam University
Islamabad, 44000
Pakistan

Said Broumi
University of Hassan II
Faculty of Arts and Humanities
Hay El Baraka Ben M'sik
Casablanca B. P. 7951
Morocco

Dr. Azeddine Elhassouny
Département de Génie logiciel
ENSIAS
Avenue Mohammed Ben
Abdallah Regragui
Madinat Al Irfane, BP 713
Agdal Rabat
Morocco

Florentin Smarandache

Neutrosophic Precalculus
and
Neutrosophic Calculus

EuropaNova

Brussels, 2015

On the frontcover: Example for the Neutrosophic
Intermediate Value Theorem

DTP:

Octavian Blaga

SCȘ AdSumus

D. Cantemir, 13

410473, Oradea, Romania

E-mail: ad.sumus@laposte.net

Contents

<i>I. Introductory Remarks</i>	7
I.1. Overview.....	8
I.2. Preliminary.....	9
I.3. Distinctions among Interval Analysis, Set Analysis, and Neutrosophic Analysis.....	11
Notation.....	11
Interval Analysis.....	11
Set Analysis.....	11
Distinctions among Interval Analysis, Set Analysis, and Neutrosophic Analysis.....	12
Examples of Neutrosophic Analysis.....	12
Examples in Set Analysis.....	13
Examples in Interval Analysis.....	14
Inclusion Isotonicity.....	15
Conclusion.....	16
References.....	16
I.4. Indeterminate Elementary Geometrical Measurements.....	17
I.5. Indeterminate Physical Laws.....	20
<i>II. Neutrosophic Precalculus</i>	21
II.1. Algebraic Operations with Sets.....	22
II.2. Neutrosophic Subset Relation.....	23
II.3. Neutrosophic Subset Function.....	24
II.4. Neutrosophic Crisp Function.....	26
II.5. General Neutrosophic Function.....	27
II.6. Neutrosophic (Subset or Crisp) Function.....	28
Examples.....	28
II.7. Discrete and Non-Discrete Indeterminacy.....	36
II.8. Neutrosophic Vector-Valued Functions of Many Variables.....	37
II.9. Neutrosophic Implicit Functions.....	38
II.10. Composition of Neutrosophic Functions.....	39
II.11. Inverse Neutrosophic Function.....	41
Proposition.....	42
II.12. Zero of a Neutrosophic Function.....	46
II.13. Indeterminacies of a Function.....	47
II.14. Neutrosophic Even Function.....	48
II.15. Neutrosophic Odd Function.....	50
II.16. Neutrosophic Model.....	52
II.17. Neutrosophic Correlation Coefficient.....	53
II.18. Neutrosophic Exponential Function.....	54

II.19. Neutrosophic Logarithmic Function.....	56
II.20. Indeterminacy of the Composition of Neutrosophic Functions	58
<i>III. Neutrosophic Calculus</i>	<i>59</i>
III.1. Neutrosophic Limit	60
Norm.....	61
III.2. Appropriateness Partial-Distance (Partial-Metric).....	63
III.3. Properties of the Appropriateness Partial-Distance.....	64
III.4. Partial-Metric Space.....	66
III.5. $\varepsilon - \delta$ Definition of the Neutrosophic Limit.....	67
III.6. Example of Calculating the Neutrosophic Limit.....	68
III.7. Particular Case of Calculating the Neutrosophic Limit	69
III.8. Computing a Neutrosophic Limit Analytically	71
III.9. Calculating a Neutrosophic Limit Using the Rationalizing Technique	74
III.10. Neutrosophic Mereo-Continuity.....	76
III.11. Neutrosophic Continuous Function	77
III.12. Neutrosophic Intermediate Value Theorem	78
III.13. Example for the Neutrosophic Intermediate Value Theorem	79
III.14. Example for the Extended Intermediate Value Theorem	80
Remark.....	80
III.15. Properties of Neutrosophic Mereo-Continuity	82
Proof	82
Proofs.....	82
III.16. Properties of Neutrosophic Continuity.....	86
III.17. The M- δ Definitions of the Neutrosophic Infinite Limits	89
III.18. Examples of Neutrosophic Infinite Limits.....	90
III.19. Set-Argument Set-Values Function.....	93
III.20. Neutrosophic Derivative.....	94
III.21. Neutrosophic Indefinite Integral	98
III.22. Neutrosophic Definite Integral.....	100
III.23. Simple Definition of Neutrosophic Definite Integral.....	102
III.24. General Definition of Neutrosophic Definite Integral.....	103
<i>IV. Conclusion</i>	<i>104</i>
<i>V. References</i>	<i>106</i>
Published Papers and Books	107
Other Articles on Neutrosophics	113
Presentations to International Conferences or Seminars	150
Ph. D. Dissertations	153

I. Introductory Remarks

I.1. Overview

Neutrosophy means the study of ideas and notions that are not true, nor false, but in between (i.e. neutral, indeterminate, unclear, vague, ambiguous, incomplete, contradictory, etc.).

Each field has a neutrosophic part, i.e. that part that has indeterminacy. Thus, there were born the neutrosophic logic, neutrosophic set, neutrosophic probability, neutrosophic statistics, neutrosophic measure, neutrosophic precalculus, neutrosophic calculus, etc.

There exist many types of indeterminacies – that's why neutrosophy can be developed in many different ways.

I.2. Preliminary

The first part of this book focuses on *Neutrosophic Precalculus*, which studies the neutrosophic functions. A *Neutrosophic Function* $f: A \rightarrow B$ is a function which has some indeterminacy, with respect to its domain of definition, to its range, or to its relationship that associates elements in A with elements in B .

As particular cases, we present the *neutrosophic exponential function* and *neutrosophic logarithmic function*. The *neutrosophic inverse function* is the inverse of a neutrosophic function.

A *Neutrosophic Model* is, in the same way, a model with some indeterminacy (vagueness, unsureness, ambiguity, incompleteness, contradiction, etc.).

*

The second part of the book focuses on *Neutrosophic Calculus*, which studies the neutrosophic limits, neutrosophic derivatives, and neutrosophic integrals.

*

We introduce for the first time the notions of *neutrosophic mereo-limit*, *mereo-continuity*, *mereo-derivative*, and *mereo-integral*,¹ besides the classical

¹ From the Greek μέρος, 'part'. It is also used to define the theory of the relations of part to whole and the relations of part to part within a whole (mereology), started by Leśniewski, in "Foundations of the General Theory of Sets" (1916) and "Foundations of Mathematics" (1927-1931), continued by Leonard and Goodman's "The Calculus of Individuals" (1940),

definitions of limit, continuity, derivative, and integral respectively.

*

The *Neutrosophic Precalculus* and *Neutrosophic Calculus* can be developed in many ways, depending on the types of indeterminacy one has and on the method used to deal with such indeterminacy.

In this book, we present a few examples of indeterminacies and several methods to deal with these specific indeterminacies, but many other indeterminacies there exist in our everyday life, and they have to be studied and resolved using similar of different methods. Therefore, more research has to be done in the field of neutrosophics.

I.3. Distinctions among Interval Analysis, Set Analysis, and Neutrosophic Analysis

Notation

In this book we consider that an interval $[a, b] = [b, a]$ in the case when we do not know which one between a and b is bigger, or for the case when the interval has varying left and right limits of the form $[f(x), g(x)]$, where for certain x 's one has $f(x) < g(x)$ and for other x 's one has $f(x) > g(x)$.

Interval Analysis

In **Interval Analysis** (or Interval Arithmetic) one works with intervals instead of crisp numbers. Interval analysis is intended for rounding up and down errors of calculations. So an error is bounding by a closed interval.

Set Analysis

If one replaces the closed intervals (from interval analysis) by a set, one get a **Set Analysis** (or Set Arithmetic).

For example, the set-argument set-value function:

$$h: P(\mathbb{R}) \rightarrow P(\mathbb{R}), \quad (1)$$

where $P(\mathbb{R})$ is the power set of \mathbb{R} (the set of all real numbers),

$$h(\{1, 2, 3\}) = \{7, 9\}, h([0, 1]) = (6, 8), h(-3) = \{-1, -2\} \cup (2.5, 8], h([x, x^2] \cup [-x^2, x]) = 0. \quad (2)$$

Set analysis is a generalization of the interval analysis.

Distinctions among Interval Analysis, Set Analysis, and Neutrosophic Analysis

Neutrosophic Analysis (or Neutrosophic Arithmetic) is a generalization of both the interval analysis and set analysis, because neutrosophic analysis deals with all kind of sets (not only with intervals), and also considers the case when there is some indeterminacy (with respect to the sets, or with respect to the functions or other notions defined on those sets).

If one uses sets and there is no indeterminacy, then neutrosophic analysis coincides with the set analysis.

If instead of sets, one uses only intervals and there is no indeterminacy, then neutrosophic analysis coincides with interval analysis.

If there is some indeterminacy, no matter if using only intervals, or using sets, one has neutrosophic analysis.

Examples of Neutrosophic Analysis

Neutrosophic precalculus and neutrosophic calculus are also different from set analysis, since they use indeterminacy.

As examples, let's consider the *neutrosophic functions*:

$$f_1(0 \text{ or } 1) = 7 \text{ (indeterminacy with respect to the argument of the function),}$$

$$\text{i.e. we are not sure if } f_1(0) = 7 \text{ or } f_1(1) = 7. \quad (3)$$

Or

$$f_2(2) = 5 \text{ or } 6 \text{ (indeterminacy with respect to the value of the function),}$$

$$\text{so we are not sure if } f_2(2) = 5 \text{ or } f_2(2) = 6. \quad (4)$$

Or even more complex:

$f_3(-2 \text{ or } -1) = -5 \text{ or } 9$ (indeterminacy with respect with both the argument and the value of the function),
 i.e. $f_3(-2) = -5$, or $f_3(-2) = 9$, or $f_3(-1) = -5$, or $f_3(-1) = 9$. (5)

And in general:

$$f_{m,n}(a_1 \text{ or } a_2 \text{ or } \dots \text{ or } a_m) = b_1 \text{ or } b_2 \text{ or } \dots \text{ or } b_n. \quad (6)$$

These functions, containing such indeterminacies, are different from set-argument, set vector functions.

Examples in Set Analysis

For example $f_1: R \rightarrow R$ is different from the set-argument function:

$$g_1: R^2 \rightarrow R, \text{ where } g_1(\{0, 1\}) = 7. \quad (7)$$

Also, $f_2: R \rightarrow R$ is different from the set-value function

$$g_2: R \rightarrow R^2, \text{ where } g_2(2) = \{5, 6\}. \quad (8)$$

Similarly, $f_3: R \rightarrow R$ is different from the set-argument set-value function

$$g_3: R^2 \rightarrow R^2, \text{ where } g_3(\{-2, -1\}) = \{-5, 9\}. \quad (9)$$

And in the general case, $f_{m,n}: R \rightarrow R$ is different from the set-argument set-value function

$$g_{m,n}: R^m \rightarrow R^n, \\ \text{where } g_{m,n}(\{a_1, a_2, \dots, a_m\}) = \{b_1, b_2, \dots, b_n\}. \quad (10)$$

It is true that any set can be enclosed into a closed interval, yet by working with larger intervals than narrow sets, the result is rougher, coarser, and more inaccurate.

Neutrosophic approach, by using smaller sets included into intervals, is more refined than interval analysis.

Neutrosophic approach also uses, as particular cases, open intervals, and half-open half-closed intervals.

Examples in Interval Analysis

Also, neutrosophic analysis deals with sets that have some indeterminacy: for example we know that an element $x(t,i,f)$ only partially belongs to a set S , and partially it does not belong to the set, while another part regarding the appurtenance to the set is indeterminate.

Or we have no idea if an element $y(0,1,0)$ belongs or not to the set (complete indeterminacy).

Or there is an element that belongs to the set, but we do not know it.

Interval analysis and set analysis do not handle these.

Let's consider an interval $L = [0, 5_{(0.6, 0.1, 0.3)} [$, where the number $5_{(0.6, 0.1, 0.3)}$ only partially (0.6) belongs to the interval L , partially doesn't belong (0.3), and its appurtenance is indeterminate (0.1). We should observe that $L \neq [0, 5]$ and $L \neq [0, 5)$. Actually, L is in between them:

$$[0, 5) \subset L \subset [0, 5], \quad (11)$$

since the element 5 does not belong to $[0, 5)$, partially belong to $[0, 5_{(0.6, 0.1, 0.3)} [$, and certainly belongs to $[0, 5]$. So, the interval L is part of neutrosophic analysis, not of interval analysis.

Now, if one considers the functions:

$$k_1([0, 5]) = [-4, 6], \text{ or } k_2([-2, -4]) = [0, 5], \quad (12)$$

then k_1 and k_2 belong to the interval analysis.

But if we take

$$k_3([0, 5_{(0.6, 0.1, 0.3)}]) = [-4, 6], \text{ or } k_4([-2, -4]) = [0, 5_{(0.6, 0.1, 0.3)}], \quad (13)$$

then k_3 and k_4 belong to neutrosophic analysis.

A *Neutrosophic Function* $f: A \rightarrow B$ is a function, which has some indeterminacy, with respect to its domain of definition, to its range, to its relationship that associates

elements in A with elements in B -- or to two or three of the above situations.

Interval Analysis studies only functions defined on intervals, whose values are also intervals, but have no indeterminacy.

Therefore, neutrosophic analysis is more general than interval analysis. Also, neutrosophic analysis deals with indeterminacy with respect to a function argument, a function value, or both.

For example, the neutrosophic functions:

$$e: \mathbb{R} \cup \{I\} \rightarrow \mathbb{R} \cup \{I\}, e(2 + 3I) = 7 - 6I \quad (14)$$

where $I =$ indeterminacy.

$$f: \mathbb{R} \rightarrow \mathbb{R}, f(4 \text{ or } 5) = 7; \quad (15)$$

$$g: \mathbb{R} \rightarrow \mathbb{R}, g(0) = -2 \text{ or } 3 \text{ or } 7; \quad (16)$$

$$h: \mathbb{R} \rightarrow \mathbb{R}, h(-1 \text{ or } 1) = 4 \text{ or } 6 \text{ or } 8; \quad (17)$$

$k: \mathbb{R} \rightarrow \mathbb{R}, k(x) = x$ and $-x$ (which fails the classical vertical line test for a curve to be a classical function); thus $k(x)$ is not a function from a classical point of view, but it is a neutrosophic function); (18)

$$l: \mathbb{R} \rightarrow \mathbb{R}, l(-3) = \text{maybe } 9. \quad (19)$$

One has:

Interval Analysis \subset Set Analysis \subset Neutrosophic Analysis.

Inclusion Isotonicity

Inclusion isotonicity of interval arithmetic also applies to set analysis and neutrosophic analysis. Hence, if \odot stands for set addition, set subtraction, set multiplication, or set division, and A, B, C, D are four sets such that: $A \subseteq C$ and $B \subseteq D$, then

$$A \odot B \subseteq C \odot D. \quad (20)$$

The proof is elementary for set analysis:

Let $x \in A \odot B$, then there exists $a \in A$ and $b \in B$ such that $x = a \odot b$.

But $a \in A$ and $A \subseteq C$ means that $a \in C$ as well.

And similarly, $b \in B$ and $B \subseteq D$ means that $b \in D$ as well.

Whence, $x = a \odot b \in C \odot D$ too.

The proof for neutrosophic analysis is similar, but one has to consider one of the neutrosophic inclusion operators; for example as follows for crisp neutrosophic components t, i, f :

a neutrosophic set M is included into a neutrosophic set N if,

for any element $x(t_M, i_M, f_M) \in M$ one has $x(t_N, i_N, f_N) \in N$, with $t_M \leq t_N$, $i_M \geq i_N$, and $f_M \geq f_N$.

Conclusion

This research is in the similar style as those on neutrosophic probability (2013) and neutrosophic statistics (2014) from below.

References

1. Florentin Smarandache, *Introduction to Neutrosophic Measure, Neutrosophic Integral, and Neutrosophic Probability*, Sitech & Educational, Craiova, Columbus, 140 p., 2013.
2. Florentin Smarandache, *Introduction to Neutrosophic Statistics*, Sitech and Education Publisher, Craiova, 123 p., 2014.
3. Ramon E. Moore, R. Baker Kearfott, Michael J. Cloud, *Introduction to Interval Analysis*, Society of Industrial and Applied Mathematics, Philadelphia, PA, USA, 2009.
4. Dilwyn Edwards and Mike Hamson, *Guide to Mathematical Modelling*, CRC Press, Boca Raton, 1990.

I.4. Indeterminate Elementary Geometrical Measurements

The mathematics of indeterminate change is the *Neutrosophic Calculus*.

Indeterminacy means imprecise, unclear, vague, incomplete, inconsistent, contradictory information. While classical calculus characterizes the dynamicity of our world, neutrosophic calculus characterizes the indeterminate (neutrosophic) dynamicity. Classical calculus deals with notions (such as slope, tangent line, arc length, centroid, curvature, area, volume, as well as velocity, and acceleration) as exact measurements, but in many real-life situations one deals with approximate measurements.

Neutrosophic Precalculus is more static and is referred to ambiguous staticity.

In neutrosophic calculus, we deal with notions that have some indeterminacy. Moreover, indeterminacy, unfortunately, propagates from one operation to the other.

In an abstract idealist world, there are perfect objects and perfect notions that the classical calculus uses.

For example, the curvature of perfect circle of radius $r > 0$ is a constant number [equals to $1/r$], but for an imperfect circle its curvature may be an interval [included in $(1/r - \varepsilon, 1/r + \varepsilon)$, which is a neighborhood of the number $1/r$, with $\varepsilon > 0$ a tiny number].

A perfect right triangle with legs of 1 cm and 2 cm has its hypotenuse equals to $\sqrt{5}\text{ cm}$. However, in our imperfect world, we cannot draw a segment of line whose length be

equal of exactly $\sqrt{5}$ cm, since $\sqrt{5}$ is an irrational number that has infinitely many decimals, we need to approximate it to a few decimals: $\sqrt{5} = 2.23606797 \dots$

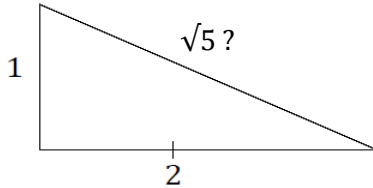

Figure 1.

The area of a perfect ellipses is $A = \pi ab$, where $2a$ and $2b$, with $a > b$, are its major and minor axes respectively. However, we cannot represent it exactly since π is a transcendental number (i.e. it is not a solution of any polynomial equations with rational coefficients), and it has infinitely many decimals. If $a = 2$ cm and $b = 1$ cm, then the area of the ellipse is $A = 2\pi = 6.2831 \dots$ cm².

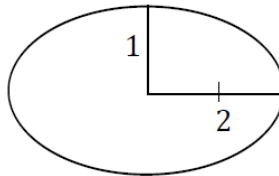

Figure 2.

but we can not exactly comprise this area inside of this ellipse, since $6.2831 \dots$ is not an exact number. We only work with approximations (imprecisions, indeterminations).

Similarly, for the volume of a perfect sphere $V = \frac{4}{3}\pi r^3$ where its radius is r . If $r = 1$ cm, then $V = \frac{4}{3}\pi =$

$4.1887 \dots \text{cm}^3$ which is a transcendental number and has infinitely many decimals. Thus, we are not able to exactly have the volume of the below sphere,

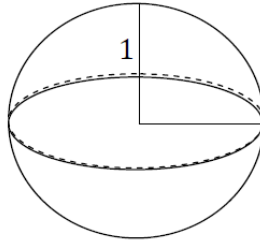

Figure 3.

equals to $4.1887 \dots \text{cm}^3$.

I.5. Indeterminate Physical Laws

Neutrosophy has also applications in physics, since many physical laws are defined in strictly closed systems², but such “perfect” system do not exist in our world, we deal only with approximately closed system, which makes room for using the neutrosophic (indeterminate) theory. Therefore, a system can be $t\%$ closed (in most cases $t < 100$), $i\%$ indeterminate with respect to closeness or openness, and $f\%$ open.

Therefore, a theoretical physical law (L) may be true in our practical world in less than 100% , hence the law may have a small percentage of falsehood, and another small percentage of indeterminacy (as in neutrosophic logic).

Between the validity and invalidity of a theoretical law (idea) in practice, there could be included multiple-middles, i.e. cases where the theoretical law (idea) is partially valid and partially invalid.

² Fu Yuhua, “Pauli Exclusion Principle and the Law of Included Multiple-Middle”, in Neutrosophic Sets and Systems, Vol. 6, 2014.

II. Neutrosophic Precalculus

II.1. Algebraic Operations with Sets

Let S and T be two sets, and $\alpha \in \mathbb{R}$ a scalar. Then:

$$\alpha \cdot S = \{\alpha \cdot s | s \in S\}; \quad (21)$$

$$S + T = \{s + t | s \in S, t \in T\}; \quad (22)$$

$$S - T = \{s - t | s \in S, t \in T\}; \quad (23)$$

$$S \cdot T = \{s \cdot t | s \in S, t \in T\}; \quad (24)$$

$$\frac{S}{T} = \left\{ \frac{s}{t} | s \in S, t \in T, t \neq 0 \right\}. \quad (25)$$

II.2. Neutrosophic Subset Relation

A *Neutrosophic Subset Relation* r , between two sets A and B , is a set of ordered pairs of the form (S_A, S_B) , where S_A is a subset of A , and S_B a subset of B , with some indeterminacy.

A neutrosophic relation r , besides *sure ordered pairs* (S_A, S_B) that 100% belong to r , may also contains *potential ordered pairs* (S_C, S_D) , where S_C is a subset of A , and S_D a subset of B , that might be possible to belong to r , but we do not know in what degree, or that partially belong to r with the neutrosophic value (T, I, F) , where $T < 1$ means degree of appurtenance to r , I means degree of indeterminate appurtenance, and F means degree of non-appurtenance.

Example:

$$r: \{0, 2, 4, 6\} \rightarrow \{1, 3, 5\}$$

$$r = \left\{ \begin{array}{l} (\{0, 2\}, \{1, 3\}), (\{4, 6\}, \{5\}), \\ (\{6\}, \{1, 5\})_{(0.7, 0.1, 0.1)}, (\{2, 6\}, \{3, 5\})_? \end{array} \right\} \quad (26)$$

where $(\{0, 2\}, \{1, 3\})$ and $(\{4, 6\}, \{5\})$ for sure belong to r ; while $(\{6\}, \{1, 5\})$ partially belongs to r in a percentage of 70%, 10% is its indeterminate appurtenance, and 10% doesn't belong to r ;

and $(\{2, 6\}, \{3, 5\})$ is also potential ordered pairs (it might belong to r , but we don't know in what degree).

II.3. Neutrosophic Subset Function

A *Neutrosophic Subset Function* $f: \mathcal{P}(A) \rightarrow \mathcal{P}(B)$, is a neutrosophic subset relation such that if there exists a subset $S \subseteq A$ with $f(S) = T_1$, and $f(S) = T_2$, then $T_1 \equiv T_2$. (This is the (*Neutrosophic*) *Vertical Line Test* extended from crisp to set-values.)

As a particular case, a *Neutrosophic Crisp Relation* between two sets A and B is a classical (crisp) relation that has some indeterminacy.

A neutrosophic crisp relation may contain, besides the *classical sure ordered pairs* (a, b) , with $a \in A$ and $b \in B$, also *potential ordered pairs* (c, d) , with $c \in A$ and $d \in B$ meaning that we are not sure if there is or there is not a relation between c and d , or there is a relation between c and d , but in a percentage strictly less than *100%*.

For example, the neutrosophic relation:

$$r: \{1, 2, 3, 4\} \rightarrow \{5, 6, 7, 8, 9\} \quad (27)$$

defined in set notation as:

$$\{(1, 5), (2, 6), (3, 7)_{[0.6, 0.1, 0.2]}, (3, 8)_{?}, (4, 9)_{?}\}$$

where the ordered pairs $(1, 5)$, $(2, 6)$, $(3, 7)$ for sure (*100%* belong to r), while $(3, 7)$ only *60%* belongs to r , *10%* the appurtenance is indeterminate, and *30%* it does not belong to r [as in neutrosophic set], while about the ordered pairs $(3, 8)$ and $(4, 9)$ we do not know their appurtenance to r (but it might be possible).

Another definition, in general, is:

A *Neutrosophic Relation* $r: A \rightarrow B$ is formed by any connections between subsets and indeterminacies in A with subsets and indeterminacies in B .

It is a double generalization of the classical relation; firstly, because instead of connecting elements in A with elements in B , one connects subsets in A with subsets in B ; and secondly, because it has some indeterminacies, or connects indeterminacies, or some connections are not well-known.

A neutrosophic relation, which is not a neutrosophic function, can be restrained to a neutrosophic function in several ways.

For example, if $r(S) = T_1$ and $r(S) = T_2$, where $T_1 \neq T_2$, we can combine these to:

- either $f(S) = T_1$ and T_2 ,
- or $f(S) = T_1$ or T_2 ,
- or $f(S) = \{T_1, T_2\}$,

which comply with the definition of a neutrosophic function.

II.4. Neutrosophic Crisp Function

A *Neutrosophic Crisp Function* $f: A \rightarrow B$ is a neutrosophic crisp relation, such that if there exists an element $a \in A$ with $f(a) = b$ and $f(a) = c$, where $b, c \in B$, then $b \equiv c$. (This is the classical *Vertical Line Test*.)

II.5. General Neutrosophic Function

A *General Neutrosophic Function* is a neutrosophic relation where the vertical line test (or the vertical subset-line test) does not work. But, in this case, the general neutrosophic function coincides with the neutrosophic relation.

II.6. Neutrosophic (Subset or Crisp) Function

A *neutrosophic (subset or crisp) function* in general is a function that has some indeterminacy.

Examples

1. $f: \{1, 2, 3\} \rightarrow \{4, 5, 6, 7\}$ (28)
 $f(1) = 4, f(2) = 5, \text{ but } f(3) = 6 \text{ or } 7$
[we are not sure].

If we consider a *neutrosophic diagram representation* of this neutrosophic function, we have:

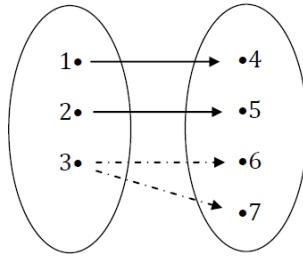

Diagram 1. Neutrosophic Diagram Representation.

The dotted arrows mean that we are not sure if the element 3 is connected to the element 6, or if 3 is connected to 7.

As we see, this neutrosophic function is not a function in the classical way, and it is not even a relationship in a classical way.

If we make a *set representation* of this neutrosophic function, we have:

$$\{(1, 4), (2, 5), \boxed{(3, 6)}, \boxed{(3, 7)}\}$$

where the dotted borders mean we are not sure if they belong or not to this set. Or we can put the pairs $(3, 6)$ and $(3, 7)$ in red color (as warning).

In table representation, we have:

x	1	2	3	3
$f(x)$	4	5	6	7

Table 1.

where about the red color numbers we are not sure.

Similarly, for a *graph representation*:

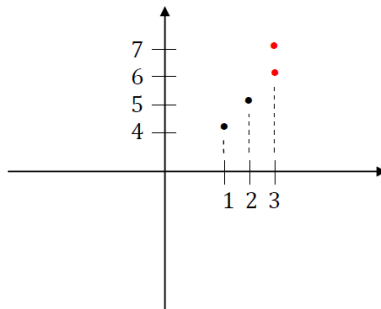

Graph 1.

Or, modifying a little this example, we might know, for example, that 3 is connected with 7 only partially, i.e. let's say $(3, 7)_{(0.6, 0.2, 0.5)}$ which means that 60% 3 is connected with 7, 20% it is not clear if connected or non-connected, and 50% 3 is not connected with 7.

The sum of components $0.6 + 0.2 + 0.5 = 1.3$ is greater than 1 because the three sources providing information about connection, indeterminacy, non-connection respectively are independent, and use different criteria of evaluation.

2. We modify again this neutrosophic function as follows:

$$g: \{1, 2, 3\} \rightarrow \{4, 5, 6, 7\}, \quad (29)$$

$$g(1) = 4, g(2) = 5, \text{ but } g(3) = 6 \text{ and } 7.$$

The neutrosophic function g is not a function in the classical way (since it fails the vertical line test at $x = 3$), but it is a relationship in the classical way.

Its four representations are respectively:

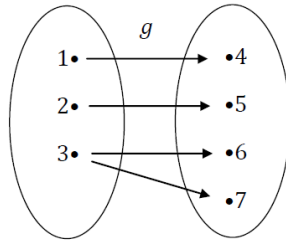
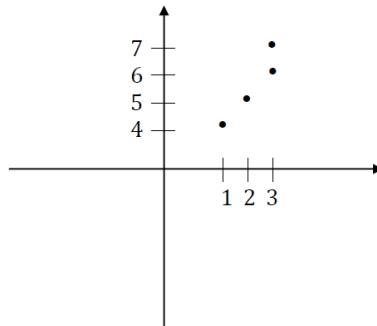

Diagram 2.

$$\{(1, 4), (2, 5), (3, 6), (3, 7)\}$$

x	1	2	3	3
f(x)	4	5	6	7

Table 1.



Graph 2.

Yet, if we redesign g as

$$G: \{1, 2, 3\} \rightarrow \mathcal{P}(\{4, 5, 6, 7\}), \quad (30)$$

$$G(1) = 4, G(2) = 5, \text{ and } G(3) = \{6, 7\},$$

then G becomes a classical set-valued function.

3. Let's consider a different style of neutrosophic function:

$$h: \mathbb{R} \rightarrow \mathbb{R} \quad (31)$$

$$h(x) \in [2, 3], \text{ for any } x \in \mathbb{R}.$$

Therefore, we know about this function only the fact that it is bounded by the horizontal lines $y = 2$ and $y = 3$:

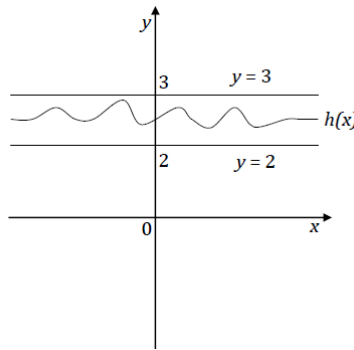

Graph 3.

4. Similarly, we modify $h(\bullet)$ and get a constant neutrosophic function (or thick function):

$$l: \mathbb{R} \rightarrow \mathcal{P}(\mathbb{R}) \quad (32)$$

$$l(x) = [2, 3] \text{ for any } x \in \mathbb{R},$$

where $\mathcal{P}(\mathbb{R})$ is the set of all subsets of \mathbb{R} .

For ex., $l(7)$ is the vertical segment of line $[2, 3]$.

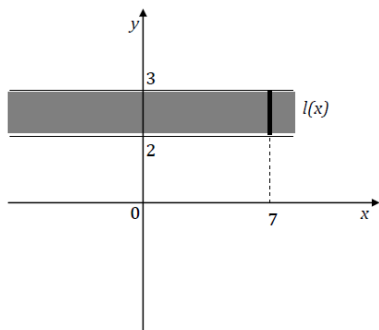

Graph 4.

5. A non-constant neutrosophic thick function:

$$k: \mathbb{R} \rightarrow \mathcal{P}(\mathbb{R})$$

(33)

$$k(x) = [2x, 2x + 1]$$

whose graph is:

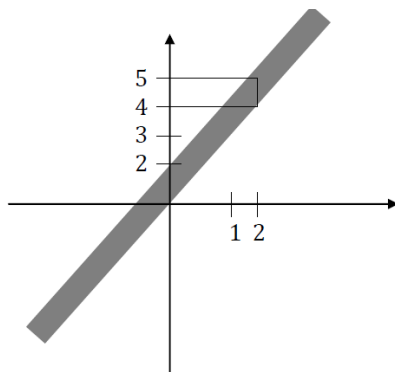

Graph 5.

For example:

$$k(2) = [2(2), 2(2) + 1] = [4, 5].$$

6. In general, we may define a neutrosophic thick function as:

$$\begin{aligned}
 m: \mathbb{R} &\rightarrow \mathcal{P}(\mathbb{R}) && (34) \\
 m(x) &= [m_1(x), m_2(x)]
 \end{aligned}$$

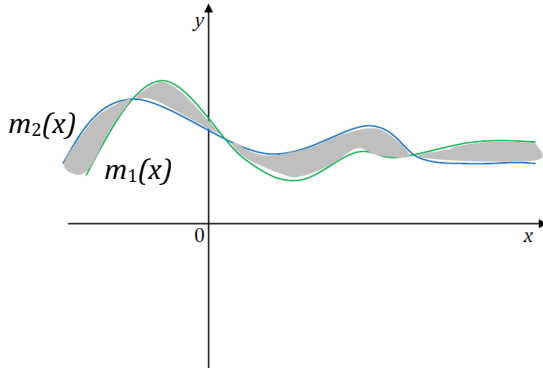

Graph 6.

and, of course, instead of brackets we may have an open interval $(m_1(x), m_2(x))$, or semi-open/semi-close intervals $(m_1(x), m_2(x)]$, or $[m_1(x), m_2(x))$.

For example, $m(0) = [m_1(0), m_2(0)]$, the value of neutrosophic function $m(x)$ and a vertical segment of line.

These examples of thick (neutrosophic) functions are actually classical surfaces in \mathbb{R}^2 .

7. Example of neutrosophic piece-wise function:

$$\begin{aligned}
 s: \mathbb{R} &\rightarrow \mathcal{P}(\mathbb{R}) && (35) \\
 s(x) &= \begin{cases} [s_1(x), s_2(x)], & \text{for } x \leq 3; \\ (s_3(x), s_4(x)), & \text{for } x > 3; \end{cases}
 \end{aligned}$$

with the neutrosophic graph:

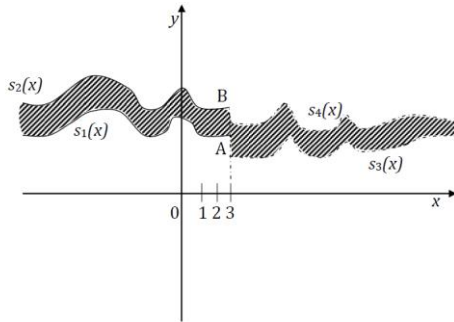

Graph 7.

For example, $s(3) = [s_1(3), s_2(3)]$, which is the vertical closed segment of line $[AB]$.

In all above examples the indeterminacy occurred into the values of function. But it is also possible to have indeterminacy into the argument of the function, or into both (the argument of the function, and the values of the function) as below.

8. Indeterminacy into the argument of the function:

$$r: \{1, 2, 3, 4\} \rightarrow \{5, 6, 7\} \quad (36)$$

$$r(1) = 5, r(2) = 6,$$

$$r(3 \text{ or } 4) = 7 \text{ \{i. e. we do not know if } r(3) = 7 \text{ or } r(4) = 7\}.$$

Another such example:

$$t: \{1, 2, 3, 4\} \rightarrow \{5, 6\} \quad (37)$$

$$t(1) = 5, \text{ but } t(2 \text{ or } 3 \text{ or } 4) = 6.$$

9. Indeterminacy into both:

$$\sqcup: \{1, 2, 3, 4\} \rightarrow \{5, 6, 7\} \quad (38)$$

$$\sqcup(1 \text{ or } 2) = 5 \text{ or } 6 \text{ or } 7,$$

which means that either $\sqcup (1) = 5$, or $\sqcup (1) = 6$, or $\sqcup (1) = 7$,
or $\sqcup (2) = 5$, or $\sqcup (2) = 6$, or $\sqcup (2) = 7$;

$$\sqcup (2 \text{ or } 3 \text{ or } 4) = 6 \text{ or } 7.$$

Another example:

$$v_1: \mathbb{R} \rightarrow \mathcal{P}(\mathbb{R}), v_1(x \text{ or } 2x) = 5x. \quad (39)$$

Yet, this last neutrosophic function with indeterminacy into argument can be transformed, because $v_1(2x) = 5x$ is equivalent to $v_1(x) = 2.5x$, into a neutrosophic function with indeterminacy into the values of the function only:

$$v_2(x) = 2.5x \text{ or } 5x.$$

Nor these last neutrosophic functions are relationships in a classical way.

II.7. Discrete and Non-Discrete Indeterminacy

From another view point, there is a *discrete indeterminacy*, as for examples:

$$f(2 \text{ or } 3) = 4,$$

or $f(2) = 5 \text{ or } 6,$

or $f(2 \text{ or } 3) = 5 \text{ or } 6;$

and *non-discrete indeterminacy*, as for examples:

$$f(7x \text{ or } 8x) = 63,$$

or $f(x) = 10x^3$

or $20 \sin(x),$

or $f(x^2 \text{ or } 8x) = 16e^x$ and $\ln x.$

Depending on each type of indeterminacy we need to determine a specific *neutrosophic technic* in order to overcome that indeterminacy.

II.8. Neutrosophic Vector-Valued Functions of Many Variables

We have given neutrosophic examples of real-valued functions of a real variable. But similar neutrosophic vector-valued functions of many variables there exist in any scientific space:

$$f: A_1 \times A_2 \times \dots \times A_n \rightarrow B_1 \times B_2 \times \dots \times B_m$$
$$f(x_1, x_2, \dots, x_n) = \begin{pmatrix} f_1(x_1, x_2, \dots, x_n), \\ f_2(x_1, x_2, \dots, x_n), \dots, \\ f_m(x_1, x_2, \dots, x_n) \end{pmatrix}. \quad (40)$$

Sure A_1, A_2, \dots, A_n and B_1, B_2, \dots, B_n may be scientific spaces of any types.

Such neutrosophic vector-valued functions of many variables may have indeterminacy into their argument, into their values, or into both. And the indeterminacy can be discrete or non-discrete.

II.9. Neutrosophic Implicit Functions

Similarly to the classical explicit and implicit function, there exist: *Neutrosophic Explicit Functions*, for example:

$$f(x) = x^2 \text{ or } x^2 + 1, \quad (41)$$

and *Neutrosophic Implicit Functions*, for example:

$$\{(x, y) \in \mathbb{R}^2 | e^x + e^y = 0 \text{ or } e^x + e^y = -1\}. \quad (42)$$

II.10. Composition of Neutrosophic Functions

Composition of Neutrosophic Functions is an extension of classical composition of functions, but where the indeterminacy propagates.

For example:

$$f(x) = [\ln(x), \ln(3x)], \text{ for } x > 0, \quad (43)$$

$$\text{and } g(x) = \begin{cases} \frac{1}{x-5}, & \text{if } x \neq 5; \\ 7 \text{ or } 9, & \text{if } x = 5; \end{cases} \quad (44)$$

are both neutrosophic functions.

What is $(f \circ g)(5) = ?$

$$(f \circ g)(5) = f(g(5)) = f(7 \text{ or } 9) =$$

$$[\ln 7, \ln 21] \text{ or } [\ln 9, \ln 27]. \quad (45)$$

Therefore, the discrete indeterminacy “7 or 9” together with the non-discrete (continuous) indeterminacy “ $[\ln(x), \ln(3x)]$ ” have propagated into a double non-discrete (continuous) indeterminacy “ $[\ln 7, \ln 21]$ or $[\ln 9, \ln 27]$ ”.

But what is $(g \circ f)(5) = ?$

$$(g \circ f)(5) = g(f(5)) = g([\ln 5, \ln 15]) =$$

$$\left[\frac{1}{\ln(15)-5}, \frac{1}{\ln(5)-5} \right] \approx [-0.43631, -0.29494]. \quad (46)$$

What is in general $(f \circ g)(x) = ?$

$$(f \circ g)(x) = f(g(x)) = \begin{cases} f\left(\frac{1}{x-5}\right), & \text{for } x \neq 5; \\ f(7 \text{ or } 9), & \text{for } x = 5; \end{cases}$$

$$= \begin{cases} \left[\ln\left(\frac{1}{x-5}\right), \ln\left(\frac{3}{x-5}\right) \right], & \text{for } x > 5; \\ \left[[\ln 7, \ln 21] \text{ or } [\ln 9, \ln 27] \right], & \text{for } x = 5. \end{cases} \quad (47)$$

Since the domain of $f(\cdot)$ is $(0, \infty)$, one has $\frac{1}{x-5} > 0$, i.e. $x > 5$ for the first piecewise of $f \circ g$.

As we said before, a neutrosophic function $y = f(x)$ may have indeterminacy into its domain, or into its range, or into its relation between x and y (or into any two or three of them together).

II.11. Inverse Neutrosophic Function

The *inverse of a neutrosophic function* is also a neutrosophic function, since the indeterminacy of the original neutrosophic function is transmitted to its inverse.

Example.

$$f(x) = \begin{cases} 2x + 1 \text{ or } 6x, & \text{for } x \neq 0; \\ [1, 3], & \text{for } x = 0; \end{cases} \quad (48)$$

or

$$0 \neq x \longrightarrow 2x+1 \text{ or } 6x;$$

$$0 \longrightarrow [1, 3].$$

Let's find the inverse of the neutrosophic function

$f(x)$.

$$y = 2x + 1 \text{ or } 6x, \text{ for } x \neq 0. \quad (49)$$

Therefore $y = 2x + 1$ or $y = 6x$, for $x \neq 0$.

Interchange the variables: $x = 2y + 1$ or $x = 6y$, for $y \neq 0$.

Thus $x = 2y + 1$, whence $y = \frac{x-1}{2} \neq 0$, therefore $x \neq 1$, respectively: $x = 6y$, whence $y = \frac{x}{6} \neq 0$, therefore $x \neq 0$.

Hence, the inverse of the neutrosophic function $f(x)$ is:

$$f^{-1}(x) = \begin{cases} \frac{x-1}{2} \text{ or } \frac{x}{6}, & \text{for } x \neq 0 \text{ and } x \neq 1; \\ 0, & \text{for } x = [1, 3]. \end{cases} \quad (50)$$

Again, the inverse of a neutrosophic function:

$$f: \mathbb{R} \rightarrow \mathbb{R}^2$$

$$f(x) = [2x + 1, 6x], \text{ for } x \in \mathbb{R},$$

or $x \rightarrow [2x + 1, 6x]$.

Simply, the inverse is:

$$f^{-1}: \mathbb{R}^2 \rightarrow \mathbb{R}$$

$$f^{-1}([2x + 1, 6x]) = x, \text{ for all } x \in \mathbb{R},$$

or $[2x + 1, 6x] \rightarrow x.$ (51)

The inverse of the neutrosophic exponential function
is $k(x) = 2^x$ or 2^{x+1}
 $k^{-1}(x) = \log_2(x)$ or $\log_2(x + 1).$ (52)

Similarly, the inverse of the neutrosophic logarithmic function

$$h(x) = \log_{(0.09, 0.11)} x$$

is $h^{-1}(x) = (0.09, 0.11)^x.$ (53)

A classical function is invertible if and only if it is one-to-one (verifies the *Horizontal Line Test*).

Let's consider the classical function:

$$f: \{1, 2, 3\} \rightarrow \{4, 5\}$$
$$f(1) = 4, f(2) = 5, f(3) = 5. \quad (54)$$

This function is not one-to-one since it fails the horizontal line test at $y = 5$, since $f(2) = f(3)$. Therefore, this function is not classically invertible.

However, neutrosophically we can consider the neutrosophic inverse function

$$f^{-1}(4) = 1, f^{-1}(5) = \{2, 3\},$$
$$f^{-1}: \{4, 5\} \rightarrow \mathcal{P}(\{1, 2, 3\}). \quad (55)$$

For the graph of a neutrosophic inverse function $f^{-1}(x)$ we only need to reflect with respect to the symmetry axis $y = x$ the graph of the neutrosophic function $f(x)$.

The indeterminacy of a neutrosophic function is transmitted to its neutrosophic inverse function.

Proposition

Any neutrosophic function is invertible.

Proof. If $f(x)$ fails the horizontal line test $f: A \rightarrow B$, at $y = b$, from the domain of definition of the neutrosophic function, we define the neutrosophic inverse function

$$f^{-1}(b) = \{a \in A, f(a) = b\}, f^{-1}: B \rightarrow A. \quad (56)$$

Let $f: A \rightarrow B$ be a neutrosophic function. If the neutrosophic graph of f contains the neutrosophic point (C, D) , where $C \subseteq A$ and $D \subseteq B$, then the graph of the neutrosophic inverse function f^{-1} contains the neutrosophic point (D, C) .

A *neutrosophic point* is a generalization of the classical point (c, d) , where $c \in A$ and $d \in B$, whose dimension is zero. A neutrosophic point is in general a thick point, which may have the dimension 0, 1, 2 or more (depending on the space we work in).

As examples, $\alpha([1, 2], [4, 6])$ has dimension 2:

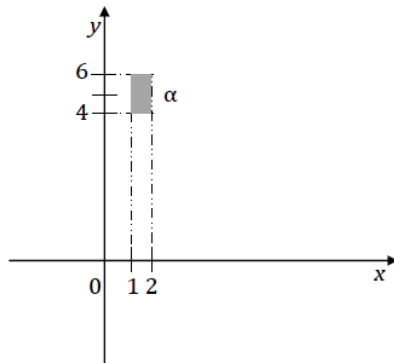

Graph 8.

or $\beta(3, (-1, 1))$ has the dimension 1:

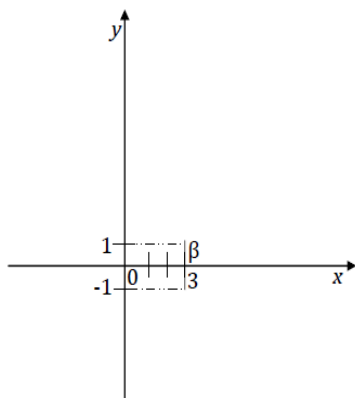

Graph 9.

or $\gamma(-2, \{-4, -3, -2\})$ has the dimension zero:

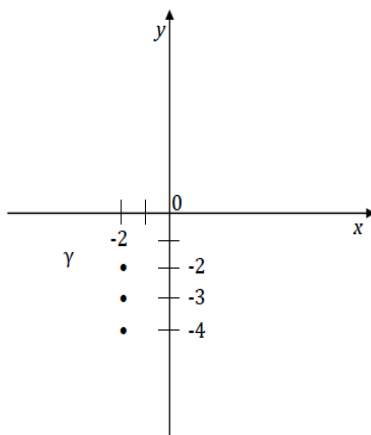

Graph 10.

while $\delta([2, 3], [4, 5], [0, 4])$ has the dimension 3:

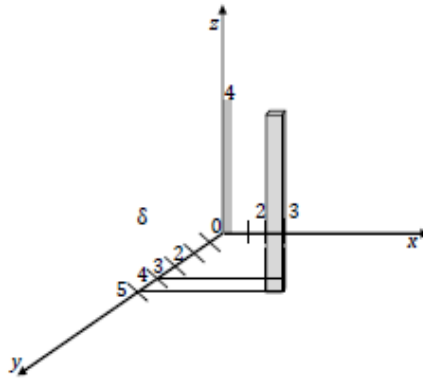

Graph 11.

II.12. Zero of a Neutrosophic Function

Let $f: A \rightarrow B$. The zero of a neutrosophic function f may be in general a set $S \subseteq A$ such $f(S) = 0$.

For example:

$$f: \mathbb{R} \rightarrow \mathbb{R}$$

$$f(x) = \begin{cases} x - 4, & x \notin [1, 3] \\ 0, & x = [1, 3] \end{cases} \quad (57)$$

This function has a crisp zero, $x = 4$, since $f(4) = 4 - 4 = 0$, and an interval-zero $x = [1, 3]$ since $f([1, 3]) = 0$.

II.13. Indeterminacies of a Function

By language abuse, one can say that any classical function is a neutrosophic function, if one considers that the classical function has a null indeterminacy.

II.14. Neutrosophic Even Function

A Neutrosophic Even Function:

$$f: A \rightarrow B$$

has a similar definition to the classical even function:

$$f(-x) = f(x), \text{ for all } x \text{ in } A, \quad (58)$$

with the extension that $f(-I) = f(I)$, where $I =$ indeterminacy.

For example:

$$f(x) = \begin{cases} x^2, & \text{for } x \notin \{-1, 1\}; \\ [0, 2], & \text{for } x = -1 \text{ or } 1. \end{cases} \quad (59)$$

Of course, for determinate

$$x \in \mathbb{R} \setminus \{-1, 1\}, f(-x) = (-x)^2 = x^2 = f(x). \quad (60)$$

While for the indeterminate $I = -1$ or 1 one has

$$-I = -(-1 \text{ or } 1) = 1 \text{ or } -1 = -1 \text{ or } 1$$

whence $f(-I) = f(-1 \text{ or } 1) = [0, 2]$

and $f(I) = f(-1 \text{ or } 1) = [0, 2]$,

hence f is a neutrosophic even function.

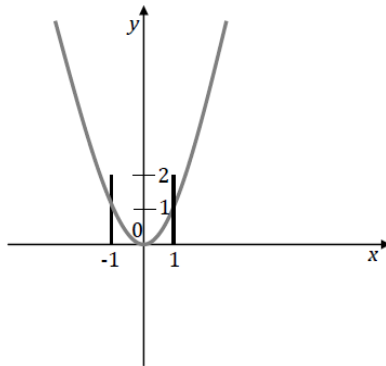

Graph 12.

As for classical even functions, the graph of a neutrosophic even function is symmetric, in a neutrosophic way, with respect to the y -axis, i.e. for a neutrosophic point P situated in the right side of the y -axis there exists a neutrosophic point P' situated in the left side of the y -axis which is symmetric with P , and reciprocally.

We recall that the graph of a neutrosophic function is formed by neutrosophic points, and a neutrosophic point may have not only the dimension 0 (zero), but also dimension 1, 2 and so on depending on the spaces the neutrosophic function is defined on and takes values in, and depending on the neutrosophic function itself.

II.15. Neutrosophic Odd Function

Similarly, a *Neutrosophic Odd Function* $f: A \rightarrow B$ has a similar definition to the classical odd function:

$f(-x) = -f(x)$, for all x in A , with the extension that $f(-I) = -f(I)$, where $I =$ indeterminacy.

For example:

$$f: \mathbb{R} \rightarrow \mathbb{R}$$

$$f(x) = \begin{cases} x \text{ and } x^3, & \text{for } x \neq 0; \\ -5 \text{ or } 5, & \text{for } x = 0. \end{cases} \quad (61)$$

The first piece of the function is actually formed by putting together two distinct functions.

Of course, for $x \neq 0$, $f(-x) = -x$, and $(-x)^3 = -x^3$, and $-x^3 = -(x \text{ and } x^3) = -f(x)$.

While for $x = 0$, one has:

$$f(-0) = f(0) = -5 \text{ or } 5;$$

$$-f(0) = -(-5 \text{ or } 5) = 5 \text{ or } -5 = -5 \text{ or } 5.$$

So, $f(-0) = -f(0)$, hence f is a neutrosophic odd function.

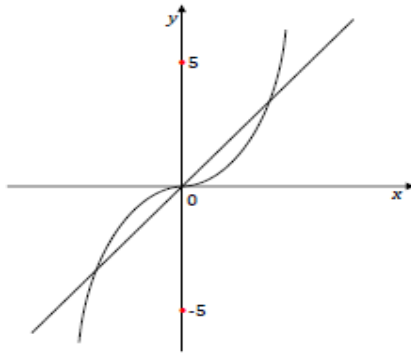

Graph 13.

Same thing: a neutrosophic odd function is neutrosophically symmetric with respect to the origin of the Cartesian system of coordinates.

II.16. Neutrosophic Model

A model which has some indeterminacy is a neutrosophic model. When gathered data that describe the physical world is incomplete, ambiguous, contradictory, unclear, we are not able to construct an accurate classical model. We need to build an approximate (thick) model.

Using neutrosophic statistics, we plot the data and then design a neutrosophic regression method. The most common used such methods are the neutrosophic linear regression and the neutrosophic least squares regression.

For two neutrosophic variables, x and y , representing the plotted data, one designs the best-fitting neutrosophic curve of the regression method. Instead of crisp data, as in classical regression, for example:

$$(x, y) \left\{ \begin{array}{l} (1, 2), (3, 5), (4, 8), \\ (-2, -4), (0, 0), (-5, -11), \dots \end{array} \right\} \quad (62)$$

one works with set (approximate) data in neutrosophic regression:

$$(x, y) \in \left\{ \begin{array}{l} ((1, [2, 2.2]), ([2.5, 3], 5), ([3.9, 4], (8, 8.1))), \\ (-2, -4), ((0.0, 0.1], (-0.1, 0.0)), \\ (-5, (-10, -11)), \dots \end{array} \right\} \quad (63)$$

and instead of obtaining, for example, a crisp linear regression as in classical statistics:

$$y = 2x - 1, \quad (64)$$

one gets a set-linear regression, for example:

$$y = [1.9, 2]x - [0.9, 1.1] \quad (65)$$

as in neutrosophic statistics.

II.17. Neutrosophic Correlation Coefficient

The classical correlation coefficient r is a crisp number between $[-1, 1]$. The neutrosophic correlation coefficient is a subset of the interval $[-1, 1]$.

Similarly, if the subset of the neutrosophic correlation coefficient is more in the positive side of the interval $[-1, 1]$, the neutrosophic variables x and y have a neutrosophic positive correlation, otherwise they have a neutrosophic negative correlation.

Of course, there is not a unique neutrosophic model to real world problems. And thus, there are no exact neutrosophic rules to be employed in neutrosophic modelling. Each neutrosophic model is an approximation, and the approximations may be done from different points of view. A model might be considered better than others if it predicts better than others. But in most situations, a model could be better from a standpoint, and worse from another standpoint – since a real world problem normally depends on many (known and unknown) parameters.

Yet, a neutrosophic modelling of reality is needed in order to fastly analyse the alternatives and to find approximate optimal solutions.

II.18. Neutrosophic Exponential Function

A *Neutrosophic Exponential Function* is an exponential function which has some indeterminacy [with respect to one or more of: its formula (base or exponent), or domain, or range].

If one has a classical exponential function

$$g(x) = a^x, \text{ with } a > 0 \text{ and } a \neq 1, \quad (66)$$

then an indeterminacy with respect to the base can be, for example:

$$f(x) = [0.9, 1.1]^x, \quad (67)$$

where “a” is an interval which even includes 1, and we get a thick function:

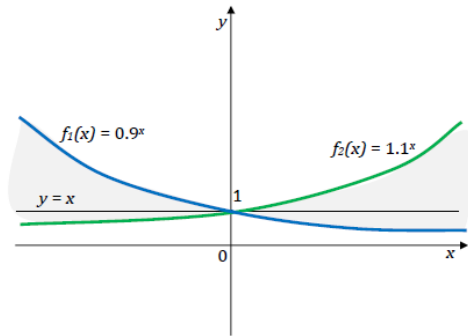

Graph 14.

or one may have indeterminacy with respect to the exponent:

$$k(x) = 2^x \text{ or } x+1. \quad (68)$$

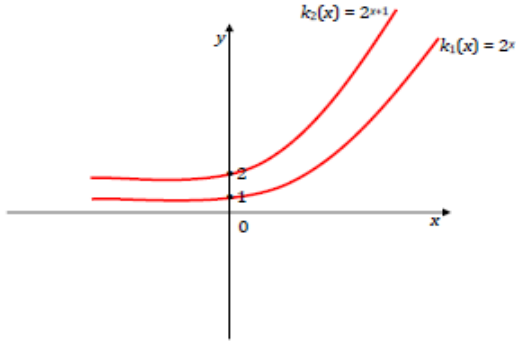

Graph 15.

For example: $k(1) = 2^{1 \text{ or } 1+1} = 2^1 \text{ or } 2^2 = 2 \text{ or } 4$
 (we are not sure if it's 2 or 4). (69)

A third neutrosophic exponential function:

$$l(x) = 2^{(x, x+1)} \tag{70}$$

is different from $k(x)$ and has the graph:

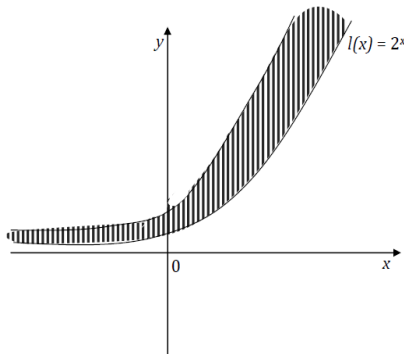

Graph 16.

which is a thick function. For example: $l(1) = 2^{(1, 1+1)} = 2^{(1, 2)} = (2^1, 2^2) = (2, 4)$, an open interval. (71)

II.19. Neutrosophic Logarithmic Function

Similarly, a *Neutrosophic Logarithmic Function* is a logarithmic function that has some indeterminacy (with respect to one or more of: its formula, or domain, or range).

For examples:

$$f(x) = \log_{[2,3]} x = [\log_3 x, \log_2 x]. \quad (72)$$

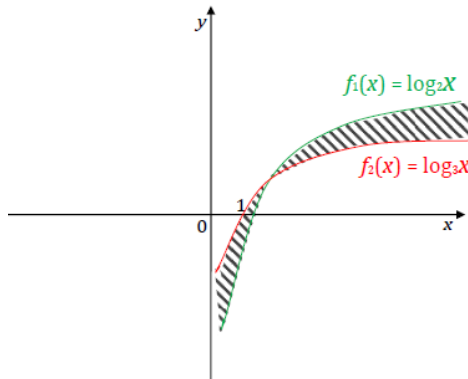

Graph 17.

$$\text{or } g(x) = \ln(x, 2x) = (\ln(x), \ln(2x)) \quad (73)$$

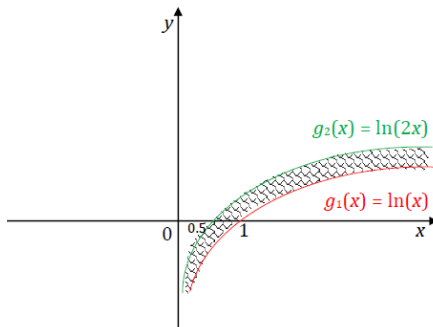

Graph 18.

or $h(x) = \log_{(0.09,1.1)} x$ (74)

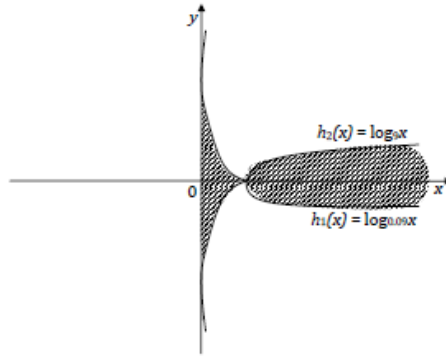

Graph 19.

II.20. Indeterminacy of the Composition of Neutrosophic Functions

In general, by composing two neutrosophic functions, the indeterminacy increases.

Example:

$$f_1(x) = x^3 \text{ or } x^4$$

$$f_2(x) = [2.1, 2.5]^x$$

then

$$(f_1 \circ f_2)(x) = f_1(f_2(x)) = [2.1, 2.5]^{3x} \text{ or } [2.1, 2.5]^{4x}. \quad (75)$$

III. Neutrosophic Calculus

III.1. Neutrosophic Limit

Neutrosophic Limit means the limit of a neutrosophic function.

We extend the classical limit.

Let consider a neutrosophic function $f: \mathbb{R} \rightarrow \mathcal{P}(\mathbb{R})$ whose neutrosophic graph is below:

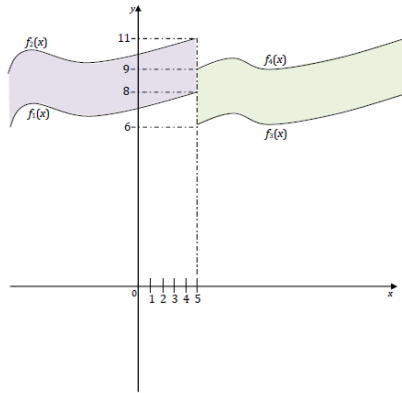

Graph 20.

$$f(x) = \begin{cases} [f_1(x), f_2(x)], & \text{for } x \leq 5; \\ [f_3(x), f_4(x)], & \text{for } x > 5, \end{cases} \quad (76)$$

is a neutrosophic piecewise-function.

Using the Neutrosophic Graphic Method, we get:

- The Neutrosophic Left Limit is

$$\lim_{\substack{x \rightarrow 5 \\ x < 5}} f(x) = [8, 11]; \quad (77)$$

- The Neutrosophic Right Limit is

$$\lim_{\substack{x \rightarrow 5 \\ x > 5}} f(x) = [6, 9]. \quad (78)$$

We introduce for the first time the notion of *neutrosophic mereo-limit*. Because the neutrosophic mereo-limit is the intersection of the neutrosophic left limit and the neutrosophic right limit [similarly as in the classical limit, where the left limit has to be equal to the right limit – which is equivalent to the fact that the intersection between the left limit (i.e. the set formed by a single finite number, or by $+\infty$, or by $-\infty$) and the right limit (i.e. also the set formed by a single finite number, or by $+\infty$, or by $-\infty$) is not empty], one has:

$$\lim_{x \rightarrow 5} f(x) = [8, 11] \cap [6, 9] =]8, 9]. \quad (79)$$

If the intersection between the neutrosophic left limit and the neutrosophic right limit is empty, then the neutrosophic mereo-limit does not exist.

Neutrosophic Limit of a function $f(x)$ does exist if the neutrosophic left limit coincides with the neutrosophic right limit. (We recall that in general the neutrosophic left and right limits are sets, rather than numbers.) For example, the previous function does not have a neutrosophic limit since $[8, 11] \not\equiv [6, 9]$.

Norm

We define a *norm*.

Let $\mu: \mathcal{P}(\mathbb{R}) \rightarrow \mathbb{R}^+$, where $\mathcal{P}(\mathbb{R})$ is the power set of \mathbb{R} , while \mathbb{R} is the set of real numbers. (80)

For any set $\mathcal{S} \in \mathcal{P}(\mathbb{R})$,

$$\mu(\mathcal{S}) = \max \{|x|, x \in \mathcal{S} \cup Fr(\mathcal{S})\}, \quad (81)$$

where $|x|$ is the absolute value of x , and $Fr(\mathcal{S})$ is the frontier of \mathcal{S} ,

or:

$$\mu(\mathcal{S}) = \max\{|inf\mathcal{S}|, |sup\mathcal{S}|\} \quad (82)$$

where $\inf \mathcal{S}$ means the infimum of \mathcal{S} , and $\sup \mathcal{S}$ means the supremum of \mathcal{S} .

Then:

$$\begin{aligned} \mu(\mathcal{S}_1 + \mathcal{S}_2) &= \max\{|\inf \mathcal{S}_1 + \inf \mathcal{S}_2|, |\sup \mathcal{S}_1 + \sup \mathcal{S}_2|\}, \\ \mu(\alpha \cdot \mathcal{S}) &= \max\{|\alpha| \cdot |\inf \mathcal{S}|, |\alpha| \cdot |\sup \mathcal{S}|\}, \end{aligned} \quad (83)$$

where $\alpha \in \mathbb{R}$ is a scalar.

If the cardinality of the set \mathcal{S} is 1, i.e. $\mathcal{S} = \{a\}$, $a \in \mathbb{R}$, then $\mu(\mathcal{S}) = \mu(a) = |a|$. (84)

We prove that $\mu(\cdot)$ is a *norm*.

$$\mu: \mathcal{P}(\mathbb{R}) \rightarrow \mathbb{R}^+,$$

$$\begin{aligned} \forall \mathcal{S} \in \mathcal{P}(\mathbb{R}), \mu(\mathcal{S}) &= \max\{|x|, x \in \mathcal{S} \cup Fr(\mathcal{S})\} = \\ &= \max\{|\inf \mathcal{S}|, |\sup \mathcal{S}|\}. \end{aligned} \quad (85)$$

$$\begin{aligned} \mu(-\mathcal{S}) = \mu(-1 \cdot \mathcal{S}) &= \max\{|-1| \cdot |\inf \mathcal{S}|, |-1| \cdot \\ &|\sup \mathcal{S}|\} = \max\{|\inf \mathcal{S}|, |\sup \mathcal{S}|\} = \mu(\mathcal{S}). \end{aligned} \quad (86)$$

For a scalar t ,

$$\begin{aligned} \mu(t \cdot \mathcal{S}) &= \max\{|t| \cdot |\inf \mathcal{S}|, |t| \cdot |\sup \mathcal{S}|\} = |t| \cdot \\ &\max\{|\inf \mathcal{S}|, |\sup \mathcal{S}|\} = |t| \cdot \mu(\mathcal{S}). \end{aligned} \quad (87)$$

$$\begin{aligned} \mu(\mathcal{S}_1 + \mathcal{S}_2) &= \max\{|\inf \mathcal{S}_1 + \inf \mathcal{S}_2|, |\sup \mathcal{S}_1 + \\ &\sup \mathcal{S}_2|\} \leq \max\{|\inf \mathcal{S}_1| + |\inf \mathcal{S}_2|, |\sup \mathcal{S}_1| + |\sup \mathcal{S}_2|\} \leq \\ &\max\{|\inf \mathcal{S}_1|, |\sup \mathcal{S}_1|\} + \max\{|\inf \mathcal{S}_2|, |\sup \mathcal{S}_2|\} = \mu(\mathcal{S}_1) + \\ &\mu(\mathcal{S}_2). \end{aligned} \quad (88)$$

$$\begin{aligned} \mu(\mathcal{S}_1 - \mathcal{S}_2) &= \mu(\mathcal{S}_1 + (-\mathcal{S}_2)) \leq \mu(\mathcal{S}_1) + \mu(-\mathcal{S}_2) = \\ &\mu(\mathcal{S}_1) + \mu(\mathcal{S}_2). \end{aligned} \quad (89)$$

III.2. Appropriateness Partial-Distance (Partial-Metric)

Let A and B be two sets included in \mathbb{R} , such that $\inf A$, $\sup A$, $\inf B$, and $\sup B$ are finite numbers.

Then the appropriate partial-distance (partial-metric) between A and B is defined as:

$$\eta : \mathbb{R}^2 \longrightarrow \mathbb{R}^+$$

$$\eta(A, B) = \max\{|\inf A - \inf B|, |\sup A - \sup B|\} \quad (90)$$

In other words, the appropriateness partial-distance measures how close the \inf 's and \sup 's of two sets (i.e. the two sets corresponding extremities) are to each other.

III.3. Properties of the Appropriateness Partial-Distance

For any $A, B, C \subset \mathbb{R}$, such that $\inf A, \sup A, \inf B, \sup B, \inf C$, and $\sup C$ are finite numbers, one has:

$$\text{a) } \eta(A, B) \geq 0. \quad (91)$$

$$\text{b) } \eta(A, A) = 0. \quad (92)$$

But if $\eta(A, B) = 0$ it does not result that $A \equiv B$, it results that $\inf A = \inf B$ and $\sup A = \sup B$.

For example, if $A = \{3, 4, 5, 7\}$ and $B = \{3, 7\}$, then $\inf A = \inf B = 3$ and $\sup A = \sup B = 7$, whence $\eta(A, B) = 0$, but $A \not\equiv B$. (93)

Therefore, this distance axiom is verified only partially by η .

$$\text{c) } \eta(A, B) = \eta(B, A). \quad (94)$$

$$\text{d) } \eta(A, B) \leq \eta(B, C) + \eta(C, A). \quad (95)$$

Proof of d):

$$\begin{aligned} \eta(A, B) &= \max\{|\inf A - \inf B|, |\sup A - \sup B|\} \\ &= \max\{|\inf A - \inf C + \inf C - \inf B|, |\sup A - \sup C + \sup C - \sup B|\}. \end{aligned} \quad (96)$$

$$\begin{aligned} \text{But } |\inf A - \inf C + \inf C - \inf B| &\leq |\inf A - \inf C| + |\inf C - \inf B| \\ &= |\inf B - \inf C| + |\inf C - \inf A| \end{aligned} \quad (97)$$

and similarly

$$\begin{aligned} |\sup A - \sup C + \sup C - \sup B| &\leq |\sup A - \sup C| + |\sup C - \sup B| \\ &= |\sup B - \sup C| + |\sup C - \sup A| \end{aligned} \quad (98)$$

whence

$$\begin{aligned} &\max\{|\inf A - \inf C + \inf C - \inf B|, |\sup A - \sup C + \sup C - \sup B|\} \\ &\leq \max\{|\inf B - \inf C|, |\sup B - \sup C|\} + \max\{|\inf C - \inf A|, |\sup C - \sup A|\} = \eta(B, C) + \eta(C, A). \end{aligned} \quad (99)$$

e) If $A = \{a\}$ and $B = \{b\}$, with $a, b \in \mathbb{R}$, i.e. A and B contain only one element each, then:

$$\eta(A, B) = |a-b|. \quad (100)$$

f) If A and B are real (open, closed, or semi-open/semi-closed) intervals, $A = [a_1, a_2]$ and $B = [b_1, b_2]$, with $a_1 < a_2$ and $b_1 < b_2$, then $\eta(A, B) = \max\{|a_1-b_1|, |a_2-b_2|\}$. (101)

III.4. Partial-Metric Space

Let's have in general:

$\eta: \mathcal{M} \rightarrow R^+$, where \mathcal{M} is a non-empty set.

The function η is a *partial-metric* (partial-distance) on \mathcal{M} ,

$$\eta(A, B) = \max\{|infA - infB|, |supA - supB|\} \quad (102)$$

and the space \mathcal{M} endowed with η is called a *partial-metric space*.

This partial-metric space η is a generalization of the metric d , defined in interval analysis:

$d: S \rightarrow S$, where S is any real set, and

$$d([a, b], [c, d]) = \max\{|a - c|, |b - d|\}, \quad (103)$$

with $a \leq b$ and $c \leq d$, because η deals with all kinds of sets, not only with intervals as in integer analysis.

Remarkably,

$$\eta(A, 0) = \max\{|infA - 0|, |supA - 0|\} =$$

$$\max\{|infA|, |supA|\} = \mu(A), \quad (104)$$

which is the norm of A .

III.5. $\varepsilon - \delta$ Definition of the Neutrosophic Limit

Let f be a neutrosophic function, $f: P(\mathbb{R}) \rightarrow P(\mathbb{R})$.

The $\varepsilon - \delta$ definition of the Neutrosophic Left Limit is an extension of the classical left limit definition, where the absolute value $|\cdot|$ is replaced by $\eta(\cdot)$. Also, instead of working with scalars only, we work with sets (where a “set” is viewed as an approximation of a “scalar”).

Therefore,

$$\lim_{x \rightarrow c} f(x) = L \quad (105)$$

is equivalent to $\forall \varepsilon > 0, \exists \delta = \delta(\varepsilon) > 0$, such that if $\eta(x, c)_{x < c} < \delta$, then $\eta(f(x), L)_{x < c} < \varepsilon$.

(106)

The $\varepsilon - \delta$ definition of the Neutrosophic Right Limit.

$$\lim_{x \rightarrow c} f(x) = L \quad (107)$$

is equivalent to $\forall \varepsilon > 0, \exists \delta = \delta(\varepsilon) > 0$, such that if $\eta(x, c)_{x > c} < \delta$, then $\eta(f(x), L)_{x > c} < \varepsilon$.

(108)

And, in general, the $\varepsilon - \delta$ definition of the Neutrosophic Limit.

$$\lim_{x \rightarrow c} f(x) = L$$

is equivalent to $\forall \varepsilon > 0, \exists \delta = \delta(\varepsilon) > 0$, such that if $\eta(x, c) < \delta$, then $\eta(f(x), L) < \varepsilon$.

(109)

III.6. Example of Calculating the Neutrosophic Limit

In our *previous example*, with $c = 5$, let $\varepsilon > 0$, then

$$\begin{aligned} & \eta([f_1(x), f_2(x)], [8, 11]) = \\ & \max_{\substack{\eta(x-5) < \delta \\ x < 5}} \{|\inf[f_1(x), f_2(x)] - \inf[8, 11]|, \\ & |\sup[f_1(x), f_2(x)] - \sup[8, 11]|\} = \max_{\substack{\eta(x-5) < \delta \\ x < 5}} \{|f_1(x) - \\ & 8|, |f_2(x) - 11|\} < \varepsilon. \end{aligned} \tag{110}$$

$\eta(x, 5) < \delta$ means $|x - 5| < \delta$ as in classical calculus.

$$\max_{\substack{\eta(x-5) < \delta \\ x < 5}} \{|f_1(x) - 8|, |f_2(x) - 11|\} < \varepsilon$$

means $|f_1(x) - 8| < \varepsilon$, and $|f_2(x) - 11| < \varepsilon$, when $|x - 5| < \delta$ and $x \leq 5$. (111)

III.7. Particular Case of Calculating the Neutrosophic Limit

Suppose, as a *particular case* of the previous example, that $f_1(x), f_2(x), f_3(x), f_4(x)$ are piecewise functions, such that in a left or right neighborhood of $x = 5$ they are:

$$f_1(x) = -x^2 + 6x + 3, \text{ for } x \in [4, 5]; \quad (112)$$

$$f_2(x) = x^3 - 114, \text{ for } x \in [4, 5]; \quad (113)$$

$$f_3(x) = x + 1, \text{ for } x \in [5, 6]; \quad (114)$$

$$f_4(x) = 3x - 6, \text{ for } x \in [5, 6]. \quad (115)$$

Therefore,

$$|f_1(x) - 8| = |-x^2 + 6x + 3 - 8| = |-(x - 5)(x - 1)| = |(x - 5)(x - 1)| < \frac{\varepsilon}{4}(4) = \varepsilon; \text{ we take } \delta = \frac{\varepsilon}{4} \text{ because } x - 1 \leq 4, \text{ since } x \in [4, 5]. \quad (116)$$

$$\text{And } |f_2(x) - 11| = |x^3 - 114 - 11| = |(x - 5)(x^2 + 5x + 25)| < \frac{\varepsilon}{75}(75) = \varepsilon; \text{ we take } \delta = \frac{\varepsilon}{75}, \text{ because } x^2 + 5x + 25 \leq (5)^2 + 5(5) + 25 = 75, \text{ since } x \in [4, 5]. \quad (117)$$

We got that for any $\varepsilon > 0$, there exists $\delta = \min\left\{\frac{\varepsilon}{4}, \frac{\varepsilon}{75}\right\} = \frac{\varepsilon}{75}$. Whence it results the *neutrosophic left limit*.

Similarly for the *neutrosophic right limit* in this example.

Let $\varepsilon > 0$. Then

$$\begin{aligned} & \eta([f_3(x), f_4(x)], [6, 9]) = \\ & \max_{\substack{\eta(x-5) < \delta \\ x > 5}} \{|\inf[f_3(x), f_4(x)] - \inf[6, 9]|, |\sup[f_3(x), f_4(x)] - \sup[6, 9]|\} = \\ & \max_{\substack{\eta(x-5) < \delta \\ x > 5}} \{|f_3(x) - 6|, |f_4(x) - 9|\} < \varepsilon, \quad (118) \end{aligned}$$

which means

$|f_3(x) - 6| < \varepsilon$, and $|f_4(x) - 9| < \varepsilon$,
when $|x - 5| < \delta$ and $x > 5$.

Therefore:

$$|f_3(x) - 6| = |x + 1 - 6| = |x - 5| < \frac{\varepsilon}{1}(1) = \varepsilon;$$

we take $\delta = \frac{\varepsilon}{1} = \varepsilon$. (119)

And:

$$|f_4(x) - 9| = |3x - 6 - 9| = |3(x - 5)| < \frac{\varepsilon}{3} \cdot (3) = \varepsilon;$$

we take $\delta = \frac{\varepsilon}{3}$. (120)

We got that for any $\varepsilon > 0$, there exists

$$\delta = \min \left\{ \varepsilon, \frac{\varepsilon}{3} \right\} = \frac{\varepsilon}{3}, \quad (121)$$

whence it results the neutrosophic right limit.

Then we intersect the neutrosophic left and right limits to get the neutrosophic mereo-limit. We observe that the neutrosophic limit does not exist of this function, since if we take $\varepsilon = 0.1 > 0$, there exist no $\delta = \delta(\varepsilon) > 0$ such that if $|x - 5| < \delta$ to get

$$\eta([f_1(x), f_2(x)], [8, 9]) < 0.1 \quad (122)$$

not even

$$\eta([f_3(x), f_4(x)], [8, 9]) < 0.1 \quad (123)$$

since in tiny neighborhood of 5 the absolute values of differences $|f_2(x) - 9|$ and $|f_3(x) - 8|$ are greater than 1.

III.8. Computing a Neutrosophic Limit Analytically

Let's consider the below limit:

$$\lim_{x \rightarrow -3} \frac{x^2 + 3x - [1, 2]x - [3, 6]}{x + 3} \tag{124}$$

We substitute x for -3 , and we get:

$$\begin{aligned} \lim_{x \rightarrow -3} \frac{(-3)^2 + 3 \cdot (-3) - [1, 2] \cdot (-3) - [3, 6]}{-3 + 3} \\ &= \frac{9 - 9 - [1 \cdot (-3), 2 \cdot (-3)] - [3, 6]}{0} \\ &= \frac{0 - [-6, -3] - [3, 6]}{0} \\ &= \frac{[3, 6] - [3, 6]}{0} = \frac{[3 - 6, 6 - 3]}{0} \\ &= \frac{[-3, 3]}{0}, \end{aligned} \tag{125}$$

which has an undefined operation $\frac{0}{0}$, since $0 \in [-3, 3]$.

Then we factor out the numerator, and simplify:

$$\begin{aligned} \lim_{x \rightarrow -3} \frac{x^2 + 3x - [1, 2]x - [3, 6]}{x + 3} \\ &= \lim_{x \rightarrow -3} \frac{(x - [1, 2]) \cdot (x + 3)}{(x + 3)} \\ &= \lim_{x \rightarrow -3} (x - [1, 2]) = -3 - [1, 2] \\ &= [-3, -3] - [1, 2] \\ &= -([3, 3] + [1, 2]) = [-5, -4]. \end{aligned} \tag{126}$$

We can check the result considering classical crisp coefficients instead of interval-valued coefficients.

For examples:

- a) Taking the infimum of the intervals [1,2] and respectively [3,6], i.e. 1 and respectively 3, we have:

$$\begin{aligned} \lim_{x \rightarrow -3} \frac{x^2 + 3x - 1x - 3}{x + 3} &= \\ \lim_{x \rightarrow -3} \frac{x^2 + 2x - 3}{x + 3} &= \lim_{x \rightarrow -3} \frac{(x+3)(x-1)}{x+3} = \lim_{x \rightarrow -3} (x - 1) = -3 - 1 \\ &= -4 \in [-5, -4]. \end{aligned} \tag{127}$$

- b) Taking the supremum of the intervals [1,2] and respectively [3,6], i.e. 2 and respectively 6, we have:

$$\begin{aligned} \lim_{x \rightarrow -3} \frac{x^2 + 3x - 2x - 6}{x + 3} &= \\ \lim_{x \rightarrow -3} \frac{x^2 + x - 6}{x + 3} &= \lim_{x \rightarrow -3} \frac{(x+3)(x-2)}{x+3} = \lim_{x \rightarrow -3} (x - 2) = -3 - 2 = \\ &= -5 \in [-5, -4]. \end{aligned} \tag{128}$$

- c) Taking the midpoints of the intervals [1,2] and respectively [3,6], i.e. 1.5 and respectively 4.5, we have:

$$\begin{aligned} \lim_{x \rightarrow -3} \frac{x^2 + 3x - 1.5x - 4.5}{x + 3} &= \\ \lim_{x \rightarrow -3} \frac{x^2 + 1.5x - 4.5}{x + 3} &= \lim_{x \rightarrow -3} \frac{(x+3)(x-1.5)}{x+3} = \lim_{x \rightarrow -3} (x - \\ 1.5) &= -3 - 1.5 = -4.5 \in [-5, -4]. \end{aligned} \tag{129}$$

- d) In general, taking $\alpha \in [1,2]$ and respectively $3\alpha \in [3,6]$, one has:

$$\begin{aligned} \lim_{x \rightarrow -3} \frac{x^2 + 3x - \alpha x - 3\alpha}{x+3} &= \\ \lim_{x \rightarrow -3} \frac{x^2 + (3-\alpha)x - 3\alpha}{x+3} &= \lim_{x \rightarrow -3} \frac{(x+3)(x-\alpha)}{x+3} = \lim_{x \rightarrow -3} (x - \\ \alpha) &= -3 - \alpha \in [-3, -3] - [1, 2] \quad \{ \text{since } \alpha \in [1, 2] \} \\ &= [-3-2, -3-1] = [-5, -4]. \end{aligned} \tag{130}$$

So, we got the same result.

III.9. Calculating a Neutrosophic Limit Using the Rationalizing Technique

$$\begin{aligned}
 \lim_{x \rightarrow 0} \frac{\sqrt{(4,5) \cdot x + 1} - 1}{x} &= \frac{\sqrt{(4,5) \cdot 0 + 1} - 1}{0} \\
 &= \frac{\sqrt{[4 \cdot 0, 5 \cdot 0] + 1} - 1}{0} \\
 &= \frac{\sqrt{[0, 0] + 1} - 1}{0} = \frac{\sqrt{0 + 1} - 1}{0} = \frac{0}{0} \\
 &= \text{undefined.} \tag{131}
 \end{aligned}$$

Multiply with the conjugate of the numerator:

$$\begin{aligned}
 \lim_{x \rightarrow 0} \frac{\sqrt{[4,5]x + 1} - 1}{x} &\cdot \frac{\sqrt{[4,5]x + 1} + 1}{\sqrt{[4,5]x + 1} + 1} \\
 &= \lim_{x \rightarrow 0} \frac{(\sqrt{[4,5]x + 1})^2 - (1)^2}{x(\sqrt{[4,5]x + 1} + 1)} \\
 &= \lim_{x \rightarrow 0} \frac{[4,5] \cdot x + 1 - 1}{x \cdot (\sqrt{[4,5]x + 1} + 1)} \\
 &= \lim_{x \rightarrow 0} \frac{[4,5] \cdot x}{x \cdot (\sqrt{[4,5]x + 1} + 1)} \\
 &= \lim_{x \rightarrow 0} \frac{[4,5]}{(\sqrt{[4,5]x + 1} + 1)} \\
 &= \frac{[4,5]}{(\sqrt{[4,5] \cdot 0 + 1} + 1)} = \frac{[4,5]}{\sqrt{1} + 1} \\
 &= \frac{[4,5]}{2} = \left[\frac{4}{2}, \frac{5}{2} \right] = [2, 2.5]. \tag{132}
 \end{aligned}$$

Similarly we can check this limit in a classical way considering a parameter $\alpha \in [4,5]$ and computing the limit by multiplying with the conjugate of the numerator:

$$\lim_{x \rightarrow 0} \frac{\sqrt{\alpha \cdot x + 1} - 1}{x} = \frac{\alpha}{2} \in [4,5]/2 = [2, 2.5]. \quad (133)$$

III.10. Neutrosophic Mereo-Continuity

We now introduce for the first time the notion of *neutrosophic mereo-continuity*. A *neutrosophic function* $f(x)$ is *mereo-continuous at a given point* $x = c$, where

$$f: A \rightarrow B$$

if the intersection of the neutrosophic left limit, neutrosophic right limit, and $f(c)$ is nonempty:

$$\left\{ \lim_{x \rightarrow c} f(x) \right\} \cap \left\{ \lim_{x \rightarrow c} f(x) \right\} \cap \{f(c)\} \neq \phi. \quad (134)$$

A *neutrosophic function* $f(x)$ is *mereo-continuous on a given interval* $[a, b]$, if there exist the classical points $A \in \{f(a)\}$ and $B \in \{f(b)\}$ that can be connected by a continuous classical curve which is inside of $f(x)$.

Also, the classical definition can be extended in the following way: A *neutrosophic function* $f(x)$ is *mereo-continuous on a given interval* $[a, b]$, if $f(x)$ is neutrosophically continuous at each point of $[a, b]$.

A *neutrosophic function* $f(x)$ is *continuous* at a given point $x = c$ if:

$$\lim_{x \rightarrow c} f(x) \equiv \lim_{x \rightarrow c} f(x) \equiv f(c). \quad (135)$$

We see that the previous neutrosophic function stated in section (3.1) graph (20) eq. (76) is mereo-continuous at $x = 5$ because:

$$\left\{ \lim_{x \rightarrow 5} f(x) \right\} \cap \left\{ \lim_{x \rightarrow 5} f(x) \right\} \cap \{f(5)\} = [8, 11] \cap [6, 9] \cap [8, 11] = [8, 9] \neq \phi. \quad (136)$$

III.11. Neutrosophic Continuous Function

A neutrosophic function $f: \mathcal{M}_1 \rightarrow \mathcal{M}_2$ is *continuous* at a *neutrosophic point* $x = c$ if:

$$\forall \varepsilon > 0, \exists \delta = \delta(\varepsilon) > 0, \quad (137)$$

such that for any $x \in \mathcal{M}_1$ such that $\eta(x, c) < \delta$ one has $\eta(f(x), f(c)) < \varepsilon$. (138)

(We recall that a “neutrosophic point” $x = c$ is in general a set $c \in \mathcal{M}_1$, while \mathcal{M}_1 and \mathcal{M}_2 are sets of sets.)

III.12. Neutrosophic Intermediate Value Theorem

Let $f: A \rightarrow P(A)$, $f(x) = [a_x, b_x] \subseteq A$, where $[a_x, b_x]$ is an interval. (139)

Let

$$\inf\{f(a)\} = a_1;$$

$$\sup\{f(a)\} = a_2;$$

$$\inf\{f(b)\} = b_1;$$

$$\sup\{f(b)\} = b_2.$$

Suppose $\min\{a_1, a_2, b_1, b_2\} = m$,

and $\max\{a_1, a_2, b_1, b_2\} = M$.

If $f(x)$ is a neutrosophic mereo-continuous function on the closed interval $[a, b]$, and k is a number between m and M , with $m \neq M$, then there exists a number $c \in [a, b]$ such that: $\{f(c)\} \ni k$ (i.e. the set $\{f(c)\}$ contains k), or $k \in \{f(c)\}$.

An extended version of this theorem is the following:

If $f(x)$ is a neutrosophic mereo-continuous function of the closed interval $[a, b]$, and $\langle k_1, k_2 \rangle$ is an interval included in the interval $[m, M]$, with $m \neq M$, then there exist c_1, c_2, \dots, c_m in $[a, b]$, where $m \geq 1$, such that $\langle k_1, k_2 \rangle \subseteq f(c_1) \cup f(c_2) \cup \dots \cup f(c_m)$.

Where by $\langle \alpha, \beta \rangle$ we mean any kind of closed, open or half-closed and half-open intervals: $[\alpha, \beta]$, or (α, β) , or $[\alpha, \beta)$, or $(\alpha, \beta]$.

III.13. Example for the Neutrosophic Intermediate Value Theorem

Let $g(x) = [g_1(x), g_2(x)]$, where $g: \mathbb{R} \rightarrow \mathbb{R}^2$, and $g_1, g_2: \mathbb{R} \rightarrow \mathbb{R}$.

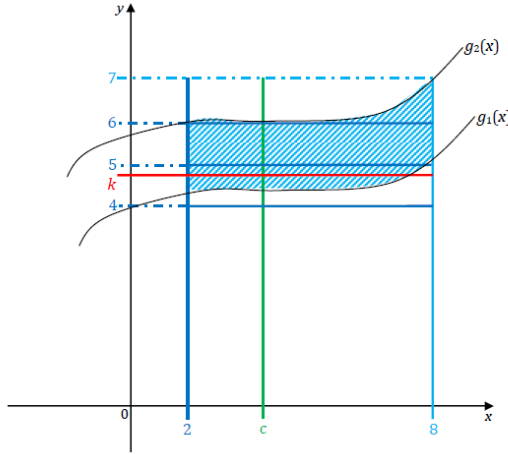

Graph 21.

g is neutrosophically continuous on the interval $[2, 8]$.

Let $m = \min\{4, 5, 6, 7\} = 4$,

and $M = \max\{4, 5, 6, 7\} = 7$, and let $k \in [4, 7]$.

Then there exist many values of $c \in [2, 8]$ such that $\{g(c)\} \ni k$. See the green vertical line above, $x = c$. For example $c = 4 \in [2, 8]$. The idea is that if $k \in [4, 7]$ and we draw a horizontal red line $g = k$, this horizontal red line will intersect the shaded blue area which actually represents the neutrosophic graph of the function g on the interval $[2, 8]$.

III.14. Example for the Extended Intermediate Value Theorem

Let $h(x) = [h_1(x), h_2(x)]$, where $h: \mathbb{R} \rightarrow \mathbb{R}^2$, and $h_1, h_2: \mathbb{R} \rightarrow \mathbb{R}$. h is neutrosophically continuous on the interval $[3, 12]$.

Let $m = \min\{6, 8, 10, 12.5\} = 6$,
 and $M = \max\{6, 8, 10, 12.5\} = 12.5$,
 and let $[k_1, k_2] \in [6.5, 12] \subset [6, 12.5]$.

Then there exist $c_1 = 8 \in [3, 12]$ and $c_2 = 10 \in [3, 12]$ such that

$$h(c_1) \cup h(c_2) = h(8) \cup h(10) = [6.5, 11] \cup [9.5, 12] = [6.5, 12] = [k_1, k_2]. \quad (140)$$

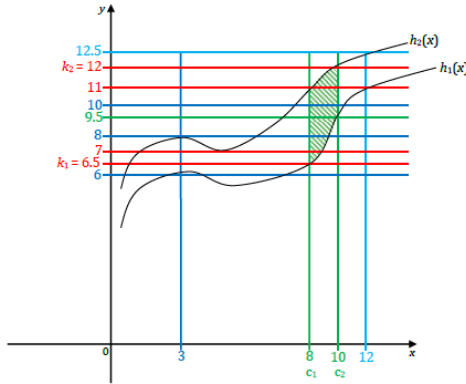

Graph 22.

Remark

The more complicated (indeterminate) is a neutrosophic function, the more complex the neutrosophic intermediate value theorem becomes.

Actually, for each class of neutrosophic function, the neutrosophic intermediate value theorem has a special form.

As a **General Remark**, we have:

For each class of neutrosophic functions a theorem will have a special form.

III.15. Properties of Neutrosophic Mereo-Continuity

1. A neutrosophic $f(x)$ is mereo-continuous on the interval $[a, b]$, if it's possible to connect a point of the set $\{f(a)\}$ with a point of the set $\{f(b)\}$ by a continuous classical curve \mathbb{C} which is included in the (thick) neutrosophic function $f(x)$ on the interval $[a, b]$.

2. If $\alpha \neq 0$ is a real number, and f is a neutrosophic mereo-continuous function at $x = c$, then $\alpha \cdot f$ is also a neutrosophic mereo-continuous function at $x = c$.

Proof

$$\begin{aligned} & \lim_{\substack{x \rightarrow c \\ x < c}}[\alpha \cdot f(x)] \cap \lim_{\substack{x \rightarrow c \\ x > c}}[\alpha \cdot f(x)] \cap \{\alpha \cdot f(c)\} = \\ & \left\{ \alpha \cdot \lim_{\substack{x \rightarrow c \\ x < c}}[f(x)] \right\} \cap \left\{ \alpha \cdot \lim_{\substack{x \rightarrow c \\ x > c}}[f(x)] \right\} \cap \{\alpha \cdot f(c)\} = \alpha \cdot \\ & \left(\left\{ \lim_{x \rightarrow c}[f(x)] \right\} \cap \left\{ \lim_{x \rightarrow c}[f(x)] \right\} \cap \{f(c)\} \right) \neq \emptyset, \end{aligned} \quad (141)$$

because $\alpha \neq 0$, and $\left\{ \lim_{x \rightarrow c}[f(x)] \right\} \cap \lim_{\substack{x \rightarrow c \\ x > c}}[f(x)] \cap \{f(c)\} \neq \emptyset$,

since f is a neutrosophic mereo-continuous function. (142)

3. Let $f(x)$ and $g(x)$ be two neutrosophic mereo-continuous functions at $x = c$, where $f, g: A \rightarrow B$. Then,

$$(f + g)(x), (f - g)(x), (f \cdot g)(x), \left(\frac{f}{g}\right)(x) \quad (143)$$

are all neutrosophic mereo-continuous functions at $x = c$.

Proofs

$f(x)$ is mereo-continuous at $x = c$ it means that

$$\left\{ \lim_{x \rightarrow c} f(x) \right\} \cap \left\{ \lim_{x \rightarrow c} f(x) \right\} \cap \{f(c)\} \neq \emptyset \quad (144)$$

therefore

$$\left\{ \lim_{x \rightarrow c} f(x) \right\} = M_1 \cup L_1 \quad (145)$$

$$\left\{ \lim_{x \rightarrow c} f(x) \right\} = M_1 \cup R_1 \quad (146)$$

and

$$\{f(c)\} = M_1 \cup V_1 \quad (147)$$

where all M_1, L_1, R_1, V_1 are subsets of B , and $M_1 \neq \emptyset$, while $L_1 \cap R_1 \cap V_1 = \emptyset$.

Similarly, $g(x)$ is mereo-continuous at $x = c$ means that

$$\left\{ \lim_{x \rightarrow c} g(x) \right\} \cap \left\{ \lim_{x \rightarrow c} g(x) \right\} \cap \{g(c)\} \neq \emptyset, \quad (148)$$

therefore

$$\left\{ \lim_{x \rightarrow c} g(x) \right\} = M_2 \cup L_2 \quad (149)$$

$$\left\{ \lim_{x \rightarrow c} g(x) \right\} = M_2 \cup R_2 \quad (150)$$

and

$$\{g(c)\} = M_2 \cup V_2 \quad (151)$$

where all M_2, L_2, R_2, V_2 are subsets of B , and $M_2 \neq \emptyset$, while $L_2 \cap R_2 \cap V_2 = \emptyset$.

Now,

$$\begin{aligned} f + g: A &\rightarrow B \\ (f + g)(x) &= f(x) + g(x) \end{aligned} \quad (152)$$

and $(f + g)(x)$ is mereo-continuous at $x = c$ if

$$\left\{ \lim_{\substack{x \rightarrow c \\ x < c}} (f + g)(x) \right\} \cap \left\{ \lim_{\substack{x \rightarrow c \\ x > c}} (f + g)(x) \right\} \cap \{(f + g)(c)\} \neq \emptyset \quad (153)$$

or

$$\left\{ \lim_{x < c} [f(x) + g(x)] \right\} \cap \left\{ \lim_{x > c} [f(x) + g(x)] \right\} \cap \{f(c) + g(c)\} \neq \emptyset \quad (154)$$

or

$$\left(\left\{ \lim_{x < c} f(x) \right\} + \left\{ \lim_{x < c} g(x) \right\} \right) \cap \left(\left\{ \lim_{x > c} f(x) \right\} + \left\{ \lim_{x > c} g(x) \right\} \right) \cap (\{f(c)\} + \{g(c)\}) \neq \emptyset \quad (155)$$

or

$$(M_1 \cup L_1 + M_2 \cup L_2) \cap (M_1 \cup R_1 + M_2 \cup R_2) \cap (M_1 \cup V_1 + M_2 \cup V_2) \neq \emptyset. \quad (156)$$

But this intersection is non-empty, because:

if $m_1 \in M_1 \neq \emptyset$ and $m_2 \in M_2 \neq \emptyset$,

then $m_1 \in M_1 \cup L_1$, and $m_1 \in M_1 \cup R_1$, and $m_1 \in M_1 \cup V_1$

(*)

and $m_2 \in M_2 \cup L_2$, and $m_2 \in M_2 \cup R_2$, and $m_2 \in M_2 \cup V_2$

(**)

whence $m_1 + m_2 \in M_1 \cup L_1 + M_2 \cup L_2$,

and $m_1 + m_2 \in M_1 \cup R_1 + M_2 \cup R_2$,

and $m_1 + m_2 \in M_1 \cup V_1 + M_2 \cup V_2$.

Therefore $(f + g)(x)$ is also mereo-continuity neutrosophic function at $x = c$.

Analogously, one can prove that $f - g$, $f \cdot g$ and $\frac{f}{g}$ are neutrosophic mereo-continuous functions at $x = c$.

From above, one has:

$$m_1 - m_2 \in M_1 \cup L_1 - M_2 \cup L_2; \quad (157)$$

$$m_1 - m_2 \in M_1 \cup R_1 - M_2 \cup R_2; \quad (158)$$

$$m_1 - m_2 \in M_1 \cup V_1 - M_2 \cup V_2. \quad (159)$$

therefore $(f - g)(x)$ is a neutrosophic mereo-continuous function at $x = c$.

Again, from above one has:

$$m_1 \cdot m_2 \in (M_1 \cup L_1) \cdot (M_2 \cup L_2); \quad (160)$$

$$m_1 \cdot m_2 \in (M_1 \cup R_1) \cdot (M_2 \cup R_2); \quad (161)$$

$$m_1 \cdot m_2 \in (M_1 \cup V_1) \cdot (M_2 \cup V_2). \quad (162)$$

therefore $(f \cdot g)(x)$ is a neutrosophic mereo-continuous function at $x = c$.

And, from (*) and (**) one has:

$$\frac{m_1}{m_2} \in \frac{M_1 \cup L_1}{M_2 \cup L_2}; \quad (163)$$

$$\frac{m_1}{m_2} \in \frac{M_1 \cup R_1}{M_2 \cup R_2}; \quad (164)$$

$$\frac{m_1}{m_2} \in \frac{M_1 \cup V_1}{M_2 \cup V_2}. \quad (165)$$

therefore $\left(\frac{f}{g}\right)(x)$ is a neutrosophic mereo-continuous function at $x = c$.

III.16. Properties of Neutrosophic Continuity

Similarly to the classical calculus, if $f(x), g(x)$ are neutrosophic continuous functions at $x = c$, and $\alpha \in \mathbb{R}$ is a scalar, then $\alpha \cdot f(x), (f + g)(x), (f - g)(x), (fg)x$, and $\left(\frac{f}{g}\right)x$ for $g(x) \neq c$ are neutrosophic continuous functions at $x = c$.

The proofs are straightforward as in classical calculus.

Since $f(x)$ and $g(x)$ are neutrosophic continuous functions, one has:

$$\lim_{\substack{x \rightarrow c \\ x < c}} f(x) \equiv \lim_{\substack{x \rightarrow c \\ x > c}} f(x) \equiv f(c) \quad (166)$$

and
$$\lim_{\substack{x \rightarrow c \\ x < c}} g(x) \equiv \lim_{\substack{x \rightarrow c \\ x > c}} g(x) \equiv g(c) \quad (167)$$

1. If we multiply the relation (166) by α we get:

$$\alpha \cdot \lim_{\substack{x \rightarrow c \\ x < c}} f(x) \equiv \alpha \cdot \lim_{\substack{x \rightarrow c \\ x > c}} f(x) \equiv \alpha \cdot f(c) \quad (168)$$

or

$$\lim_{\substack{x \rightarrow c \\ x < c}} [\alpha \cdot f(x)] \equiv \lim_{\substack{x \rightarrow c \\ x > c}} [\alpha \cdot f(x)] \equiv \alpha \cdot f(c) \quad (169)$$

or $\alpha \cdot f(x)$ is a neutrosophic continuous function at $x = c$.

2. If we add relations (166) and (167) term by term, we get:

$$\lim_{\substack{x \rightarrow c \\ x < c}} f(x) + \lim_{\substack{x \rightarrow c \\ x < c}} g(x) \equiv \lim_{\substack{x \rightarrow c \\ x > c}} f(x) + \lim_{\substack{x \rightarrow c \\ x > c}} g(x) \equiv f(c) + g(c) \quad (170)$$

or

$$\lim_{\substack{x \rightarrow c \\ x < c}} [f(x) + g(x)] \equiv \lim_{\substack{x \rightarrow c \\ x > c}} [f(x) + g(x)] \equiv f(c) + g(c) \quad (171)$$

or $(f + g)(x)$ is a neutrosophic continuous function at $x = c$.

3. Similarly, if we subtract relations (166) and (167) term by term, we get:

$$\lim_{\substack{x \rightarrow c \\ x < c}} f(x) - \lim_{\substack{x \rightarrow c \\ x < c}} g(x) \equiv \lim_{\substack{x \rightarrow c \\ x > c}} f(x) - \lim_{\substack{x \rightarrow c \\ x > c}} g(x) \equiv f(c) - g(c) \quad (172)$$

or

$$\lim_{\substack{x \rightarrow c \\ x < c}} [f(x) - g(x)] \equiv \lim_{\substack{x \rightarrow c \\ x > c}} [f(x) - g(x)] \equiv f(c) - g(c) \quad (173)$$

or $(f - g)(x)$ is a neutrosophic continuous function at $x = c$.

4. If we multiply relations (166) and (167) term by term, we get:

$$\begin{aligned} \left[\lim_{\substack{x \rightarrow c \\ x < c}} f(x) \right] \cdot \left[\lim_{\substack{x \rightarrow c \\ x < c}} g(x) \right] &\equiv \left[\lim_{\substack{x \rightarrow c \\ x > c}} f(x) \right] \cdot \left[\lim_{\substack{x \rightarrow c \\ x > c}} g(x) \right] \\ &\equiv f(c) \cdot g(c) \end{aligned} \quad (174)$$

or

$$\lim_{\substack{x \rightarrow c \\ x < c}} [f(x) \cdot g(x)] \equiv \lim_{\substack{x \rightarrow c \\ x > c}} [f(x) \cdot g(x)] \equiv f(c) \cdot g(c) \quad (175)$$

or $(f \cdot g)(x)$ is a neutrosophic continuous function at $x = c$.

5. If we divide relations (166) and (167) term by term, supposing $g(x) \neq 0$ for all x , we get:

$$\frac{\lim_{x \rightarrow c} f(x)}{\lim_{x \rightarrow c} g(x)} \equiv \frac{\lim_{x \rightarrow c} f(x)}{\lim_{x \rightarrow c} g(x)} \equiv \frac{f(c)}{g(c)} \quad (176)$$

or

$$\lim_{x \rightarrow c} \left[\frac{f(x)}{g(x)} \right] \equiv \lim_{x \rightarrow c} \left[\frac{f(x)}{g(x)} \right] \equiv \frac{f(c)}{g(c)} \quad (177)$$

or $\left(\frac{f}{g}\right)(x)$ is a neutrosophic continuous function at $x = c$.

III.17. The M - δ Definition of the Neutrosophic Infinite Limits

The $M - \delta$ definition of the neutrosophic infinite limits are extensions of the classical infinite limits.

- a. $\lim_{x \rightarrow c} f(x) = +\infty$ means that $\forall M > 0, \exists \delta = \delta(M) > 0$, such that if $\eta(x, c) < \delta$, then $\inf\{f(x)\} > M$.
- b. $\lim_{x \rightarrow c} f(x) = -\infty$ means that $\forall N < 0, \exists \delta = \delta(N) > 0$, such that if $\eta(x, c) < \delta$, then $\sup\{f(x)\} < N$.

III.18. Examples of Neutrosophic Infinite Limits

1. Let's have the neutrosophic function $f(x) = \frac{[2, 5]}{x-1}$.

$$\lim_{\substack{x \rightarrow 1 \\ x < 1}} \frac{[2,5]}{x-1} = -\infty \quad (178)$$

and

$$\lim_{\substack{x \rightarrow 1 \\ x > 1}} \frac{[2,5]}{x-1} = +\infty . \quad (179)$$

Therefore, $x = 1$ is a vertical asymptote for $f(x)$.

Let's apply the definition for the neutrosophic left limit.

Let $N < 0$. If, for $x < 1$,

$$\eta(x, c) = \eta(x, 1) = |x - 1| < \frac{[2,5]}{|N|} = \delta(N) = \delta, \quad (180)$$

which is equivalent to

$$-\frac{[2,5]}{|N|} < x - 1 < \frac{[2,5]}{|N|} \quad (181)$$

then

$$f(x) = \frac{[2,5]}{x-1} < \frac{[2,5]}{-\frac{[2,5]}{|N|}} = -|N| = N \quad (182)$$

Therefore,

$$\lim_{\substack{x \rightarrow 1 \\ x < 1}} f(x) = -\infty \quad (183)$$

2. Let $g(x) = \frac{4}{(1,3)x^2}$.

$$\lim_{\substack{x \rightarrow 0 \\ x < 0}} \frac{4}{(1,3)x^2} = +\infty \quad (184)$$

and

$$\lim_{\substack{x \rightarrow 0 \\ x > 0}} \frac{4}{(1,3)x^2} = +\infty, \quad (185)$$

hence

$$\lim_{x \rightarrow 0} \frac{4}{(1,3)x^2} = +\infty. \quad (186)$$

Therefore $x = 0$ is a vertical asymptote for the neutrosophic function $g(x)$.

Let's apply the $M - \delta$ definition to compute the same limit.

Let $M > 0$. If

$$\eta(x, c) = \eta(x, 0) = \eta(x) = |x| < \frac{1}{(\sqrt{1}, \sqrt{3})\sqrt{M}} = \delta(m) = \delta \quad (187)$$

then

$$g(x) = \frac{4}{(1,3)x^2} > \frac{4}{(1,3) \cdot \left[\frac{1}{(\sqrt{1}, \sqrt{3})\sqrt{M}} \right]^2} = \frac{4}{(1,3) \cdot \frac{1}{(1,3)M}} =$$

$$\frac{4}{\frac{(1,3)/(1,3)}{M}} = 4M / \left(\frac{1}{3}, 3\right) =$$

because $(1,3)/(1,3) = (1/3, 3/1) = (1/3, 3)$

$$= \left(\frac{4}{3}M, 12M\right) = M\left(\frac{4}{3}, 12\right), \text{ and } \inf\{M\left(\frac{4}{3}, 12\right)\} = \frac{4}{3}M > M. \quad (188)$$

Therefore,

$$\lim_{x \rightarrow 0} g(x) = +\infty. \quad (189)$$

$$3. \text{ Let } h(x) = \frac{x^2+7}{x-(\text{either } 2 \text{ or } 3)} \quad (190)$$

be a neutrosophic function [meaning that we are not sure if it is $x - 2$ or $x - 3$], which is actually equivalent to either the classical function $h_1(x) = \frac{x^2+7}{x-2}$ or to the classical function $h_2(x) = \frac{x^2+7}{x-3}$.

$$(191)$$

Thus,

$$\lim_{\substack{x \rightarrow \text{either } 2 \text{ or } 3 \\ x < \text{either } 2 \text{ or } 3 \text{ respectively}}} \frac{x^2 + 7}{x - (\text{either } 2 \text{ or } 3)} = -\infty \quad (192)$$

and

$$\lim_{\substack{x \rightarrow \text{either } 2 \text{ or } 3 \\ x > \text{either } 2 \text{ or } 3 \text{ respectively}}} \frac{x^2 + 7}{x - (\text{either } 2 \text{ or } 3)} = +\infty \quad (193)$$

Therefore, either $x = 2$ or $x = 3$ is a vertical asymptote for $h(x)$.

4. Another type of neutrosophic limit:

$$\begin{aligned} & \lim_{x \rightarrow 2+3I} \frac{x^2 + (1+I)x}{2x + 4 - 6I} \\ &= \frac{(2+3I)^2 + (1+I)(2+3I)}{2(2+3I) + 4 - 6I} \\ &= \frac{4 + 12I + 9I^2 + 2 + 3I + 2I + 3I^2}{4 + 6I + 4 - 6I} \\ &= \frac{6 + 17I + 12I^2}{8} = \frac{6 + 17I + 12I}{8} = \frac{6 + 29I}{8} \\ &= \frac{6}{8} + \frac{29}{8}I, \end{aligned}$$

where $I =$ indeterminacy with $0 \cdot I = 0$ and $I^2 = I$. (194)

III.19. Set-Argument Set-Values Function

$$f: \mathcal{P}(M) \rightarrow \mathcal{P}(N), f(A) = B, \quad (195)$$

where M and N are sets, $A \in \mathcal{P}(M)$ or $A \subseteq M$, and $B \in \mathcal{P}(N)$ or $B \subseteq N$.

This is a *generalization of the interval-argument interval-valued function*.

Example:

$$f: \mathcal{P}(R) \rightarrow \mathcal{P}(R) \quad (196)$$

$$f(\{1, 3, 5\}) = \{2, 6\} \quad (197)$$

$$f([1, 4]) = [2, 3] \quad (198)$$

$$f((1, 0)) = 5 \quad (199)$$

$$f([-2, 3) \cup \{6\}) = x^2 = [4, 9) \cup \{36\}. \quad (200)$$

$\mathcal{P}(M)$ is the set of all subsets of M , and $\mathcal{P}(N)$ is the set of all subsets of N .

The partial-metric η and the norm μ are very well defined on $\mathcal{P}(M)$ and $\mathcal{P}(N)$, and the definitions of neutrosophic limit, neutrosophic continuity, neutrosophic derivative, and neutrosophic integral are extensions from classical calculus definitions by using the partial-metric η and/or the norm μ .

III.20. Neutrosophic Derivative

The general definition of the *neutrosophic derivative* of function $f_N(x)$ is:

$$f'_N(X) = \lim_{\mu(H) \rightarrow 0} \frac{\langle \inf f(X+H) - \inf f(X), \sup f(X+H) - \sup f(X) \rangle}{H}, \quad (201)$$

where $\langle a, b \rangle$ means any kind of open / closed / half open-closed interval.

As particular definitions for the cases when H is an interval one has:

$$f'_N(X) = \lim_{[\inf H, \sup H] \rightarrow [0, 0]} \frac{[\inf f(X+H) - \inf f(X), \sup f(X+H) - \sup f(X)]}{[\inf H, \sup H]} \quad (202)$$

is the neutrosophic derivative of $f(X)$.

In a simplified way, one has:

$$f'_N(X) = \lim_{h \rightarrow 0} \frac{[\inf f(X+h) - \inf f(X), \sup f(X+h) - \sup f(X)]}{h}. \quad (203)$$

Both definition above are generalizations of the classical derivative definition, since for crisp functions and crisp variables one has:

$$[\inf H, \sup H] \equiv h \quad (204)$$

$$\text{and } \inf f(X+H) \equiv \sup f(x+H) \equiv f(x+h) \quad (205)$$

$$\inf f(X) \equiv \sup f(X) \equiv f(x). \quad (206)$$

Let's see some examples:

$$1) f(X) = [2x^3 + 7x, x^5]. \quad (207)$$

$$\begin{aligned}
 & f'_N(X) \\
 &= \lim_{h \rightarrow 0} \frac{[2(x+h)^3 + 7(x+h) - 2x^3 - 7x, (x+h)^5 - x^5]}{h} \\
 &= \left[\lim_{h \rightarrow 0} \frac{2(x+h)^3 + 7(x+h) - 2x^3 - 7x}{h}, \lim_{h \rightarrow 0} \frac{(x+h)^5 - x^5}{h} \right] \\
 &= \left[\frac{d}{dx}(2x^3 + 7x), \frac{d}{dx}(x^5) \right] = [6x^2 + 7, 5x^4].
 \end{aligned}
 \tag{208}$$

2) Let $g: R \rightarrow \mathcal{P}(R)$, by

$$g(x) = \begin{cases} [f_1(x), f_2(x)], & \text{if } x \leq 5; \\ [f_3(x), f_4(x)], & \text{if } x > 5. \end{cases}
 \tag{209}$$

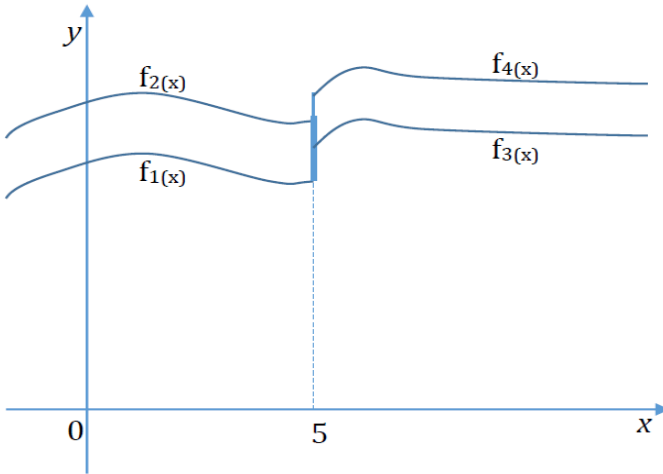

Graph 23.

Any classical function f is differentiable at a given point $x = c$ if: f is continuous at $x = c$, f is smooth at $x = c$, and f does not have a vertical tangent at $x = c$.

While $g(x)$ is neutrosophically differentiable on $\mathbb{R} \setminus \{5\}$ if $f_1, f_2, f_3,$ and f_4 are differentiable:

$$g'(x) = \begin{cases} [f'_1(x), f'_2(x)], & \text{if } x < 5; \\ [f'_3(x), f'_4(x)], & \text{if } x > 5. \end{cases} \quad (210)$$

At $x = 5$, the neutrosophic function $g(x)$ is differentiable if:

$$[f'_1(5), f'_2(5)] \equiv [f'_3(5), f'_4(5)], \quad (211)$$

otherwise $g(x)$ has a mereo-derivative at $x = 5$ (as in the above figure) if

$$[f'_1(5), f'_2(5)] \cap [f'_3(5), f'_4(5)] \neq \emptyset, \quad (212)$$

or $g(x)$ is not differentiable at $x = 5$ if

$$[f'_1(5), f'_2(5)] \cap [f'_3(5), f'_4(5)] = \emptyset. \quad (213)$$

3) Another example of neutrosophic derivative.

Let $f : \mathbb{R} \rightarrow \mathbb{R} \cup \{I\}$, where $I =$ indeterminacy,

$$f(x) = 3x - x^2I \quad (214)$$

$$\begin{aligned} f'(x) &= \lim_{h \rightarrow 0} \frac{f(x+h) - f(x)}{h} \\ &= \lim_{h \rightarrow 0} \frac{[3(x+h) - (x+h)^2I] - [3x - x^2I]}{h} \\ &= \lim_{h \rightarrow 0} \frac{3x + 3h - x^2I - 2xhI - h^2I - 3x + x^2I}{h} \\ &= \lim_{h \rightarrow 0} \frac{h(3 - 2xI - hI)}{h} = 3 - 2xI - 0 \cdot I = 3 - 2xI. \end{aligned} \quad (215)$$

Therefore, directly

$$f'(x) = \frac{d}{dx}(3x) - \frac{d}{dx}(x^2I) = 3 - I \frac{d}{dx}(x^2) = 3 - 2xI. \quad (216)$$

4) An example with refined indeterminacy:

I_1 = indeterminacy of first type;

I_2 = indeterminacy of second type.

$$\text{Let } g: \mathbb{R} \rightarrow \mathbb{R} \cup \{I_1\} \cup \{I_2\}, \quad (217)$$

$$g(x) = -x + 2xI_1 + 5x^3I_2, \quad (218)$$

$$\begin{aligned} \text{Then } g'(x) &= \frac{d}{dx}(-x) + \frac{d}{dx}(2xI_1) + \frac{d}{dx}(5x^3I_2) = \\ &-1 + 2I_1 + 15x^2I_2. \end{aligned} \quad (219)$$

III.21. Neutrosophic Indefinite Integral

We just extend the classical definition of anti-derivative.

The *neutrosophic antiderivative* of neutrosophic function $f(x)$ is the neutrosophic function $F(x)$ such that

$$F'(x) = f(x).$$

For example,

1. Let $f: R \rightarrow R \cup \{I\}$, $f(x) = 5x^2 + (3x + 1)I$. (220)

Then,

$$\begin{aligned} F(X) &= \int [5x^2 + (3x + 1)I] dx \\ &= \int 5x^2 dx \\ &+ \int (3x + 1)I dx \\ &= 5 \cdot \frac{x^3}{3} + I \int (3x + 1) dx = \frac{5x^3}{3} \\ &+ \left(\frac{3x^2}{2} + x \right) I + C, \end{aligned} \tag{221}$$

where C is an *indeterminate real constant* (i.e. constant of the form $a+bI$, where a, b are real numbers, while $I =$ indeterminacy).

2. Refined Indeterminacy.

$$\text{Let } g: \mathbb{R} \rightarrow \mathbb{R} \cup \{I_1\} \cup \{I_2\} \cup \{I_3\}, \tag{222}$$

were $I_1, I_2,$ and I_3 are types of subindeterminacies,

$$g(x) = -5 + 2I_1 - x^4I_2 + 7xI_3. \tag{223}$$

Then,

$$\int g(x)dx = \int[-5 + 2I_1 - x^4I_2 + 7xI_3]dx = -5x + 2xI_1 - \frac{x^5}{5}I_2 + \frac{7x^2}{2}I_3 + a + bI, \text{ where } a \text{ and } b \text{ are real constants.} \quad (224)$$

III.22. Neutrosophic Definite Integral

$$1. \text{ Let } h: \mathbb{R} \rightarrow \mathcal{P}(\mathbb{R}) \quad (225)$$

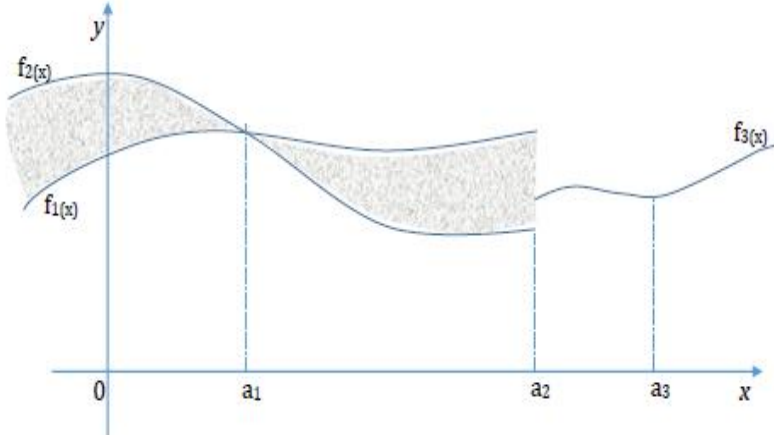

Graph 24.

such that

$$h(x) = \begin{cases} [f_1(x), f_2(x)], & \text{if } x \leq a_2 \\ f_3(x), & \text{if } x > a_2 \end{cases} \quad (226)$$

$h(x)$ is a thick neutrosophic function for $x \in (-\infty, a_2]$, and a classical function for $x \in (a_2, +\infty)$.

We now compute the *neutrosophic definite integral*:

$$\begin{aligned} \alpha &= \int_0^{a_3} h(x) dx = \int_0^{a_1} [f_1(x), f_2(x)] dx + \\ &\int_{a_1}^{a_2} [f_2(x), f_1(x)] dx + \int_{a_2}^{a_3} f_3(x) dx = \left[\int_0^{a_1} f_1(x) dx, \int_0^{a_1} f_2(x) dx \right] + \\ &\left[\int_{a_1}^{a_2} f_2(x) dx, \int_{a_1}^{a_2} f_1(x) dx \right] + \int_{a_2}^{a_3} f_3(x) dx = [A, B] + \\ &[C, D] + [E, E] = [A + C + E, B + D + E], \end{aligned} \quad (227)$$

where, of course,

$$A = \int_0^{a_1} f_1(x)dx, B = \int_0^{a_1} f_2(x)dx, C = \int_{a_1}^{a_2} f_2(x)dx, \\ D = \int_{a_1}^{a_2} f_1(x)dx, \text{ and } E = \int_{a_2}^{a_3} f_3(x)dx.. \tag{228}$$

Since $h(x)$ is a thick function between 0 and a_2 , we interpret the result α of our neutrosophic definite integral in general as:

$$\alpha \in [A + C + E, B + D + E], \tag{229}$$

since one may take: $\alpha = A + B + E$ as in classical calculus (i.e. the area are below the lowest curve), or an average:

$$\alpha = \frac{(A + C + E) + (B + D + E)}{2} \\ = \frac{A + B + C + D}{2} + E \tag{230}$$

(i.e. the area below a curve passing through the middle of the shaded area), or the maximum possible area:

$$\alpha = B + D + E. \tag{231}$$

Depending on the nature of the solved problem, a neutrosophic expert can choose the most appropriate

$$\alpha \in [A + C + E, B + D + E]. \tag{232}$$

III.23. Simple Definition of Neutrosophic Definite Integral

Let f_N be a neutrosophic function

$$f_N: \mathbb{R} \rightarrow \mathcal{P}(\mathbb{R}) \tag{233}$$

which is continuous or mereo-continuous on the interval $[a, b]$. Then,

$$\int_a^b f_N(x) dx = \lim_{n \rightarrow \infty} \sum_{i=1}^n f_N(C_i) \frac{b-a}{n} \tag{234}$$

where $C_i \in [x_{i-1}, x_i]$, for $i \in \{1, 2, \dots, n\}$, and $a \equiv x_0 < x_1 < x_2 < \dots < x_{n-1} < x_n \equiv b$ are subdivision of the interval $[a, b]$: exactly as the definition of the classical integral, but $f_N(C_i)$ may be a real set (not necessarily a crisp real number as in classical calculus), or $f_N(C_i)$ may have some indeterminacy.

III.24. General Definition of Neutrosophic Definite Integral

Let

$$f_N: \mathcal{P}(M), \rightarrow \mathcal{P}(N), \tag{235}$$

where M, N are given sets, and $\mathcal{P}(M)$ and $\mathcal{P}(N)$ are the power sets of M and N respectively.

f_N is a set-argument set-valued function which, in addition, has some indeterminacy. So, f_N is a neutrosophic set-argument set-valued function.

f_N maps a set in M into a set in N . Therefore, $A, B \in \mathcal{P}(M)$. Then:

$$\int_A^B f_N(x) dx = \lim_{n \rightarrow \infty} \sum_{i=1}^n f_N(C_i) \cdot \frac{\eta(B,A)}{n}, \tag{236}$$

where

$\inf A \equiv \inf x_0 < \inf x_1 < \dots < \inf x_{n-1} < \inf x_n \equiv \inf B$
 $\sup A \equiv \sup x_0 < \sup x_1 < \dots < \sup x_{n-1} < \sup x_n \equiv \sup B$
 and $(C_i) \in \mathcal{P}(M)$ such that:

$$\inf X_{i-1} \leq \inf C_i \leq \inf X_i$$

and

$$\sup X_{i-1} \leq \sup C_i \leq \sup X_i, \text{ for } i \in \{1, 2, \dots, n\}.$$

Therefore, the neutrosophic integral *lower and upper limits* are sets (not necessarily crisp numbers as in classical calculus), C_i , for all $i \in \{1, 2, \dots, n\}$, and similarly $f_N(C_i)$ are sets (not crisp numbers as in classical calculus). And, in addition, there may be some indeterminacy as well with respect to their values.

IV. Conclusion

Neutrosophic Analysis is a generalization of Set Analysis, which in its turn is a generalization of Interval Analysis.

Neutrosophic Precalculus is referred to indeterminate staticity, while Neutrosophic Calculus is the mathematics of indeterminate change.

The Neutrosophic Precalculus and Neutrosophic Calculus can be developed in many ways, depending on the types of indeterminacy one has and on the methods used to deal with such indeterminacy.

We introduce for the first time the notions of *neutrosophic mereo-limit*, *neutrosophic mereo-continuity* (in a different way from the classical semi-continuity), *neutrosophic mereo-derivative* and *neutrosophic mereo-integral* (both in different ways from the fractional calculus), besides the classical definitions of limit, continuity, derivative, and integral respectively.

Future research can be done in neutrosophic fractional calculus.

In this book, we present a few examples of indeterminacies and several methods to deal with these specific indeterminacies, but many other indeterminacies there exist in our everyday life, and they have to be studied and resolved using similar of different methods. Therefore, more research should to be done in the field of neutrosophics.

V. References

Published Papers and Books

- [1] Agboola A.A.A., On Refined Neutrosophic Algebraic Structures, in Neutrosophic Sets and Systems, Vol. 9, 2015.
- [2] Broumi S., Smarandache F., Several Similarity Measures of Neutrosophic Sets, in Neutrosophic Sets and Systems, 54-62, Vol. 1, 2013.
- [3] Broumi S., Smarandache F., Neutrosophic Refined Similarity Measure Based on Cosine Function, in Neutrosophic Sets and Systems, 42-48, Vol. 6, 2014.
- [4] Broumi S., Smarandache F., Dhar M., Rough Neutrosophic Set, in Neutrosophic Sets and Systems, Vol. 3, 60-65, 2014.
- [5] Broumi S., Smarandache F., On Neutrosophic Implications, in Neutrosophic Sets and Systems, 9-17, Vol. 2, 2014.
- [6] Broumi S., Deli I., Smarandache F., N-Valued Interval Neutrosophic Sets and Their Application in Medical Diagnosis, in Critical Review, Center for Mathematics of Uncertainty, Creighton University, Omaha, NE, USA, Vol. X, 45-69, 2015.
- [7] Broumi S., Smarandache F., Cosine Similarity Measure of Interval Valued Neutrosophic Sets, in Neutrosophic Sets and Systems, Vol. 5, 15-20, 2014; also in Critical Review, Center for Mathematics of Uncertainty, Creighton University, USA, Vol. IX, 28-32, 2015.
- [8] Broumi S., Ye J., Smarandache F., An Extended TOPSIS Method for Multiple Attribute Decision Making based on Interval Neutrosophic Uncertain Linguistic

- Variables, in Neutrosophic Sets and Systems, 23-32, Vol. 8, 2015.
- [9] Broumi S., Smarandache F., Interval Neutrosophic Rough Set, in Neutrosophic Sets and Systems, UNM, Vol. 7, 23-31, 2015.
- [10] Broumi S., Smarandache F., Soft Interval-Valued Neutrosophic Rough Sets, in Neutrosophic Sets and Systems, UNM, Vol. 7, 69-80, 2015.
- [11] Dhar M., Broumi S., Smarandache F., A Note on Square Neutrosophic Fuzzy Matrices, in Neutrosophic Sets and Systems, Vol. 3, 37-41, 2014.
- [12] Farahani H., Smarandache F., Wang L. L., A Comparison of Combined Overlap Block Fuzzy Cognitive Maps (COBFCM) and Combined Overlap Block Neutrosophic Cognitive Map (COBNCM) in Finding the Hidden Patterns and Indeterminacies in Psychological Causal Models: Case Study of ADHD, in Critical Review, Center for Mathematics of Uncertainty, Creighton University, Omaha, NE, USA, Vol. X, 70-84, 2015.
- [13] Kandasamy W. B. Vasantha, Smarandache F., Fuzzy Cognitive Maps and Neutrosophic Cognitive Maps, Xiquan, Phoenix, 211 p., 2003.
- [14] Kandasamy W. B. Vasantha, Smarandache F., Dual Numbers, Zip Publ., Ohio, 2012.
- [15] Kandasamy W. B. Vasantha, Smarandache F., Special Dual like Numbers and Lattices, Zip. Publ., Ohio, 2012.
- [16] Kandasamy W. B. Vasantha, Smarandache F., Special Quasi Dual Numbers and Groupoids, Zip Publ., 2012.

- [17] Kandasamy W. B. Vasantha, Smarandache F., Neutrosophic Lattices, in Neutrosophic Sets and Systems 42-47, Vol. 2, 2014.
- [18] Mukherjee A., Datta M., Smarandache F., Interval Valued Neutrosophic Soft Topological Spaces, in Neutrosophic Sets and Systems, Vol. 6, 18-27, 2014.
- [19] Mumtaz Ali, Smarandache F., Shabir Muhammad, Naz Munazza, Soft Neutrosophic Bigroup and Soft Neutrosophic N-Group, in Neutrosophic Sets and Systems, 55-81, Vol. 2, 2014.
- [20] Mumtaz Ali, Smarandache F., Vladareanu L., Shabir M., Generalization of Soft Neutrosophic Rings and Soft Neutrosophic Fields, in Neutrosophic Sets and Systems, Vol. 6, 35-41, 2014.
- [21] Mumtaz Ali, Smarandache F., Shabir M., Soft Neutrosophic Groupoids and Their Generalization, in Neutrosophic Sets and Systems, Vol. 6, 61-81, 2014.
- [22] Mumtaz Ali, Smarandache F., Shabir M., Naz M., Neutrosophic Bi-LA-Semigroup and Neutrosophic N-LASemigroup, in Neutrosophic Sets and Systems, Vol. 4, 19-24, 2014.
- [23] Mumtaz Ali, Smarandache F., Shabir M., Soft Neutrosophic Bi-LA-Semigroup and Soft Neutrosophic N-LA-Semigroup, in Neutrosophic Sets and Systems, Vol. 5, 45-54, 2014.
- [24] Mumtaz Ali, Smarandache F., Shabir M., Vladareanu L., Generalization of Neutrosophic Rings and Neutrosophic Fields, in Neutrosophic Sets and Systems, Vol. 5, 9-14, 2014.

- [25] Mumtaz Ali, Dyer C., Shabir M., Smarandache F., Soft Neutrosophic Loops and Their Generalization, in Neutrosophic Sets and Systems, Vol. 4, 55-75, 2014.
- [26] Mumtaz Ali, Shabir M., Naz M., Smarandache F., Neutrosophic Left Almost Semigroup, in Neutrosophic Sets and Systems, Vol. 3, 18-28, 2014.
- [27] Mumtaz Ali, Smarandache F., Shabir M., Naz M., Soft Neutrosophic Ring and Soft Neutrosophic Field, in Neutrosophic Sets and Systems, Vol. 3, 53-59, 2014.
- [28] Mumtaz Ali, Shabir M., Smarandache F., Vladareanu L., Neutrosophic LA-semigroup Rings, in Neutrosophic Sets and Systems, UNM, Vol. 7, 81-88, 2015.
- [29] Mumtaz Ali, Smarandache F., Broumi S., Shabir M., A New Approach to Multi-Spaces through the Application of Soft Sets, in Neutrosophic Sets and Systems, UNM, Vol. 7, 34-39, 2015.
- [30] Olariu S., Complex Numbers in n Dimensions, Elsevier Publication, 2002.
- [31] Salama A. A., Smarandache F., Filters via Neutrosophic Crisp Sets, in Neutrosophic Sets and Systems, 34-37, Vol. 1, 2013.
- [32] Salama A. A., Smarandache F., Neutrosophic Crisp Theory, in Neutrosophic Sets and Systems, Vol. 5, 27-35, 2014.
- [33] Salama A. A., Smarandache F., Kroumov Valeri, Neutrosophic Crisp Sets & Neutrosophic Crisp Topological Spaces, in Neutrosophic Sets and Systems, 25-30, Vol. 2, 2014.

- [34] Salama A. A., Smarandache F., Eisa M., Introduction to Image Processing via Neutrosophic Technique, in Neutrosophic Sets and Systems, Vol. 5, 59-64, 2014.
- [35] Salama A. A., Smarandache F., Kroumov V., Neutrosophic Closed Set and Neutrosophic Continuous Functions, in Neutrosophic Sets and Systems, Vol. 4, 4-8, 2014.
- [36] Salama A. A., Smarandache F., Alblowi S. A., New Neutrosophic Crisp Topological Concept, in Neutrosophic Sets and Systems, Vol. 4, 50-54, 2014.
- [37] Salama A. A., Smarandache F., Alblowi S. A., The Characteristic Function of a Neutrosophic Set, in Neutrosophic Sets and Systems, Vol. 3, 14-17, 2014.
- [38] Salama A. A., El-Ghareeb H.A., Smarandache F., et. al., Introduction to Develop Some Software Programes for dealing with Neutrosophic Sets, in Neutrosophic Sets and Systems, Vol. 3, 51-52, 2014.
- [39] Shabir Muhammad, Mumtaz Ali, Naz Munazza, Smarandache F., Soft Neutrosophic Group, in Neutrosophic Sets and Systems, 13-25, Vol. 1, 2013.
- [40] Smarandache F., Neutrosophy, in Neutrosophic Probability, Set, and Logic, Amer. Res. Press, Rehoboth, USA, 105 p., 1998.
- [41] Smarandache F., n-Valued Refined Neutrosophic Logic and Its Applications in Physics, in Progress in Physics, 143-146, Vol. 4, 2013.
- [42] Smarandache F., Neutrosophic Measure and Neutrosophic Integral, in Neutrosophic Sets and Systems, 3-7, Vol. 1, 2013.

- [43] Smarandache F., Vladutescu Stefan, Communication vs. Information, an Axiomatic Neutrosophic Solution, in Neutrosophic Sets and Systems, 38-45, Vol. 1, 2013.
- [44] Smarandache F., Introduction to Neutrosophic Measure, Neutrosophic Integral, and Neutrosophic Probability, Sitech & Educational, Craiova, Columbus, 140 p., 2013.
- [45] Smarandache F., Introduction to Neutrosophic Statistics, Sitech and Education Publisher, Craiova, 123 p., 2014.
- [46] Smarandache F., (t,i,f)-Neutrosophic Structures and I-Neutrosophic Structures, in Neutrosophic Sets and Systems, 3- 10, Vol. 8, 2015.
- [47] Smarandache F., Thesis-Antithesis-Neutrothesis, and Neutrosynthesis, in Neutrosophic Sets and Systems, 64-67, Vol. 8, 2015.
- [48] Smarandache F., Refined Literal Indeterminacy and the Multiplication Law of Subindeterminacies, in Neutrosophic Sets and Systems, Vol. 9, 2015.
- [49] Smarandache F., Neutrosophic Axiomatic System, in Critical Review, Center for Mathematics of Uncertainty, Creighton University, Omaha, NE, USA, Vol. X, 5-28, 2015.
- [50] Ye Jun, Multiple-Attribute Group Decision-Making Method under a Neutrosophic Number Environment, Journal of Intelligent Systems, DOI: 10.1515/jisys-2014-0149.

Other Articles on Neutrosophics

- [1] Said Broumi, Florentin Smarandache, Correlation Coefficient of Interval Neutrosophic Set, in „Applied Mechanics and Materials”, Vol. 436 (2013), pp. 511-517, 8 p.
- [2] Said Broumi, Ridvan Sahin, Florentin Smarandache, Generalized Interval Neutrosophic Soft Set and its Decision Making Problem, in „Journal of New Research in Science”, No. 7 (2014), pp. 29-47, 19 p.
- [3] Mumtaz Ali, Florentin Smarandache, Munazza Naz, Muhammad Shabir, G-Neutrosophic Space, in „U.P.B. Sci. Bull.”, 11 p.
- [4] Said Broumi, Irfan Deli, Florentin Smarandache, Interval Valued Neutrosophic Parameterized Soft Set Theory and its Decision Making, in „Journal of New Research in Science”, No. 7 (2014), pp. 58-71, 14 p.
- [5] Said Broumi, Florentin Smarandache, Intuitionistic Neutrosophic Soft Set, in „Journal of Information and Computing Science”, Vol. 8, No. 2, 2013, pp. 130-140, 11 p.
- [6] Said Broumi, Florentin Smarandache, Pabitra Kumar Maji, Intuitionistic Neutrosophic Soft Set over Rings, in „Mathematics and Statistics”, No. 2(3), 2014, pp. 120-126, DOI: 10.13189/ms.2014.020303, 7 p.
- [7] Said Broumi, Florentin Smarandache, Lower and Upper Soft Interval Valued Neutrosophic Rough Approximations of An IVNSS-Relation, at SISOM & ACOUSTICS 2014, Bucharest 22-23 May, 8 p.
- [8] Said Broumi, Florentin Smarandache , More on Intuitionistic Neutrosophic Soft Sets, in „Computer Science

- and Information Technology”, No. 1(4), 2013, pp. 257-268, DOI: 10.13189/csit.2013.010404, 12 p.
- [9] A. A. Salama, Said Broumi, Florentin Smarandache, Neutrosophic Crisp Open Set and Neutrosophic Crisp Continuity via Neutrosophic Crisp Ideals, in „I.J. Information Engineering and Electronic Business”, No. 3, 2014, pp. 1-8, DOI: 10.5815/ijieeb.2014.03.01, 8 p.
- [10] Florentin Smarandache, Ștefan Vlăduțescu, Neutrosophic Principle of Interconvertibility Matter-Energy-Information, in „Journal of Information Science”, 2014, pp. 1-9, DOI: 10.1177/0165551510000000, 9 p.
- [11] Florentin Smarandache, Mumtaz Ali, Munazza Naz, Muhammad Shabir, Soft Neutrosophic Left Almost Semigroup, at SISOM & ACOUSTICS 2014, Bucharest 22-23 May
- [12] Mumtaz Ali, Muhammad Shabir, Munazza Naz, Florentin Smarandache, Soft neutrosophic semigroups and their generalization, in „Scientia Magna”, Vol. 10 (2014), No. 1, pp. 93-111, 19 p.
- [13] A. A. Salama, Said Broumi, Florentin Smarandache, Some Types of Neutrosophic Crisp Sets and Neutrosophic Crisp Relations, in „I.J. Information Engineering and Electronic Business”, 2014, 9 p.
- [14] Vasile Patrascu, Neutrosophic information in the framework of multi-valued representation, CAIM, Romanian Society of Applied and Industrial Mathematics et al., 19-22 September 2013, Bucharest, Romania.
- [15] N-norm and N-conorm in Neutrosophic Logic and Set, and the Neutrosophic Topologies (2005), in Critical Review, Creighton University, Vol. III, 73-83, 2009.

- [16] F. Smarandache, V. Christianto, n-ary Fuzzy Logic and Neutrosophic Logic Operators, in <Studies in Logic Grammar and Rhetoric>, Belarus, 17 (30), 1-16, 2009.
- [17] F. Smarandache, V. Christianto, F. Liu, Haibin Wang, Yanqing Zhang, Rajshekhar Sunderraman, André Rogatko, Andrew Schumann, Neutrosophic Logic and Set, and Paradoxes chapters, in Multispace & Multistructure. Neutrosophic Transdisciplinarity, NESP, Finland, pp. 395-548 and respectively 604-631, 2010.
- [18] Florentin Smarandache, The Neutrosophic Research Method in Scientific and Humanistic Fields, in Multispace and Multistructure, Vol. 4, 732-733, 2010.
- [19] Haibin Wang, Florentin Smarandache, Yanqing Zhang, Rajshekhar Sunderraman, Single Valued Neutrosophic Sets, in Multispace and Multistructure, Vol. 4, 410-413, 2010.
- [20] Pabitra Kumar Maji, Neutrosophic Soft Set, Annals of Fuzzy Mathematics and Informatics, Vol. 5, No. 1, 157-168, January 2013.
- [21] Pabitra Kumar Maji, A Neutrosophic Soft Set Approach to A Decision Making Problem, Annals of Fuzzy Mathematics and Informatics, Vol. 3, No. 2, 313-319, April 2012.
- [22] I. M. Hanafy, A. A. Salama, K. M. Mahfouz, Correlation Coefficients of Neutrosophic Sets by Centroid Method, , International Journal of Probability and Statistics 2013, 2(1): 9-12.
- [23] Maikel Leyva-Vazquez, K. Perez-Teruel, F. Smarandache, Análisis de textos de José Martí utilizando mapas cognitivos neutrosóficos, por, 2013, <http://vixra.org/abs/1303.021>
- [24] I. M. Hanafy, A.A.Salama and K. Mahfouz, Correlation of Neutrosophic Data, International Refereed Journal of

- Engineering and Science (IRJES), Vol. 1, Issue 2, 39-43, 2012.
- [25] A. A. Salama & H. Alagamy, Neutrosophic Filters, International Journal of Computer Science Engineering and Information Technology Research (IJCSEITR), Vol. 3, Issue 1, Mar 2013, 307-312.
- [26] Florentin Smarandache, Neutrosophic Masses & Indeterminate Models. Applications to Information Fusion, Proceedings of the 15th International Conference on Information Fusion, Singapore, 9-12 July 2012.
- [27] Tzung-Pei Hong, Yasuo Kudo, Mineichi Kudo, Tsau-Young Lin, Been-Chian Chien, Shyue-Liang Wang, Masahiro Inuiguchi, GuiLong Liu, A Geometric Interpretation of the Neutrosophic Set – A Generalization of the Intuitionistic Fuzzy Set, 2011 IEEE International Conference on Granular Computing, edited, IEEE Computer Society, National University of Kaohsiung, Taiwan, 602-606, 8-10 November 2011.
- [28] Florentin Smarandache, Luige Vladareanu, Applications of Neutrosophic Logic to Robotics / An Introduction, 2011 IEEE International Conference on Granular Computing, edited by Tzung-Pei Hong, Yasuo Kudo, Mineichi Kudo, Tsau-Young Lin, Been-Chian Chien, Shyue-Liang Wang, Masahiro Inuiguchi, GuiLong Liu, IEEE Computer Society, National University of Kaohsiung, Taiwan, 607-612, 8-10 November 2011.
- [29] Said Broumi, F. Smarandache, Intuitionistic Neutrosophic Soft Set, Journal of Information and Computing Science, Vol. 8, No. 2, 2013, pp. 130-140.

- [30] Wen Ju and H. D. Cheng, A Novel Neutrosophic Logic SVM (N-SVM) and its Application to Image Categorization, *New Mathematics and Natural Computation (World Scientific)*, Vol. 9, No. 1, 27-42, 2013.
- [31] A. Victor Devadoss, M. Clement Joe Anand, Activism and Nations Building in Pervasive Social Computing Using Neutrosophic Cognitive Maps (NCMs), *International Journal of Computing Algorithm*, Volume: 02, Pages: 257-262, October 2013.
- [32] Ling Zhang, Ming Zhang, H. D. Cheng, Color Image Segmentation Based on Neutrosophic Method, in *Optical Engineering*, 51(3), 037009, 2012.
- [33] A.Victor Devadoss, M. Clement Joe Anand, A. Joseph Bellarmin, A Study of Quality in Primary Education Combined Disjoint Block Neutrosophic Cognitive Maps (CDBNCM), *Indo-Bhutan International Conference On Gross National Happiness* Vol. 02, Pages: 256-261, October 2013.
- [34] Ming Zhang, Ling Zhang, H. D. Cheng, Segmentation of Breast Ultrasound Images Based on Neutrosophic Method, *Optical Engineering*, 49(11), 117001-117012, 2010.
- [35] Ming Zhang, Ling Zhang, H. D. Cheng, A Neutrosophic Approach to Image Segmentation Based on Watershed Approach, *Signal Processing*, 90(5), 1510-1517, 2010.
- [36] Florentin Smarandache, Strategy on T, I, F Operators. A Kernel Infrastructure in Neutrosophic Logic, in *Multispace and Multistructure*, Vol. 4, 414-419, 2010.
- [37] Pinaki Majumdar & S. K. Samanta, On Similarity and Entropy of Neutrosophic Sets, *M.U.C Women College, Burdwan (W. B.), India*, 2013.

- [38] Mohammad Reza Faraji and Xiaojun Qi, An Effective Neutrosophic Set-Based Preprocessing Method for Face Recognition, Utah State University, Logan, 2013.
- [39] Liu Feng, Florentin Smarandache, Toward Dialectic Matter Element of Extenics Model, in Multispace and Multistructure, Vol. 4, 420-429, 2010.
- [40] Liu Feng and Florentin Smarandache, Self Knowledge and Knowledge Communication, in Multispace and Multistructure, Vol. 4, 430-435, 2010.
- [41] Haibin Wang, Andre Rogatko, Florentin Smarandache, Rajshekhar Sunderraman, A Neutrosophic Description Logic, Proceedings of 2006 IEEE International Conference on Granular Computing, edited by Yan-Qing Zhang and Tsau Young Lin, Georgia State University, Atlanta, 305-308, 2006.
- [42] Haibin Wang, Rajshekhar Sunderraman, Florentin Smarandache, André Rogatko, Neutrosophic Relational Data Model, in <Critical Review> (Society for Mathematics of Uncertainty, Creighton University), Vol. II, 19-35, 2008.
- [43] F. Smarandache, Short Definitions of Neutrosophic Notions [in Russian], translated by A. Schumann, Philosophical Lexicon, Minsk-Moscow, Econompres, Belarus-Russia, 2008.
- [44] Haibin Wang, Yan-Qing Zhang, Rajshekhar Sunderraman, Florentin Smarandache, Neutrosophic Logic Based Semantic Web Services Agent, in Multispace and Multistructure, Vol. 4, 505-519, 2010.
- [45] F.G. Lupiáñez, "On neutrosophic paraconsistent topology", Kybernetes 39 (2010), 598-601.

- [46] J. Ye, A multicriteria decision-making method using aggregation operators for simplified neutrosophic sets, *Journal of Intelligent and Fuzzy Systems* (2013) doi: 10.3233/IFS-130916.
- [47] Florentin Smarandache, Neutrosophic Logic as a Theory of Everything in Logics, in *Multispace and Multistructure*, Vol. 4, 525-527, 2010.
- [48] Florentin Smarandache, Blogs on Applications of Neutrosophics and Multispace in Sciences, in *Multispace and Multistructure*, Vol. 4, 528-548, 2010.
- [49] Athar Kharal, A Neutrosophic Multicriteria Decision Making Method, National University of Science and Technology, Islamabad, Pakistan.
- [50] Florentin Smarandache, Neutrosophic Transdisciplinarity (Multi-Space & Multi-Structure), *Arhivele Statului, Filiala Vâlcea, Rm. Vâlcea*, 1969; presented at *Scoala de Vara Internationala, Interdisciplinara si Academica*, Romanian Academy, Bucharest, 6-10 July 2009.
- [51] Jun Ye, Single valued neutrosophic cross-entropy for multicriteria decision making problems, *Applied Mathematical Modelling* (2013) doi: 10.1016/j.apm.2013.07.020.
- [52] Jun Ye, Multicriteria decision-making method using the correlation coefficient under single-valued neutrosophic environment, *International Journal of General Systems*, Vol. 42, No. 4, 386-394, 2013.
- [53] Florentin Smarandache, Neutrosophic Diagram and Classes of Neutrosophic Paradoxes, or To The Outer-Limits of Science, Florentin Smarandache, *Prog. Physics*, Vol. 4, 18-23, 2010.

- [54] Florentin Smarandache, S-denying a Theory, in Multi-space and Multistructure, Vol. 4, 622-629, 2010.
- [55] Florentin Smarandache, Five Paradoxes and a General Question on Time Traveling, Prog. Physics, Vol. 4, 24, 2010.
- [56] H. D. Cheng, Yanhui Guo and Yingtao Zhang, A Novel Image Segmentation Approach Based on Neutrosophic Set and Improved Fuzzy C-means Algorithm, New Mathematics and Natural Computation, Vol. 7, No. 1 (2011) 155-171.
- [57] F. Smarandache, Degree of Negation of an Axiom, to appear in the Journal of Approximate Reasoning, arXiv:0905.0719.
- [58] M. R. Bivin, N. Saivaraju and K. S. Ravichandran, Remedy for Effective Cure of Diseases using Combined Neutrosophic Relational Maps, International Journal of Computer Applications, 12(12):18?23, January 2011. Published by Foundation of Computer Science.
- [59] F. Smarandache, Neutrosophic Research Method, in Multispace & Multistructure. Neutrosophic Transdisciplinarity, NESP, Finland, pp. 395-548 and respectively 732-733, 2010.
- [60] Tahar Guerram, Ramdane Maamri, and Zaidi Sahnoun, A Tool for Qualitative Causal Reasoning On Complex Systems, IJCSI International Journal of Computer Science Issues, Vol. 7, Issue 6, November 2010.
- [61] P. Thiruppathi, N.Saivaraju, K.S. Ravichandran, A Study on Suicide problem using Combined Overlap Block Neutrosophic Cognitive Maps, International Journal of Algorithms, Computing and Mathematics, Vol. 3, Number 4, November 2010.

- [62] Francisco Gallego Lupiáñez, "On various neutrosophic topologies", "Recent advances in Fuzzy Systems", WSEAS (Athens , 2009), 59-62.
- [63] F.G. Lupiáñez, Interval neutrosophic sets and Topology, *Kybernetes* 38 (2009), 621-624.
- [64] F .G. Lupiáñez, On various neutrosophic topologies, *Kybernetes* 38 (2009), 1009-1013.
- [65] Francisco Gallego Lupiáñez, Interval neutrosophic sets and topology, *Kybernetes: The Intl J. of Systems & Cybernetics*, Volume 38, Numbers 3-4, 2009 , pp. 621-624(4).
- [66] Andrew Schumann, Neutrosophic logics on Non-Archimedean Structures, Critical Review, Creighton University, USA, Vol. III, 36-58, 2009.
- [67] Fu Yuhua, Fu Anjie, Zhao Ge, Positive, Negative and Neutral Law of Universal Gravitation, Zhao Ge, *New Science and Technology*, 2009 (12), 30-32.
- [68] Monoranjan Bhowmik and Madhumangal Pal, Intuitionistic Neutrosophic Set, *Journal of Information and Computing Science*, England, Vol. 4, No. 2, 2009, pp. 142-152.
- [69] Wen Ju and H. D. Cheng, Discrimination of Outer Membrane Proteins using Reformulated Support Vector Machine based on Neutrosophic Set, *Proceedings of the 11th Joint Conference on Information Sciences (2008)*, Published by Atlantis Press.
- [70] Smita Rajpal, M.N. Doja, Ranjit Biswas, A Method of Imprecise Query Solving, *International Journal of Computer Science and Network Security*, Vol. 8 No. 6, pp. 133-139, June 2008.

- [71] Florentin Smarandache, Neutrosophic Degree of a Paradoxicity, in Multispace and Multistructure, Vol. 4, 605-607, 2010.
- [72] F.G. Lupiáñez, On Neutrosophic Topology, *Kybernetes* 37 (2008), 797-800.
- [73] F.G. Lupiáñez, Interval neutrosophic sets and Topology, "Applied and Computational Mathematics", WSEAS (Athens, 2008), 110-112.
- [74] Smita Rajpal, M.N. Doja and Ranjit Biswas, A Method of Neutrosophic Logic to Answer Queries in Relational Database, by *Journal of Computer Science* 4 (4): 309-314, 2008.
- [75] Pawalai Kraipeerapun, Chun Che Fung, Kok Wai Wong, Ensemble Neural Networks Using Interval Neutrosophic Sets and Bagging, by *Third International Conference on Natural Computation (ICNC 2007)*, Haikou, Hainan, China, August 24-August 27, 2007.
- [76] Pawalai Kraipeerapun, Chun Che Fung, and Kok Wai Wong, Lithofacies Classification from Well Log Data using Neural Networks, Interval Neutrosophic Sets and Quantification of Uncertainty, *World Academy of Science, Engineering and Technology*, 23, 2006.
- [77] Jose L. Salmeron, Florentin Smarandache, Redesigning Decision Matrix Method with an indeter-minacy-based inference process, *Advances in Fuzzy Sets and Systems*, Vol. 1(2), 263-271, 2006.
- [78] P. Kraipeerapun, C. C. Fung, W. Brown and K. W. Wong, Neural network ensembles using interval neutrosophic sets and bagging for mineral prospectivity prediction and quantification of uncertainty, 2006 IEEE Conference on

- Cybernetics and Intelligent Systems, 7-9 June 2006, Bangkok, Thailand.
- [79] Jose L. Salmeron, Florentin Smarandache, Processing Uncertainty and Indeterminacy in Information Systems success mapping, arXiv:cs/0512047v2.
- [80] Florentin Smarandache, Jean Dezert, The Combination of Paradoxical, Uncertain, and Imprecise Sources of Information based on DS_mT and Neutro-Fuzzy Inference, in arXiv:cs/0412091v1. A version of this paper published in Proceedings of 10th International Conference on Fuzzy Theory and Technology (FT&T 2005), Salt Lake City, Utah, USA, July 21-26, 2005.
- [81] Goutam Bernajee, Adaptive fuzzy cognitive maps vs neutrosophic cognitive maps: decision support tool for knowledge based institution, Journal of Scientific and Industrial Research, 665-673, Vol. 67, 2008,
- [82] W. B. Vasantha Kandasamy and Florentin Smarandache, Fuzzy Cognitive Maps and Neutrosophic Cognitive Maps, Book Review by Milan Mares: Kybernetika, Vol. 40 (2004), No. 1, [151]-15.
- [83] H. Wang, Y. Zhang, R. Sunderraman, F. Song, Set-Theoretic Operators on Degenerated Neutrosophic Set, by Georgia State UNiversity, Atlanta, 2004.
- [84] Anne-Laure Joussetme, Patrick Maupin, Neutrosophy in situation analysis, Proc. of Fusion 2004 Int. Conf. on Information Fusion, pp. 400-406, Stockholm, Sweden, June 28-July1, 2004 (<http://www.fusion2004.org>).
- [85] C. Lee, Preamble to Neutrosophic Logic, Multiple-Valued Logic / An International Journal, Vol. 8, No. 3, 285-296, June 2002.

- [86] Florentin Smarandache, Neutrosophy, a New Branch of Philosophy, Multiple-Valued Logic / An International Journal, Vol. 8, No. 3, 297-384, June 2002.
- [87] Florentin Smarandache, A Unifying Field in Logics: Neutrosophic Field, Multiple-Valued Logic / An International Journal, Vol. 8, No. 3, 385-438, June 2002.
- [88] Jean Dezert, Open Questions to Neutrosophic Inferences, Multiple-Valued Logic / An International Journal, Vol. 8, No. 3, 439-472, June 2002.
- [89] Feng Liu, Florentin Smarandache, Logic: A Misleading Concept. A Contradiction Study toward Agent's Logic, Proceedings of the First International Conference on Neutrosophy, Neutrosophic Logic, Neutrosophic Set, Neutrosophic Probability and Statistics, University of New Mexico, Gallup Campus, 2001.
- [90] Fu Yuhua, Fu Anjie, Zhao Ge, Six Neutral Fundamental Reactions Between Four Fundamental Reactions, by <http://wbabin.net/physics/yuhua2.pdf>.
- [91] Florentin Smarandache, On Rugina's System of Thought, International Journal of Social Economics, Vol. 28, No. 8, 623-647, 2001.
- [92] Feng Liu, Florentin Smarandache, Intentionally and Unintentionally. On Both, A and Non-A, in Neutrosophy, Presented to the First International Conference on Neutrosophy, Neutrosophic Logic, Set, and Probability, University of New Mexico, Gallup, December 1-3, 2001.
- [93] Arora, M., Biswas, R., Deployment of neutrosophic technology to retrieve answer for queries posed in natural language, Computer Science and Information Technology

- (ICCSIT), 2010 3rd IEEE International Conference on, Vol. 3, DOI: 10.1109/ICCSIT.2010.5564125, 2010, 435 – 439.
- [94] Aggarwal, S., Biswas, R. ; Ansari, A.Q., Neutrosophic modeling and control, Computer and Communication Technology (ICCCT), 2010 International Conference, DOI: 10.1109/ICCCT.2010.5640435, 2010, 718 – 723.
- [95] Wang, H. ; Yan-Qing Zhang ; Sunderraman, R., Truth-value based interval neutrosophic sets, Granular Computing, 2005 IEEE International Conference, Vol. 1, DOI: 10.1109/GRC.2005.1547284, 2005, 274 – 277.
- [96] Smarandache, F., A geometric interpretation of the neutrosophic set — A generalization of the intuitionistic fuzzy set, Granular Computing (GrC), 2011 IEEE International Conference, DOI: 10.1109/GRC.2011.6122665, 2011, 602 – 606.
- [97] Mohan, J. ; Yanhui Guo ; Krishnaveni, V.; Jeganathan, K. MRI denoising based on neutrosophic wiener filtering, Imaging Systems and Techniques (IST), 2012 IEEE, DOI: 10.1109/IST.2012.6295518, 2012, 327 – 331.
- [98] Smarandache, F. ; Vladareanu L., Applications of neutrosophic logic to robotics: An introduction, Granular Computing (GrC), 2011 IEEE, DOI: 10.1109/GRC.2011.6122666, 2011, 607 – 612.
- [99] Mohan, J. ; Krishnaveni, V. ; Guo, Yanhui, A Neutrosophic approach of MRI denoising, Image Information Processing, 2011, DOI: 10.1109/ICIIP.2011.6108880, 2011, 1 – 6.
- [100] Kraipeerapun, P. ; Chun Che Fung ; Brown, W. ; Kok-Wai Wong, Neural Network Ensembles using Interval Neutrosophic Sets and Bagging for Mineral Prospectivity Prediction and Quantification of Uncertainty, Cybernetics

- and Intelligent Systems, 2006 IEEE Conference on, DOI: 10.1109/ICCIS.2006.252249, 2006, 1 – 6.
- [101] Smarandache, F., Neutrosophic masses & indeterminate models: Applications to information fusion, Information Fusion (FUSION), 2012 15th International Conference on, 2012, 1051 – 1057.
- [102] Smarandache, F., Neutrosophic set - a generalization of the intuitionistic fuzzy set, Granular Computing, 2006 IEEE, DOI: 10.1109/GRC.2006.1635754, 2006, 38 – 42.
- [103] Rao, S.; Red Teaming military intelligence - a new approach based on Neutrosophic Cognitive Mapping, Intelligent Systems and Knowledge Engineering (ISKE), 2010, DOI: 10.1109/ISKE.2010.5680765, 2010, 622 – 627.
- [104] Smarandache, F., Neutrosophic masses & indeterminate models. Applications to information fusion, Advanced Mechatronic Systems (ICAMechS), 2012, 674 – 679.
- [105] Mohan, J. ; Krishnaveni, V. ; Guo, Yanhui; Validating the Neutrosophic approach of MRI denoising based on structural similarity, Image Processing (IPR 2012), IET, DOI: 10.1049/cp.2012.0419, 2012, 1 – 6.
- [106] Kraipeerapun, P. ; Chun Che Fung ; Kok Wai Wong; Ensemble Neural Networks Using Interval Neutrosophic Sets and Bagging, Natural Computation, 2007. ICNC 2007. Third International Conference, Vol. 1, DOI: 10.1109/ICNC.2007.359, 2007, 386 – 390.
- [107] Kraipeerapun, P.; Chun Che Fung, Comparing performance of interval neutrosophic sets and neural networks with support vector machines for binary classification problems, Digital Ecosystems and Technologies, 2008. DEST 2008.

- 2nd IEEE, DOI: 10.1109/DEST.2008.4635138, 2008, 34 – 37.
- [108] Kraipeerapun, P. ; Kok Wai Wong ; Chun Che Fung ; Brown, W.; Quantification of Uncertainty in Mineral Prospectivity Prediction Using Neural Network Ensembles and Interval Neutrosophic Sets, Neural Networks, 2006. IJCNN '06., DOI: 10.1109/IJCNN.2006.247262, 2006, 3034 – 3039.
- [109] Haibin Wang; Rogatko, A.; Smarandache, F.; Sunderraman, R.; A neutrosophic description logic, Granular Computing, 2006 IEEE International Conference, DOI: 10.1109/GRC.2006.1635801, 2006, 305 – 308.
- [110] Khoshnevisan, M. ; Bhattacharya, S.; Neutrosophic information fusion applied to financial market, Information Fusion, 2003. Proceedings of the Sixth International Conference, Vol. 2, DOI: 10.1109/ICIF.2003.177381, 2003, 1252 – 1257.
- [111] Aggarwal, S. ; Biswas, R. ; Ansari, A.Q. From Fuzzification to Neutrosophication: A Better Interface between Logic and Human Reasoning, Emerging Trends in Engineering and Technology (ICETET), 2010 3rd International Conference, DOI: 10.1109/ICETET.2010.26, 2010, 21 – 26.
- [112] Chih-Yen Chen ; Tai-Shan Liao ; Chi-Wen Hsieh; Tzu-Chiang Liu ; Hung-Chun Chien; A novel image enhancement approach for Phalanx and Epiphyseal/metaphyseal segmentation based on hand radiographs, Instrumentation and Measurement Technology Conference (I2MTC), 2012 IEEE International, DOI: 10.1109/I2MTC.2012.6229651, 2012, 220--224.
- [113] Kraipeerapun, P. ; Chun Che Fung ; Kok Wai Wong, Quantification of Vagueness in Multiclass Classification

- Based on Multiple Binary Neural Networks, Machine Learning and Cybernetics, 2007 International Conference on, Vol. 1, DOI: 10.1109/ICMLC.2007.4370129, 2007 140 – 144.
- [114] Bajger, M.; Fei Ma; Bottema, M.J.; Automatic Tuning of MST Segmentation of Mammograms for Registration and Mass Detection Algorithms, Digital Image Computing: Techniques and Applications, 2009. DICTA '09. DOI: 10.1109/DICTA.2009.72, 2009. 400 – 407.
- [115] Rao, S., Externalizing Tacit knowledge to discern unhealthy nuclear intentions of nation states, Intelligent System and Knowledge Engineering, 2008. ISKE 2008. 3rd International Conference on, Vol. 1, DOI: 10.1109/ISKE.2008.4730959, 2008, 378 – 383.
- [116] Maupin, P.; Joussetme, A.-L., Vagueness, a multifacet concept - a case study on *Ambrosia artemisiifolia* predictive cartography, Geoscience and Remote Sensing Symposium, 2004. IGARSS '04. Proceedings. 2004 IEEE International, Vol. 1, DOI: 10.1109/IGARSS.2004.1369036, 2004.
- [117] Djiknavorian, P.; Grenier, D.; Valin, P.; Analysis of information fusion combining rules under the dsm theory using ESM inputs, Information Fusion, 2007 10th International Conference on, DOI: 10.1109/ICIF.2007.4408128, 2007, 1 – 8, Cited by 4.
- [118] Florentin Smarandache, A Geometric Interpretation of the Neutrosophic Set, A Generalization of the Intuitionistic Fuzzy Set, In Neutrosophic Theory and Its Applications. Collected Papers, Volume 1, EuropaNova, Bruxelles, 2014, pp. 27-35.

- [119] Hojjatollah Farahani, Florentin Smarandache, Lihshing Leigh Wang, A Comparison of Combined Overlap Block Fuzzy Cognitive Maps (COBFCM) and Combined Overlap Block Neutrosophic Cognitive Map (COBNCM) in finding the hidden patterns and indeterminacies in Psychological Causal Models: Case Study of ADHD, In *Critical Review*, Volume X, 2015, pp. 71-83.
- [120] Tudor Marin, Gheorghe Savoiu, Addressing The Dimensions Of Education And Integrated Curriculum Via Generalized Fuzzy Logic, In *Euromentor Journal*, Volume VI, No. 1/March 2015, pp. 61-73.
- [121] T. Bharathi, A Fuzzy Study on the Analysis of Cervical Cancer among women using Combined Disjoint Block Fuzzy Cognitive Maps (CDBFCMs), In *International Journal of Research in Science & Technology*, Volume 1, November 2014, 5 p.
- [122] Asim Hussain, Muhammad Shabir, Algebraic Structures Of Neutrosophic Soft Sets, In *Neutrosophic Sets and Systems*, Vol. 7, 2015, pp. 53-61.
- [123] Ridvan Sahin, Mesut Karabacak, A multi attribute decision making method based on inclusion measure for interval neutrosophic sets, In *International Journal of Engineering and Applied Sciences*, Volume 2, February 2015, pp. 13-15.
- [124] Maikel Leyva-Vazquez, Karina Perez-Teruel, Florentin Smarandache, Análisis de textos de José Martí utilizando mapas cognitivos neutrosóficos, In *Neutrosophic Theory and Its Applications. Collected Papers*, Volume 1, EuropaNova, Bruxelles, 2014, pp. 463-467.
- [125] G. Anusha, P. Venkata Ramana, Analysis of Reasons for Stress on College Students using Combined Disjoint Block

- Fuzzy Cognitive Maps (CDBFCM), In International Journal For Research In Emerging Science And Technology, Volume 2, February 2015, pp. 16-21.
- [126] Ștefan Vlăduțescu, Mirela Teodorescu, An analitical extended book review. S. Frunza: Advertising constructs reality (2014), In International Letters of Social and Humanistic Sciences, 2015, pp. 98-106.
- [127] Indranu Suhendro, An Eidetic Reflex and Moment of Breakthrough in Time and Scientific Creation: 10 Years of Progress in Physics, 100 Years of General Relativity, and the Zelmanov Cosmological Group, In Progress in Physics, Vol. 11, 2015, pp. 180-182.
- [128] Mumtaz Ali, Florentin Smarandache, Said Broumi , and Muhammad Shabir, A New Approach to Multi-spaces Through the Application of Soft Sets, In Neutrosophic Sets and Systems, Vol. 7, 2015, pp. 34-39.
- [129] Anjan Mukherjee, Sadhan Sarkar, A new method of measuring similarity between two neutrosophic soft sets and its application in pattern recognition problems, In Neutrosophic Sets and Systems, Vol. 8, 2015, pp. 63-68.
- [130] Pranab Biswas, Surapati Pramanik, Bibhas C. Giri, A New Methodology for Neutrosophic Multi-Attribute Decision-Making with Unknown Weight Information, In Neutrosophic Sets and Systems, Vol. 3, 2014, pp. 42-52.
- [131] Fu Yuhua, An Example of Guiding Scientific Research with Philosophical Principles Based on Uniqueness of Truth and Neutrosophy Deriving Newton's Second Law and the like, In Critical Review, Volume X, 2015, pp.85-92.
- [132] Said Broumi, Jun Ye, Florentin Smarandache, An Extended TOPSIS Method for Multiple Attribute Decision Making

- based on Interval Neutrosophic Uncertain Linguistic Variables, In Neutrosophic Sets and Systems, Vol. 8, 2015, pp.22-31.
- [133] Huda E. Khalid, An Original Notion to Find Maximal Solution in the Fuzzy Neutrosophic Relation Equations (FNRE) with Geometric Programming (GP), In Neutrosophic Sets and Systems, Vol. 7, 2015, pp. 3-7.
- [134] Mamouni Dhar, Said Broumi, Florentin Smarandache, A Note on Square Neutrosophic Fuzzy Matrices, In Neutrosophic Sets and Systems, Vol. 3, 2014, pp. 37-41.
- [135] Jun Ye, Another Form of Correlation Coefficient between Single Valued Neutrosophic Sets and Its Multiple Attribute Decision-Making Method, In Neutrosophic Sets and Systems, Vol. 1, 2013, pp. 8-12.
- [136] Juan-Juan Peng, Jian-qiang Wang, Hong-yu Zhang, Xiao-hong Chen, An outranking approach for multi-criteria decision-making problems with simplified neutrosophic sets, In Applied Soft Computing, 2014, pp. 336–346.
- [137] Yanhui Guo, Abdulkadir Sengur, A Novel Image Segmentation Algorithm Based on Neutrosophic Filtering and Level Set, In Neutrosophic Sets and Systems, Vol. 1, 2013, pp. 46-49.
- [138] Yanhui Guo, Abdulkadir Sengur, Jun Ye, A novel image thresholding algorithm based on Neuro-sophic similarity score, In Measurement, 2014, pp. 175–186.
- [139] Zhiming Zhang, Chong Wu, A novel method for single-valued neutrosophic multi-criteria decision making with incomplete weight information, In Neutrosophic Sets and Systems, Vol. 4, 2014, pp. 35-49.

- [140] Florentin Smarandache, Luige Vladareanu, Applications of Neutrosophic Logic to Robotics, In Neutrosophic Theory and Its Applications. Collected Papers, Volume 1, EuropaNova, Bruxelles, 2014, pp. 61-66.
- [141] Elena Rodica Opran, Dan Valeriu Voinea, Mirela Teodorescu, Art and being in neutrosophic communication, In International Letters of Social and Humanistic Sciences, 2015, pp. 16-27.
- [142] C. Ramkumar, R. Ramanan, A. Lourdusamy, S. Narayanamoorthy, A Study On Neutrosophic Cognitive Maps (NCM) And Its Applications, In International Journal of Mathematical Archive, 6(3), 2015, pp. 209-211.
- [143] Kalyan Mondal, Surapati Pramanik, A Study on Problems of Hijras in West Bengal Based on Neutrosophic Cognitive Maps, In Neutrosophic Sets and Systems, Vol. 5, 2014, pp. 21-26.
- [144] Adrian Nicolescu, Mirela Teodorescu, A Unifying Field in Logics. Book Review, In International Letters of Social and Humanistic Sciences, 2015, pp. 48-59.
- [145] A. A. Salama, Basic Structure of Some Classes of Neutrosophic Crisp Nearly Open Sets & Possible Application to GIS Topology, In Neutrosophic Sets and Systems, Vol. 7, 2015, pp. 18-22.
- [146] Florentin Smarandache, Stefan Vladuțescu, Communication vs. Information, an Axiomatic Neutrosophic Solution, In Neutrosophic Sets and Systems, Vol. 1, 2013, pp. 38-45.
- [147] Debabrata Mandal, Comparative Study of Intuitionistic and Generalized Neutrosophic Soft Sets, In International

- Journal of Mathematical, Computational, Natural and Physical Engineering, Vol. 9, No. 2, 2015, pp.111-114.
- [148] Florentin Smarandache, Connections between Extension Logic and Refined Neutrosophic Logic, In Neutrosophic Theory and Its Applications. Collected Papers, Volume 1, EuropaNova, Bruxelles, 2014, pp. 47-54.
- [149] Said Broumi, Florentin Smarandache, Correlation Coefficient of Interval Neutrosophic Set, In Neutrosophic Theory and Its Applications. Collected Papers, Volume 1, EuropaNova, Bruxelles, 2014, pp. 67-73.
- [150] Said Broumi, Irfan Deli, Correlation Measure For Neutrosophic Refined Sets And Its Application In Medical Diagnosis, In Palestine Journal of Mathematics, Vol. 3, 2014, pp. 11-19.
- [151] Said Broumi, Florentin Smarandache, Cosine Similarity Measure of Interval Valued Neutrosophic Sets, In Neutrosophic Sets and Systems, Vol. 5, 2014, pp. 15-20.
- [152] Pranab Biswas, Surapati Pramanik, Bibhas C. Giri, Cosine Similarity Measure Based Multi-attribute Decision-making with Trapezoidal Fuzzy Neutrosophic Numbers, In Neutrosophic Sets and Systems, Vol. 8, 2014, pp. 46-55.
- [153] Surapati Pramanik, Kalyan Mondal, Cosine Similarity Measure of Rough Neutrosophic Sets and Its Application In Medical Diagnosis, In Global Journal of Advanced Research, Vol. 2, pp. 315-328.
- [154] Surapati Pramanik, Kalyan Mondal, Cotangent Similarity Measure of Rough Neutrosophic Sets And Its Application To Medical Diagnosis, In Journal of New Theory, 2015, pp. 90-102.

- [155] Feng Liu, Florentin Smarandache, Dialectics and the Dao: On Both, A and Non-A in Neutrosophy and Chinese Philosophy, In Neutrosophic Theory and Its Applications. Collected Papers, Volume 1, EuropaNova, Bruxelles, 2014, pp. 440-444.
- [156] Shan Ye, Jun Ye, Dice Similarity Measure between Single Valued Neutrosophic Multisets and Its Application in Medical Diagnosis, In Neutrosophic Sets and Systems, Vol. 6, 2014, pp. 48-53.
- [157] Pranab Biswas, Surapati Pramanik, Bibhas C. Giri, Entropy Based Grey Relational Analysis Method for Multi-Attribute Decision Making under Single Valued Neutrosophic Assessments, In Neutrosophic Sets and Systems, Vol. 2, 2014, pp. 102-110.
- [158] Fu Yuhua, Examples of Neutrosophic Probability in Physics, In Neutrosophic Sets and Systems, Vol. 7, 2015, pp. 32-34.
- [159] Fu Yuhua, Expanding Newton Mechanics with Neutrosophy and Quadstage Method. New Newton Mechanics Taking Law of Conservation of Energy as Unique Source Law, In Neutrosophic Sets and Systems, Vol. 3, 2014, pp. 3-13.
- [160] Fu Yuhua, Expanding Uncertainty Principle to Certainty-Uncertainty Principles with Neutrosophy and Quad-stage Method, In Neutrosophic Sets and Systems, Vol. 8, 2015, pp. 10-13.
- [161] Mumtaz Ali, Florentin Smarandache, Muhammad Shabir, Luige Vladareanu, Generalization of Neutrosophic Rings and Neutrosophic Fields, In Neutrosophic Sets and Systems, Vol. 5, 2014, pp. 9-14.

- [162] Mumtaz Ali, Florentin Smarandache, Muhammad Shabir, Luige Vladareanu, Generalization of Soft Neutrosophic Rings and Soft Neutrosophic Fields, In Neutrosophic Sets and Systems, Vol. 6, 2014, pp. 34-40.
- [163] A. A. Salama, S. A. Alblowi, Generalized Neutrosophic Set and Generalized Neutrosophic Topological Spaces, In Computer Science and Engineering, 2012, pp. 129-132
- [164] Mumtaz Ali, Florentin Smarandache, Munazza Naz, Muhammad Shabir, G-Neutrosophic Space, In Neutrosophic Theory and Its Applications. Collected Papers, Volume 1, EuropaNova, Bruxelles, 2014, pp. 116-126.
- [165] Kanika Mandal, Kajla Basu, Hypercomplex Neutrosophic Similarity Measure & Its Application In Multi-Criteria Decision Making Problem, 15 p.
- [166] Jun Ye, Improved cosine similarity measures of simplified neutrosophic sets for medical diagnoses, In Artificial Intelligence in Medicine, 2015, pp. 171-179.
- [167] Haibin Wang, Florentin Smarandache, Yan-Qing Zhang, Rajshekhar Sunderraman, Interval Neutrosophic Logic, In Neutrosophic Theory and Its Applications. Collected Papers, Volume 1, EuropaNova, Bruxelles, 2014, pp. 142-160.
- [168] A. A. Salama, Florentin Smarandache, Filters via Neutrosophic Crisp Sets, In Neutrosophic Sets and Systems, Vol. 1, 2013, pp. 34-37.
- [169] Said Broumi, Florentin Smarandache, Interval Neutrosophic Rough Set, In Neutrosophic Sets and Systems, Vol. 7, 2015, pp. 23-31.

- [170] , I. Arockiarani, I.R. Sumathi, Interval Valued Fuzzy Neutrosophic Soft Structure Spaces, In Neutrosophic Sets and Systems, Vol. 5, 2014, pp. 36-44.
- [171] Anjan Mukherjee, Mithun Datta, Florentin Smarandache, Interval Valued Neutrosophic Soft Topological Spaces, In Neutrosophic Sets and Systems, Vol. 6, 2014, pp. 17-26.
- [172] A. A. Salama, Haitham A. El-Ghareeb, Ayman M. Manie, Florentin Smarandache, Introduction to Develop Some Software Programs for Dealing with Neutrosophic Sets, In Neutrosophic Sets and Systems, Vol. 3, 2014, pp. 53-54.
- [173] A. A. Salama, Florentin Smarandache, Mohamed Eisa, Introduction to Image Processing via Neutrosophic Techniques, In Neutrosophic Sets and Systems, Vol. 5, 2014, pp. 59-64.
- [174] A. A. Salama, Said Broumi, S. A. Alblowi, Introduction to Neutrosophic Topological Spatial Region, Possible Application to GIS Topological Rules, In I.J. Information Engineering and Electronic Business, 2014, pp. 15-21.
- [175] V. Jaiganesh, P. Rutravigneshwaran, Intrusion Detection Using Neutrosophic Classifier, In The International Journal of Science & Tech., Vol. 2, 2014, pp. 128-133.
- [176] Monoranjan Bhowmik, Madhumangal Pal, Intuitionistic Neutrosophic Set Relations and Some of Its Properties, In Journal of Information and Computing Science, Vol. 5, No. 3, 2010, pp. 183-192.
- [177] Broumi Said, Florentin Smarandache, Intuitionistic Neutrosophic Soft Set, In Neutrosophic Theory and Its Applications. Collected Papers, Volume 1, EuropaNova, Bruxelles, 2014, pp. 162-171.

- [178] Broumi Said, Florentin Smarandache, Intuitionistic Neutrosophic Soft Set over Rings, In Neutrosophic Theory and Its Applications. Collected Papers, Volume 1, EuropaNova, Bruxelles, 2014, pp. 172-178.
- [179] Shawkat Alkhazaleh, Emad Marei, Mappings on Neutrosophic Soft Classes, In Neutrosophic Sets and Systems, Vol. 2, 2014, pp. 3-8.
- [180] Shan Ye, Jing Fu, Jun Ye, Medical Diagnosis Using Distance-Based Similarity Measures of Single Valued Neutrosophic Multisets, In Neutrosophic Sets and Systems, Vol. 7, 2015, pp. 47-52.
- [181] Lingwei Kong, Yuefeng Wu, Jun Ye, Misfire Fault Diagnosis Method of Gasoline Engines Using the Cosine Similarity Measure of Neutrosophic Numbers, In Neutrosophic Sets and Systems, Vol. 8, 2015, pp. 42-45.
- [182] Broumi Said, Florentin Smarandache, More on Intuitionistic Neutrosophic Soft Sets, In Neutrosophic Theory and Its Applications. Collected Papers, Volume 1, EuropaNova, Bruxelles, 2014, pp. 179-190.
- [183] Kalyan Mondal, Surapati Pramanik, Multi-criteria Group Decision Making Approach for Teacher Recruitment in Higher Education under Simplified Neutrosophic Environment, In Neutrosophic Sets and Systems, Vol. 6, 2014, pp. 27-33.
- [184] Yun Ye, Multiple-attribute Decision-Making Method under a Single-Valued Neutrosophic Hesitant Fuzzy Environment, In J. Intell. Syst., 2015, pp. 23-36.
- [185] Juan-Juan Peng, Multi-valued Neutrosophic Sets and Power Aggregation Operators with Their Applications in Multi-criteria Group Decision-making Problems, In

- International Journal of Computational Intelligence Systems, Vol. 8, No. 2, 2015, pp. 345-363.
- [186] Fu Yuhua, Negating Four Color Theorem with Neutrosophy and Quadstage Method, In Neutrosophic Sets and Systems, Vol. 8, 2015, pp. 59-62.
- [187] Florentin Smarandache, Neutrosafia, o nouă ramură a filosofiei, In Neutrosophic Theory and Its Applications. Collected Papers, Volume 1, EuropaNova, Bruxelles, 2014, pp. 472-477.
- [188] Florentin Smarandache, Neutrosophic Axiomatic System, In Critical Review, Volume X, 2015, pp. 5-28.
- [189] Mumtaz Ali, Florentin Smarandache, Muhammad Shabir, Munazza Naz, Neutrosophic Bi-LA-Semigroup and Neutrosophic N-LASemigroup, In Neutrosophic Sets and Systems, Vol. 4, 2014, pp. 19-24.
- [190] Broumi Said, Florentin Smarandache, Lower and Upper Soft Interval Valued Neutrosophic Rough Approximations of An IVNSS-Relation, In Neutrosophic Theory and Its Applications. Collected Papers, Volume 1, EuropaNova, Bruxelles, 2014, pp. 191-198.
- [191] Jozef Novak-Marcincin, Adrian Nicolescu, Mirela Teodorescu, Neutrosophic circuits of communication. A review, In International Letters of Social and Humanistic Sciences, 2015, pp. 174-186.
- [192] A.Q. Ansari, Ranjit Biswas, Swati Aggarwal, Neutrosophic classifier: An extension of fuzzy classifier, In Applied Soft Computing, 2013, pp. 563-573.
- [193] A. A. Salama, Florentin Smarandache, Valeri Kromov, Neutrosophic Closed Set and Neutrosophic Continuous

- Functions, In Neutrosophic Sets and Systems, Vol. 4, 2014, pp. 4-8.
- [194] Ameiryys Betancourt-Vázquez, Maikel Leyva-Vázquez, Karina Perez-Teruel, Neutrosophic cognitive maps for modeling project portfolio interdependencies, In Critical Review, Volume X, 2015, pp. 40-44.
- [195] A. A. Salama, O. M. Khaled, K. M. Mahfouz, Neutrosophic Correlation and Simple Linear Regression, In Neutrosophic Sets and Systems, Vol. 5, 2014, pp. 3-8.
- [196] A. A. Salama, Said Broumi, Florentin Smarandache, Neutrosophic Crisp Open Set and Neutrosophic Crisp Continuity via Neutrosophic Crisp Ideals, In Neutrosophic Theory and Its Applications. Collected Papers, Volume 1, EuropaNova, Bruxelles, 2014, pp 199-205.
- [197] A. A. Salama, Neutrosophic Crisp Points & Neutrosophic Crisp Ideals, In Neutrosophic Sets and Systems, Vol. 1, 2013, pp. 50-53.
- [198] A. A. Salama, Hewayda Elghawalby, *- Neutrosophic Crisp Set & *- Neutrosophic Crisp relations, In Neutrosophic Sets and Systems, Vol. 6, 2014, pp. 12-16.
- [199] A. A. Salama, Florentin Smarandache, Valeri Kroumov, Neutrosophic Crisp Sets & Neutrosophic Crisp Topological Spaces, In Neutrosophic Sets and Systems, Vol. 2, 2014, pp. 25-30.
- [200] A. A. Salama, Florentin Smarandache, Neutrosophic Crisp Set Theory, In Neutrosophic Sets and Systems, Vol. 5, 2014, pp. 27-35.
- [201] Kalyan Mondal, Surapati Pramanik, Neutrosophic Decision Making Model of School Choice, In Neutrosophic Sets and Systems, Vol. 7, 2015, pp. 62-68.

- [202] A. A. Salama, H. Alagamy, Neutrosophic Filters, In International Journal of Computer Science Engineering and Information Technology Research (IJCSEITR), Vol. 3, 2013, pp. 307-312.
- [203] Surapati Pramanik, Tapan Kumar Roy, Neutrosophic Game Theoretic Approach to Indo-Pak Conflict over Jammu-Kashmir, In Neutrosophic Sets and Systems, Vol. 2, 2013, pp. 82-100.
- [204] Ridvan Sahin, Neutrosophic Hierarchical Clustering Algorithms, In Neutrosophic Sets and Systems, Vol. 2, 2014, pp. 18-24.
- [205] A.A.A. Agboola, S.A. Akinleye, Neutrosophic Hypercompositional Structures defined by Binary Relations, In Neutrosophic Sets and Systems, Vol. 3, 2014, pp. 29-36.
- [206] , A.A.A. Agboola, S.A. Akinleye, Neutrosophic Hypervector Spaces, 16 p.
- [207] A. A. Salama, Florentin Smarandache, Neutrosophic Ideal Theory Neutrosophic Local Function and Generated Neutrosophic Topology, In Neutrosophic Theory and Its Applications. Collected Papers, Volume 1, EuropaNova, Bruxelles, 2014, pp. 213-218.
- [208] Mumtaz Ali, Muhammad Shabir, Florentin Smarandache, Luige Vladareanu, Neutrosophic LA-Semigroup Rings, In Neutrosophic Sets and Systems, Vol. 7, 2015, pp. 81-88.
- [209] Vasantha Kandasamy, Florentin Smarandache, Neutrosophic Lattices, In Neutrosophic Sets and Systems, Vol. 2, 2013, pp. 42-47.

- [210] Mumtaz Ali, Muhammad Shabir, Munazza Naz, Florentin Smarandache, Neutrosophic Left Almost Semigroup, In Neutrosophic Sets and Systems, Vol. 3, 2014, pp. 18-28.
- [211] Alexandru Gal, Luige Vladareanu, Florentin Smarandache, Hongnian Yu, Mincong Deng, Neutrosophic Logic Approaches Applied to "RABOT" Real Time Control, In Neutrosophic Theory and Its Applications. Collected Papers, Volume 1, EuropaNova, Bruxelles, 2014, pp. 55-60.
- [212] Karina Pérez-Teruel, Maikel Leyva-Vázquez, Neutrosophic Logic for Mental Model Elicitation and Analysis, In Neutrosophic Sets and Systems, Vol. 2, 2014, pp. 31-33.
- [213] Fu Yuhua, Neutrosophic Examples in Physics, In Neutrosophic Sets and Systems, Vol. 1, 2013, pp. 26-33.
- [214] Florentin Smarandache, Neutrosophic Measure and Neutrosophic Integral, In Neutrosophic Sets and Systems, Vol. 1, 2013, pp. 3-7.
- [215] Swati Aggarwal, Ranjit Biswas, A.Q. Ansari, Neutrosophic Modeling and Control, Intl. Conf. on Computer & Communication Tech., 2010, pp. 718-723.
- [216] Irfan Deli, Yunus Toktas, Said Broumi, Neutrosophic Parameterized Soft Relations and Their Applications, In Neutrosophic Sets and Systems, Vol. 4, 2014, pp. 25-34.
- [217] Said Broumi, Irfan Deli, Florentin Smarandache, Neutrosophic Parametrized Soft Set Theory and Its Decision Making, In Neutrosophic Theory and Its Applications. Collected Papers, Volume 1, EuropaNova, Bruxelles, 2014, pp. 403-409.
- [218] Florentin Smarandache, Stefan Vladutescu, Neutrosophic Principle of Interconvertibility Matter-Energy-Information (NPI_MEI), In Neutrosophic Theory and Its Applications.

- Collected Papers, Volume 1, EuropaNova, Bruxelles, 2014, pp. 219-227.
- [219] Said Broumi, Irfan Deli, Florentin Smarandache, Neutrosophic Refined Relations and Their Properties, In Neutrosophic Theory and Its Applications. Collected Papers, Volume 1, EuropaNova, Bruxelles, 2014, pp. 228-248.
- [220] Said Broumi, Florentin Smarandache, Neutrosophic Refined Similarity Measure Based on Cosine Function, In Neutrosophic Sets and Systems, Vol. 6, 2014, pp. 41-47.
- [221] Kalyan Mondal, Surapati Pramanik, Neutrosophic Refined Similarity Measure Based On Cotangent Function And Its Application To Multi-Attribute Decision Making, In Global Journal of Advanced Research, Vol-2, 2015, pp. 486 -496.
- [222] A. A. Salama, Mohamed Eisa, M. M. Abdelmoghny, Neutrosophic Relations Database, In International Journal of Information Science and Intelligent System, 2014, pp. 1-13.
- [223] Daniela Gifu, Mirela Teodorescu, Neutrosophic routes in multiverse of communication, In Neutrosophic Sets and Systems, Vol. 6, 2014, pp. 81-83.
- [224] A.A.Salama, S.A. Alblowi, Neutrosophic Set and Neutrosophic Topological Spaces, In IOSR Journal of Mathematics, 2012, pp. 31-35.
- [225] Mehmet Sahin, Shawkat Alkhazaleh, Vakkas Ulucay, Neutrosophic Soft Expert Sets, In Applied Mathematics, 2015, pp. 116-127.
- [226] Irfan Deli, Said Broumi, Neutrosophic soft matrices and NSM-decision making, In Journal of Intelligent & Fuzzy Systems, 2015, pp. 2233-2241.

- [227] Irfan Deli, Said Broumi, Mumtaz Ali, Neutrosophic Soft Multi-Set Theory and Its Decision Making, In Neutrosophic Sets and Systems, Vol. 5, 2014, pp. 65-76.
- [228] Irfan Deli, Said Broumi, Neutrosophic soft relations and some properties, In Ann. Fuzzy Math. Inform., 2014, pp. 2-14.
- [229] Debabrata Mandal, Neutrosophic Soft Semirings, In Annals of Fuzzy Mathematics and Informatics, 2014, pp. 2-13.
- [230] Faruk Karaaslan, Neutrosophic Soft Sets with Applications in Decision Making, In International Journal of Information Science and Intelligent System, 2015, pp. 1-20.
- [231] Shawkat Alkhazaleh, Neutrosophic Vague Set Theory, In Critical Review, Volume X, 2015, pp. 29-39.
- [232] A.A.A. Agboola, S.A. Akinleye, Neutrosophic Vector Spaces, In Neutrosophic Sets and Systems, Vol. 4, 2014, pp. 9-18.
- [233] Said Broumi, Florentin Smarandache, New Distance and Similarity Measures of Interval Neutrosophic Sets, In Neutrosophic Theory and Its Applications. Collected Papers, Volume 1, EuropaNova, Bruxelles, 2014, pp. 249-255.
- [234] A. A. Salama, Florentin Smarandache, S. A. Alblowi, New Neutrosophic Crisp Topological Concepts, In Neutrosophic Sets and Systems, Vol. 4, 2014, pp. 50-54.
- [235] I. R. Sumathi, I. Arockiarani, New operations On Fuzzy Neutrosophic Matrices, In International Journal of Innovative Research and study, 2014, pp. 119-124.
- [236] Said Broumi, Florentin Smarandache, New Operations on Interval Neutrosophic Sets, In Neutrosophic Theory and Its Applications. Collected Papers, Volume 1, EuropaNova, Bruxelles, 2014, pp. 256-266.

- [237] Said Broumi, Pinaki Majumdar, Florentin Smarandache, New Operations on Intuitionistic Fuzzy Soft Sets Based on First Zadeh's Logical Operators, In Neutrosophic Theory and Its Applications. Collected Papers, Volume 1, EuropaNova, Bruxelles, 2014, pp. 267-277.
- [238] Said Broumi, Florentin Smarandache, New Operations over Interval Valued Intuitionistic Hesitant Fuzzy Set, In Neutrosophic Theory and Its Applications. Collected Papers, Volume 1, EuropaNova, Bruxelles, 2014, pp 267-276.
- [239] Said Broumi, Florentin Smarandache, Mamoni Dhar, Pinaki Majumdar, New Results of Intuitionistic Fuzzy Soft Set, In Neutrosophic Theory and Its Applications. Collected Papers, Volume 1, EuropaNova, Bruxelles, 2014, pp. 386-391.
- [240] Vasantha Kandasamy, Sekar. P. Vidhyalakshmi, New Type of Fuzzy Relational Equations and Neutrosophic Relational Equations – To analyse Customers Preference to Street Shops, In Neutrosophic Sets and Systems, Vol. 3, 2014, pp. 68-76.
- [241] Irfan Deli, npn-Soft sets theory and their applications, In Annals of Fuzzy Mathematics and Informatics, 2015, pp. 3-16.
- [242] Said Broumi, Irfan Deli, Florentin Smarandache, N-Valued Interval Neutrosophic Sets and Their Application in Medical Diagnosis, In Critical Review, Volume X, 2015, pp. 45-68.
- [243] Florentin Smarandache, n-Valued Refined Neutrosophic Logic and Its Applications to Physics, In Neutrosophic

- Theory and Its Applications. Collected Papers, Volume 1, EuropaNova, Bruxelles, 2014, pp. 36-44.
- [244] Said Broumi, Florentin Smarandache, Mamoni Dhar, On Fuzzy Soft Matrix Based on Reference Function, In Neutrosophic Theory and Its Applications. Collected Papers, Volume 1, EuropaNova, Bruxelles, 2014, pp. 392-398.
- [245] Tanushree Mitra Basu, Shyamal Kumar Mondal, Neutrosophic Soft Matrix and Its Application in Solving Group Decision Making Problems from Medical Science, In Computer Communication & Collaboration, 2015, Vol. 3, pp. 1-31.
- [246] A.A.A. Agboola, B. Davvaz, On Neutrosophic Canonical Hypergroups and Neutro-sophic Hyperrings, In Neutrosophic Sets and Systems, Vol. 2, 2014, pp. 34-41.
- [247] A.A.A. Agboola, B. Davvaz, On Neutrosophic Ideals of Neutrosophic BCI-Algebras, In Critical Review, Volume X, 2015, pp. 93-103.
- [248] Fu Yuhua, Pauli Exclusion Principle and the Law of Included Multiple-Middle, In Neutrosophic Sets and Systems, Vol. 6, 2014, pp. 3-5.
- [249] Pawalai Krai Peerapun, Kok Wai Wong, Chun Che Fung, Warick Brown, Quantification of Uncertainty in Mineral Prospectivity Prediction Using Neural Network Ensembles and Interval Neutrosophic Sets, 2006 International Joint Conference on Neural Networks, pp. 3034-3039.
- [250] Florentin Smarandache, Refined Literal Indeterminacy and the Multiplication Law of Sub-Indeterminacies, In Neutrosophic Sets and Systems, Vol. 9, 2015, pp. 1-5.

- [251] Said Broumi, Irfan Deli, Florentin Smarandache, Relations on Interval Valued Neutrosophic Soft Sets, In Neutrosophic Theory and Its Applications. Collected Papers, Volume 1, EuropaNova, Bruxelles, 2014, pp. 290-306.
- [252] Florentin Smarandache, Reliability and Importance Discounting of Neutrosophic Masses, In Neutrosophic Theory and Its Applications. Collected Papers, Volume 1, EuropaNova, Bruxelles, 2014, pp. 13-26.
- [253] Florentin Smarandache, Replacing the Conjunctive Rule and Disjunctive Rule with Tnorms and T-conorms respectively (Tchamova-Smarandache), in Neutrosophic Theory and Its Applications. Collected Papers, Volume 1, EuropaNova, Bruxelles, 2014, pp. 45-46.
- [254] Said Broumi, Florentin Smarandache, On Neutrosophic Implications, In Neutrosophic Sets and Systems, Vol. 2, 2014, pp. 9-17.
- [255] A. A. Salama, Mohamed Eisa, S.A. Elhafeez, M. M. Lotfy, Review of Recommender Systems Algorithms Utilized in Social Networks based e-Learning Systems & Neutrosophic System, In Neutrosophic Sets and Systems, Vol. 8, 2015, pp. 32-40.
- [256] Kalyan Mondal, Surapati Pramanik, Rough Neutrosophic Multi-Attribute Decision-Making Based on Rough Accuracy Score Function, In Neutrosophic Sets and Systems, Vol. 8, 2015, pp. 14-21.
- [257] Said Broumi, Florentin Smarandache, Mamoni Dhar, Rough Neutrosophic Sets, In Neutrosophic Sets and Systems, Vol. 3, 2014, pp. 62-67.
- [258] C. Antony Crispin Sweety, I. Arockiarani, Rough sets in Fuzzy Neutrosophic approximation space, 16 p.

- [259] Said Broumi, Florentin Smarandache, Several Similarity Measures of Neutrosophic Sets, In Neutrosophic Sets and Systems, Vol. 1, 2013, pp. 54-62.
- [260] Anjan Mukherjee and Sadhan Sarkar, Several Similarity Measures of Interval Valued Neutrosophic Soft Sets and Their Application in Pattern Recognition Problems, In Neutrosophic Sets and Systems, Vol. 6, 2014, pp. 54-60.
- [261] Zhang-peng Tian, Jing Wang, Hong-yu Zhang, Xiao-hong Chen, Jian-qiang Wang, Simplified neutrosophic linguistic normalized weighted Bonferroni mean operator and its application to multi-criteria decision-making problems, Faculty of Sciences and Mathematics, University of Nis, Serbia, Filomat, 24 p.
- [262] Jun Ye, Qiansheng Zhang, Single Valued Neutrosophic Similarity Measures for Multiple Attribute Decision-Making, In Neutrosophic Sets and Systems, Vol. 2, 2014, pp. 48-54.
- [263] Rajashi Chatterjee, P. Majumdar, S. K. Samanta, Single valued neutrosophic multisets, In Annals of Fuzzy Mathematics and Informatics, 2015, pp. 1-16.
- [264] Said Broumi, Florentin Smarandache, Soft Interval –Valued Neutrosophic Rough Sets, In Neutrosophic Sets and Systems, Vol. 7, 2015, pp. 69-80.
- [265] Mumtaz Ali, Florentin Smarandache, Muhammad Shabir, Munazza Naz, Soft Neutrosophic Bigroup and Soft Neutrosophic N-Group, In Neutrosophic Sets and Systems, Vol. 2, 2014, pp. 55-79.
- [266] Mumtaz Ali, Florentin Smarandache, Muhammad Shabir, Soft Neutrosophic Bi-LA-semigroup and Soft Neutrosophic

- N-LA-seigroup, In Neutrosophic Sets and Systems, Vol. 5, 2014, pp. 45-58.
- [267] Muhammad Shabir, Mumtaz Ali, Munazza Naz, Florentin Smarandache, Soft Neutrosophic Group, In Neutrosophic Sets and Systems, Vol. 1, 2013, pp. 13-25.
- [268] Mumtaz Ali, Florentin Smarandache, Muhammad Shabir, Soft Neutrosophic Groupoids and Their Generalization, In Neutrosophic Sets and Systems, Vol. 6, 2014, pp. 61-80.
- [269] Florentin Smarandache, Mumtaz Ali, Munazza Naz, and Muhammad Shabir, Soft Neutrosophic Left Almost Semigroup, In Neutrosophic Theory and Its Applications. Collected Papers, Volume 1, EuropaNova, Bruxelles, 2014, pp. 317-326.
- [270] Mumtaz Ali, Florentin Smarandache, and Muhammad Shabir, Soft Neutrosophic Loop, Soft Neutrosophic Biloop and Soft Neutrosophic N-Loop, In Neutrosophic Theory and Its Applications. Collected Papers, Volume 1, EuropaNova, Bruxelles, 2014, pp. 327-348.
- [271] Mumtaz Ali, Christopher Dyer, Muhammad Shabir, Florentin Smarandache, Soft Neutrosophic Loops and Their Generalization, In Neutrosophic Sets and Systems, Vol. 4, 2014, pp. 55-75.
- [272] Mumtaz Ali, Florentin Smarandache, Muhammad Shabir, Munazza Naz, Soft Neutrosophic Ring and Soft Neutrosophic Field, In Neutrosophic Sets and Systems, Vol. 3, 2014, pp. 55-61.
- [273] Mumtaz Ali, Muhammad Shabir, Munazza Naz, Florentin Smarandache, Soft neutrosophic semigroups and their generalization, In Neutrosophic Theory and Its

- Applications. Collected Papers, Volume 1, EuropaNova, Bruxelles, 2014, pp. 349-367.
- [274] A. A. Salama, Said Broumi and Florentin Smarandache, Some Types of Neutrosophic Crisp Sets and Neutrosophic Crisp Relations, In Neutrosophic Theory and Its Applications. Collected Papers, Volume 1, EuropaNova, Bruxelles, 2014, pp. 379-385.
- [275] A. A. Salama, Florentin Smarandache, S. A. Alblowi, The Characteristic Function of a Neutrosophic Set, In Neutrosophic Sets and Systems, Vol. 3, 2014, pp. 14-17.
- [276] Florentin Smarandache, Stefan Vladutescu, The Fifth Function of University: "Neutrosophic E-function" of Communication-Collaboration-Integration of University in the Information Age, In Neutrosophic Theory and Its Applications. Collected Papers, Volume 1, EuropaNova, Bruxelles, 2014, pp. 445-462.
- [277] Vasile Patrascu, The Neutrosophic Entropy and its Five Components, In Neutrosophic Sets and Systems, Vol. 7, 2015, pp. 40-46.
- [278] Florentin Smarandache, Thesis-Antithesis-Neutrothesis, and Neutrosynthesis, In Neutrosophic Sets and Systems, Vol. 8, 2015, pp. 57-58.
- [279] Florentin Smarandache, (t, i, f) -Neutrosophic Structures & I-Neutrosophic Structures (Revisited), In Neutrosophic Sets and Systems, Vol. 8, 2015, pp. 3-9.
- [280] Florentin Smarandache, Sukanto Bhattacharya, To be and Not to be - An introduction to Neutrosophy: A Novel Decision Paradigm, In Neutrosophic Theory and Its Applications. Collected Papers, Volume 1, EuropaNova, Bruxelles, 2014, pp. 424-439.

- [281] Pranab Biswas, Surapati Pramanik, Bibhas C. Giri, TOPSIS method for multi-attribute group decision-making under single-valued neutrosophic environment, In Neural Comput & Applic., 2015, 11 p.
- [282] Pabitra Kumar Maji, Weighted Neutrosophic Soft Sets. In Neutrosophic Sets and Systems, Vol. 6, 2014, pp. 6-11.
- [283] Pabitra Kumar Maji, Weighted Neutrosophic Soft Sets Approach in a Multicriteria Decision Making Problem. In Journal of New Theory, 2015, 12 p

Presentations to International Conferences or Seminars

- [1] F. Smarandache, Foundations of Neutrosophic set and Logic and Their Applications to Information Fusion, Okayama University of Science, Kroumov Laboratory, Department of Intelligence Engineering, Okayama, Japan, 17 December 2013.
- [2] Jean Dezert & Florentin Smarandache, Advances and Applications of Dezert-Smarandache Theory (DSmT) for Information Fusion, presented by F. Smarandache, Osaka University, Department of Engineering Science, Inuiguchi Laboratory, Japan, 10 January 2014.
- [3] F. Smarandache, Foundations of Neutrosophic Set and Logic and Their Applications to Information Fusion, Osaka University, Inuiguchi Laboratory, Department of Engineering Science, Osaka, Japan, 10 January 2014.
- [4] F. Smarandache, Alpha-Discounting Method for Multicriteria Decision Making, Osaka University,

Department of Engineering Science, Inuiguchi Laboratory, Japan, 10 January 2014.

- [5] F. Smarandache, The Neutrosophic Triplet Group and its Application to Physics, seminar Universidad Nacional de Quilmes, Department of Science and Technology, Buenos Aires, Argentina, 02 June 2014.
- [6] F. Smarandache, Foundations of Neutrosophic Logic and Set and their Applications to Information Fusion, tutorial, 17th International Conference on Information Fusion, Salamanca, Spain, 7th July 2014.
- [7] Said Broumi, Florentin Smarandache, New Distance and Similarity Measures of Interval Neutrosophic Sets, 17th International Conference on Information Fusion, Salamanca, Spain, 7-10 July 2014.
- [8] F. Smarandache, Foundations of Neutrosophic Logic and Set Theory and their Applications in Science. Neutrosophic Statistics and Neutrosophic Probability. n-Valued Refined Neutrosophic Logic, Universidad Complutense de Madrid, Facultad de Ciencia Matemáticas, Departamento de Geometría y Topología, Instituto Matemático Interdisciplinar (IMI), Madrid, Spain, 9th July 2014.
- [9] F. Smarandache, (T, I, F)-Neutrosophic Structures, Annual Symposium of the Institute of Solid Mechanics, SISOM 2015, Robotics and Mechatronics. Special Session and Work Shop on VIPRO Platform and RABOR Rescue Robots, Romanian Academy, Bucharest, 21-22 May 2015.
- [10] Mumtaz Ali & Florentin Smarandache, Neutrosophic Soluble Groups, Neutrosophic Nilpotent Groups and

Their Properties, Annual Symposium of the Institute of Solid Mechanics, SISOM 2015, Robotics and Mechatronics. Special Session and Work Shop on VIPRO Platform and RABOR Rescue Robots, Romanian Academy, Bucharest, 21-22 May 2015.

- [11] V. Vladareanu, O. I. Sandru, Mihnea Moisescu, F. Smarandache, Hongnian Yu, Modelling and Classification of a Robotic Workspace using Extenics Norms, Annual Symposium of the Institute of Solid Mechanics, Robotics and Mechatronics. Special Session and Work Shop on VIPRO Platform and RABOR Rescue Robots, Romanian Academy, Bucharest, 21-22 May 2015.
- [12] Luige Vladareanu, Octavian Melinte, Liviu Ciupitu, Florentin Smarandache, Mumtaz Ali and Hongbo Wang, NAO robot integration in the virtual platform VIPRO, Annual Symposium of the Institute of Solid Mechanics, SISOM 2015, Robotics and Mechatronics. Special Session and Work Shop on VIPRO Platform and RABOR Rescue Robots, Romanian Academy, Bucharest, 21-22 May 2015.
- [13] F. Smarandache, Types of Neutrosophic Graphs and neutrosophic Algebraic Structures together with their Applications in Technology, Universitatea Transilvania din Brasov, Facultatea de Design de Produs si Mediu, Brasov, Romania, 06 June 2015.

Ph. D. Dissertations

- [1] Eng. Stefan Adrian Dumitru, Contributii in dezvoltarea sistemelor de control neuronal al miscarii robotilor mobili autonomi, adviser Dr. Luige Vlădăreanu, Institute of Solid Mechanics, Romanian Academy, Bucharest, 25 September, 2014.
- [2] Eng. Dănuț Adrian Bucur, Contribuții în controlul mișcării sistemelor de prehensiune pentru roboți și mâini umanoide inteligente, adviser Dr. Luige Vlădăreanu, Institute of Solid Mechanics, Romanian Academy, Bucharest, 25 September, 2014.
- [3] Eng. Daniel Octavian Melinte, Cercetari teoretice si experimentale privind controlul sistemelor mecanice de pozitionare cu precizie ridicata, advisers Dr. Luige Vlădăreanu & Dr. Florentin Smarandache, Institute of Solid Mechanics, Romanian Academy, Bucharest, September 2014 .
- [4] Eng. Ionel Alexandru Gal, Contributions to the Development of Hybrid Force-Position Control Strategies for Mobile Robots Control, advisers Dr. Luige Vlădăreanu & Dr. Florentin Smarandache, Institute of Solid Mechanics, Romanian Academy, Bucharest, October 14, 2013.
- [5] Smita Rajpal, Intelligent Searching Techniques to Answer Queries in RDBMS, Ph D Dissertation in progress, under the supervision of Prof. M. N. Doja, Department of Computer Engineering Faculty of Engineering, Jamia Millia Islamia, New Delhi, India, 2011.

- [6] Josué Antonio Nescolarde Selva, A Systematic Vision of Belief Systems and Ideologies, under the supervision of Dr. Josep Llus Usó I Domènech, Dr. Francesco Eves Macià, Universidad de Alicante, Spain, 2010.
- [7] Ming Zhang, Novel Approaches to Image Segmentation Based on Neutrosophic Logic, Ph D Dissertation, Utah State University, Logan, Utah, USA, All Graduate Theses and Dissertations, Paper 795, 12-1-201, 2010.
- [8] Haibin Wang, Study on Interval Neutrosophic Set and Logic, Georgia State University, Atlanta, USA, 2005.
- [9] Sukanto Bhattacharya, Utility, Rationality and Beyond - From Finance to Informational Finance [using Neutrosophic Probability], Bond University, Queensland, Australia, 2004.

Neutrosophic Analysis is a generalization of Set Analysis, which in its turn is a generalization of Interval Analysis.

Neutrosophic Precalculus is referred to indeterminate staticity, while Neutrosophic Calculus is the mathematics of indeterminate change.

The Neutrosophic Precalculus and Neutrosophic Calculus can be developed in many ways, depending on the types of indeterminacy one has and on the methods used to deal with such indeterminacy.

In this book, the author presents a few examples of indeterminacies and several methods to deal with these specific indeterminacies, but many other indeterminacies there exist in our everyday life, and they have to be studied and resolved using similar or different methods. Therefore, more research should be done in the field of neutrosophics.

The author introduces for the first time the notions of neutrosophic mereo-limit, neutrosophic mereo-continuity (in a different way from the classical semi-continuity), neutrosophic mereo-derivative and neutrosophic mereo-integral (both in different ways from the fractional calculus), besides the classical definitions of limit, continuity, derivative, and integral respectively. Future research may be done in the neutrosophic fractional calculus.

\$19.95

