

The 3th Conference on Combinatorics and Graph theory of China  
July 19-23, Shanghai, P.R.China

# Labeled Graphs with Combinatorial Manifolds

**Linfan Mao**

(Chinese Academy of Mathematics and System Science, Beijing 100080)

*maolinfan@163.com*

**Shanghai--July 2008**

# ABSTRACT

In this speech, I will prescribe limitation on following topics and mainly concentrate on myself works for *combinatorially differential geometry*, particularly, the combinatorial counterpart in recent years.

- *motivation.*
- *what is a combinatorial manifold?*
- *topological characteristics on combinatorial manifolds with labeled graphs.*
- *differential characteristics on combinatorial manifolds, these differentially combinatorial manifolds.*

# 1. Motivation

- A view of the sky by eyes of a man on the earth



**Question:** *where do we come from? where will we go?*

● **TAO TEH KING** (道德经) *said:*

道生一，一生二，二生三，三生万物。万物负阴而抱阳，冲气以为和。

The Tao gives birth to One. One gives birth to Two. Two gives birth to Three. Three gives birth to all things. All things have their backs to the female and stand facing the male. When male and female combine, all things achieve harmony.

人法地，地法天，天法道，道法自然。

Man follows the earth. Earth follows the universe. The universe follows the Tao. The Tao follows only itself.

**What is these sentences meaning?** All things that we can acknowledge is determined by our eyes, or ears, or nose, or tongue, or body or passions, i.e., these six organs.



- What are these words meaning?

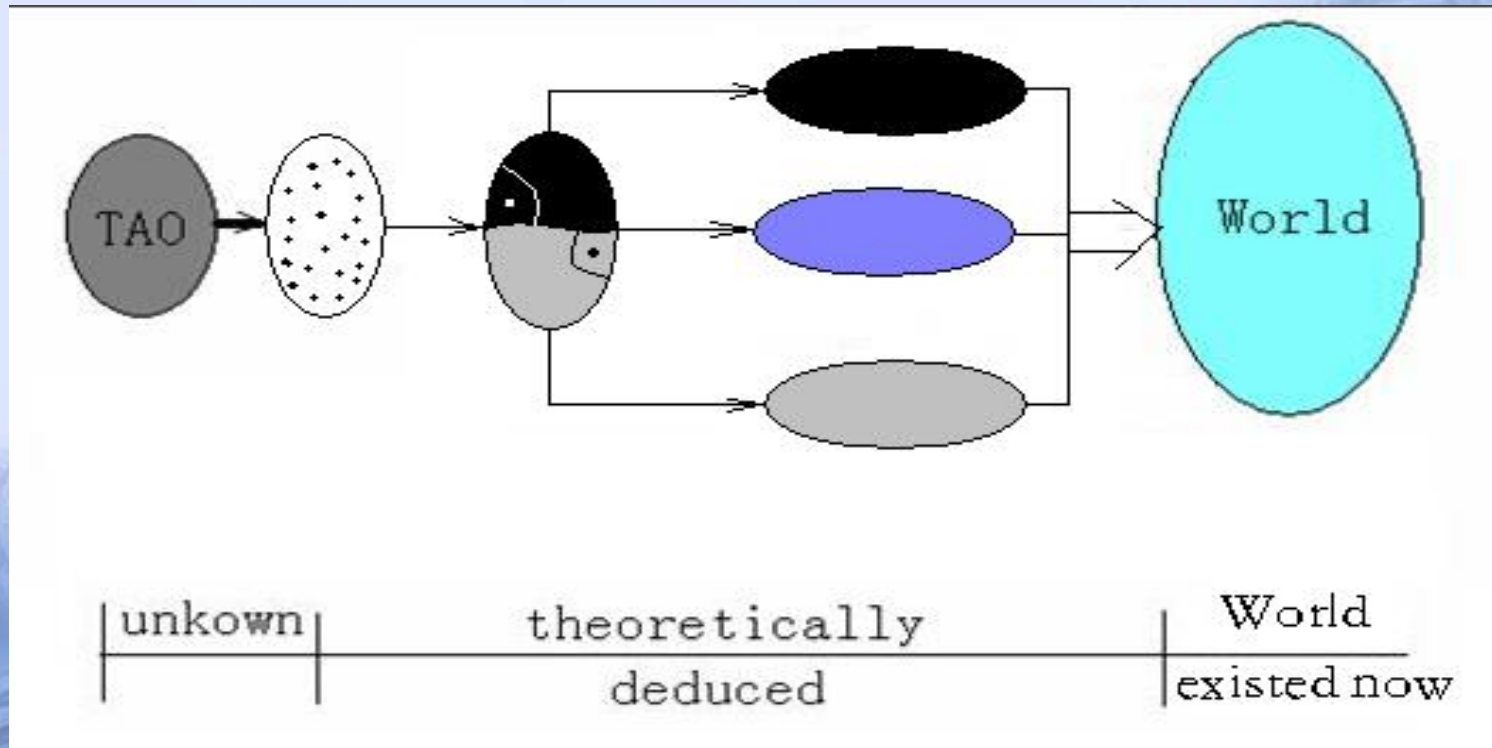

Here, the *theoretically deduced* is done by logic, particularly, by mathematical deduction.

- Researchs on the unknown world by experiment on CMB

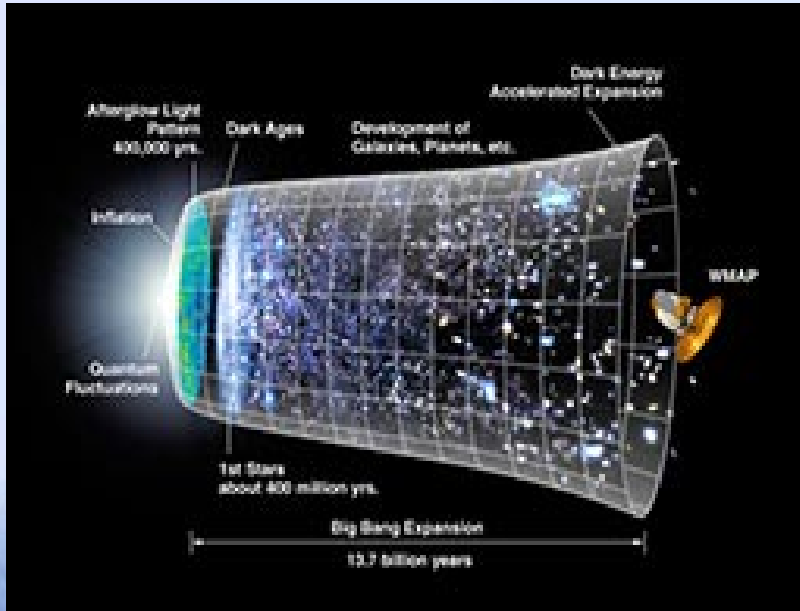

CMBtimeline

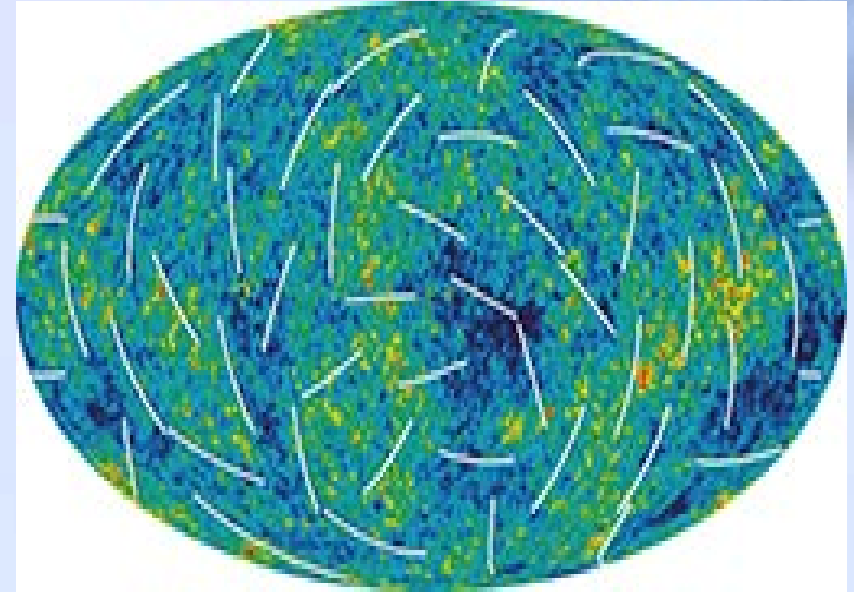

WMAP 2003

**Peoples wined the Noble Prize for research on CMB:**

**A.Penzias and R.Wilson , *in physics in 1978***

**G.F.Smoot and J.C.Mather, *in physics in 2006***

- ***What is the structure of the world?***

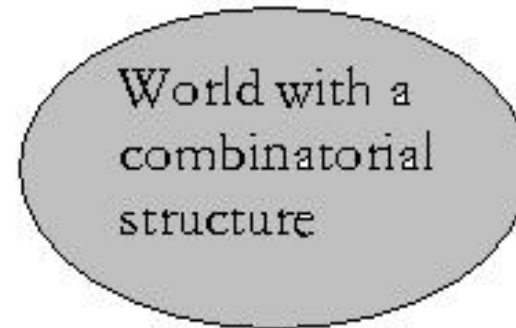
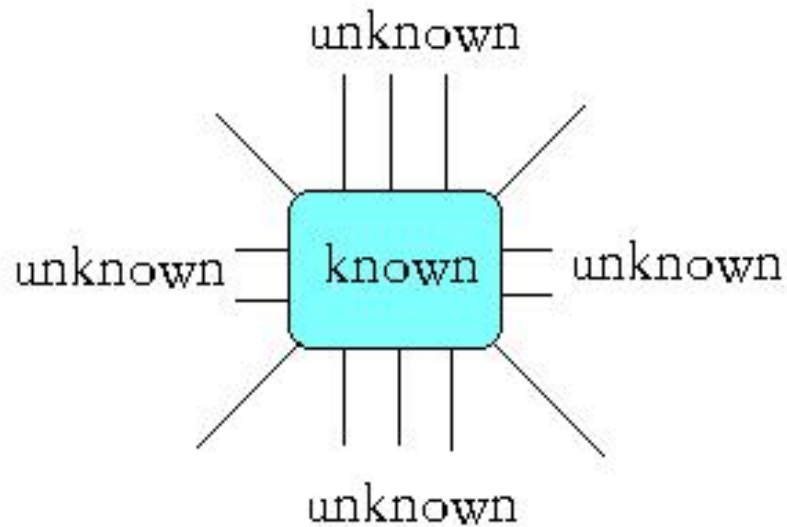

**Experiment Scientists**

**Combinatorial Scientists**

- A depiction of a person with the world by combinatoricians

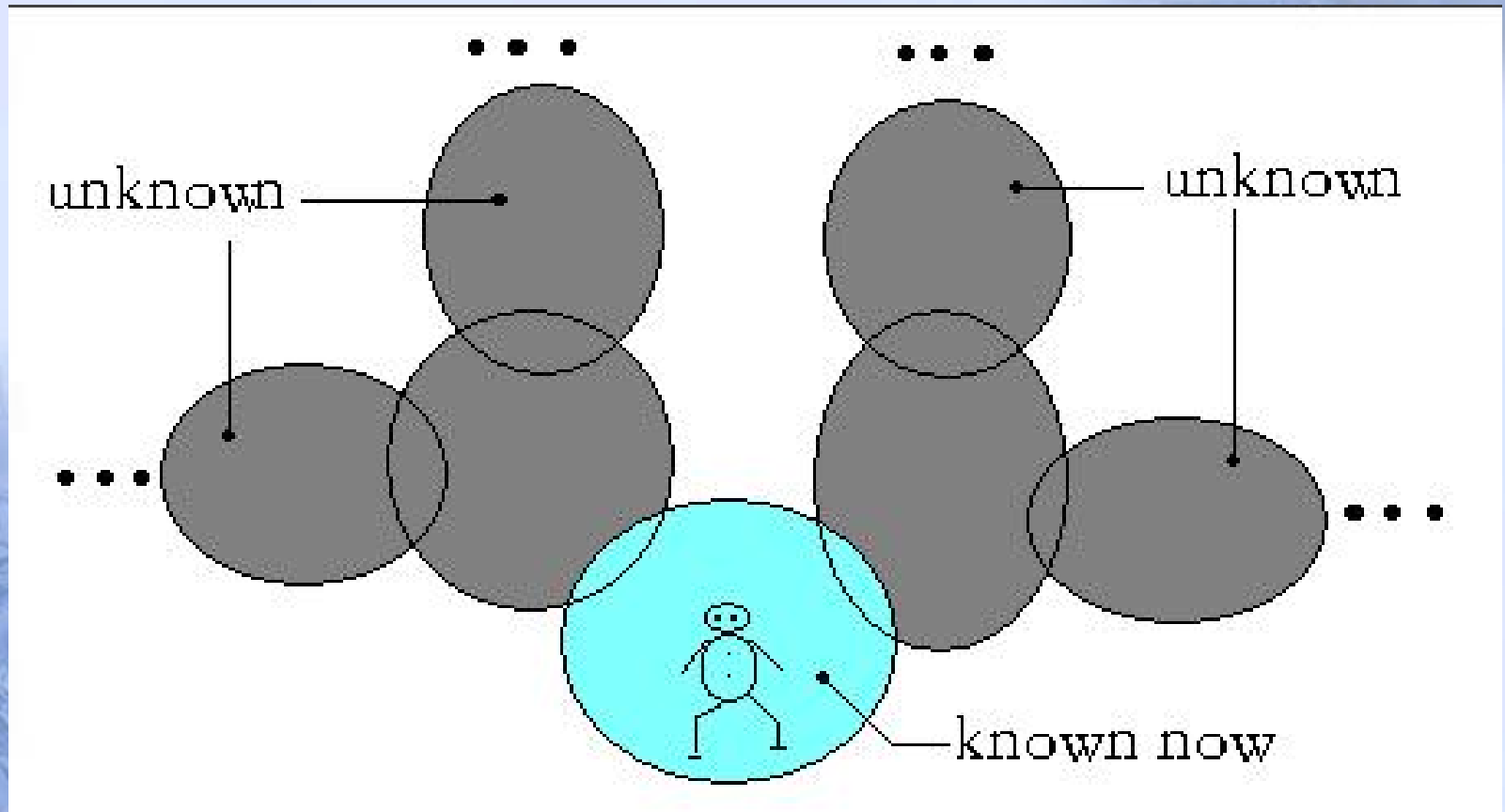



- **What is a combinatorial manifold?**

Loosely speaking, a combinatorial manifold is a combination of finite manifolds, such as those shown in the next figure.

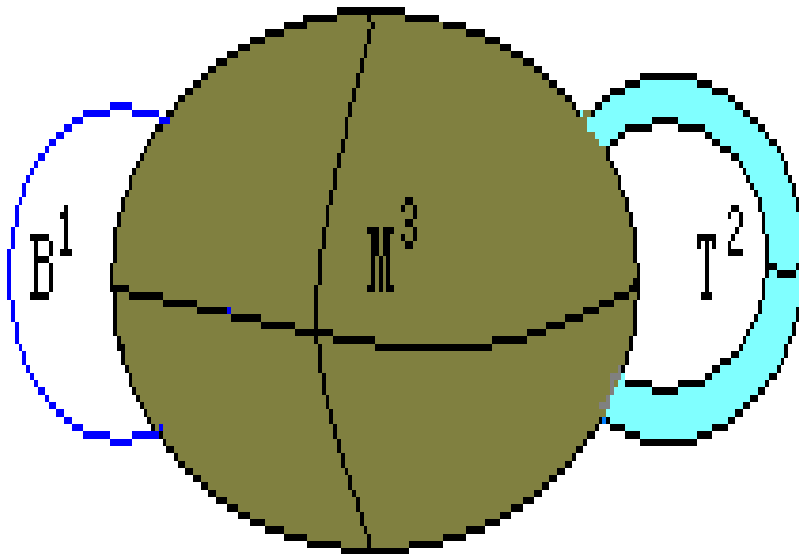

(a)

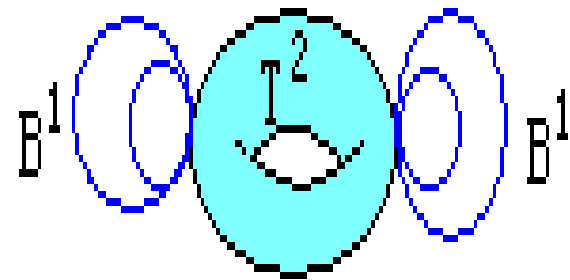

(b)

## 2. Combinatorial Manifolds

**Definition 2.1** For a given integer sequence  $n_1, n_2, \dots, n_m, m \geq 1$  with  $0 < n_1 < n_2 < \dots < n_s$ , a combinatorial manifold  $\widetilde{M}$  is a Hausdorff space such that for any point  $p \in \widetilde{M}$ , there is a local chart  $(U_p, \varphi_p)$  of  $p$ , i.e., an open neighborhood  $U_p$  of  $p$  in  $\widetilde{M}$  and a homeomorphism  $\varphi_p : U_p \rightarrow \widetilde{B}(n_1(p), n_2(p), \dots, n_{s(p)}(p))$  with  $\{n_1(p), n_2(p), \dots, n_{s(p)}(p)\} \subseteq \{n_1, n_2, \dots, n_m\}$  and  $\bigcup_{p \in \widetilde{M}} \{n_1(p), n_2(p), \dots, n_{s(p)}(p)\} = \{n_1, n_2, \dots, n_m\}$ , denoted by  $\widetilde{M}(n_1, n_2, \dots, n_m)$  or  $\widetilde{M}$  on the context and

$$\widetilde{\mathcal{A}} = \{(U_p, \varphi_p) | p \in \widetilde{M}(n_1, n_2, \dots, n_m)\}$$

an atlas on  $\widetilde{M}(n_1, n_2, \dots, n_m)$ . The maximum value of  $s(p)$  and the dimension  $\widehat{s}(p)$  of  $\bigcap_{i=1}^{s(p)} B_i^{n_i}$  are called the dimension and the intersectional dimension of  $\widetilde{M}(n_1, n_2, \dots, n_m)$  at the point  $p$ , respectively.

- vertex-edge labeled graphs of combinatorial manifolds

A vertex-edge labeled graph  $G([1, k], [1, l])$  is a connected graph  $G = (V, E)$  with two mappings

$$\tau_1 : V \rightarrow \{1, 2, \dots, k\}, \quad \tau_2 : E \rightarrow \{1, 2, \dots, l\}$$

for integers  $k$  and  $l$ . For example, two vertex-edge labeled graphs with an underlying graph  $K_4$  are shown in the next figure.

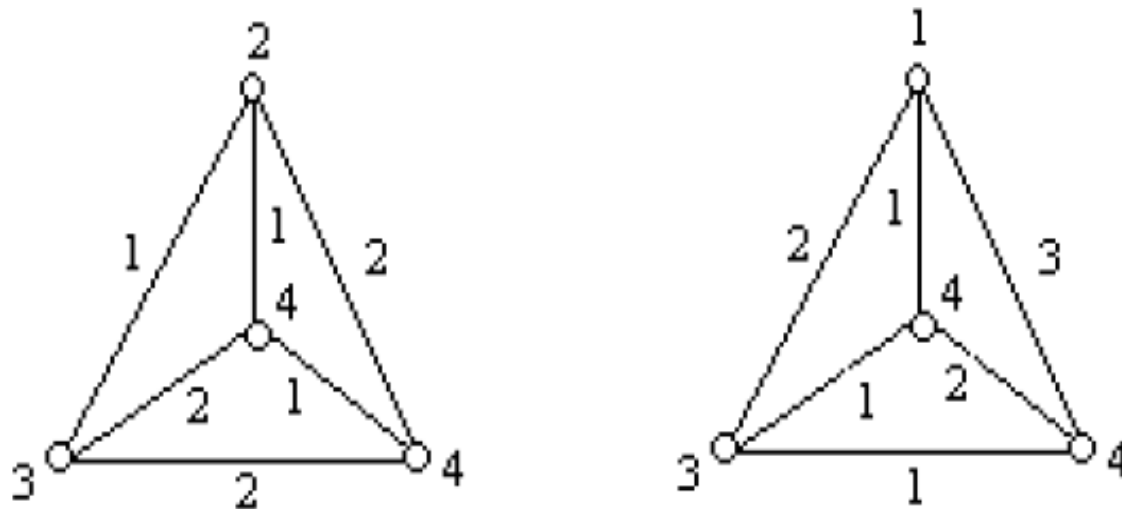

$\mathcal{H}(n_1, n_2, \dots, n_m)$  — all finitely combinatorial manifolds  $\tilde{M}(n_1, n_2, \dots, n_m)$

$\mathcal{G}[0, n_m]$  — all vertex-edge labeled graphs  $G([0, n_m], [0, n_m])$  with

- (1) Each induced subgraph by vertices labeled with 1 in  $G$  is a union of complete graphs and vertices labeled with 0 can only be adjacent to vertices labeled with 1.
- (2) For each edge  $e = (u, v) \in E(G)$ ,  $\tau_2(e) \leq \min\{\tau_1(u), \tau_1(v)\}$ .

**Theorem 2.1** *Let  $1 \leq n_1 < n_2 < \dots < n_m, m \geq 1$  be a given integer sequence. Then every finitely combinatorial manifold  $\tilde{M} \in \mathcal{H}(n_1, n_2, \dots, n_m)$  defines a vertex-edge labeled graph  $G([0, n_m], [0, n_m]) \in \mathcal{G}[0, n_m]$ . Conversely, every vertex-edge labeled graph  $G([0, n_m], [0, n_m]) \in \mathcal{G}[0, n_m]$  defines a finitely combinatorial manifold  $\tilde{M} \in \mathcal{H}(n_1, n_2, \dots, n_m)$  with a 1 – 1 mapping  $\theta : G([0, n_m], [0, n_m]) \rightarrow \tilde{M}$  such that  $\theta(u)$  is a  $\theta(u)$ -manifold in  $\tilde{M}$ ,  $\tau_1(u) = \dim\theta(u)$  and  $\tau_2(v, w) = \dim(\theta(v) \cap \theta(w))$  for  $\forall u \in V(G([0, n_m], [0, n_m]))$  and  $\forall (v, w) \in E(G([0, n_m], [0, n_m]))$ .*



## ■ fundamental d-groups

**Definition 2.2** For two points  $p, q$  in a finitely combinatorial manifold  $M(n_1, n_2, \dots, n_m)$ , if there is a sequence  $B_1, B_2, \dots, B_s$  of  $d$ -dimensional open balls with two conditions following hold.

- (1)  $B_i \subset \widetilde{M}(n_1, n_2, \dots, n_m)$  for any integer  $i, 1 \leq i \leq s$  and  $p \in B_1, q \in B_s$ ;
- (2) The dimensional number  $\dim(B_i \cap B_{i+1}) \geq d$  for  $\forall i, 1 \leq i \leq s - 1$ .

Then points  $p, q$  are called  $d$ -dimensional connected in  $\widetilde{M}(n_1, n_2, \dots, n_m)$  and the sequence  $B_1, B_2, \dots, B_s$  a  $d$ -dimensional path connecting  $p$  and  $q$ , denoted by  $P^d(p, q)$ .

If each pair  $p, q$  of points in the finitely combinatorial manifold  $\widetilde{M}(n_1, n_2, \dots, n_m)$  is  $d$ -dimensional connected, then  $\widetilde{M}(n_1, n_2, \dots, n_m)$  is called  $d$ -pathwise connected and say its connectivity  $\geq d$ .

Choose a graph with vertex set being manifolds labeled by its dimension and two manifold adjacent with a label of the dimension of the intersection if there is a  $d$ -path in this combinatorial manifold. Such graph is denoted by  $G^d$ .  $d=1$  in (a) and (b),  $d=2$  in (c) and (d) in the next figure.

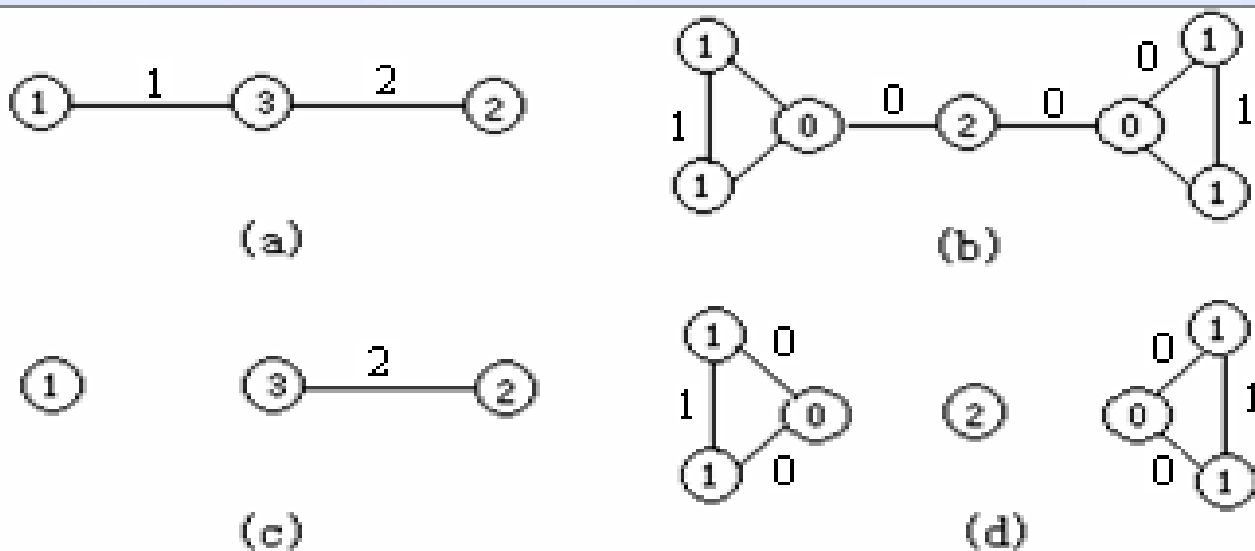

**Definition 2.3** Let  $\widetilde{M}(n_1, n_2, \dots, n_m)$  be a finitely combinatorial manifold. For an integer  $d, 1 \leq d \leq n_1$  and  $\forall x \in \widetilde{M}(n_1, n_2, \dots, n_m)$ , a fundamental  $d$ -group at the point  $x$ , denoted by  $\pi^d(\widetilde{M}(n_1, n_2, \dots, n_m), x)$  is defined to be a group generated by all homotopic classes of closed  $d$ -paths based at  $x$ .

**Theorem 2.2** Let  $\widetilde{M}(n_1, n_2, \dots, n_m)$  be a  $d$ -connected finitely combinatorial manifold with  $1 \leq d \leq n_1$ . Then

(1) for  $\forall x \in \widetilde{M}(n_1, n_2, \dots, n_m)$ ,

$$\pi^d(\widetilde{M}(n_1, n_2, \dots, n_m), x) \cong \left( \bigoplus_{M \in V(G^d)} \pi^d(M) \right) \bigoplus \pi(G^d),$$

where  $G^d = G^d[\widetilde{M}(n_1, n_2, \dots, n_m)]$ ,  $\pi^d(M), \pi(G^d)$  denote the fundamental  $d$ -groups of a manifold  $M$  and the graph  $G^d$ , respectively and

(2) for  $\forall x, y \in \widetilde{M}(n_1, n_2, \dots, n_m)$ ,

$$\pi^d(\widetilde{M}(n_1, n_2, \dots, n_m), x) \cong \pi^d(\widetilde{M}(n_1, n_2, \dots, n_m), y).$$

### 3. Differential Structures on Combinatorial Manifolds

- What is a differentiable manifold?

An *differential  $n$ -manifold*  $(M^n, \mathcal{A})$  is an  $n$ -manifold  $M^n$ ,  $M^n = \bigcup_{i \in I} U_i$ , endowed with a  $C^r$  differential structure  $\mathcal{A} = \{(U_\alpha, \varphi_\alpha) | \alpha \in I\}$  on  $M^n$  for an integer  $r$  with following conditions hold.

(1)  $\{U_\alpha; \alpha \in I\}$  is an open covering of  $M^n$ ;

(2) For  $\forall \alpha, \beta \in I$ , atlases  $(U_\alpha, \varphi_\alpha)$  and  $(U_\beta, \varphi_\beta)$  are *equivalent*, i.e.,  $U_\alpha \cap U_\beta = \emptyset$  or  $U_\alpha \cap U_\beta \neq \emptyset$  but the *overlap maps*

$$\varphi_\alpha \varphi_\beta^{-1} : \varphi_\beta(U_\alpha \cap U_\beta) \rightarrow \varphi_\alpha(U_\alpha) \quad \text{and} \quad \varphi_\beta \varphi_\alpha^{-1} : \varphi_\alpha(U_\alpha \cap U_\beta) \rightarrow \varphi_\beta(U_\beta)$$

are  $C^r$ ;

(3)  $\mathcal{A}$  is maximal, i.e., if  $(U, \varphi)$  is an atlas of  $M^n$  equivalent with one atlas in  $\mathcal{A}$ , then  $(U, \varphi) \in \mathcal{A}$ .



An explain for condition (2).

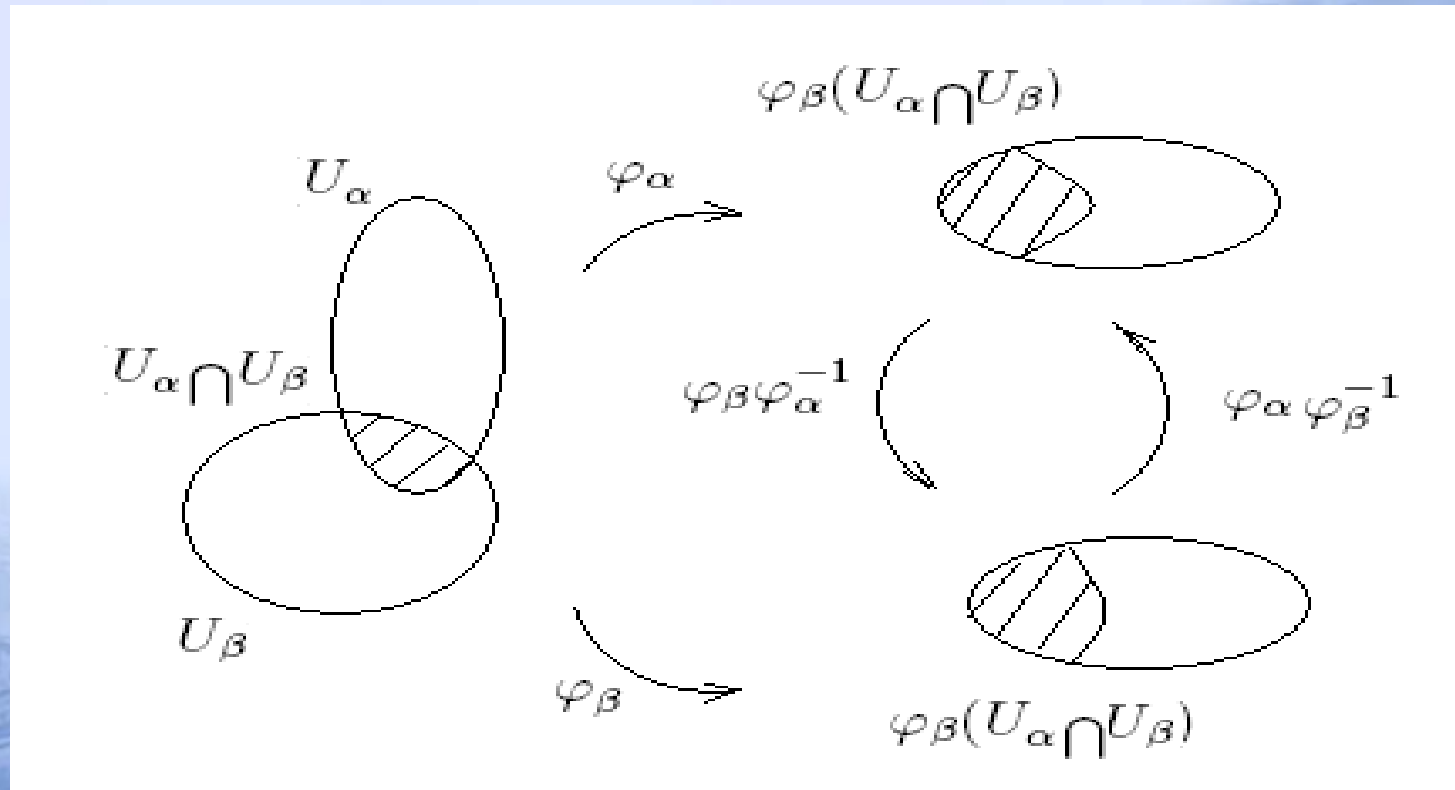

An  $n$ -manifold is *smooth* if it is endowed with a  $C^\infty$  differential structure.

- What is a differentiable combinatorial manifold?

**Definition 3.1** For a given integer sequence  $1 \leq n_1 < n_2 < \dots < n_m$ , a combinatorially  $C^h$  differential manifold  $(\tilde{M}(n_1, n_2, \dots, n_m); \tilde{\mathcal{A}})$  is a finitely combinatorial manifold  $\tilde{M}(n_1, n_2, \dots, n_m)$ ,  $\tilde{M}(n_1, n_2, \dots, n_m) = \bigcup_{i \in I} U_i$ , endowed with a atlas  $\tilde{\mathcal{A}} = \{(U_\alpha; \varphi_\alpha) | \alpha \in I\}$  on  $\tilde{M}(n_1, n_2, \dots, n_m)$  for an integer  $h, h \geq 1$  with conditions following hold.

(1)  $\{U_\alpha; \alpha \in I\}$  is an open covering of  $\tilde{M}(n_1, n_2, \dots, n_m)$ ;

(2) For  $\forall \alpha, \beta \in I$ , local charts  $(U_\alpha; \varphi_\alpha)$  and  $(U_\beta; \varphi_\beta)$  are equivalent, i.e.,  $U_\alpha \cap U_\beta = \emptyset$  or  $U_\alpha \cap U_\beta \neq \emptyset$  but the overlap maps

$$\varphi_\alpha \varphi_\beta^{-1} : \varphi_\beta(U_\alpha \cap U_\beta) \rightarrow \varphi_\alpha(U_\alpha) \quad \text{and} \quad \varphi_\beta \varphi_\alpha^{-1} : \varphi_\alpha(U_\alpha \cap U_\beta) \rightarrow \varphi_\beta(U_\beta)$$

are  $C^h$  mappings;

(3)  $\tilde{\mathcal{A}}$  is maximal, i.e., if  $(U; \varphi)$  is a local chart of  $\tilde{M}(n_1, n_2, \dots, n_m)$  equivalent with one of local charts in  $\tilde{\mathcal{A}}$ , then  $(U; \varphi) \in \tilde{\mathcal{A}}$ .

- **Local properties of combinatorial manifolds**
- **Tangent vector spaces**

**Definition 3.2** Let  $(\widetilde{M}(n_1, n_2, \dots, n_m), \widetilde{\mathcal{A}})$  be a smoothly combinatorial manifold and  $p \in \widetilde{M}(n_1, n_2, \dots, n_m)$ . A tangent vector  $v$  at  $p$  is a mapping  $v : \mathcal{X}_p \rightarrow \mathbf{R}$  with conditions following hold.

- (1)  $\forall g, h \in \mathcal{X}_p, \forall \lambda \in \mathbf{R}, v(h + \lambda h) = v(g) + \lambda v(h);$
- (2)  $\forall g, h \in \mathcal{X}_p, v(gh) = v(g)h(p) + g(p)v(h).$

**Theorem 3.2** For any point  $p \in \widetilde{M}(n_1, n_2, \dots, n_m)$  with a local chart  $(U_p; [\varphi_p])$ , the dimension of  $T_p \widetilde{M}(n_1, n_2, \dots, n_m)$  is

$$\dim T_p \widetilde{M}(n_1, n_2, \dots, n_m) = \widehat{s}(p) + \sum_{i=1}^{s(p)} (n_i - \widehat{s}(p)) \quad \text{with a basis matrix} \quad \left[ \frac{\partial}{\partial x} \right]_{s(p) \times n_{s(p)}} =$$

$$\begin{bmatrix} \frac{1}{s(p)} \frac{\partial}{\partial x^{11}} & \cdots & \frac{1}{s(p)} \frac{\partial}{\partial x^{1\widehat{s}(p)}} & \frac{\partial}{\partial x^{1(\widehat{s}(p)+1)}} & \cdots & \frac{\partial}{\partial x^{1n_1}} & \cdots & 0 \\ \frac{1}{s(p)} \frac{\partial}{\partial x^{21}} & \cdots & \frac{1}{s(p)} \frac{\partial}{\partial x^{2\widehat{s}(p)}} & \frac{\partial}{\partial x^{2(\widehat{s}(p)+1)}} & \cdots & \frac{\partial}{\partial x^{2n_2}} & \cdots & 0 \\ \cdots & \cdots & \cdots & \cdots & \cdots & \cdots & \cdots & \cdots \\ \frac{1}{s(p)} \frac{\partial}{\partial x^{s(p)1}} & \cdots & \frac{1}{s(p)} \frac{\partial}{\partial x^{s(p)\widehat{s}(p)}} & \frac{\partial}{\partial x^{s(p)(\widehat{s}(p)+1)}} & \cdots & \cdots & \frac{\partial}{\partial x^{s(p)(n_{s(p)}-1)}} & \frac{\partial}{\partial x^{s(p)n_{s(p)}}} \end{bmatrix}$$

where  $x^{il} = x^{jl}$  for  $1 \leq i, j \leq s(p), 1 \leq l \leq \widehat{s}(p)$ .

- tensor fields

**Definition 3.3** Let  $\widetilde{M}(n_1, n_2, \dots, n_m)$  be a smoothly combinatorial manifold and  $p \in \widetilde{M}(n_1, n_2, \dots, n_m)$ . A tensor of type  $(r, s)$  at the point  $p$  on  $\widetilde{M}(n_1, n_2, \dots, n_m)$  is an  $(r + s)$ -multilinear function  $\tau$ ,

$$\tau : \underbrace{T_p^* \widetilde{M} \times \dots \times T_p^* \widetilde{M}}_r \times \underbrace{T_p \widetilde{M} \times \dots \times T_p \widetilde{M}}_s \rightarrow \mathbf{R},$$

where  $T_p \widetilde{M} = T_p \widetilde{M}(n_1, n_2, \dots, n_m)$  and  $T_p^* \widetilde{M} = T_p^* \widetilde{M}(n_1, n_2, \dots, n_m)$ .

**Theorem 3.3** Let  $\widetilde{M}(n_1, n_2, \dots, n_m)$  be a smoothly combinatorial manifold and  $p \in \widetilde{M}(n_1, n_2, \dots, n_m)$ . Then

$$T_s^r(p, \widetilde{M}) = \underbrace{T_p \widetilde{M} \otimes \dots \otimes T_p \widetilde{M}}_r \otimes \underbrace{T_p^* \widetilde{M} \otimes \dots \otimes T_p^* \widetilde{M}}_s,$$

where  $T_p \widetilde{M} = T_p \widetilde{M}(n_1, n_2, \dots, n_m)$  and  $T_p^* \widetilde{M} = T_p^* \widetilde{M}(n_1, n_2, \dots, n_m)$ , particularly,

$$\dim T_s^r(p, \widetilde{M}) = (\widehat{s}(p) + \sum_{i=1}^{s(p)} (n_i - \widehat{s}(p)))^{r+s}.$$



## ● curvature tensor

**Definition 3.4** A connection  $\tilde{D}$  on a smoothly combinatorial manifold  $\tilde{M}$  is a mapping  $\tilde{D} : \mathcal{X}(\tilde{M}) \times T_s^r \tilde{M} \rightarrow T_s^r \tilde{M}$  on tensors of  $\tilde{M}$  with  $\tilde{D}_X \tau = \tilde{D}(X, \tau)$  such that for  $\forall X, Y \in \mathcal{X} \tilde{M}$ ,  $\tau, \pi \in T_s^r(\tilde{M})$ ,  $\lambda \in \mathbf{R}$  and  $f \in C^\infty(\tilde{M})$ ,

$$(1) \quad \tilde{D}_{X+fY} \tau = \tilde{D}_X \tau + f \tilde{D}_Y \tau \quad \text{and} \quad \tilde{D}_X(\tau + \lambda \pi) = \tilde{D}_X \tau + \lambda \tilde{D}_X \pi;$$

$$(2) \quad \tilde{D}_X(\tau \otimes \pi) = \tilde{D}_X \tau \otimes \pi + \tau \otimes \tilde{D}_X \pi;$$

$$(3) \quad \text{for any contraction } C \text{ on } T_s^r(\tilde{M}), \quad \tilde{D}_X(C(\tau)) = C(\tilde{D}_X \tau).$$

A combinatorially connection space is a 2-tuple  $(\tilde{M}, \tilde{D})$  consisting of a smoothly combinatorial manifold  $\tilde{M}$  with a connection  $\tilde{D}$  and a torsion tensor  $\tilde{T} : \mathcal{X}(\tilde{M}) \times \mathcal{X}(\tilde{M}) \rightarrow \mathcal{X}(\tilde{M})$  on  $(\tilde{M}, \tilde{D})$  is defined by  $\tilde{T}(X, Y) = \tilde{D}_X Y - \tilde{D}_Y X - [X, Y]$  for  $\forall X, Y \in \mathcal{X}(\tilde{M})$ . If  $\tilde{T}|_U(X, Y) \equiv 0$  in a local chart  $(U, [\varphi])$ , then  $\tilde{D}$  is called torsion-free on  $(U, [\varphi])$ . For  $\forall X, Y \in \mathcal{X}(\tilde{M})$ , a combinatorially curvature operator

$\tilde{\mathcal{R}}(X, Y) : \mathcal{X}(\tilde{M}) \rightarrow \mathcal{X}(\tilde{M})$  is defined by

$$\tilde{\mathcal{R}}(X, Y)Z = \tilde{D}_X \tilde{D}_Y Z - \tilde{D}_Y \tilde{D}_X Z - \tilde{D}_{[X, Y]} Z$$

for  $\forall Z \in \mathcal{X}(\tilde{M})$ .

**Definition 3.5** Let  $\tilde{M}$  be a smoothly combinatorial manifold and  $g \in A^2(\tilde{M}) = \bigcup_{p \in \tilde{M}} T_2^0(p, \tilde{M})$ . If  $g$  is symmetrical and positive, then  $\tilde{M}$  is called a combinatorially Riemannian manifold, denoted by  $(\tilde{M}, g)$ . In this case, if there is a connection  $\tilde{D}$  on  $(\tilde{M}, g)$  with equality following hold

$$Z(g(X, Y)) = g(\tilde{D}_Z Y) + g(X, \tilde{D}_Z Y)$$

then  $\tilde{M}$  is called a combinatorially Riemannian geometry, denoted by  $(\tilde{M}, g, \tilde{D})$ .

In this case,  $\tilde{R} = \tilde{R}_{(\sigma\varsigma)(\eta\theta)(\mu\nu)(\kappa\lambda)} dx^{\sigma\varsigma} \otimes dx^{\eta\theta} \otimes dx^{\mu\nu} \otimes dx^{\kappa\lambda}$  with

$$\begin{aligned} \tilde{R}_{(\sigma\varsigma)(\eta\theta)(\mu\nu)(\kappa\lambda)} &= \frac{1}{2} \left( \frac{\partial^2 g_{(\mu\nu)(\sigma\varsigma)}}{\partial x^{\kappa\lambda} \partial x^{\eta\theta}} + \frac{\partial^2 g_{(\kappa\lambda)(\eta\theta)}}{\partial x^{\mu\nu} \partial x^{\sigma\varsigma}} - \frac{\partial^2 g_{(\mu\nu)(\eta\theta)}}{\partial x^{\kappa\lambda} \partial x^{\sigma\varsigma}} - \frac{\partial^2 g_{(\kappa\lambda)(\sigma\varsigma)}}{\partial x^{\mu\nu} \partial x^{\eta\theta}} \right) \\ &+ \Gamma_{(\mu\nu)(\sigma\varsigma)}^{\vartheta\iota} \Gamma_{(\kappa\lambda)(\eta\theta)}^{\xi\omicron} g_{(\xi\omicron)(\vartheta\iota)} - \Gamma_{(\mu\nu)(\eta\theta)}^{\xi\omicron} \Gamma_{(\kappa\lambda)(\sigma\varsigma)}^{\vartheta\iota} g_{(\xi\omicron)(\vartheta\iota)}, \end{aligned}$$

where  $g_{(\mu\nu)(\kappa\lambda)} = g\left(\frac{\partial}{\partial x^{\mu\nu}}, \frac{\partial}{\partial x^{\kappa\lambda}}\right)$ .

- **Einstein's gravitational equations in multi-spacetimes**

Let  $(\tilde{M}, g, \tilde{D})$  be a combinatorially Riemannian manifold. A type  $(0, 2)$  tensor  $\mathcal{E} : \mathcal{X}(\tilde{M}) \times \mathcal{X}(\tilde{M}) \rightarrow C^\infty(\tilde{M})$  with

$$\mathcal{E} = \mathcal{E}_{(\mu\nu)(\kappa\lambda)} dx^{\mu\nu} \otimes dx^{\kappa\lambda}$$

is called an *energy-momentum tensor* if it satisfies the conservation laws  $\tilde{D}(\mathcal{E}) = 0$ , i.e., for any indexes  $\kappa, \lambda$ ,  $1 \leq \kappa \leq m$ ,  $1 \leq \lambda \leq n_\kappa$ ,

$$\frac{\partial \mathcal{E}_{(\mu\nu)(\kappa\lambda)}}{\partial x^{\kappa\lambda}} - \Gamma_{(\mu\nu)(\kappa\lambda)}^{\sigma\varsigma} \mathcal{E}_{(\sigma\varsigma)(\kappa\lambda)} - \Gamma_{(\kappa\lambda)(\kappa\lambda)}^{\sigma\varsigma} \mathcal{E}_{(\mu\nu)(\sigma\varsigma)} = 0$$

Then we get these *Einstein's* gravitational equations in a multi-spacetime to be

$$\tilde{\mathcal{R}}_{(\mu\nu)(\kappa\lambda)} - \frac{1}{2} \mathbf{R} g_{(\mu\nu)(\kappa\lambda)} + \lambda g_{(\mu\nu)(\kappa\lambda)} = -8\pi G \mathcal{E}_{(\mu\nu)(\kappa\lambda)}.$$

- Global properties of combinatorial manifolds

$$\mathcal{C} = \{(\tilde{U}_\alpha, [\varphi_\alpha]) \mid \alpha \in \tilde{I}\} \text{ --- for } \forall \alpha \in \tilde{I}, \hat{s}(p) + \sum_{i=1}^{s(p)} (n_i - \hat{s}(p)) \text{ is an constant } n_{\tilde{U}_\alpha}$$

$$\text{for } \forall p \in \tilde{U}_\alpha.$$

$$\mathcal{H}_{\tilde{M}} = \{n_{\tilde{U}_\alpha} \mid \alpha \in \tilde{I}\}.$$

**Definition 3.6** Let  $\tilde{M}$  be a smoothly combinatorial manifold with orientation  $\mathcal{O}$  and  $(\tilde{U}; [\varphi])$  a positively oriented chart with a constant  $n_{\tilde{U}}$ . Suppose  $\omega \in \Lambda^{nv}(\tilde{M})$ ,  $\tilde{U} \subset \tilde{M}$  has compact support  $\tilde{C} \subset \tilde{U}$ . Then define

$$\int_{\tilde{C}} \omega = \int \varphi_*(\omega|_{\tilde{U}}).$$

Now if  $\mathcal{C}_{\tilde{M}}$  is an atlas of positively oriented charts with an integer set  $\mathcal{H}_{\tilde{M}}$ , let  $\tilde{P} = \{(\tilde{U}_\alpha, \varphi_\alpha, g_\alpha) \mid \alpha \in \tilde{I}\}$  be a partition of unity subordinate to  $\mathcal{C}_{\tilde{M}}$ . For  $\forall \omega \in \Lambda^n(\tilde{M})$ ,  $n \in \mathcal{H}_{\tilde{M}}$ , an integral of  $\omega$  on  $\tilde{P}$  is defined by

$$\int_{\tilde{P}} \omega = \sum_{\alpha \in \tilde{I}} \int g_\alpha \omega.$$



- **A generalization of Stokes theorem**

**Theorem 3.4** *Let  $\tilde{M}$  be a smoothly combinatorial manifold with an integer set  $\mathcal{H}_{\tilde{M}}(n, m)$  and  $\tilde{D}$  a boundary subset of  $\tilde{M}$ . For  $\forall \tilde{n} \in \mathcal{H}_{\tilde{M}}(n, m)$  if  $\omega \in \Lambda^{\tilde{n}}(\tilde{M})$  has a compact support, then  $\int_{\tilde{D}} \tilde{d}\omega = \int_{\partial\tilde{D}} \omega$  with the convention  $\int_{\partial\tilde{D}} \omega = 0$  while  $\partial\tilde{D} = \emptyset$ .*

**Theorem 3.5** *Let  $G([0, n_m], [0, n_m])$  be a vertex-edge labeled graph with an integer set  $\mathcal{H}_G(n, m)$  and  $\tilde{D}$  a boundary subset of  $G([0, n_m], [0, n_m])$ . For  $\forall \tilde{n} \in \mathcal{H}_G(n, m)$  if  $\omega \in \Lambda^{\tilde{n}}(G([0, n_m], [0, n_m]))$  has a compact support, then  $\int_{\tilde{D}} \tilde{d}\omega = \int_{\partial\tilde{D}} \omega$  with the convention  $\int_{\partial\tilde{D}} \omega = 0$  while  $\partial\tilde{D} = \emptyset$ .*

**Corollary 3.1** *Let  $G([0, n_m], [0, n_m])$  be a vertex-edge labeled graph with an integer set  $\mathcal{H}_G(n, m)$ . For  $\forall \tilde{n} \in \mathcal{H}_G(n, m)$  if  $\omega \in \Lambda^{\tilde{n}}(G([0, n_m], [0, n_m]))$  has a compact support, then*

$$\int_{G([0, n_m], [0, n_m])} \omega = 0.$$



## 4. Further Reading of My Works

- [1] Automorphism Groups of Maps, Surfaces and Smarandache Geometries, American Research Press, 2005.
- [2] Smarandache Multi-Space Theory, Hexis, Phoenix, American, 2006.
- [3] Selected Papers on Mathematical Combinatorics, World Academic Union, 2006.
- [4] Combinatorial speculation and combinatorial conjecture for mathematics, International J.Math. Combin. Vol.1(2007), No.1, 1-19.
- [5] Geometrical theory on combinatorial manifolds, JP J.Geometry and Topology, Vol.7, No.1(2007),65-114.
- [6] An introduction to Smarandache multi-spaces and mathematical ombinatorics, Scientia Magna, Vol.3, No.1(2007),54-80.

上述文献，均可以在《中国科技论文在线》优秀学者栏目作者名目下免费下载。更多的，参见正在写作的：

**Geometry and Combinatorial Field Theory**

(Plan to publish in USA in 2009)

Thanks!