

# Techno-Art of Selariu Supermathematics Functions

2nd volume

Editor: Florentin Smarandache

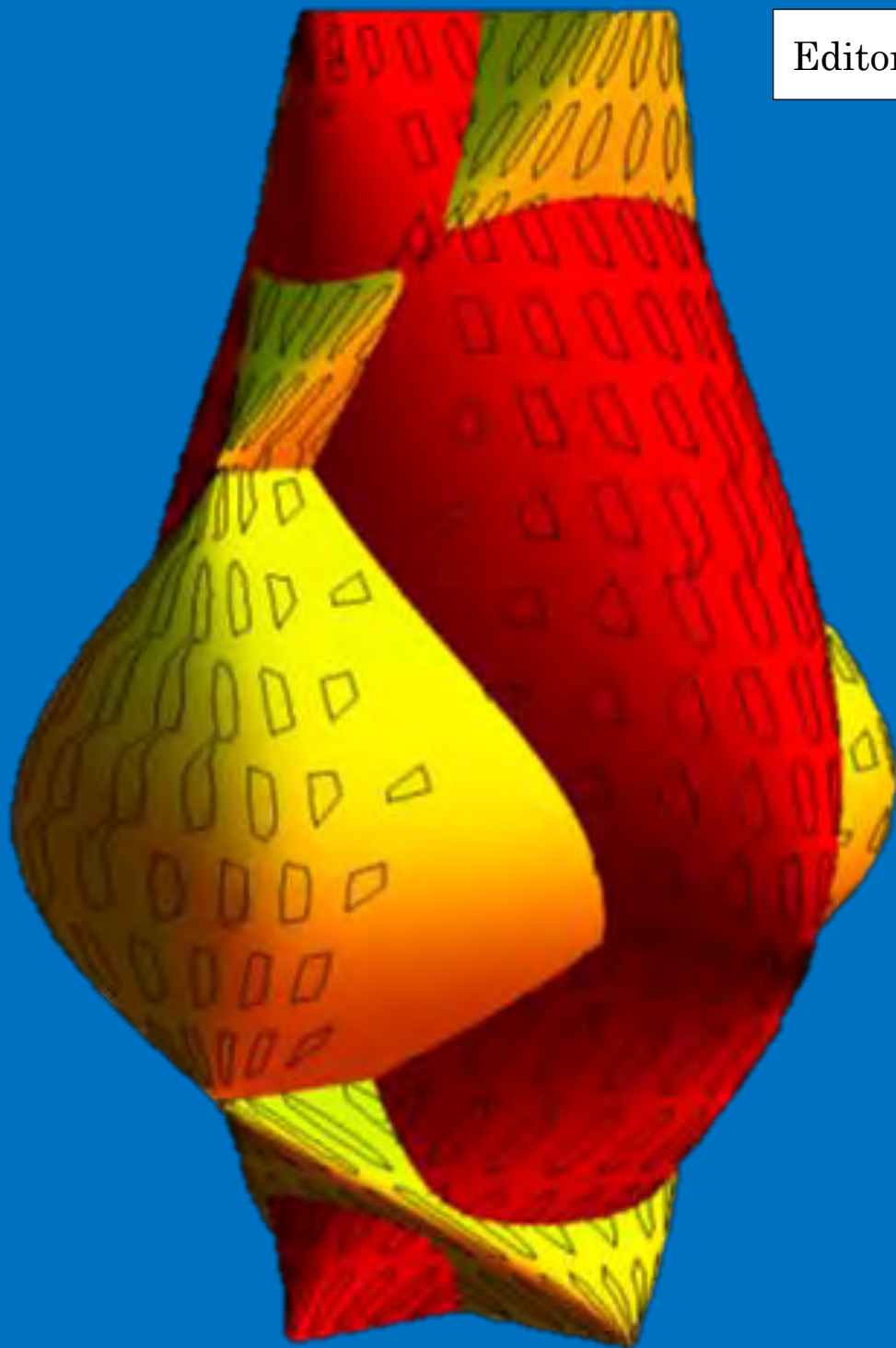

**TECHNO-ART OF SELARIU SUPERMATHEMATICS FUNCTIONS**

2nd volume

---

Editor: Florentin Smarandache

Foreword: Ioan Ghiocel

Contact Mircea Eugen Şelariu at:

[selariu\\_m@yahoo.ro](mailto:selariu_m@yahoo.ro)

[selariume@gmail.com](mailto:selariume@gmail.com)

Contact the editor at:

[smarand@unm.edu](mailto:smarand@unm.edu)

More on the topic:

[www.supermathematica.com](http://www.supermathematica.com)

[www.supermatematica.ro](http://www.supermatematica.ro)

[www.eng.upt.ro/~mselariu](http://www.eng.upt.ro/~mselariu)

[www.cartiAZ.ro](http://www.cartiAZ.ro)

<http://fs.gallup.unm.edu/a/outer-art.htm>

© Pons, Mircea Eugen Şelariu & Florentin Smarandache, 2015

*Book editor:* Georgiana Antonescu. *Pons asbl*,  
Bruxelles, Quai du Batelage, 5, Belgium

ISBN 978-1-59973-376-0



# TECHNO-ART OF SELARIU SUPERMATHEMATICS FUNCTIONS

2nd volume

with a *Foreword* by IOAN GHIOCEL

Editor: FLORENTIN SMARANDACHE

*Pons Publishing*

Brussels, 2015





On the first cover: **Intertwined SM Object**

On the back cover: **Mesh Art Objects**

Peer Reviewers:

Prof. Mihály Bencze, University of Braşov, Romania.

Prof. Valentin Boju, Ph. D., Institut de Technologie de Montréal, Canada.

# CONTENTS

FOREWORD.....7

INTRODUCTION TO SUPERMATHEMATICS FUNCTIONS..... 11

*SUPERMATHEMATICS OBJECTS*

CONOPYRAMIDS..... 24

CONOPYRAMIDS ASSEMBLY..... 25

DOUBLE CLEPSYDRA..... 26

RIDDLED CONOPYRAMIDS IN THREE VIEWS..... 27

ANOTHER DOUBLE CLEPSYDRA..... 31

QUADRILOBIC CLEPSYDRAS ..... 32

QUADRUPLE CLEPSYDRAS ..... 36

THE CUBE ROMANIAN: The Easiest Cube in The World ..... 37

REAL AND SUPERMATHEMATICS CLEPSYDRAS ..... 40

ARTISTIC AND SUPERMATHEMATICS CLEPSYDRAS..... 41

VARIOUS CONES AND PYRAMIDS. Cone continuing transformation in pyramidocon or conopyramid ..... 42

CURIOUS CONOPYRAMIDS..... 47

FLOWER VASES..... 48

CUBES..... 51

INTERTWINED SM OBJECTS ..... 56

QUADRILOBIC CUBES..... 62

SPHEROCUBES ..... 67

GEOMETRY & SUPERMATHEMATICS ..... 73

CHROMATIC ..... 77

SM OBJECTS IN 3D GEOMETRY..... 81

SM VASES & COLUMNS ..... 84

GOBLETS & GLASSES..... 90

EX-CENTRIC SPIRALS ..... 92

CHINESE LAMPIONS..... 94

---

|  |     |
|--|-----|
| RIDDLED PROPELLERS .....                                   | 97  |
| ROUNDBABOUTS .....   | 98  |
| RIBANDS.....   | 100 |
| AERONAUTICAL CAPSULE .....                                 | 102 |
| NASA CAPSULE.....  | 103 |
| SM PLANES .....  | 104 |
| TOROIDS.....   | 107 |
| FRAGMENTED TOROIDS .....                                   | 115 |
| FLOWERS .....  | 121 |
| VASES.....   | 126 |
| BLUE APPEARINGS IN THREE VIEWS .....                       | 131 |
| YELLOW APPEARINGS IN THREE VIEWS .....                     | 132 |
| RED APPEARINGS IN THREE VIEWS.....                         | 133 |
| CYAN APPEARINGS IN THREE VIEWS .....                       | 134 |
| MOTTLED APPEARINGS IN THREE VIEWS .....                    | 135 |
| MESH ART OBJECTS.....                                      | 139 |
| ROMANIAN FOLK DANCE .....                                  | 141 |
| COLORFUL SUPERMATHEMATIC TOROIDS .....                     | 142 |
| EX-CENTRIC SNAILS .....                                    | 143 |
| ARTIFICIAL FLOWERS .....                                   | 144 |
| APPEARINGS ON GEOMETRIC FORMS .....                        | 147 |
| JELLIES .....  | 150 |
| COLUMN ELEMENTS OF EMBRACING THE YELLOW AND THE CYAN ..... | 152 |
| COLUMN ELEMENTS OF ETERNAL LOVE .....                      | 154 |
| COLUMN ELEMENTS OF ETERNAL GRATITUDE .....                 | 156 |

---

## FOREWORD

An ALBUM, according to the dictionary, is defined as "notebook for storing photos, postcards, stamps, lyrics, quotes etc.", which, in other words, means gatherings of "pieces" of the same "species". Or, in the new *Techno-Art of Selariu SuperMathematics Functions* ALBUM (the second book of Selariu SuperMathematics Functions), one contemplates a unique COMPOSITION, INTER-, INTRA- and TRANS-DISCIPLINARY. (Capitalizing here is not a futility, but a harmony with the TRUTH.)

One caveat I am indebted to do, as a consequent "reader" – over time, I received the ALBUM, chapter by chapter, pace by pace, which gave me the time to analyze / deepen all its details: as MUSIC, between the fine arts, distinguishes itself, the same way, among multiple albums, the present ALBUM is absolutely singular!

In understanding music, it is said that there are – it is obviously about the GREAT MUSIC, of CULT/ SYMPHONIC origin – three *stages* to scour:

- *nebulous-emotional* (predominantly sensory perception);
- *lucid-intellectual* (with emphasis on detection of a "literary support");
- *emotional-intellectual* (perception both by feeling and reason).

The parallelism cited in the previous paragraph shall be maintained, so that, by browsing – only! – the ALBUM pages (in order or randomly), you feel induced by the sensation of *pleasure, of love at first sight*; the variety of "exhibits", most of them unusual, the elegance, the symmetry of the layout, the chromatic, and so one, delight the eye, but equally incites to *catchy intellectual exploration*.

A comprehensive and savant INTRODUCTION explains the genesis of the inserted "figures", the addressees being, without discriminating criteria, equally engineers, mathematicians, artists, graphic designers, architects, and all lovers of beauty – as the love of beauty is the supreme form of love. If I should put a label on the "content" of this ALBUM, I would concoct the word NEO-BEAUTY!

The new complements of mathematics, reunited under the name of **ex-centric mathematics** (EM), extend (theoretically, endless) their scope; in this respect, *Selariu SuperMathematics Functions* are undeniable arguments! The author has labored (especially in the last three decades) extensively and fruitfully in the elitist field of the domain, the ample bibliography attesting that, out of its 67 "positions", but 13 are collaborations (yet

with personalities of scientific notoriety), and 42 articles, studies, conferences, papers belong exclusively to the author.

Striking phrases, such as “staggering multiplication of the dimensions of the Universe”, “*integration through differential division*” etc., become plausible (and explained) by replacing *the time* (of Einstein's *four-dimensional space*) with **ex-centricity**. Consequently, classical geometrical bodies (for  $e=0$ ): the sphere, the cylinder, the cone, undergo metamorphosis (for  $e = +/-1$ ), respectively into a cube, a prism, a pyramid. Inevitably and invariably, it is confirmed again that science is a finite space that grows in the infinite space; each new "expansion" does include a new area of unknown, but the unknown is inexhaustible... Besides "*explanatory memorandum*" and explicative relations, dozens of charts, figures and representations complete the full spectrum, such that a consultation of the ALBUM to be made properly and knowingly.

To mention some 'milestones' in this ALBUM, I choose specific mathematical elements, *supermathematically hybridated: quadrilobic cubes, sphericubes, conopyramids, ex-centric spirals, severed toroids*, and the list is far from complete...

There are also those that would qualify as "*utilitarian*": *clepsydras, vases, baskets, lampions*, or those suggestively “baptized” (by the author): *butterflies, octopuses, flying saucers, jellies, roundabouts, ribands*, and so on – all superlatively designed in shapes and colors!

*Apparitions in three views, 3D arrangements, contours, water games, colored / painted eggs*, or even *ex-centric eggs*, and many more, bestow additional meanings, perceived by those who look / analyze as a show of genuine *metaphoric delights*.

Referring to last "*assortment*" of the previous enumeration, a parenthesis is required. In one of his magnificent poems, Nichita Stănescu claims:

*"With no measure, pit by pit,  
I bent the circle, round the leg,  
And in echoes thinking it,  
I ogived it to the egg."\**

The poet accomplishes – in a single quatrain – two performances: (1) *to bend the circle* (2) to give to the noun *ogive* a verb meaning, putting the circle *to ogive* until it hits the "state"

---

\* Editor's translation.

of *egg!* Not to be outdone, the unpredictable author of this ALBUM empowers chickens, thanks to his **SUPERMATHEMATICS**, to produce *ex-centric eggs!*

Tidy spirit by excellence, the author does not hesitate to organize even the CHAOS, in 25 images which, hypersuggestively, cannot find place in terms of comparisons.

The boundless fantasy is evident in the representation – *supermathematically stylized* – of the famous Brancusi “Column”. After it is "decomposed" into *elements* (suggestively entitled: Column elements of eternal love, Column elements of eternal embrace, Column elements of endless gratitude, so on), it follows, as it is natural, the "assembled" version, such that the *Endless Column* has moments of geometrical explosion and restriction, as suggestion, intuition, i.e. programming, de-programming, plus-programming – everything smartly dressed graphically and chromatically.

The inventory of ALBUM’s "exhibits" is far from complete; there is much to highlight, but due to space constraints, I confine only to mention the 24 instances of representation of the organ called MOUTH, engaged / involved in an *Esperanto gesture* of subtle refinement.

At the end of my considerations, it is worth noting that the ALBUM cannot be told, but it must be seen, browsed, insisted on each graphic, each page, studied together, with repeated comebacks. The endeavor will surely be rewarded.

A final adagio: as huge statues need distance (literally) to be seen in all their sublime shape, likewise the assessment of this ALBUM needs "distance" (now figuratively) from any... pride, envy, malice!

**Prof. Eng. Ioan GHIOCEL**

---

*The book of Nature is written in mathematical characters.*

Galileo Galilei

*Creation – the only smile of our tragedy.*

Lucian Blaga

---

# INTRODUCTION TO SUPERMATHEMATICS FUNCTIONS

The Functions, which are the base to generate, the most often, technical objects, so less artistical, neogeometrical, included in this album, are named **Supermathematics functions (SMF)**.

The name belongs to the regretted mathematician Prof. em. dr. doc.ing. **Gheorghe Silas** which, at the presentation of the very first work in this domain, at the First National Conference in Vibrations in Machine Constructions, Timisoara, Romania, 1978, named « CIRCULAR EX-CENTRIC FUNCTIONS », declared : « Young man, you just discovered not only « some functions », but a new mathematics, a **supermathematics** !» I was glad, at my 40 years old, like a teenager. And I proudly found that he might be right !

**The prefix super** is justified today, to point out the birth of new complements in mathematics, joined together under the name of **Ex-centric Mathematics (EM)** with much more important entities and infinitely more numerous than the existing entities in the **actual mathematics** , which we are obliged to name it **Centric Mathematics (CM.)**

To each entity from CM is corresponding an infinity of similar entities in EM, so Supermathematics (SM) is the reunion of the two domains, it means **SM = MC  $\cap$  ME and MC** is a particular case, of null ex-centricity of **ME**. Namely, **MC = SM( e = 0 )**. To each known function in **MC** is corresponding an infinity family of functions in **ME** , and in addition, a series of new functions appears, with a wide range of applications in mathematics and technology.

In this way, to **x = cos  $\alpha$**  is corresponding the functions family **x = cex  $\theta$  = cex (  $\theta$ , s,  $\epsilon$  )** where **s = e / R** and  **$\epsilon$**  are the polar coordinates of the **ex-center S(s,  $\epsilon$ )**, corresponding to the unity/trigonometrical circle or **E(e,  $\epsilon$ )** corresponding to certain circle of R radius, considered as **pole** of a straight line **d** which is rotating around **E or S** with position angle  **$\theta$** , generating in this way the ex-centric trigonometric functions, or ex-centric circular supermathematical functions (**EC-SMF**), by the cross of **d** with unity circle (v.Fig.1). Among them the **ex-centric cosine** of  **$\theta$** , noted **cex  $\theta$  = x**, where **x** is the projection of **W** point, the cross of the straight line with the trigonometric circle **C(1,0)**, or the cartesian coordinate of **W** point. Because a straight line, taken by **S**, interior to the circle (**s  $\leq$  1  $\rightarrow$  e < R**), is crossing the circle in two points, **W<sub>1</sub>** si **W<sub>2</sub>**, briefly named **W<sub>1,2</sub>**,





In this last case, we have a **EC-SMF** by variable point S/E ex-center, it means  $\mathbf{s} = \mathbf{s}(\theta)$  and/or  $\boldsymbol{\varepsilon} = \boldsymbol{\varepsilon}(\theta)$ . If the variable position of S/E is represented still by **EC-SMF** of same ex-center  $\mathbf{S}(\mathbf{s}, \boldsymbol{\varepsilon})$  or by another ex-center  $\mathbf{S}_1[s_1 = s_1(\theta), \varepsilon_1 = \varepsilon_1(\theta)]$ , then double ex-centricity functions are obtained. Trough extrapolation, triple and multiple ex-centricity functions are obtained. Therefore, **SMF-CE** are functions of so many variables as we wish or we need.

If the distances from  $\mathbf{O}$  to  $\mathbf{W}_{1,2}$  points from  $\mathbf{C}(\mathbf{1}, \mathbf{O})$  circle are constants and equals with the radius  $\mathbf{R} = 1$  of the trigonometric circle  $\mathbf{C}$ , distances we will name **ex-centric radiuses** pe care le vom denumi **raze centrice**, the distances from  $\mathbf{S}$  to  $\mathbf{W}_{1,2}$  noted by  $\mathbf{r}_{1,2}$  are variables and are named **ex-centric radiuses** of the unity circle  $\mathbf{C}(1, \mathbf{O})$  and represent, at the same time, new ex-centric circular supermathematics functions (**EC-SMF**), which were named **ex-centric radial functions** and are noted with  $\mathbf{rex}_{1,2}\theta$ , if is expressed as function of the **variable** named **ex-centric  $\theta$**  and motor, which is the angle from the ex-center  $\mathbf{E}$ . Or, noted  $\mathbf{Rex}_{1,2}\alpha$ , if it is expressed as function of the angle  $\alpha$  or **centric variable**, the angle of  $\mathbf{O}(\mathbf{0}, \mathbf{0})$ . The points  $\mathbf{W}_{1,2}$  are seen under the angles  $\alpha_{1,2}$  from  $\mathbf{O}(\mathbf{0}, \mathbf{0})$  and under the angles  $\theta$  and  $\theta + \pi$  from  $\mathbf{S}(\mathbf{e}, \boldsymbol{\varepsilon})$  and  $\mathbf{E}$ . The straight line  $\mathbf{d}$  is divided by  $\mathbf{S} \subset \mathbf{d}$  in two semi-straight lines, one positive  $\mathbf{d}^+$  and the other negative  $\mathbf{d}^-$ . Therefore, we can consider  $\mathbf{r}_1 = \mathbf{rex}_1\theta$  a positively oriented segment on  $\mathbf{d}$  ( $\rightarrow \mathbf{r}_1 > 0$ ) and  $\mathbf{r}_2 = \mathbf{rex}_2\theta$  a negatively oriented segment on  $\mathbf{d}$  ( $\rightarrow \mathbf{r}_2 < 0$ ) and in the sense of the negative semi-straight line  $\mathbf{d}^-$ .

Trough simple trigonometric relations, in certain triangles  $\mathbf{OEW}_{1,2}$ , or, more precisely, writing sine theoreme ( as function of  $\theta$ ) and Pitagora's generalized theoreme (for  $\alpha_{1,2}$  variables) in these triangles, immediately we find the **invariant expressions** of the ex-centric radial functions :

$$\mathbf{r}_{1,2}(\theta) = \mathbf{rex}_{1,2}\theta = -s.\cos(\theta - \varepsilon) \pm \sqrt{1 - s^2 \sin^2(\theta - \varepsilon)} \quad \text{and}$$

$$\mathbf{r}_{1,2}(\alpha_{1,2}) = \mathbf{Rex}\alpha_{1,2} = \pm \sqrt{1 + s^2 - 2.s.\cos(\theta - \varepsilon)} .$$

All **EC-SMF** has **invariant** expressions, and because this they don't need to be tabulated ; tabulated being the centric functions, from **MC**, which help to express them. In all their expressions, we will find constantly, one of the square roots of previous expressions, of ex-centric radial functions.

Finding these two determinations is simple : for **+** (**plus**) in the front of square roots we always obtain the first determination ( $\mathbf{r}_1 > 0$ ) and for the **-** (**minus**) sign we obtain the second determination ( $\mathbf{r}_2 < 0$ ). The rule is still available for all **EC-SMF**. By convention, the first determination, of index **1**, we can be use/write without index number.

About these **REX (« King »)** functions, we have to make some observations :

The ex-centric radial functions are the expression, in the plane, in polar coordinates, of the distance between two points : **S(s, ε)** and **W<sub>1,2</sub> (R = 1, α<sub>1,2</sub>)**, on direction of straight line **d**, inclined by **θ** angle reported to **Ox** axis;

Therefore, with their help and only ( exclusively) their, it can be expressed the equations of **All known plane curves**, as of other new ones, which appeared together with the birth of **ME**. An example is represented by **Booth's lemniscates** (see Fig. 2, a, b, c), expressed, in polar coordinates, by the equation :

$$\rho(\theta) = \mathbf{R} (\mathbf{rex}_1 \theta + \mathbf{rex}_2 \theta) = -2 s.R \cos(\theta - \varepsilon) \text{ for } \mathbf{R} = 1, \varepsilon = 0 \text{ and } \mathbf{s} \in [0, 3]$$

Another consequence is the generalization of circle's definition : "The Circle is the plane curve which's M points we find at the distances  $\mathbf{r}(\theta) = \mathbf{R}.\mathbf{rex} \theta = \mathbf{R}.\mathbf{rex} [\theta, \mathbf{E}(\mathbf{e}, \varepsilon)]$  regarding to a **certain** point from the circle's plane **E(e, ε)** ".

If **S ≡ O(0,0)** , then **s = 0** and **rexθ = 1 = constant** and **r(θ) = R = constant**, the **classical definition** of the circle is obtained : points placed at the same **R** distance from de center of the circle.

The **rex θ** and **Rex α** functions asserts the transfer functions of zero degree, or of position transfer, from the Mechanism theory, an it is the ratio between **R(α<sub>1,2</sub>)** parameter which position the conducted element **OM<sub>1,2</sub>** and **R.r<sub>1,2</sub> (θ)** parameter which position the leader element **EM<sub>1,2</sub>**. Between these two parameters, the following relations exists, which can simply deduced from fig 1, the defining of **EC-SMF** figure.

Between the position angles of the two elements, leader and leaded, the following relations exists :

$$\alpha_{1,2} = \theta \Upsilon \arcsin[e.\sin(\theta - \varepsilon)] = \theta \Upsilon \beta_{1,2}(\theta) = \mathbf{aex}_{1,2} \theta \quad \text{and}$$

$$\theta = \alpha_{1,2} \pm \beta_{1,2}(\alpha_{1,2}) = \alpha_{1,2} \pm \arcsin \left[ \pm \frac{s.\sin(\alpha_{1,2} - \varepsilon)}{\sqrt{1 + s^2 - 2.s.\cos(\alpha_{1,2} - \varepsilon)}} \right] = \mathbf{Aex} (\alpha_{1,2}).$$

The functions **aex<sub>1,2</sub> θ** and **Aex α<sub>1,2</sub>** are the **EC-SMF** named **ex-centric amplitude because** they can be used for defining **EC-SMF** cosine si sine ex-centrics, as amplitude function or amplitudinus am,(k,u) is used for defining of elliptical Jacobi functions : sn (k,u) = sin [am(k,u)], cn(k,u) = cos[am(k,u)], or :

$$\mathbf{cex}_{1,2} \theta = \cos(\mathbf{aex}_{1,2} \theta), \quad \mathbf{Cex} \alpha_{1,2} = \cos(\mathbf{Aex} \alpha_{1,2}) \quad \text{and}$$

$$\mathbf{sex}_{1,2} \theta = \sin (\mathbf{aex}_{1,2} \theta), \quad \mathbf{Sex} \alpha_{1,2} = \cos (\mathbf{Aex} \alpha_{1,2})$$

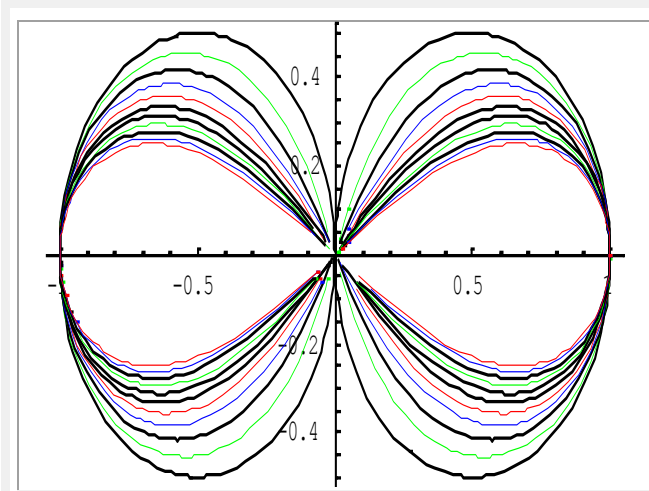

**Fig.2,a Booth's Lemniscates for R = 1 and numerical ex-centricity  $e \in [1.1, 2]$**

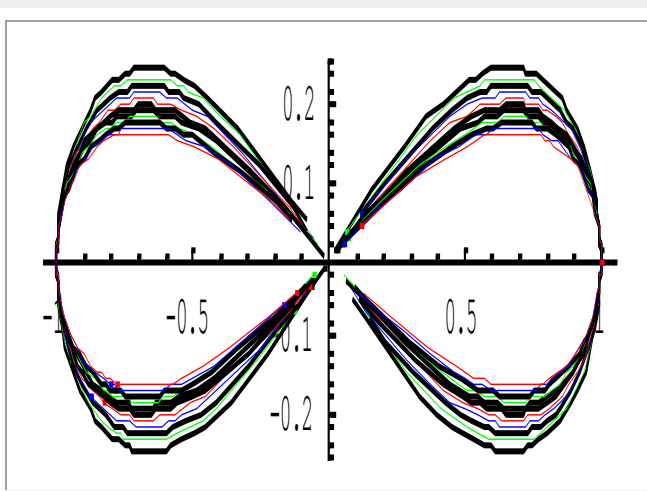

**Fig. 2,b Booth's Lemniscates for R = 1 and numerical ex-centricity  $e \in [2.1, 3]$**

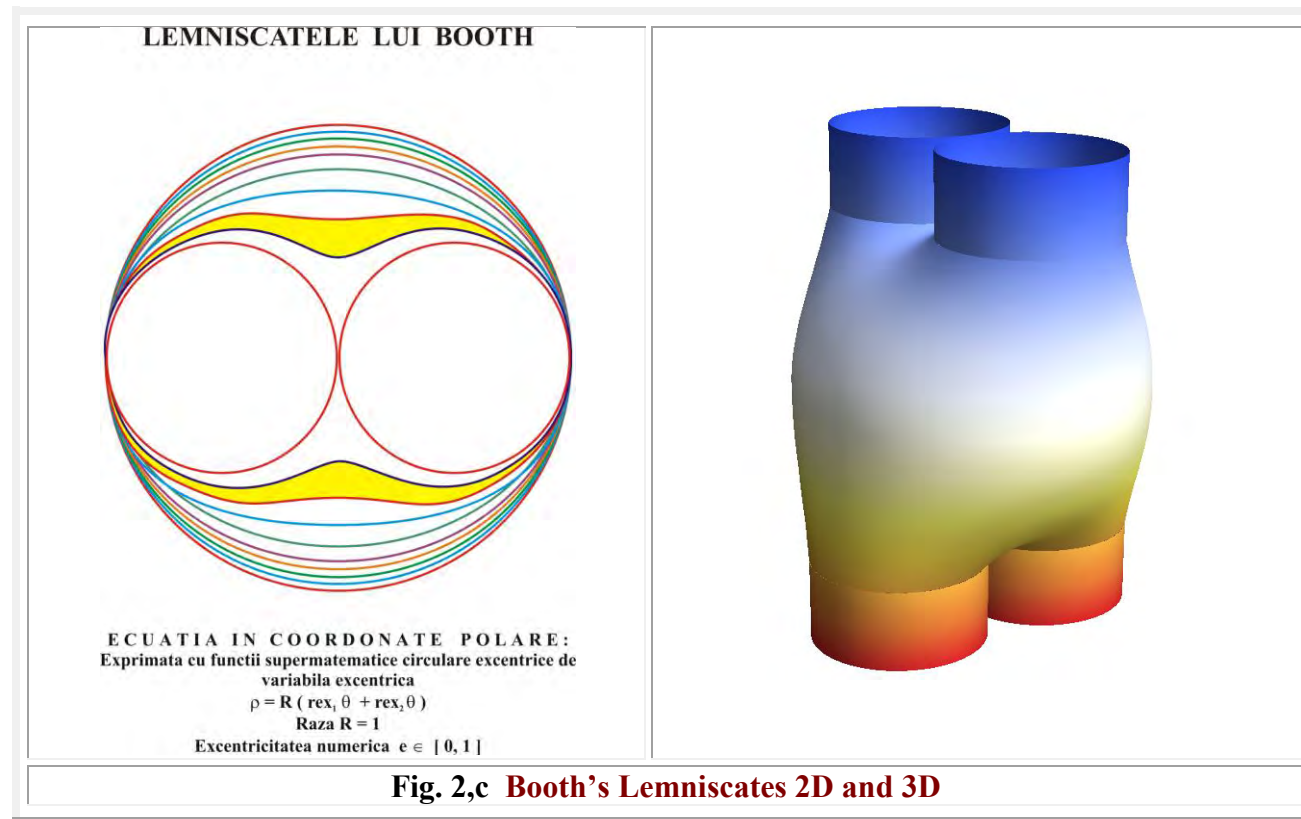

The radial ex-centric functions can be considered as modules of the position vectors  $\vec{r}_{1,2}$  of the points  $\mathbf{W}_{1,2}$  from the unit circle  $\mathbf{C}(\mathbf{1}, \mathbf{O})$ , vectors expressed through the following relations :

$$\vec{r}_{1,2} = \text{rex}_{1,2} \theta \cdot \text{rad} \theta,$$

where  $\text{rad} \theta$  is the unit vector of variable direction or the versor/ **fazor** of  $\mathbf{d}^+$  straight line direction, which derivative is the fazor  $\text{der} \theta = \mathbf{d}(\text{rad} \theta)/\mathbf{d}\theta$  and is representing normal vectors on the straight lines  $\mathbf{OW}_{1,2}$ , directions, tangents to the circle in  $\mathbf{W}_{1,2}$  points. They are named the **centric derivative** fazors. Meanwhile, the modulus of  $\text{rad} \theta$  function is the corresponding in **MC** of the function  $\text{rex} \theta$  for  $s = 0 \rightarrow \theta = \alpha$  when  $\text{rex} \theta = 1$  and  $\text{der} \alpha_{1,2}$  are the tangent versors to the unit circle in  $\mathbf{W}_{1,2}$  points.

The derivative of the  $\vec{r}_{1,2}$  vectors are the speed vectors

$$\vec{v}_{1,2} = \frac{d\vec{r}_{1,2}}{d\theta} = \text{dex}_{1,2} \theta \cdot \text{dera}_{1,2}$$

of the  $\mathbf{W}_{1,2} \subset \mathbf{C}$  points in their rotating motion on the circle, with speeds of variable modulus  $\mathbf{v}_{1,2} = \text{dex}_{1,2} \theta$ , when the generating straight line  $\mathbf{d}$  is rotating around the ex-center  $\mathbf{S}$  with constant angular speed and equal with the unity, namely  $\Omega = 1$ . The speed vectors has the previously presented expressions, where  $\text{dera}_{1,2}$  are the fazors of centric radiuses  $\mathbf{R}_{1,2}$  of module 1 and of  $\alpha_{1,2}$  directions. The expressions of the functions **EC-SMF**  $\text{dex}_{1,2} \theta$ , **ex-centric derivative of  $\theta$** , are, meanwhile, also the  $\alpha_{1,2}(\theta)$  angles derivatives, as function of the motor or independent variable  $\theta$ , namely

$$\text{dex}_{1,2} \theta = \mathbf{d}\alpha_{1,2}(\theta)/\mathbf{d}\theta = 1 - \frac{s \cdot \cos(\theta - \varepsilon)}{\pm \sqrt{1 - s^2 \cdot \sin^2(\theta - \varepsilon)}} \text{ as function of } \theta \text{ and}$$

$$\text{Dex}\alpha_{1,2} = \mathbf{d}(\theta)/\mathbf{d}\alpha_{1,2} = \frac{1 - s \cdot \cos(\alpha_{1,2} - \varepsilon)}{1 + s^2 - 2 \cdot s \cdot \cos(\alpha_{1,2} - \varepsilon)} = \frac{1 - s \cdot \cos(\alpha_{1,2} - \varepsilon)}{\text{Re} x^2 \alpha_{1,2}}, \text{ as functions of } \alpha_{1,2}.$$

It was demonstrated that the **ex-centric derivative EC-SMF** functions shows the first order transfer functions, or angular speeds, from the Mechanisms Theory, for **all (!)** known plane mechanisms.

The radial ex-centric function  $\text{rex} \theta$  exactly express the movement of push-pull mechanism  $\mathbf{S} = \mathbf{R} \cdot \text{rex} \theta$ , which motor connecting rod has the  $\mathbf{r}$ , length, equal with the real ex-centricity  $\mathbf{e}$  and the length of the crank is equal with the radius of the circle  $\mathbf{R}$ , a such

well-known mechanism, because it is a component of all automobiles, except those with Wankel engine. The applications of radial ex-centric functions could continue, but we will insist on more general applications of **EC-SMF**.

Concrete, to the unique forms of circle, square, parabola, ellipse, hyperbola, different spirals, etc from **MC**, grouped now under the name of **centrics**, correspond an infinity of the same type of **ex-centrics**: circular, square (quadrilobe), parabolic, elliptic, hyperbolic, spiral **ex-centrics**, etc. Any **ex-centric**, for null ex-centricity ( $e = 0$ ), is degenerating into a **centric**, which represents, at same time, its **generating** curve. Therefore, the **MC** himself belongs to **ME** for the unique case ( $s = e = 0$ ), from the infinity possible cases where it can be placed, in the plane, a point named **ex-center E(e, ε)**. In this case, **E** is superposing on one or two points named **center**: the **origine O(0,0)** of a frame of a referential system, and/or the **center C(0,0)** of the unit circle, for circular functions, or, respectively, the symmetry center of the two arms of the equilateral hyperbola, for hyperbolic functions.

It was enough that a point **E** be expelled from the center (**O** and/or **C**) and from the **MC** world appears a new world of **ME**, and the reunion of these two worlds give birth to the **SM** world. And this occurred in the town of the Romanian Revolution from 1989, **Timisoara**, the same town where at November 3-th, 1823 **Janos Bolyai** wrote: « From **nothing** I've created a new world ». With these words, he announced the discovery of the fundamental formula of the first **non-euclidean geometry**. He – from nothing, me – from the collective effort to multiply the periodical functions, functions which are necessities to an engineer to describe some periodical phenomena. In this way, I have completed the mathematics with new objects. If **Euler**, when defined the trigonometric functions, as direct circular functions, wouldn't be chosen **three superposed points**: the origine **O**, the center of the circle **C** and **S** as a pole of a semistraight line, which intersects the trigonometric/unit circle, the **FSM-CE** could be known much earlier, maybe under other name. Depending on the way to « **split** » (we separate one point by one of the superposed ones, or all of them), the following types of **SMF** appears:

$O \equiv C \equiv S \rightarrow$  **Centric functions belonging to MC** ;

and those which belong to **ME** are :

$O \equiv C \neq S \rightarrow$  **Ex-centric Circular Supermathematics Functions (EC-SMF)**;

$O \neq C \equiv S \rightarrow$  **Elevated Circular Supermathematics Functions (CEL-FSM)**;

$O \neq C \neq S \rightarrow$  **Exotic Circular Supermathematics Functions (CEX-FSM)**.



These **new mathematics complements**, joined together under the **temporary** name of **SM**, are tools or instruments of extreme utility, of a long ago waiting, the proof being the large number and the diversity of periodical functions introduced in mathematics, and the way sometimes complicated to reach them, trying to substitute the circle with other curves, most of them closed.

For obtaining some special and periodical new functions, it was tried the replacement of trigonometric circle with a **square** or a **diamond**. This was the proceeding of the former chief of Mathematics Department from Mechanics College from Timisoara, prof. Dr. Mat. **Valeriu Alaci**, discovering the **square** and **diamond** shape trigonometric functions. Hereafter, mathematics teachers **Eugen Visa** introduced the **pseudo-hyperbolic** functions, and **M.O. Enculescu** defined the **polygonal** functions, replacing the circle with a n-sided polygon; for  $n = 4$  he obtained the square **Alaci** trigonometric functions. Low, the romanian origin american mathematician, Prof. **Malvina Baica** from University of Wisconsin together with **Mircea Cărdu**, completed the gap between the circular **Euler** functions and **Alaci** square functions, with the so-called **Periodic Transtrigonometric Functions**.

The Russian mathematician **Marcusevici** describe, in his work “**Remarcable sine functions**” the **generalized trigonometric functions** and the **lemniscate**. Even since 1877, the German mathematician Dr. **Biehringer**, replacing right triangle with an oblique triangle, defined the **inclined** trigonometric functions. The British scientist Romanian origin ing. **George (Gogu) Constantinescu** replaced the **circle** with the **evolvent** and defined the **Romanian** trigonometric functions: **Romanian cosine** and **Romanian sine**, expressed by  $Cor\ \alpha$  and  $Sin\ \alpha$  functions, which helped him to resolve exactly some non-linear differential equations of the Sonicity Theory, created by himself. And how little known are all these functions even in Romania!

The elliptical functions are defined on an ellipse. A rotated one, with the main axis along Oy axis.

How simple can become, and, as a matter a fact, are the complicated things ! This **paradox(ism)** suggest that by the simple displacement/expulsion of a **point** from a **center** and trough the apparition of the **ex-center**, a new world may appear, the world of **ME** and, concurrently, a new Universe, the **SM** Universe.

Notions like « **Supermathematics Functions** » and « **Funcții circulare excentrice** » appeared on most search engines like Google, Yahoo, Altavista s.a, since the birth of Internet. The new notions, like **cuadrilobe** « cuadrilobas », which help to name the

**ex-centrics** which continuously fill the space between a **circle** and a **square**, circumscribed to the circle, were included in Mathematics Dictionary. The cross of the **quadriloba** with the straight line **d** generate the new functions called **cosine quadrilobe-ic** si **sine quadrilobe-ic**.

The benefits of **SM** in science and technology are too numerous to show them all here. But we are please to remind that **SM** wipe the boundaries between **linear** and **non-linear** ; The linear belongs to **MC**, and the non-linear is the appanage of **ME**, like between **ideal** and **real**, or between **perfection** and **imperfection**.

It says that **Topology** is the mathematics which doesn't make the difference between a pretzel and a tea cup. Well, **SM** doesn't make the difference between a **circle** ( $e = 0$ ) and a **perfect square** ( $s = \pm 1$ ), between a **circle** and a **perfect triangle**, between an **ellipse** and a **perfect oblong**, between a **sphere** and a **perfect cube**, s.a; with the same parametric equations it can be obtained besides the **ideal** forms of **MC** (circle, ellipse, sphere s.a) , as the **real** ones (square, oblong, cube, s.a.). For  $s \in [-1,1]$ , in the case of ex-centric variable  $\theta$ , as in the case of centric variable  $\alpha$ , for  $s \in [-\infty, +\infty]$ , it can be obtained in infinity of intermediate forms, like square, oblong or cube with rounded corners and slightly curved sides or, respectively, faces. What makes easier to use the new **SM** functions for drawing and representing some technical parts, with rounded or splayed edges, in the programmes **SM - CAD/CAM**, which doesn't use the computer any more as a drawing board, but make the technical object at once, trough parammetric equations, with remarcable consequences memory spare ; Only the equations are memorized, not the vaste number of pixels which define/bounds a technical piece.

The numerous presented functions, being for the first time introduced in mathematics, for an easier fixing in memory, the author considered as necessary a short presentation of their equations, so anyone wants to contribute to their application development, can do it.

**SM** is not a finished work, it's still an **introduction** in this vaste domain, a first step, a small author's step and a giant leap for mathematics.

The **elevated circular SM** functions (**CEL-SMF**), named so because trough modification of numarical ex-centricity  $s$  the points of the curves of elevated sine functions **sel $\theta$**  as of the elevated circular function elevated cosine **cel $\theta$**  is elevating – in other words it rise on the vertical, getting out from the space  $\{-1, +1\}$  of the other sine and cosine functions, central or ex-central. The plots of the functions **cex $\theta$**  and **sex  $\theta$**  are shown in fig. 3, where it can see that the points of these plots are modifying in horizontal direction, all of them remaining in the space  $[-1, +1]$ , named domain of existance of these functions.



The plots of  $\text{cel}\theta$  and  $\text{sel}\theta$  functions can be simply represented by the products :

$$\text{cel}_{1,2} \theta = \text{rex}_{1,2} \theta \cdot \cos \theta$$

and

$$\text{Cel} \alpha_{1,2} = \text{Rex} \alpha_{1,2} \cdot \cos \theta$$

$$\text{sel}_{1,2} \theta = \text{rex}_{1,2} \theta \cdot \sin \theta$$

and

$$\text{Sel} \alpha_{1,2} = \text{Rex} \alpha_{1,2} \cdot \sin \theta$$

and are shown fig. 4.

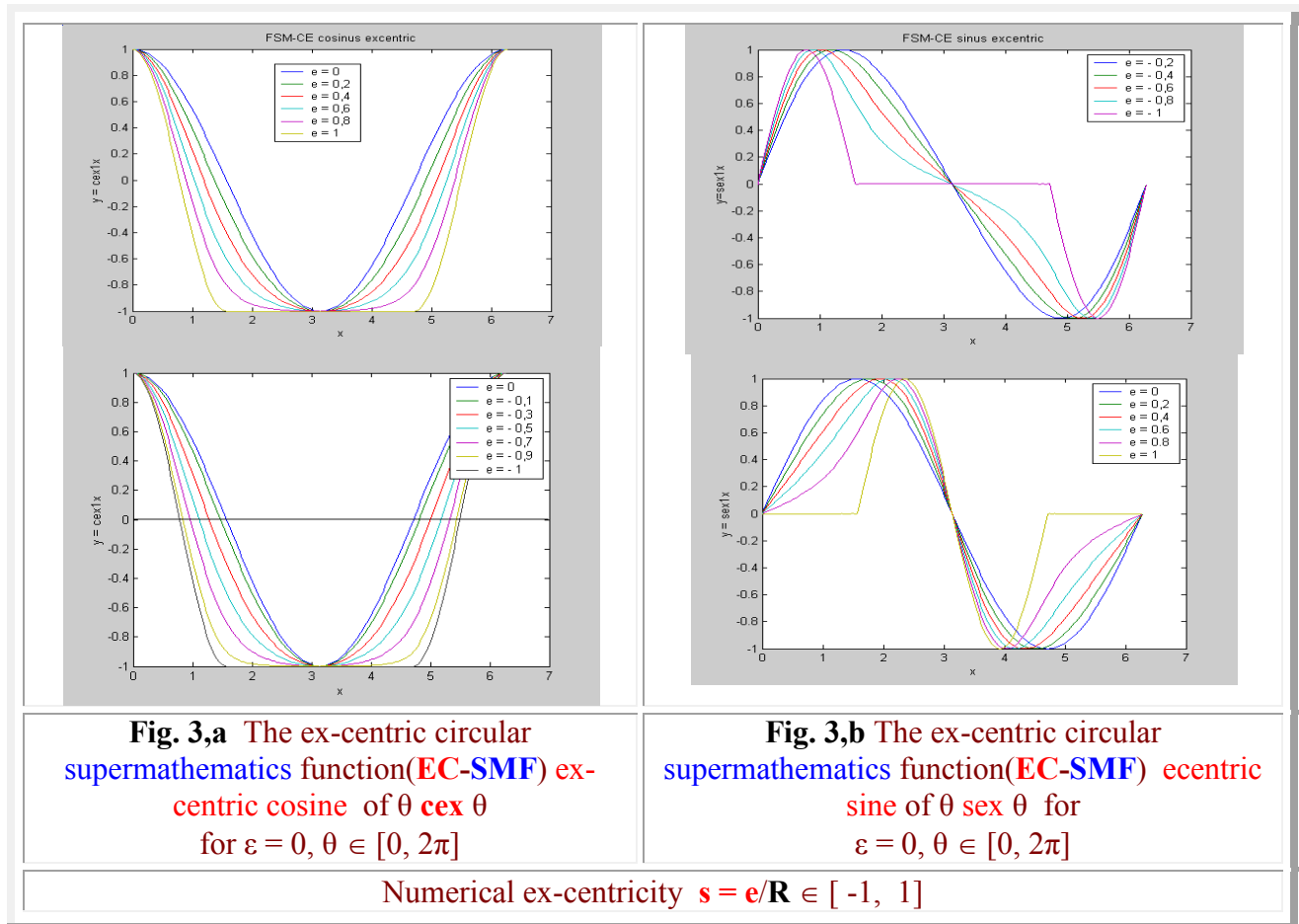

The most general **SM** are the **exotic circular functions** which are defined on an unit circle un-centered in the origin of axis system  $xOy$  neither in the ex-center **S**, but in a certain point **C** ( $c, y$ ) from the unit circle plane, with the polar coordinates ( $c, y$ ) in the coordinate system  $xOy$ . Many of the drawings from this album are made with **EC-SMF** of variable ex-center and with arcs which are  $n$  multiples of  $\theta(n.\theta)$ . The used relations, for each particular case, are explicitly shown, in most cases using the **centric** mathematical

functions, which trough, as we could see, can be expressed all **SM** functions, especially when the visualisation programs cannot use **SMF**. This doesn't means that, in the future, the new math complements will not be implemented in computers, for largely expand their useful domain.

Neither the specialists in making computer assisted design programs **CAD/CAM/CAE**, won't be late too much to make these new programs, fundamantaly differents, trough which the technical objects are made with parametric **circular** or **hyperbolic SMF**'s, in the way there are examplified some achievements such as airplanes, buildings, etc in <http://www.eng.upt.ro/~mselariu> and how a washer can be represented asaa toroid ex-centricity ( or an "ex-centric torus"), square or oblong in an axial section, and , respectively, a square plate with a central square hole can be a "square torus of square section". And all these, because **SM** doesn't make distinction between a circle and a square or between an ellipse and an oblong, as said before.

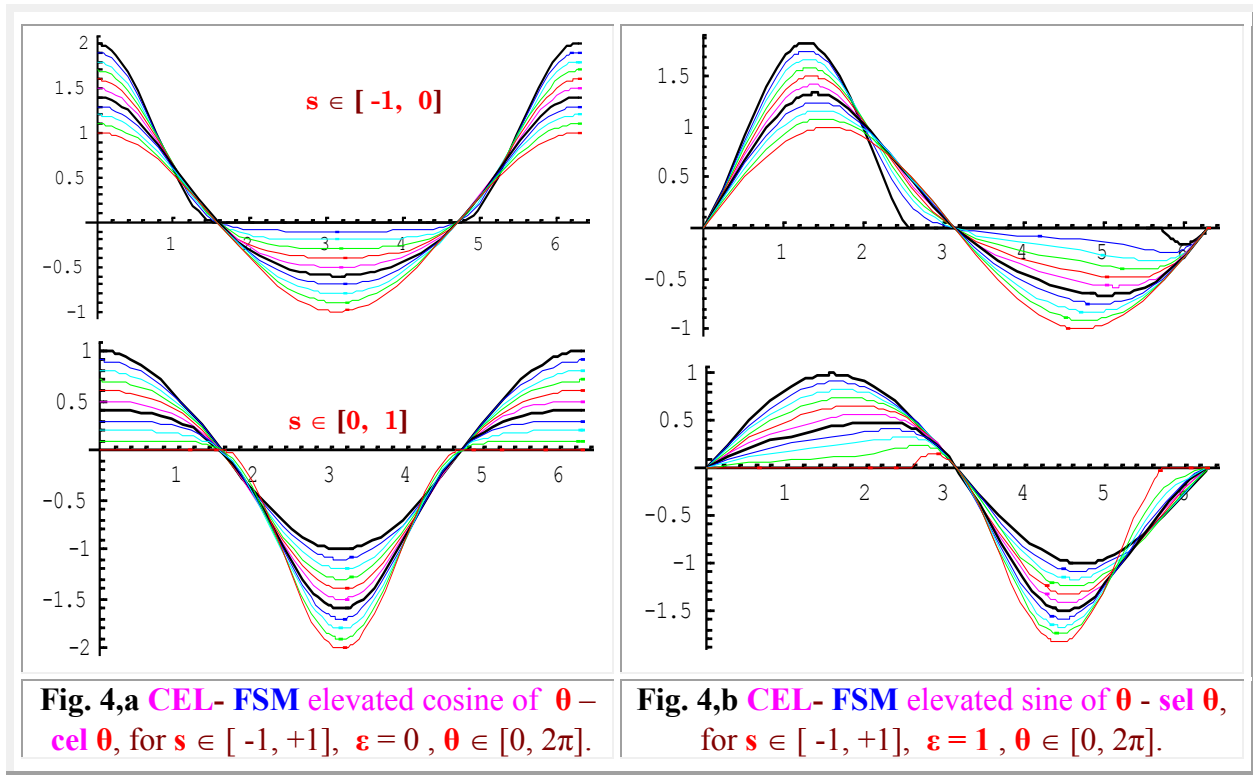

**Fig. 4,a** CEL- FSM elevated cosine of  $\theta$  – cel  $\theta$ , for  $s \in [-1, +1]$ ,  $\epsilon = 0$ ,  $\theta \in [0, 2\pi]$ .

**Fig. 4,b** CEL- FSM elevated sine of  $\theta$  - sel  $\theta$ , for  $s \in [-1, +1]$ ,  $\epsilon = 1$ ,  $\theta \in [0, 2\pi]$ .

But the most important achievements can be obtained in science trough solutioning some non-linear problems, because **SM** reunite in a single entity these two domains, such

different in the past. Among these, the non-linear domain ask ingenious approaches for each particular problem. Therefore, in the domain of vibrations, static elastical characteristics (SEC) soft non-linear (regressive) or hard non-linear (progressive) can be simply obtained writing  $y = m \cdot x$ , only  $m$  is not anymore  $m = \tan \alpha$  as in linear case ( $s = 0$ ), but  $m = \text{tex}_{1,2} \theta$  and depending on numerical ex-centricity  $s$  sign, postive or negative, or for  $S$  placed on negative x axis ( $\varepsilon = \pi$ ) or on positive x axis ( $\varepsilon = 0$ ), the two nonlinear elastical characteristics (NEC) is obtained, and obviously for  $s=0$  a linear will be obtained.

Because the functions  $\text{cex}\theta$  and  $\text{sex}\theta$ , as  $\text{Cex}\alpha$  and  $\text{Sex}\alpha$  and their combinations, are solutions of some differntial equations of second order with variable coefficients, it being stated that **even** for  $s = \pm 1$ , and not only for  $s = 0$ , linear systems (Cebasev) are obtained. At these, the mass ( $M$  point) is rotating on the circle with a double angular speed  $\omega = 2 \cdot \Omega$  (reported to the linear system of  $s = 0$  at  $\omega = \Omega = \text{constant}$ ) a half of a period, and in the other half of period stops in the point  $A(R,0)$  for  $e = sR = R$  or  $\varepsilon = 0$  and in the point  $A'(-R, 0)$  for  $e = -s \cdot R = -1$ , or  $\varepsilon = \pi$ . In this way, the oscilation period  $T$  of the **three linear systems** is the same and equal with  $T = \Omega / 2\pi$ . For the others values, intermediates, of  $s$  and  $e$  the nonlinear CES systems are obtained. The projection, on any direction, of the rotating motion of  $M$  point on  $R$  radius circle, equal with the oscillation amplitude, with variable angular speed  $\omega = \Omega \cdot \text{dex} \theta$  (after  $\text{dex} \theta$  function) is an **non-linear** oscillating motion.

The apparition of « **king** » function  $\text{rex}\theta$  and of his properties made easier the apparition of a **hybrid** method (analytico-numerical), through which o simple **relation** was obtained, with only two terms, to **calculate** the first kind complete elliptic integral  $K(k)$ , with an unbelievable precision, with minimum **15 accurate decimals**, after only 5 steps. Making the next steps, can lead to a new relation to calculate  $K(k)$ , with a considerable higher precision and with the possibility to expand the method to other elliptic integrals and not only to these. The relation of  $E(k)$  after 6 steps has the same precision to calculate.

The apparition of **FSM** facilitated the apparition of a new integration method, named **integration through the differential dividing**.

We will stop here, letting you the pleasure to delight yourselves looking the drawings of this album.

Mircea Eugen Selariu

# SUPERMATHEMATICS OBJECTS



## CONOPYRAMIDS

```
ParametricPlot3D[{s Cos[t]/Sqrt[1 - (sSin[t])^2], s Sin[t]/Sqrt[1 - (sCos[t])^2], s}, {t, 0, 2Pi}, {s, -1, 1}]
```

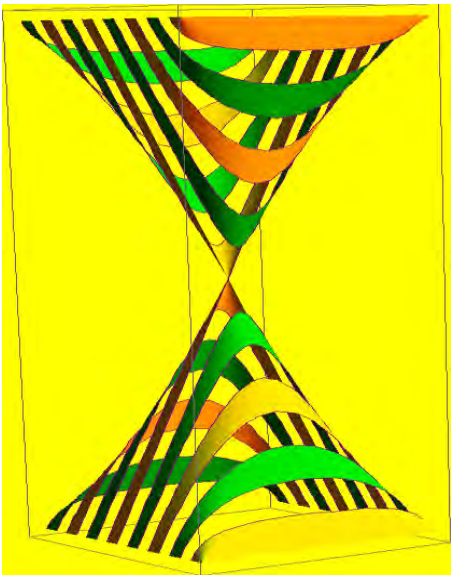
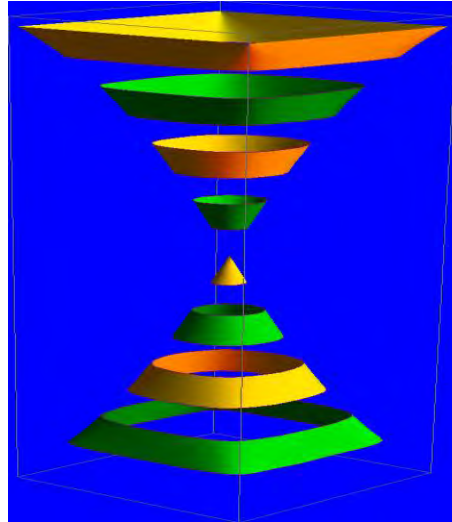
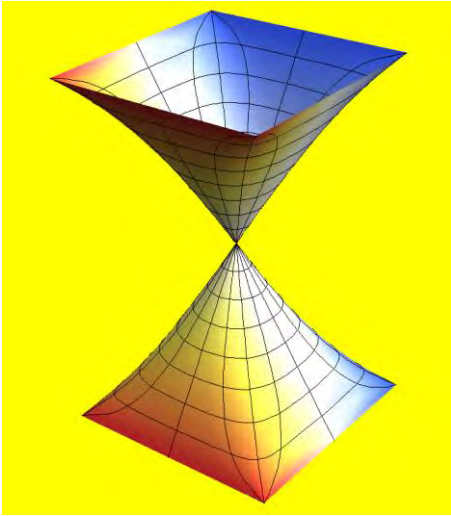

$$\begin{cases} x = s \cdot \cos \theta \\ y = s \cdot \sin \theta, \theta \in [0, 2\pi]; S(s \in [-1, 1]) \\ z = s \end{cases}$$

# CONOPYRAMIDS ASSEMBLY

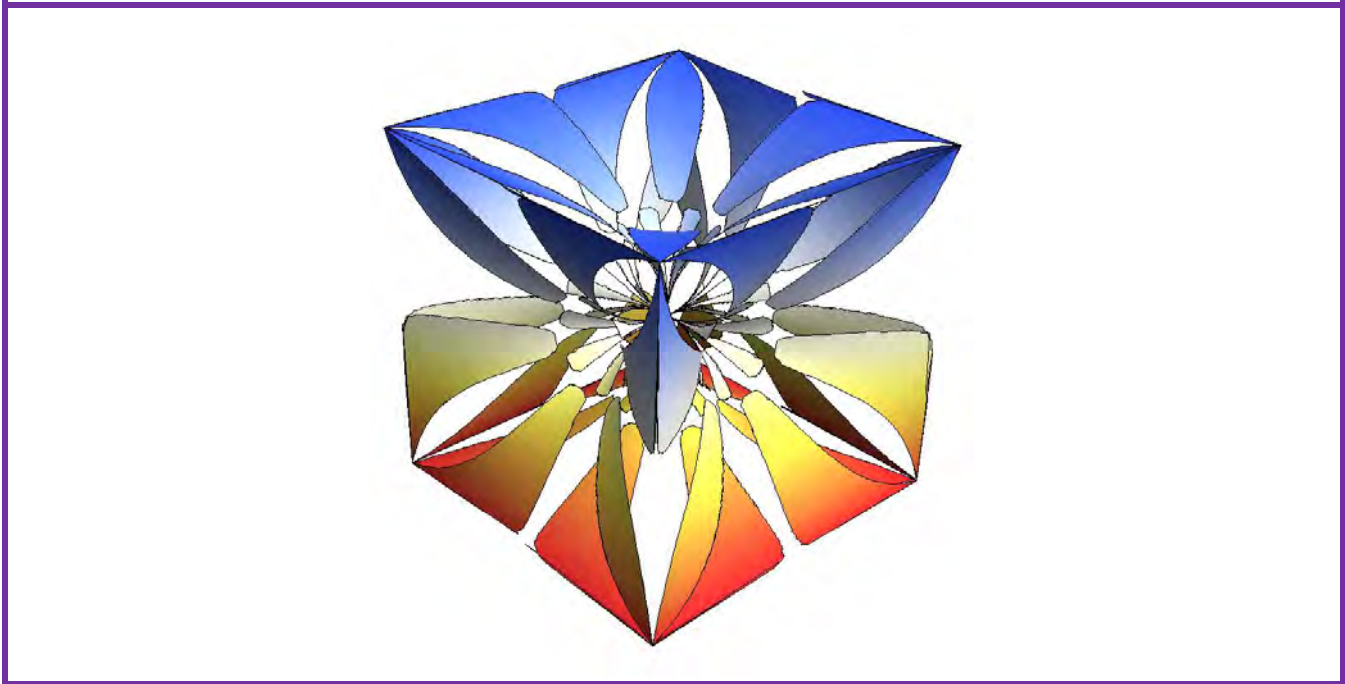
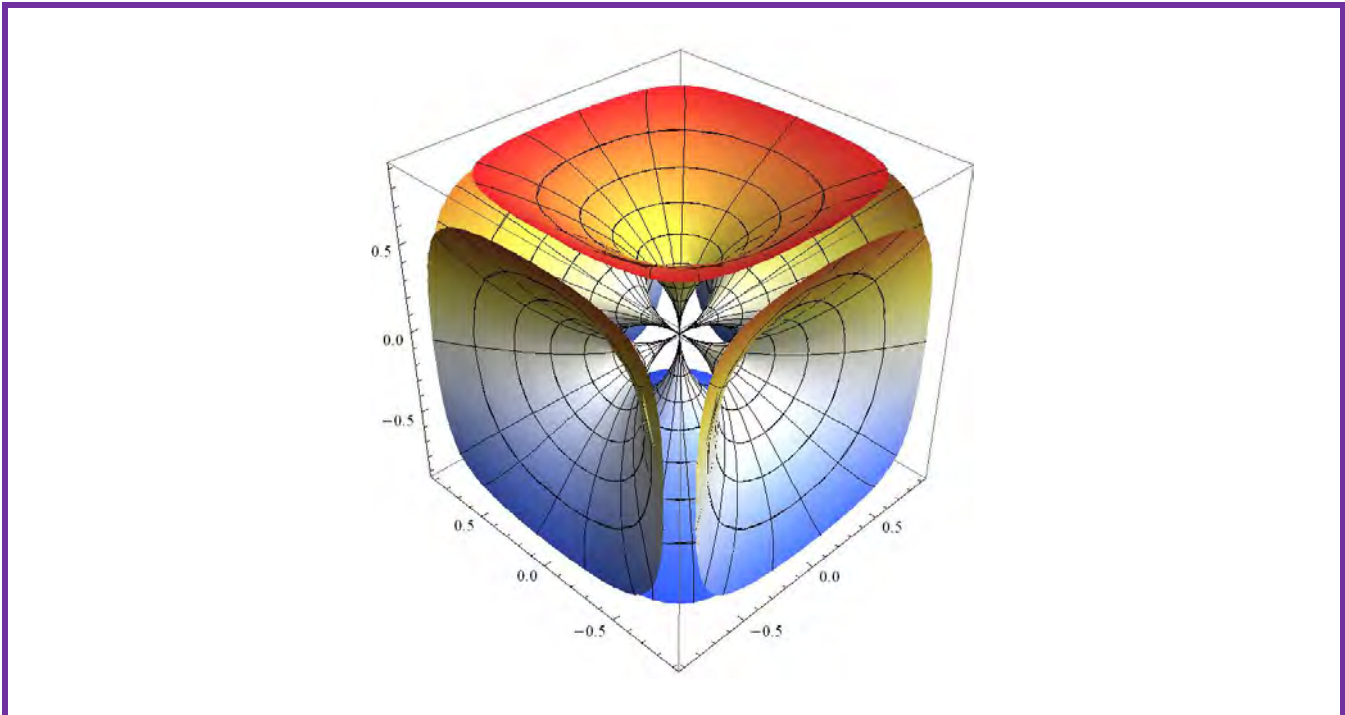



## DOUBLE CLEPSYDRA

```
ParametricPlot3D[{(1 - Cos[t - ArcSin[Sin[t]]])Cos[u],
(1 - Cos[t - ArcSin[Sin[t]]])Sin[u],
Sin[t - ArcSin[Sin[t]]]}, {t, 0, 3Pi}, {u, 0, 2Pi}
```

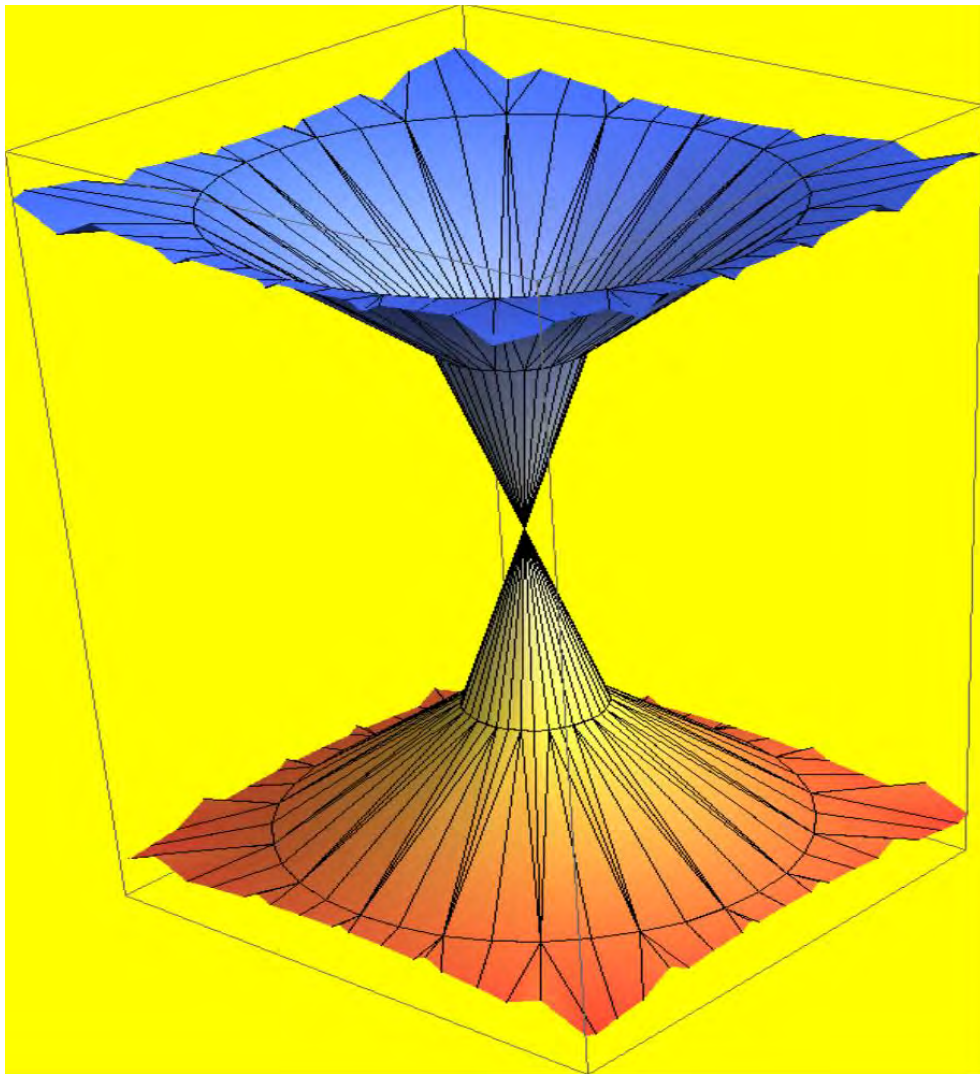

$$\begin{cases} x = (1 - \text{cex}\theta)\text{cos}u \\ y = (1 - \text{cex}\theta)\text{sin}u, \quad S(s = 1; \epsilon = 0), \theta \in [0, 3\pi]; u \in [0, 2\pi] \\ z = \text{sex}\theta \end{cases}$$

RIDDLED CONOPYRAMIDS IN THREE VIEWS

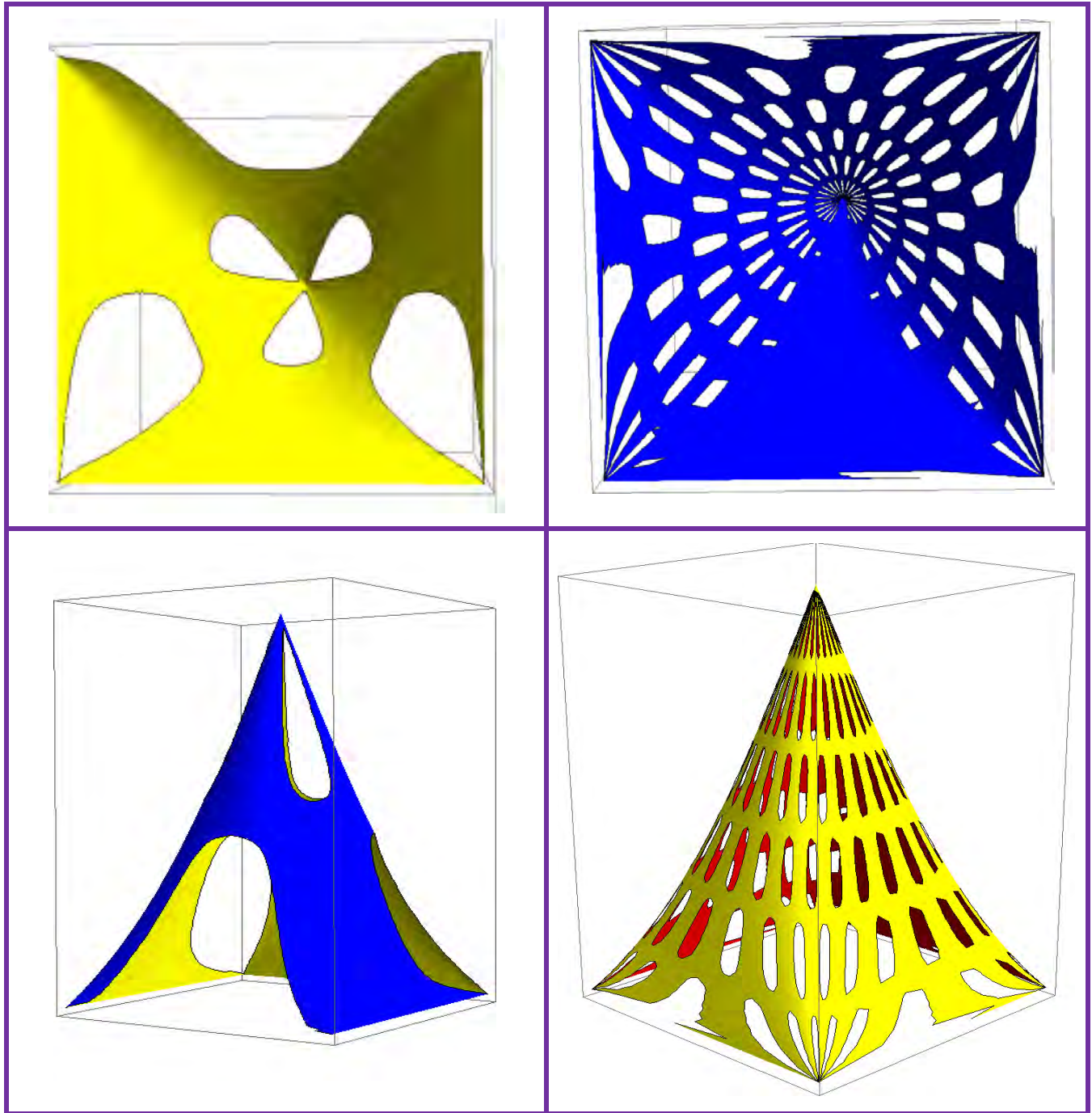



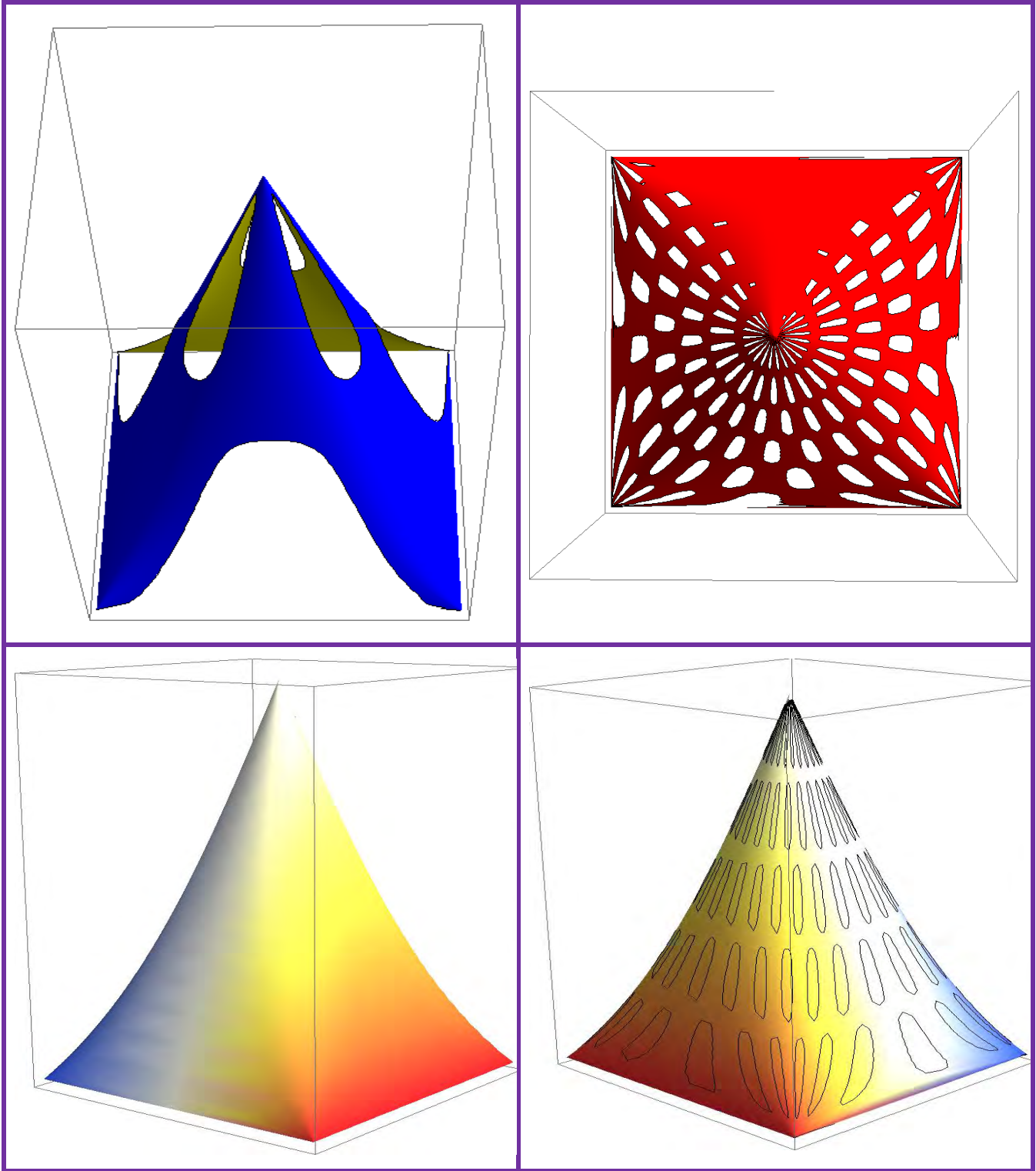

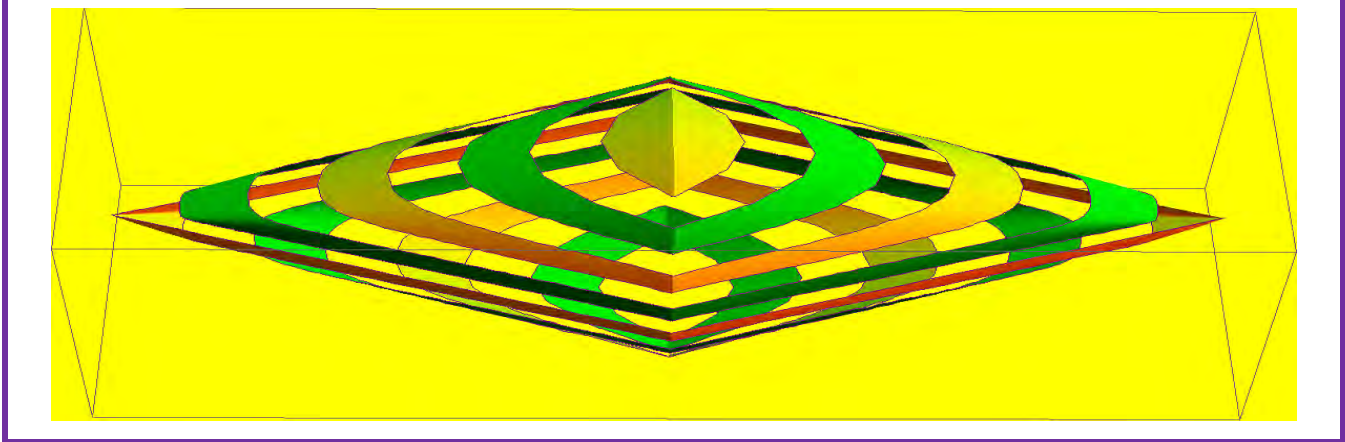
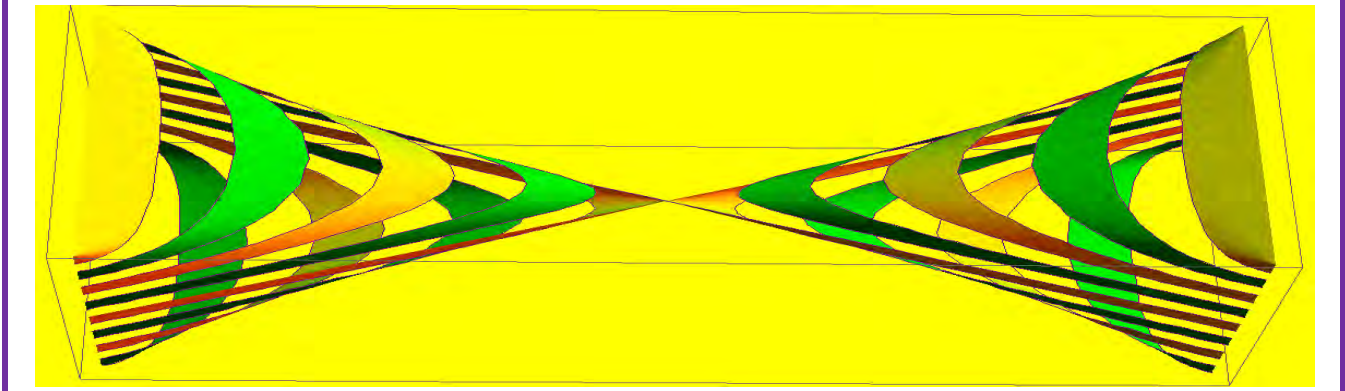
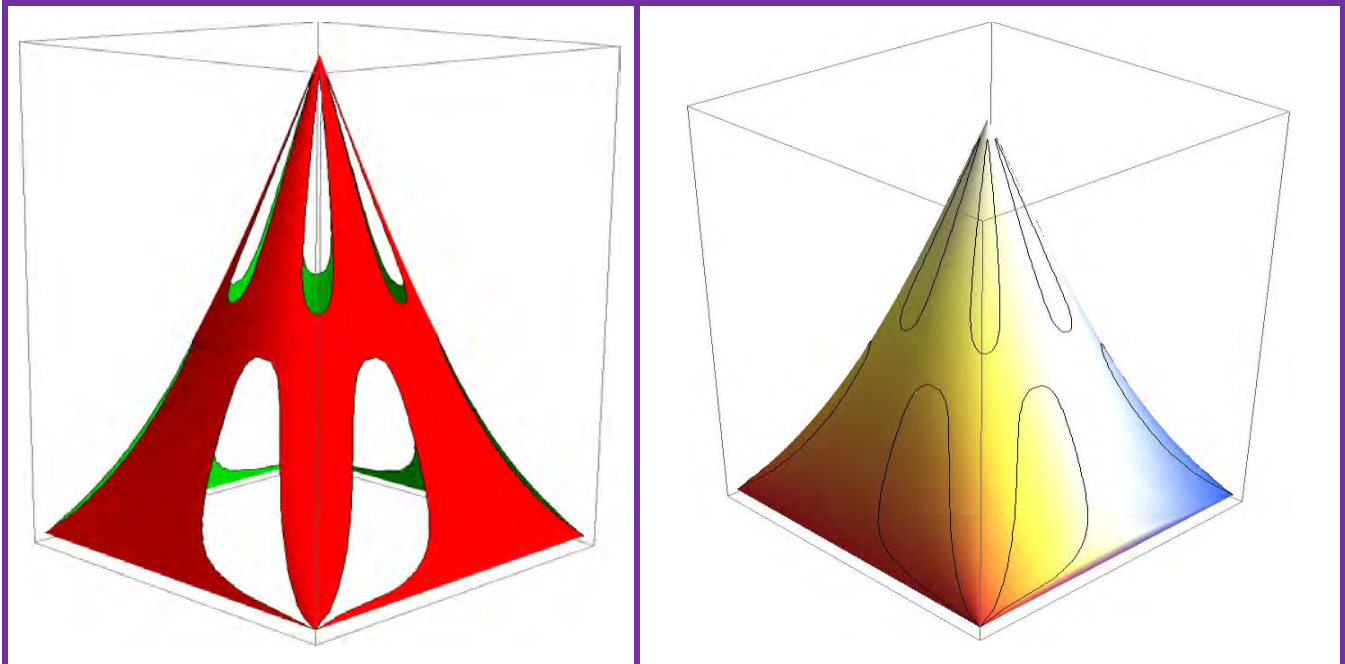

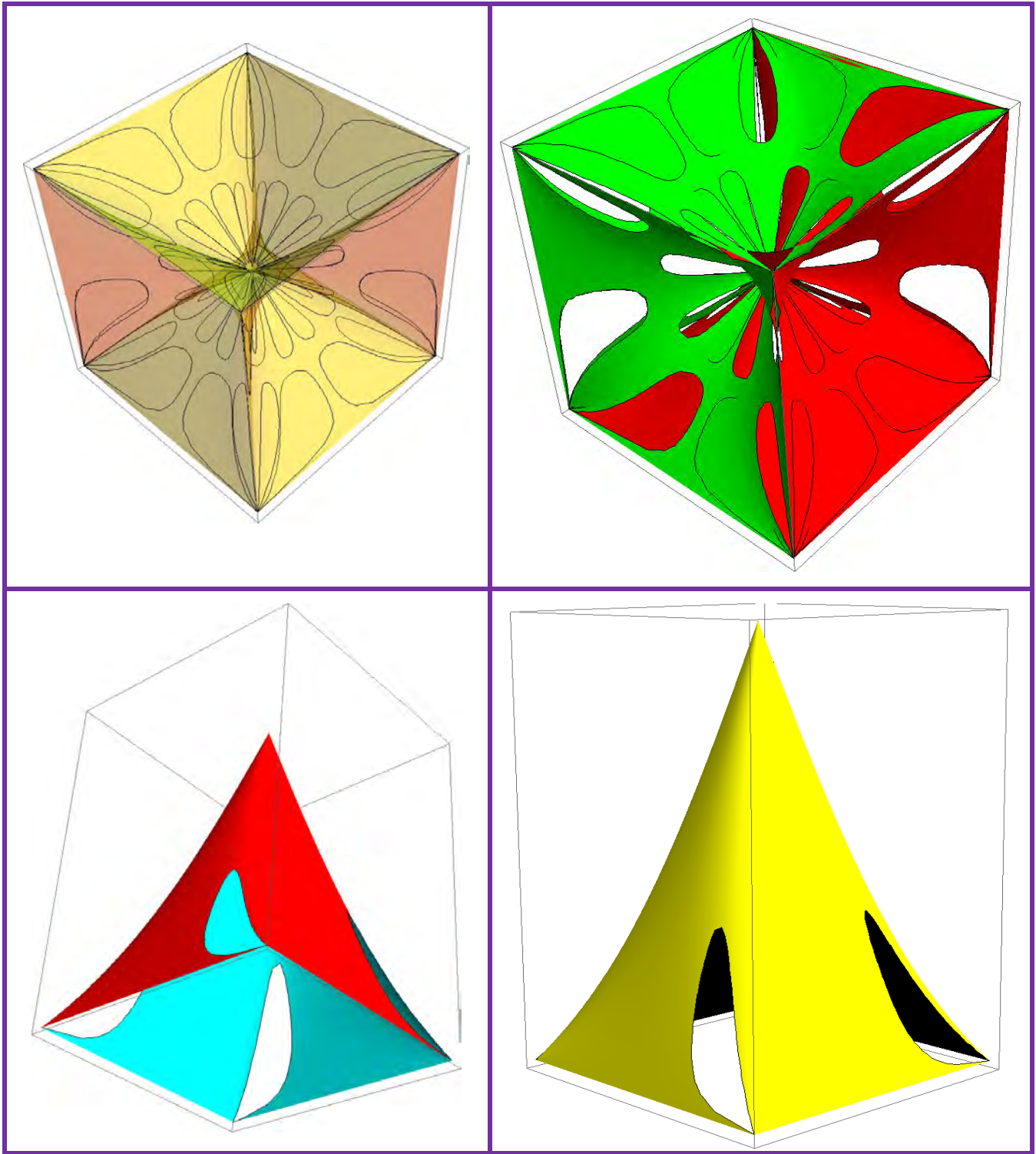

ANOTHER DOUBLE CLEPSYDRA

ParametricPlot3D[{{(1 - Cos[t - ArcSin[Sin[t]]])Cos[u], (1 - Cos[t - ArcSin[Sin[t]]])Sin[u],  
Sin[t - ArcSin[Sin[t]]]}, {t, 0, 3Pi}, {u, 0, 2Pi}

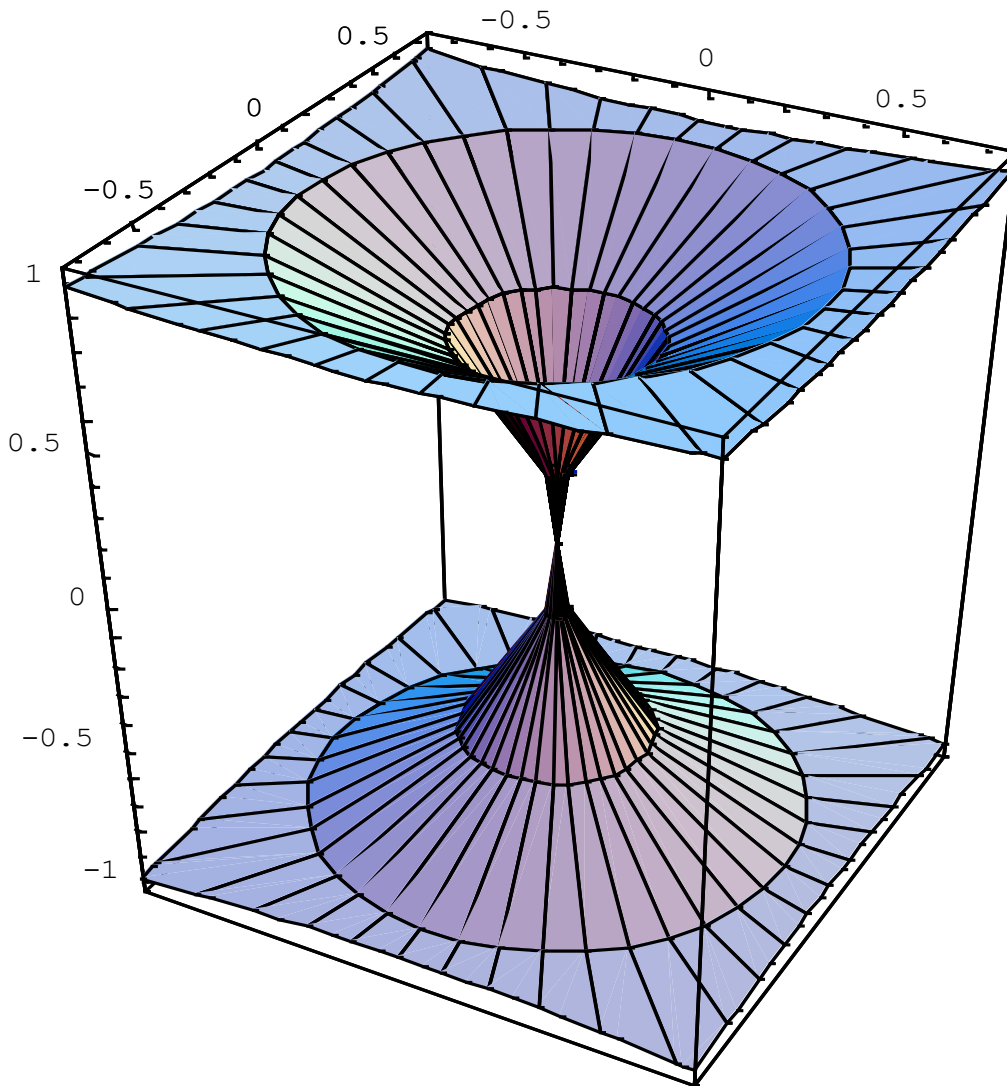

$$\begin{cases} x = (1 - \text{cex}\theta)\cos u \\ y = (1 - \text{cex}\theta)\sin u, \quad S(s = 1; \varepsilon = 0), \theta \in [0, 3\pi]; u \in [0, 2\pi] \\ z = \text{sex}\theta \end{cases}$$



## QUADRILOBIC CLEPSYDRAS

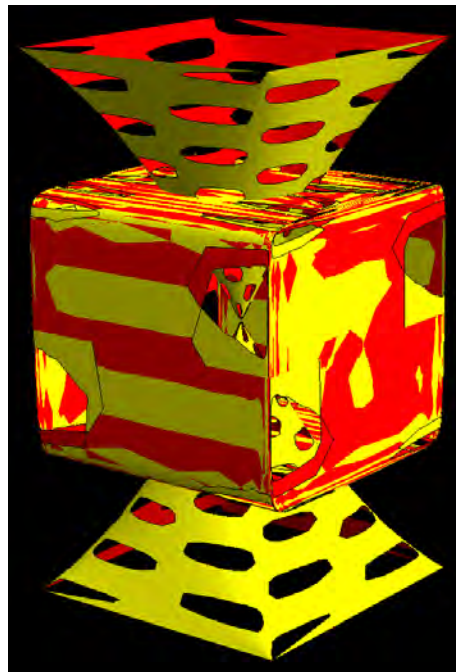
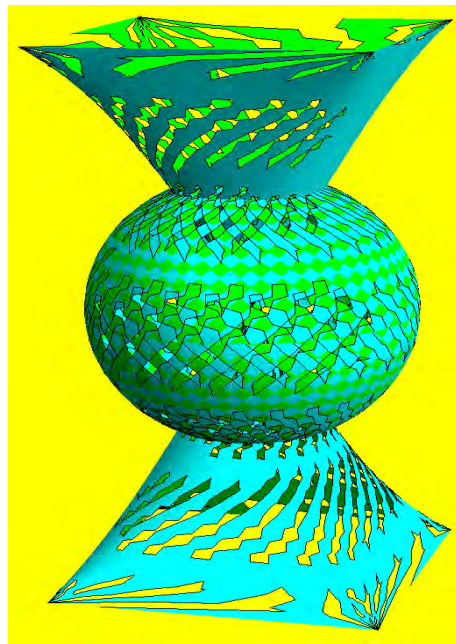
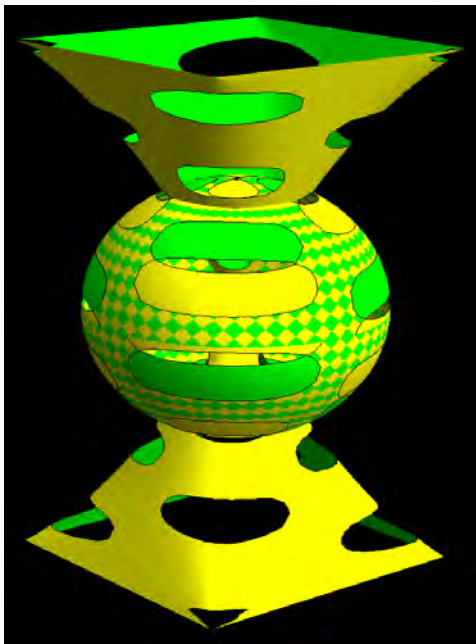

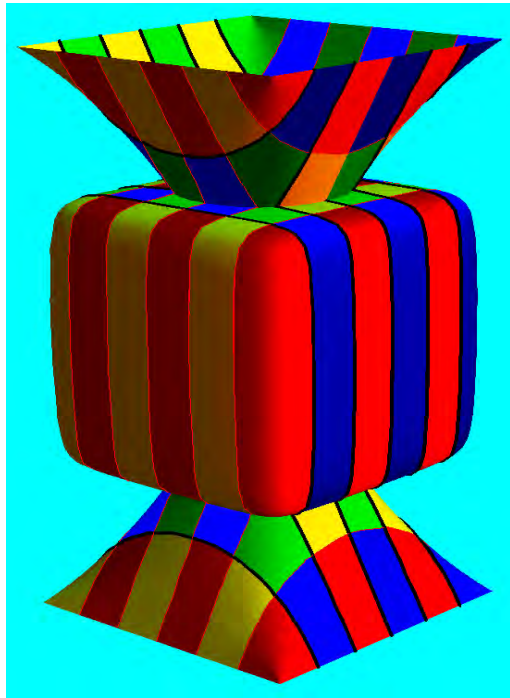
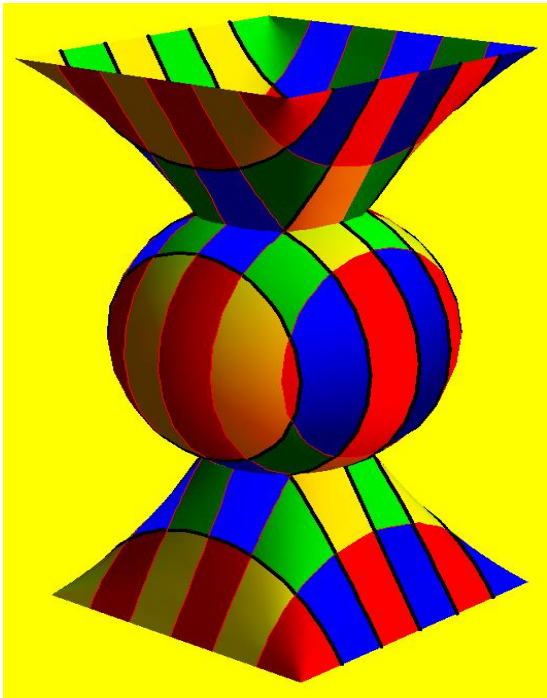
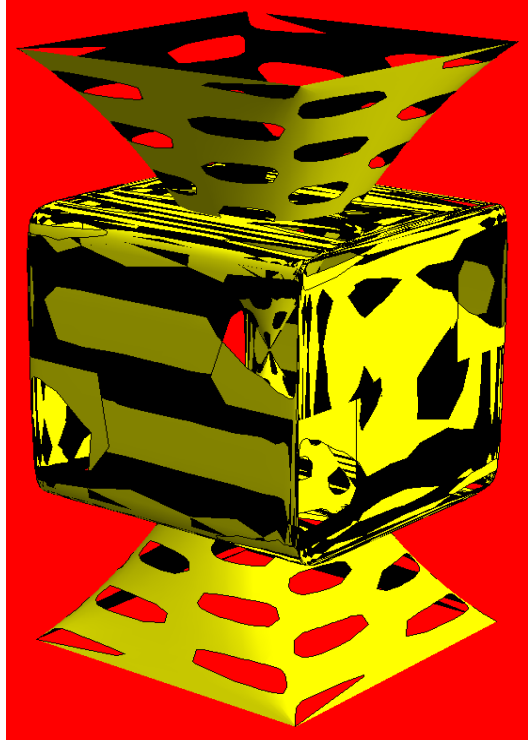
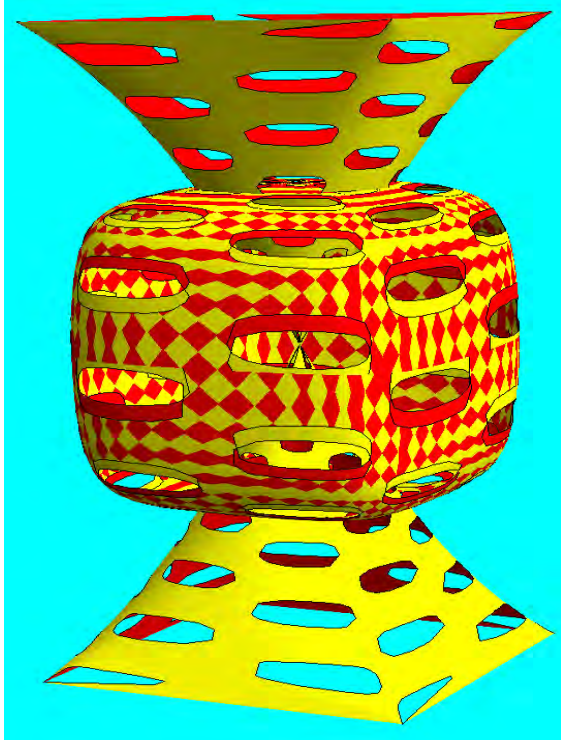

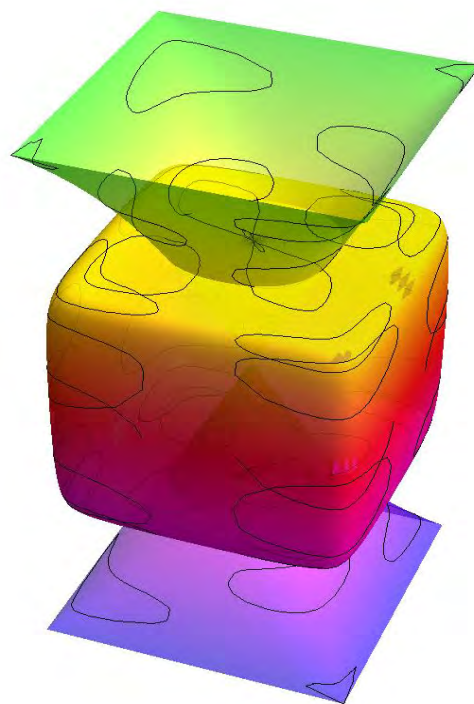
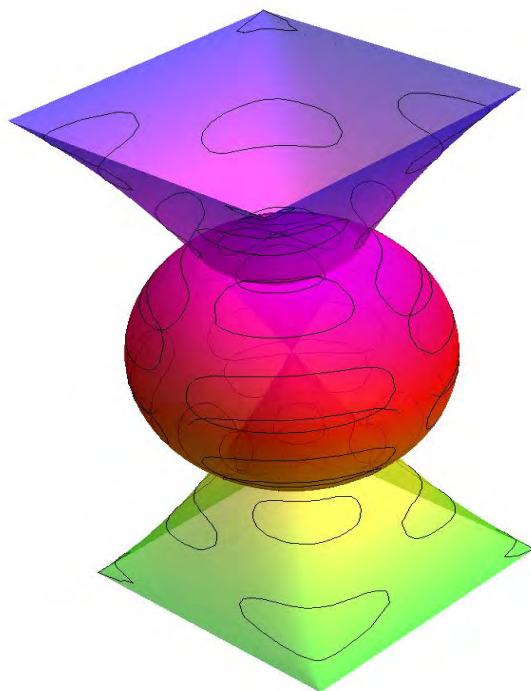
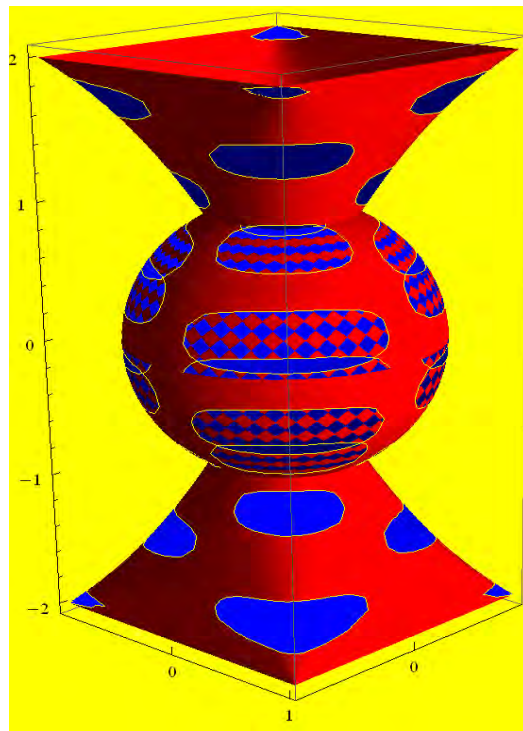
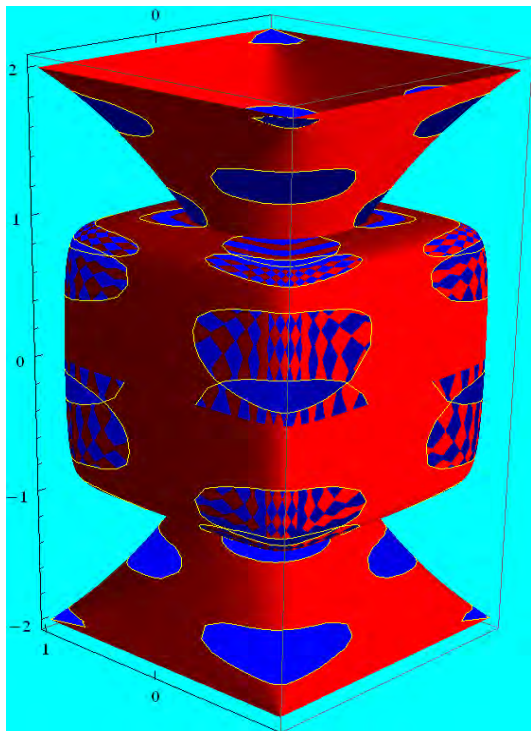



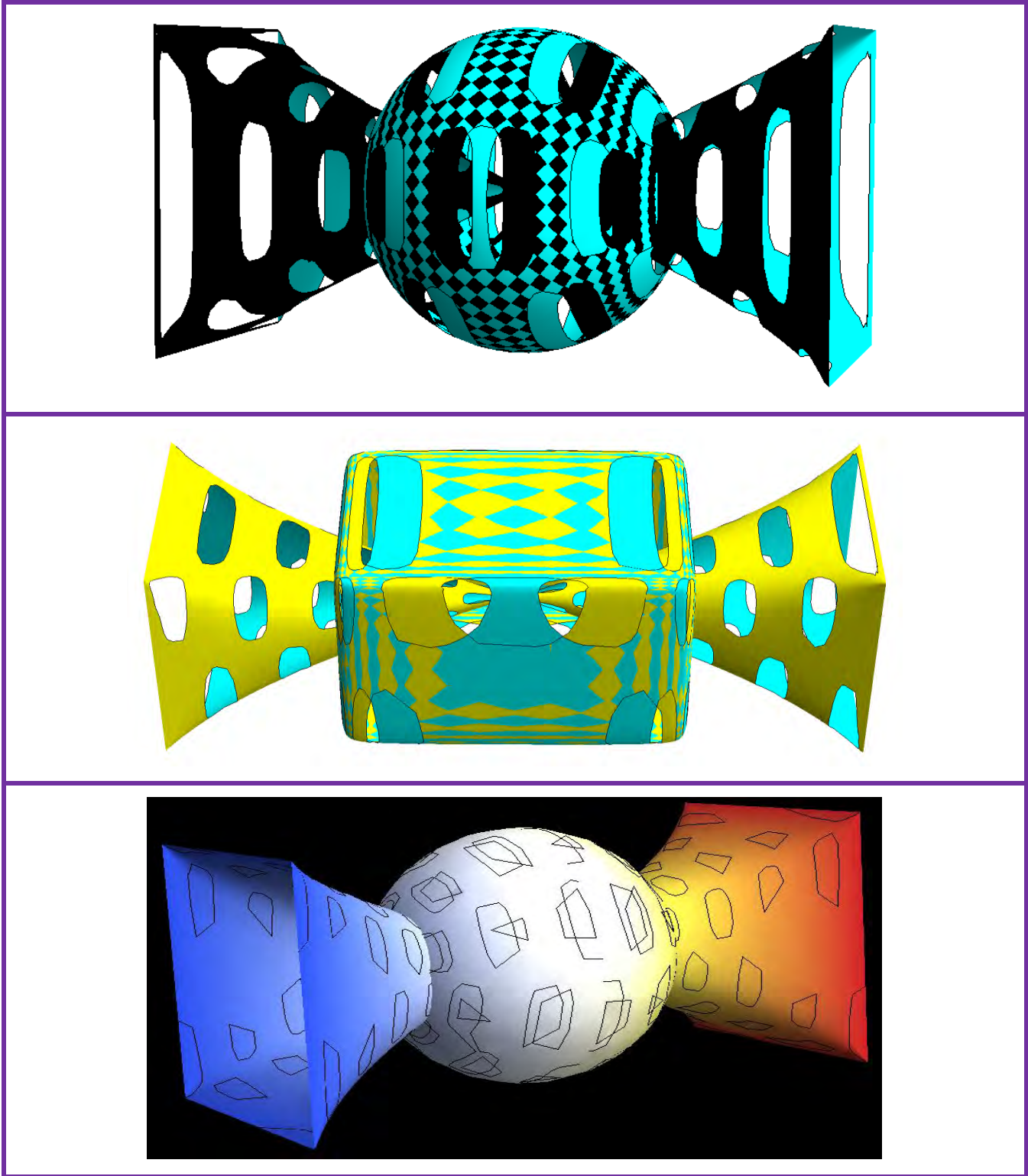



## QUADRUPLE CLEPSYDRAS

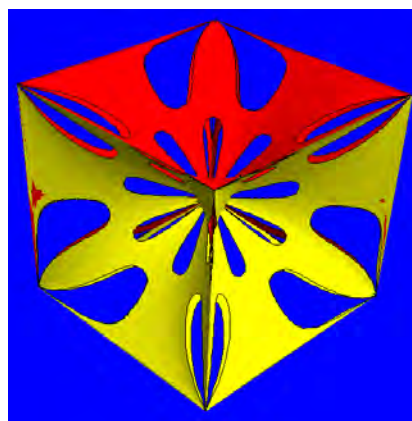
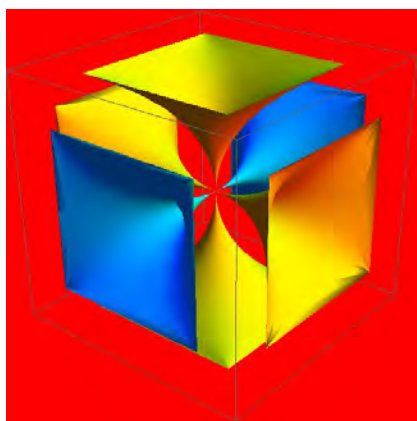
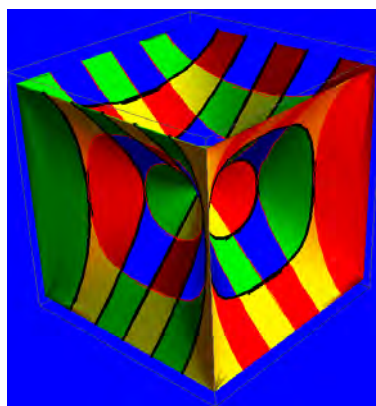
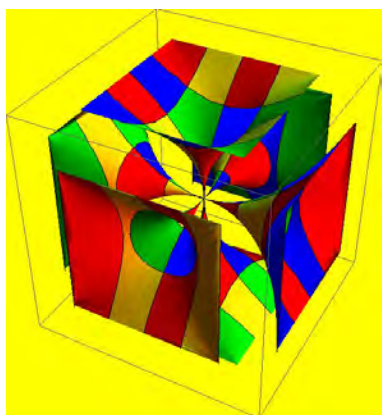
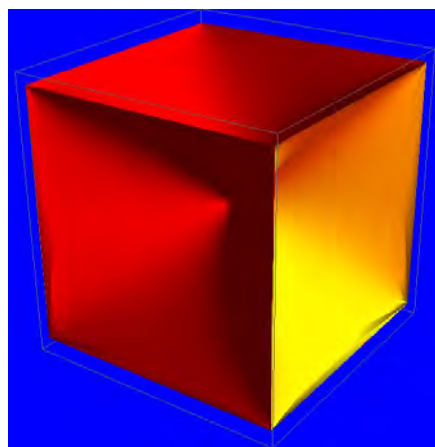
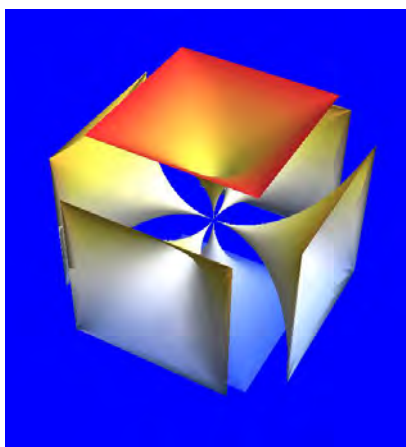

# THE CUBE ROMANIAN: The Easiest Cube in The World

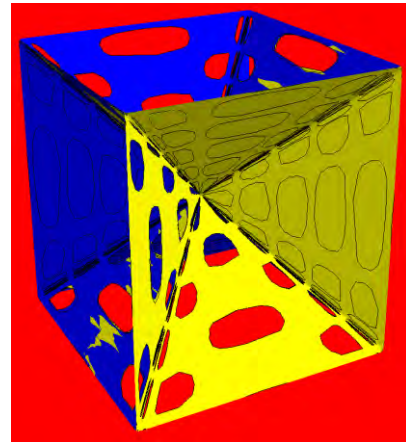
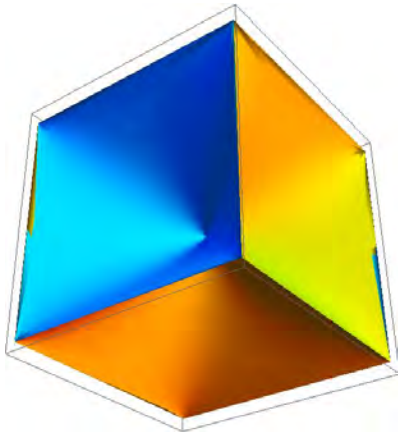
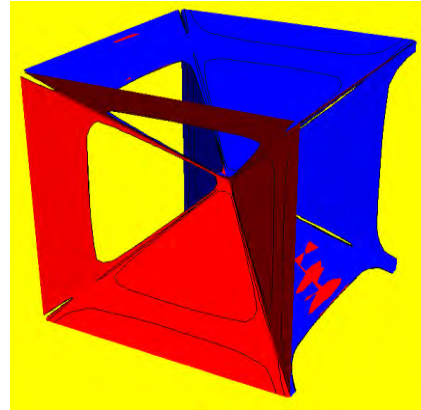
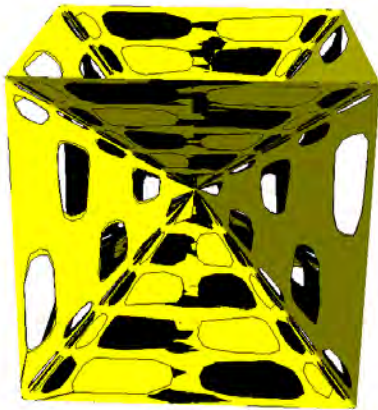
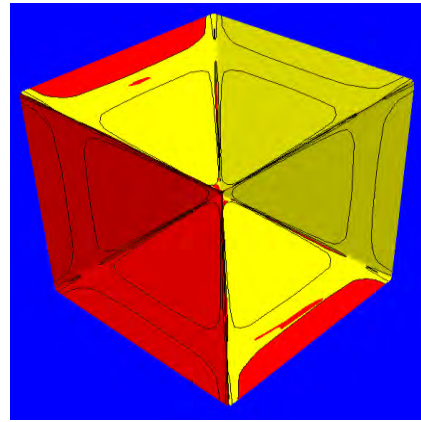
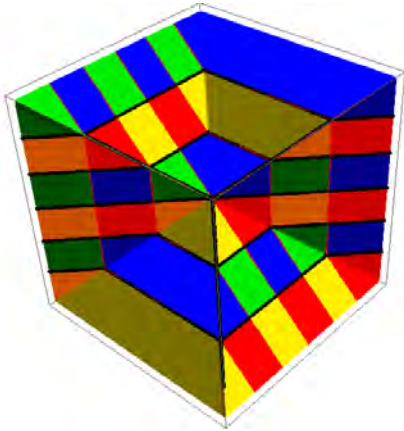

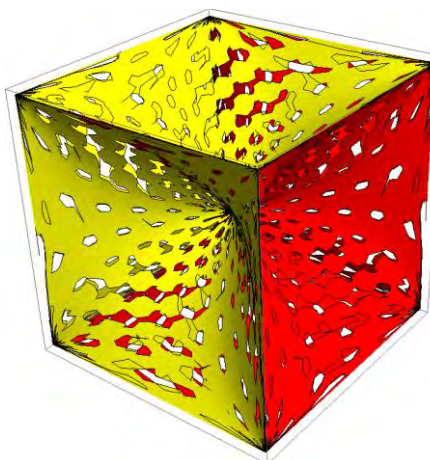
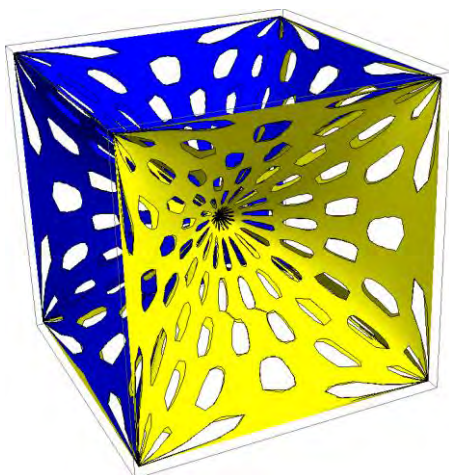
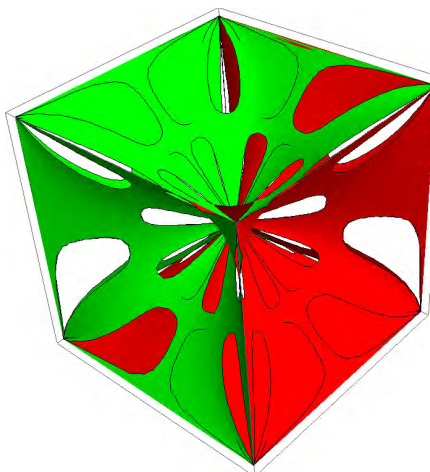
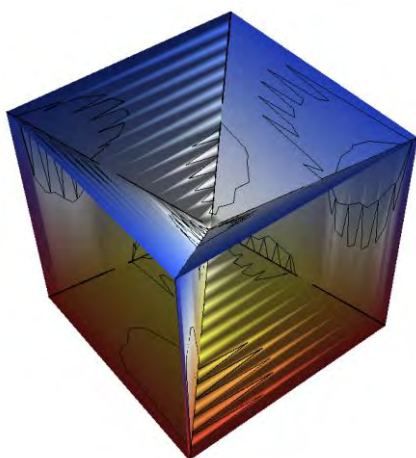
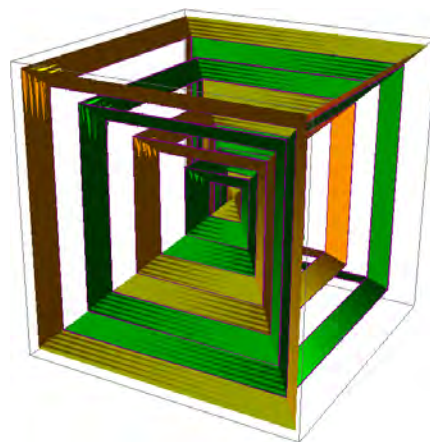
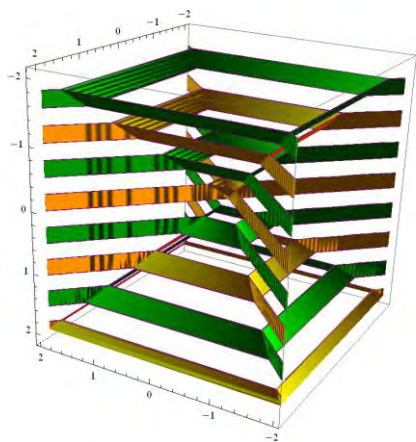



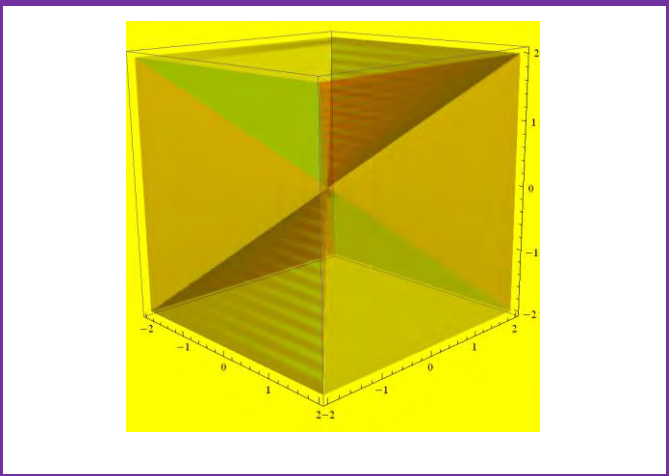
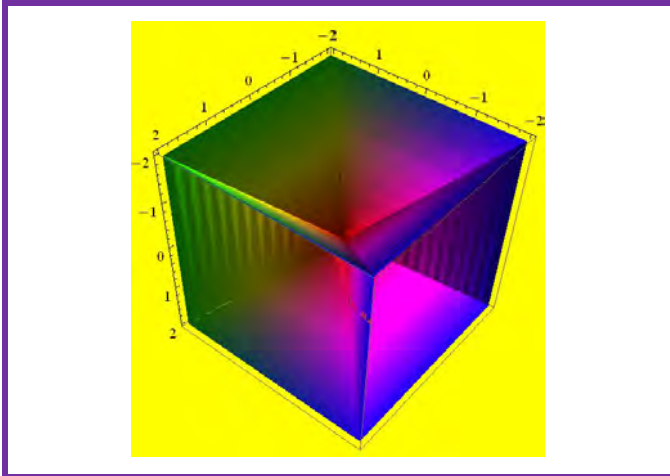
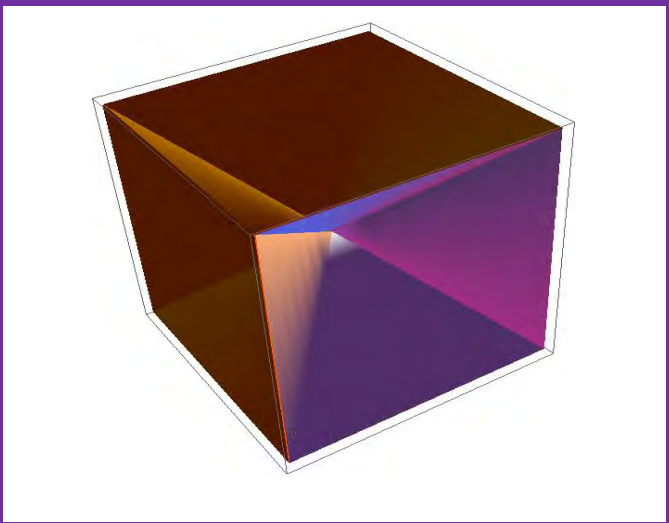
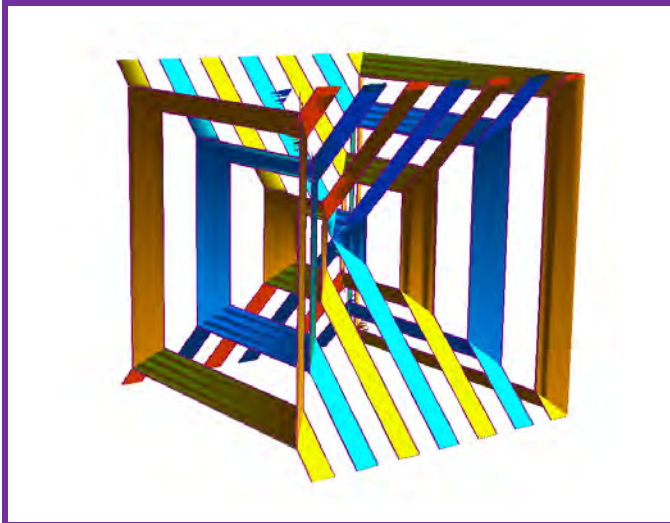
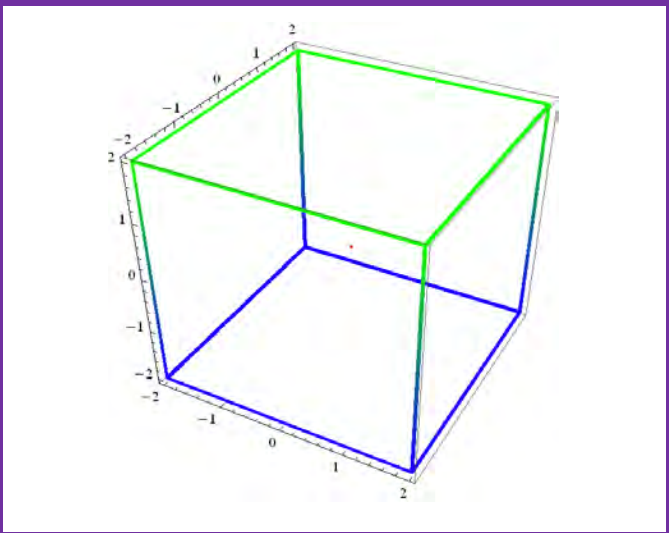
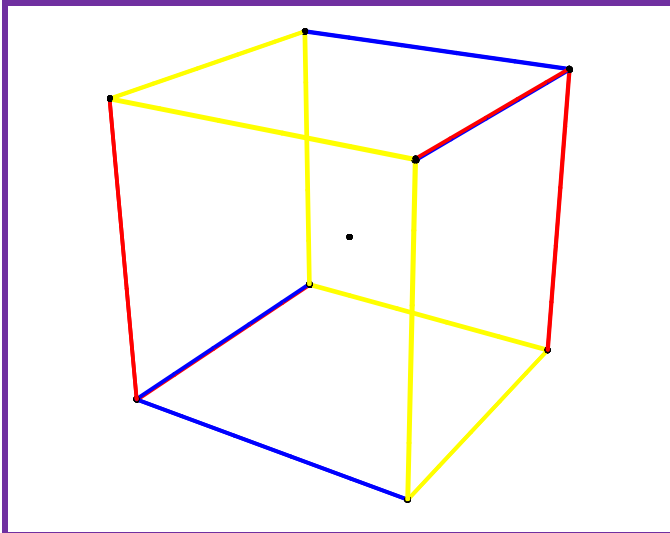

## REAL AND SUPERMATHEMATICS CLEPSYDRAS

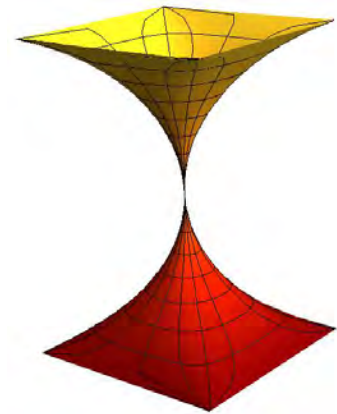
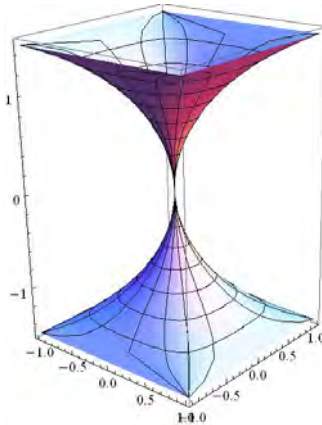
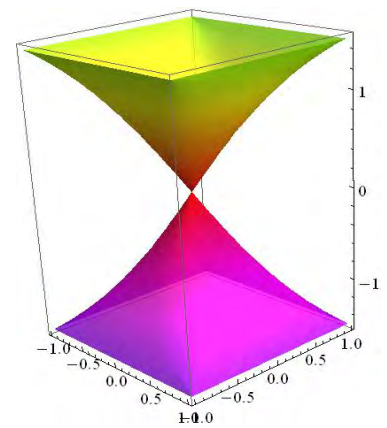
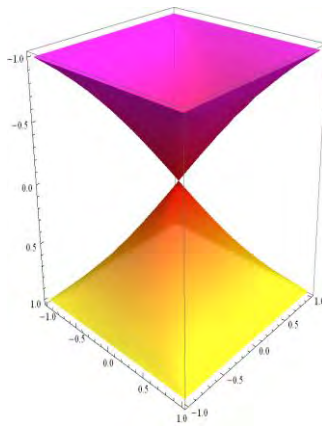
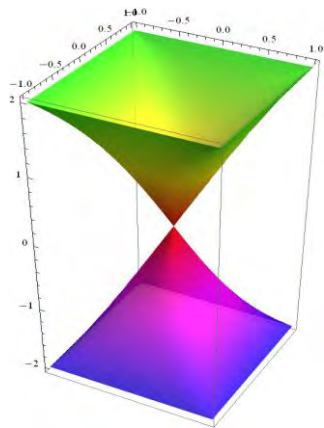

ARTISTIC AND SUPERMATHEMATICS CLEPSYDRAS

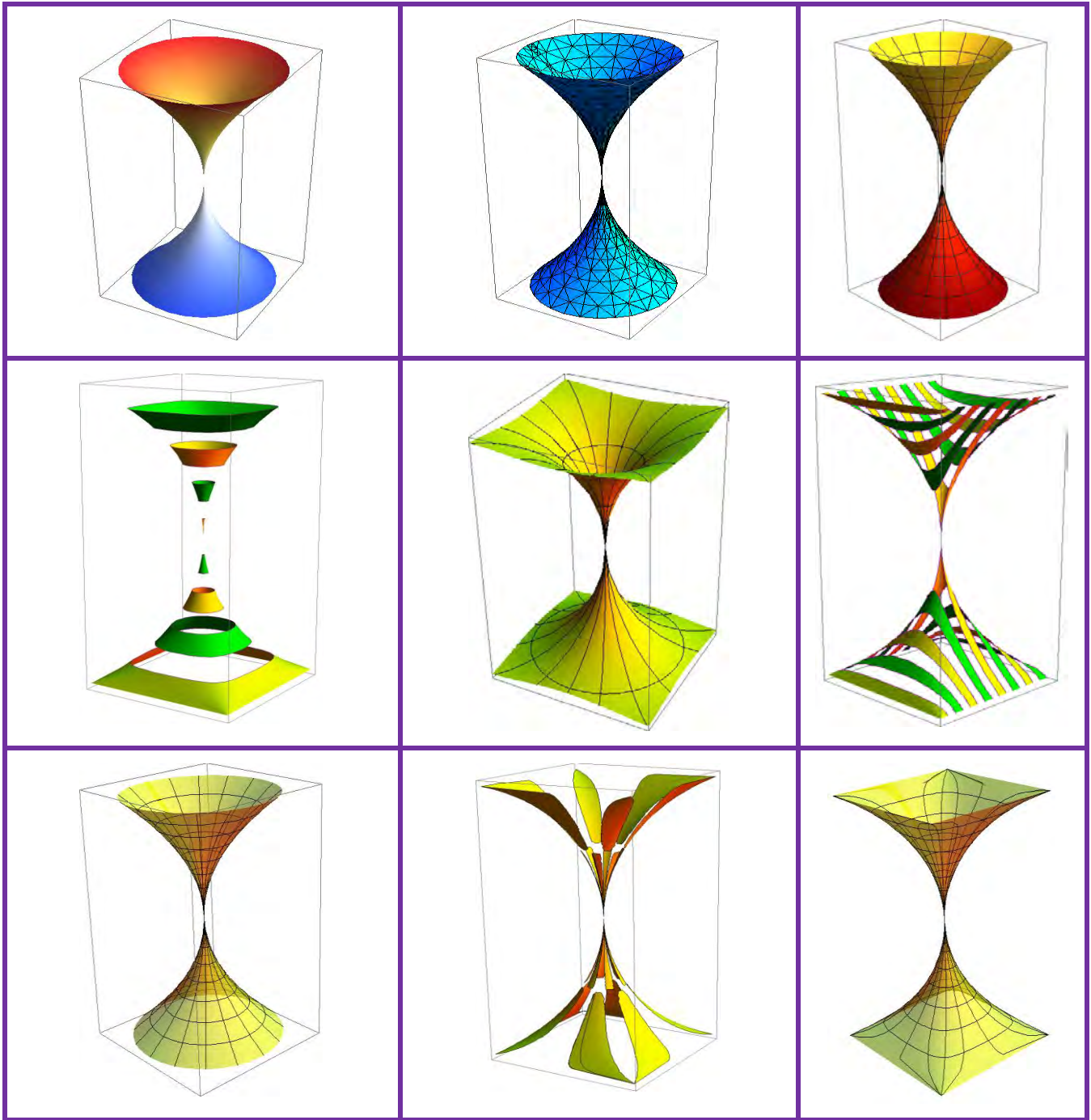



VARIOUS CONES AND PYRAMIDS. Cone continuing transformation in pyramidocon or conopyramid

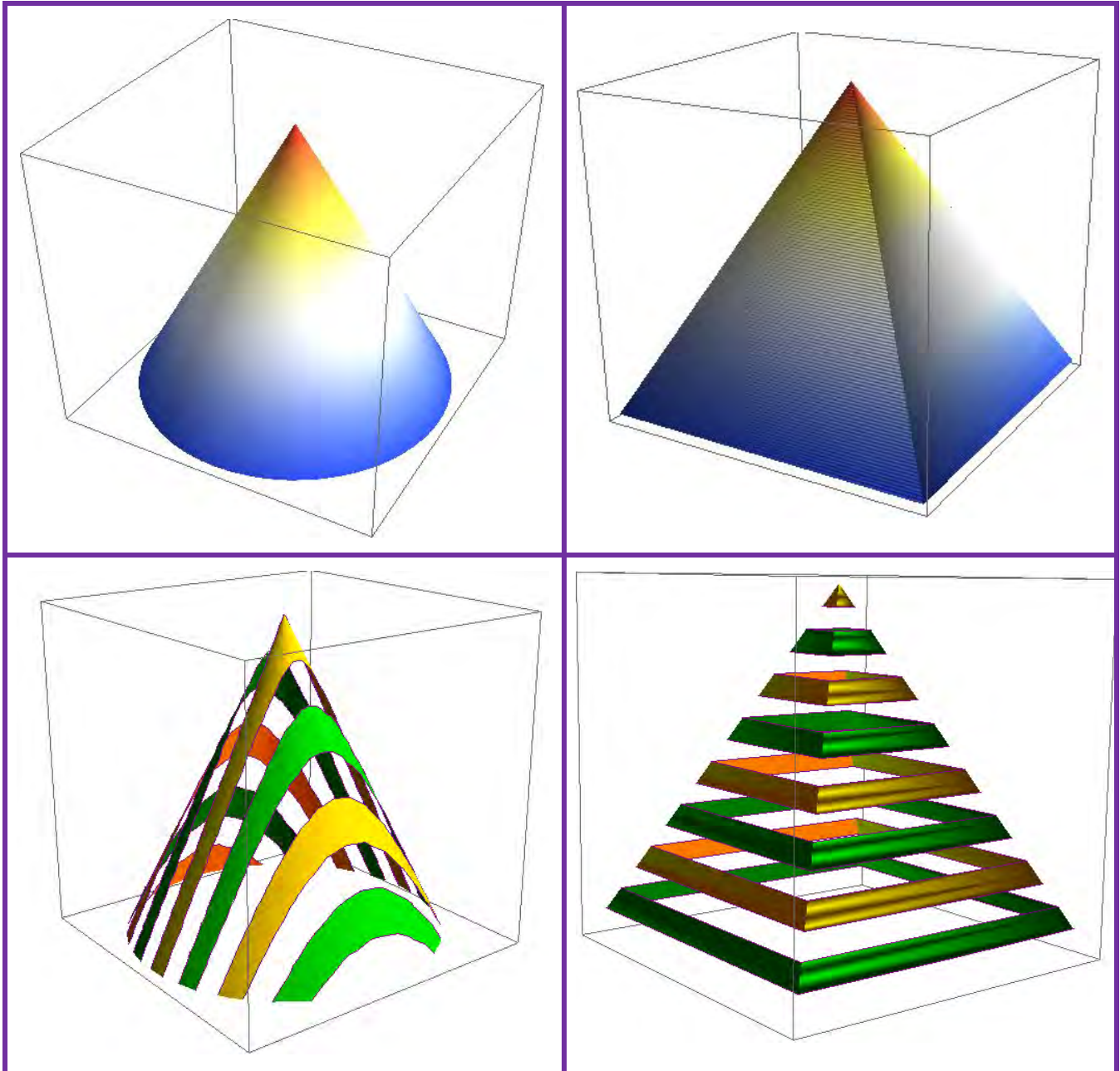



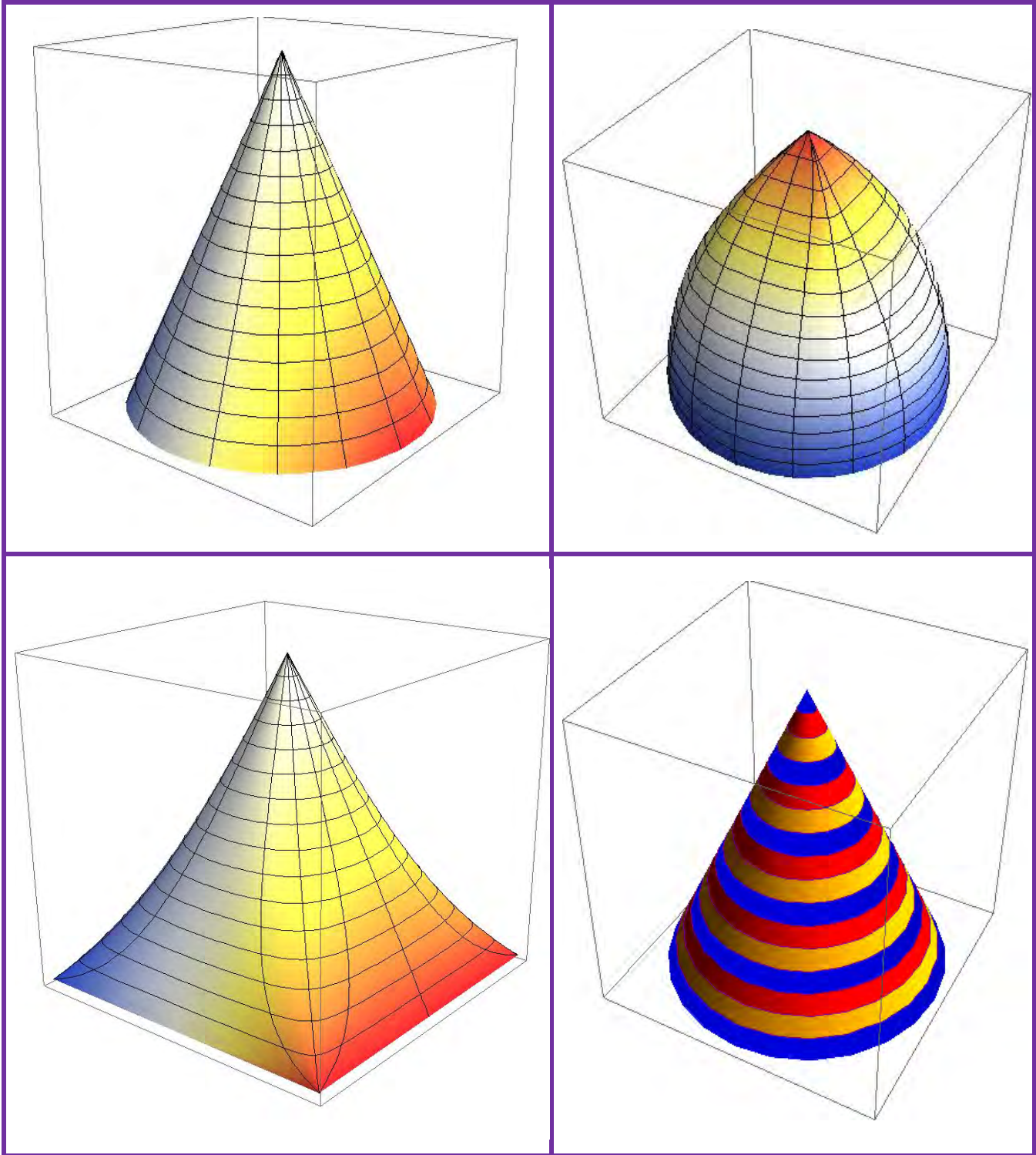

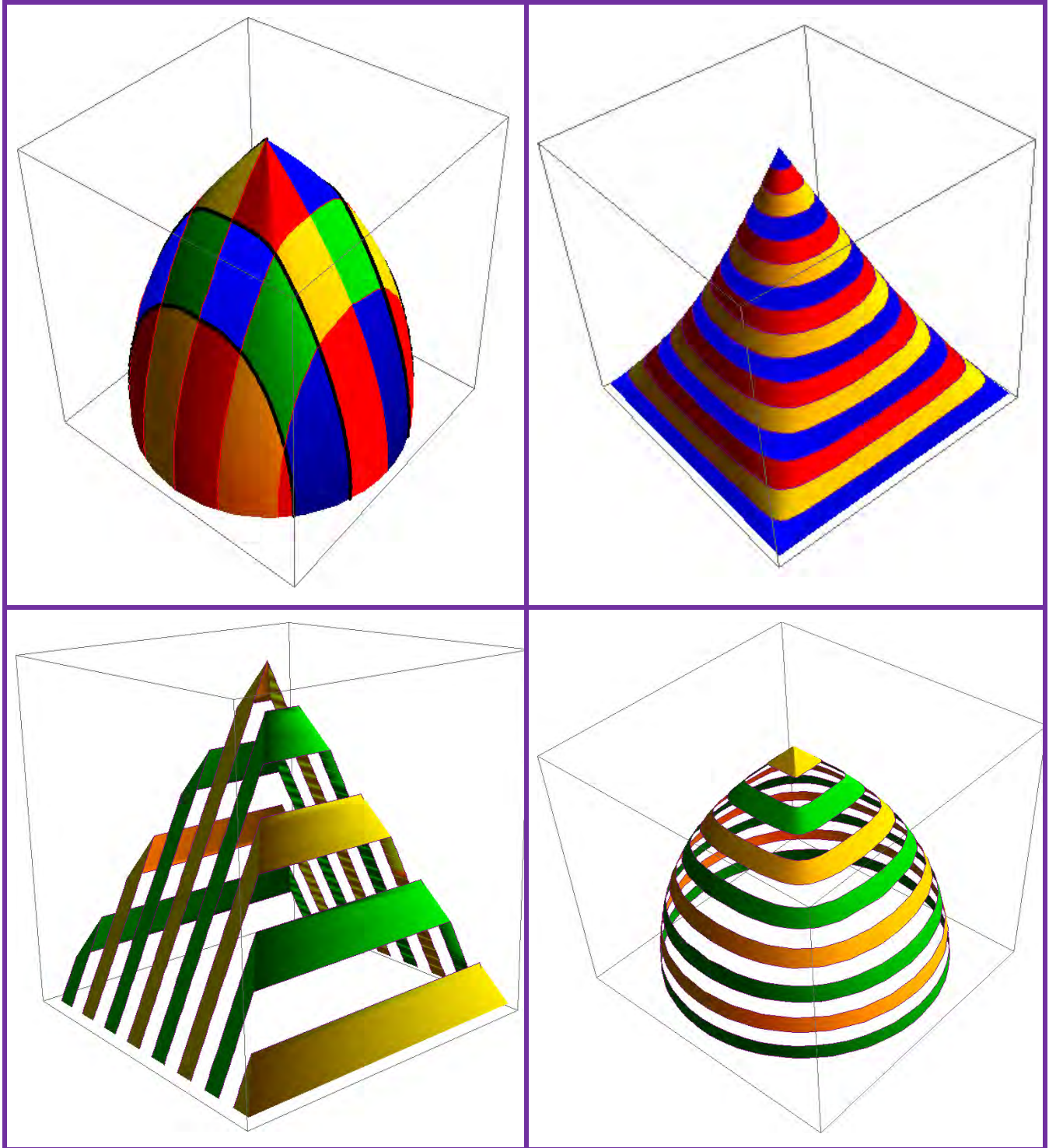

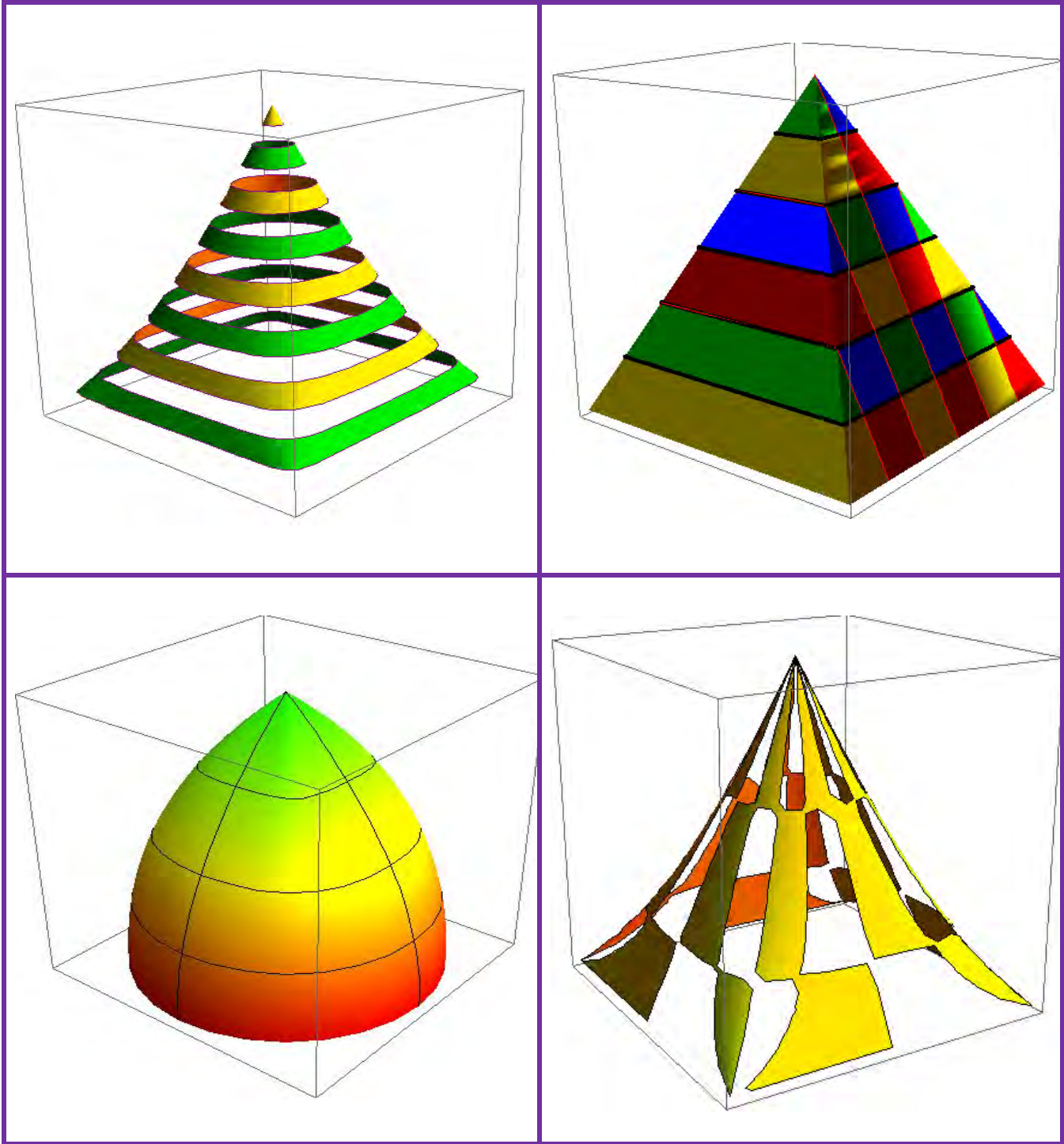



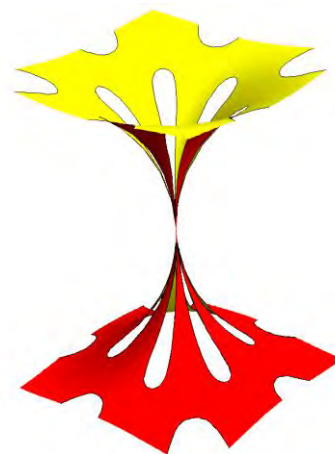
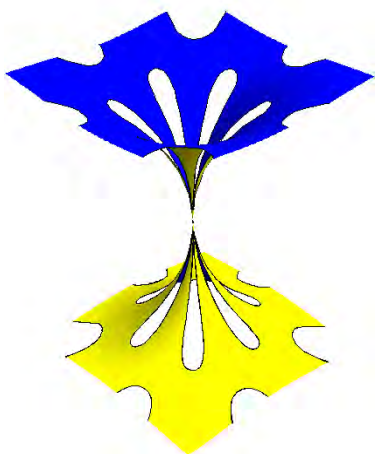
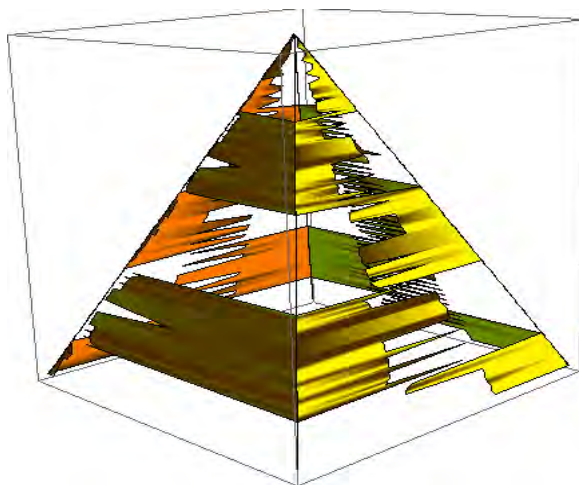
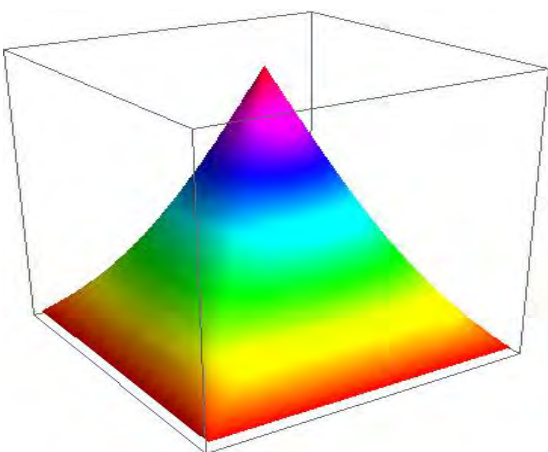
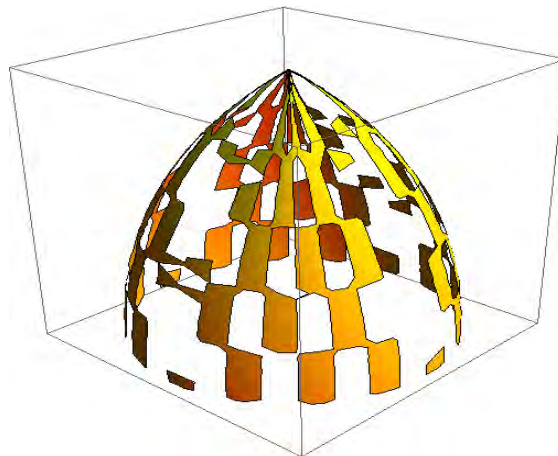
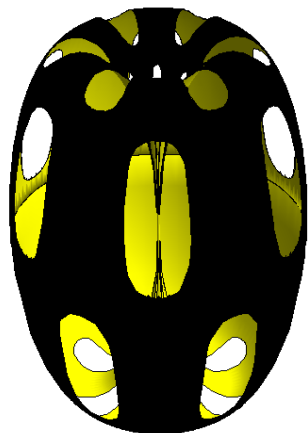

CURIOUS CONOPYRAMIDS

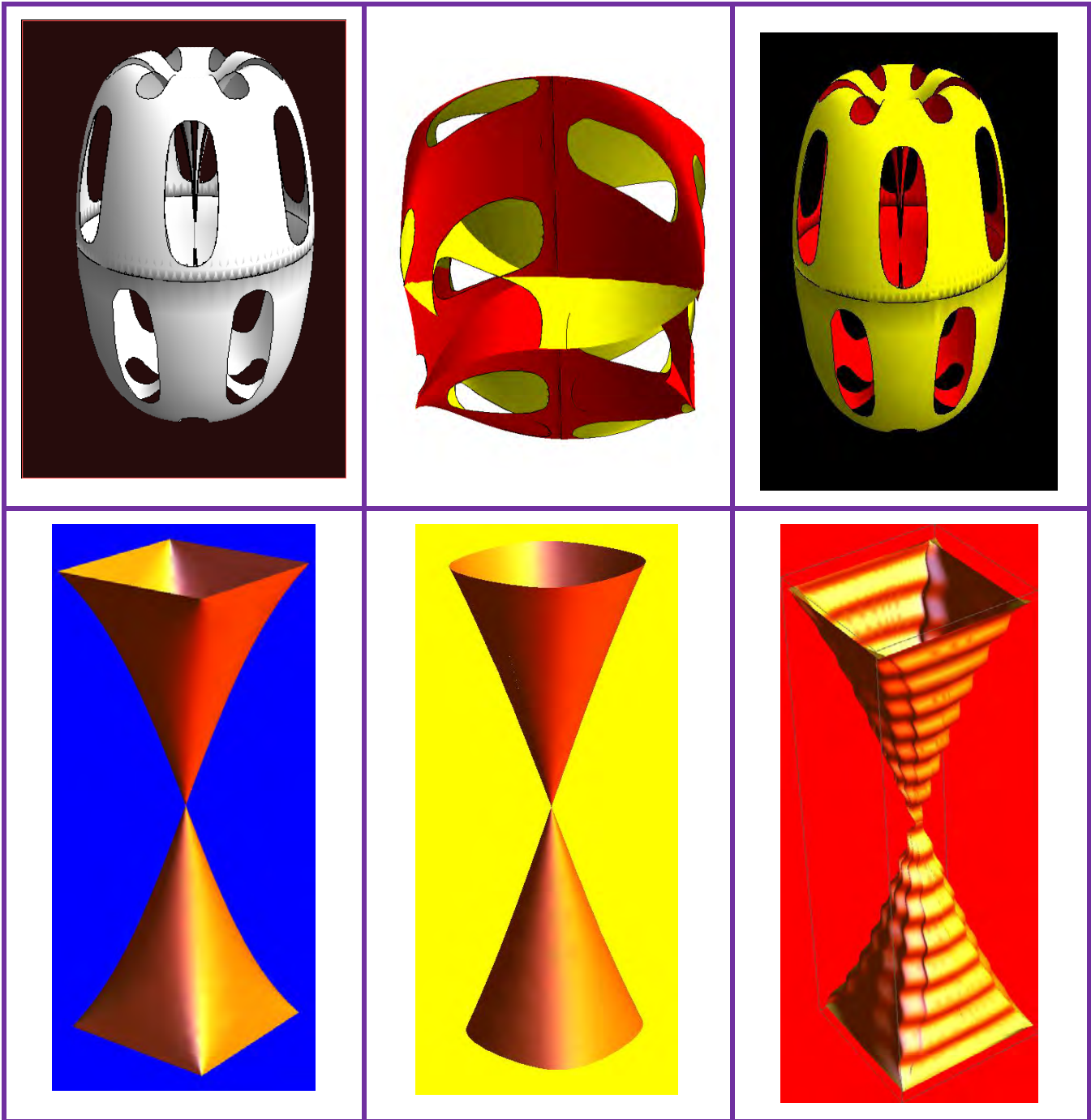

## FLOWER VASES

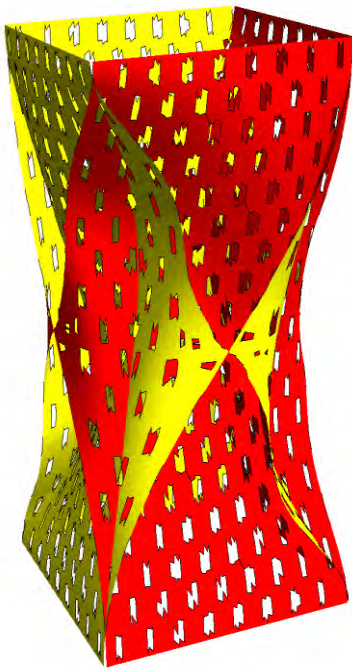
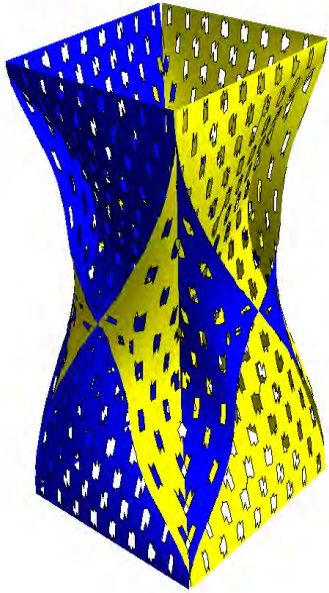

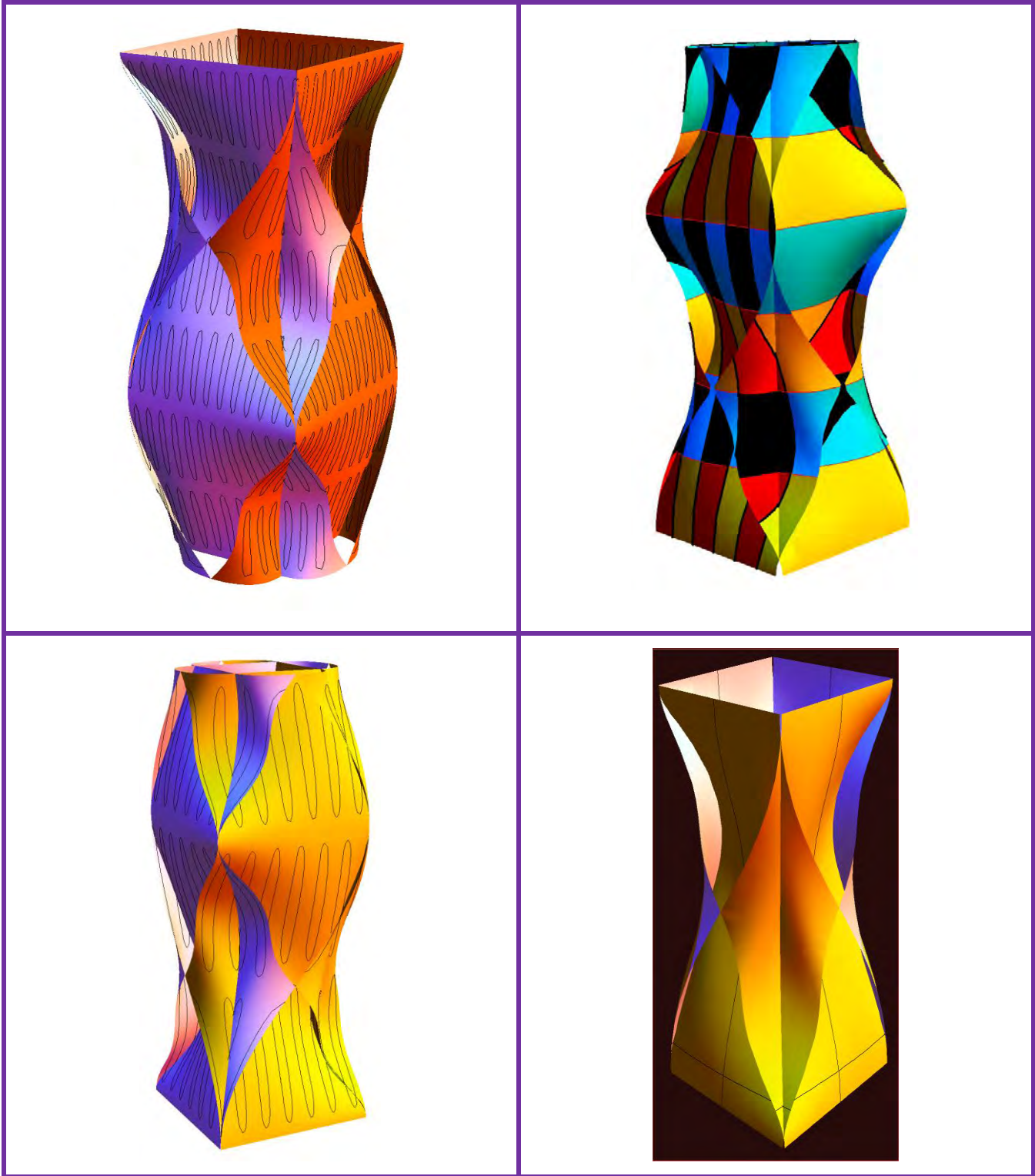



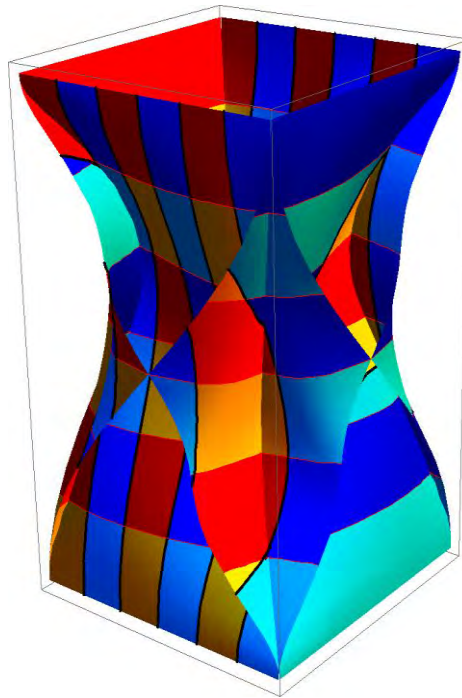
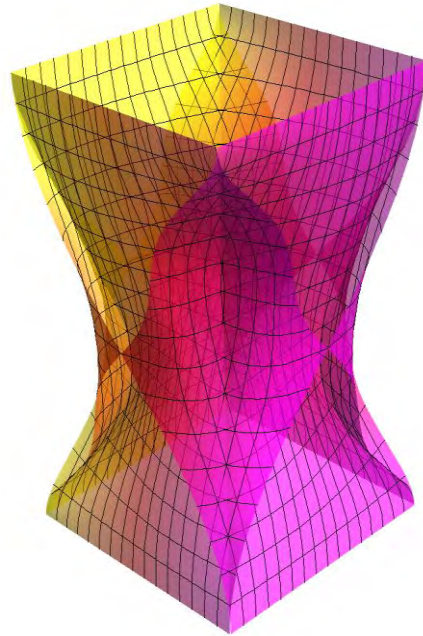

# CUBES

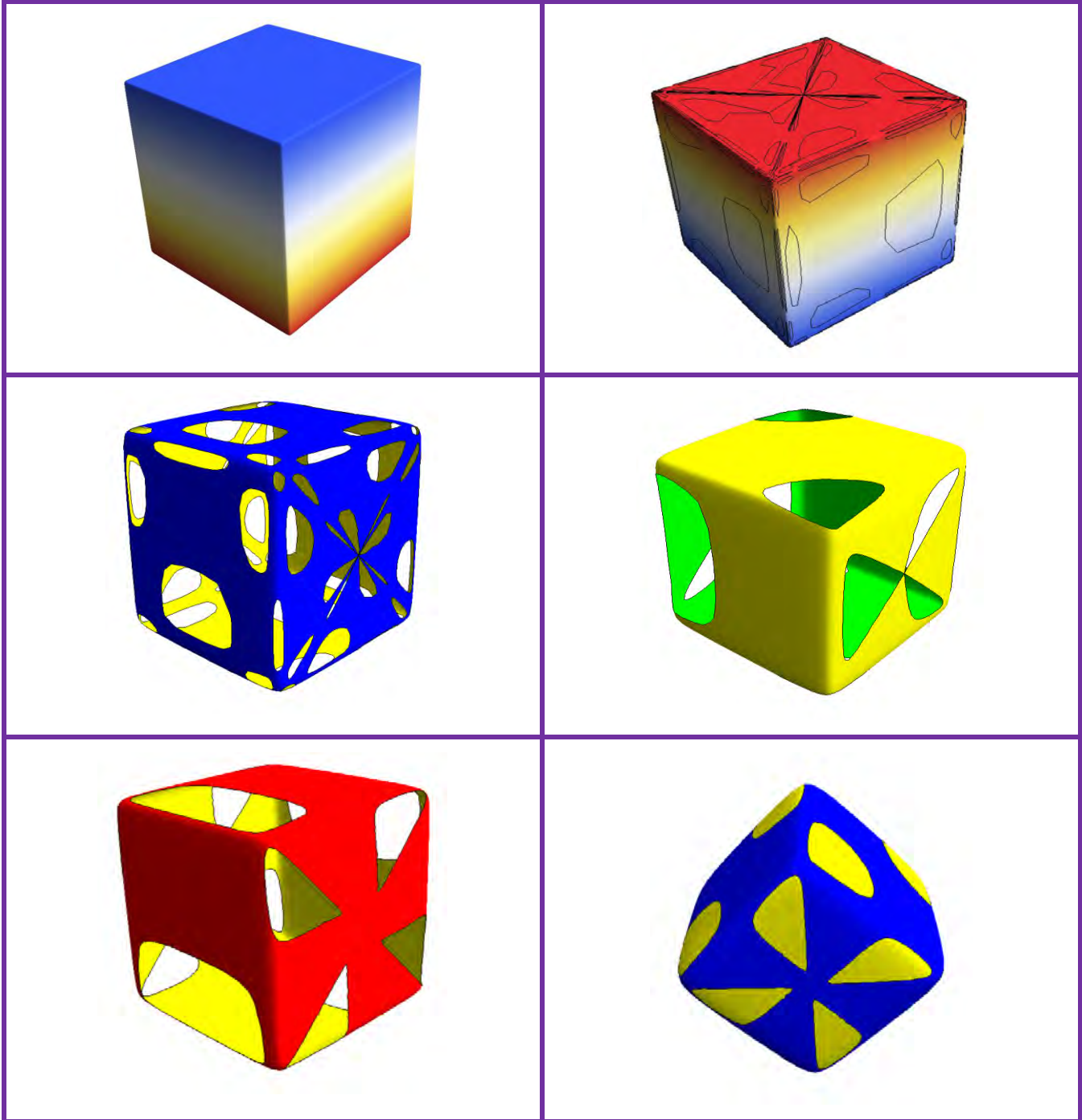

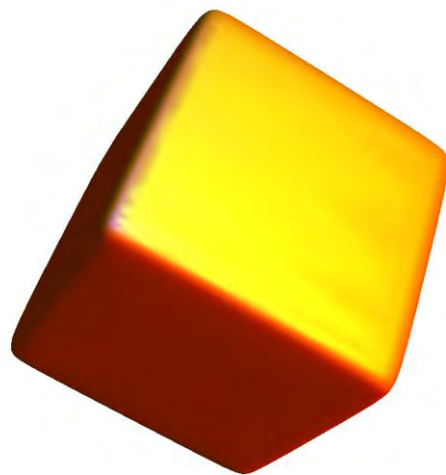
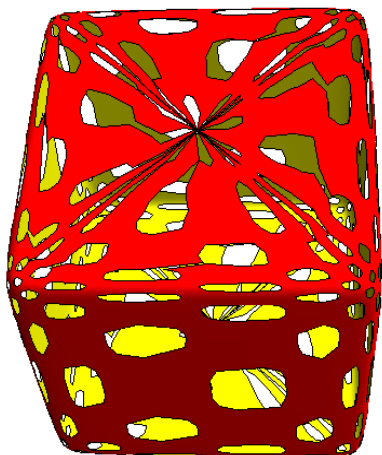
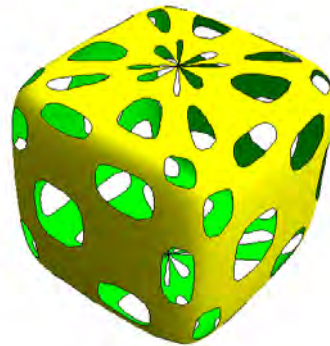
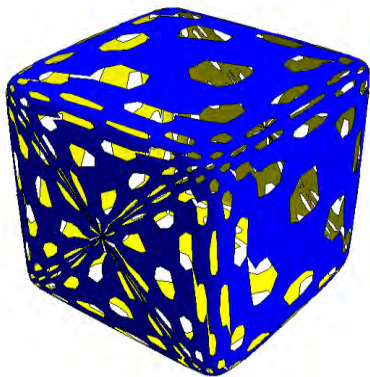
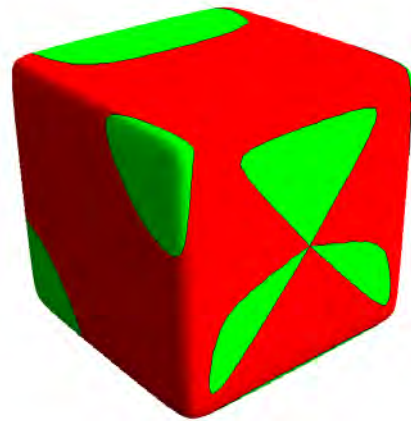
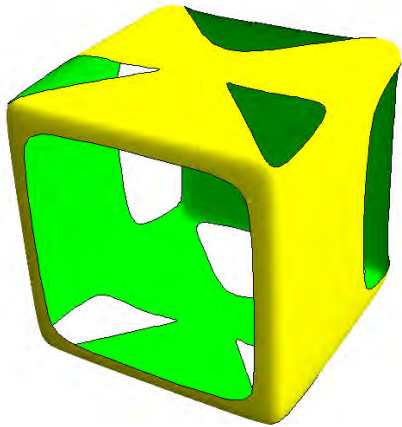

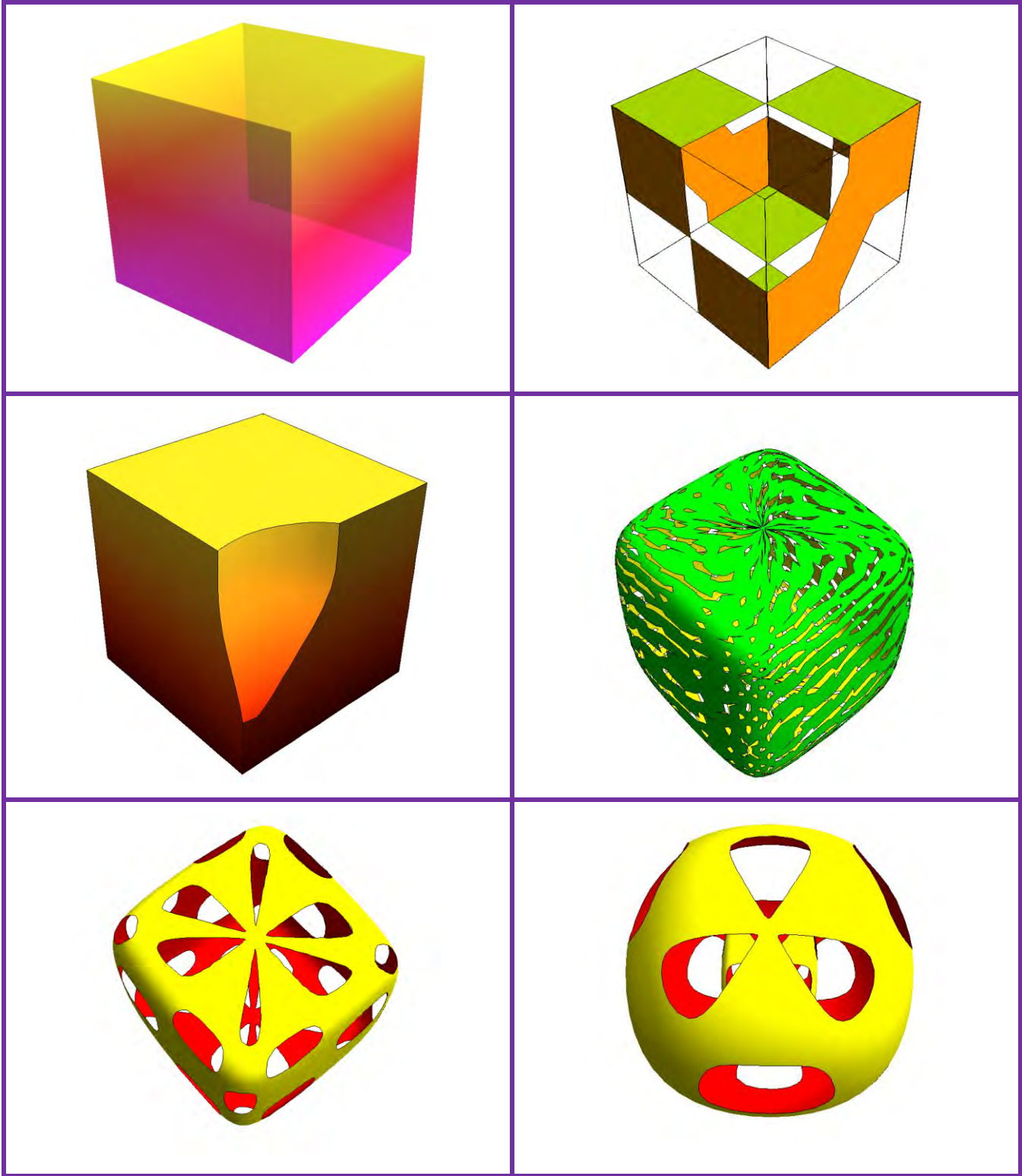



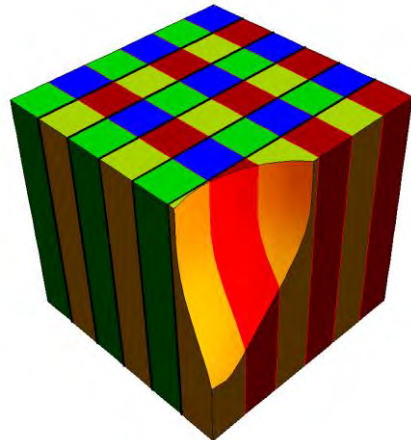
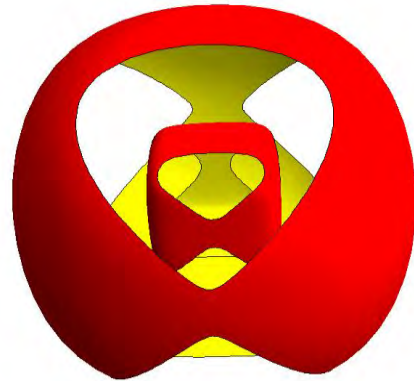
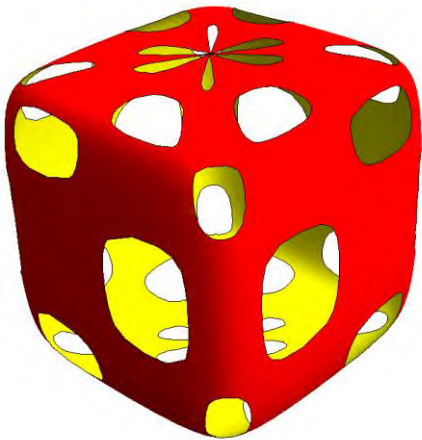
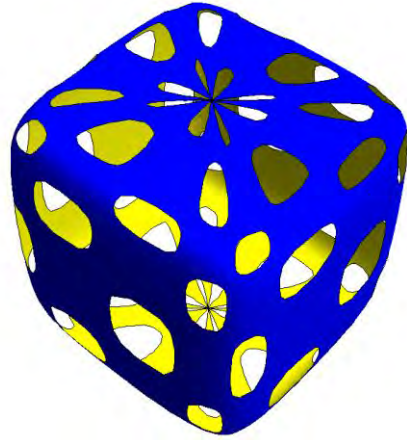
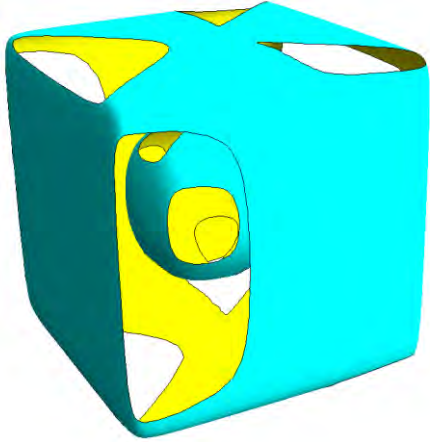

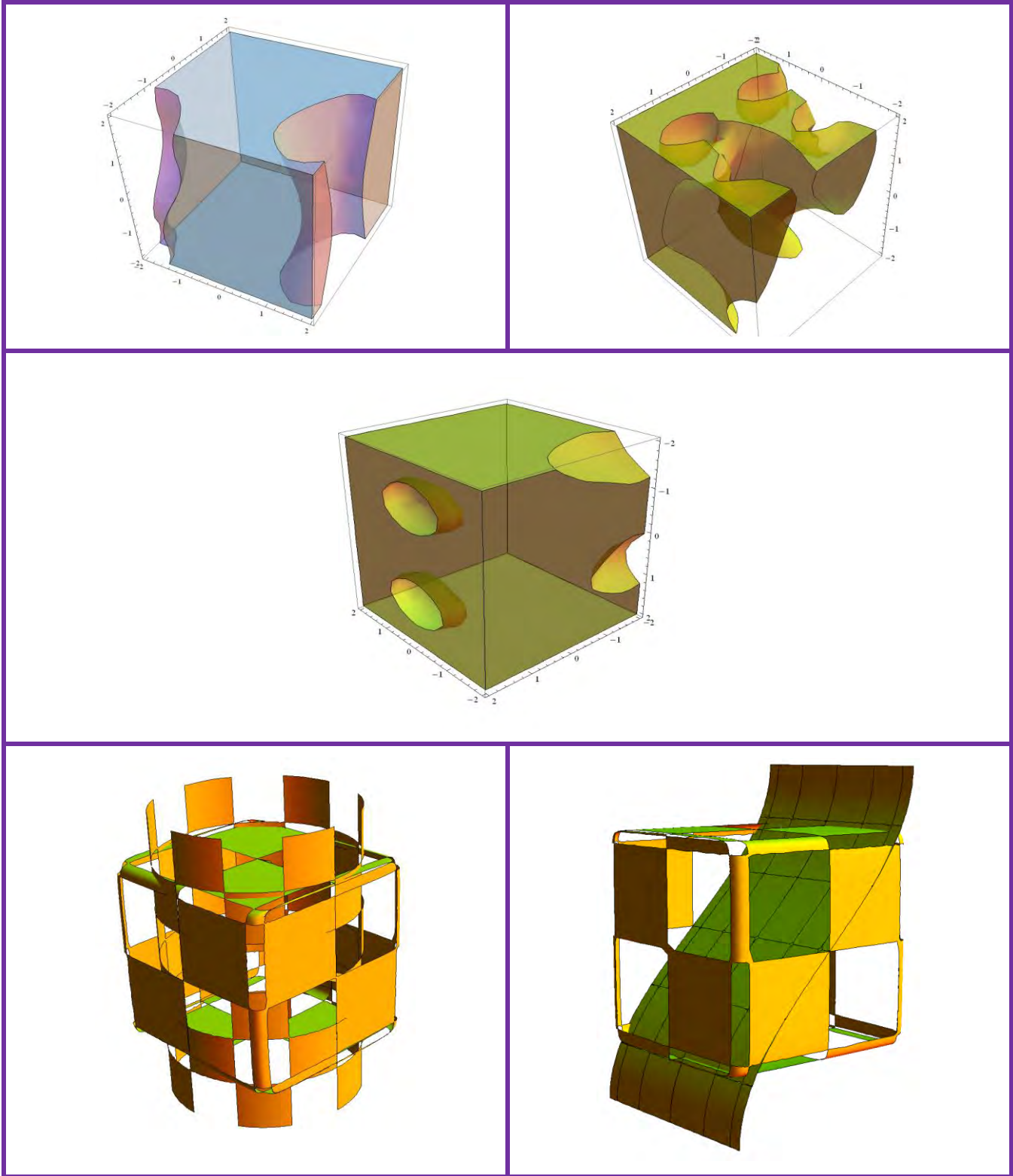

## INTERTWINED SM OBJECTS

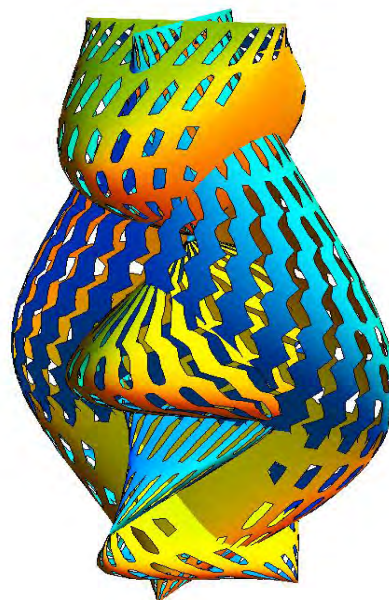
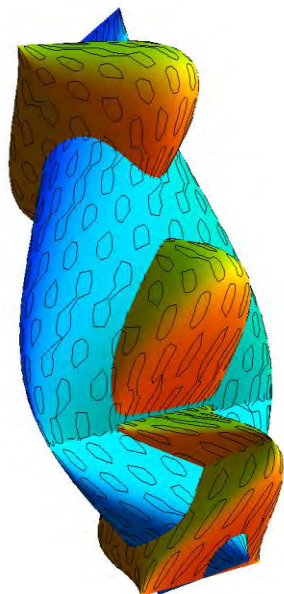
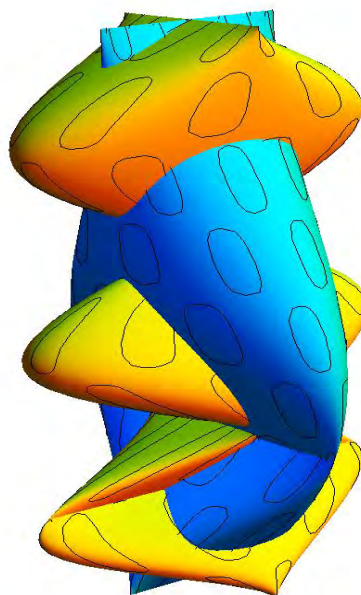
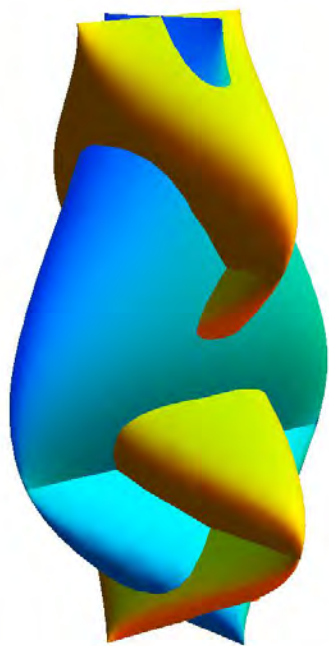



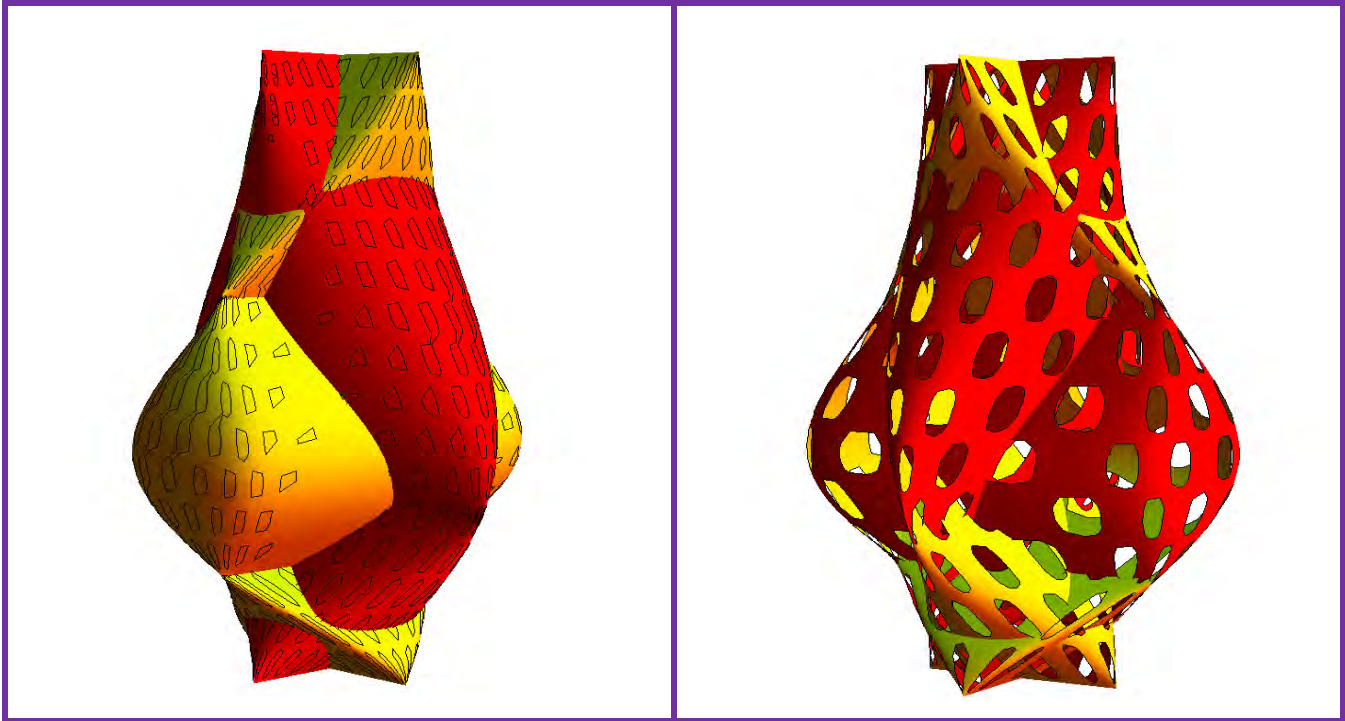

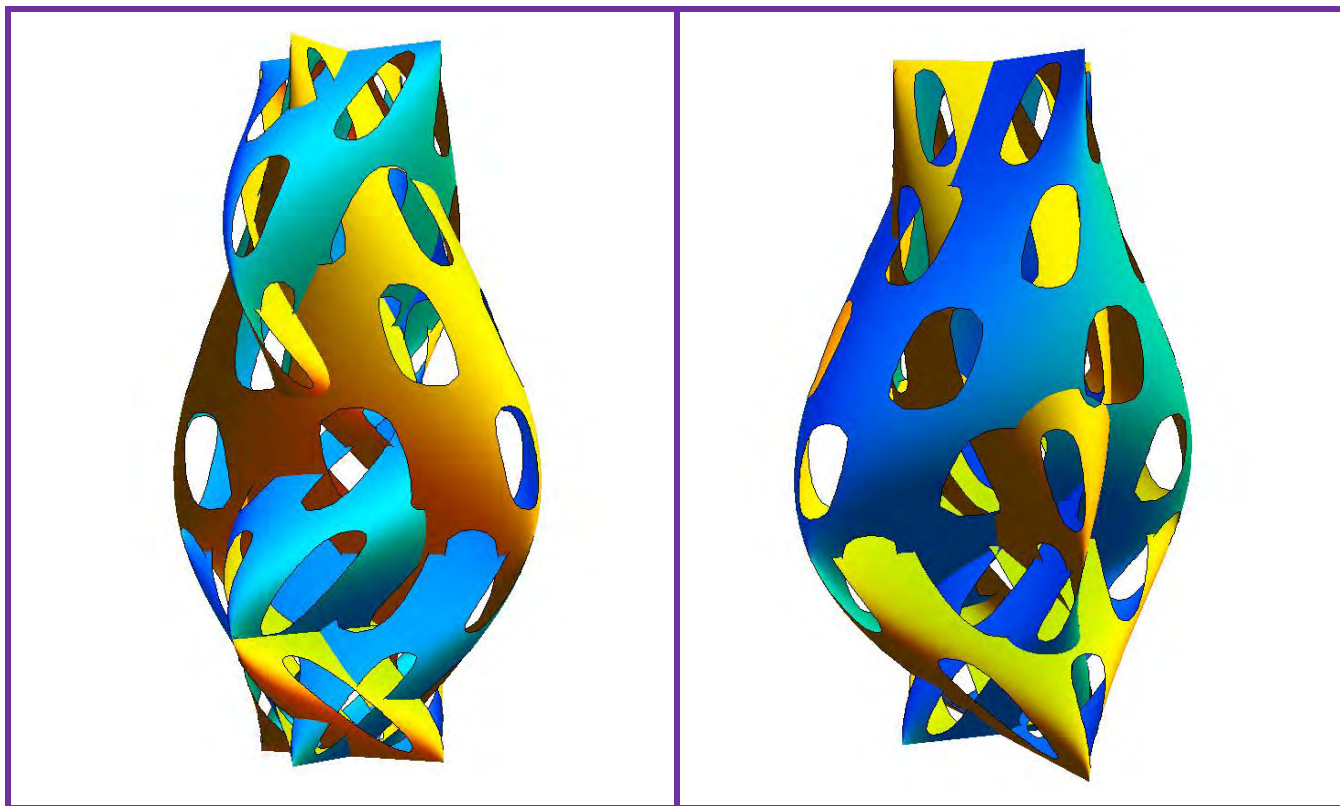

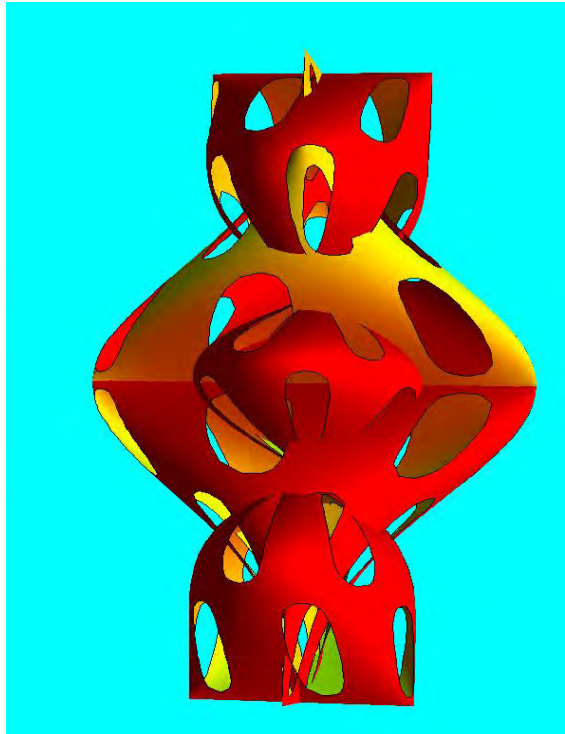
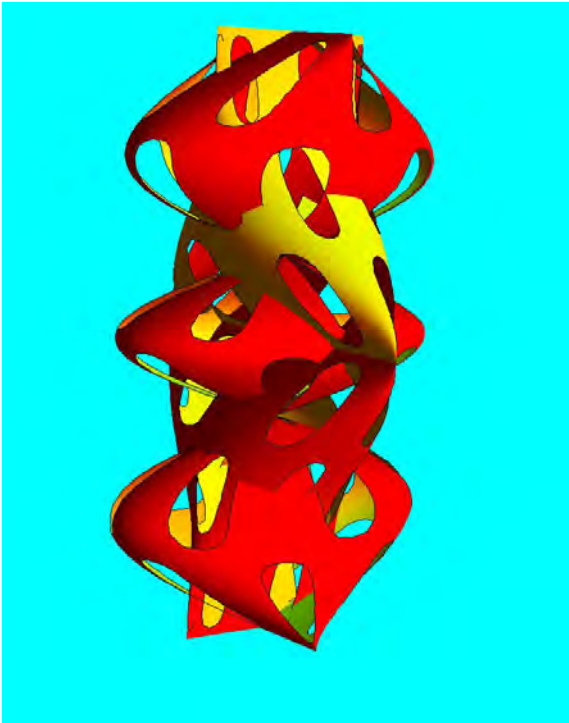
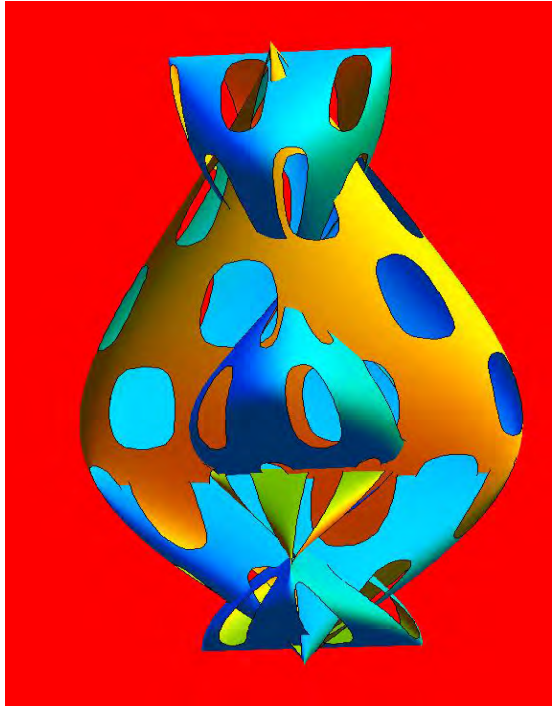
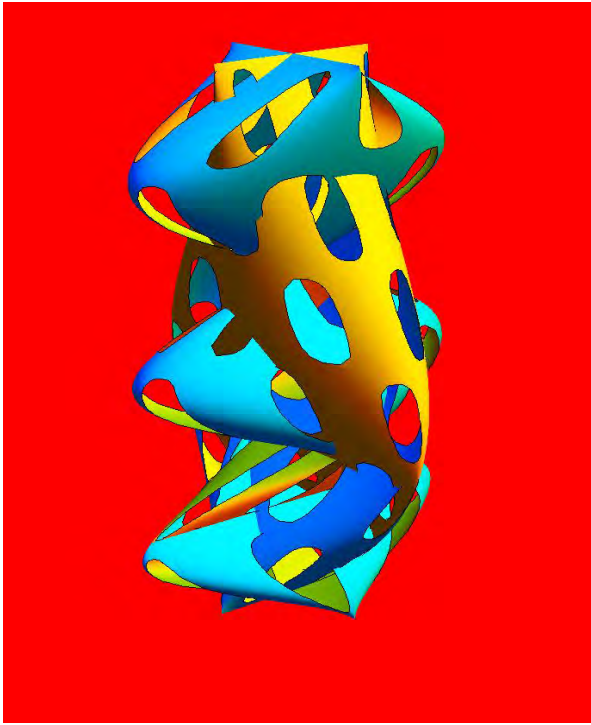

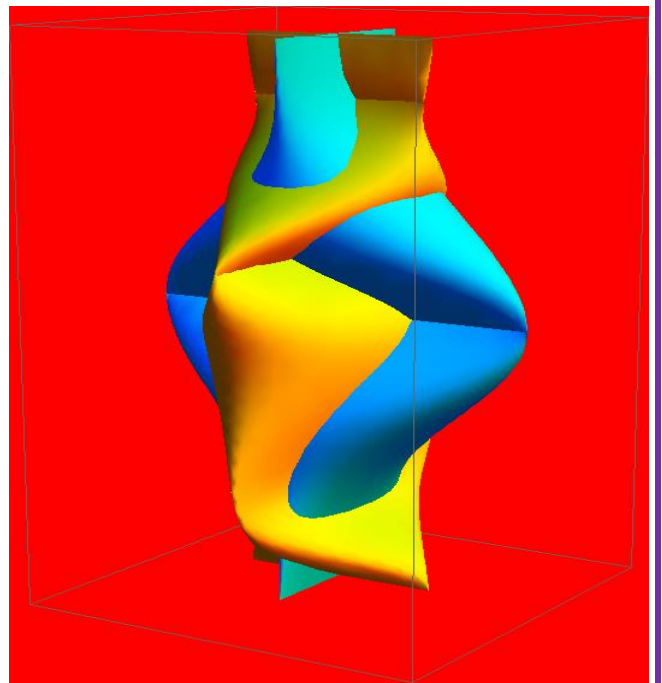
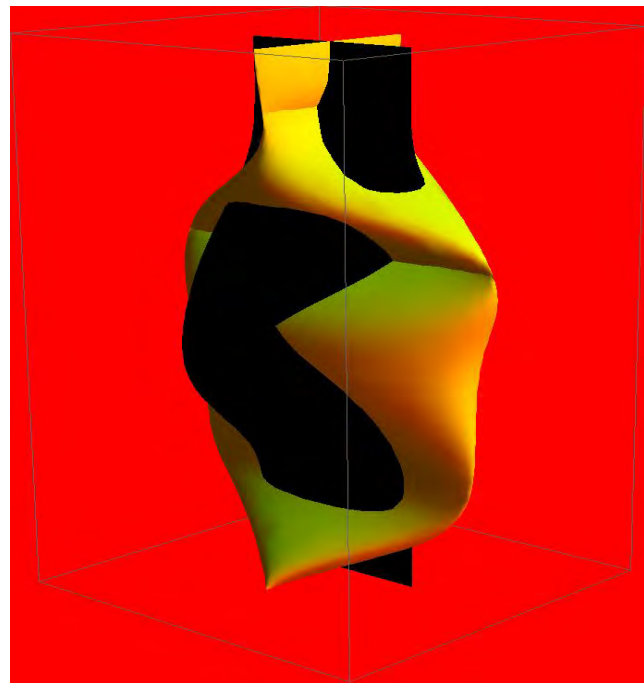
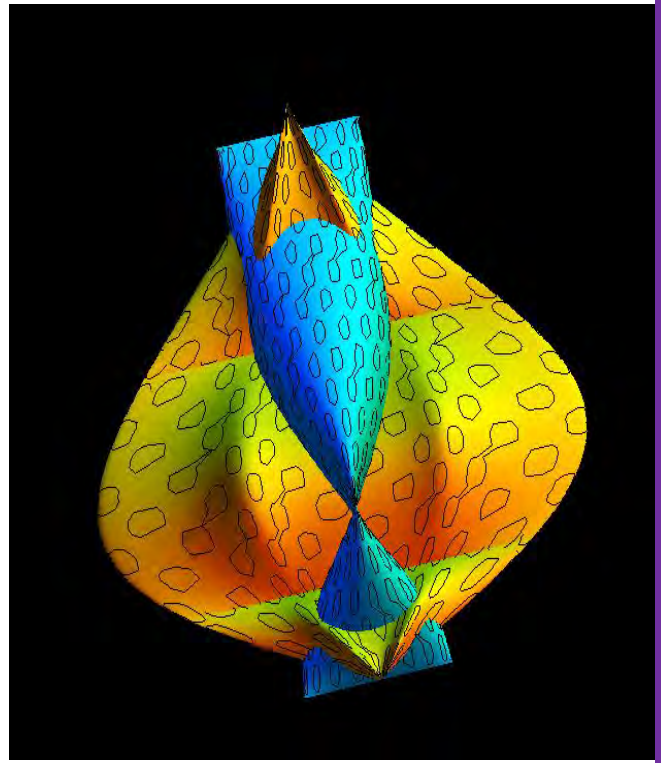
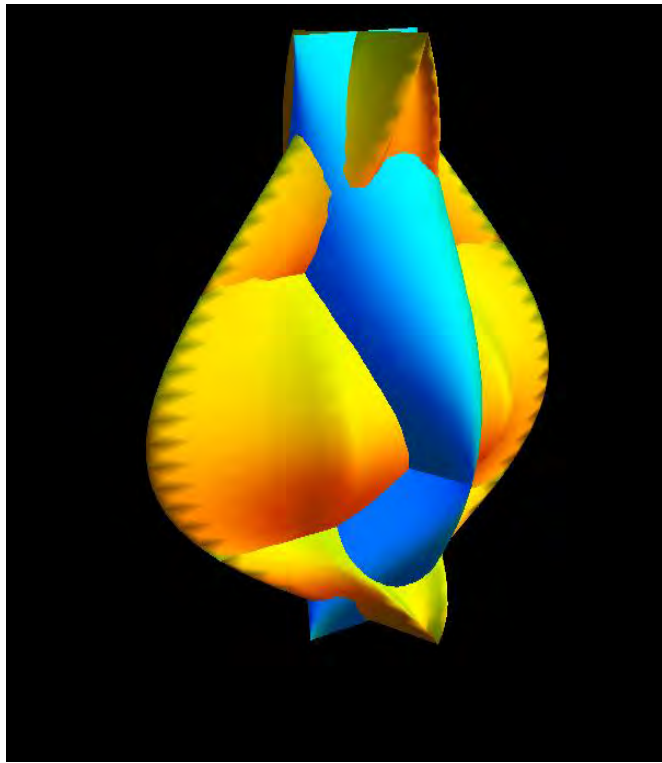



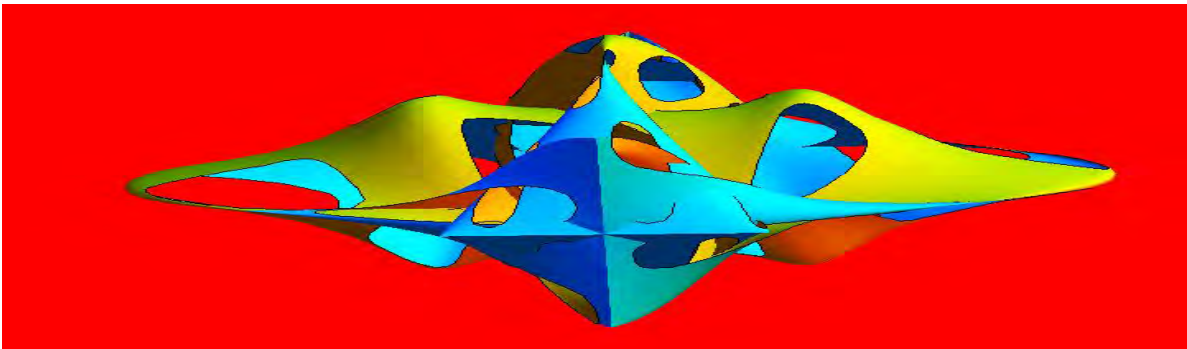
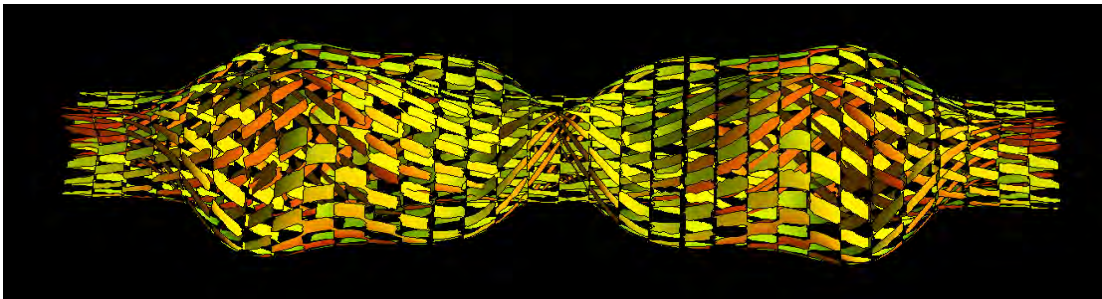
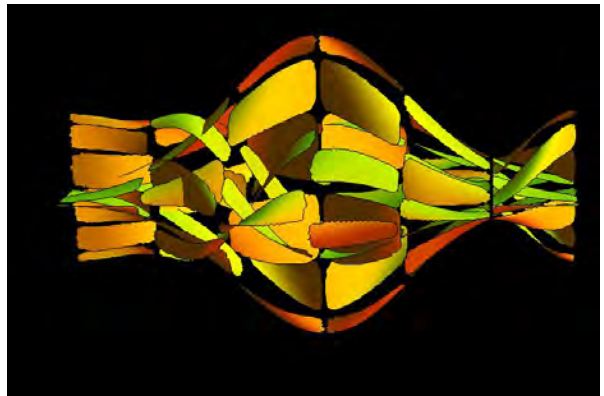
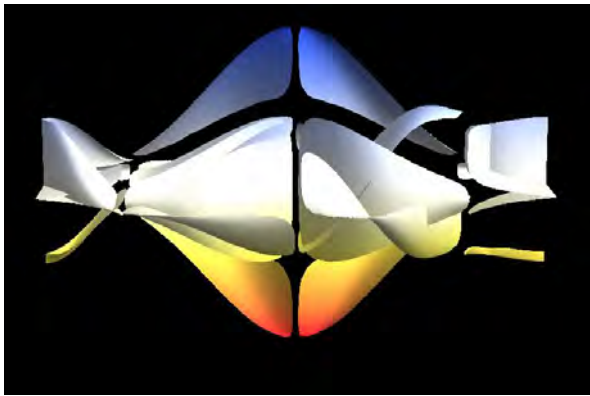
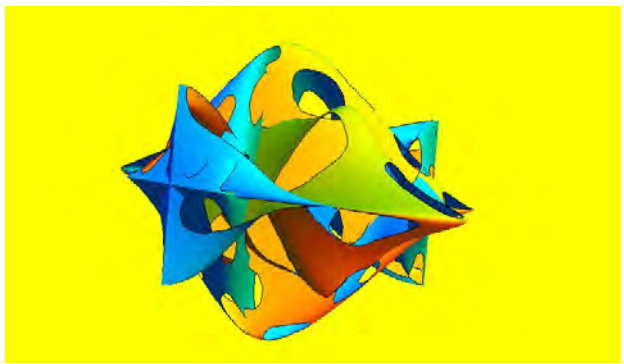
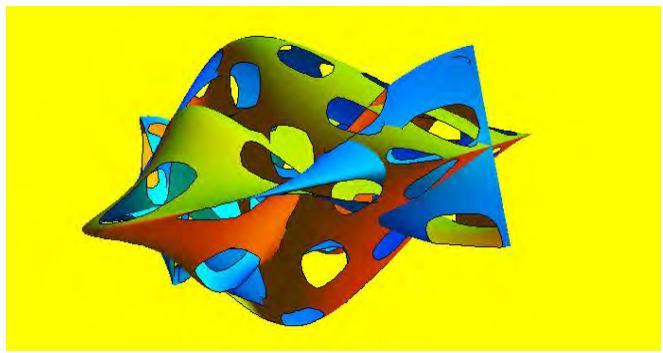



## QUADRILOBIC CUBES

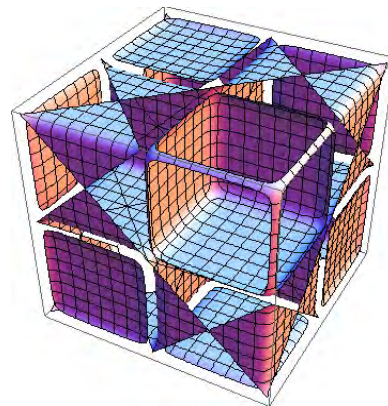
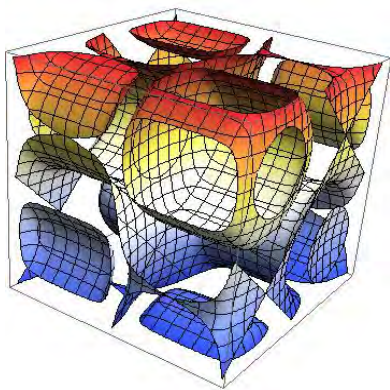
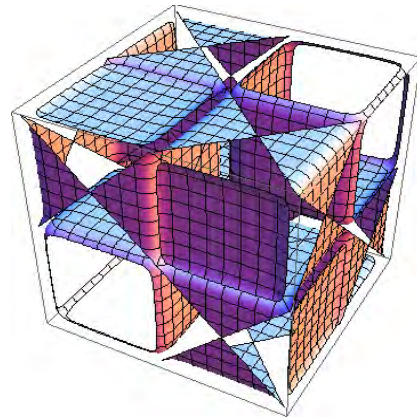
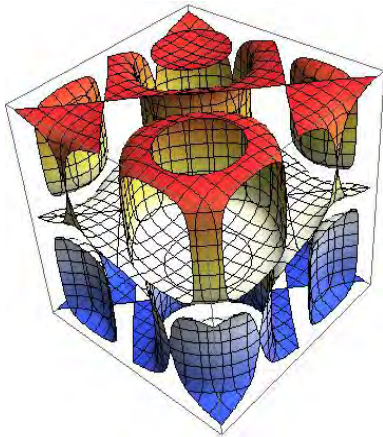
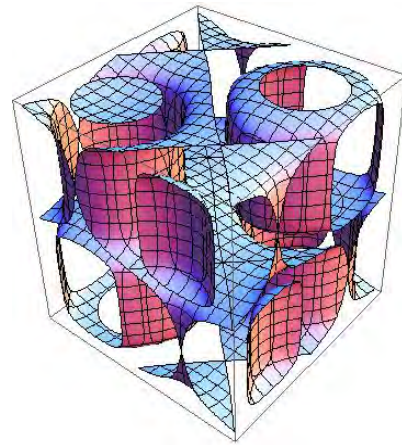
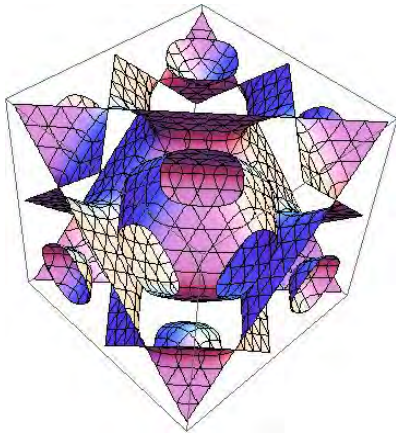

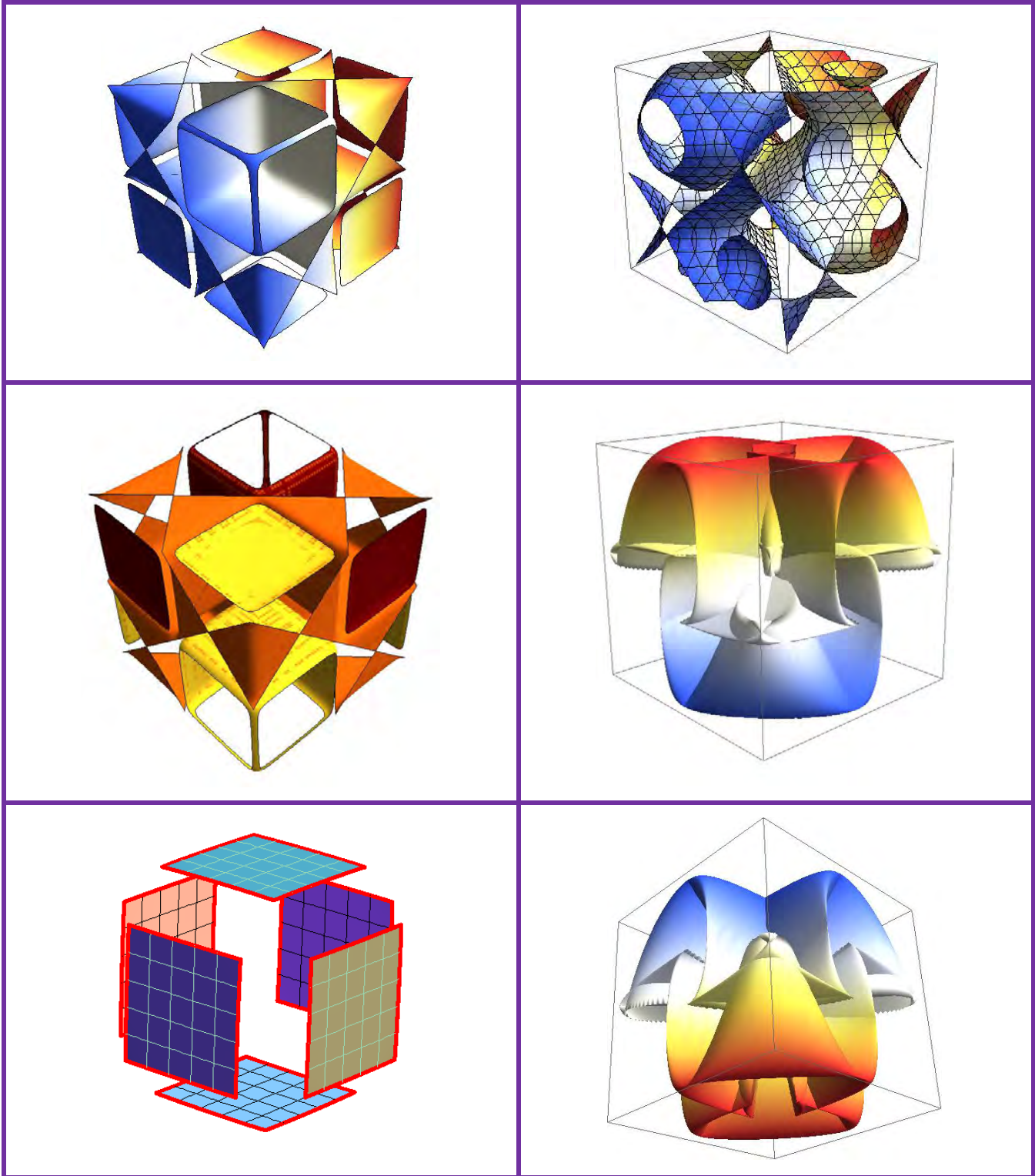

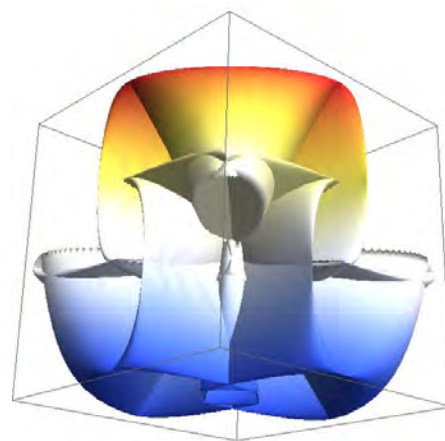
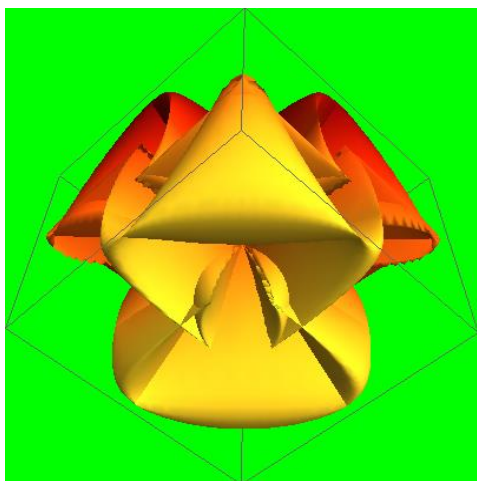
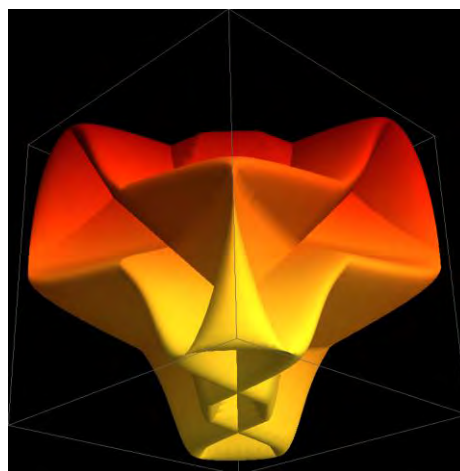
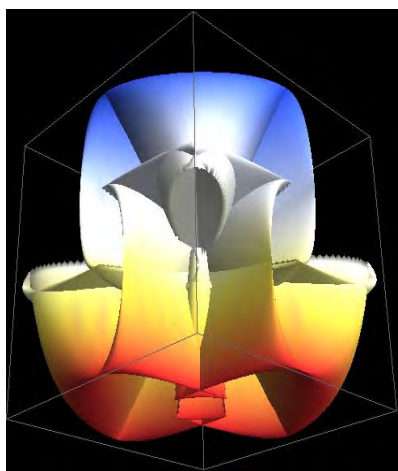
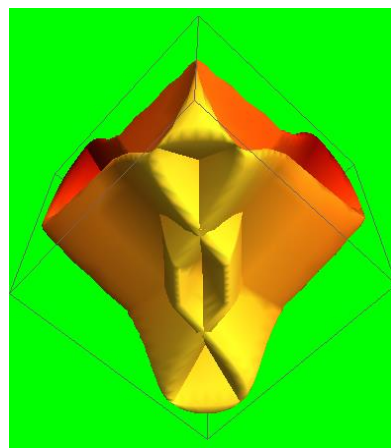
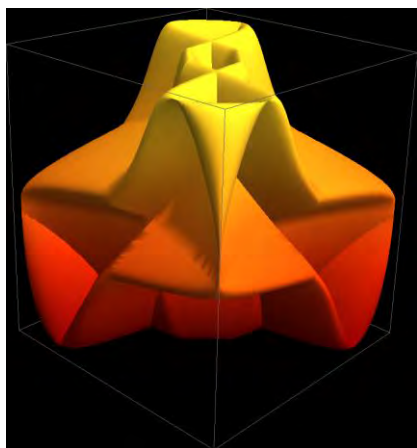



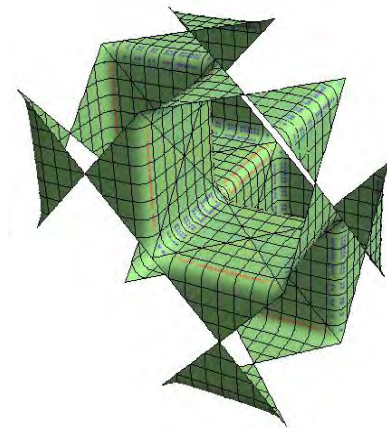
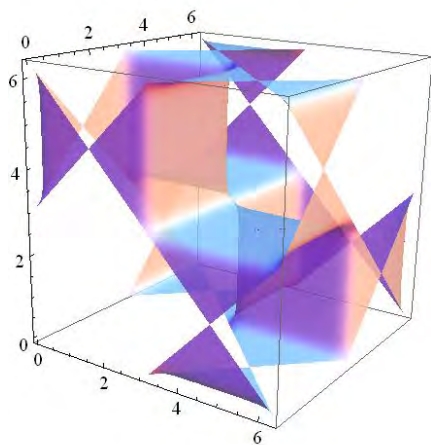
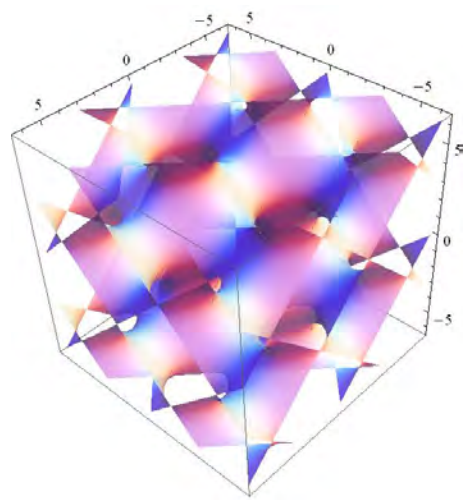
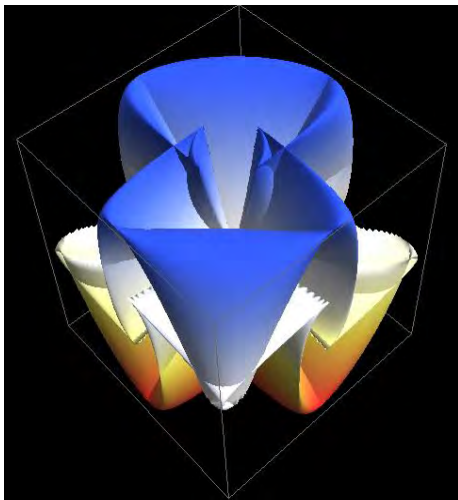
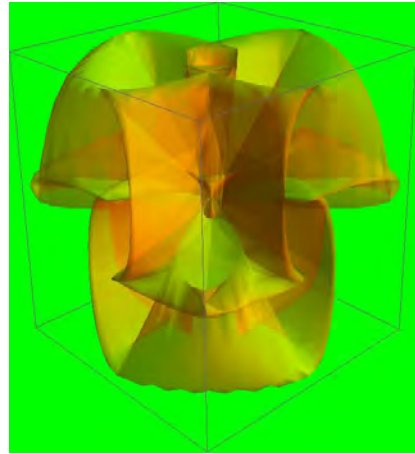
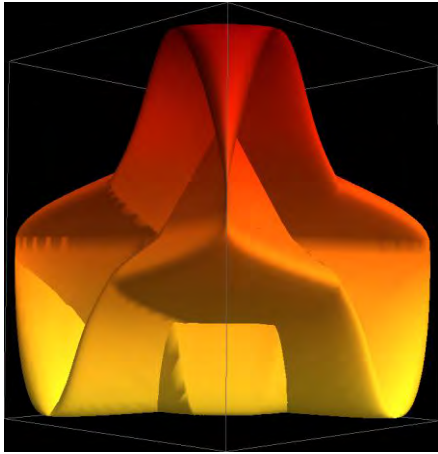

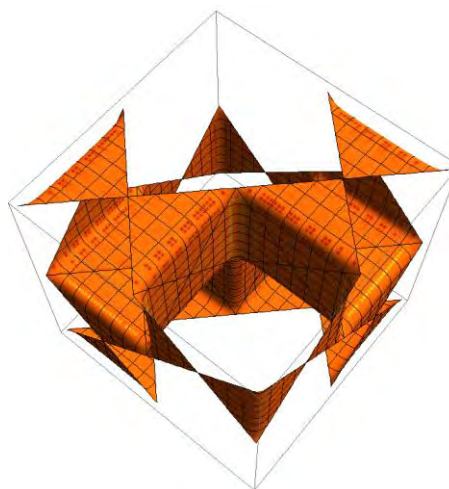
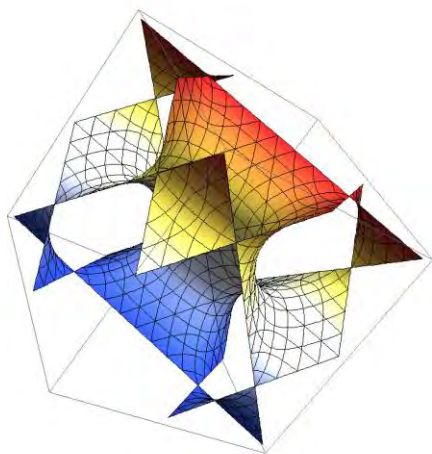
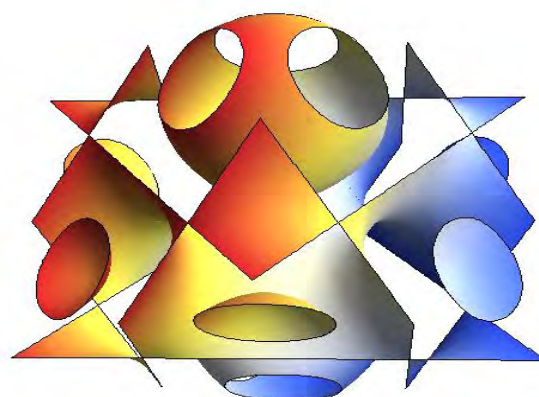
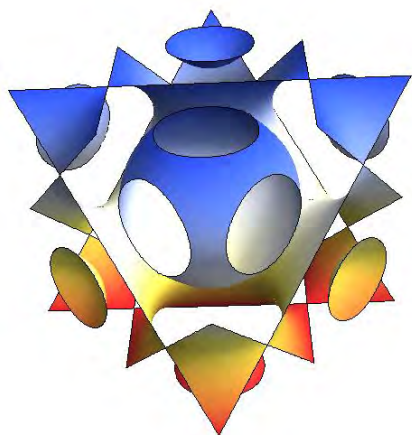
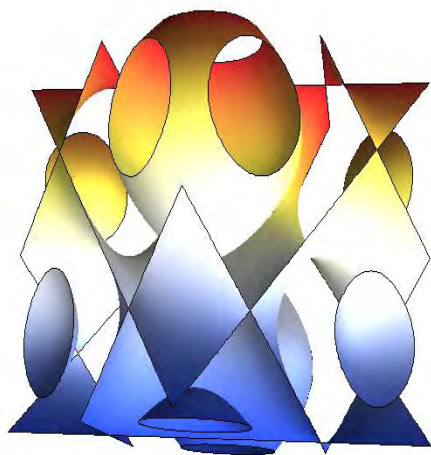



# SPHEROCUBES

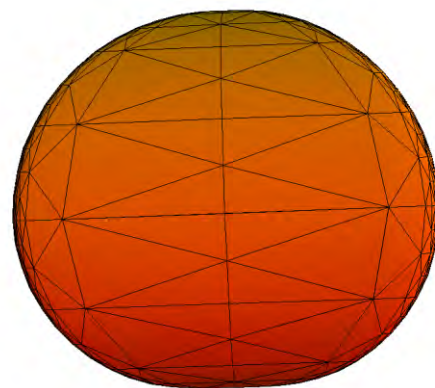
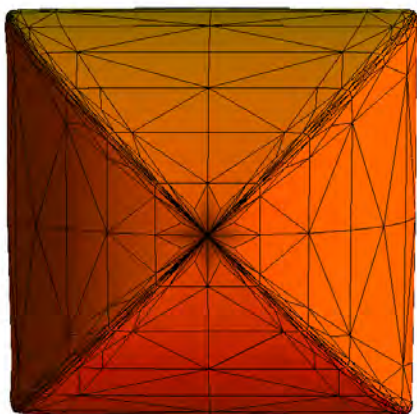
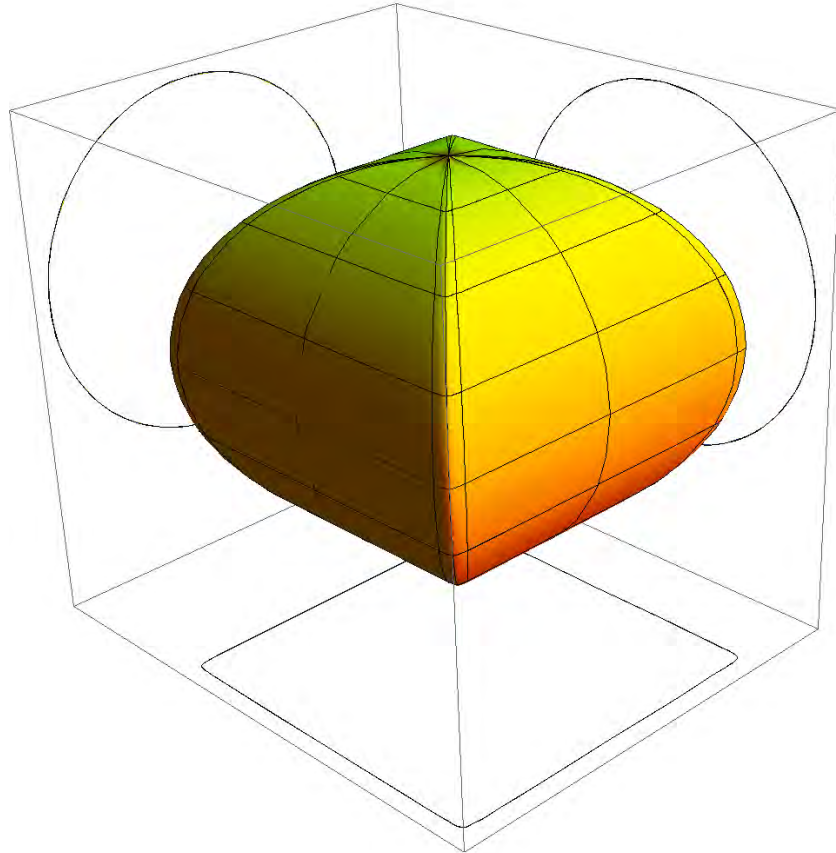

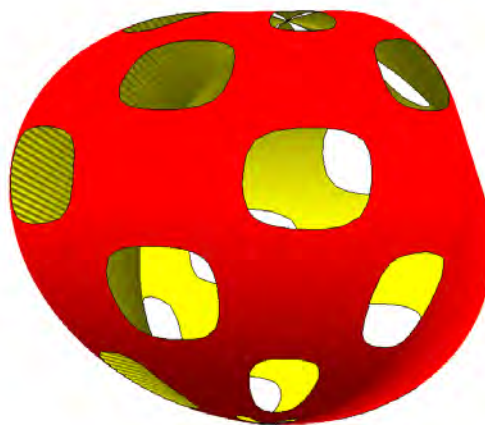
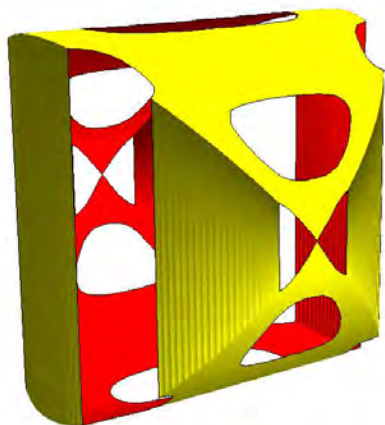
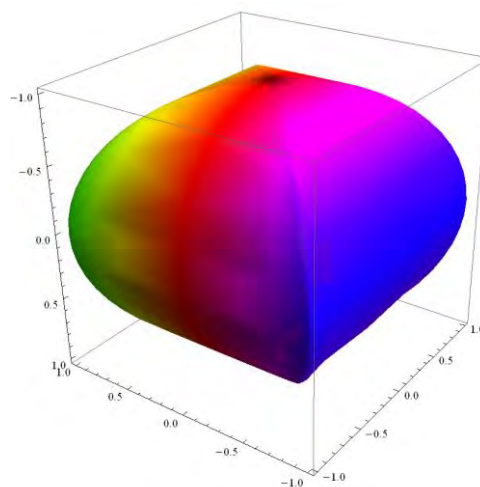
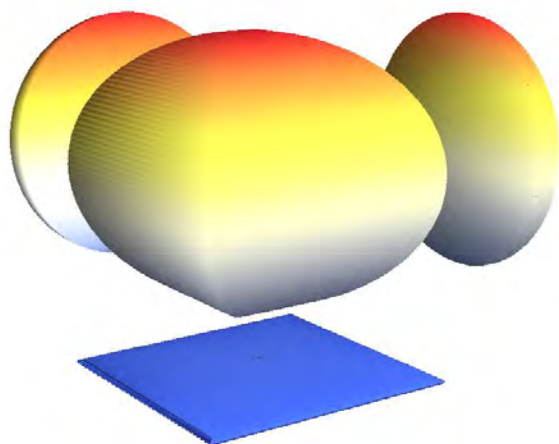
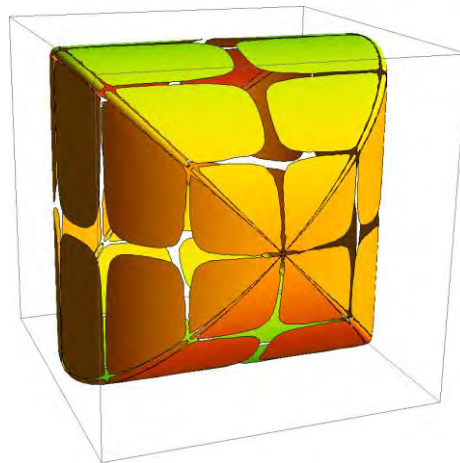
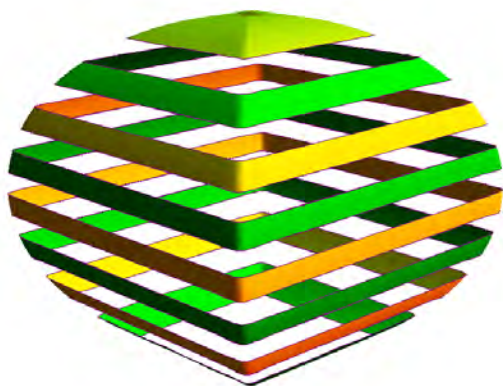

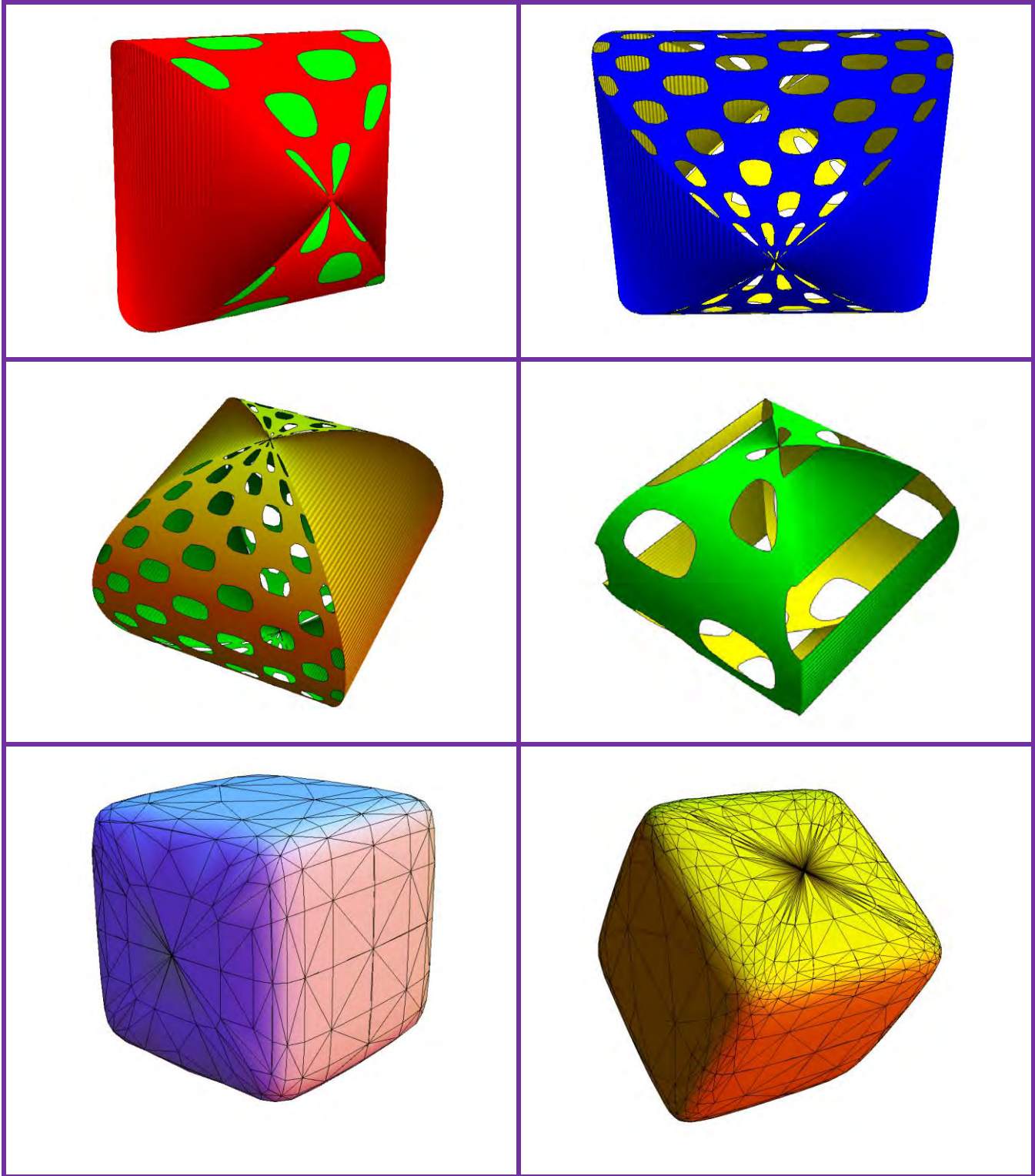



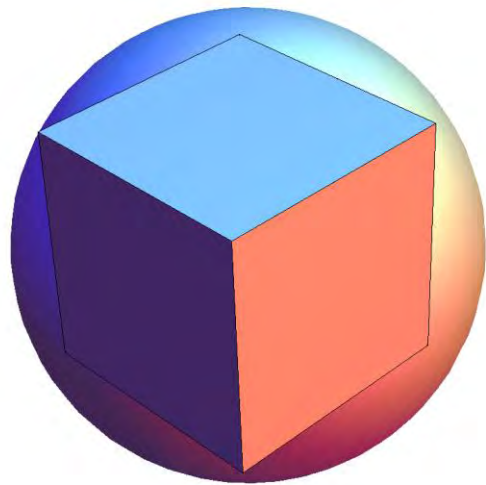
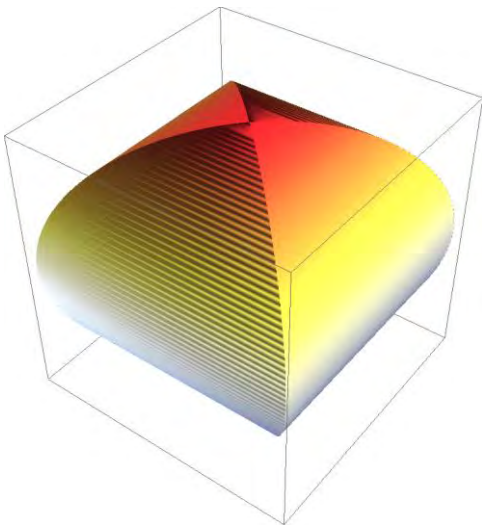
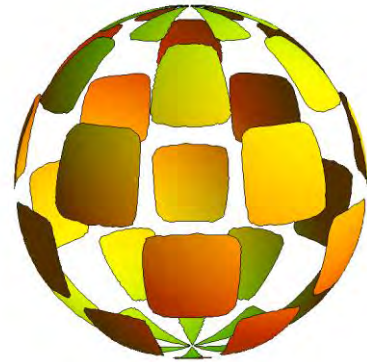
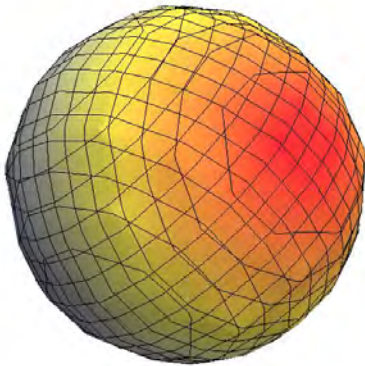
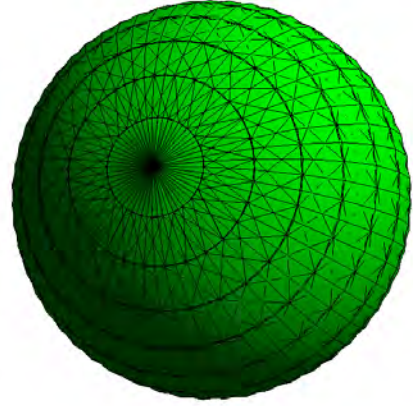
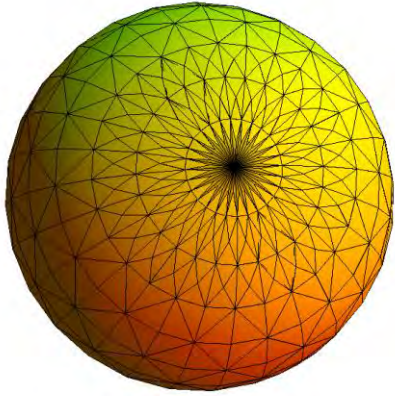

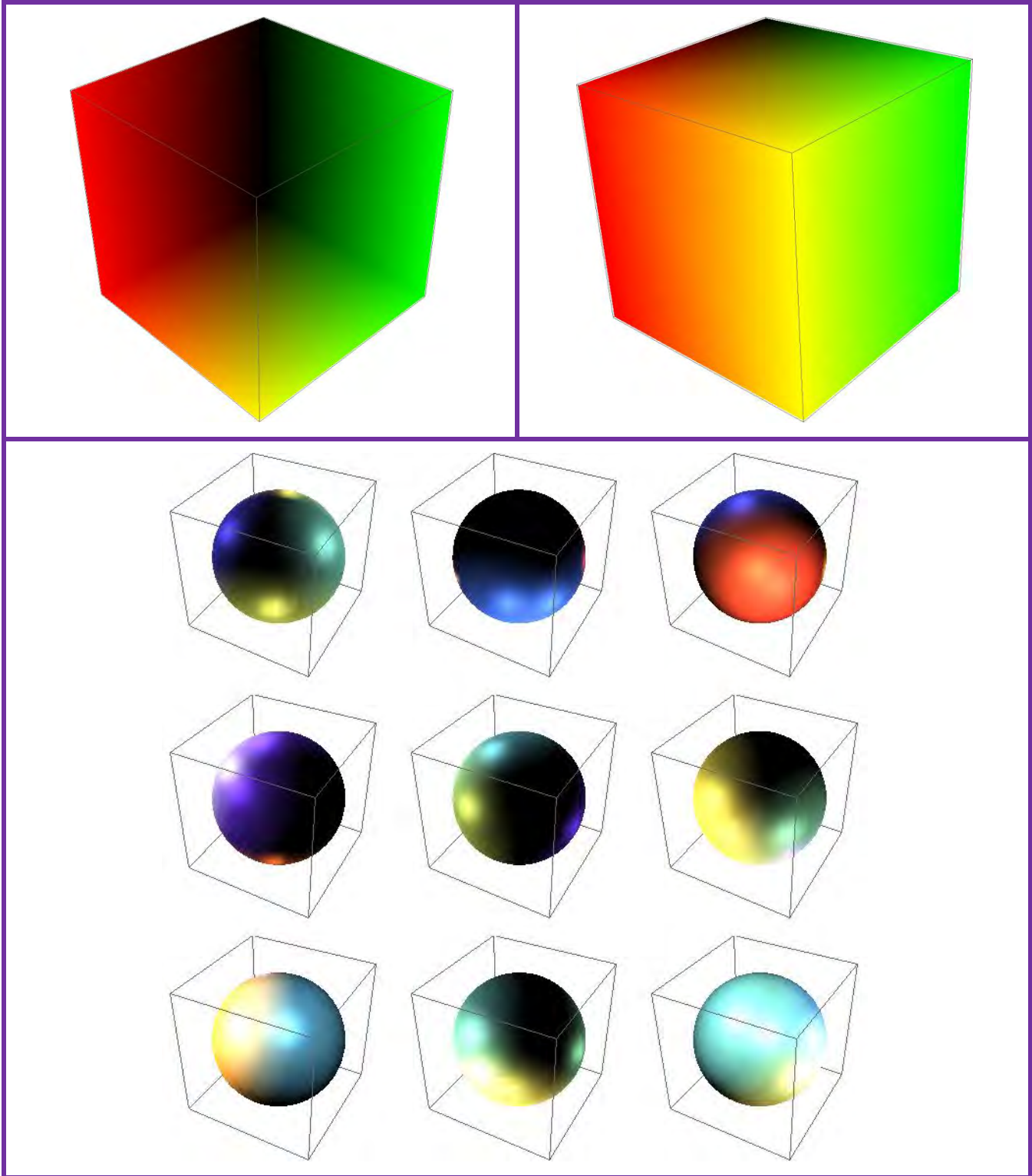



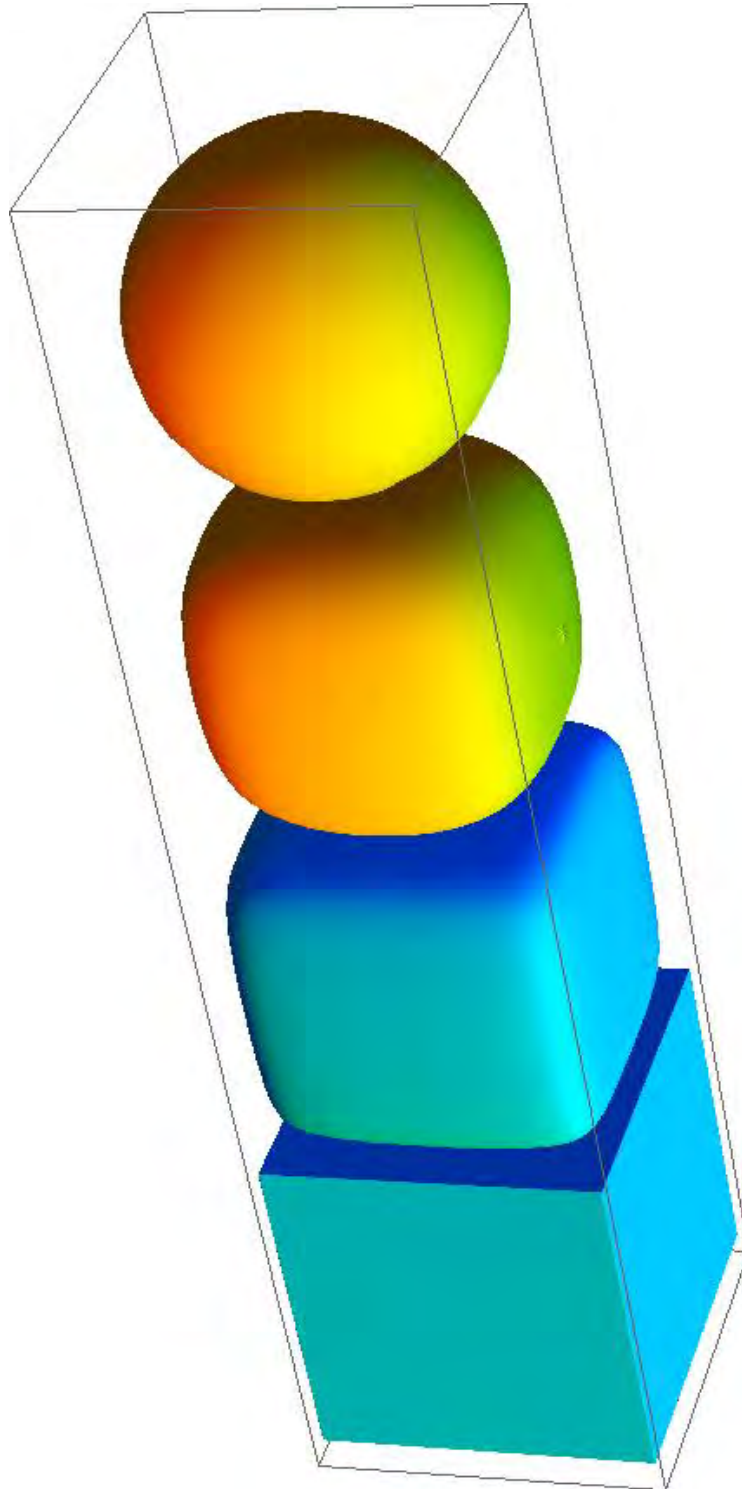

# GEOMETRY & SUPERMATHEMATICS

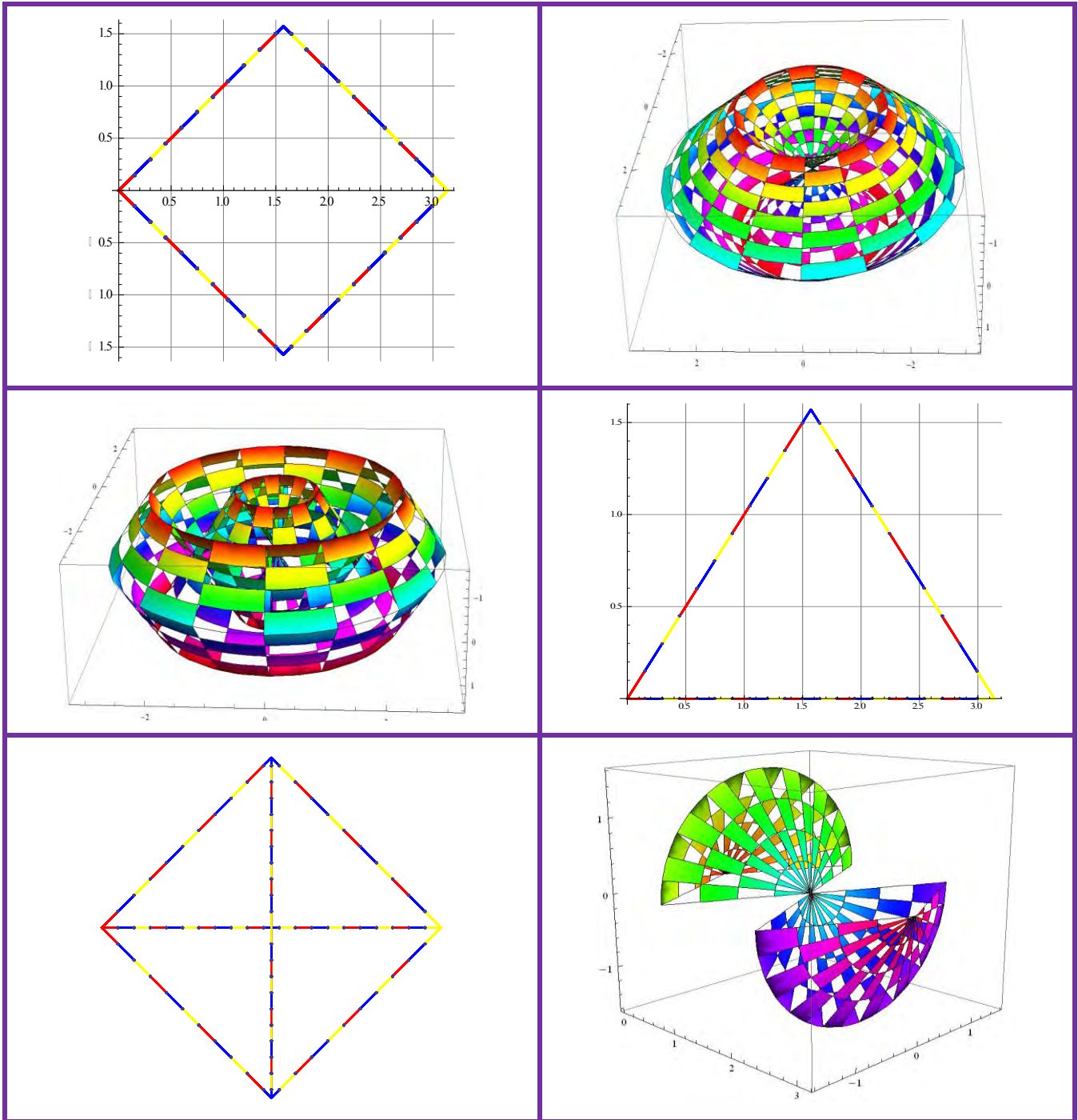

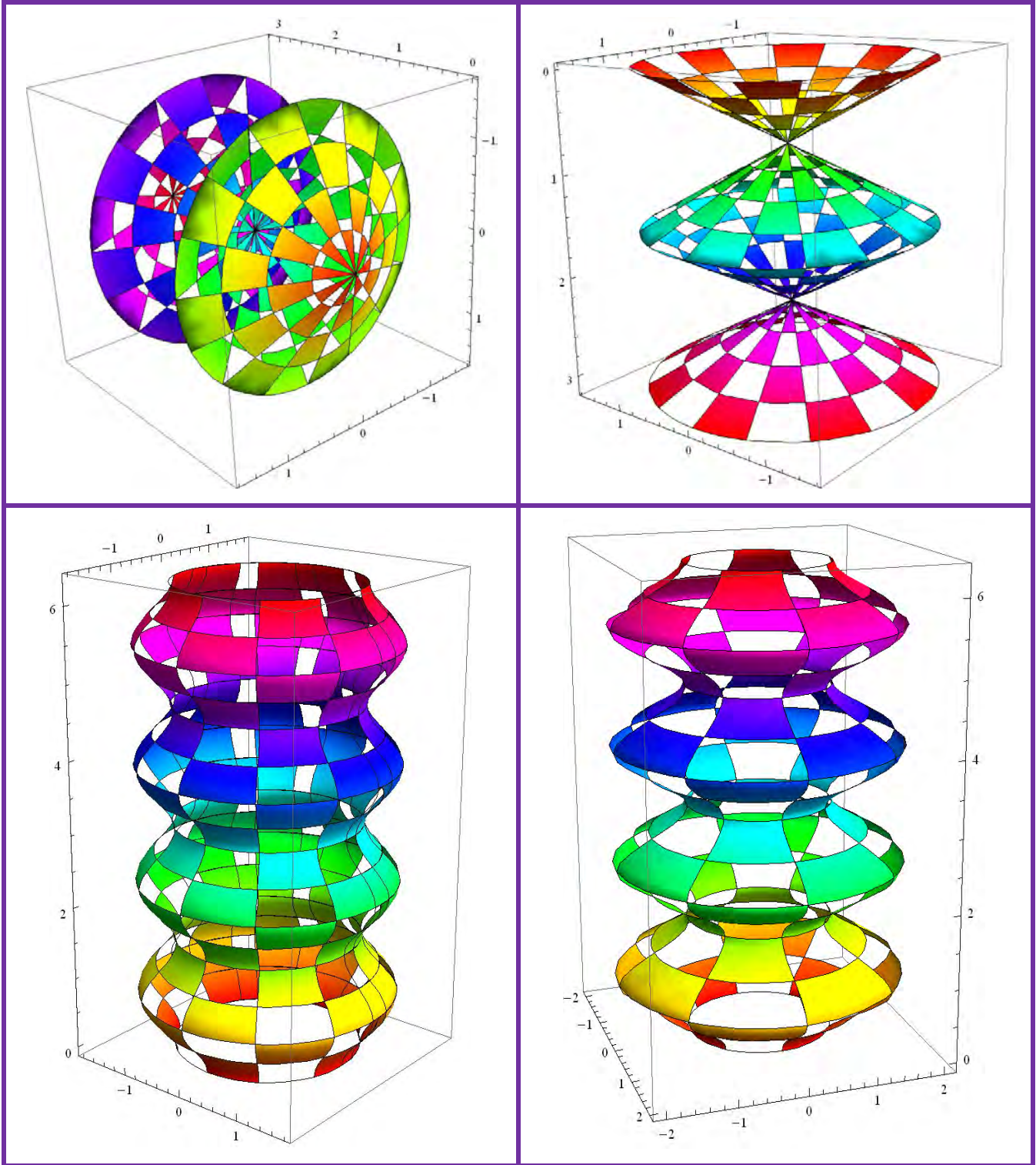



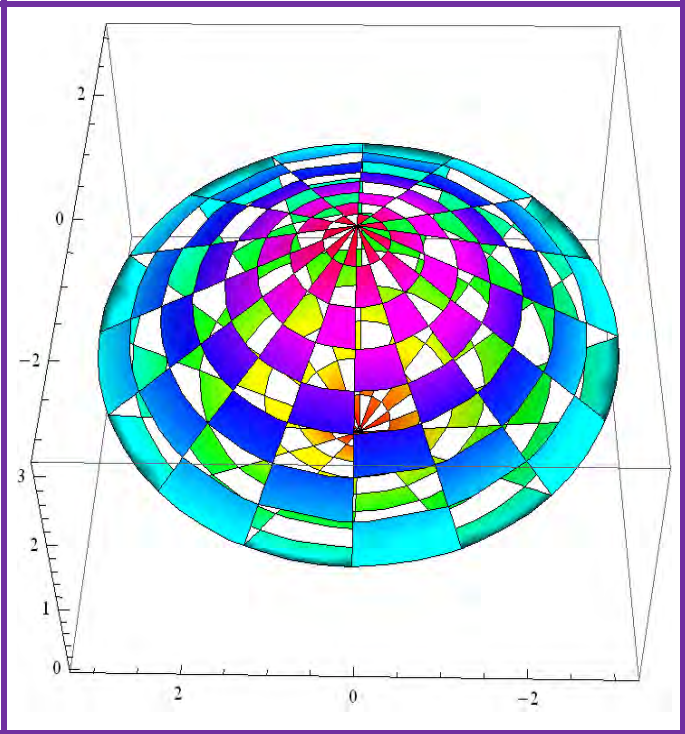
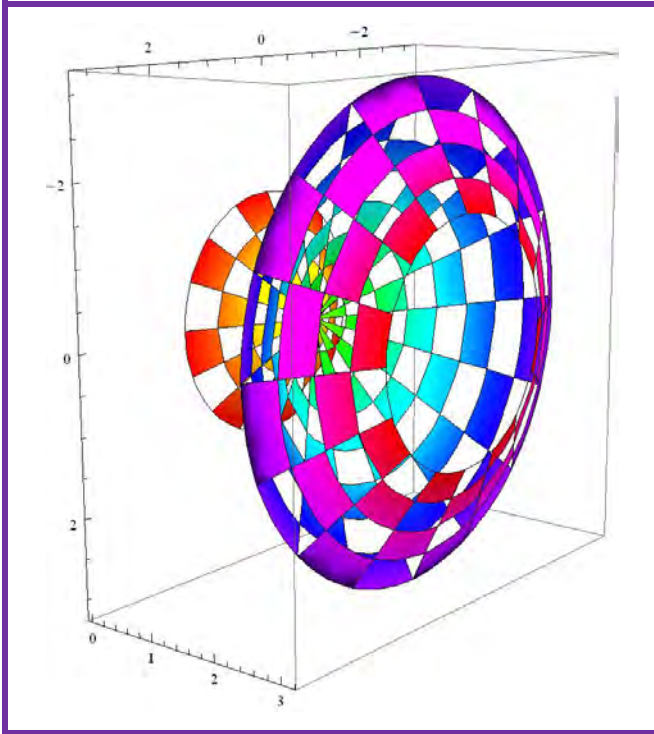
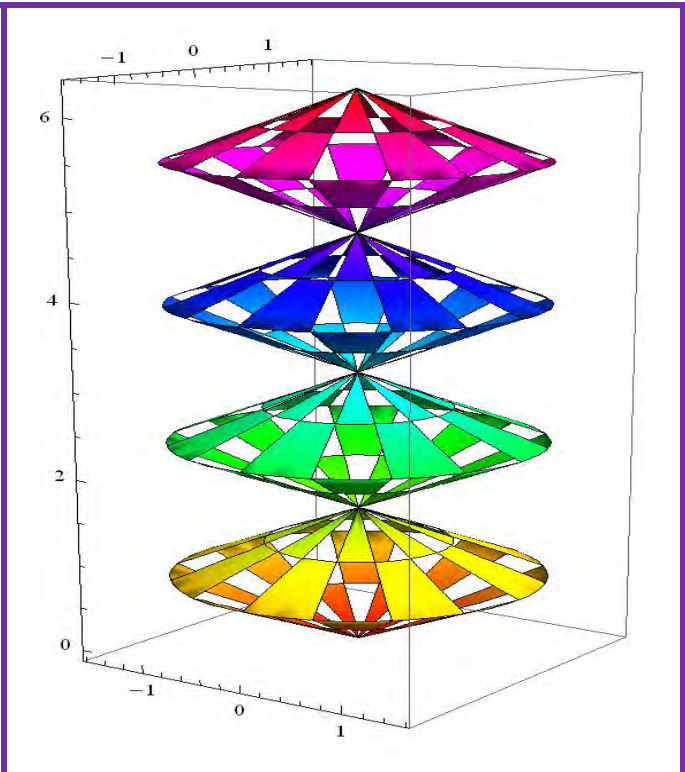
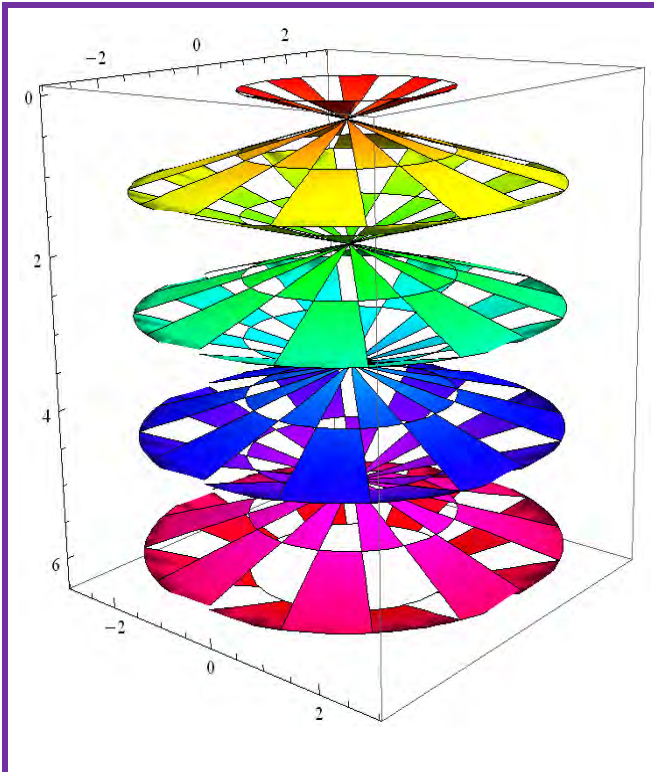

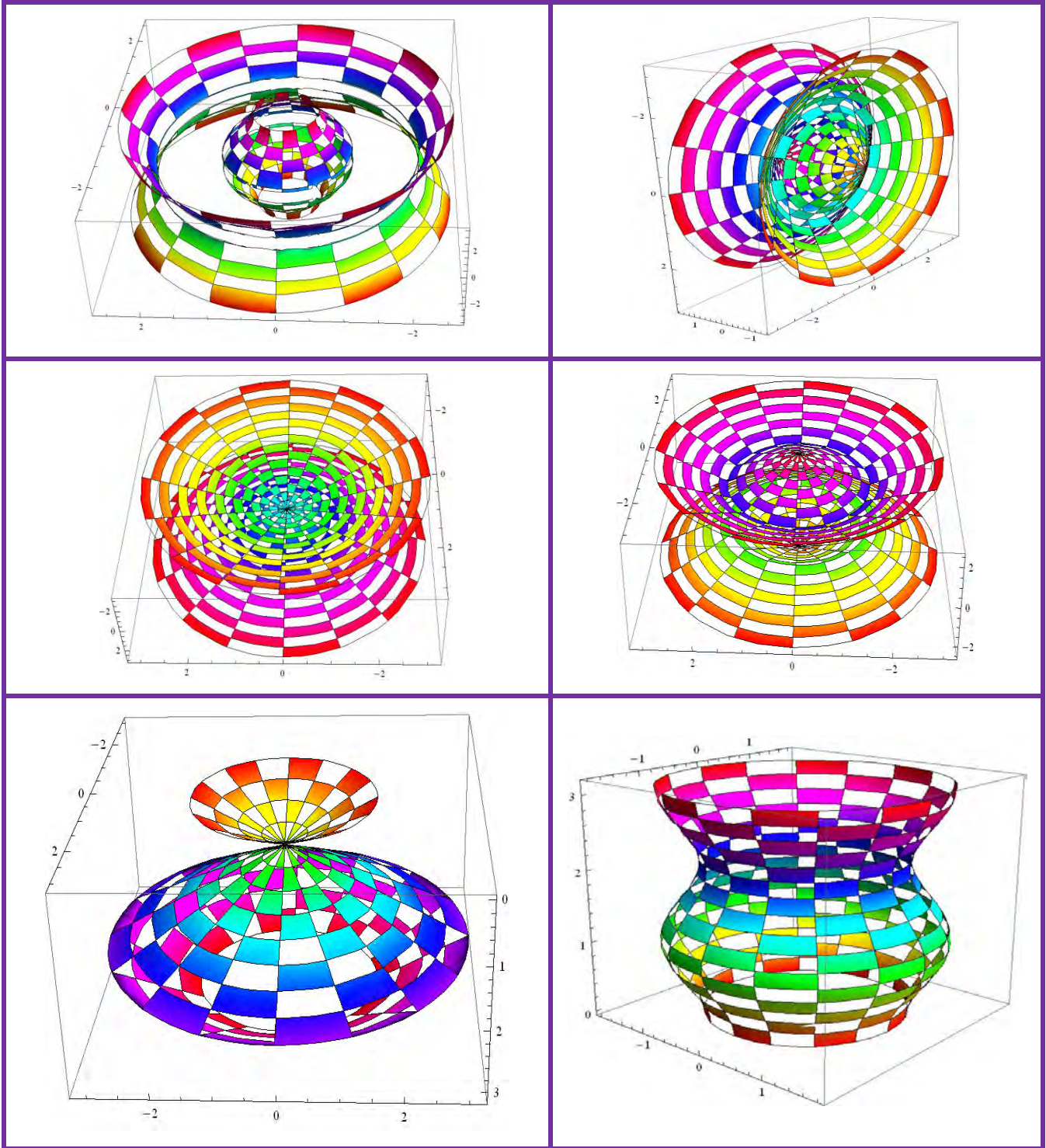



# CHROMATIC

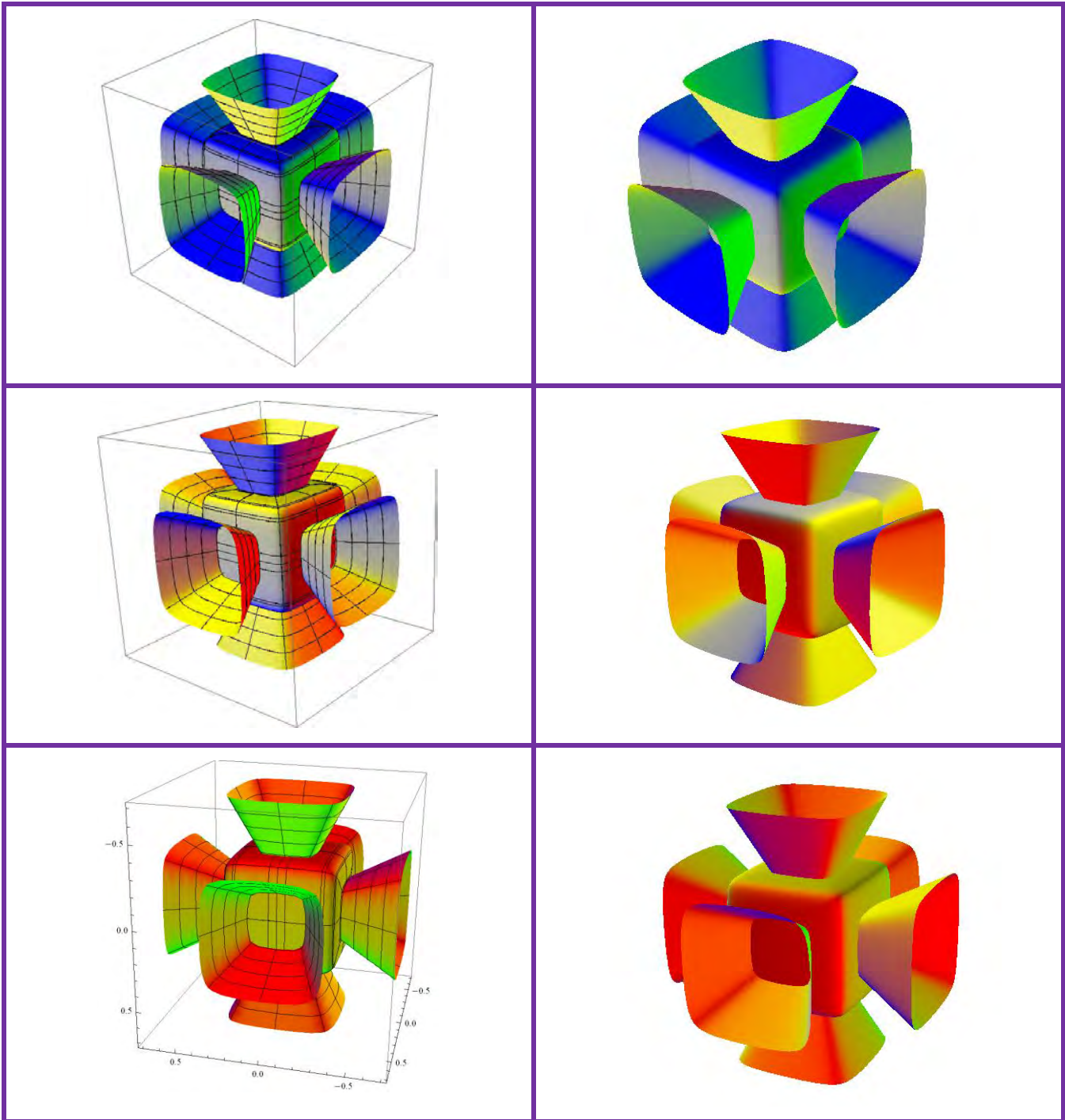

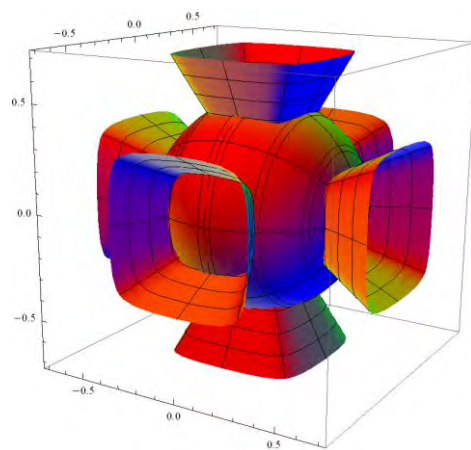
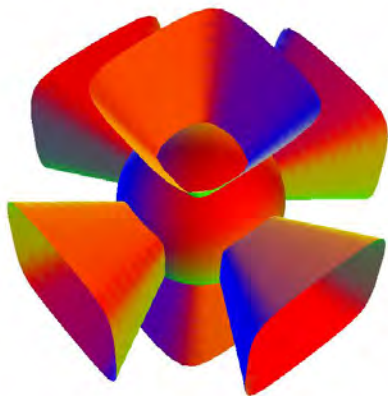
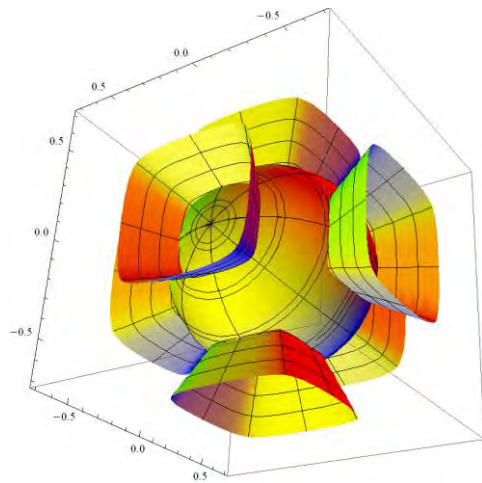
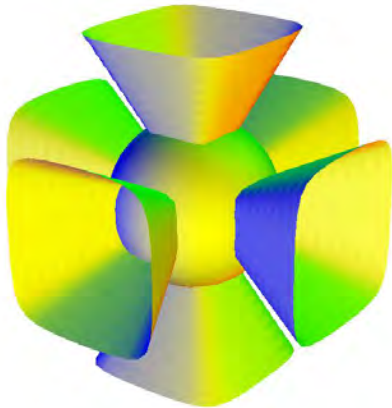
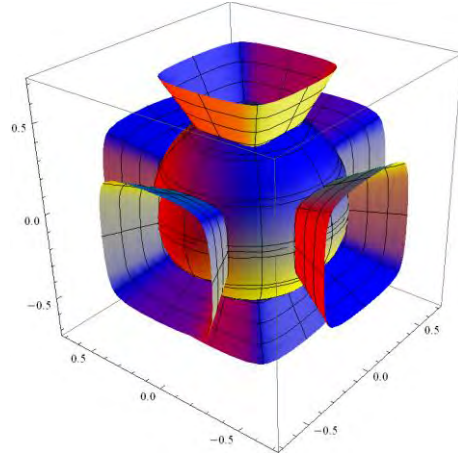
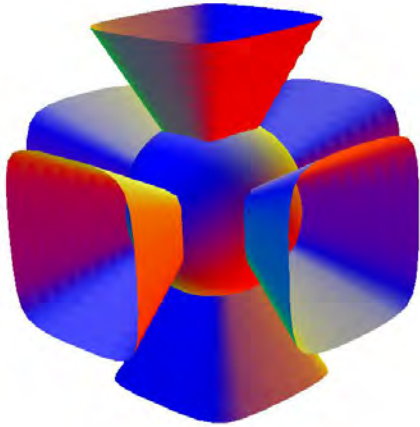

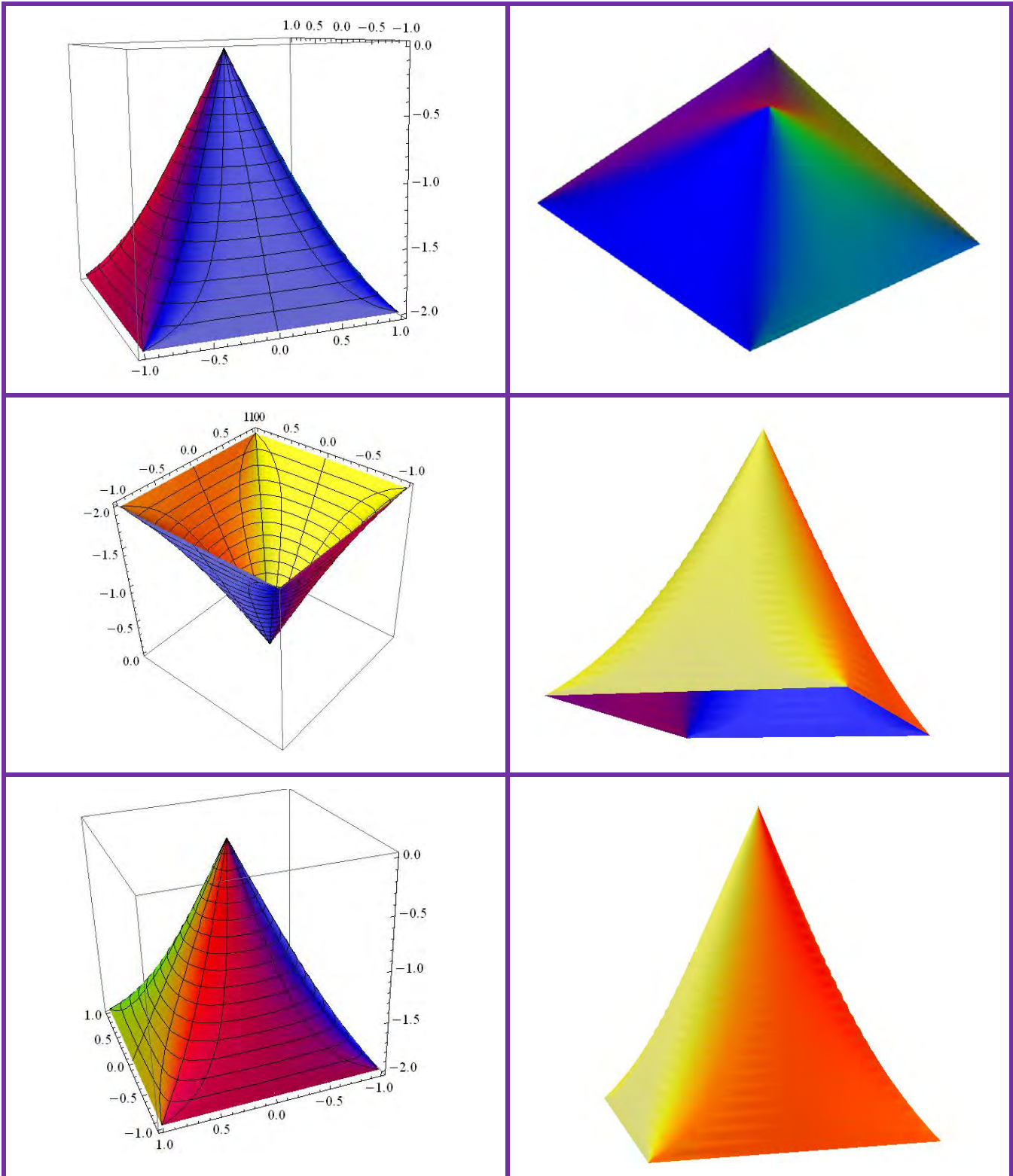



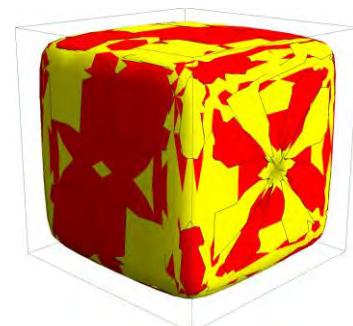
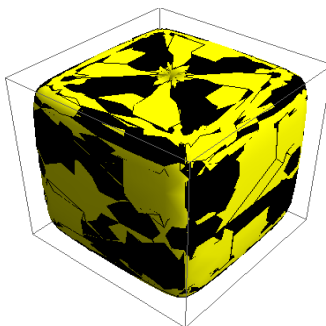
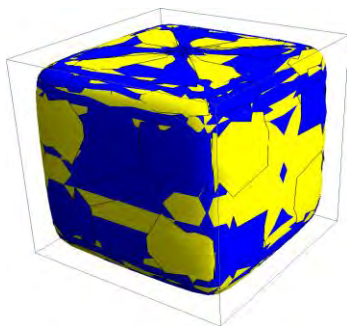
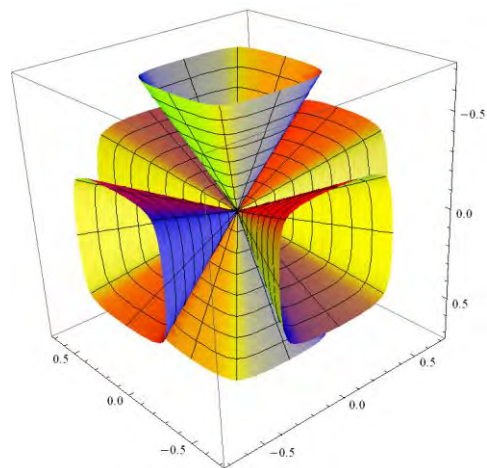
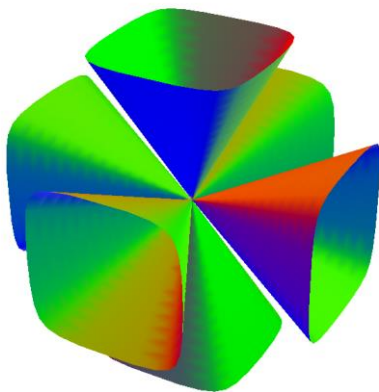
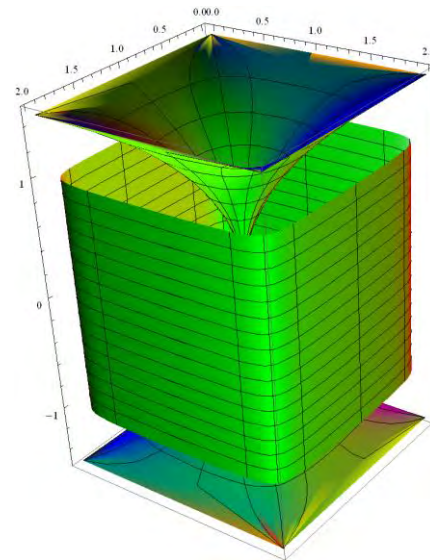
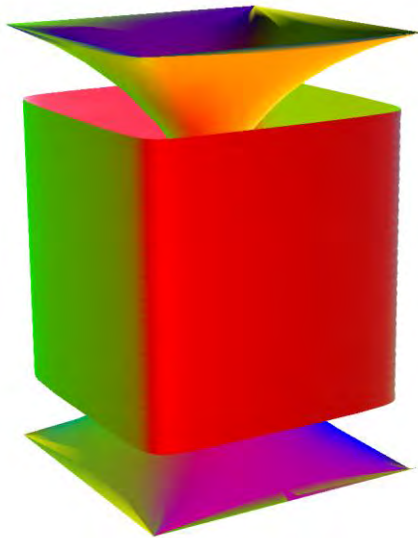

# SM OBJECTS IN 3D GEOMETRY

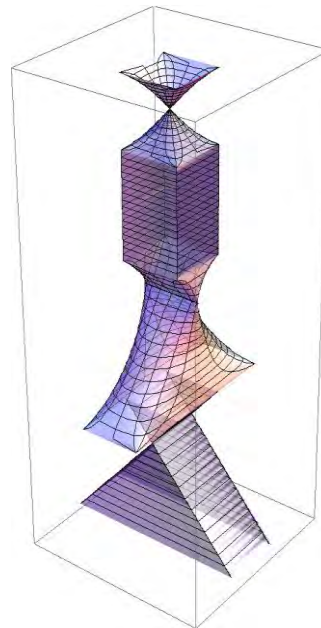
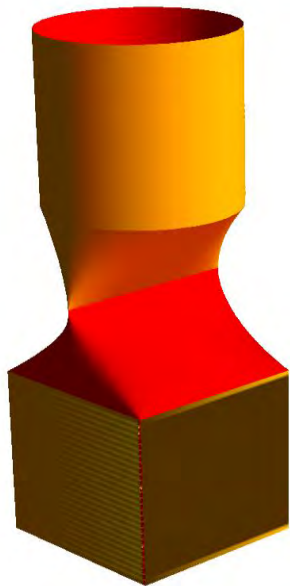
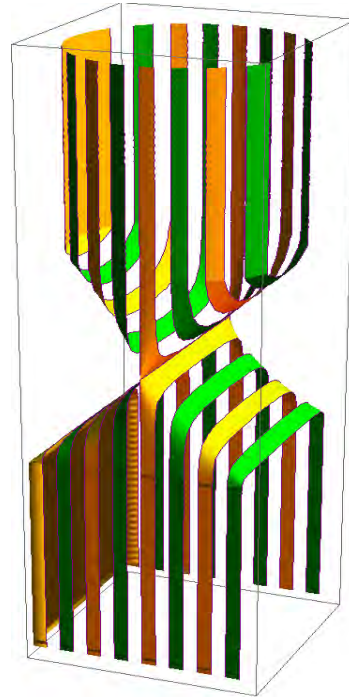
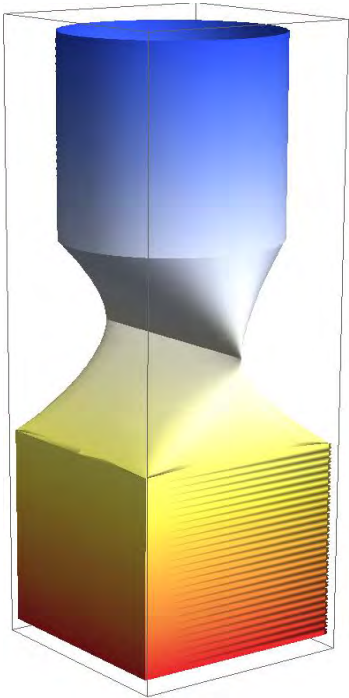



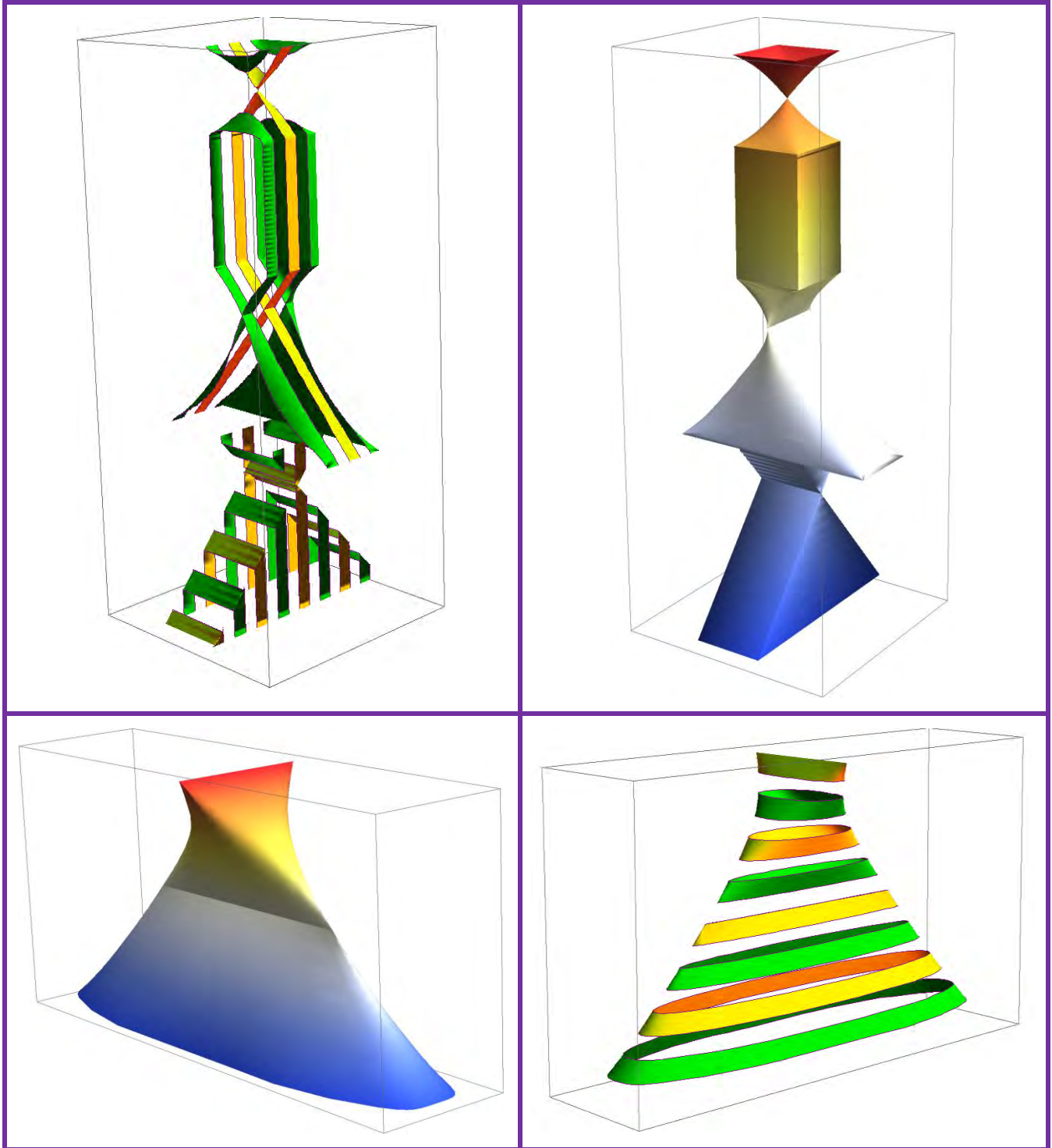

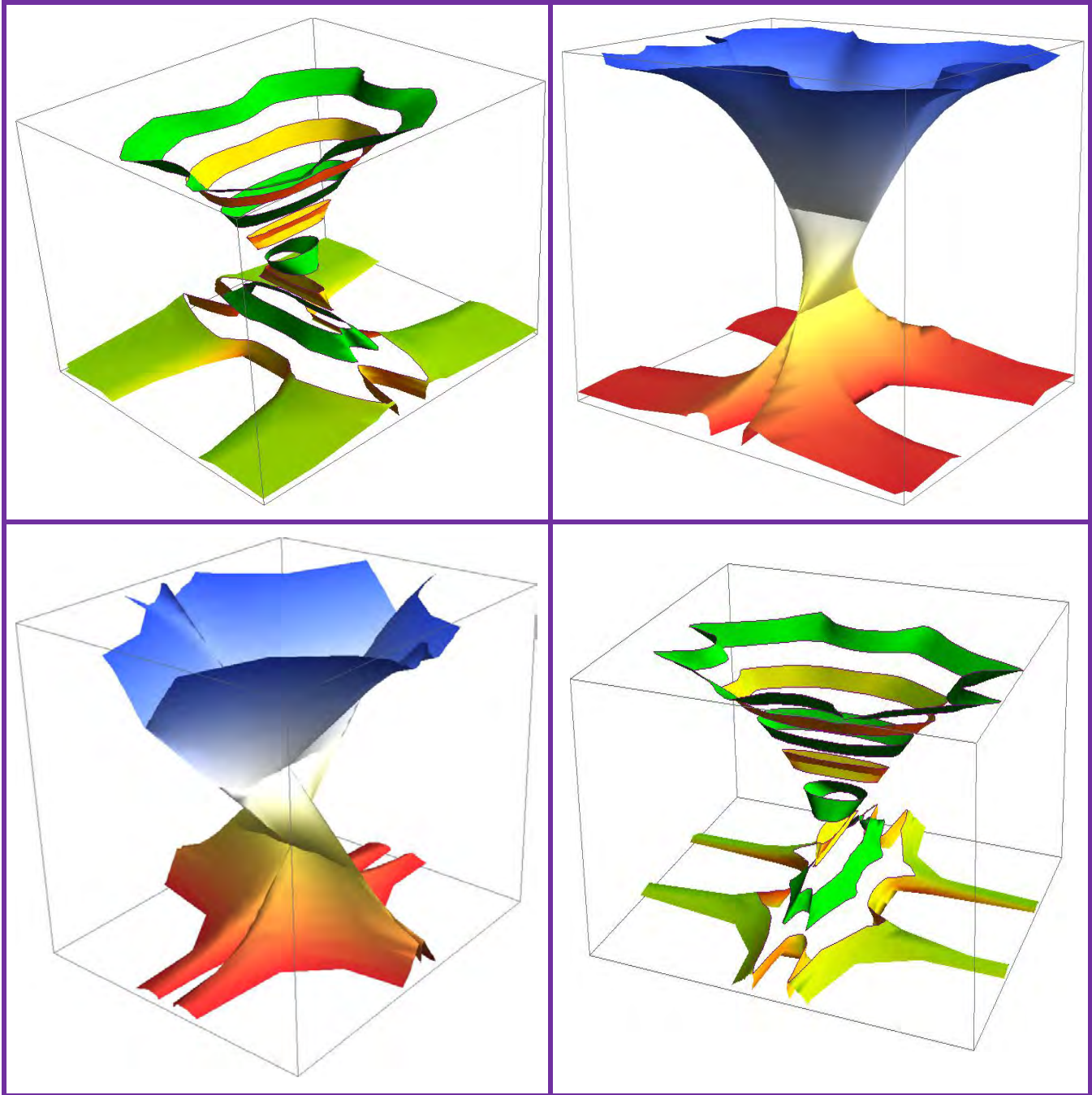

## SM VASES &amp; COLUMNS

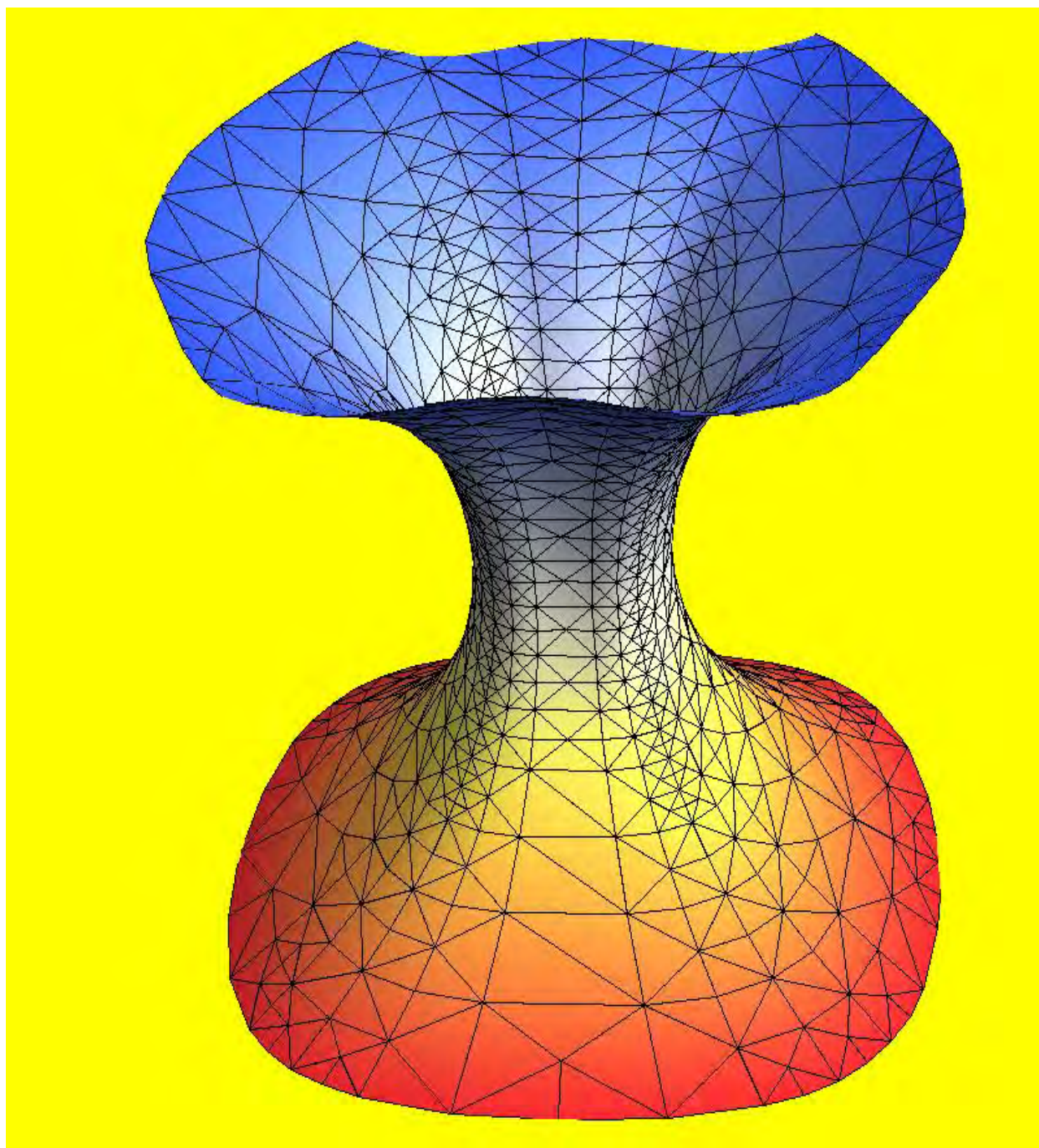



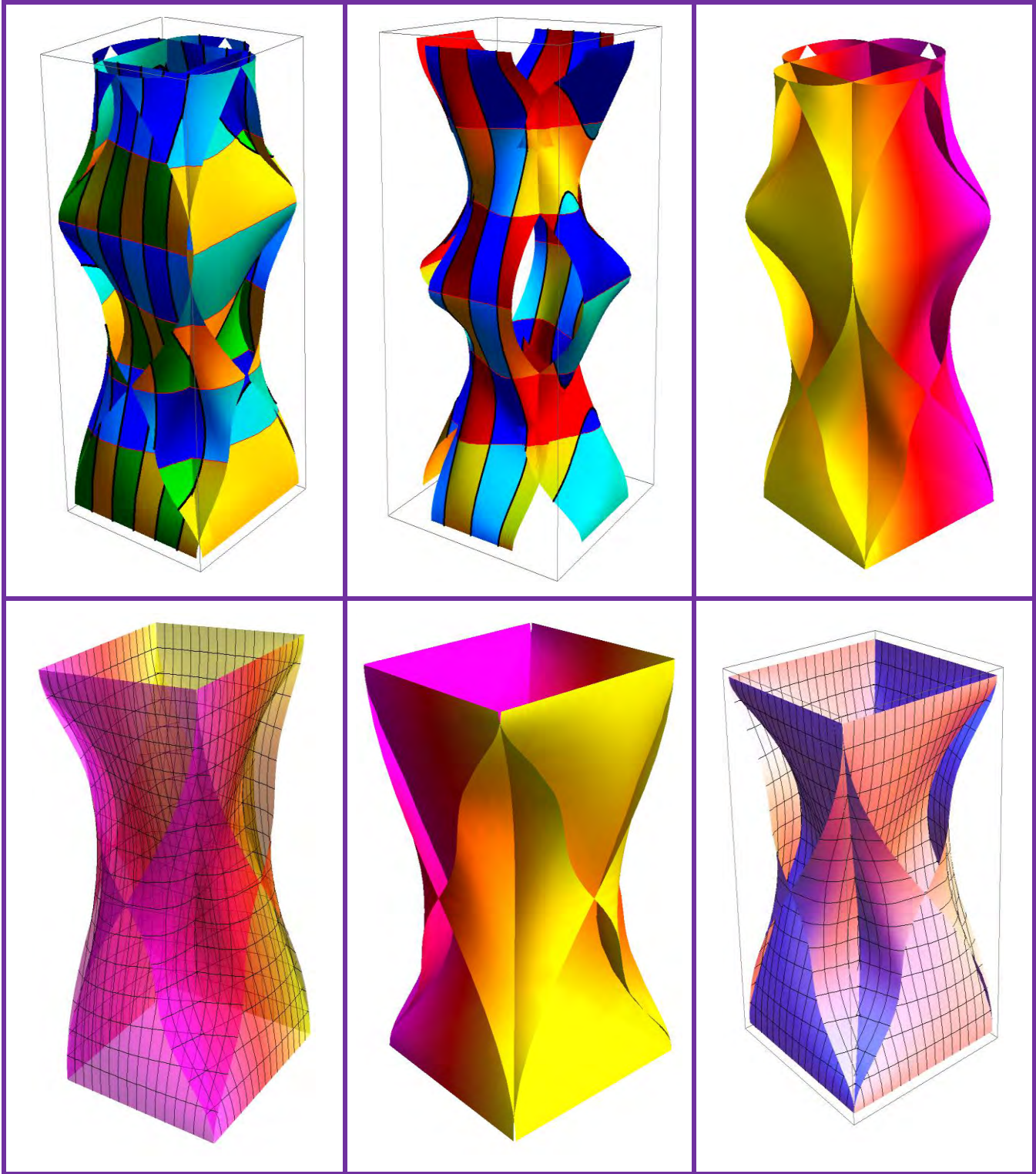



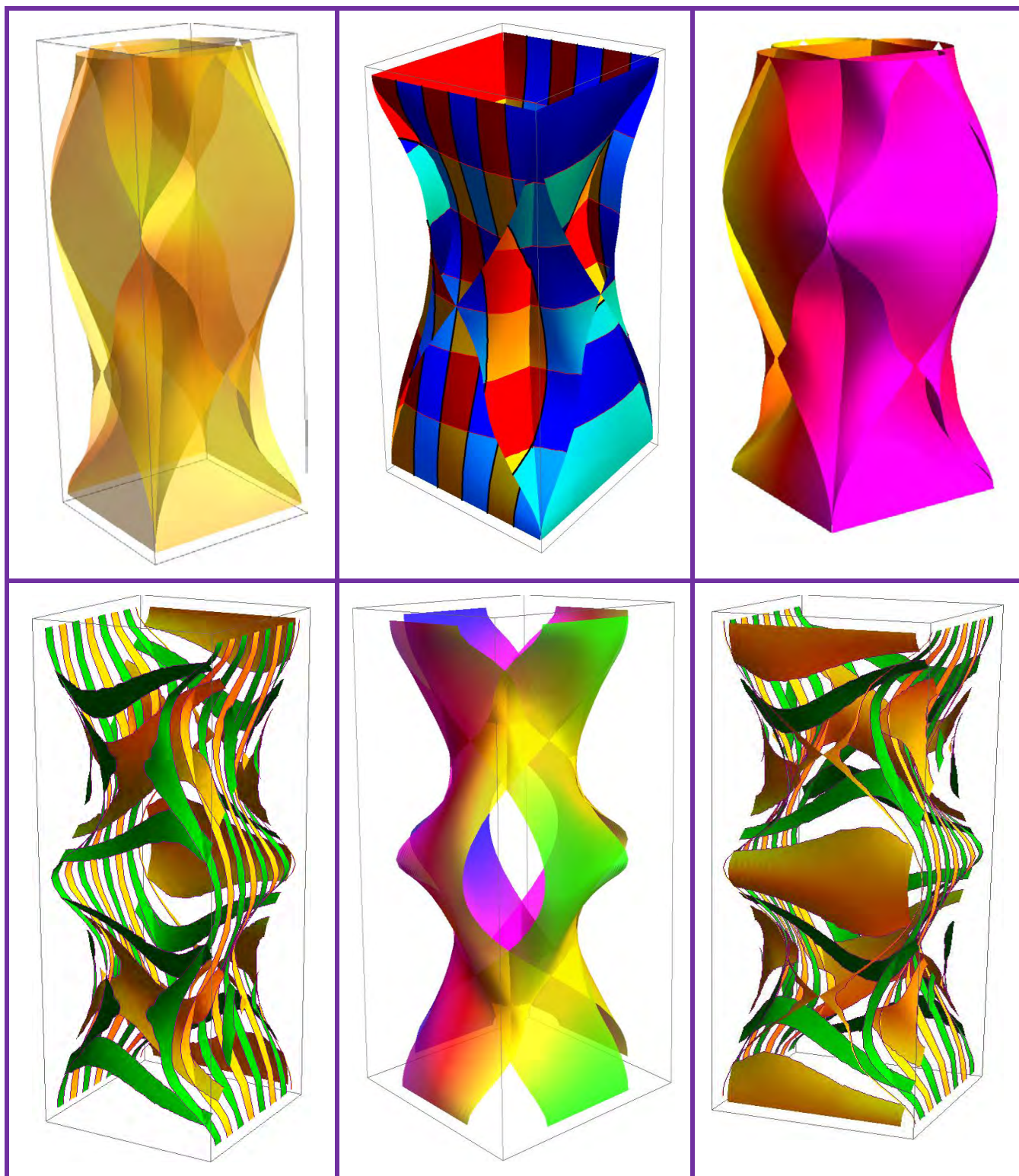

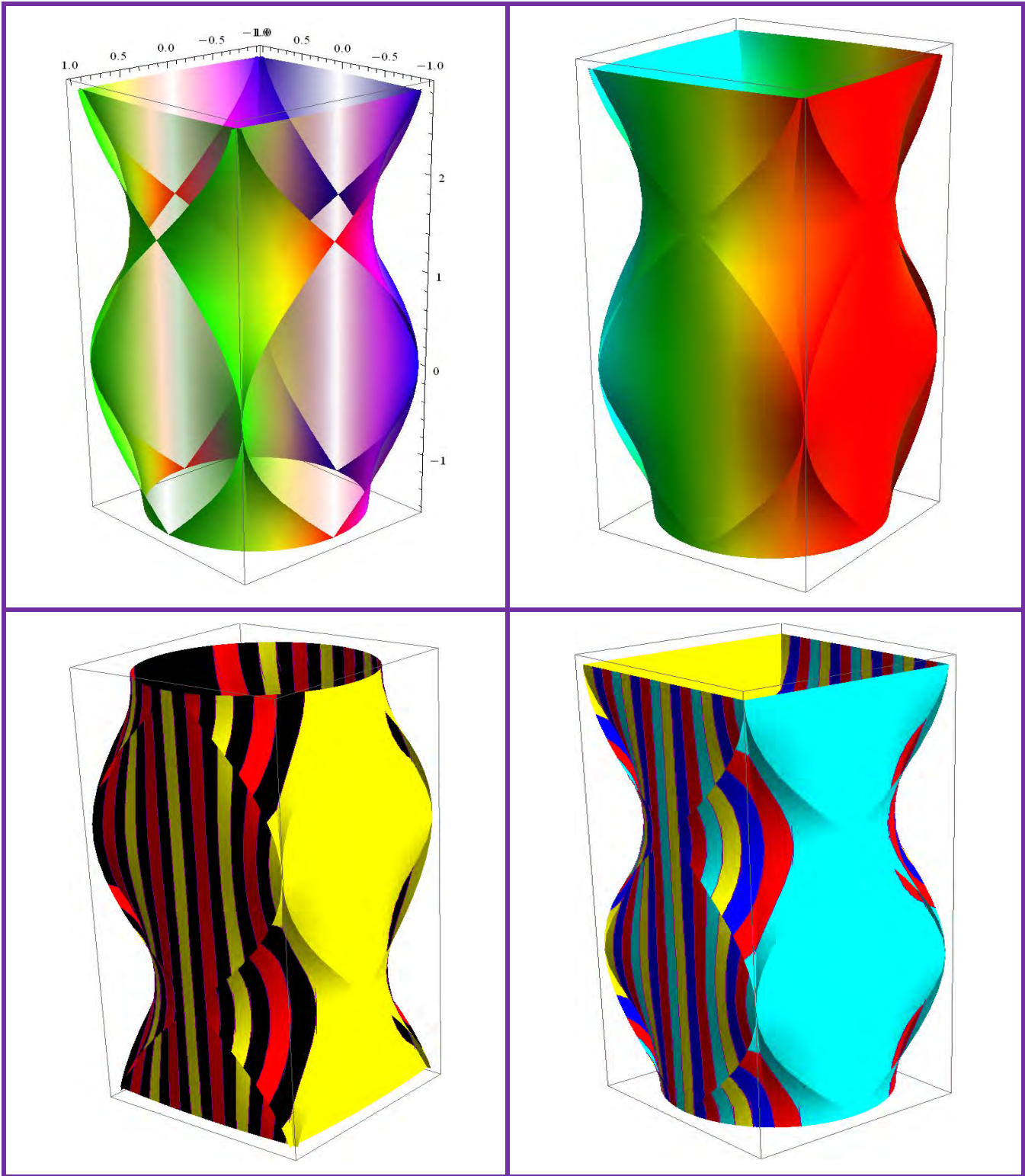



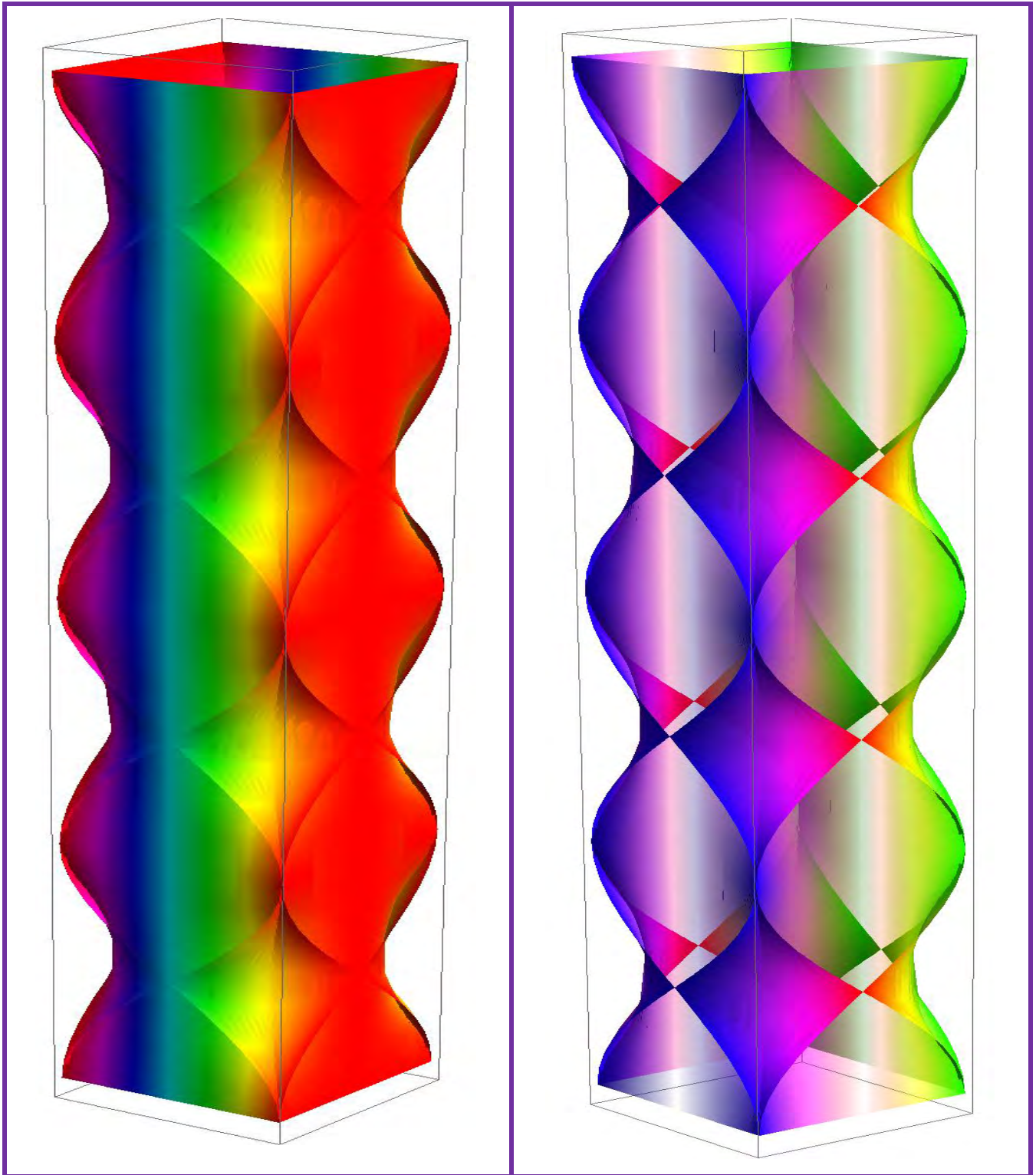

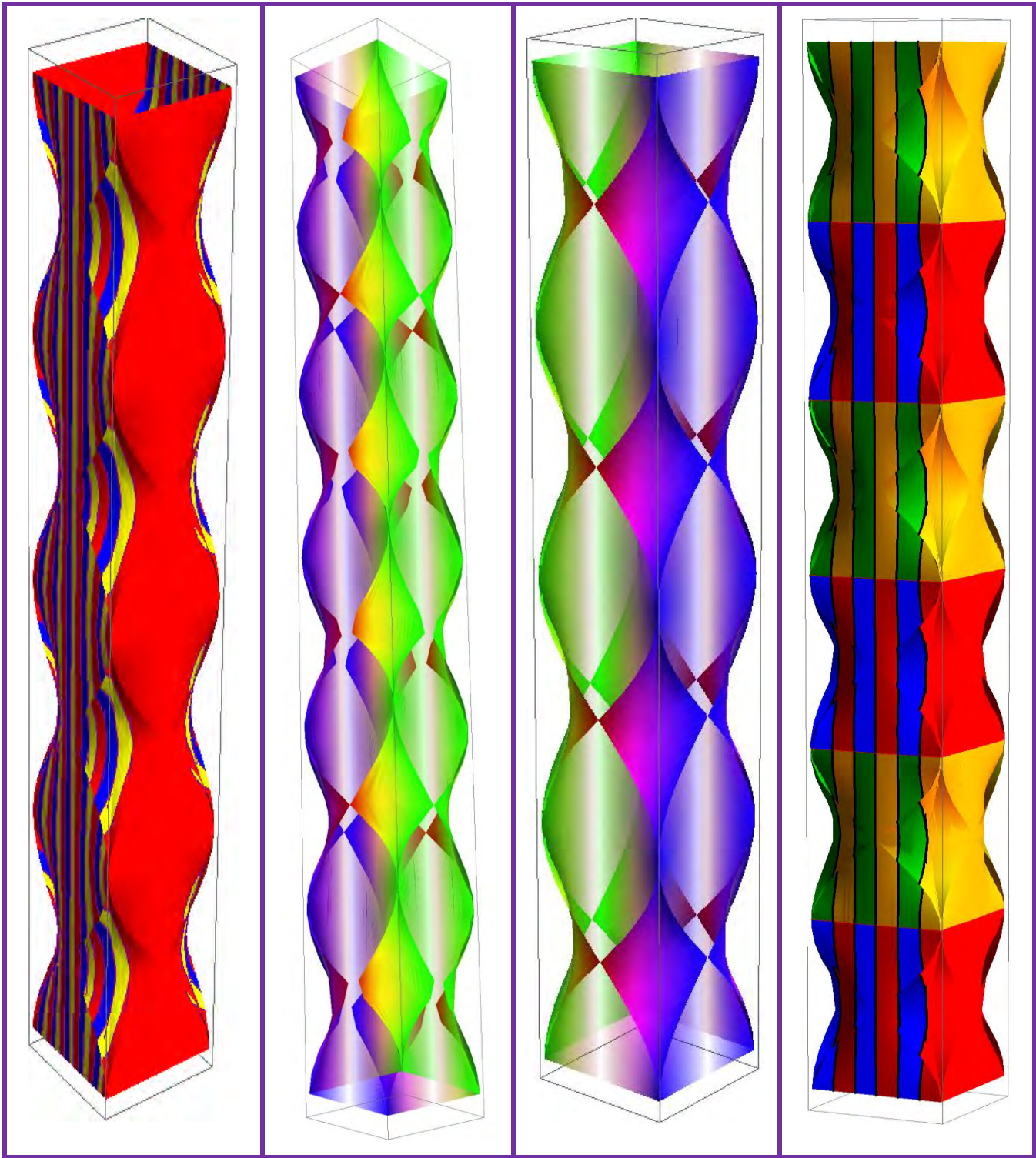



## GOBLETS &amp; GLASSES

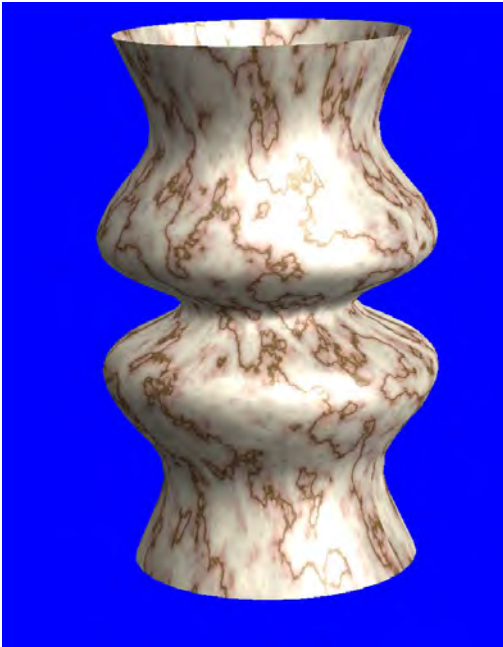

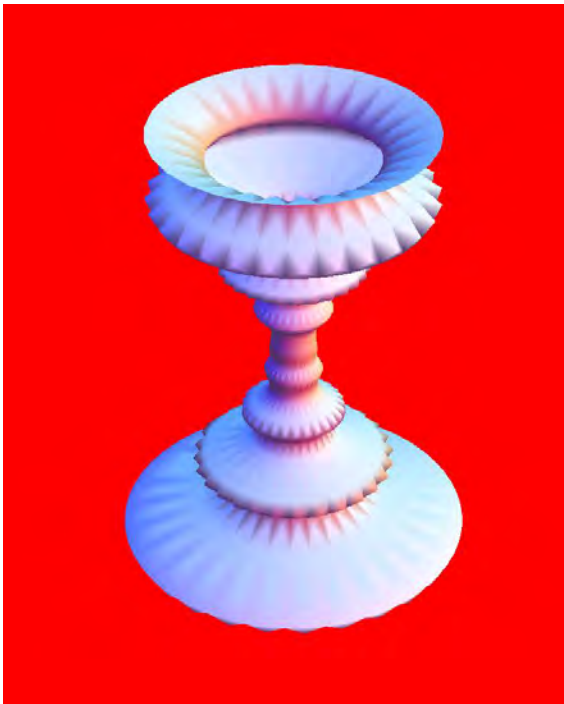
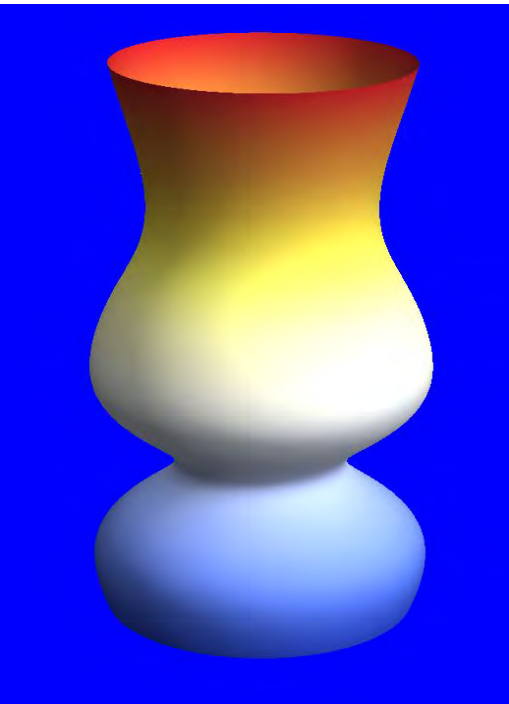

## EX-CENTRIC SPIRALS

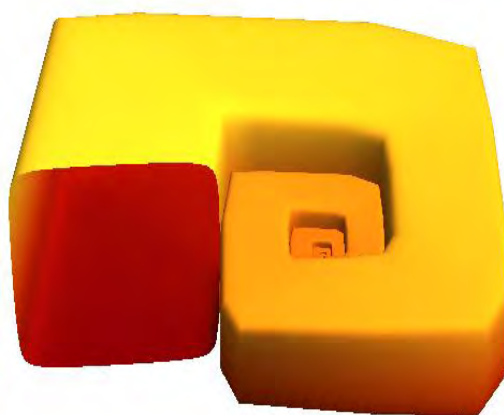
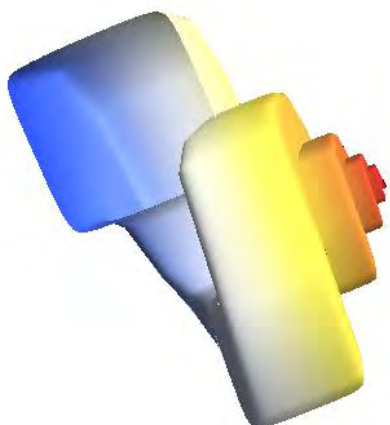
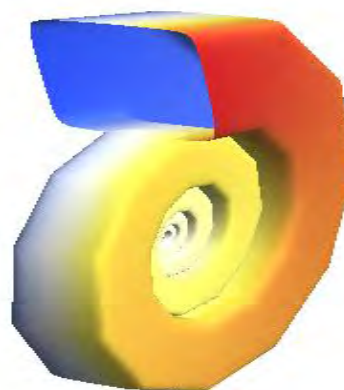
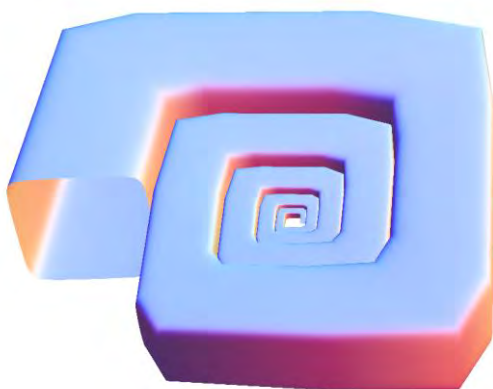
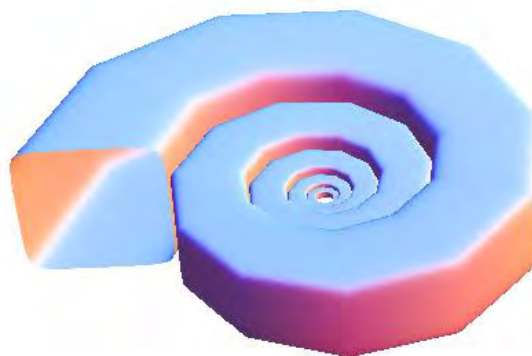
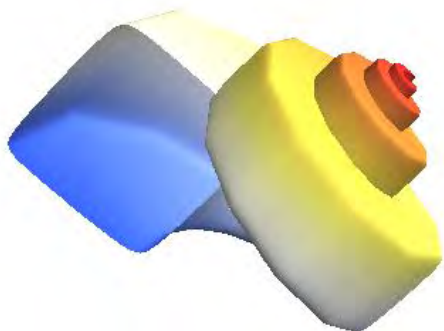

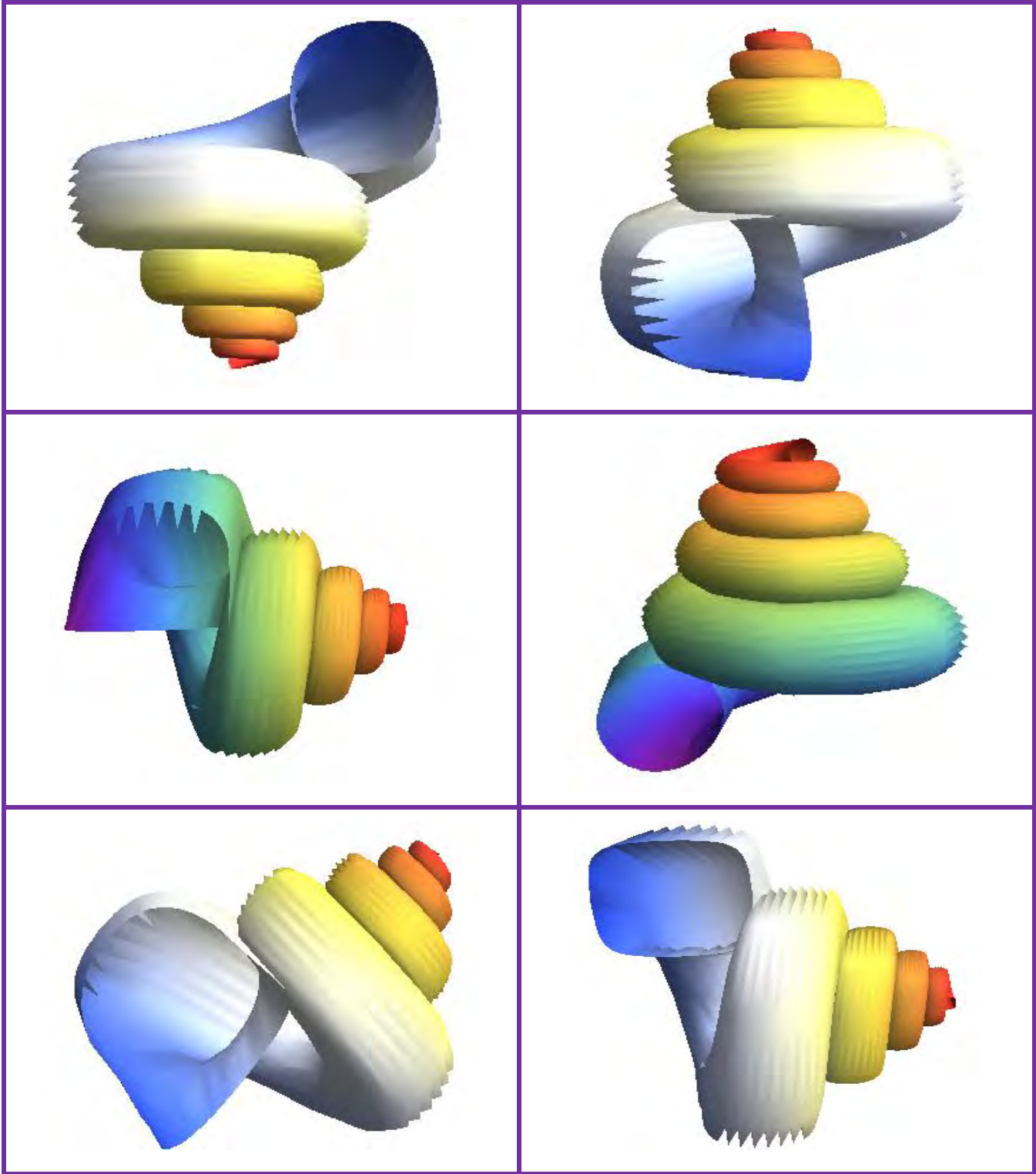



## CHINESE LAMPIONS

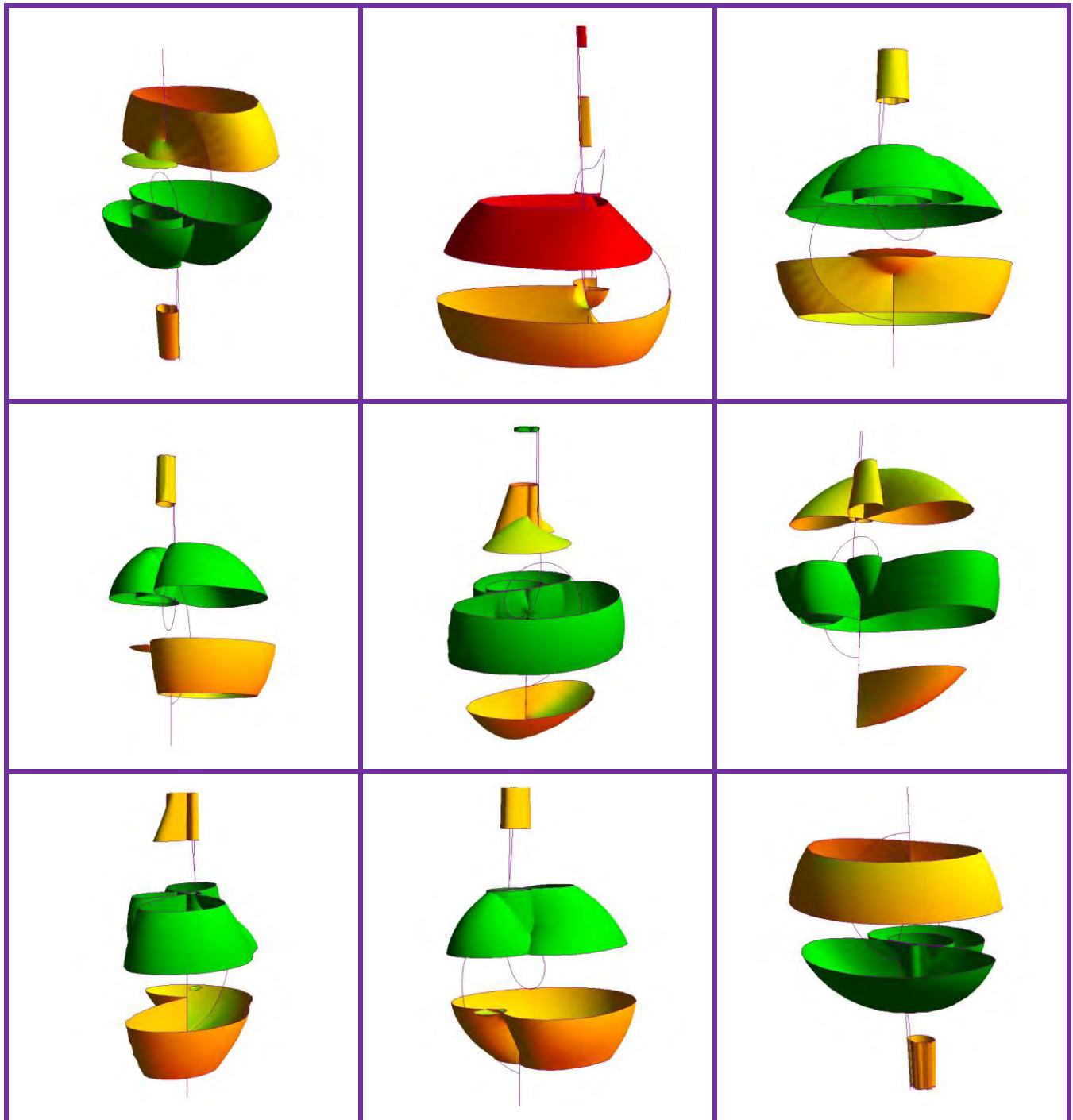

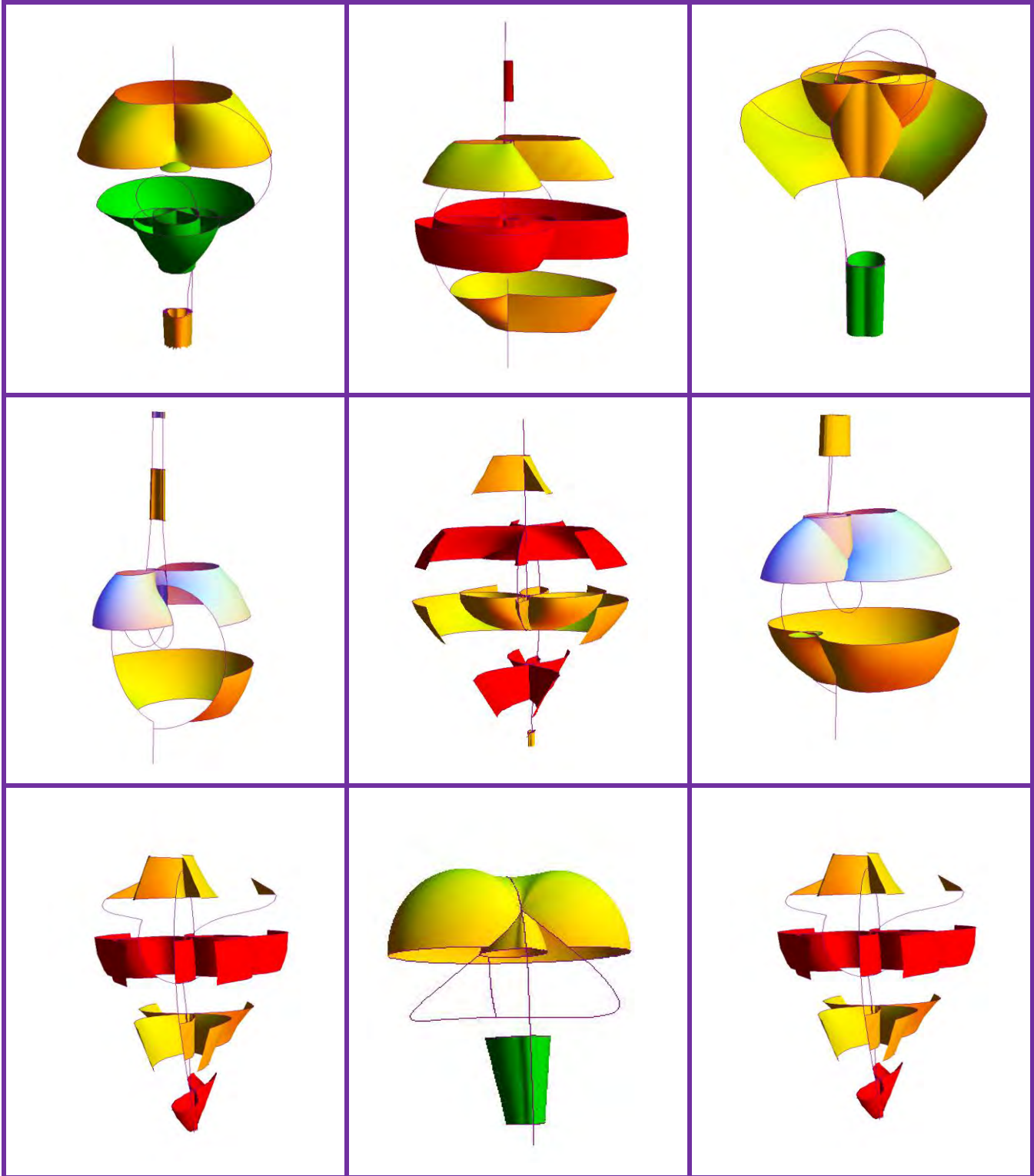

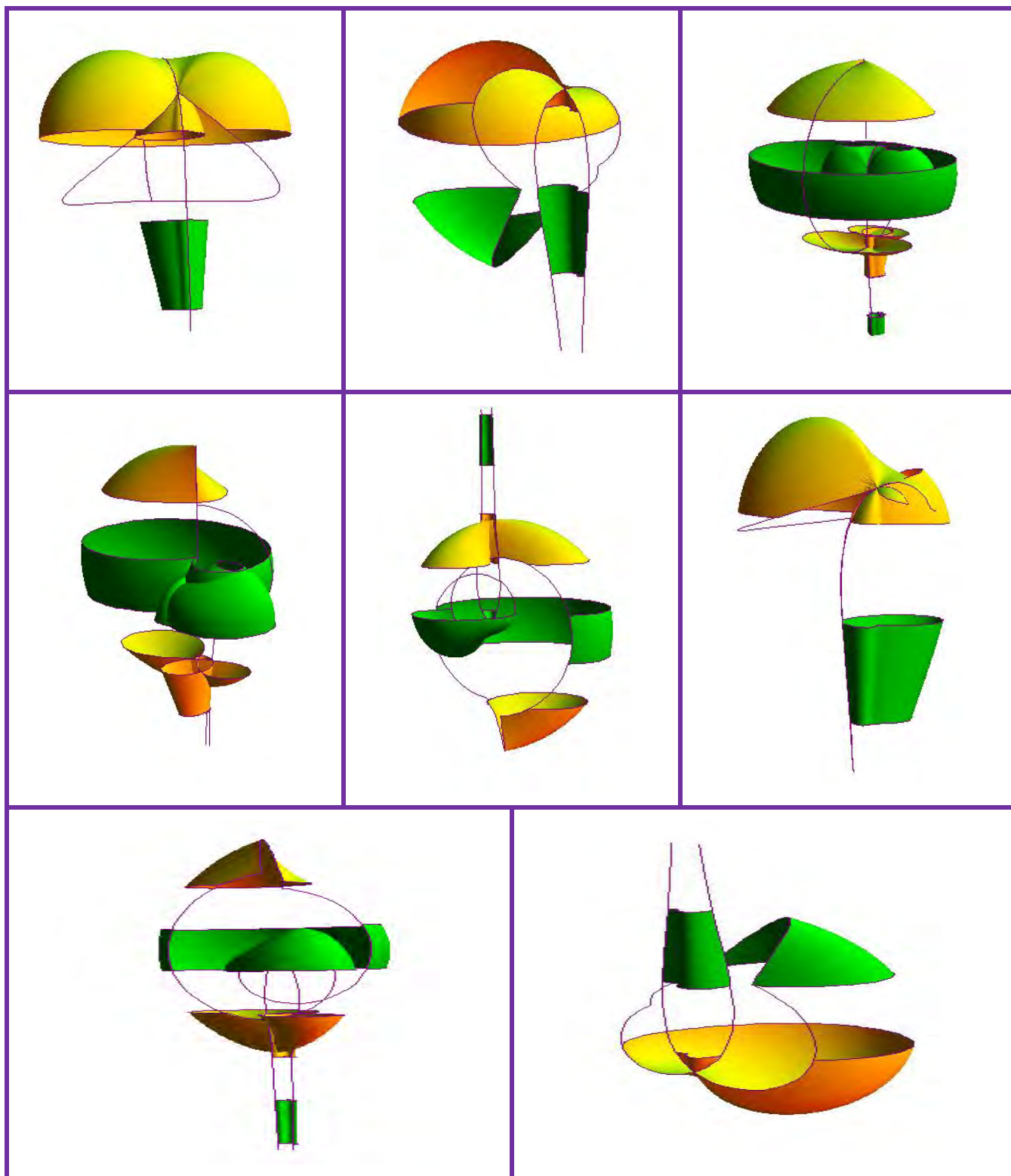

# RIDDLED PROPELLERS

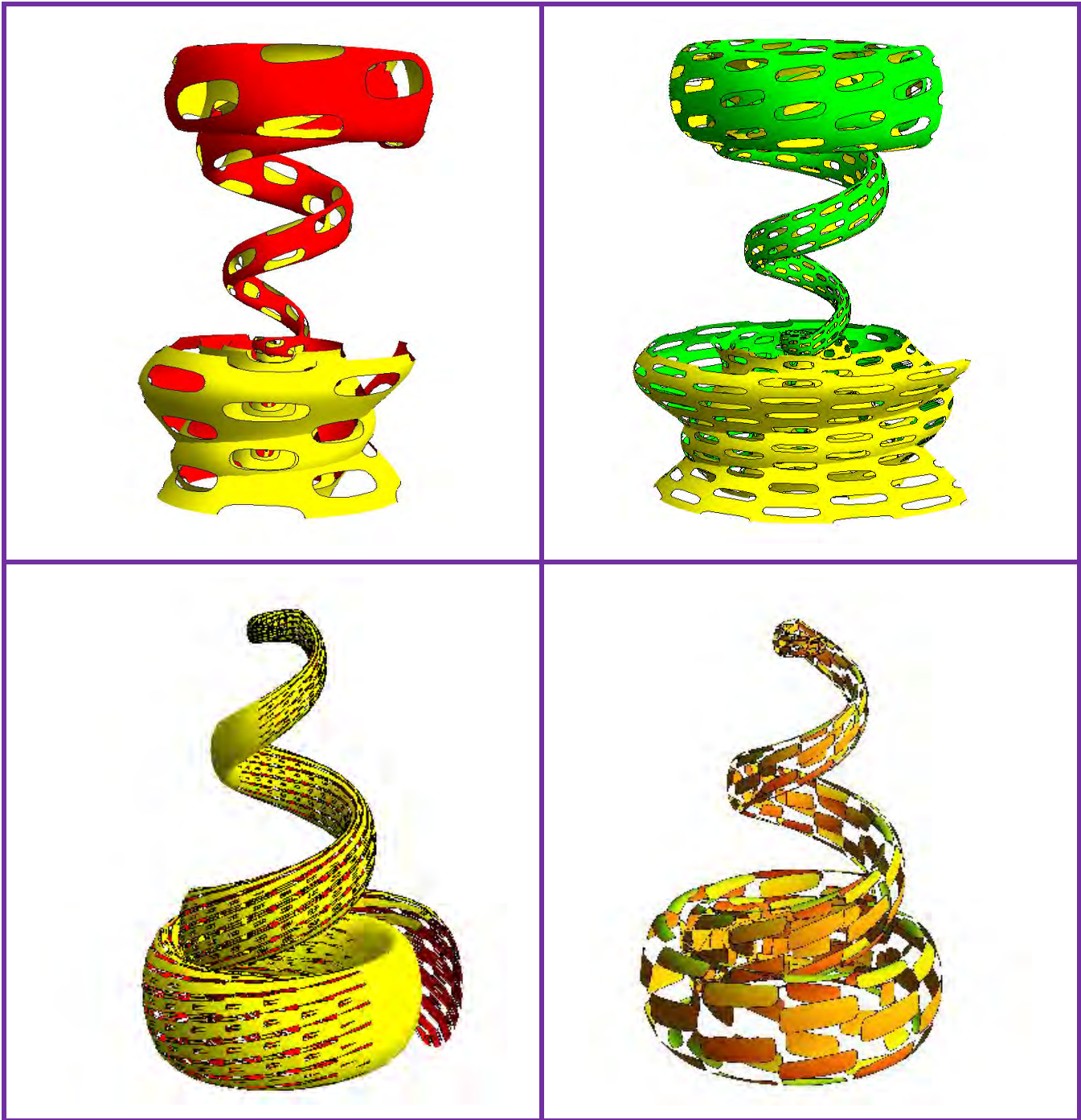



## ROUNDBOUTS

"Six Interwoven Loops" from The Wolfram Demonstrations  
Project\_ <http://demonstrations.wolfram.com/SixInterwovenLoops/>

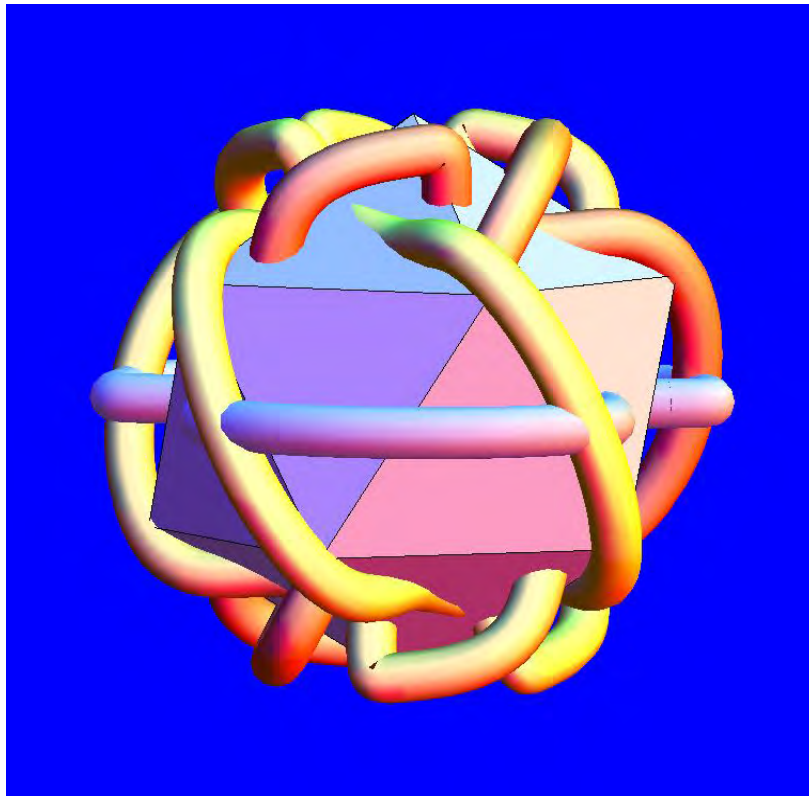
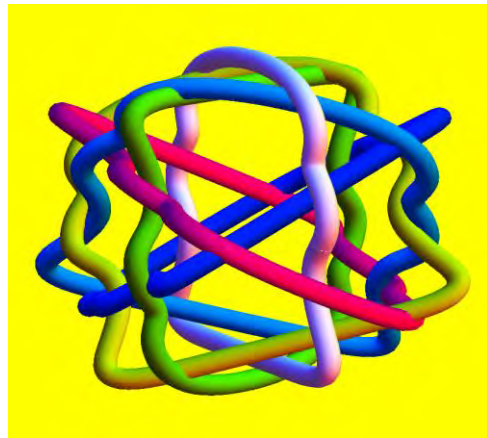
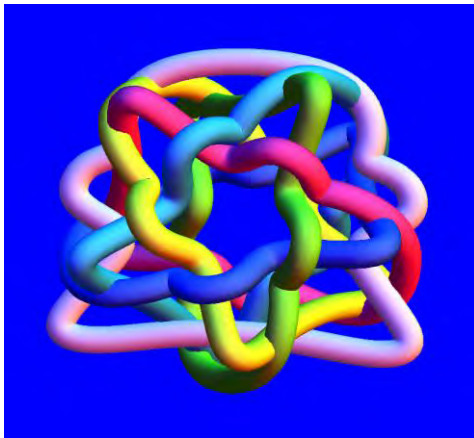

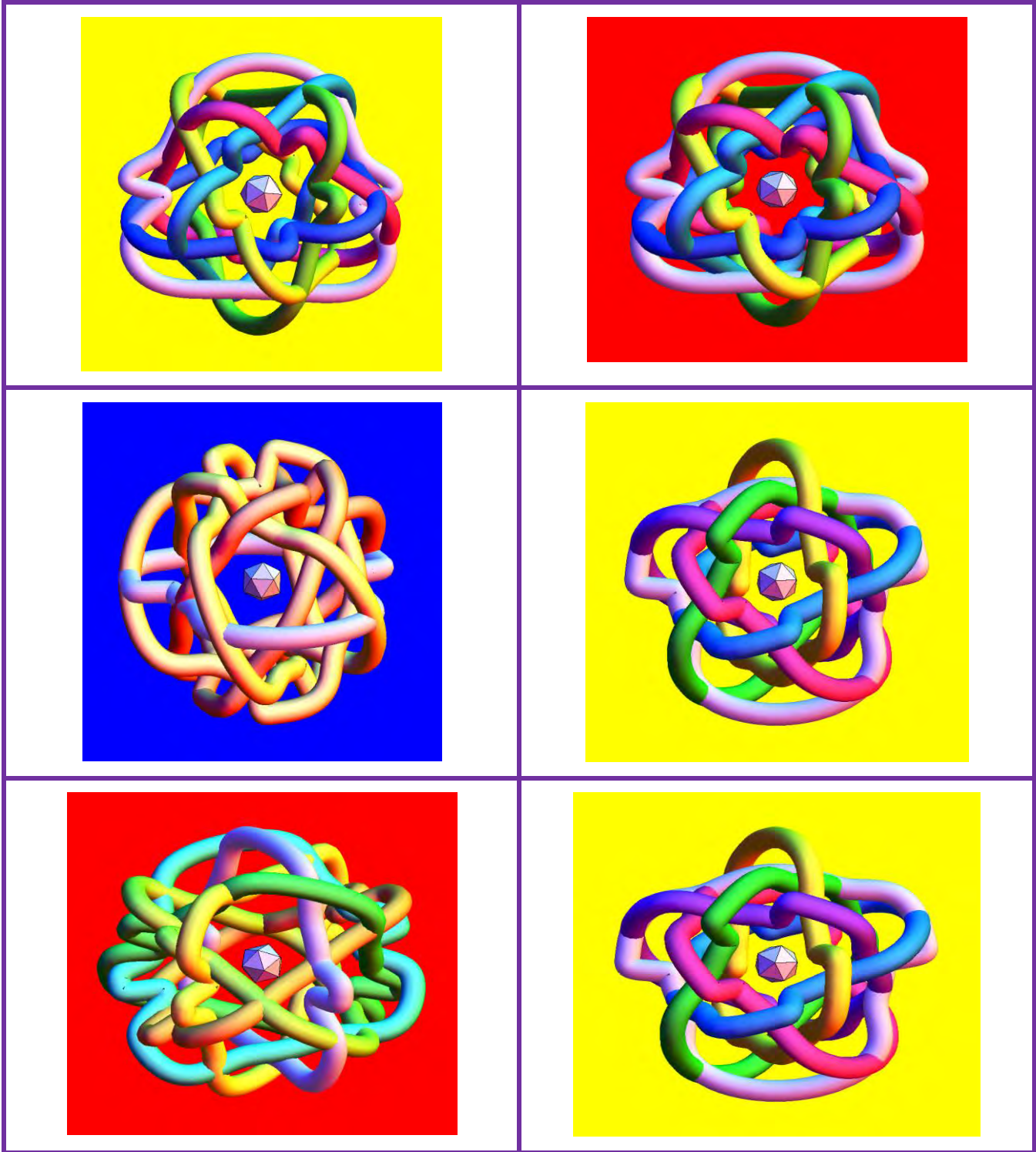

## RIBANDS

ParametricPlot3D[{{ $coqu.sigt - 1$ ,  $siqu + 1$ ,  $coqt.siqu - 1$ ,  $S(s = 0.8, \varepsilon = 0)$ },  
 { $coqt.siqu - 1$ ,  $2cost.sigt + 1$ ,  $coqu.sigt$ ;  $S(s = 0.2, \varepsilon = 0)$ }}, { $u, 0, 2\pi$ }, { $t, 0, \pi$ }]

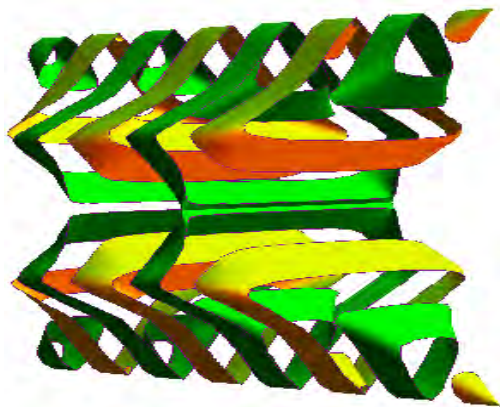
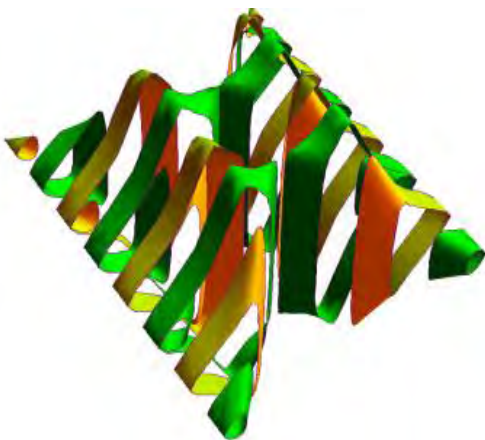
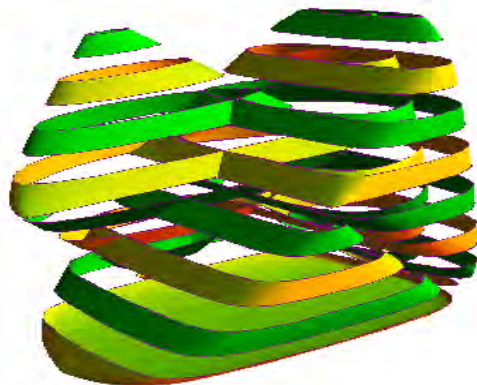
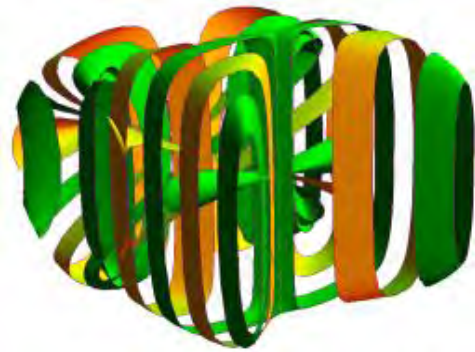



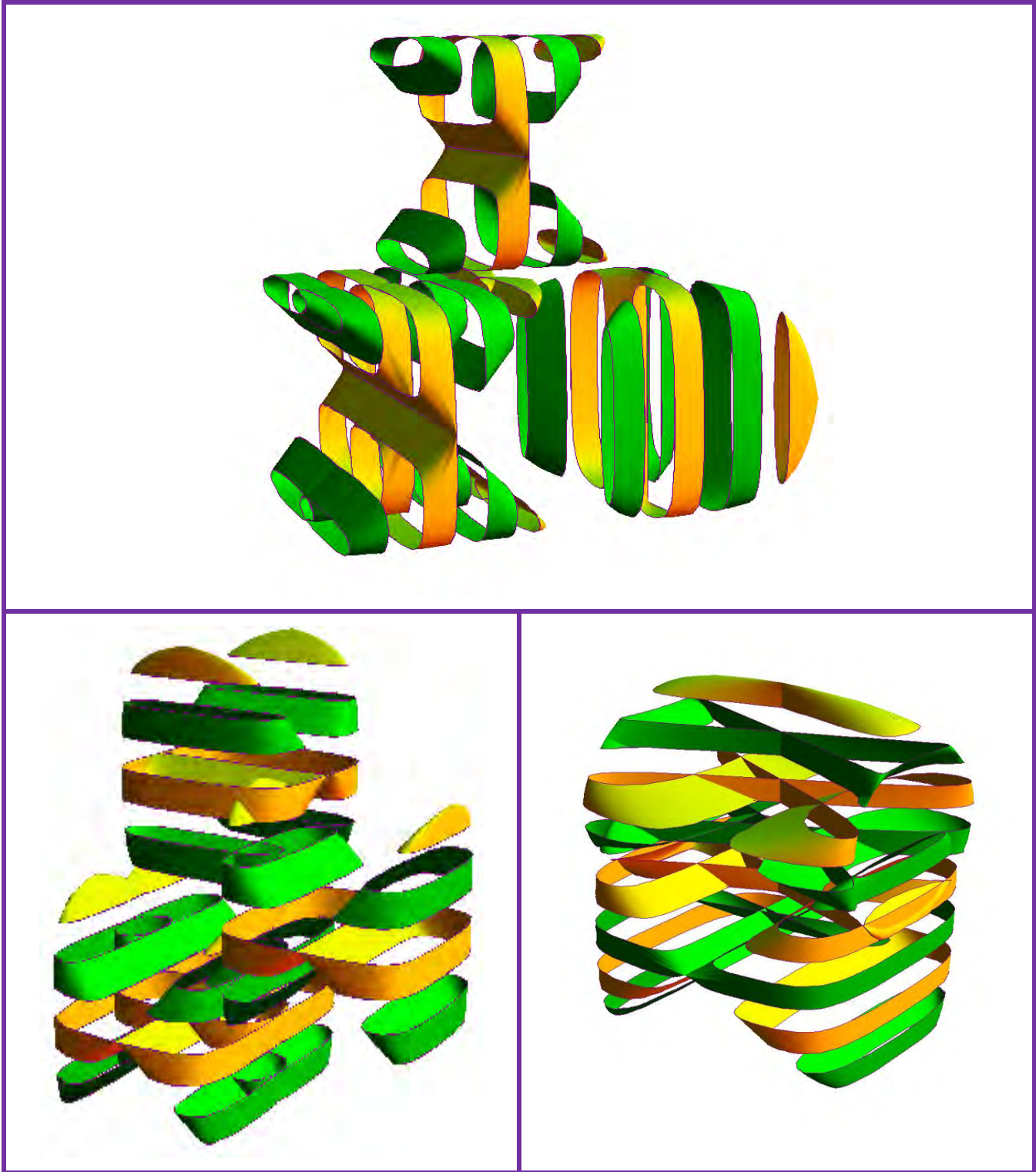



## AERONAUTICAL CAPSULE

```

RevolutionPlot3D[{2Cos[t - ArcSin[0.02Sin[t]]],
  2.5Cos[t - Pi/2 - ArcSin[0.75Sin[t - Pi/2]]]}, {t, 0, 2Pi}, Axes -> None, Boxed -> False,
  Mesh -> All, ColorFunction -> (ColorData["TemperatureMap"][#3]&), Background -> Blue]

```

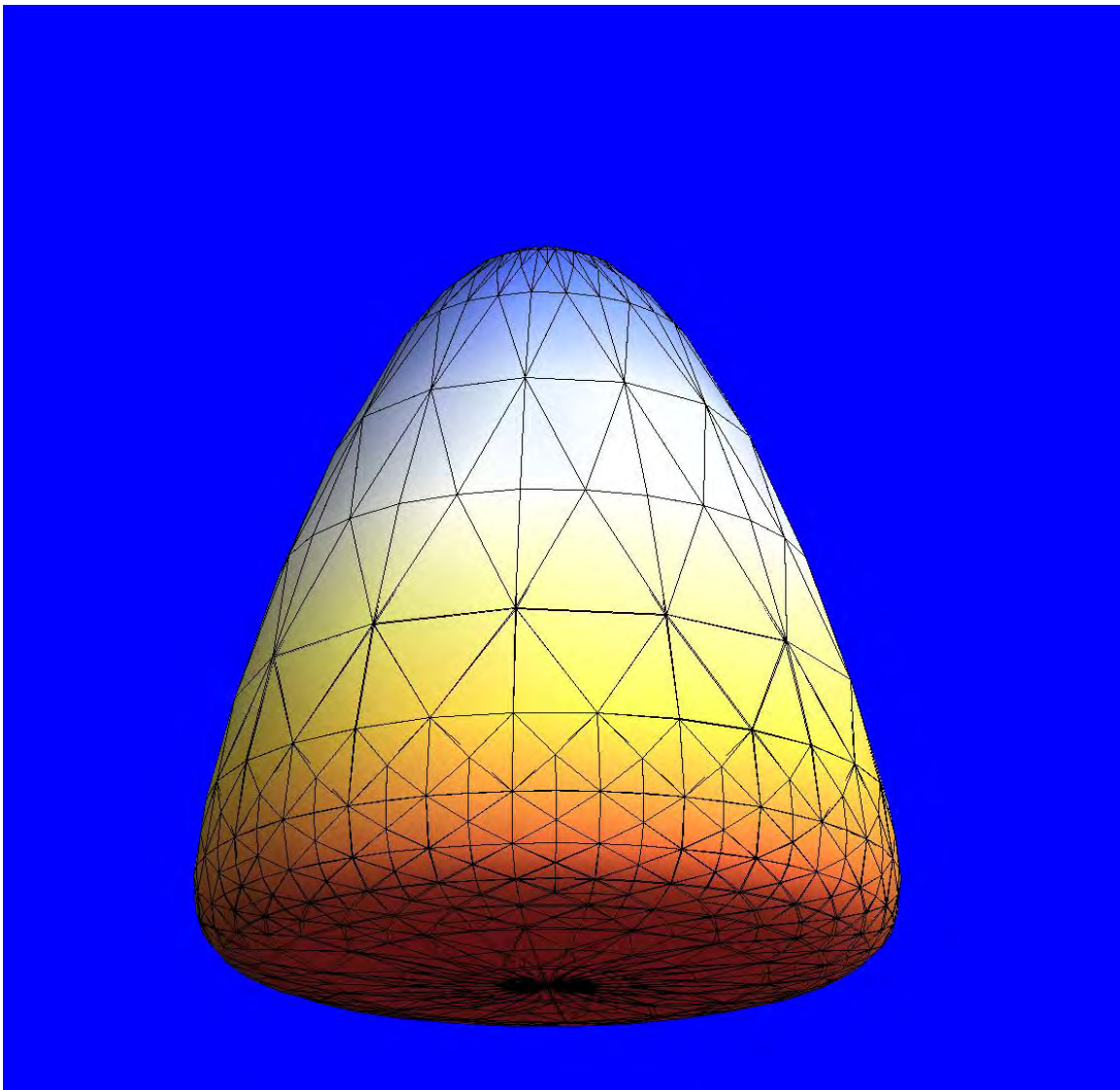

$$\text{RevolutionPlot3D} \left\{ \begin{array}{l} 2. \text{cex}[\theta, S(s = 0.02; \varepsilon = 0)] \\ 2.5 \text{cex} \left[ \theta - \frac{\pi}{2}, S(s = 0.75; \varepsilon = 0) \right] \end{array} \right\}, \quad \theta \in [0, 2\pi]$$

# NASA CAPSULE



## SM PLANES

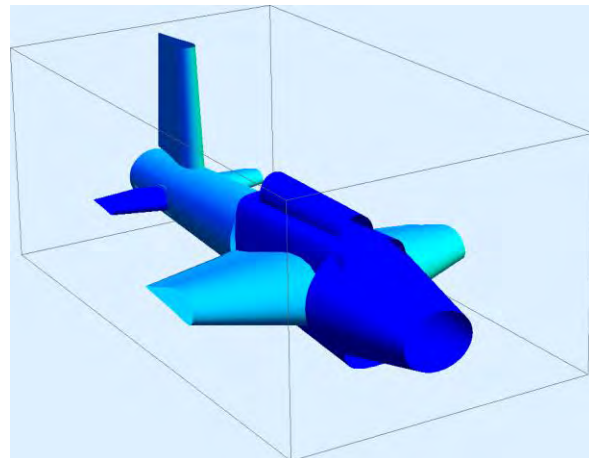
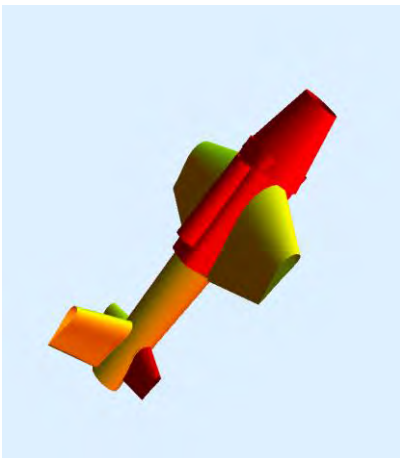
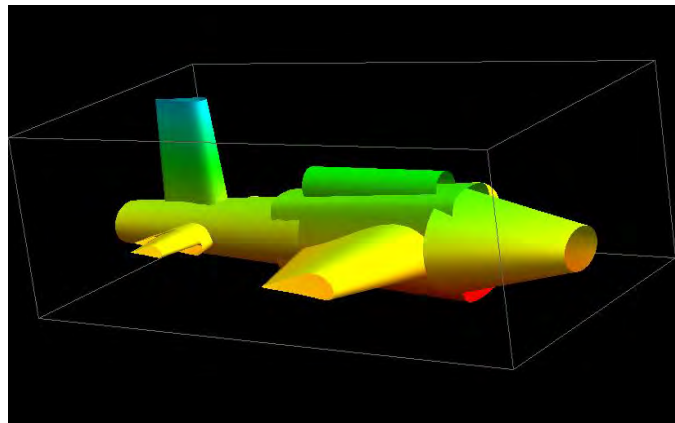
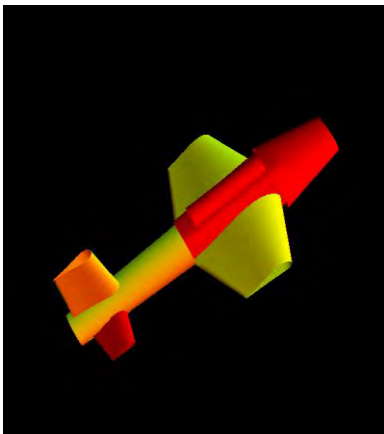
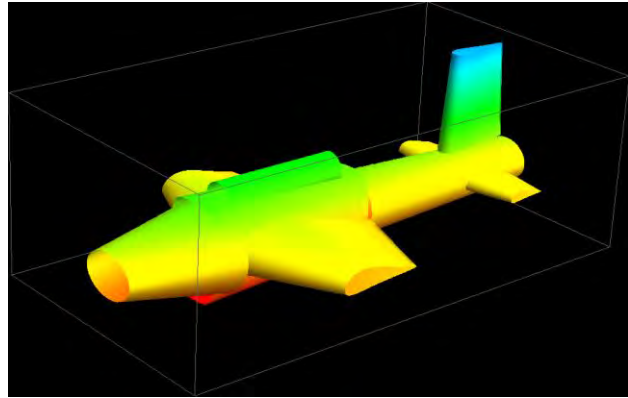
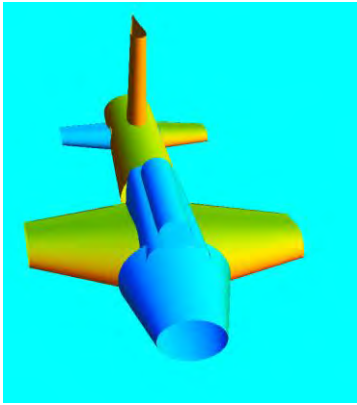



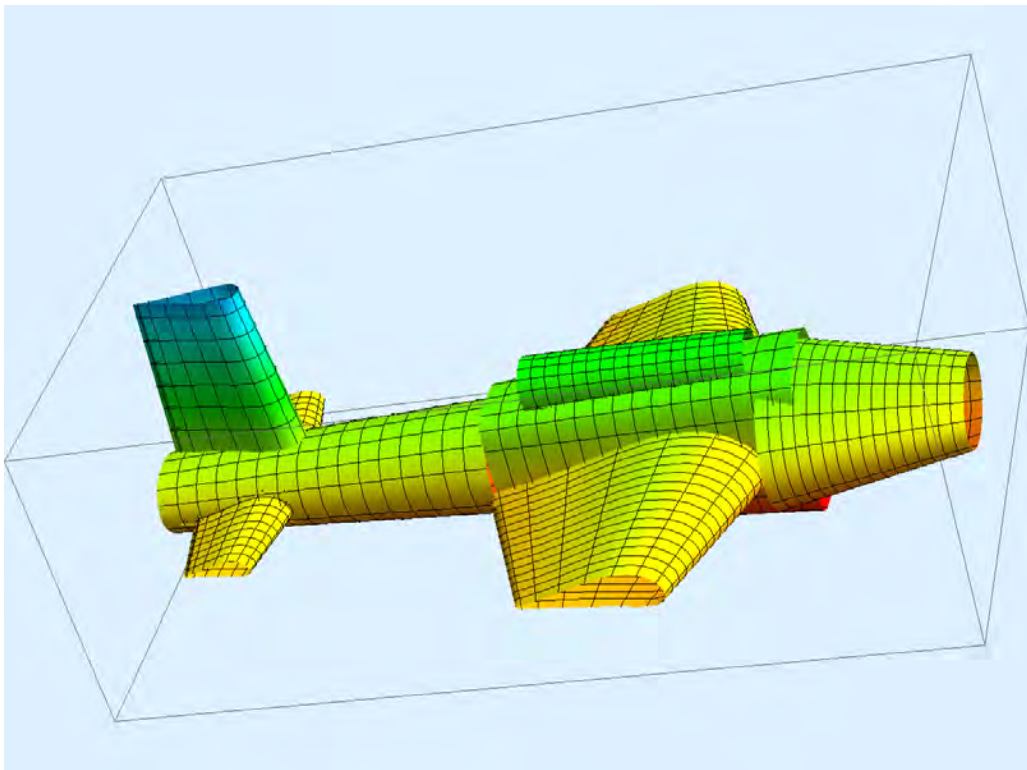
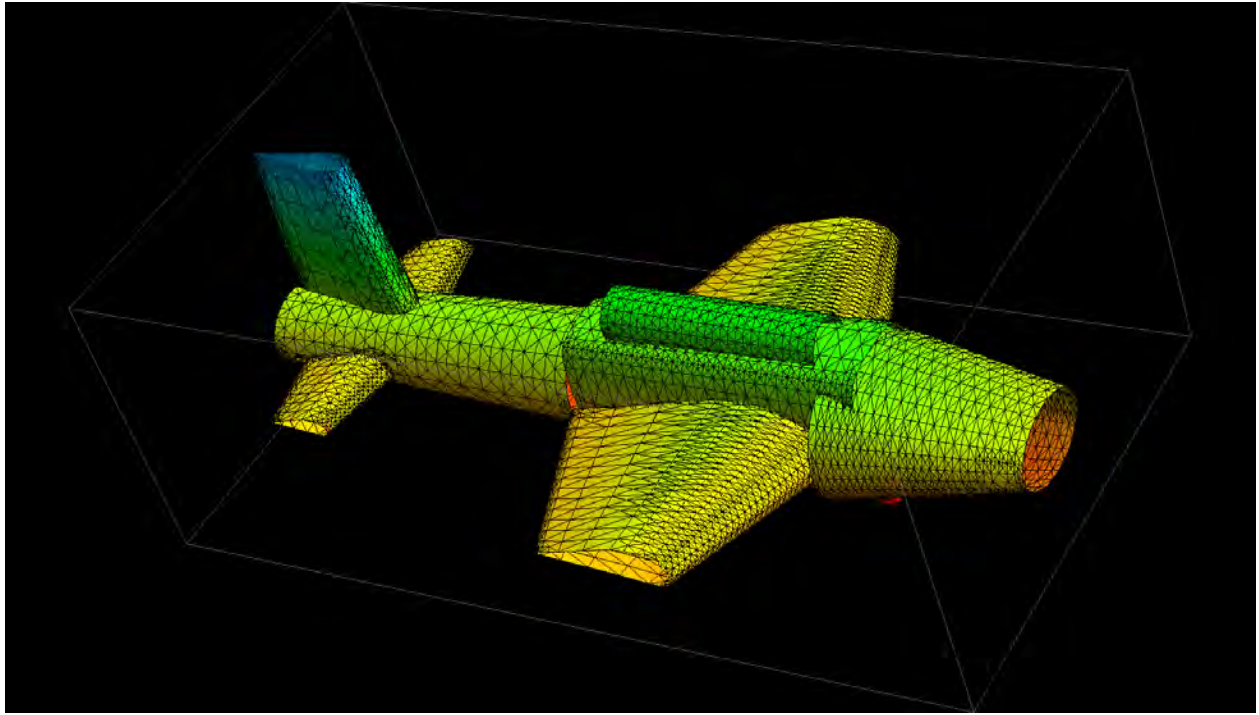



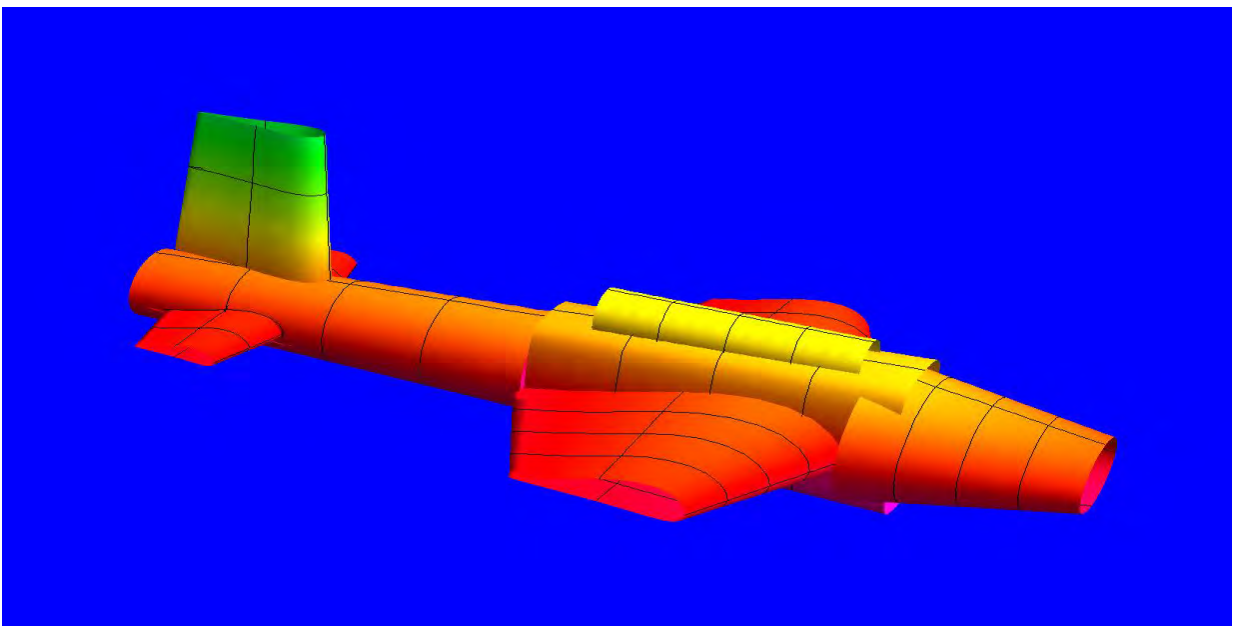
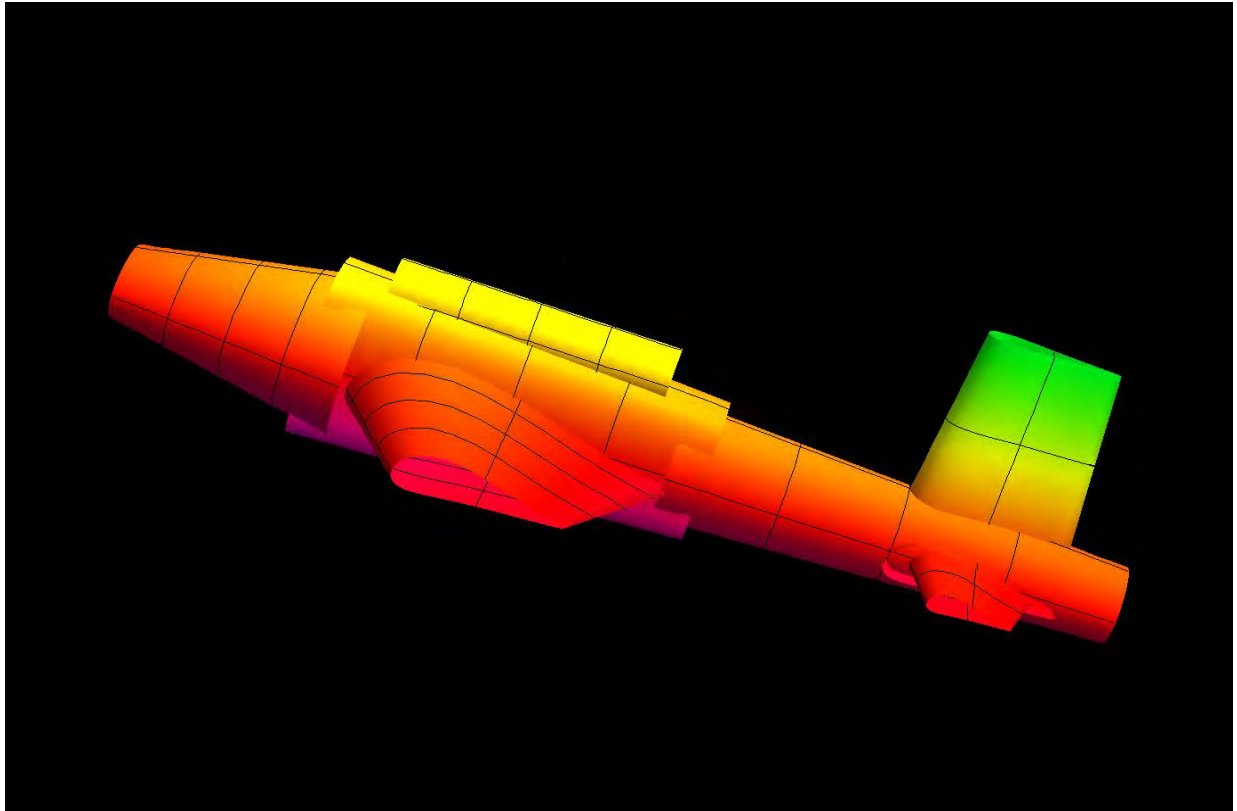

# TOROIDS

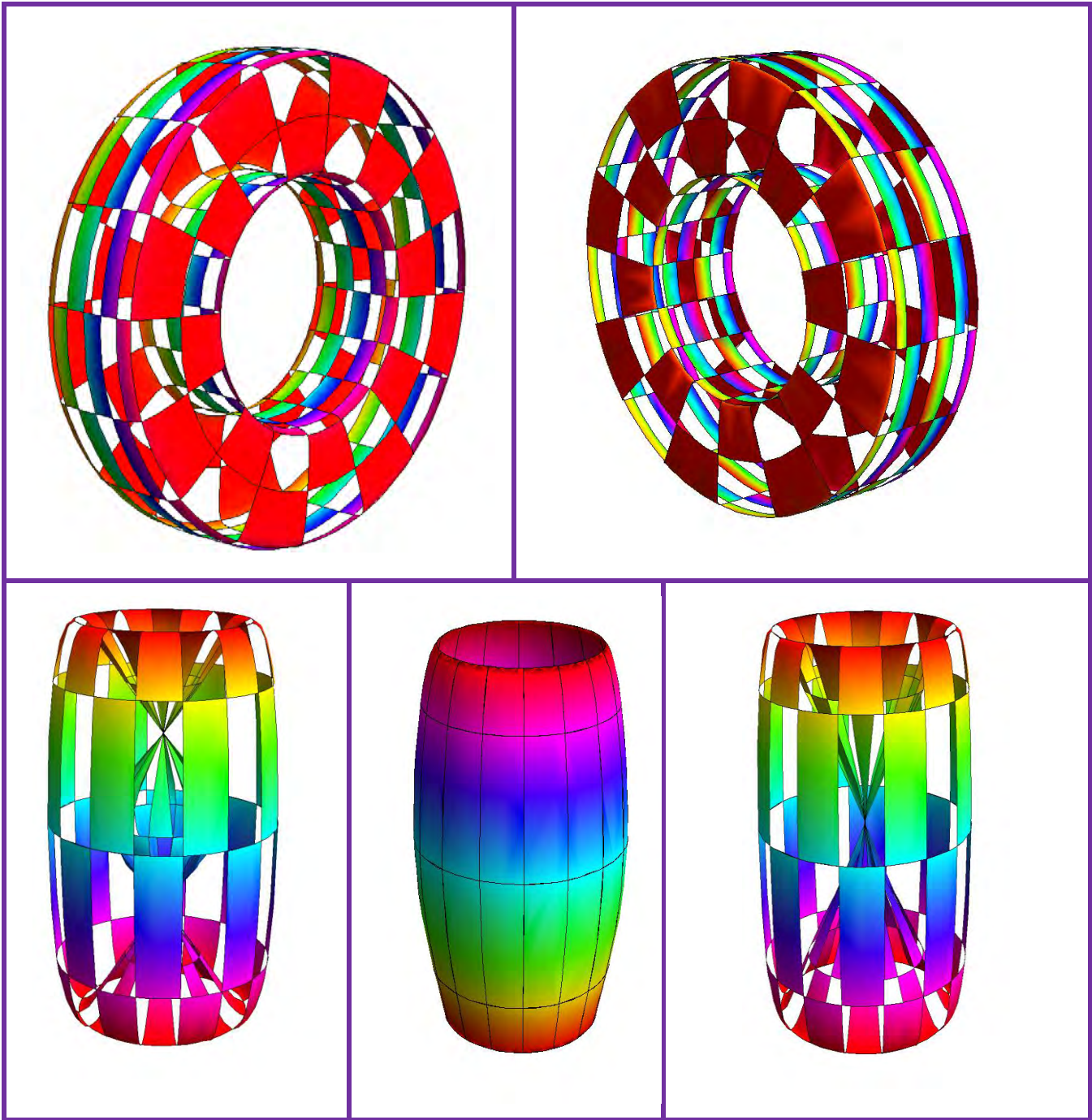

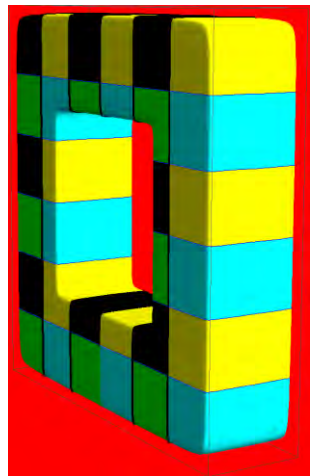
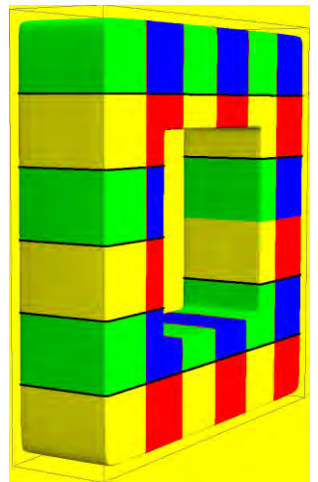
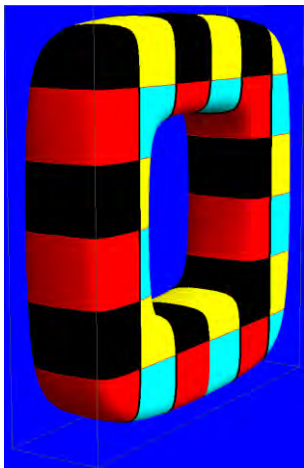
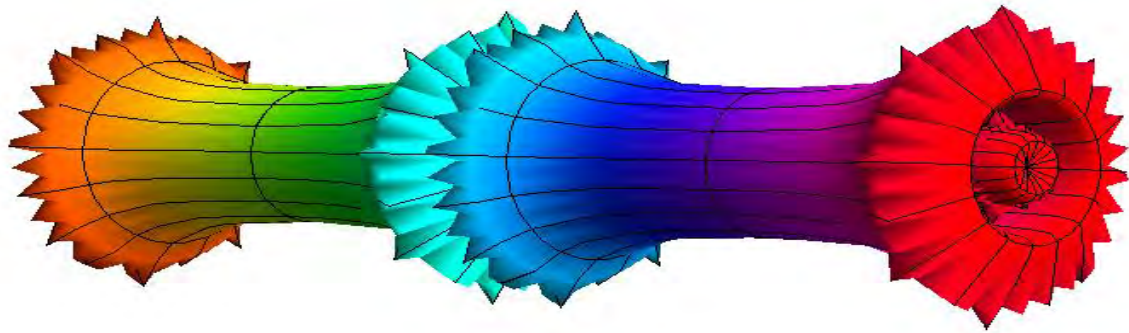
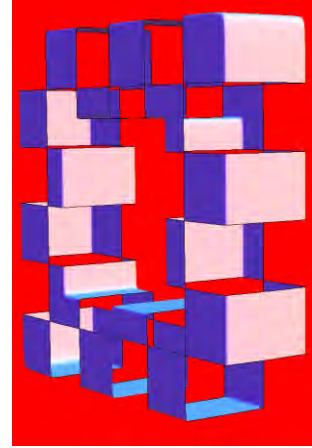
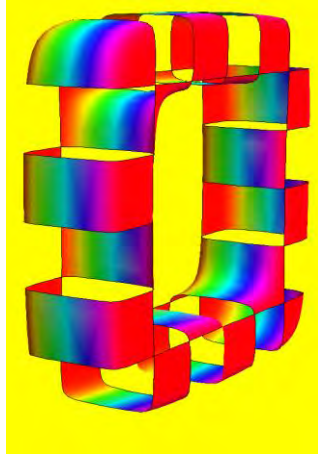
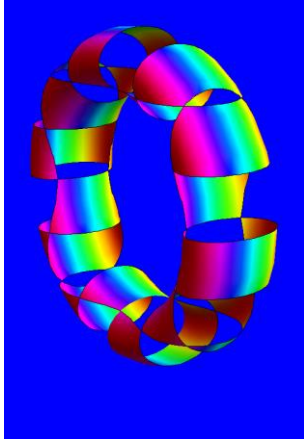



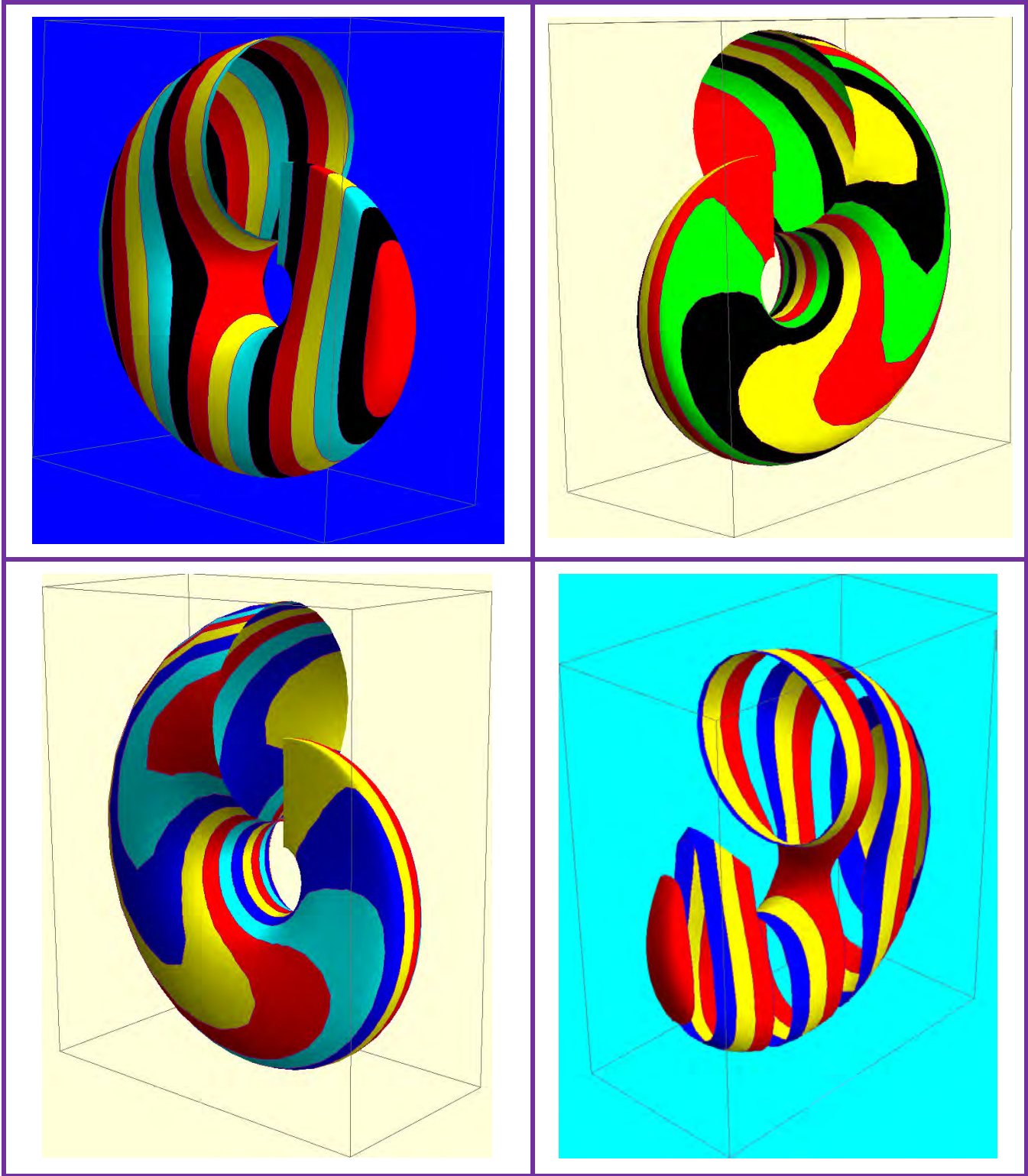



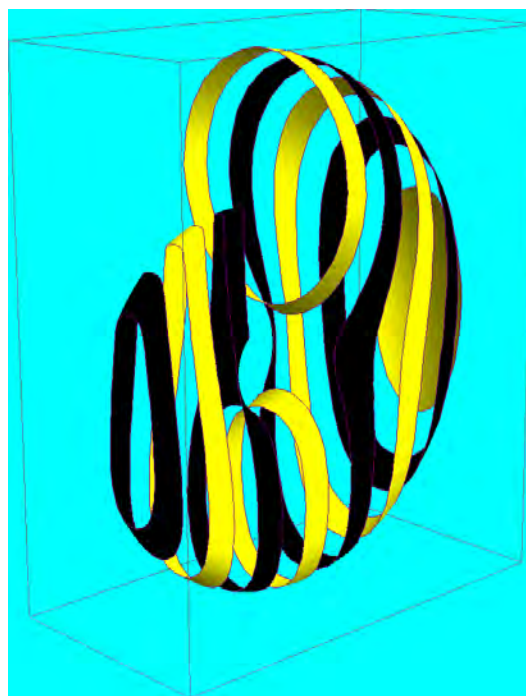
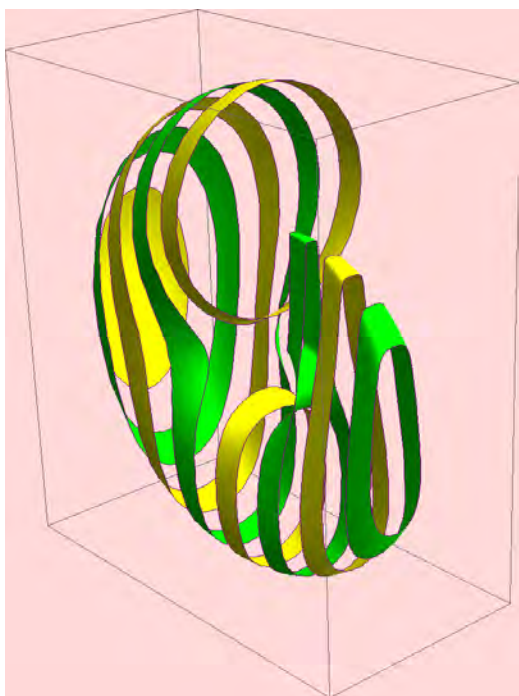
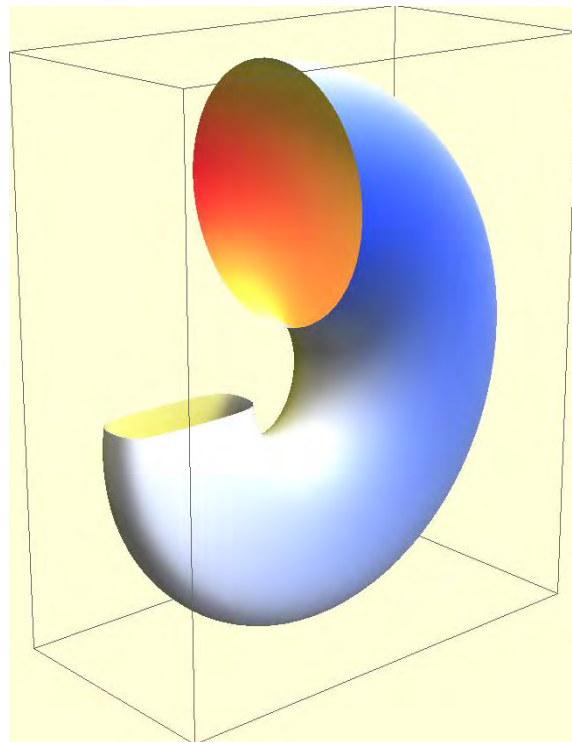
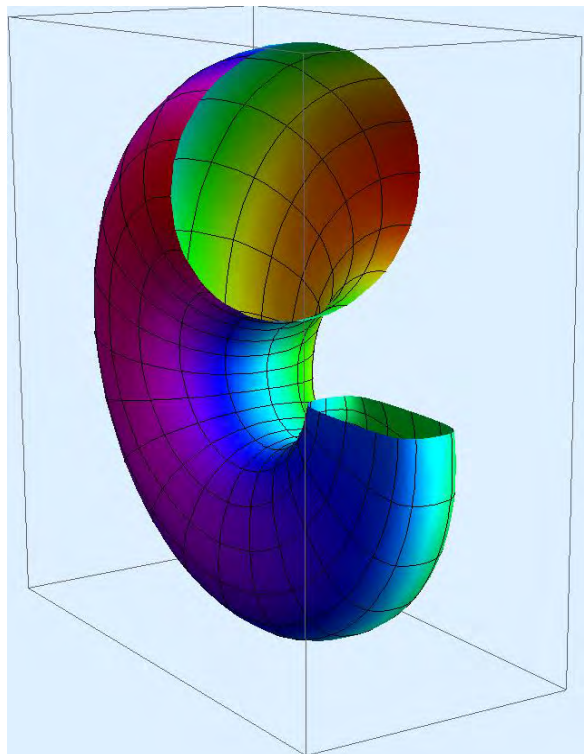

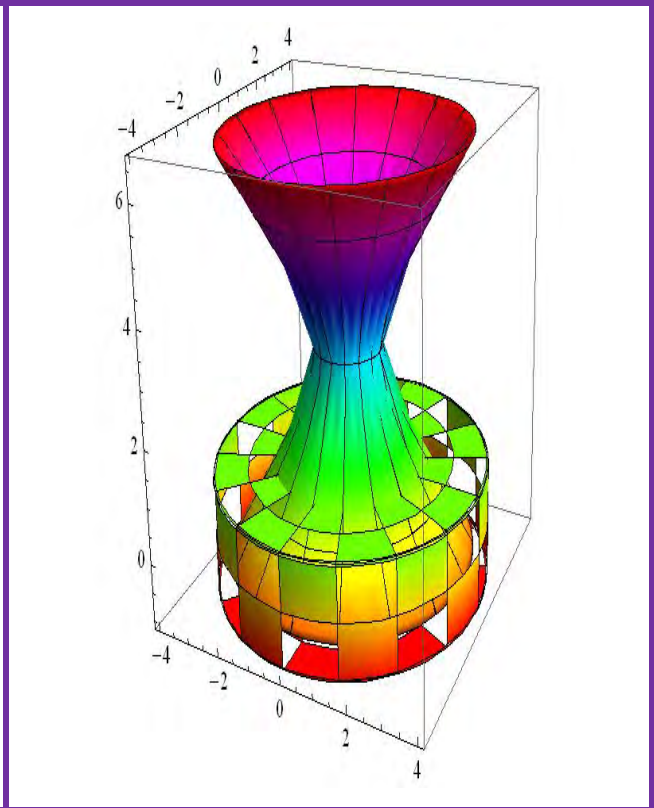
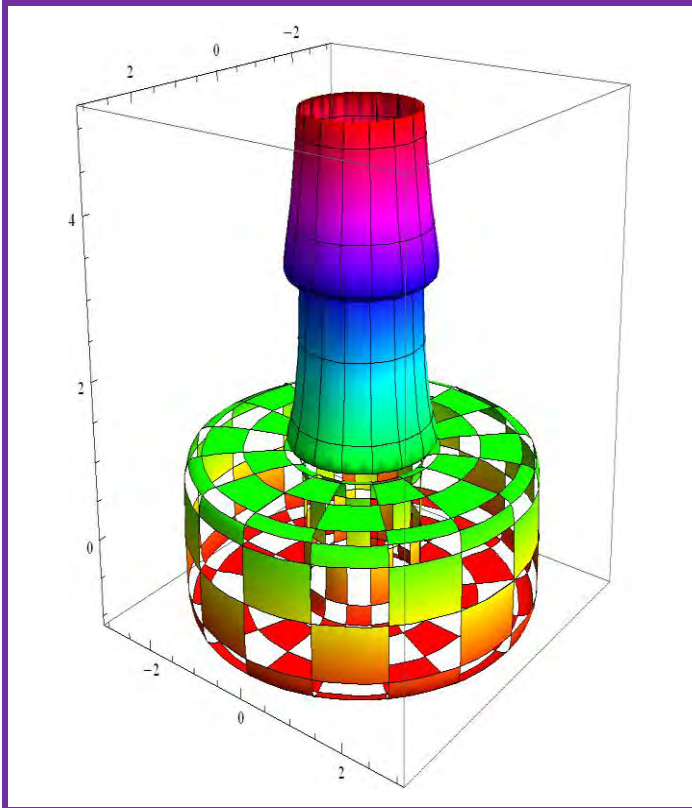
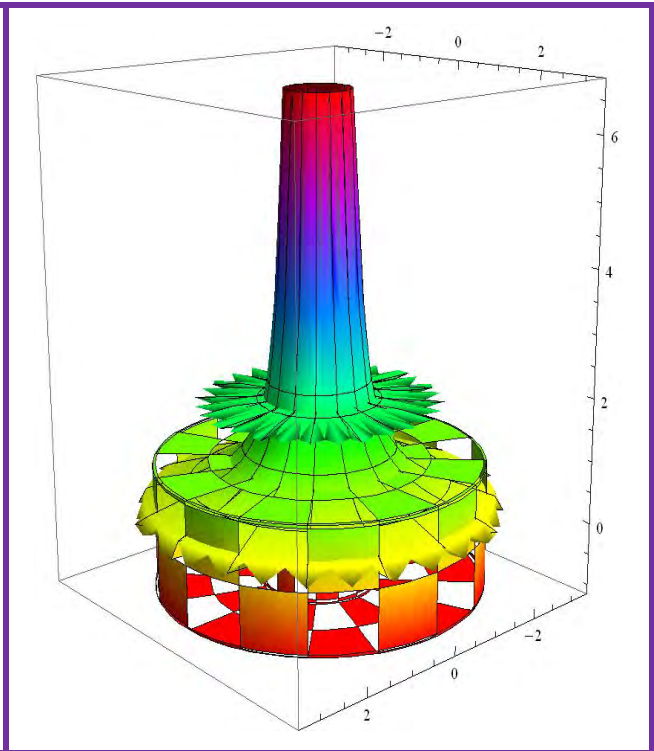
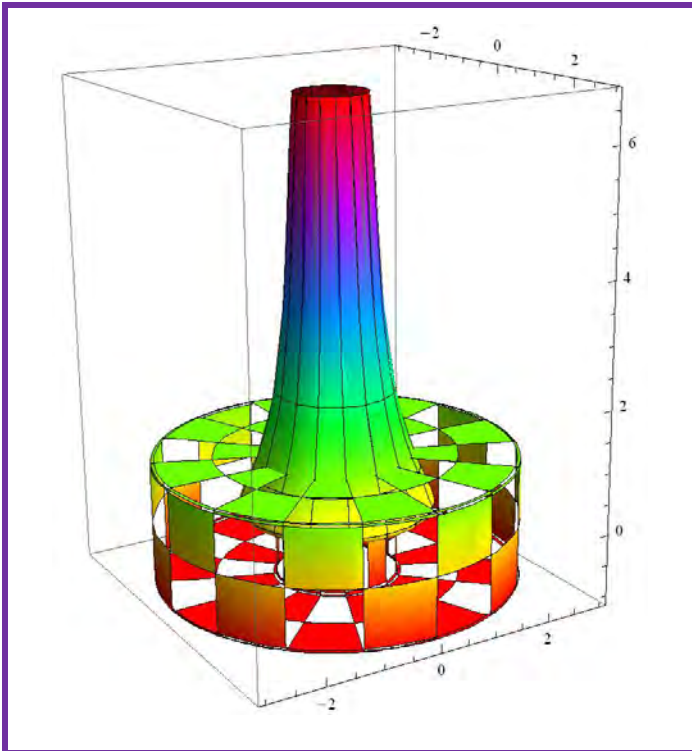

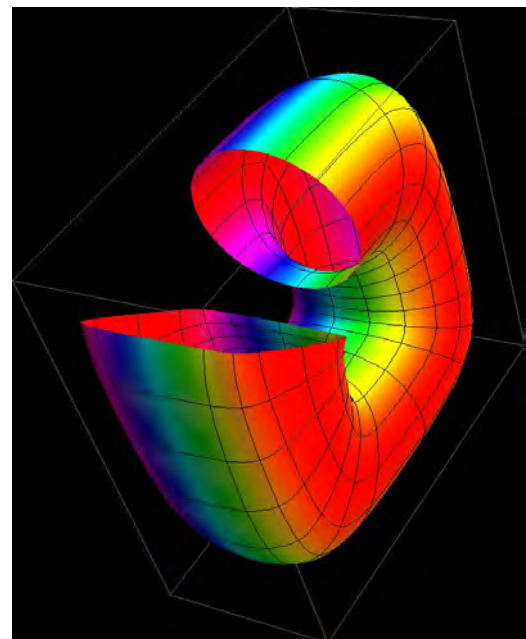
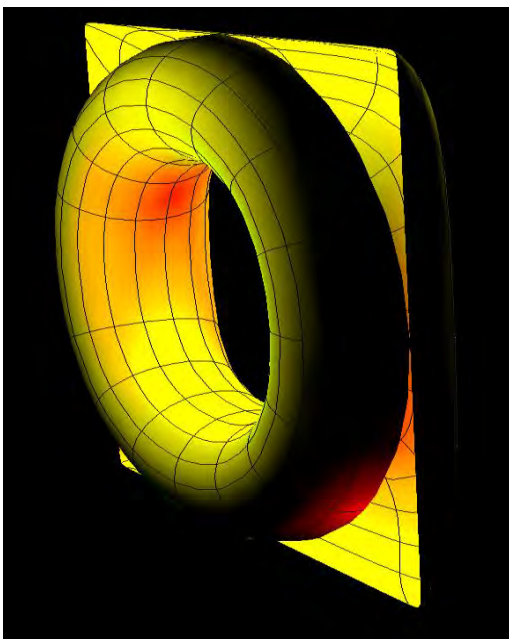
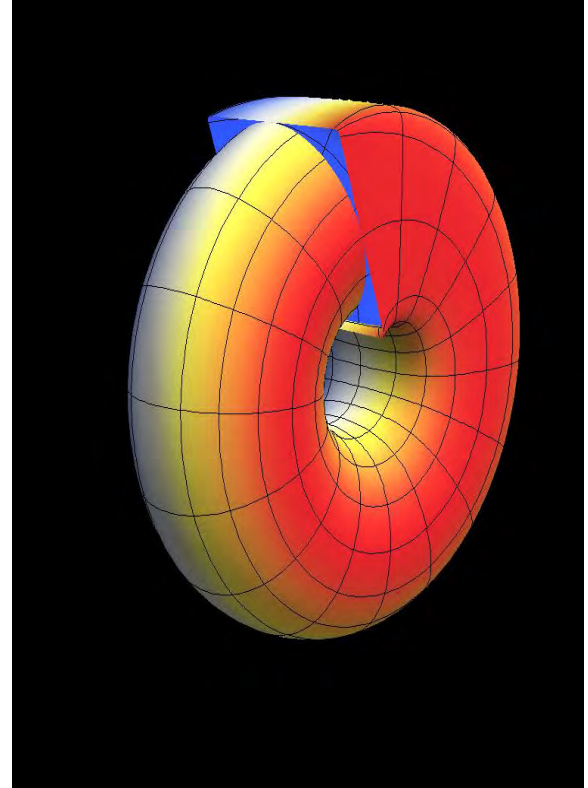
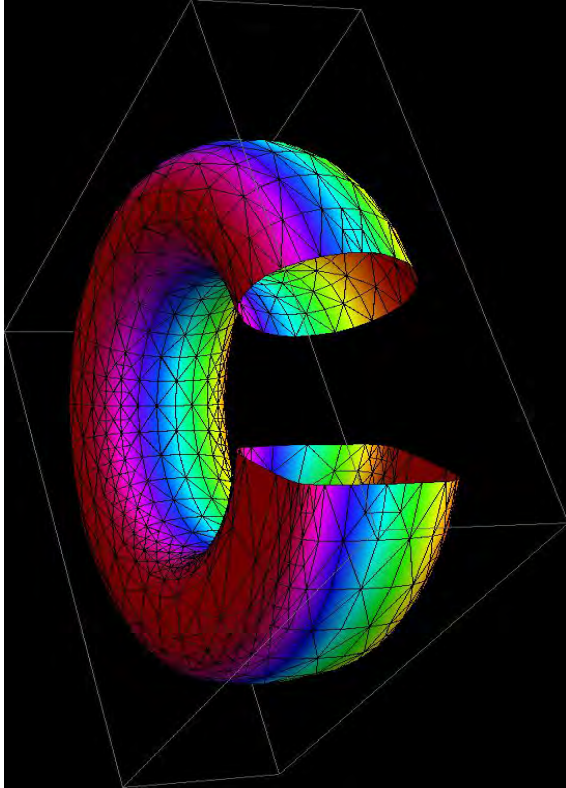



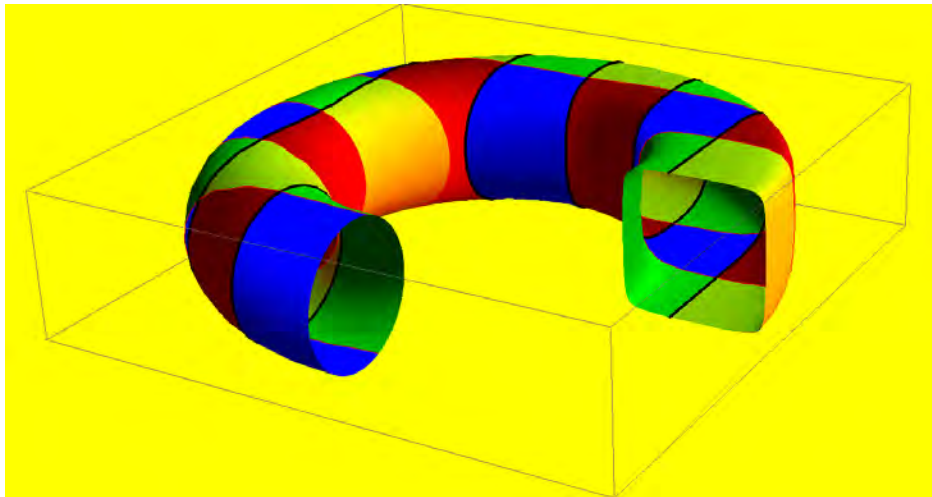
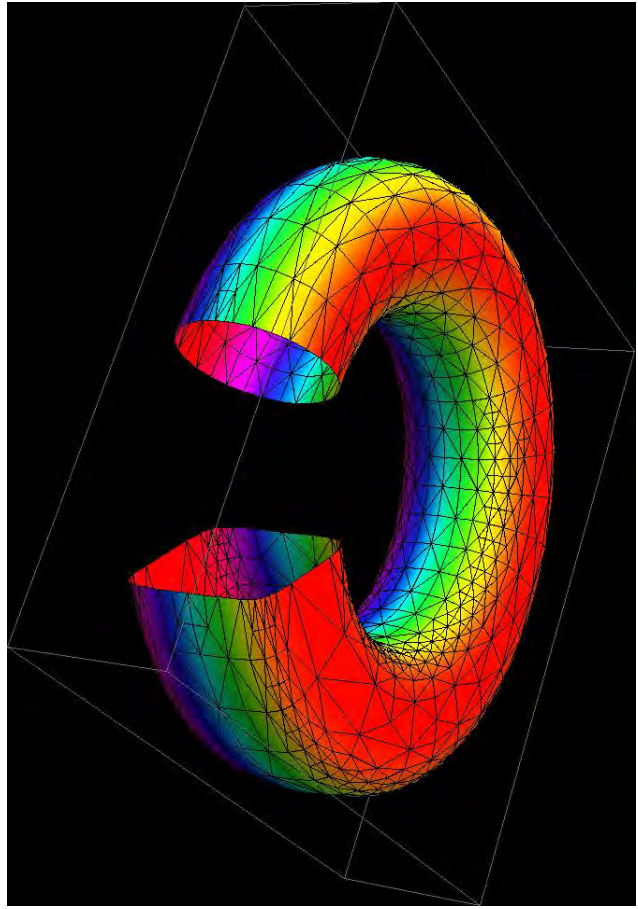
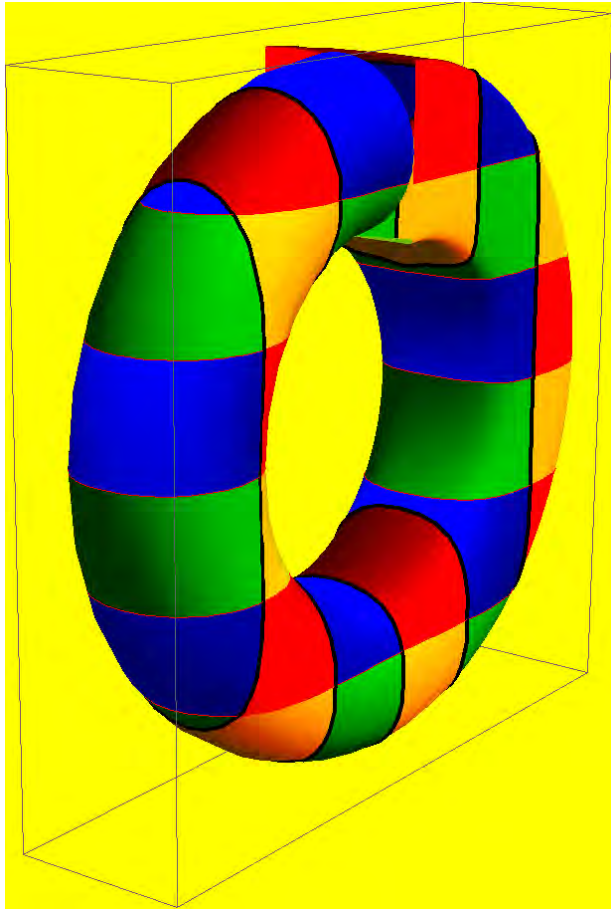



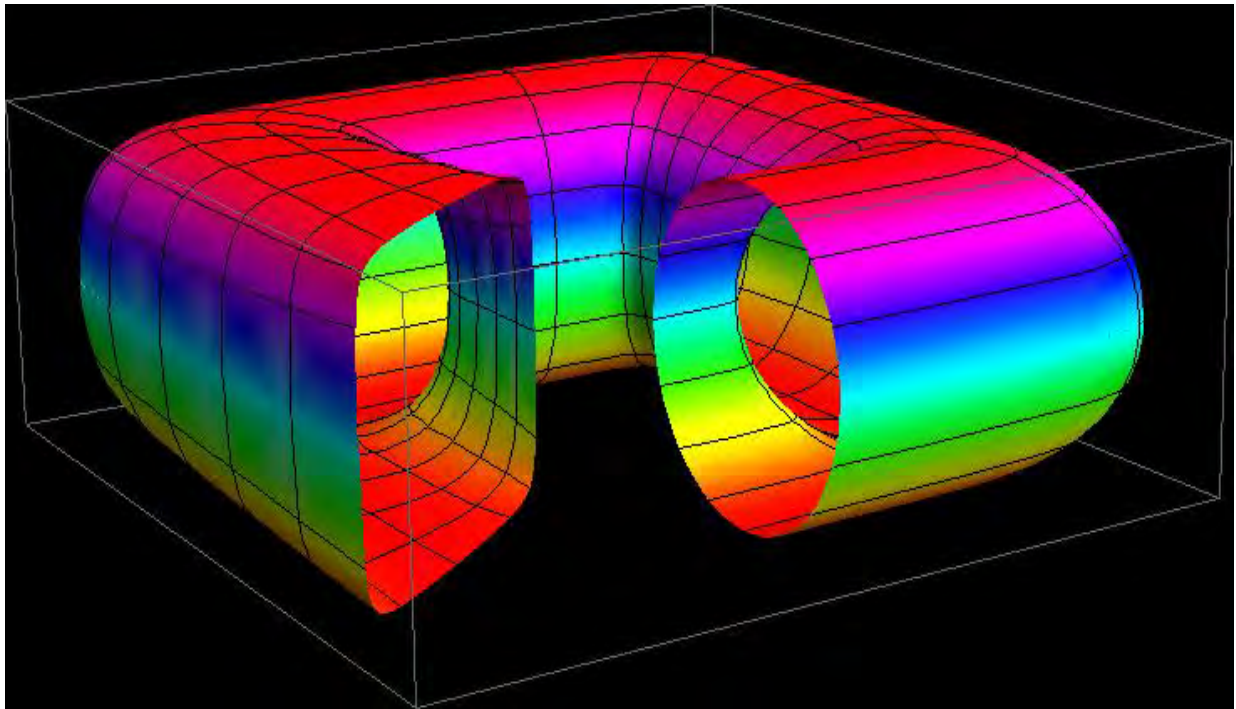
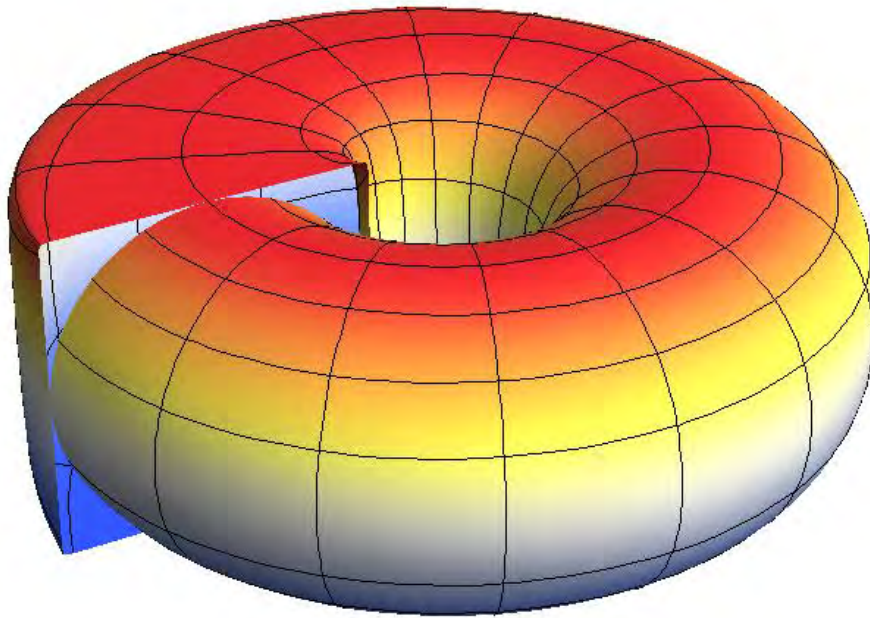

# FRAGMENTED TOROIDS

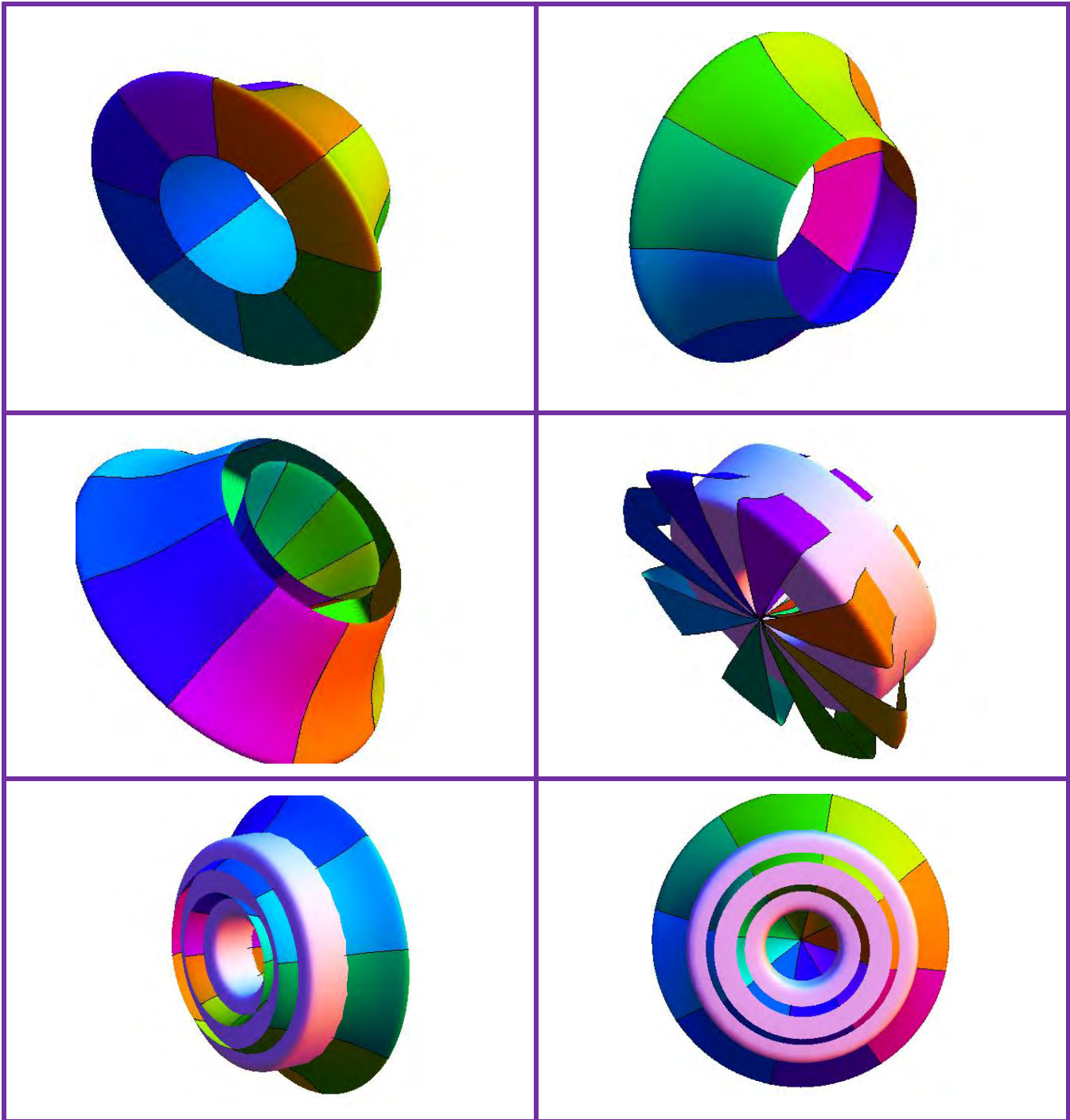

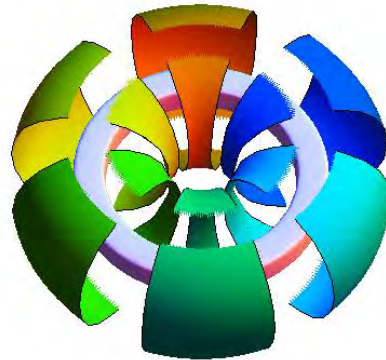
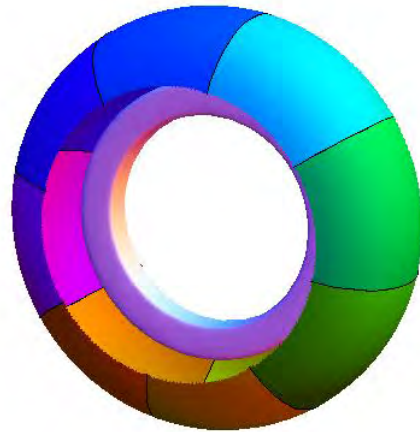
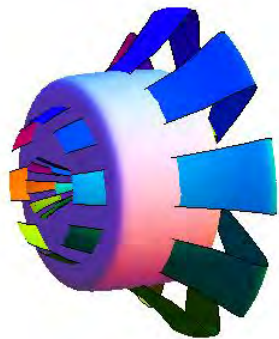
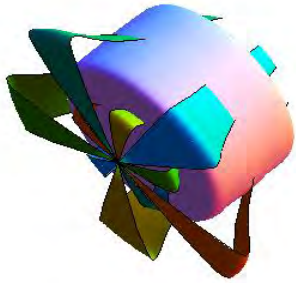



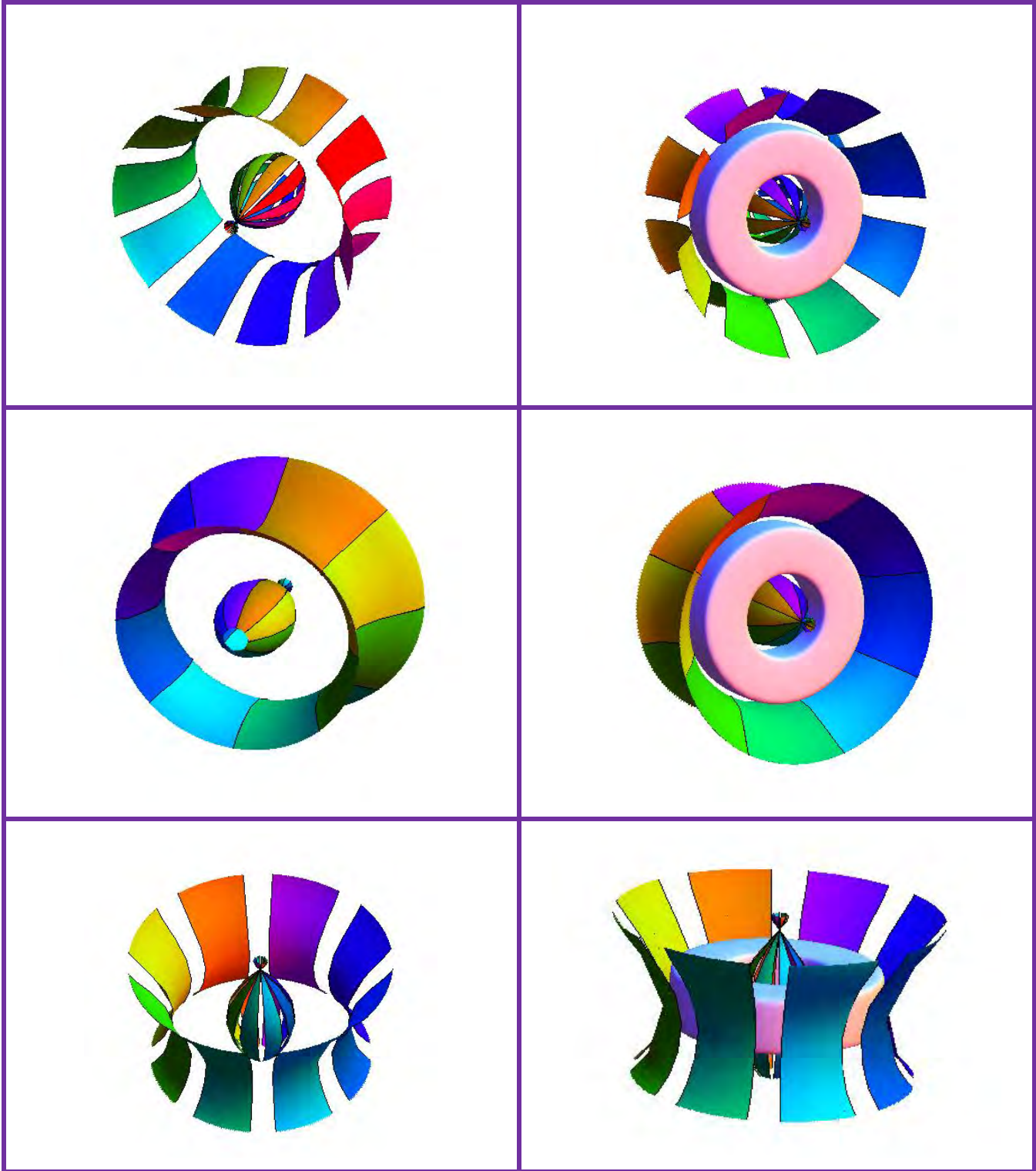



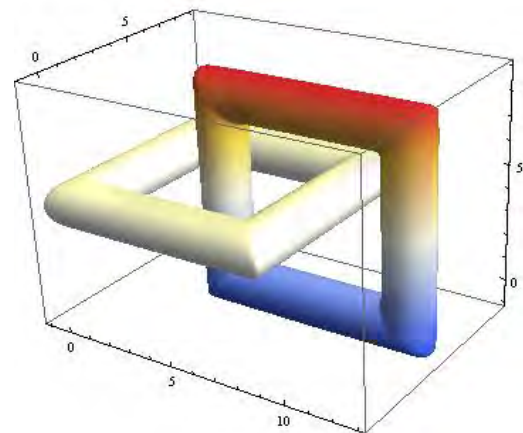
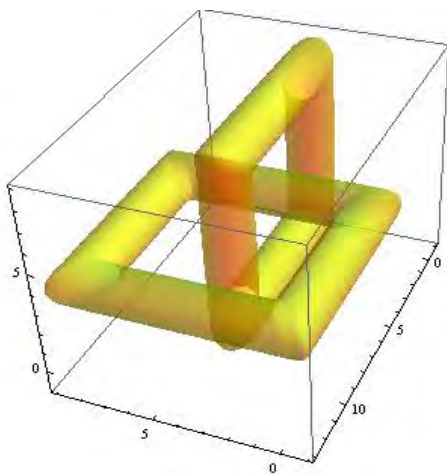
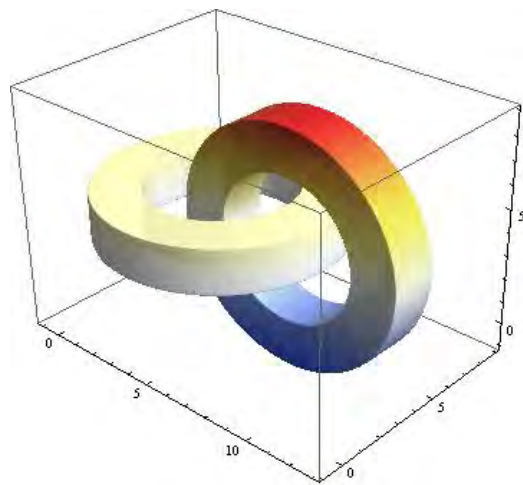
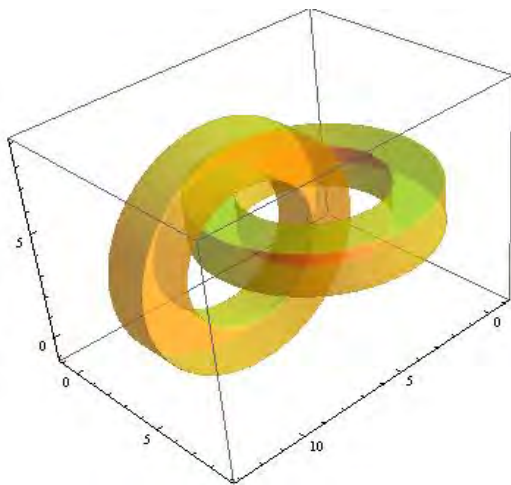
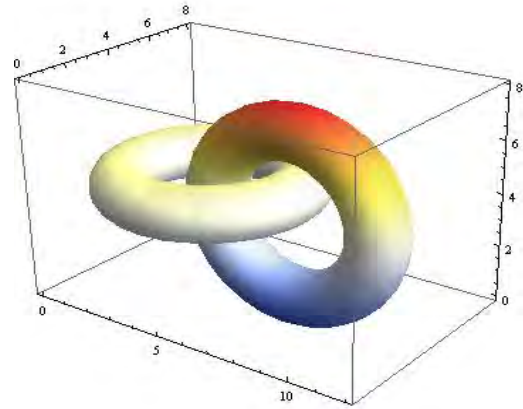
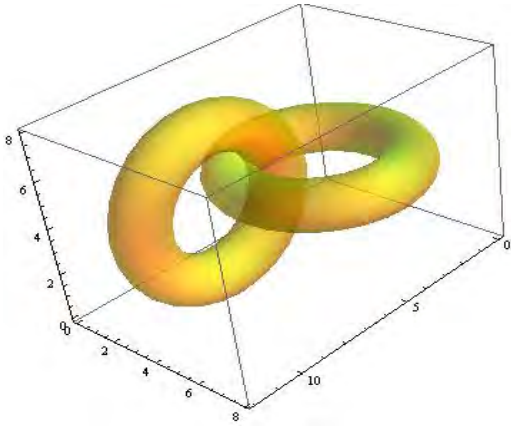

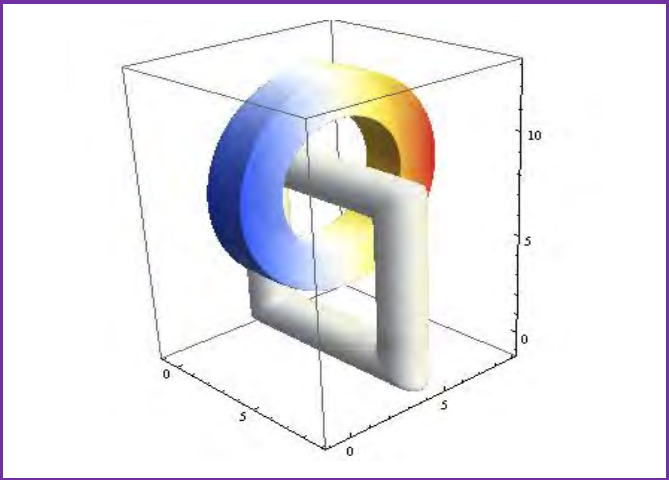
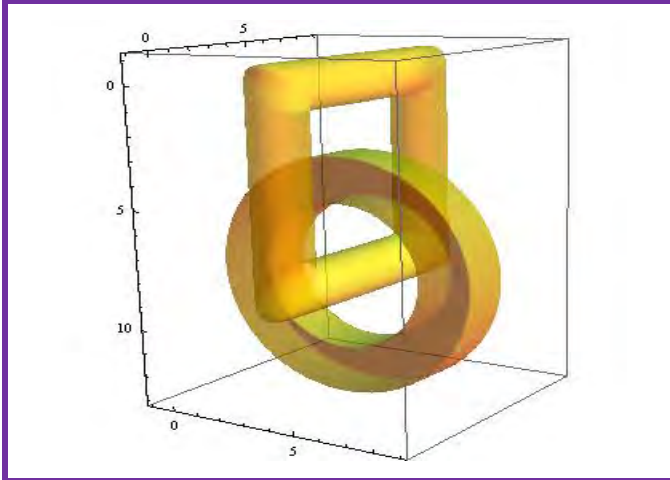
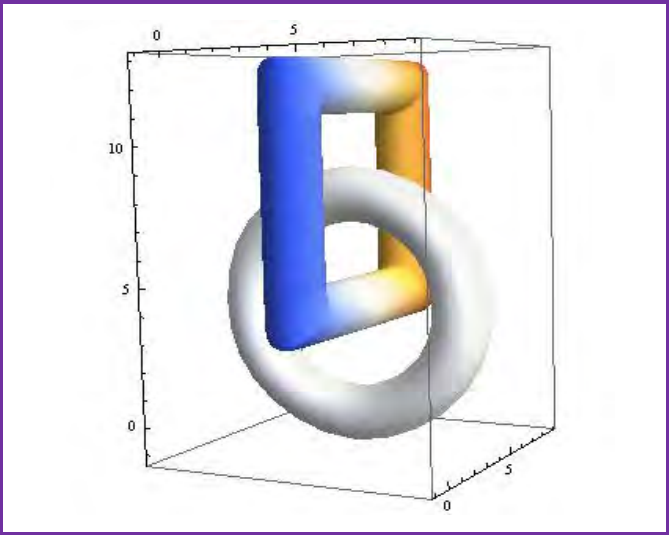
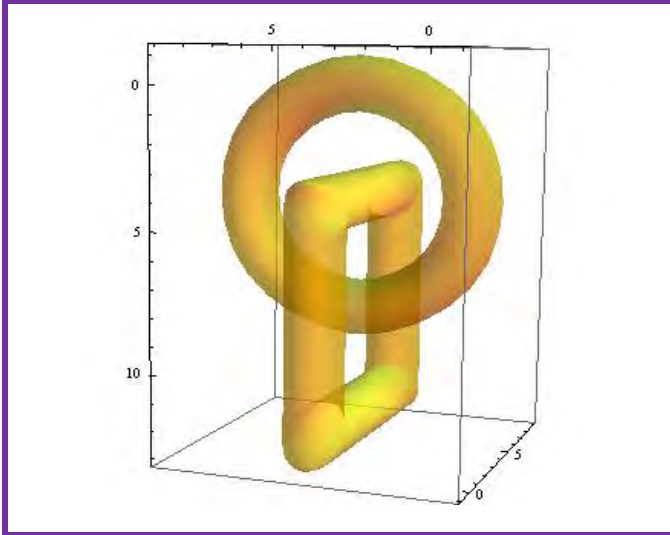
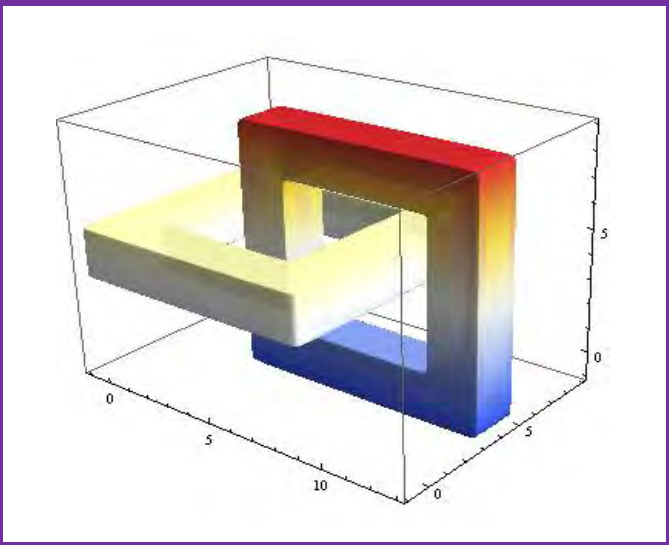
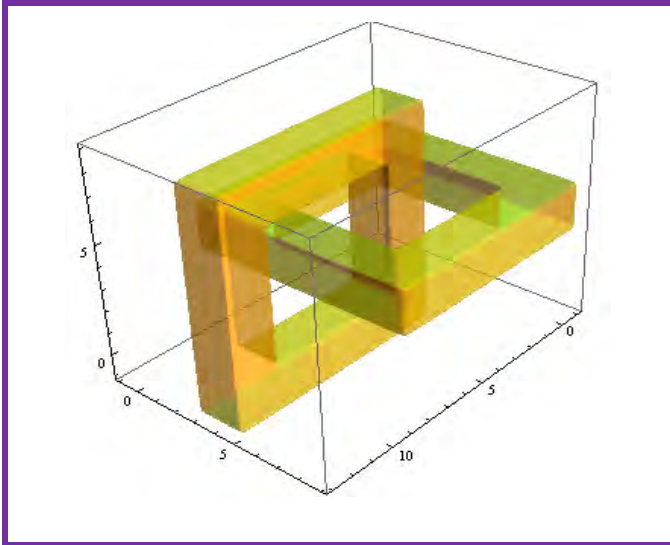

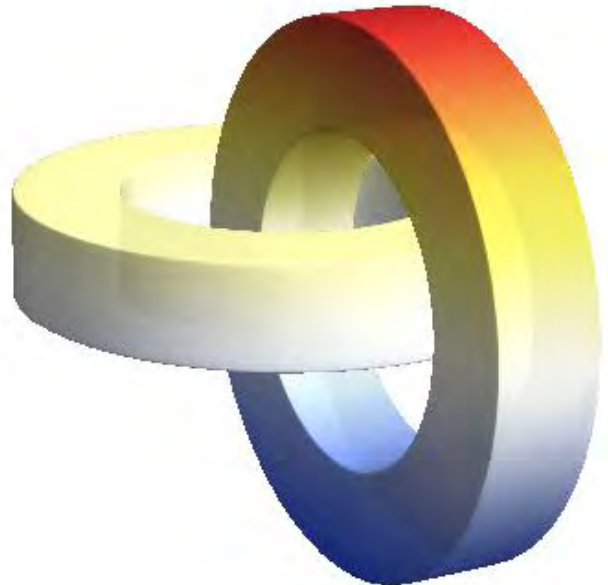
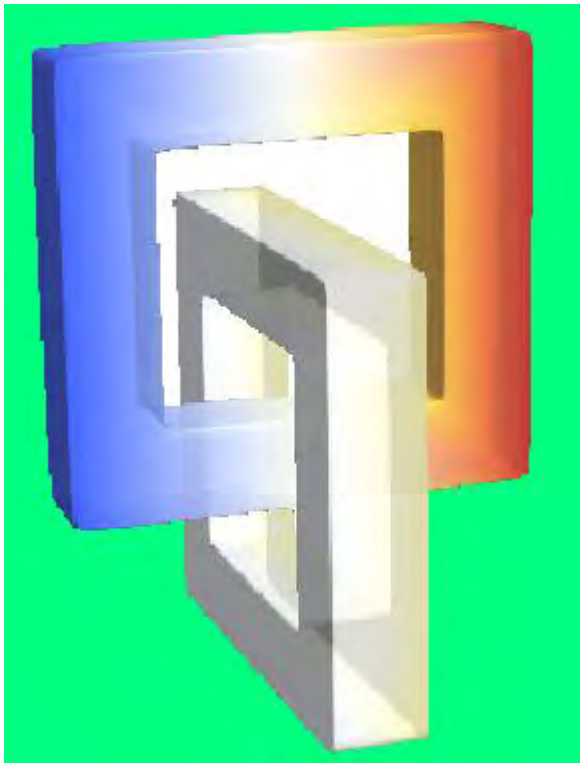



FLOWERS

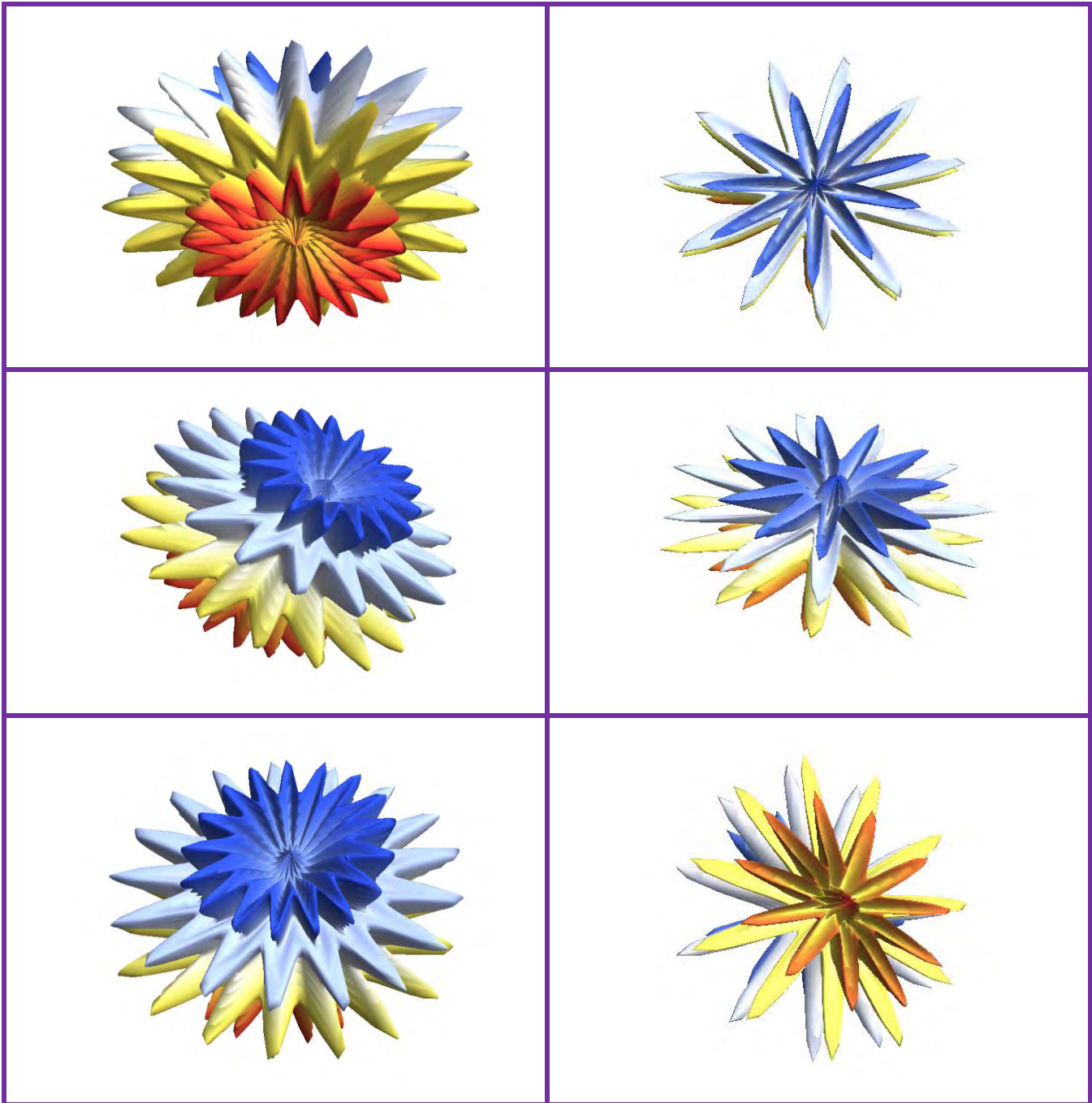



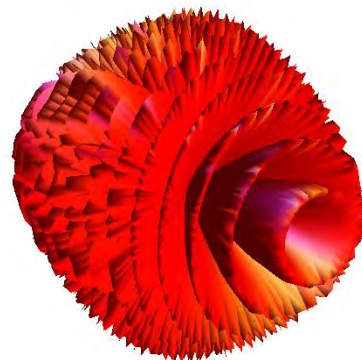
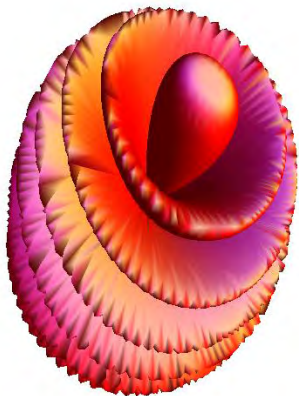
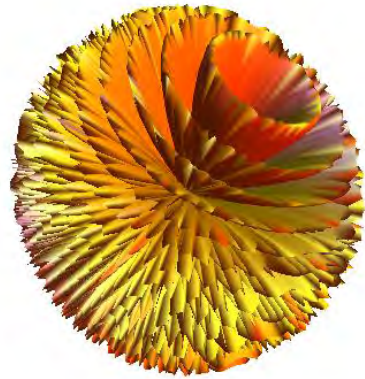
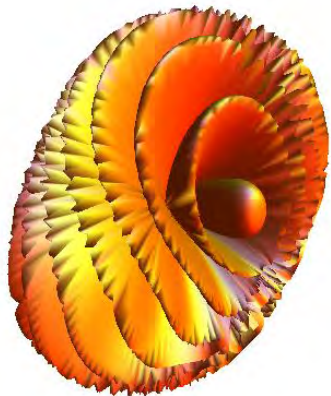
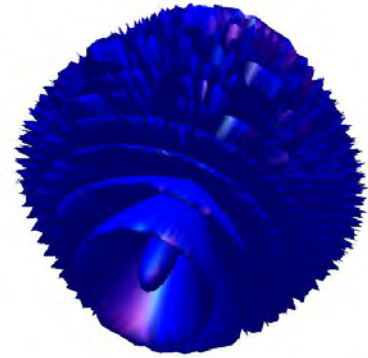
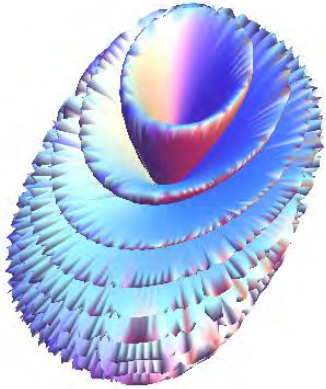

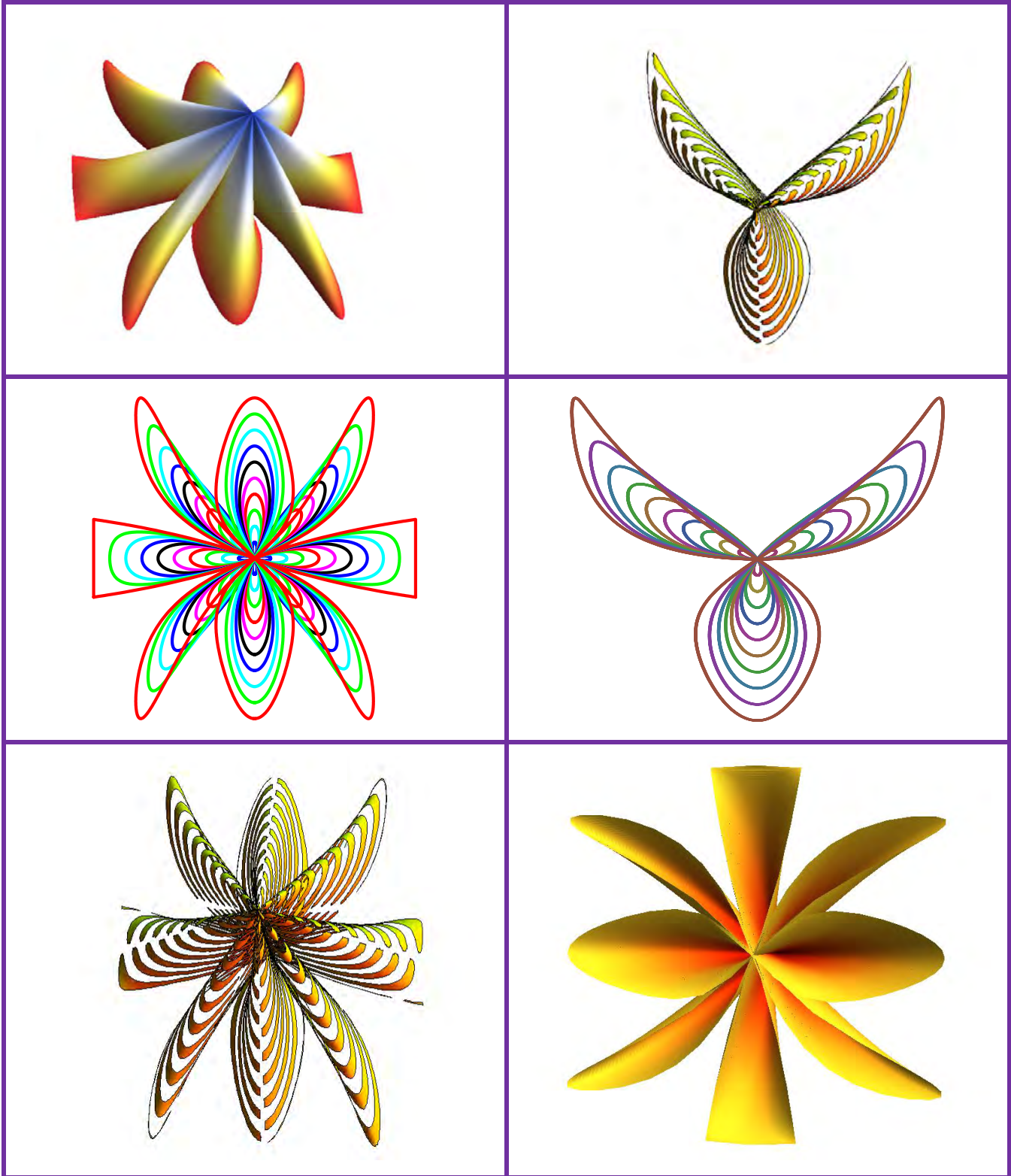

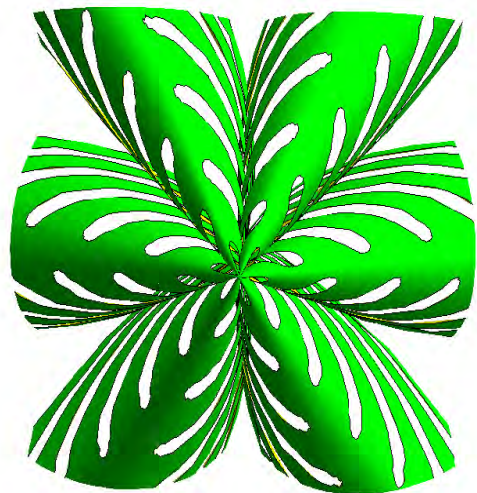
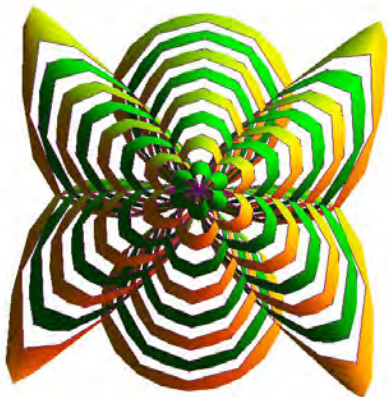
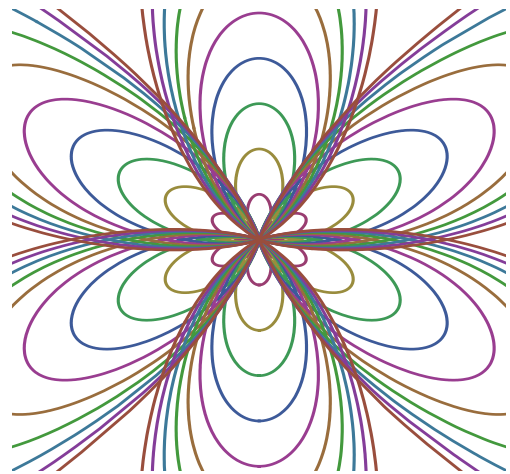
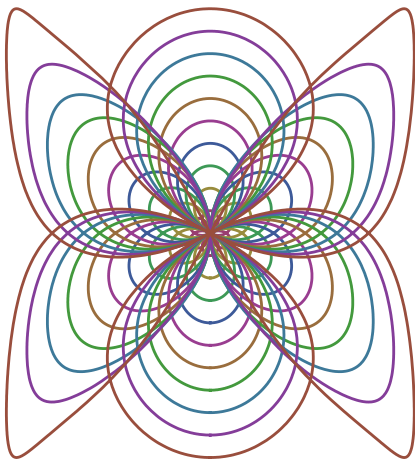
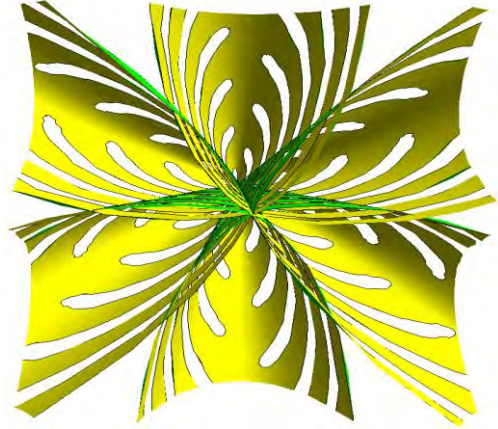
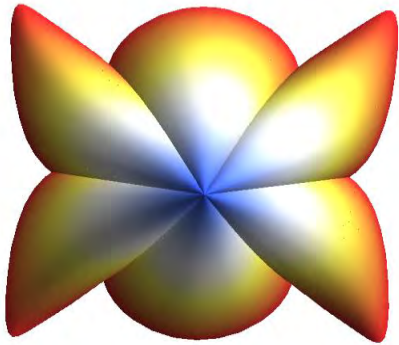



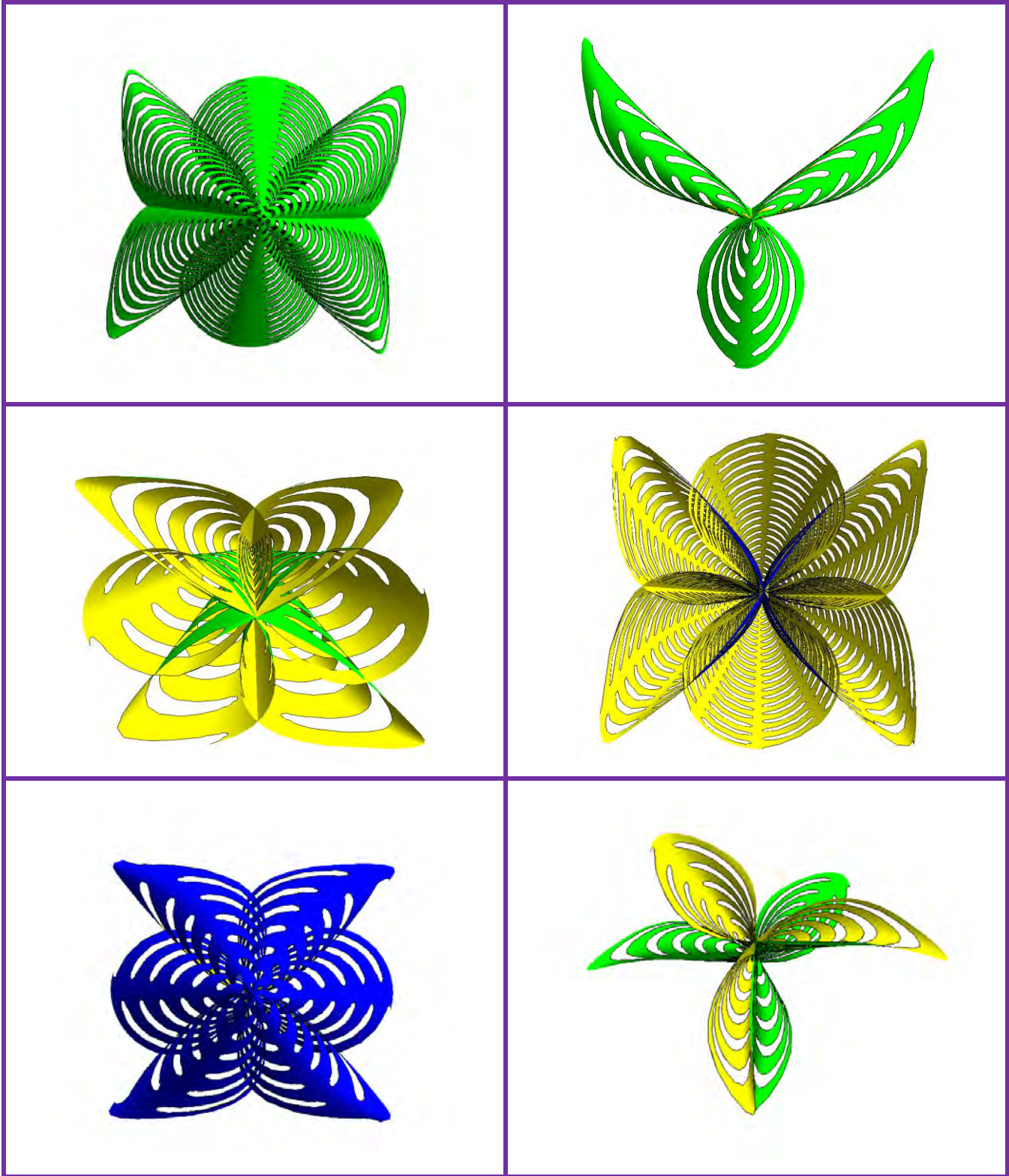



## VASES

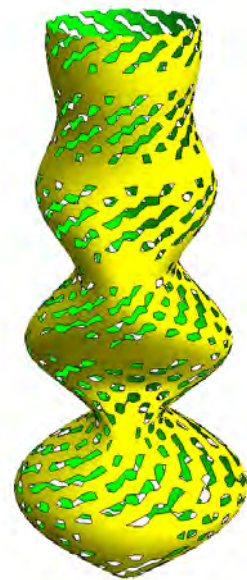
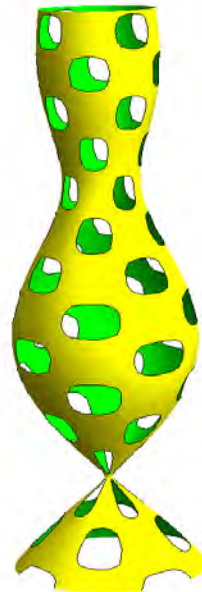
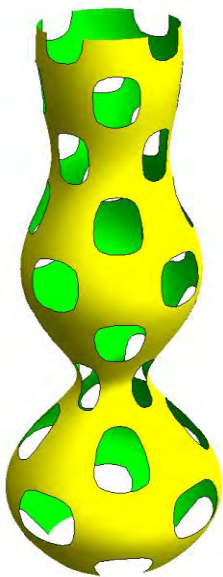
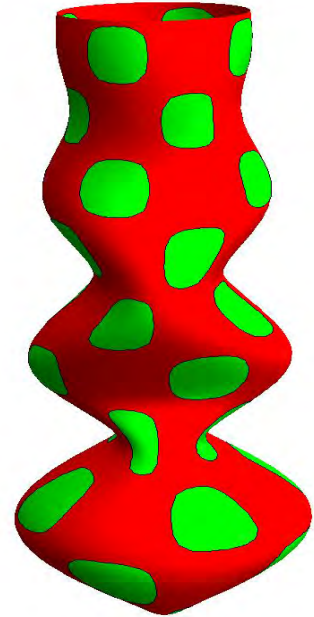
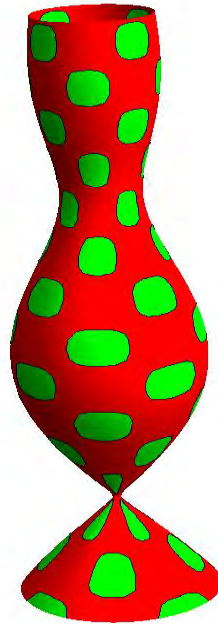
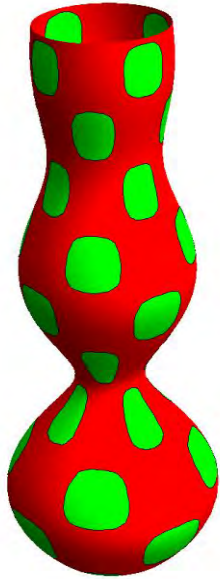

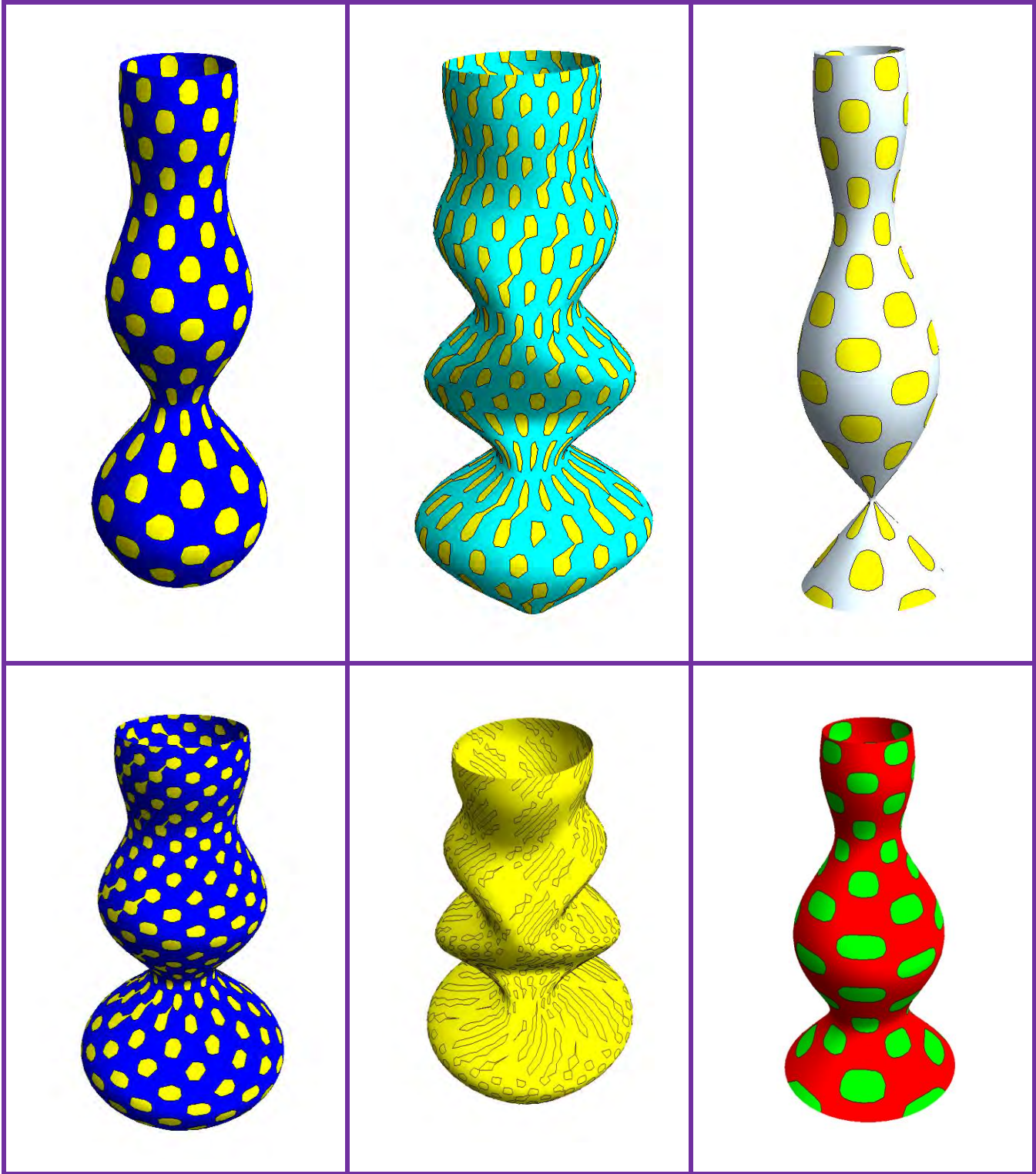

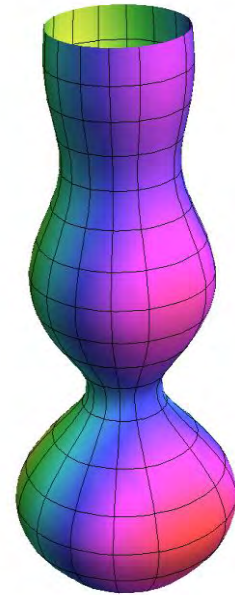
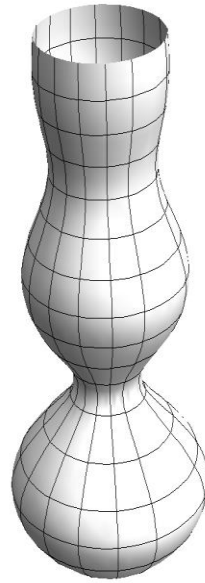
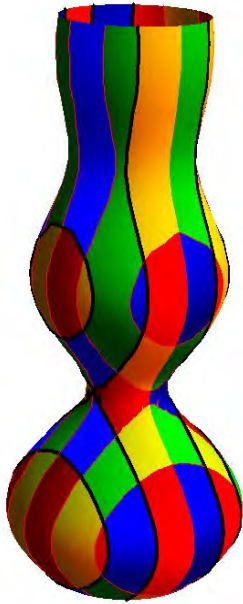



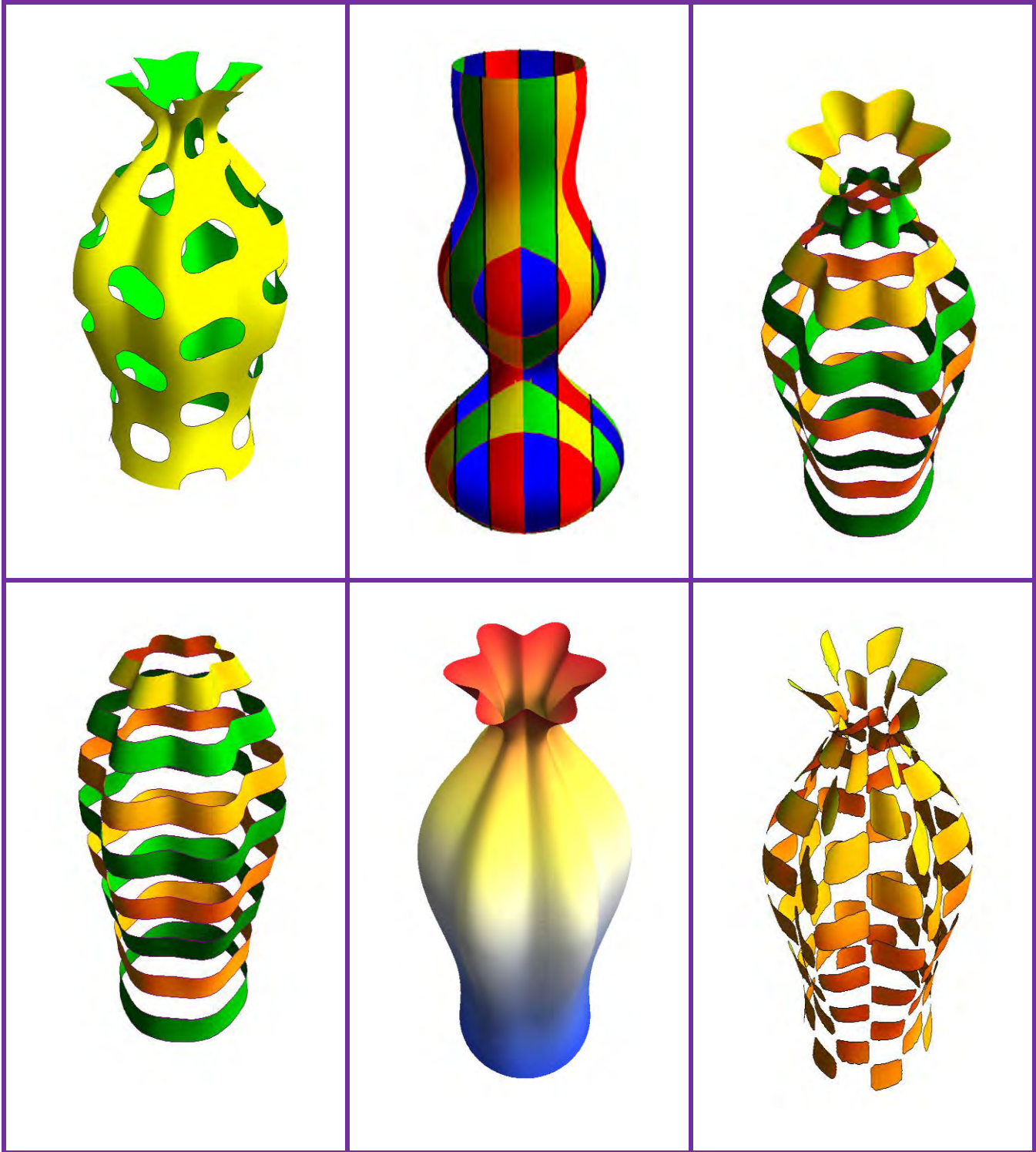



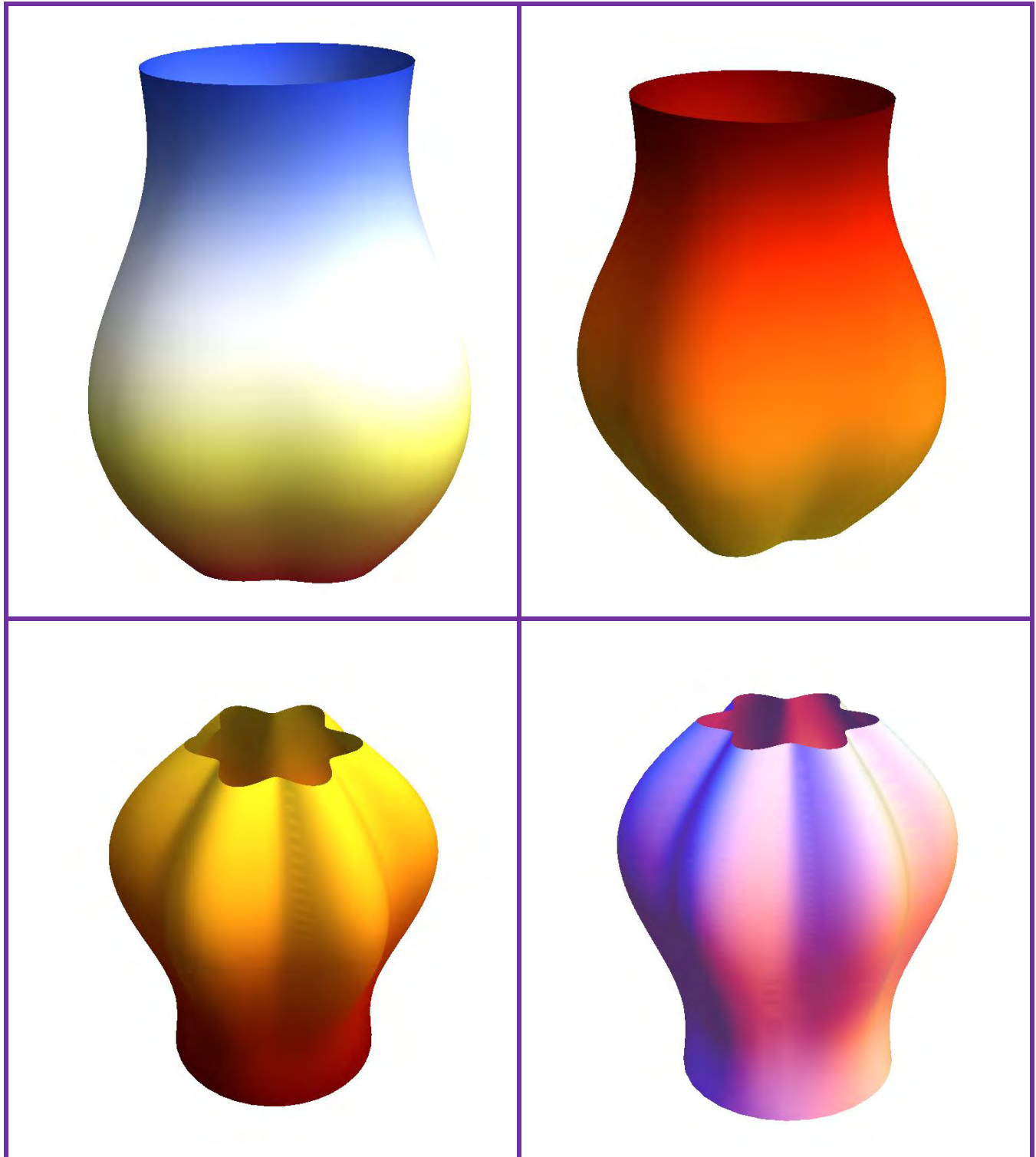

BLUE APPEARINGS IN THREE VIEWS

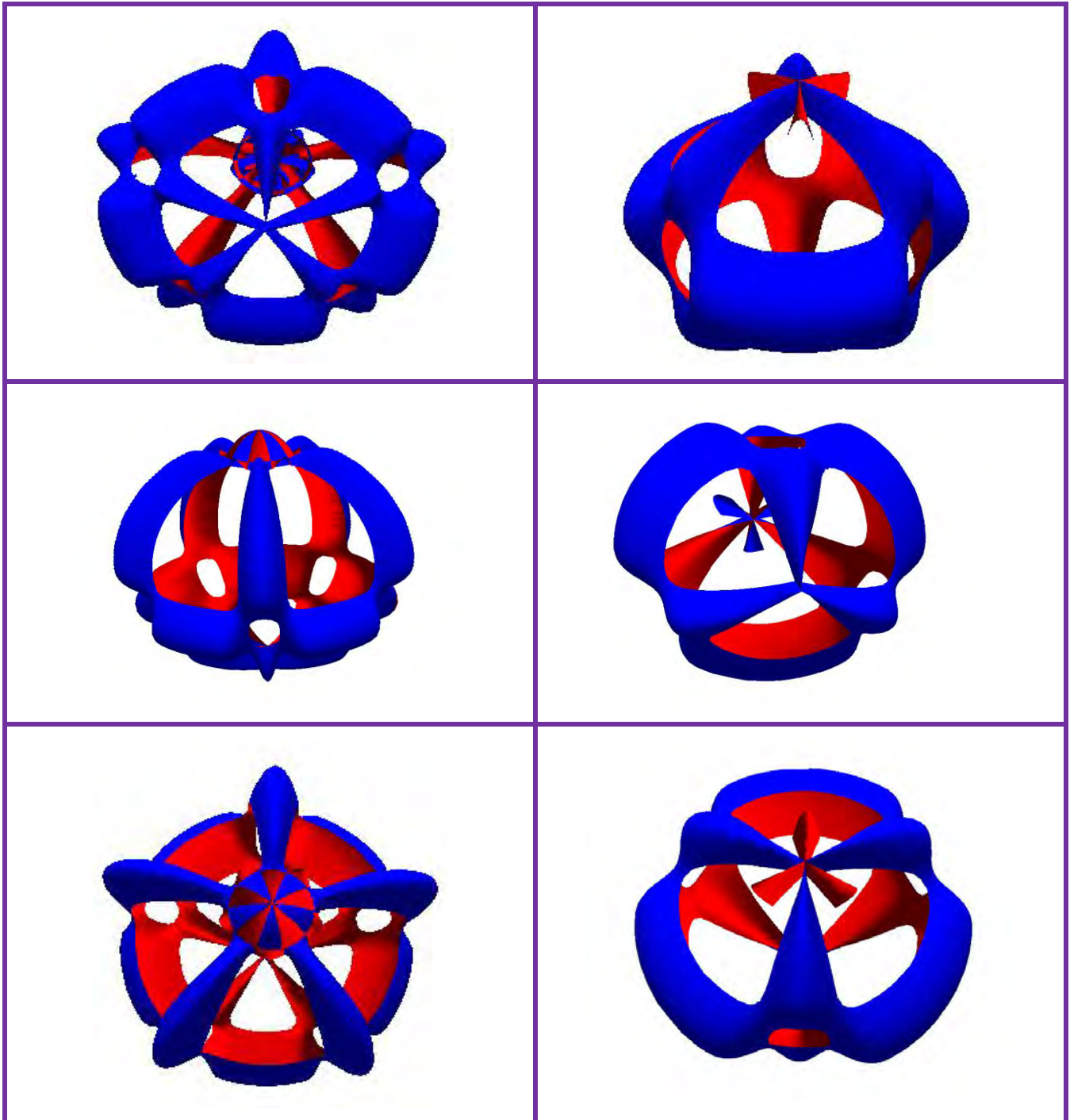

## YELLOW APPEARINGS IN THREE VIEWS

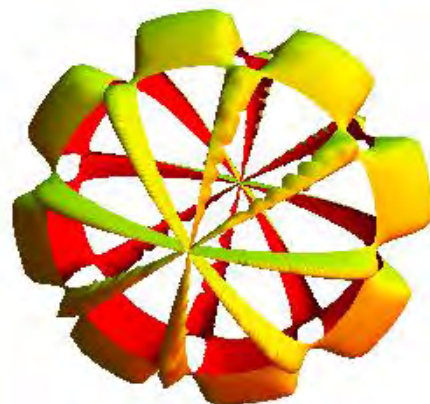
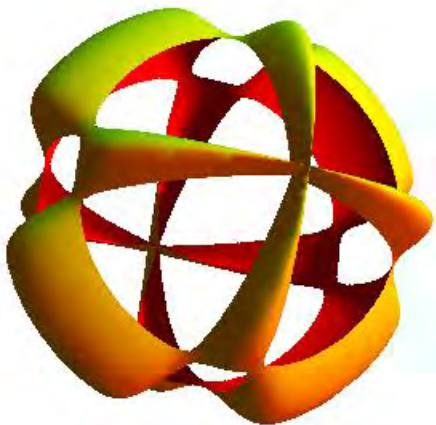
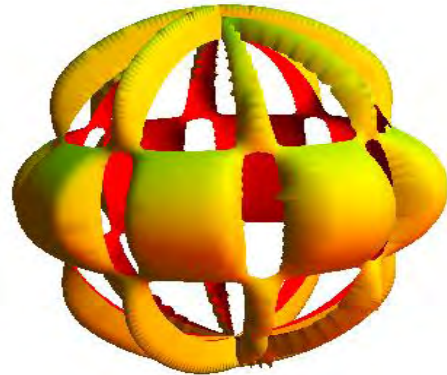
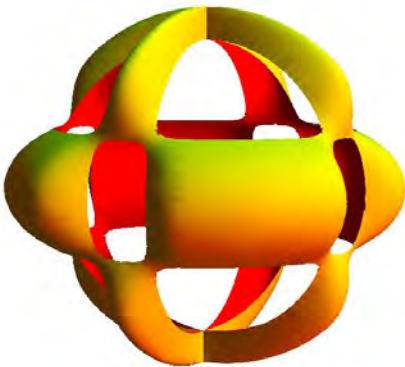
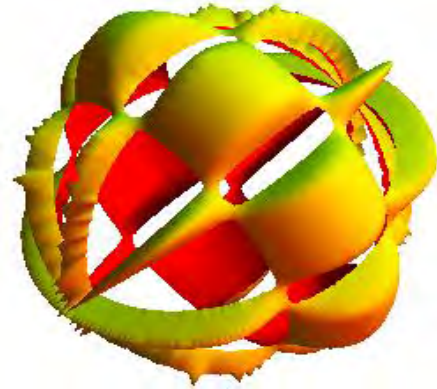
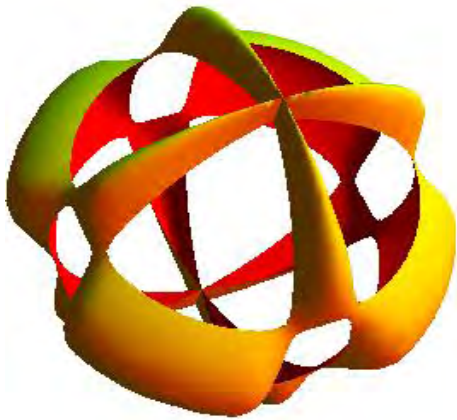

RED APPEARINGS IN THREE VIEWS

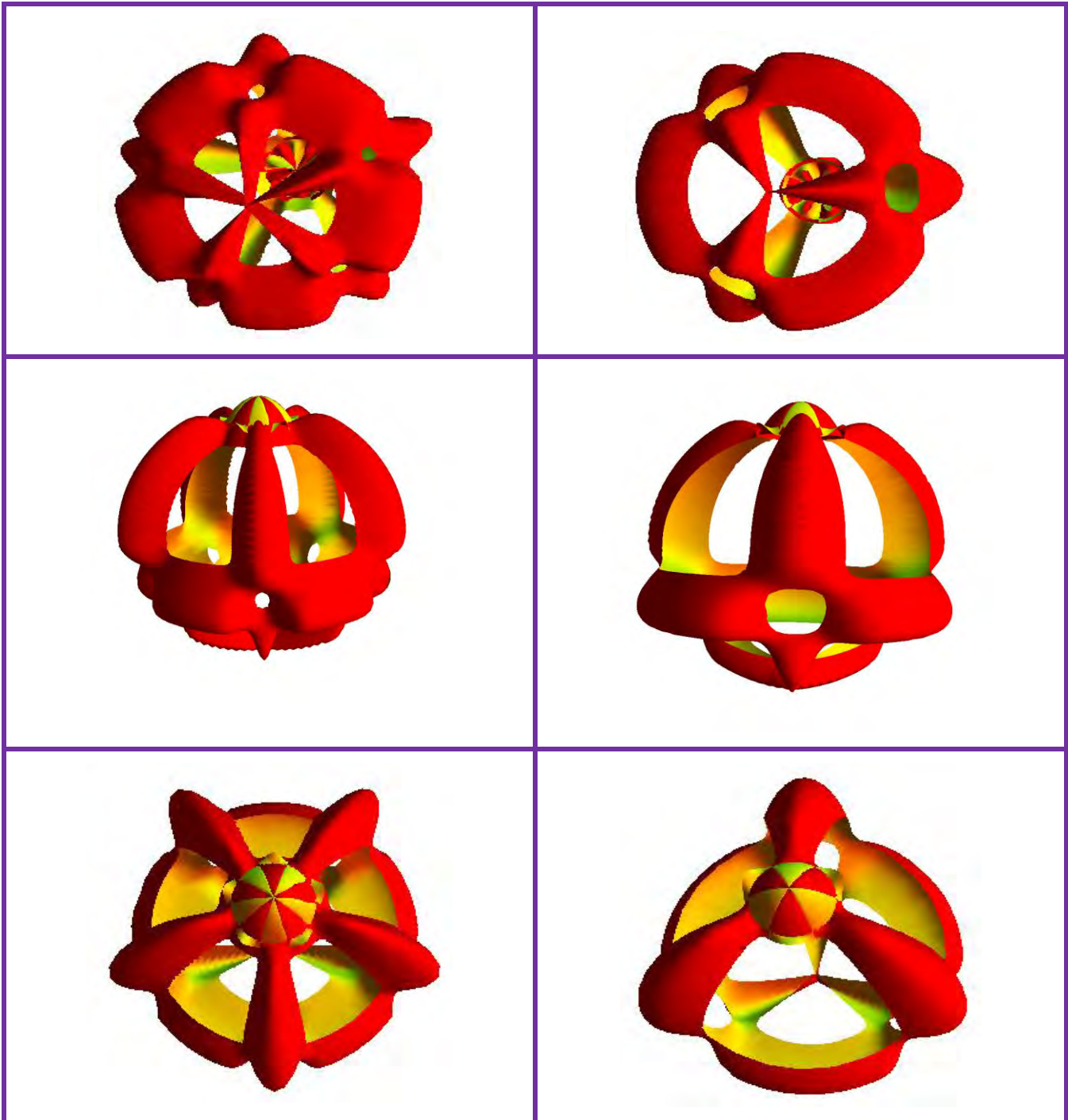



## CYAN APPEARINGS IN THREE VIEWS

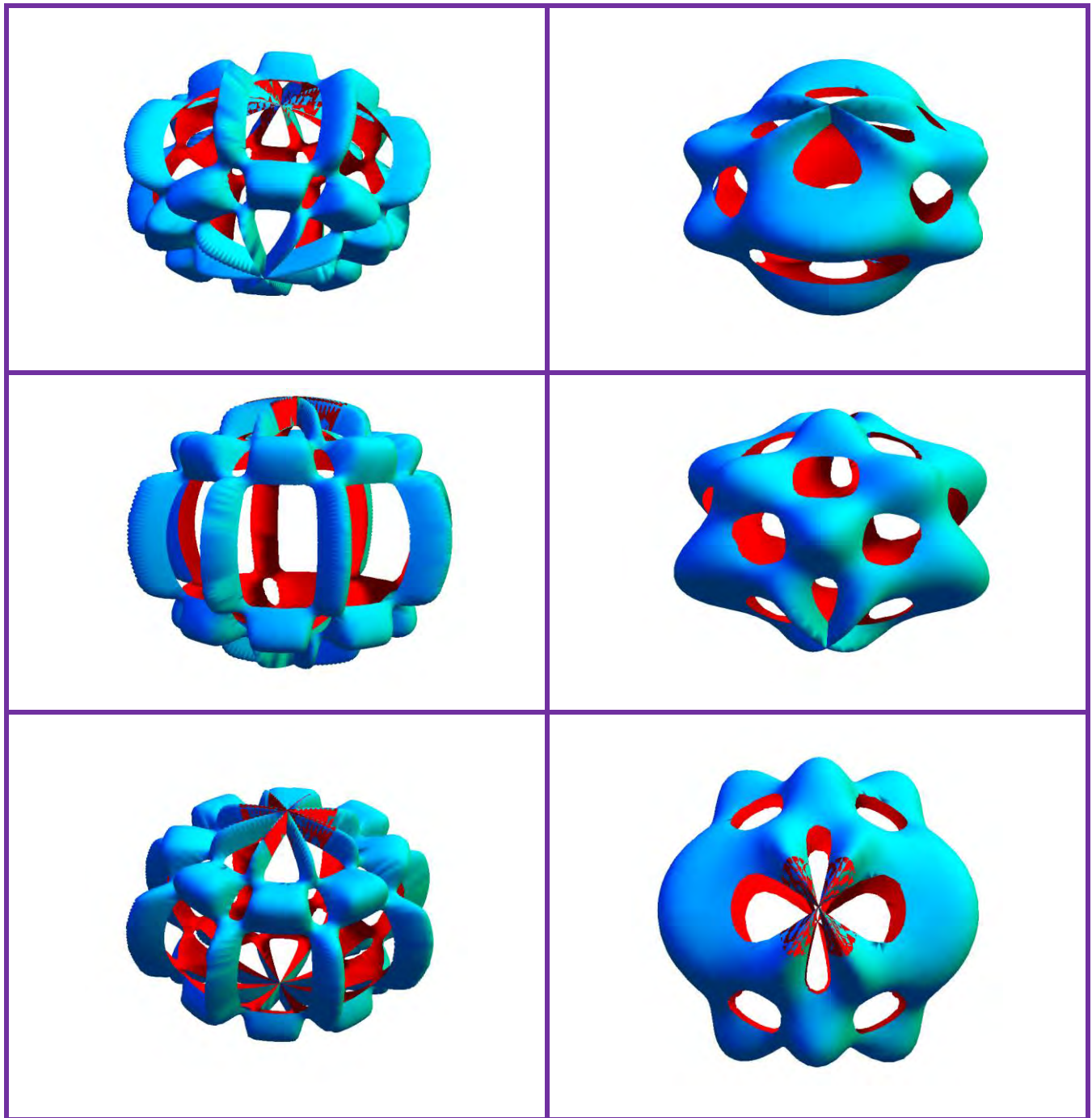

MOTTLED APPEARINGS IN THREE VIEWS

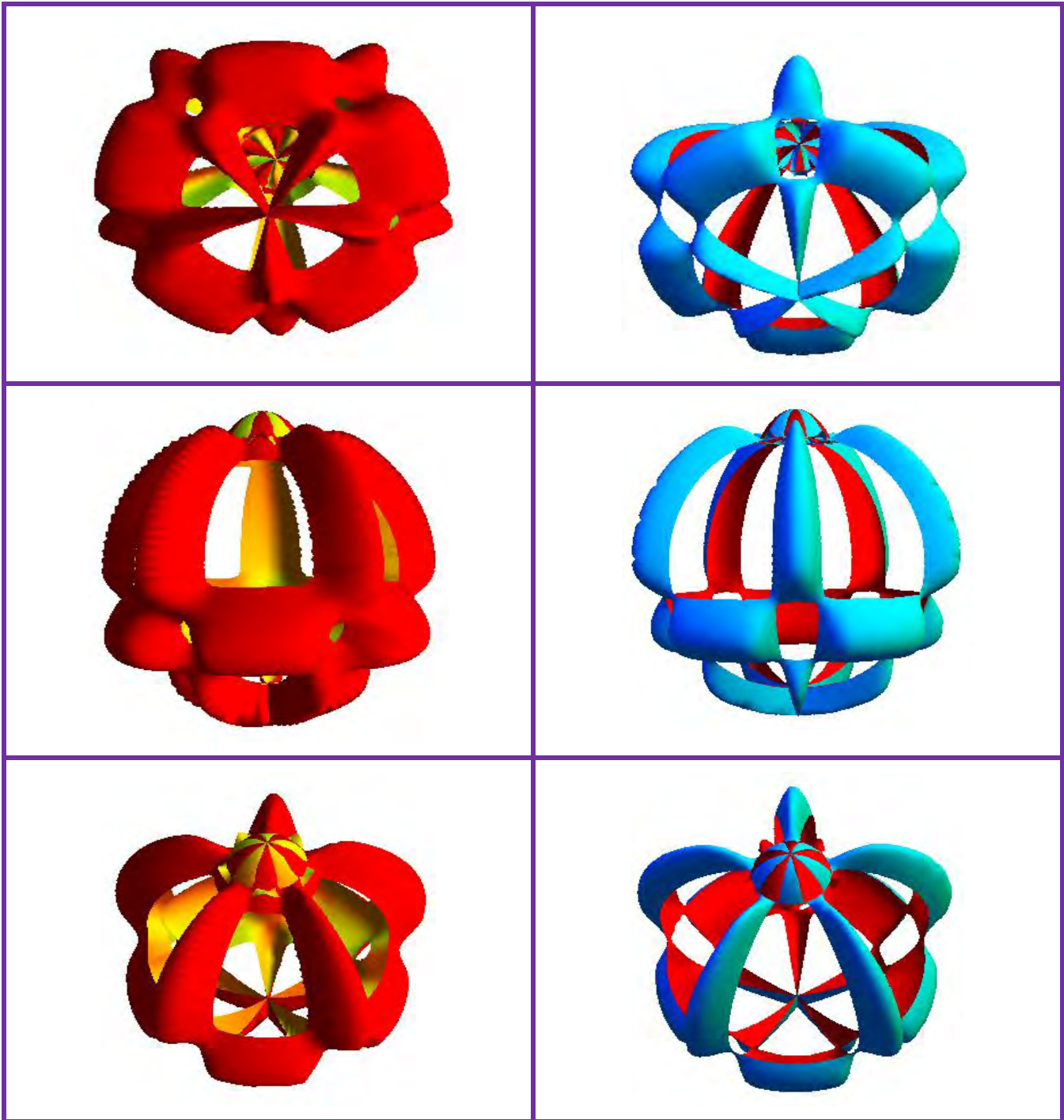

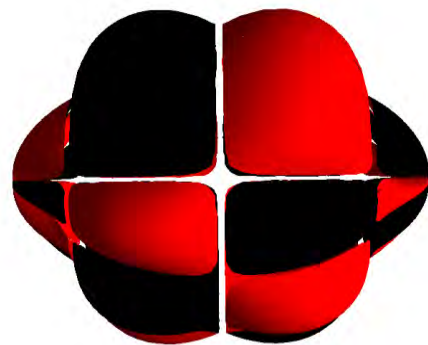
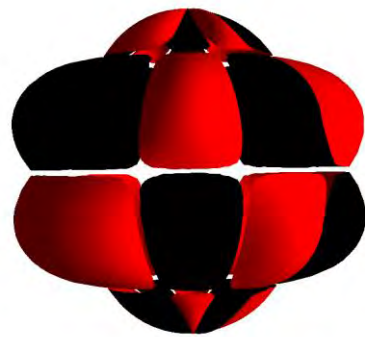
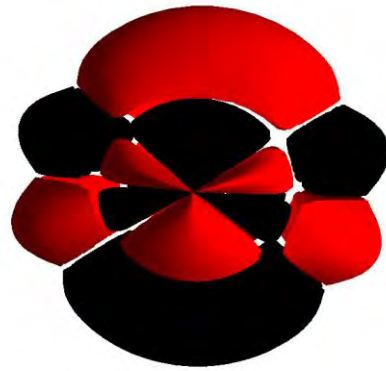
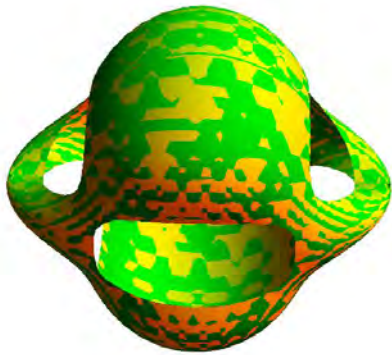



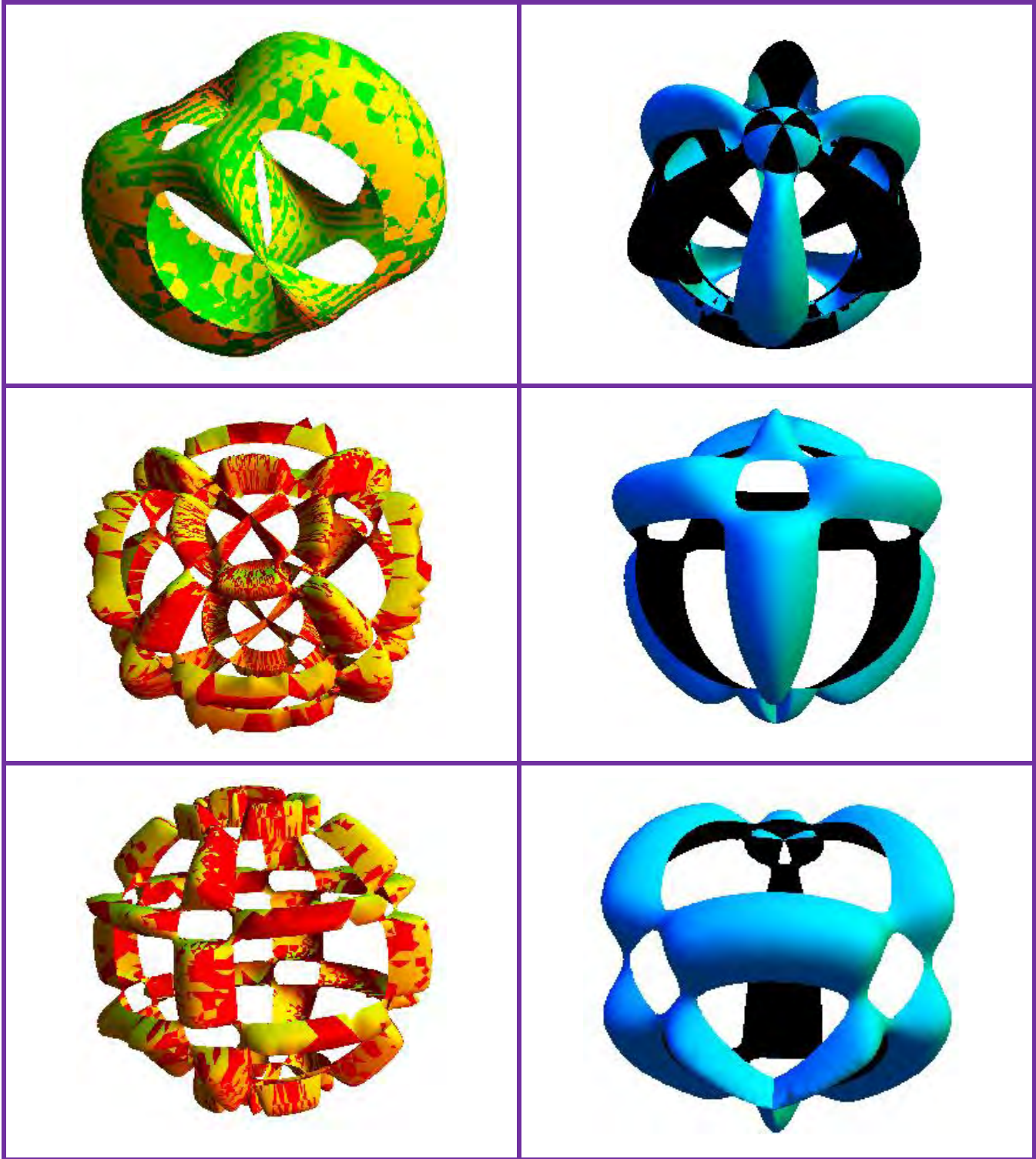



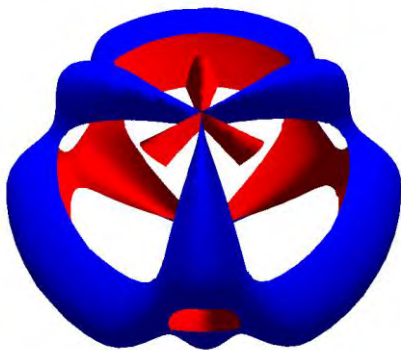
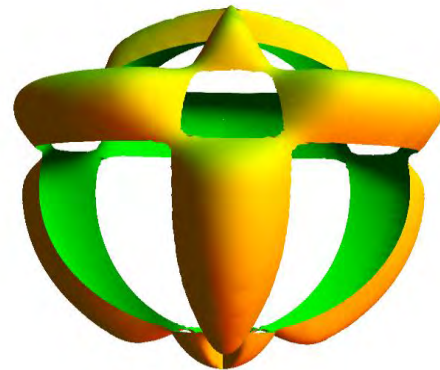
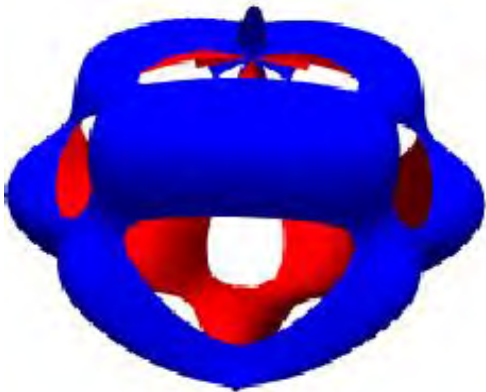
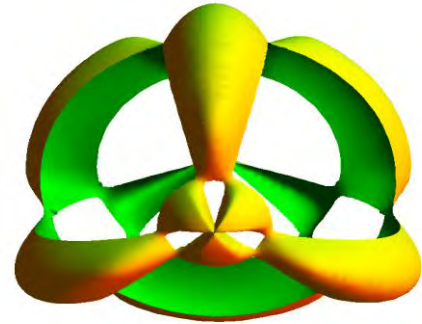
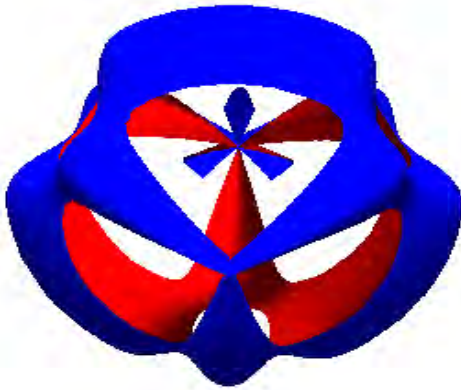

MESH ART OBJECTS

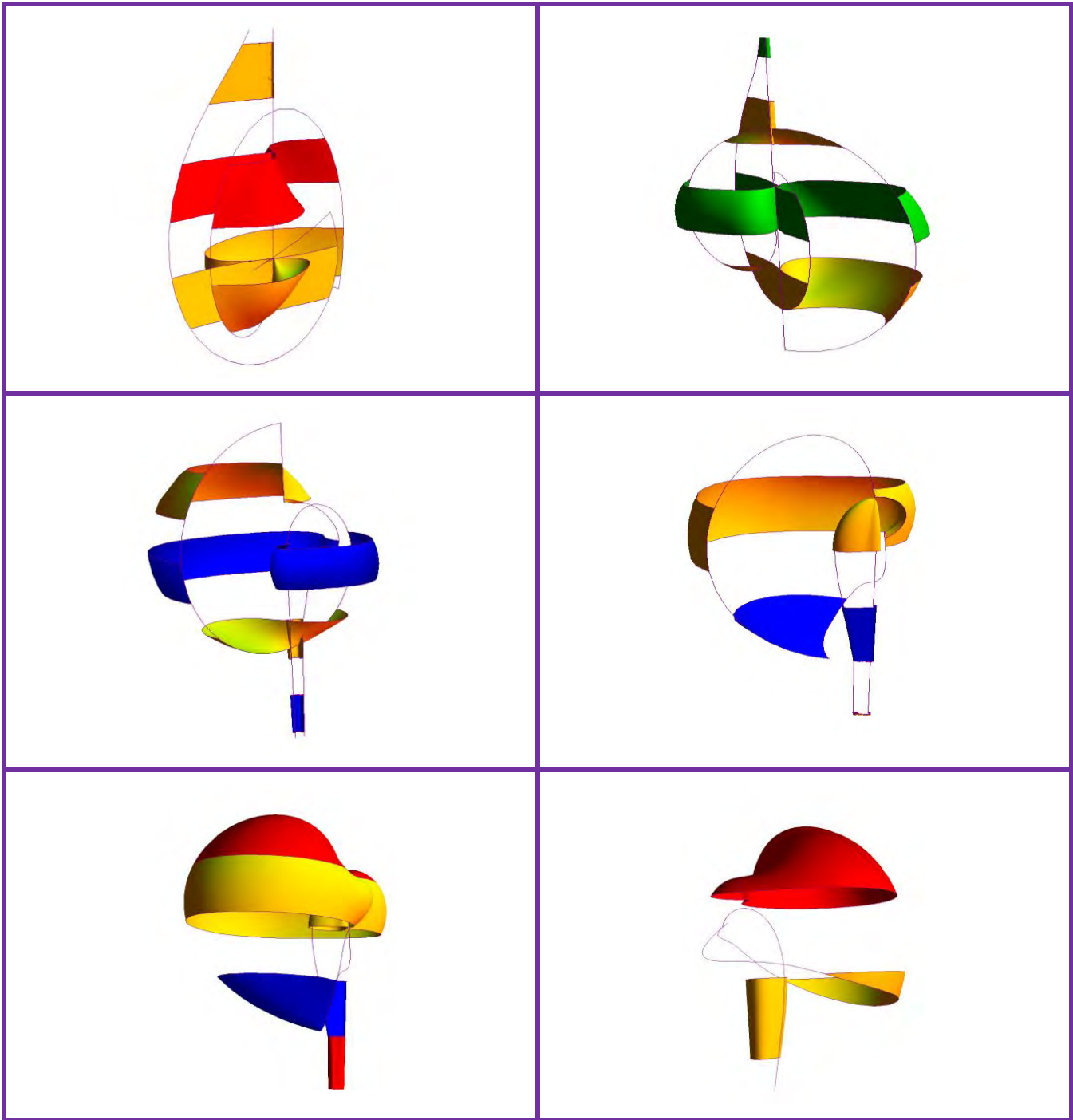

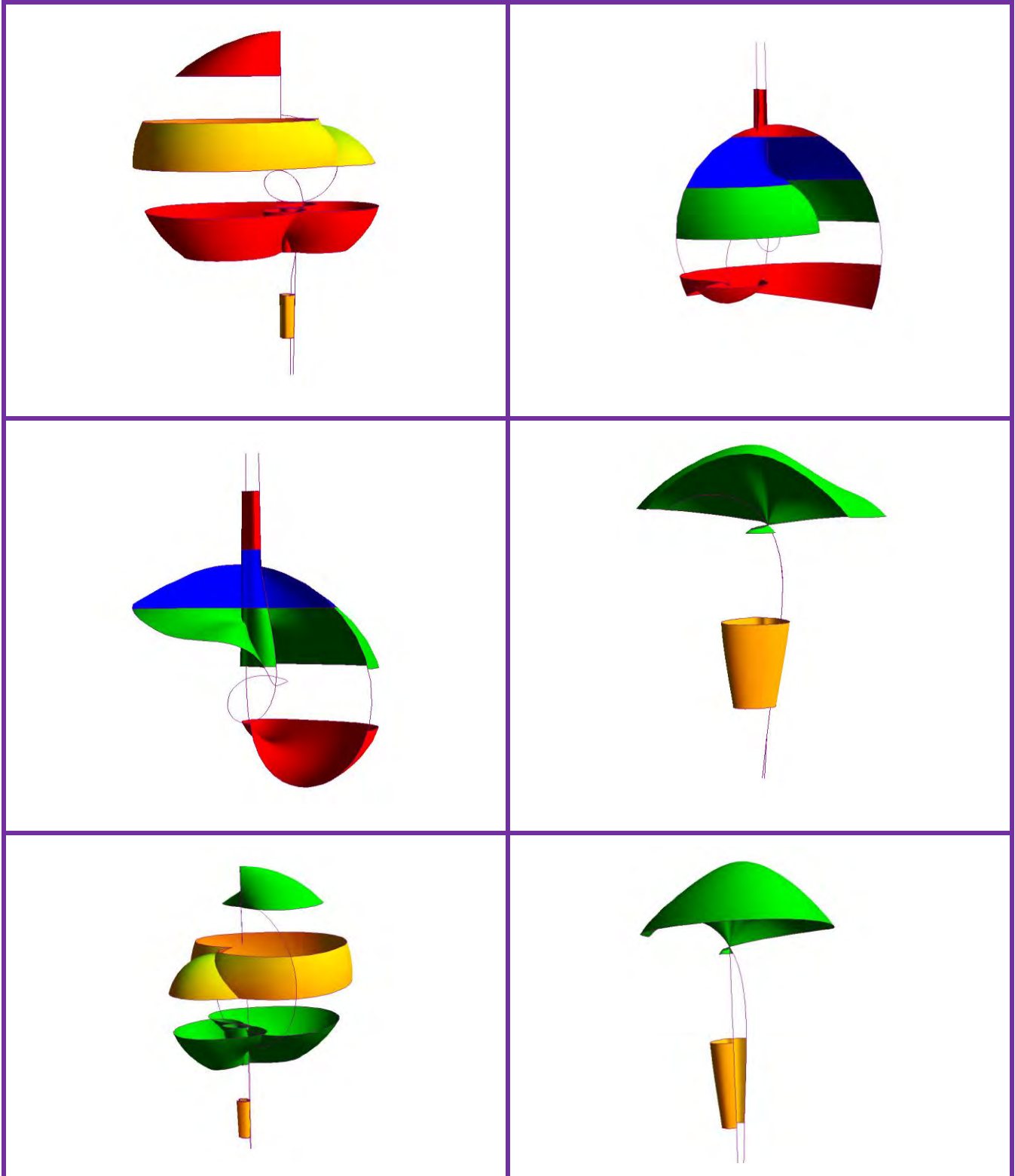

ROMANIAN FOLK DANCE

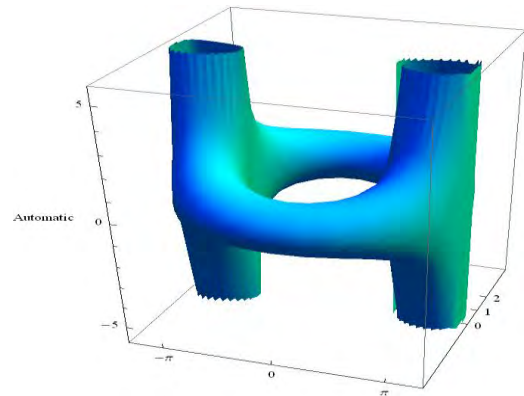
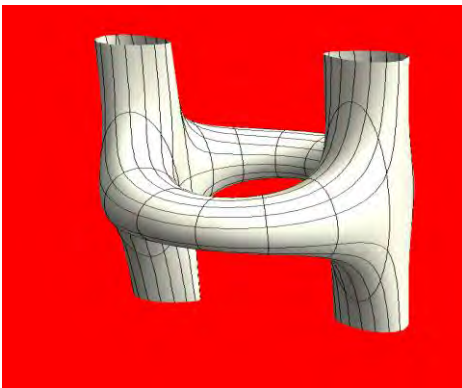
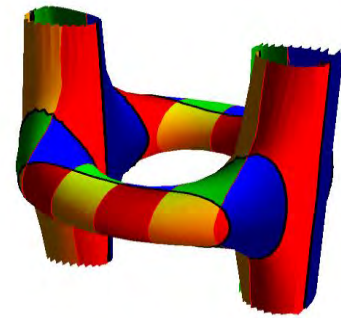
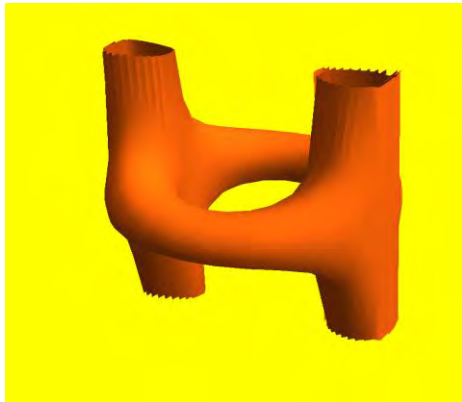
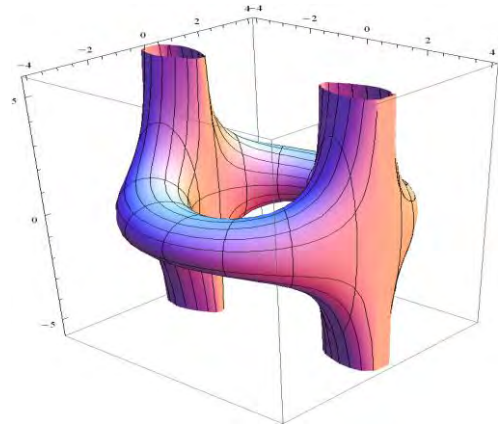
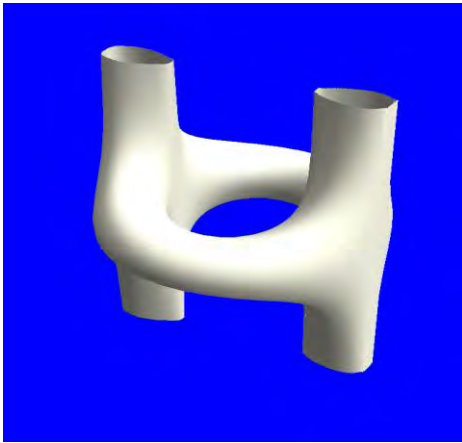



## COLORFUL SUPERMATHEMATIC TOROIDS

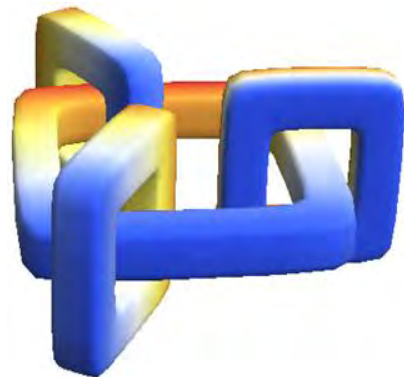
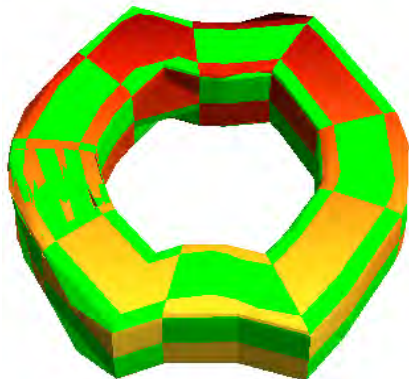
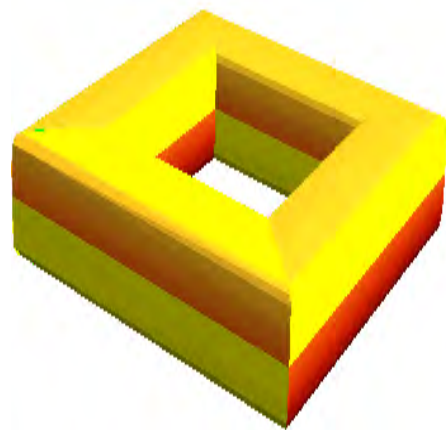
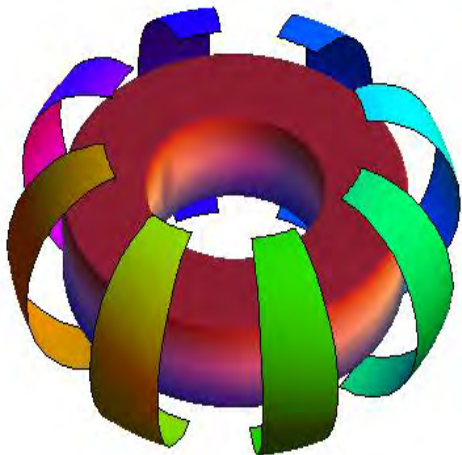
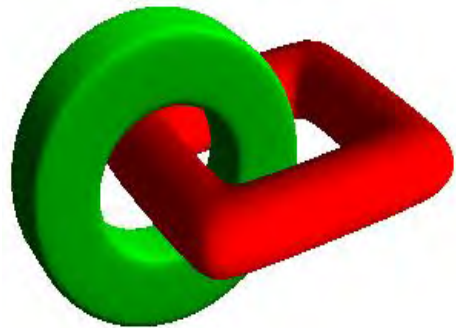
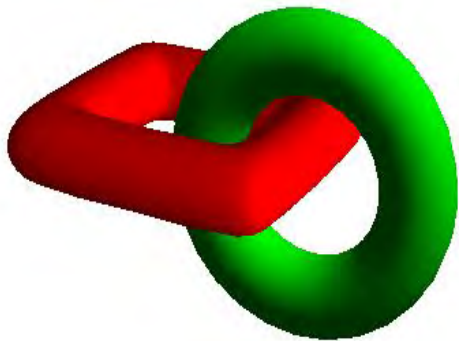

EX-CENTRIC SNAILS

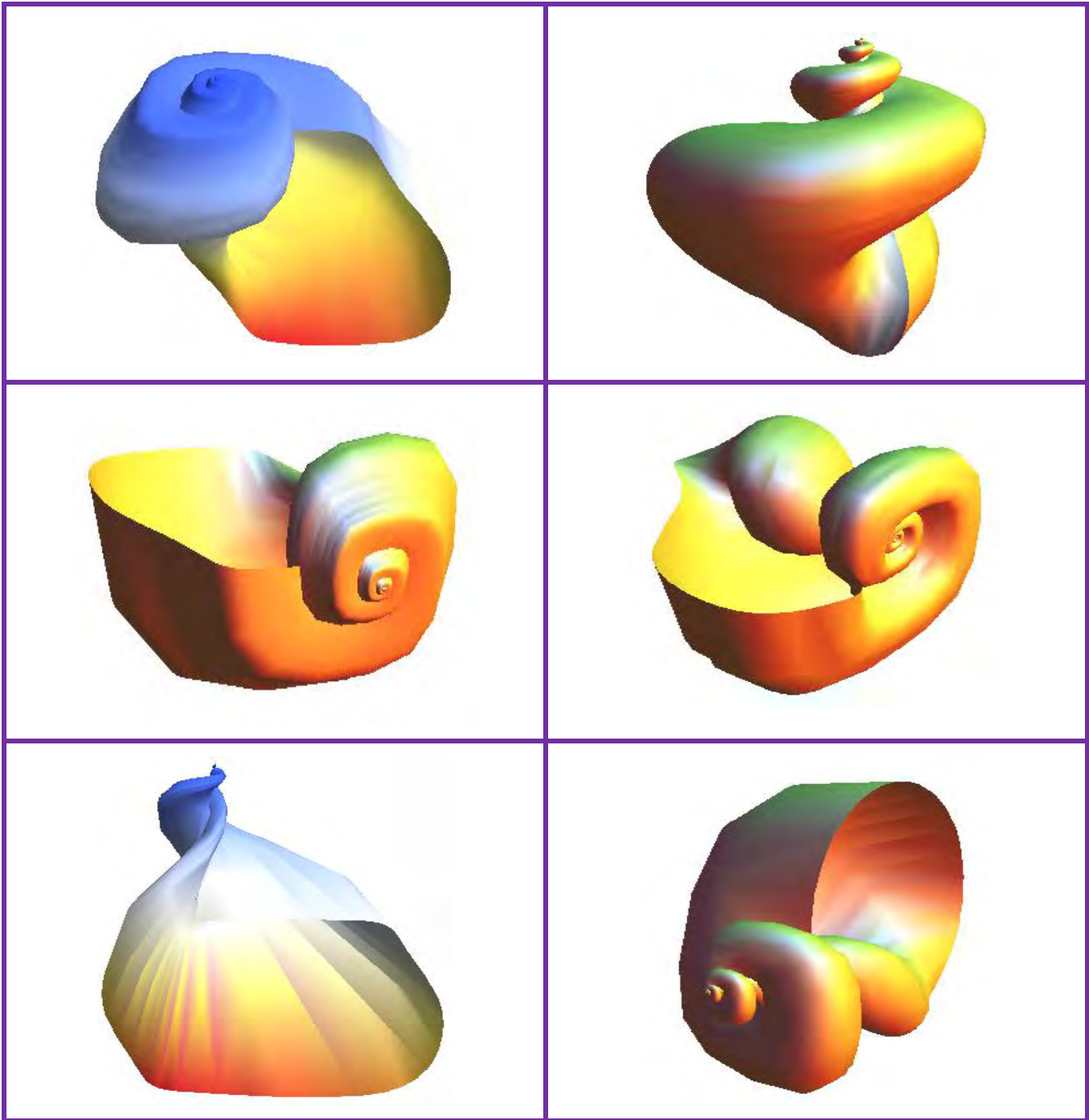

## ARTIFICIAL FLOWERS

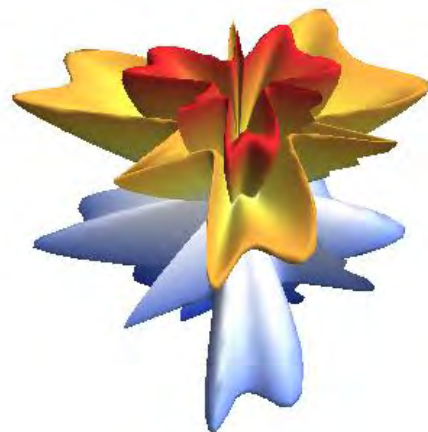
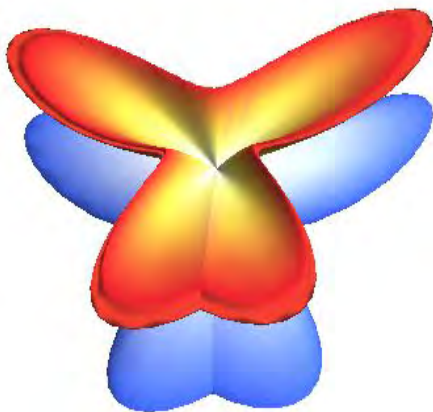
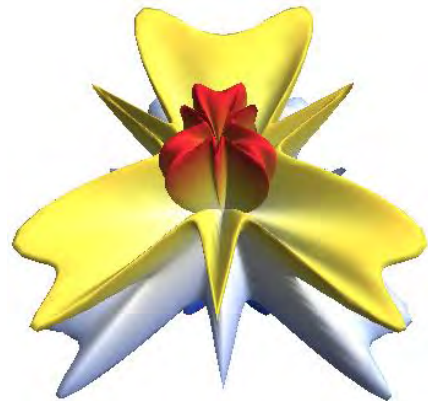
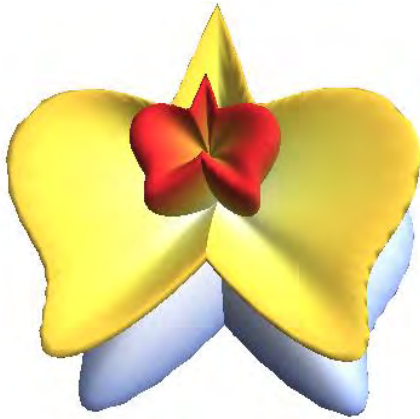

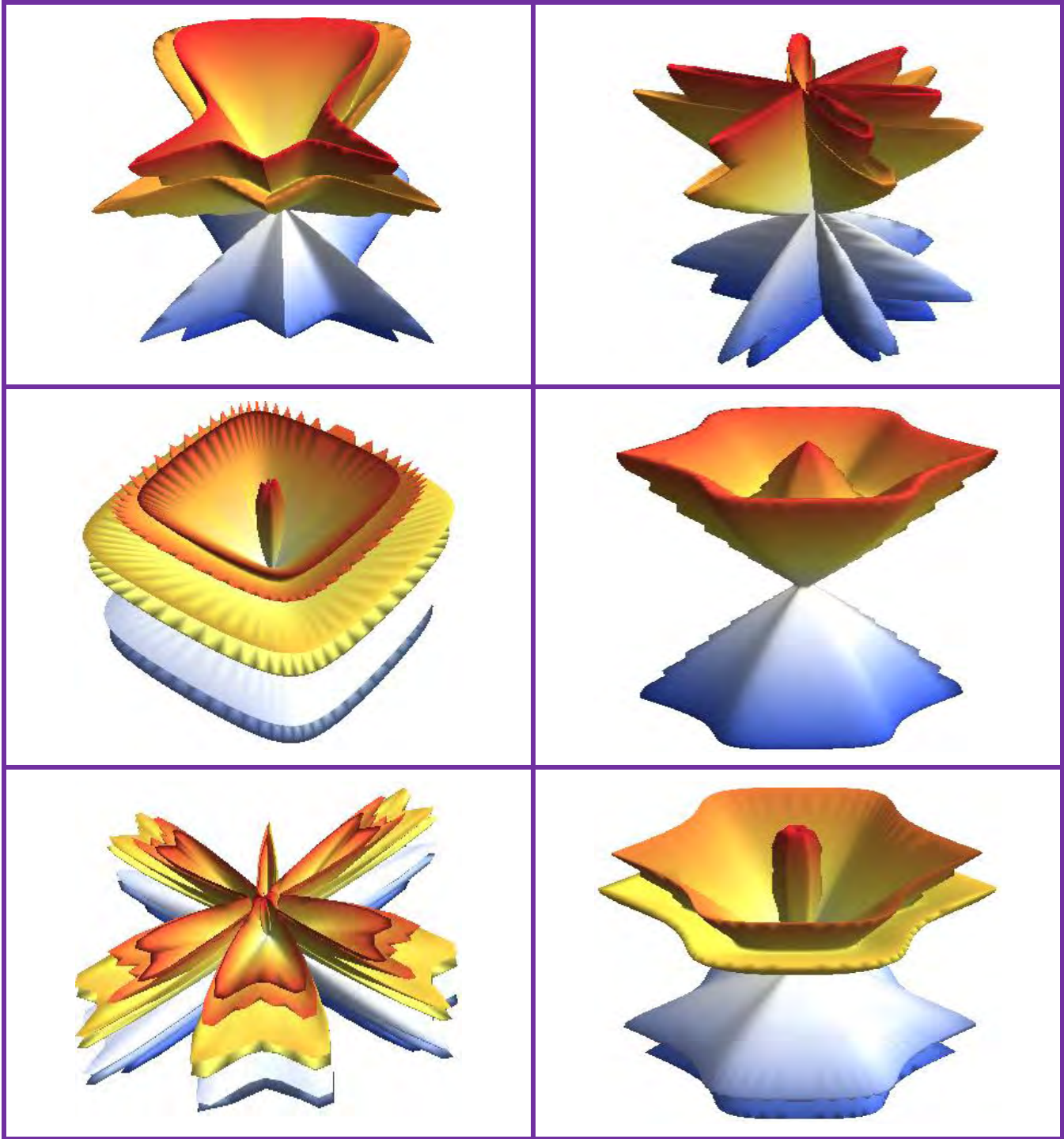



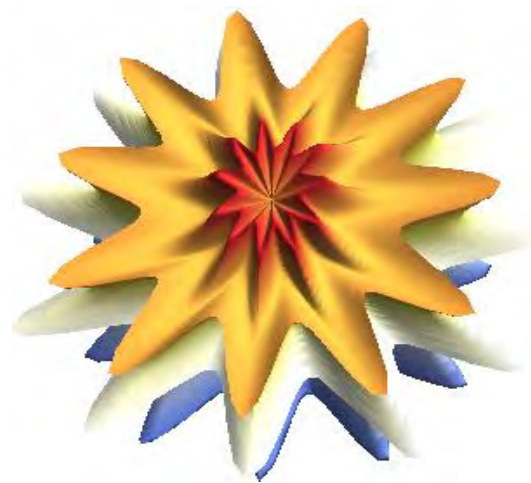
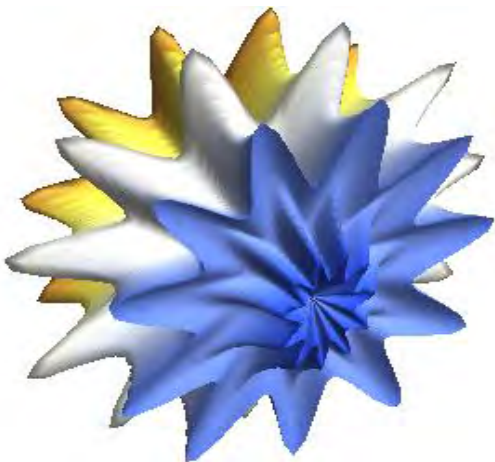
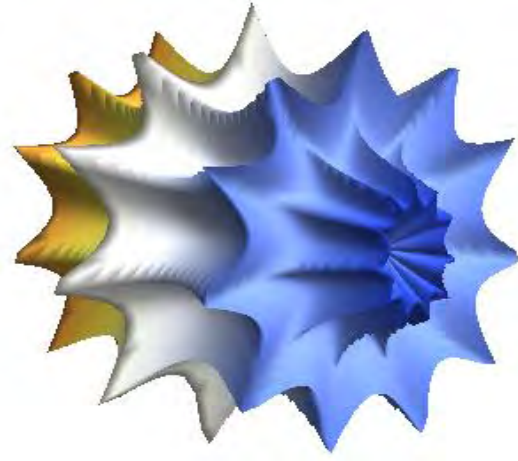
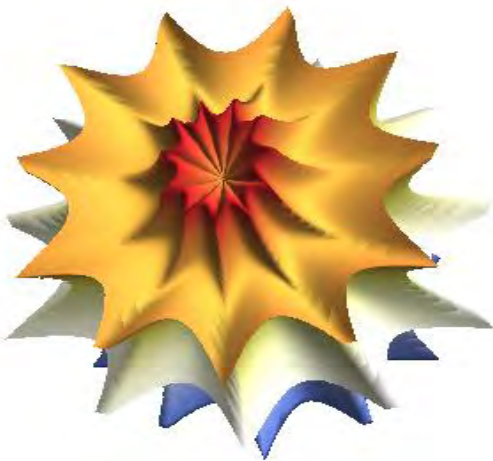
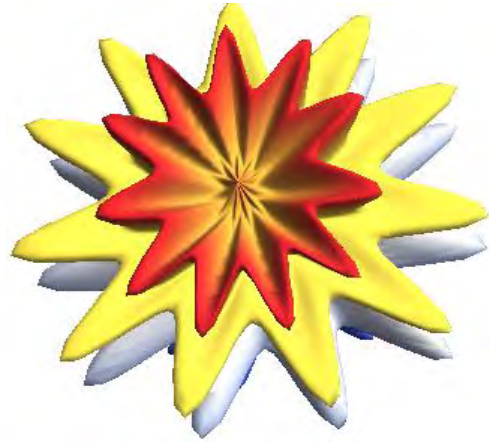
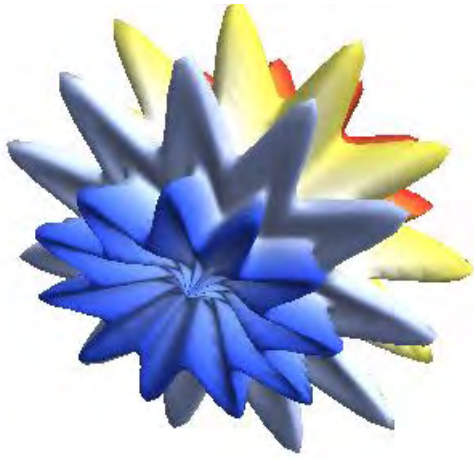

APPEARINGS ON GEOMETRIC FORMS

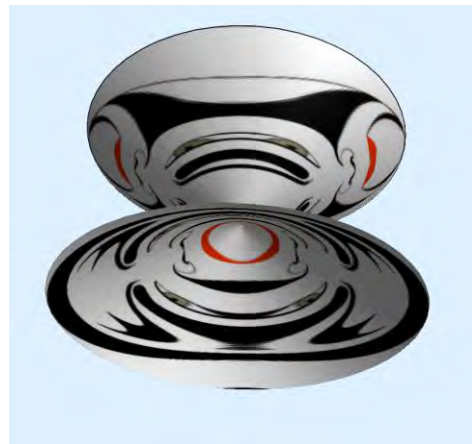
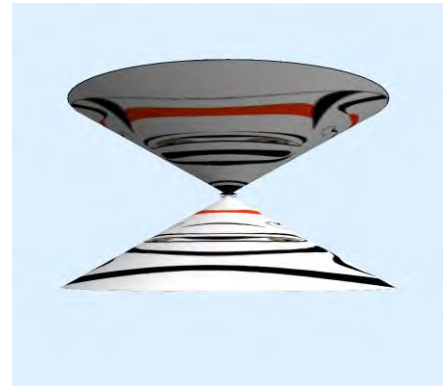



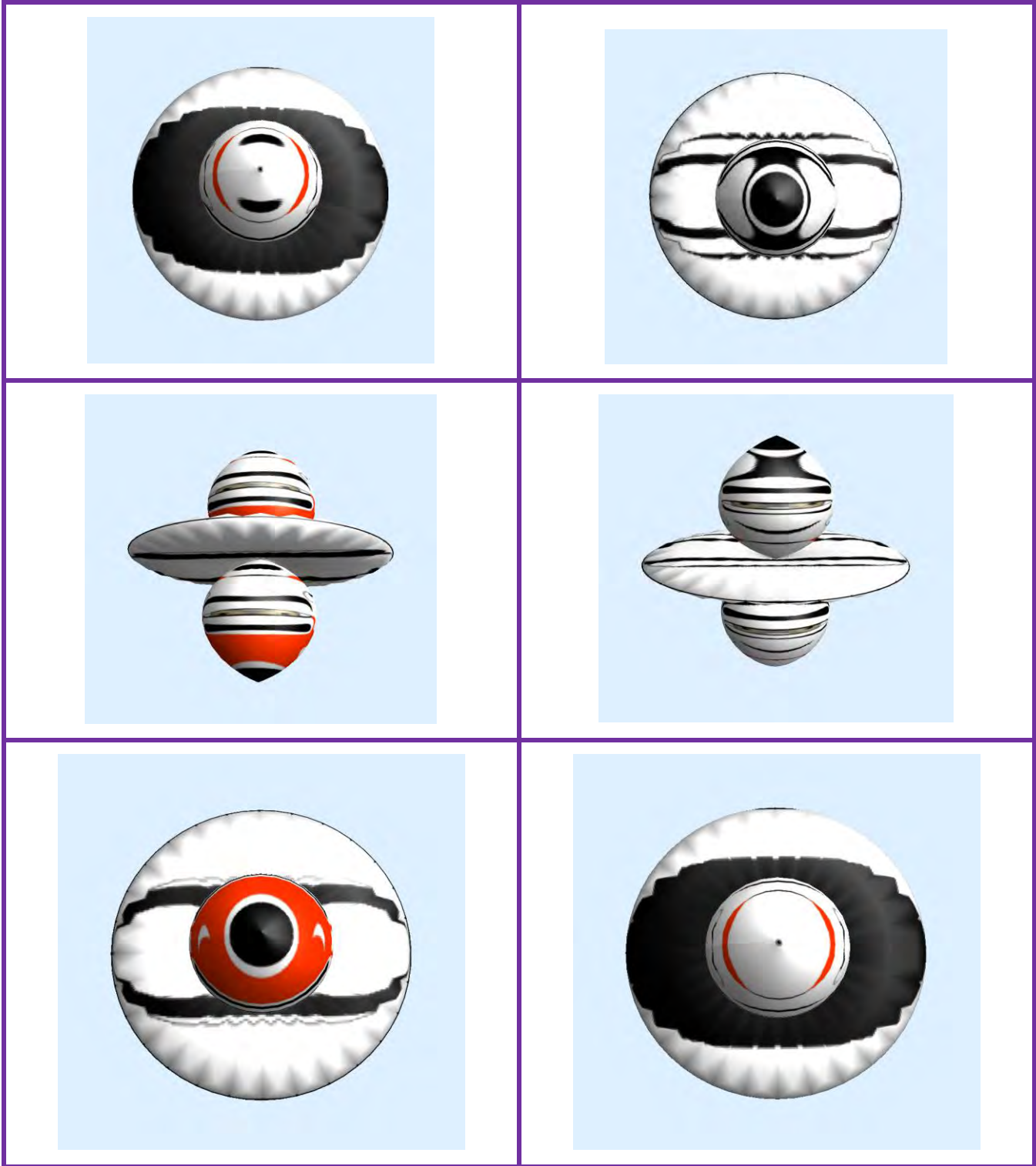



## JELLIES

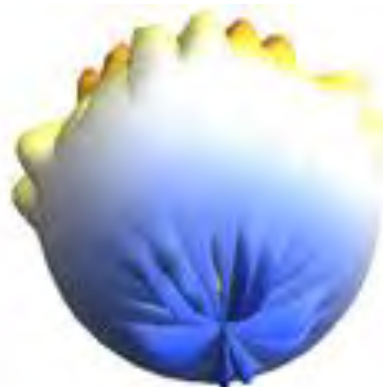

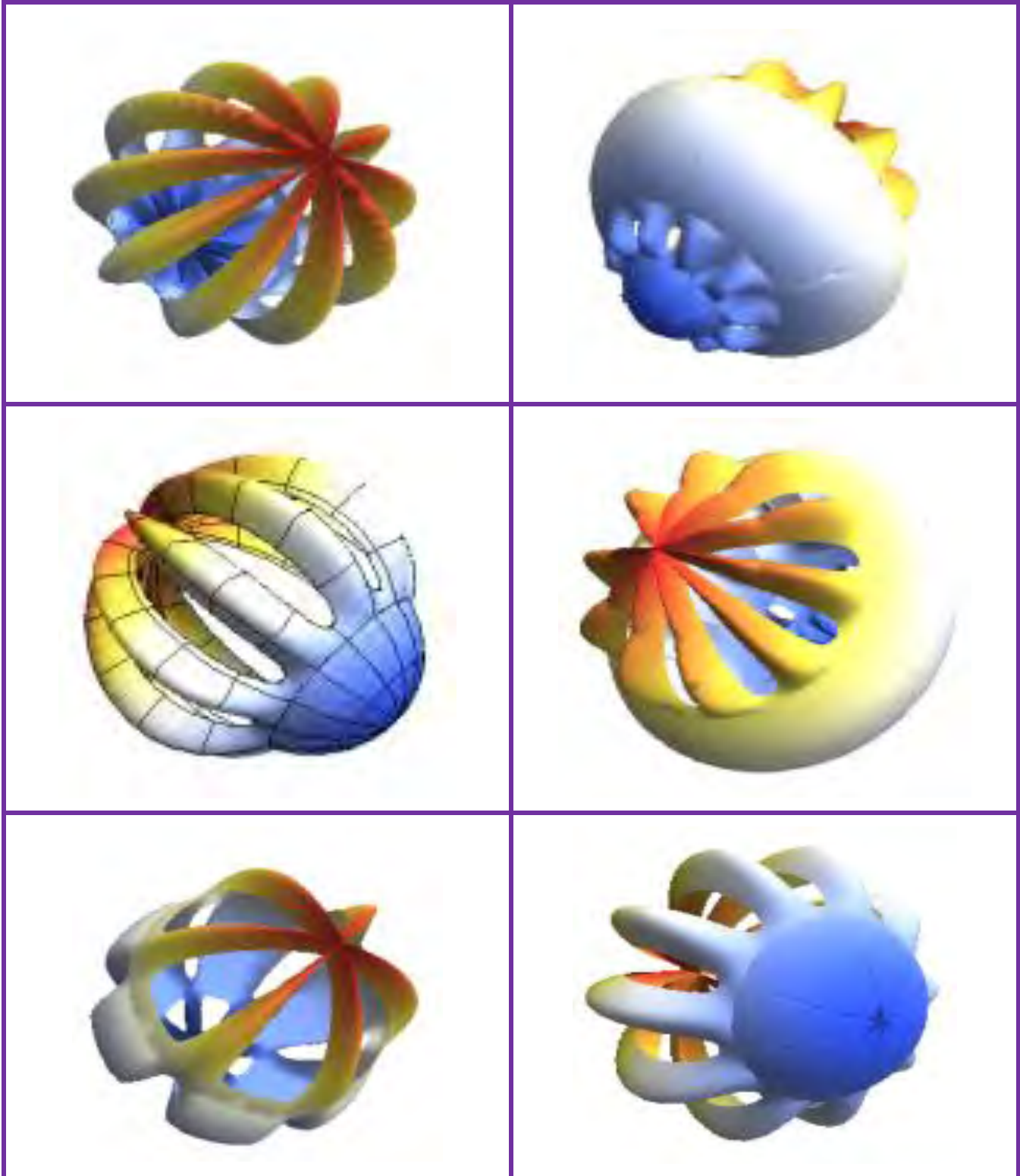

## COLUMN ELEMENTS OF EMBRACING THE YELLOW AND THE CYAN

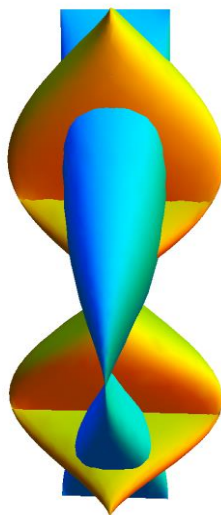
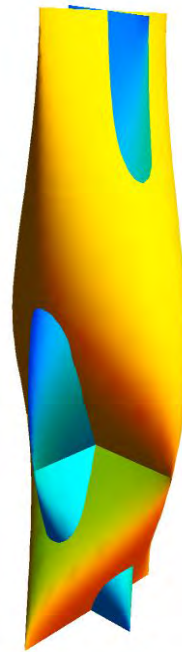
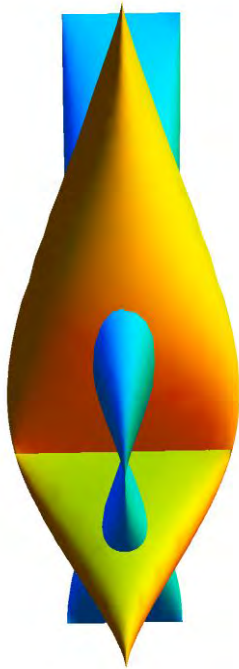

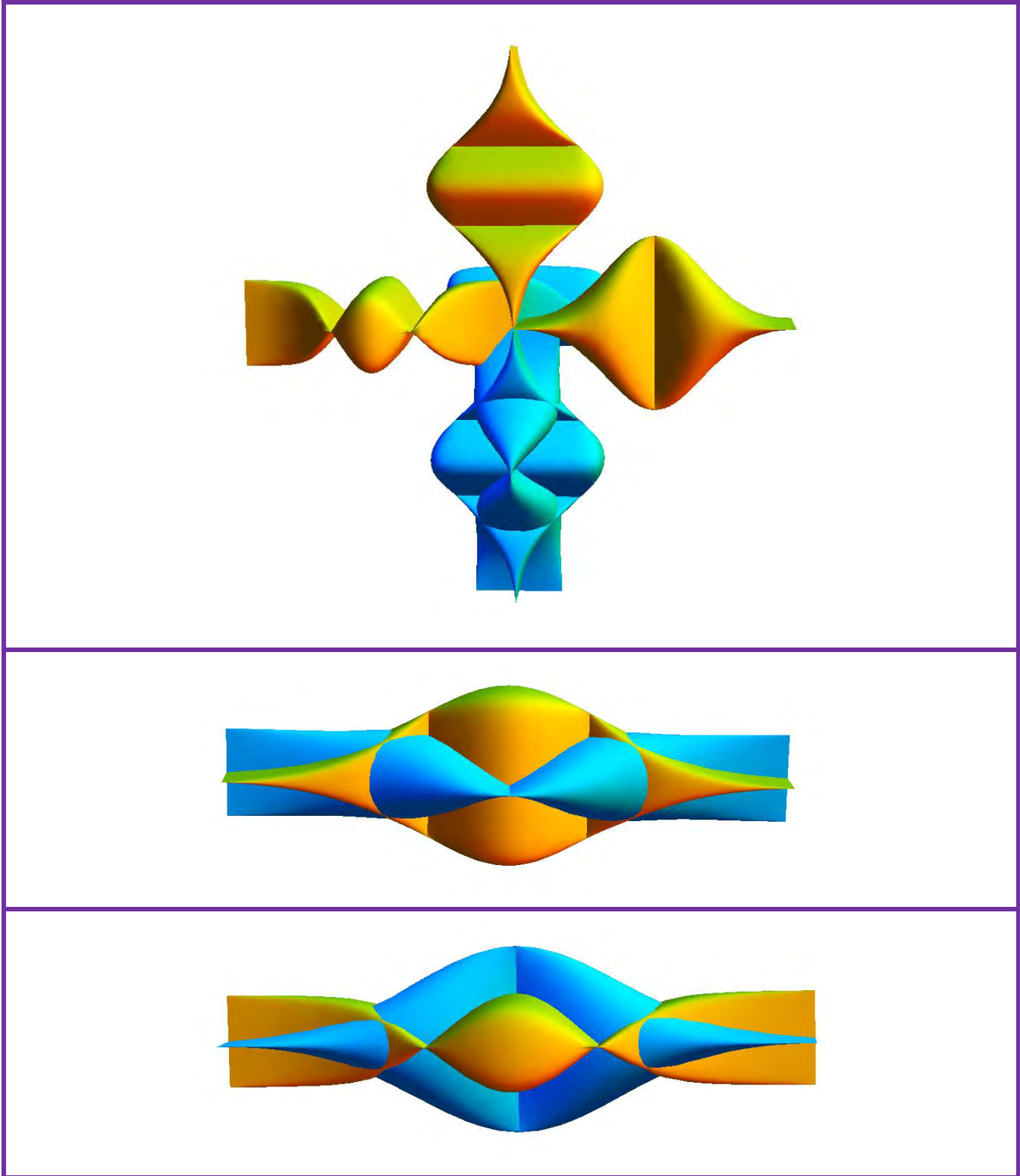



## COLUMN ELEMENTS OF ETERNAL LOVE

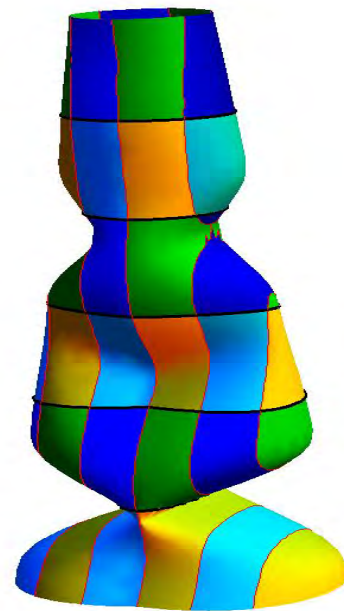
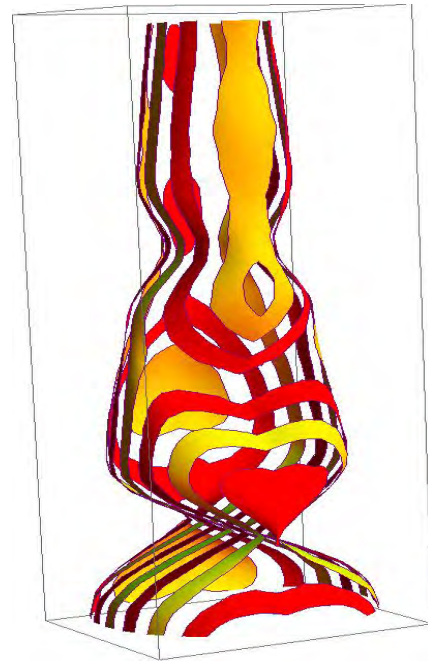

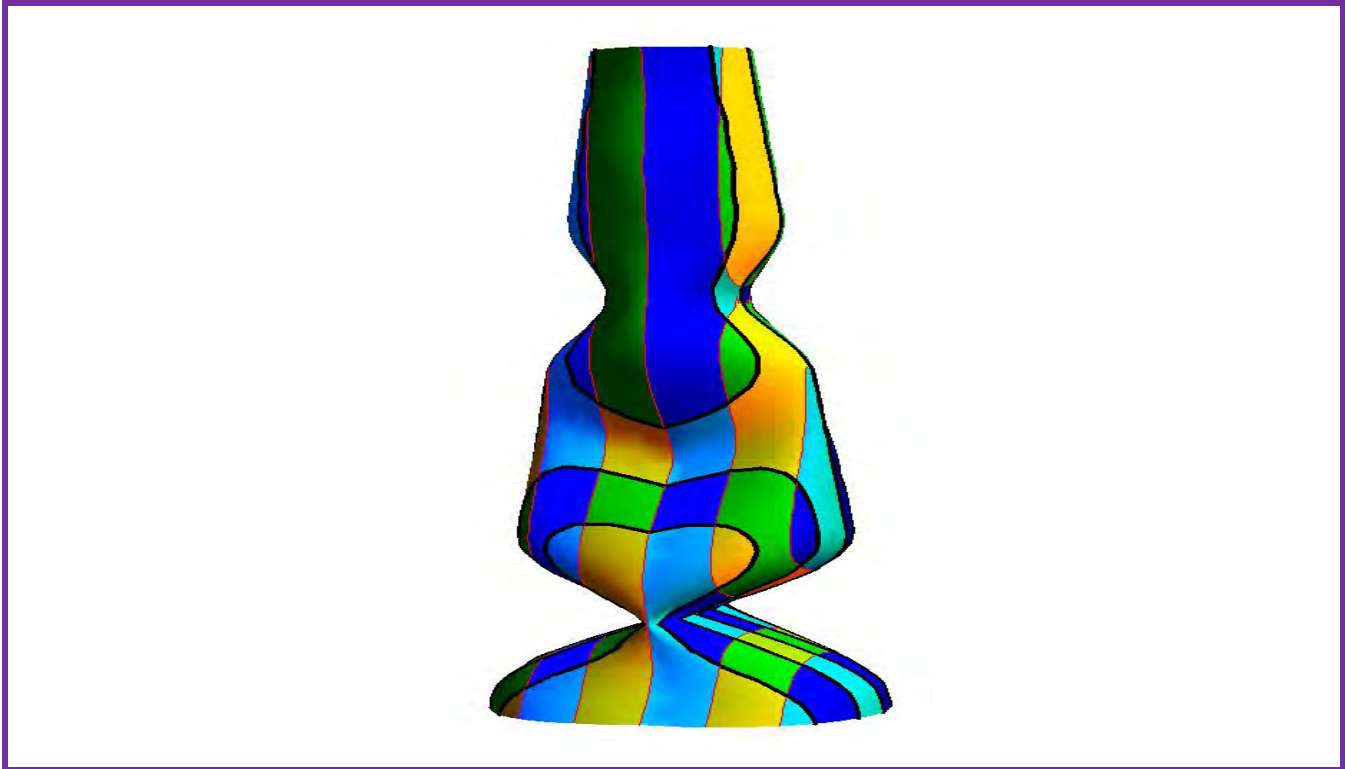
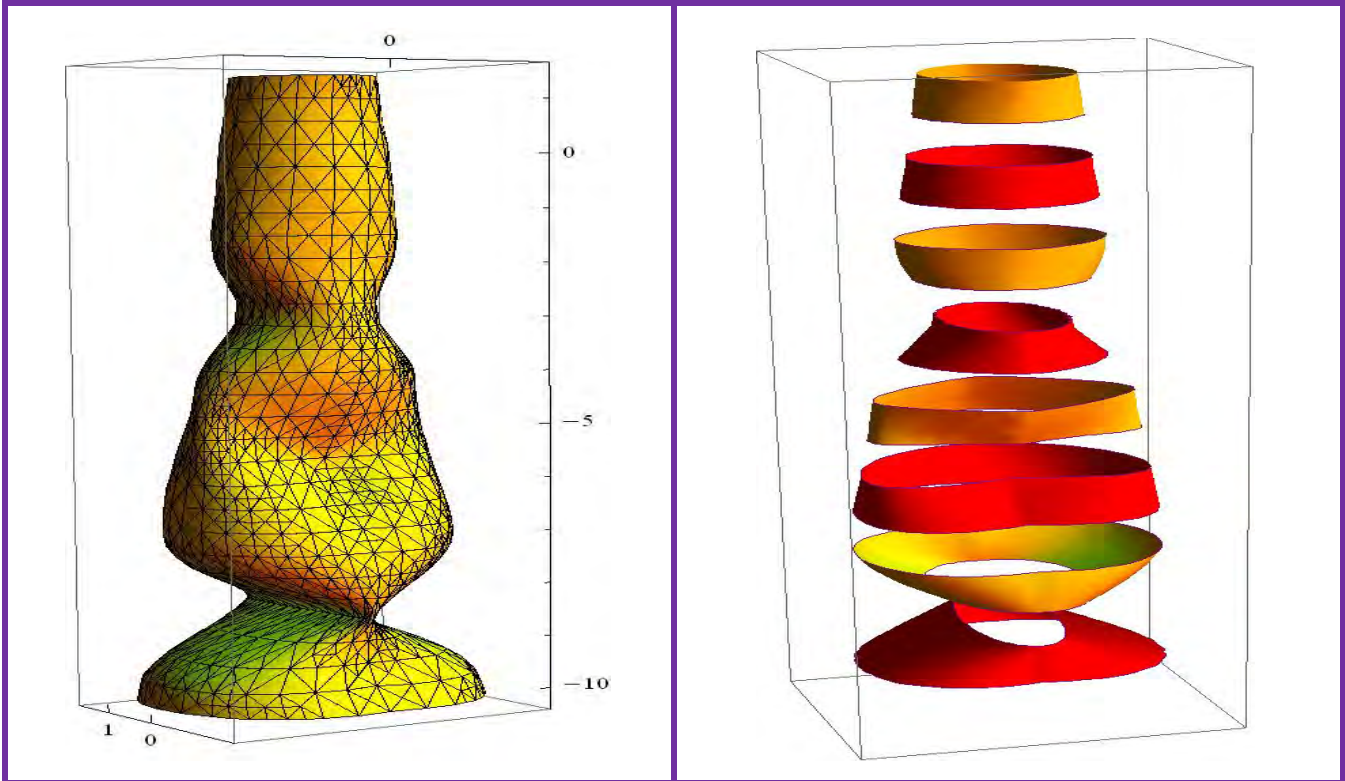

## COLUMN ELEMENTS OF ETERNAL GRATITUDE

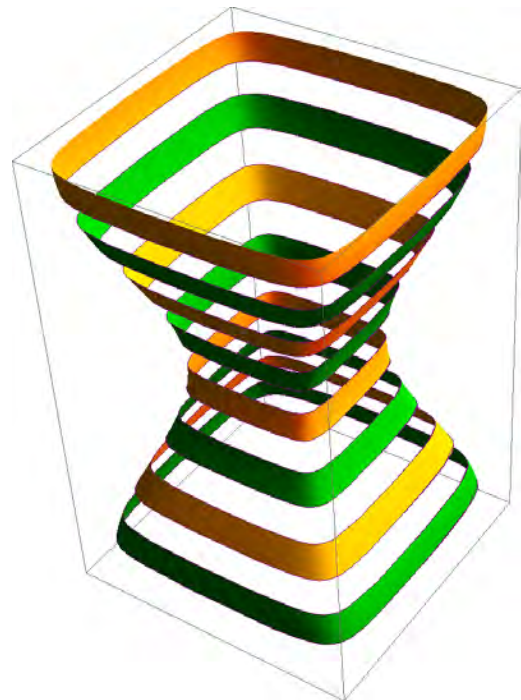

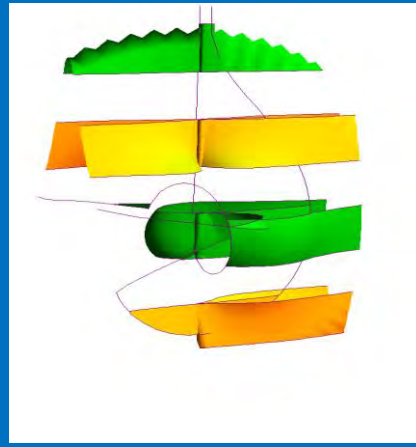
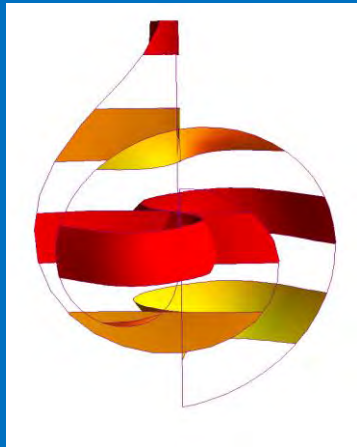

In the new *Techno-Art of Selariu SuperMathematics Functions* ALBUM (the second book of Selariu SuperMathematics Functions), one contemplates a unique COMPOSITION, INTER-, INTRA- and TRANS-DISCIPLINARY. A comprehensive and savant INTRODUCTION explains the genesis of the inserted "figures", the addressees being, without discriminating criteria, equally engineers, mathematicians, artists, graphic designers, architects, and all lovers of beauty – as the love of beauty is the supreme form of love. If I should put a label on the "content" of this ALBUM, I would concoct the word NEO-BEAUTY!

The new complements of mathematics, reunited under the name of **ex-centric mathematics** (EM), extend (theoretically, endless) their scope; in this respect, *Selariu SuperMathematics Functions* are undeniable arguments! The author has labored (especially in the last three decades) extensively and fruitfully in the elitist field of the domain.

To mention some 'milestones' in this ALBUM, I choose specific mathematical elements, *supermathematically hybridated*: *quadrilobic cubes, sphericubes, conopyramids, ex-centric spirals, severed toroids*. There are also those that would qualify as "utilitarian": *clepsydras, vases, baskets, lampions*, or those suggestively "baptized" (by the author): *butterflies, octopuses, flying saucers, jellies, roundabouts, ribands*, and so on – all superlatively designed in shapes and colors! Striking phrases, such as "staggering multiplication of the dimensions of the Universe", "*integration through differential division*" etc., become plausible (and explained) by replacing *the time* (of Einstein's *four-dimensional space*) with **ex-centricity**. Consequently, classical geometrical bodies (for  $e=0$ ): the sphere, the cylinder, the cone, undergo metamorphosis (for  $e = +/-1$ ), respectively into a cube, a prism, a pyramid. Inevitably and invariably, it is confirmed again that science is a finite space that grows in the infinite space; each new "expansion" does include a new area of unknown, but the unknown is inexhaustible...

Just browsing the ALBUM pages, you feel induced by the sensation of *pleasure, of love at first sight*; the variety of "exhibits", most of them unusual, the elegance, the symmetry of the layout, the chromatic, and so one, delight the eye, but equally incites to *catchy intellectual exploration*.

ISBN 978-1-59973-376-0



9 781599 733760 >