

SPECIAL SUBSET VERTEX MULTISUBGRAPHS FOR MULTINETWORKS

W.B.VASANTHA KANDASAMY
K. ILANTHENRAL
FLORENTIN SMARANDACHE

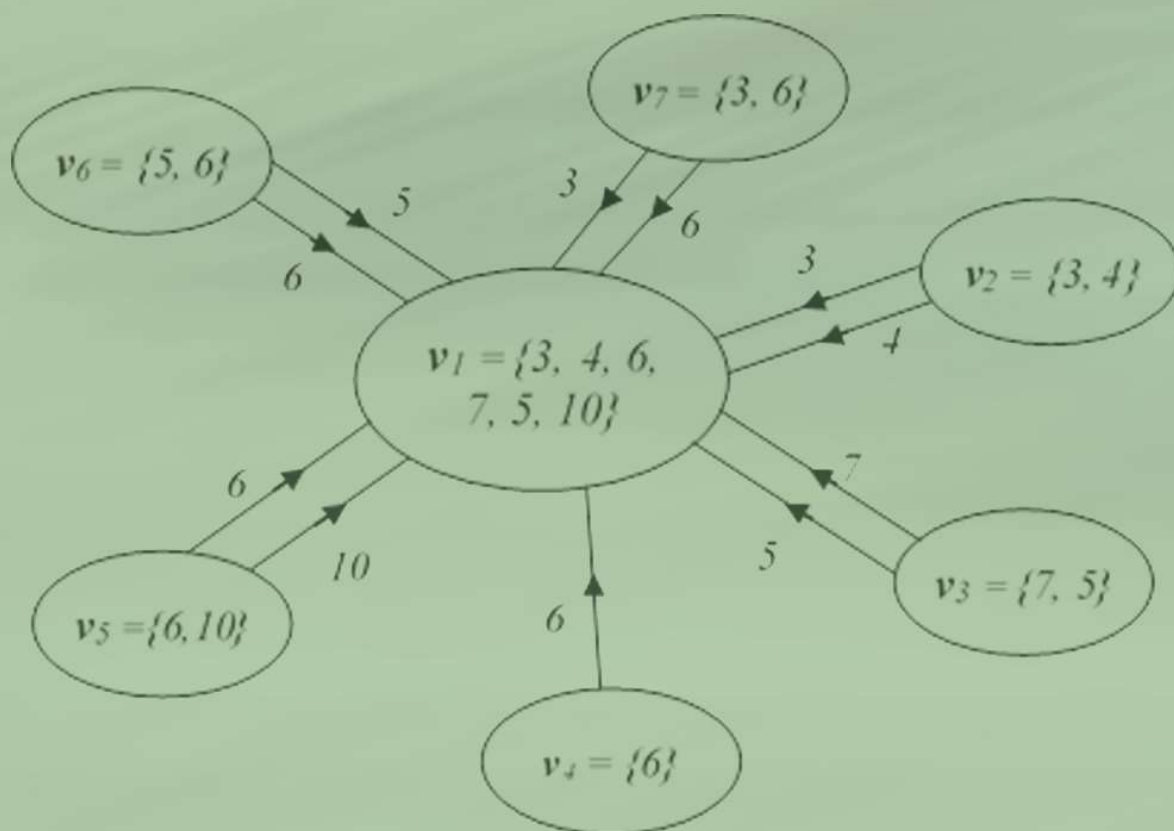

Special Subset Vertex Multisubgraphs for Multi Networks

**W. B. Vasantha Kandasamy
Ilanthanal K
Florentin Smarandache**



Copyright 2019 by *EuropaNova ASBL* and the *Authors*

This book can be ordered from:
EuropaNova ASBL
Clos du Parnasse, 3E
1000, Bruxelles
Belgium
E-mail: info@europanova.be
URL: <http://www.europanova.be/>

Peer reviewers:

Yanhui Guo, University of Illinois at Springfield, One University Plaza,
Springfield, IL 62703, United States, Email: yguo56@uis.edu
Darjan Karabasevic, University Business Academy, Novi Sad, Serbia, Email:
darjan.karabasevic@mef.edu.rs.
Dr. Mohamed Abdel-Baset, Faculty of Computers and Informatics, Zagazig
University, Egypt, Email: mohamed.abdelbasset@fci.zu.edu.eg.
Xindong Peng, School of Information Science and Engineering, Shaoguan
University, Shaoguan 512005, China, Email: 952518336@qq.com.

Many books can be downloaded from the following
Digital Library of Science:
<http://fs.unm.edu/ScienceLibrary.htm>

ISBN-13: 978-1-59973-633-4
EAN: 9781599736334

Printed in the United States of America

CONTENTS

Preface	4
Chapter One INTRODUCTION	7
Chapter Two SPECIAL SUBSET VERTEX MULTISUBGRAPHS	51
Chapter Three EDGE MULTISUBGRAPHS	123
Chapter Four SPECIAL SUPER SUBSET VERTEX MULTIGRAPH FOR MULTINETWORK	211

FURTHER READING	241
INDEX	249
ABOUT THE AUTHORS	251

PREFACE

In this book authors study special type of subset vertex multi subgraphs; these multi subgraphs can be directed or otherwise. Another special feature of these subset vertex multigraphs is that we are aware of the elements in each vertex set and how it affects the structure of both subset vertex multisubgraphs and edge multisubgraphs. It is pertinent to record at this juncture that certain ego centric directed multistar graphs become empty on the removal of one edge, there by theorising the importance, and giving certain postulates how to safely form ego centric multi networks. Given any subset vertex multigraph we are not always guaranteed of getting the special subset vertex multisubgraphs. However, if we have subset vertex multigraphs which has special subset vertex multisubgraphs then we can have corresponding to them multinet works, these multi networks are fault tolerant networks, hence the study of these special type of multisubgraphs has become mandatory.

Further in this book we introduce a new notion of super special subset vertex multigraphs which are built using the subset vertex multigraphs, especially when the subset vertex multigraph has no special subset vertex multi subgraphs. However, such super special subset vertex multigraphs associated with a multigraph are unique; so one cannot enjoy many options. To over this we build in case of subset vertex multi graphs which has several special subset vertex multisubgraphs the super special subset vertex multisubgraphs, these are not unique, and we can choose the one which is economic and form the multinetwork.

We see as in case of usual multigraphs these subset vertex multigraphs when one edge is removed then several edges are removed in the later case, causing instability of the network. This mainly happens because we are aware of the vertex which contributes these multiedges so this would help the researcher to know the exact multinetwork and act accordingly. These structures will be boon in multi networks associated with transportation networks and social information networks.

We wish to acknowledge Dr. K Kandasamy for his sustained support and encouragement in the writing of this book.

W.B.VASANTHA KANDASAMY
ILANTHENRAL K
FLORENTIN SMARANDACHE

Chapter One

INTRODUCTION

In this chapter we give some of the basic concepts which are very essential for the reader. Further we also give a few concepts or notions which are discussed in this book as they are vital for the reader to know how these multigraphs are different from the existing one and the need to pursue them. Recall in [53-6] subset vertex graphs of two types was introduced.

Basically, they are a powerful tool in the study of social network. Here we just give the definition of them and describe them by examples. These subset vertex graphs are built basically using subsets of a set S as a vertex subset. The vertex subsets of any subset vertex graph is taken from the set $P(S)$, the power set of S .

Definition 1.1. *Let S be any set and $P(S)$ the powerset of S . Let v_1, v_2, \dots, v_n be n subsets of $P(S)$ which forms the vertices of the graph G . We define an edge from v_i to v_j if and only if $i \neq j$ and $v_i \cap v_j \neq \phi$; $1 \leq i, j \leq n$. Thus, once the vertex subsets v_1, \dots, v_n are given the edges are uniquely fixed. We define G with vertex*

subsets v_1, \dots, v_n and edges defined in this way as the subset vertex graph of type I.

The following observations are mandatory.

- 1) The set S can be anything depending on the problem in hand.
- 2) Once the vertex subsets are given the edges are defined in a unique way. Thus, for a given set of vertex subsets there is one and only one subset vertex graph associated with it.
- 3) These vertex subsets graphs are not directed.

We now provide some examples of them.

Example 1.1 Let $S = \{Z_{27}\}$ be a set of order 27, $S = \{a_0, a_1, \dots, a_{26}\} = \{0, 1, 2, 3, 4, \dots, 26\}$, where $a_i = i$ ($a_5 = 5$): $0 \leq i \leq 26$. $P(S)$ be the powerset of S . Consider the vertex subsets $\{v_1, v_2, v_3, v_4, v_5, v_6\} \subseteq P(S)$ where $v_1 = \{2, 4, 6, 8, 10, 16, 20\}$, $v_2 = \{6, 4, 17, 19, 23, 7\}$, $v_3 = \{3, 5, 15\}$, $v_4 = \{9, 8, 26, 24\}$, $v_5 = \{7, 17, 15, 0, 1\}$ and $v_6 = \{4, 2, 5, 7, 10, 12\}$.

Now we show how the edges are fixed according to the definition of subset vertex graphs of type I. An edge exists between v_i and v_j , $i \neq j$; if and only if $v_i \cap v_j \neq \phi$.

Now we find the edges of the subset vertex graphs with vertex subsets v_1, v_2, \dots, v_6 . $v_1 \cap v_2 = \{6, 4\}$ so there is an edge between v_1 and v_2 . Now $v_1 \cap v_3 = \phi$ so there is no edge between v_1 and v_3 . $v_1 \cap v_4 = \{8\}$ so there is an edge between v_1 and v_4 . $v_1 \cap v_5 = \phi$ so there is no edge between v_1 and v_5 . We find now $v_1 \cap v_6 = \{4, 2, 10\}$. We find the edge between v_2 and v_3 ; $v_2 \cap v_3 = \phi$ so there is no edge between v_2 and v_3 . We find

$v_2 \cap v_4 = \emptyset$ so there is no edge between v_2 and v_4 . $v_2 \cap v_5 = \{17\}$ so there is an edge between v_2 and v_5 . Consider $v_2 \cap v_6 = \{7, 4\}$ so there is an edge between v_2 and v_6 . The edges between v_3 and v_4 , v_5 and v_6 . $v_3 \cap v_4 = \emptyset$ so no edge exists between v_3 and v_4 . We find $v_3 \cap v_5 = \{15\}$ so there is an edge between v_3 and v_5 . $v_3 \cap v_6 = \{5\}$ so there is an edge between v_3 and v_6 . Now we find the edges incident to v_4 . $v_4 \cap v_5 = \emptyset$ and $v_4 \cap v_6 = \emptyset$ so with both v_5 and v_6 there is no edge connecting v_4 . Finally, $v_5 \cap v_6 = \{7\}$ so there is an edge between v_5 and v_6 .

Hence for the given set of vertices v_1, v_2, \dots, v_6 the edges are unique and are not directed. Let G be the subset vertex graph with edges v_1, v_2, \dots, v_6 given by the following figure.

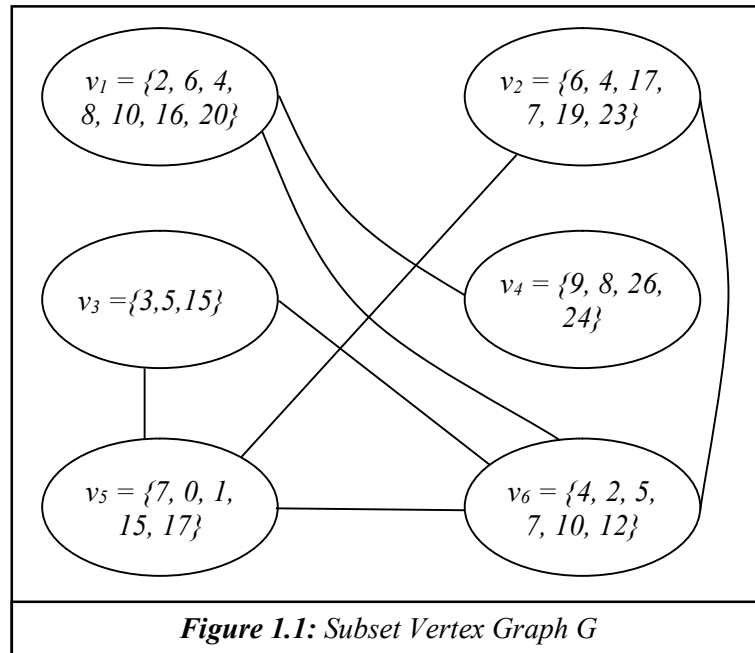

Next, we give yet another example of a subset vertex star graph of type I.

Example 1.2. Let $S = \{Z_{40}\}$ be a set and $P(S)$ the power set of S . Let G be the subset vertex star graph given by the following figure.

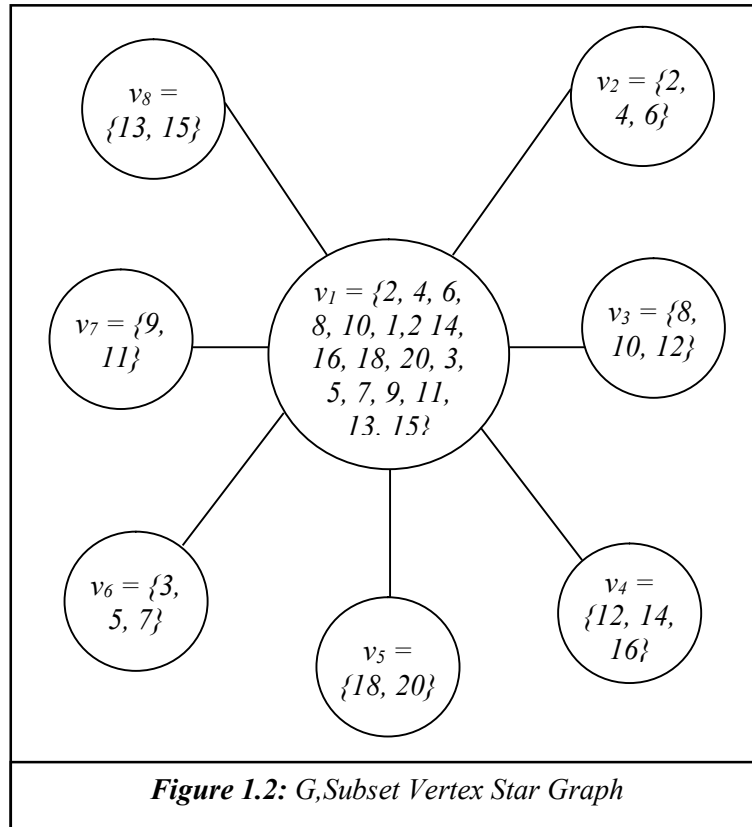

Now we provide an example of a subset vertex circle graph.

Example 1.3. Let $S = \{Z_{24}\}$ be a set and $P(S)$ the power set of S , G be the subset vertex circle graph given by the following figure

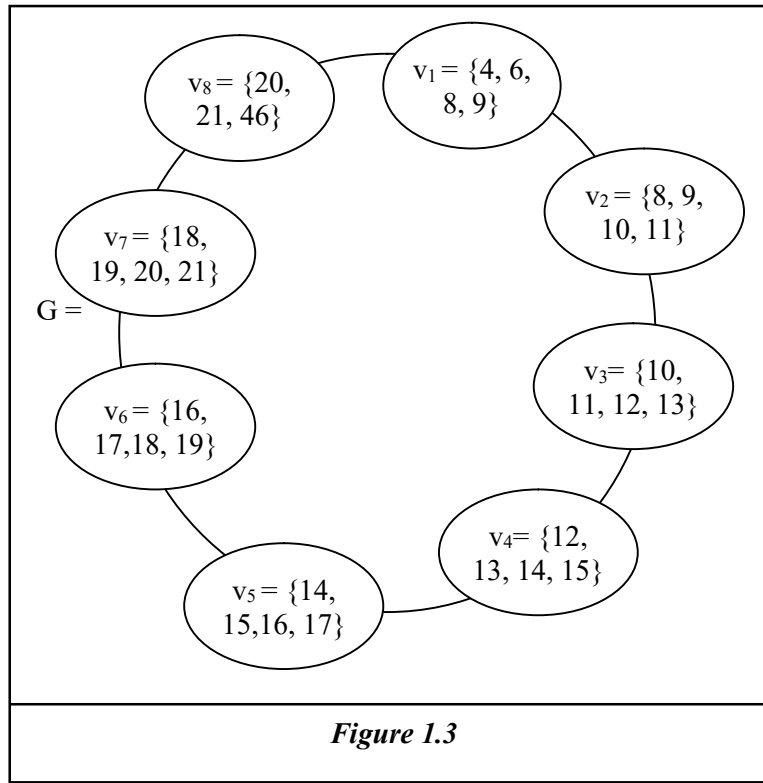
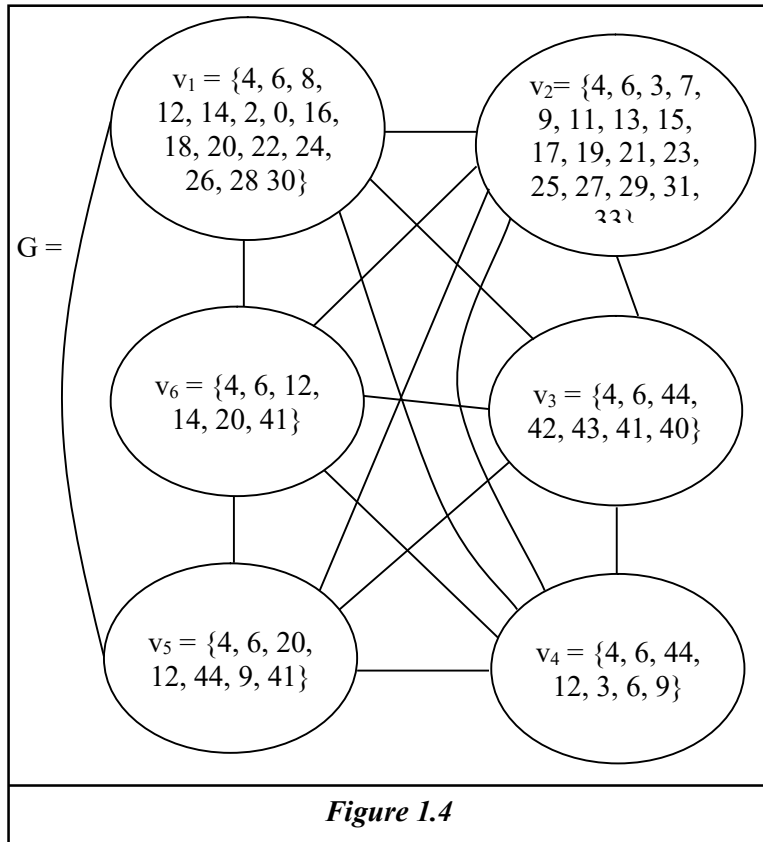

Figure 1.3

We give yet another example of a complete subset vertex graph.

Example 1.4. Let $S = \{Z_{54}\}$ be a set. $P(S)$ be the power set of S . Let G be the complete subset vertex graph given by the following figure.



Now consider the chain of vertex subsets which forms a totally ordered set given in the following.

$$v_1 = \{3, 4, 6\} \subseteq v_2 = \{3, 4, 6, 7, 9\} \subseteq v_3 = \{3, 4, 6, 7, 9, 10\}$$

$$\subseteq v_4 = \{3, 4, 6, 7, 9, 10, 11, 12, 14\} \subseteq v_5 = \{3, 4, 6, 7, 9, 10, 11, 12, 14, 16, 17, 18\} \subseteq v_6 = \{3, 4, 6, 8, 7, 9, 10, 11, 12, 14, 16, 17,$$

$18, 24\} \subseteq v_7 = \{3, 4, 6, 8, 7, 9, 10, 11, 12, 14, 16, 17, 18, 24, 26, 27, 28, 29\}$.

The subset vertex graph G is as follows.

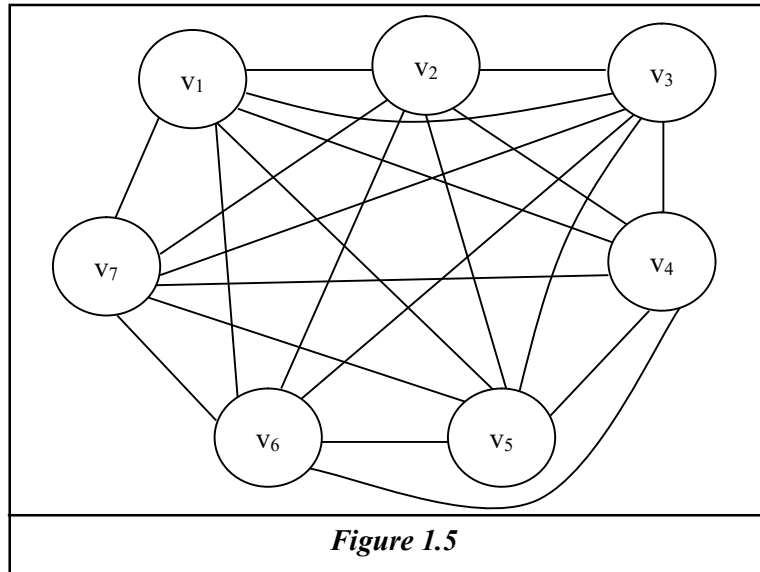

G is clearly a subset vertex graph which is complete.

In fact it is clear every totally ordered subsets of $P(S)$ forming the subset vertex of any graph G will form a complete subset vertex graph. However, we cannot say in case of all complete subset vertex graphs the subset vertex set will form a totally ordered chain, the Figure 1.4 is an instance of this situation.

Now we see the usual subset vertex subgraphs of G . If a subset vertex graph G has n vertices then the number of subset vertex subgraph of G which are proper including the null subset vertex subgraph in $nC_1 + nC_2 + nC_3 + \dots + nC_{n-1}$.

Example 1.5. Let $S = \{Z_{20}\}$ and $P(S)$ be the power set of S . Let G be the subset vertex graph given by the following figure.

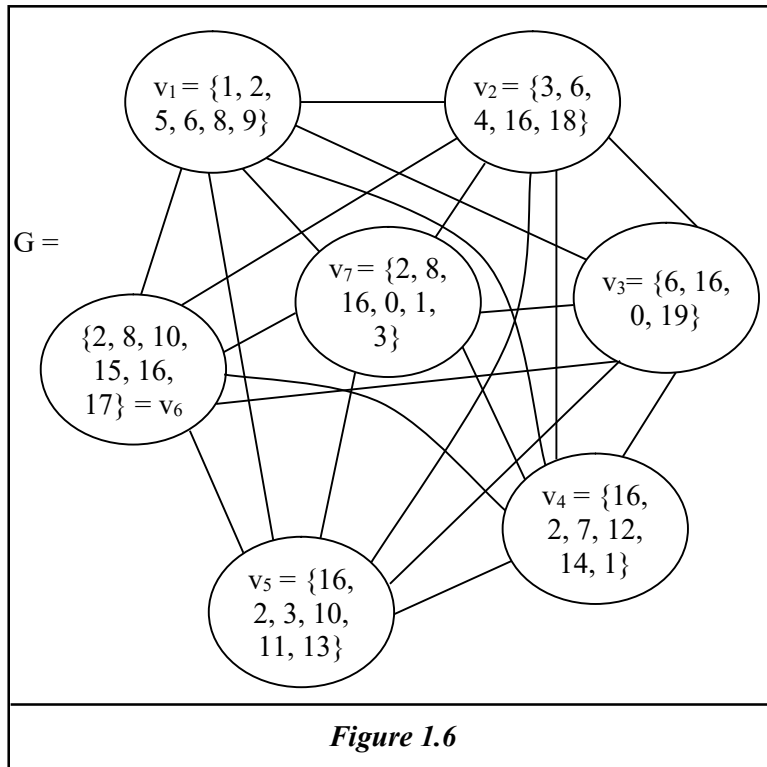

G has $7C_1 + 7C_2 + 7C_3 + 7C_4 + 7C_5 + 7C_6$ nontrivial subset vertex subgraphs which includes the null 7 subset vertex null subgraphs also. We take any one of the proper subset vertex subgraph say H of G given by the following figure.

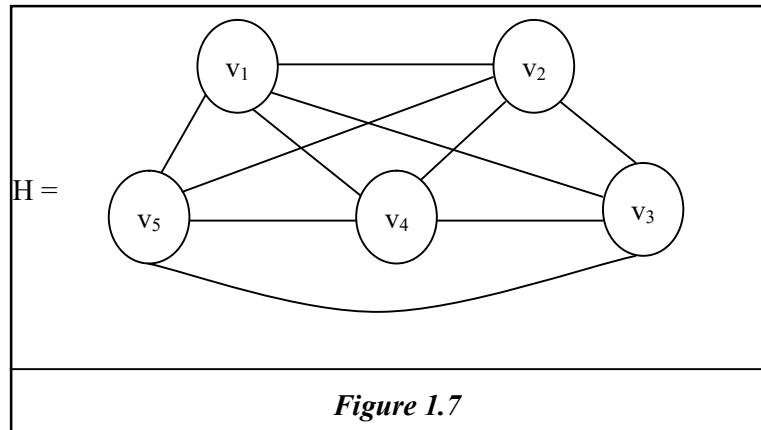

Now for this H we take the proper subsets of the vertex subsets we rename the subsets of v_i as u_i , $i = 1, 2, \dots, 5$, where $u_i \subset v_i$.

Let K be the subset- subset vertex subgraph of H given by the following figure.

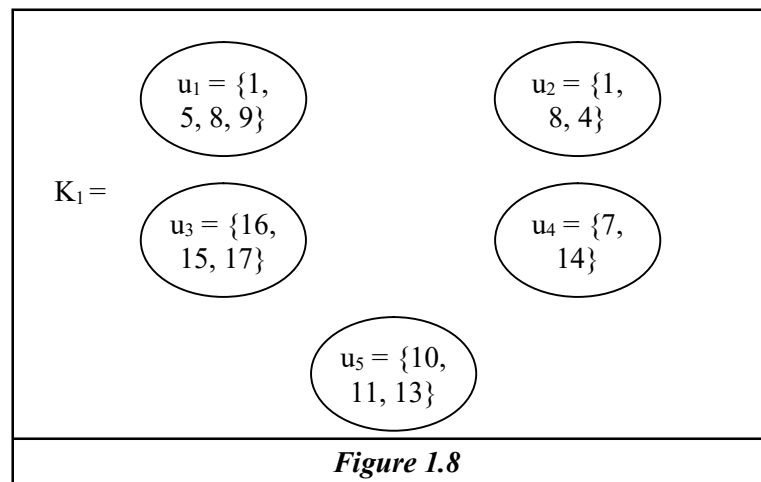

We see K_1 is just an empty subset subset vertex subgraph of H , whereas H is a complete subset vertex subgraph of G .

Consider K_2 a subset subset vertex subgraph of G given by the following figure.

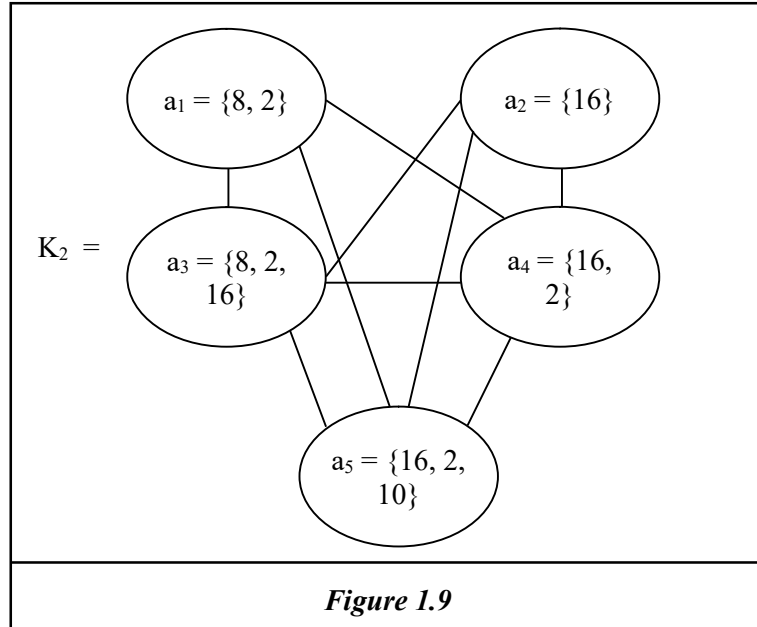

K_2 the subset-subset vertex subgraph of H is not a complete subset-subset vertex subgraph of H .

Now we find the local complement of K_1 and K_2 relative to H .

The local complement P_1 of K_1 relative to H is as follows, which takes the vertex subsets as $s_i = v_i \setminus u_i; 1 \leq i \leq 5$.

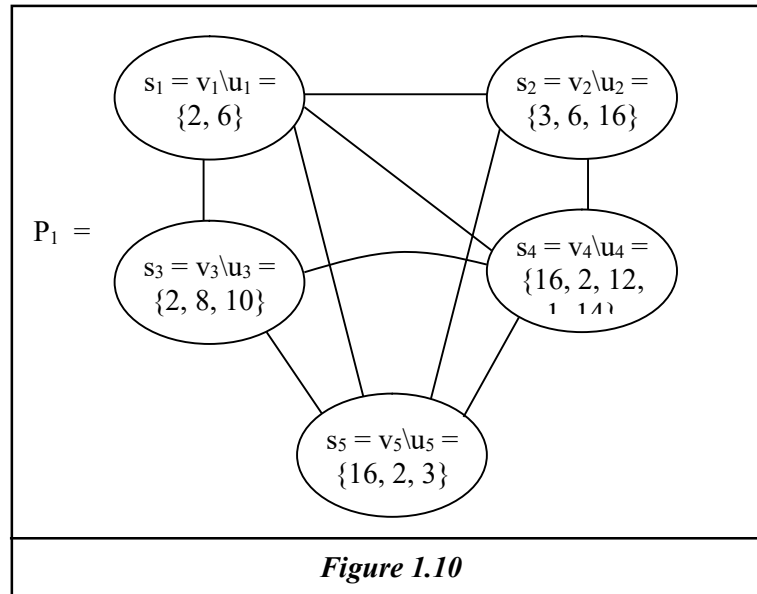

Clearly the local complement P_1 of K_1 relative to H is a subset-subset vertex subgraph of G which is pseudo complete but K_1 is an empty subset-subset vertex subgraph of H .

Now we find the local complement P_2 of K_2 relative to H in the following.

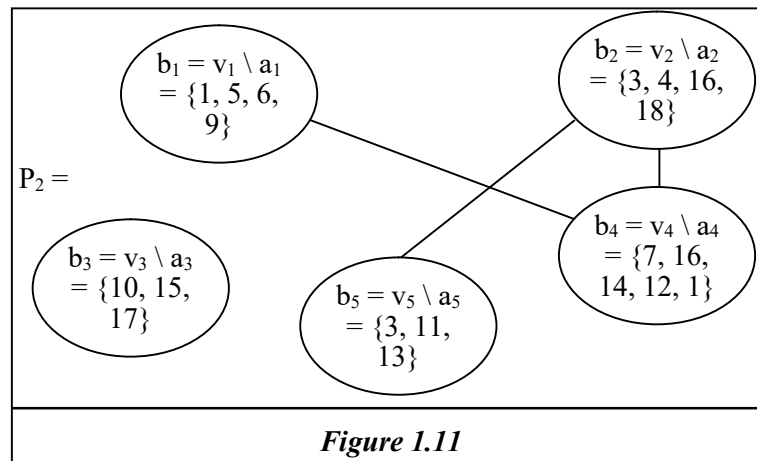

Clearly K_2 the subset-subset vertex subgraph of H which is the local complement of K_2 relative to H is a disconnected one whereas K_2 is a connected subset-subset vertex subgraph of H , with vertex subsets $b_i = v_i \setminus a_i, 1 \leq i \leq 5$.

Consider the subset vertex subgraph S of G given by the following figure.

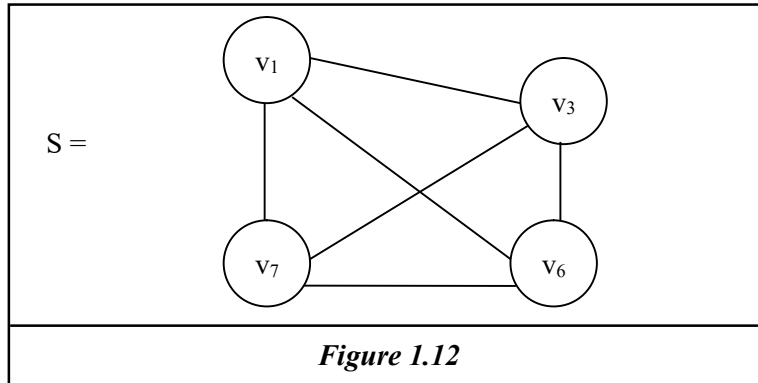

S is a complete subset vertex subgraph of G .

In fact every subset vertex subgraph of G is also a complete subset vertex subgraph as G is a complete subset vertex graph.

We now give the subset subset vertex subgraph M_1 of S by the following figure.

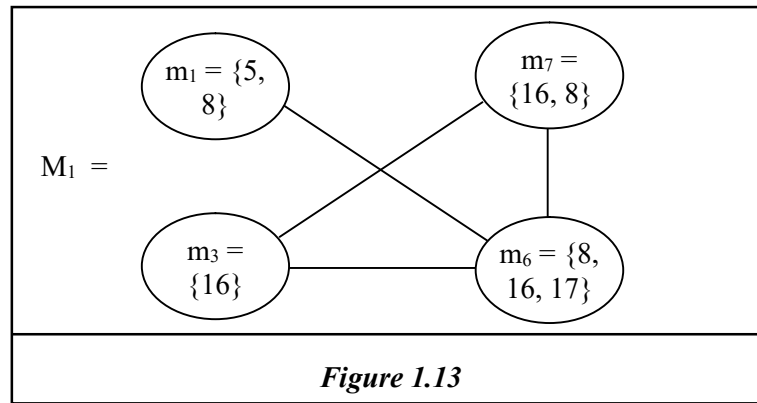

We see M_1 the subset - subset vertex subgraph of S is not complete or pseudo complete. It is only connected.

Now we give the local complement N_1 of M_1 relative to S in the following figure.

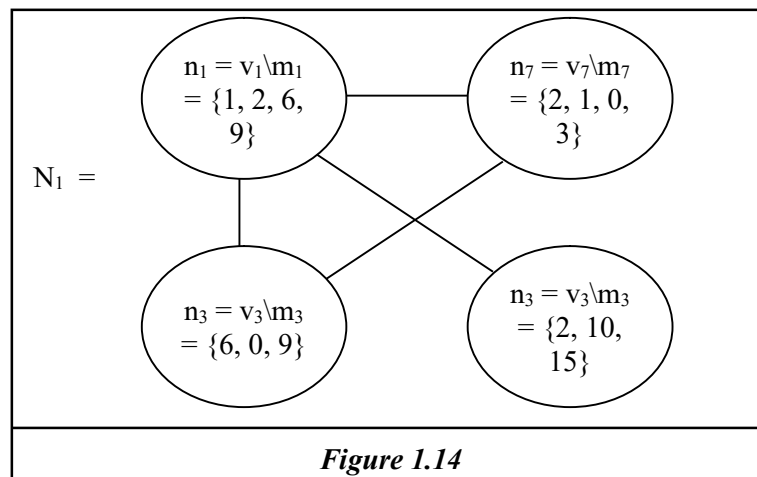

N_1 the local complement of M_1 is not a complete or pseudo complete subset - subset vertex subgraph.

Now the notion of subset - subset vertex subgraph of a subset vertex graph G is the concept of special subset vertex

subgraphs. So we can call the special subset vertex subgraph of G also as subset - subset vertex subgraph of G .

Study of these structures have been elaborately dealt in [53]. Now we proceed onto describe this notion by an example or two.

Example 1.6. Let $S = \{Z_{27}\}$ and $P(S)$ the power set of S .

Let G be the subset vertex graph given by the following figure.

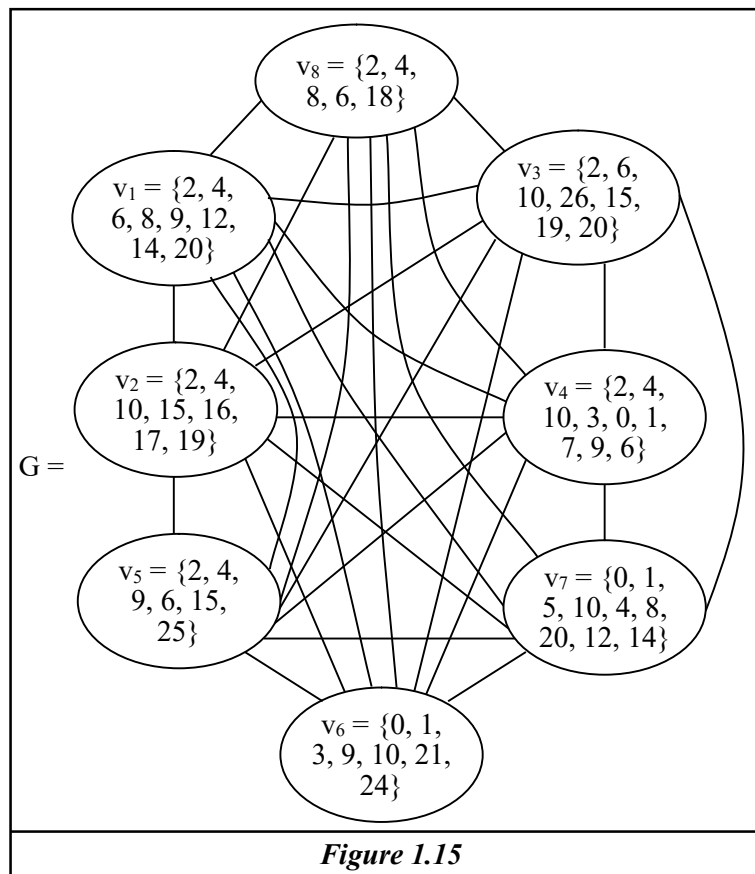

Let H_1 be a special subset vertex subgraph of G given by the following figure.

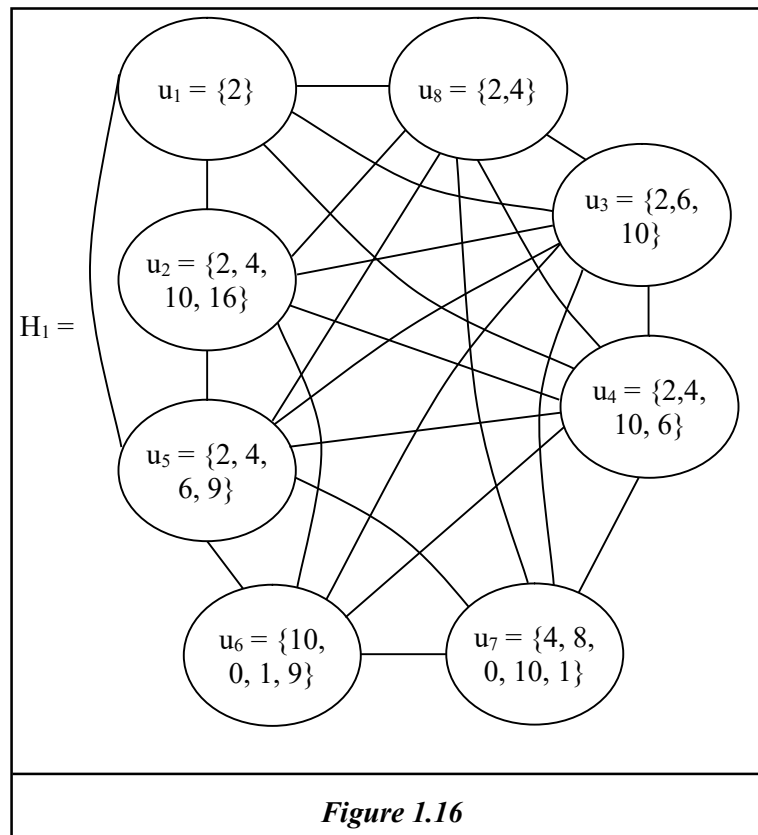

Clearly H_1 is a special subset – subset vertex subgraph which is only pseudo complete whereas G is a complete subset vertex graph.

Let H_2 be a special subset - subset subgraph of G given by the following figure.

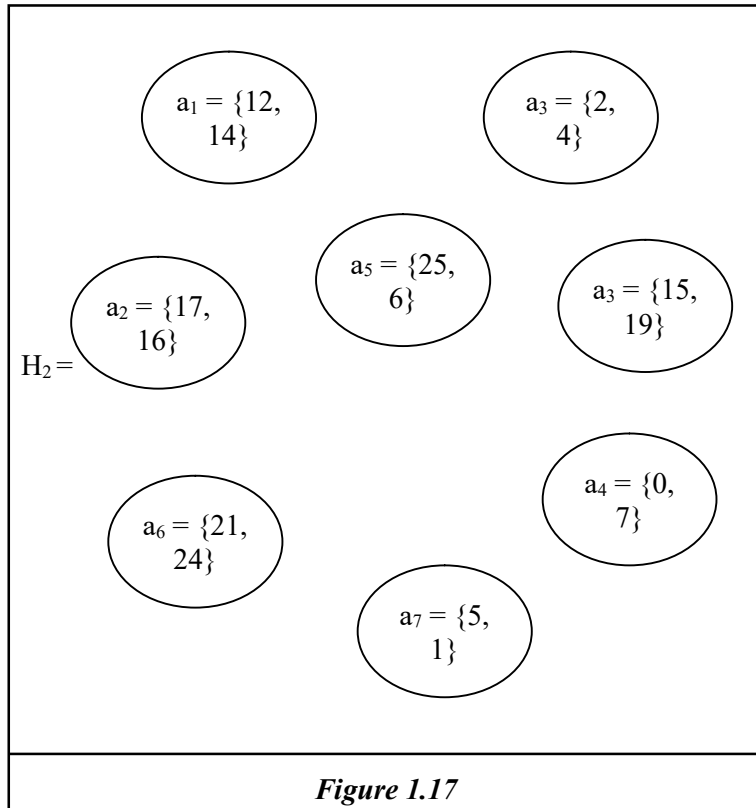

We see H_2 is a subset - subset vertex special subgraph of G which is empty but G is complete.

Let H_3 be the special subset - subset vertex subgraph of G given by the following figure.

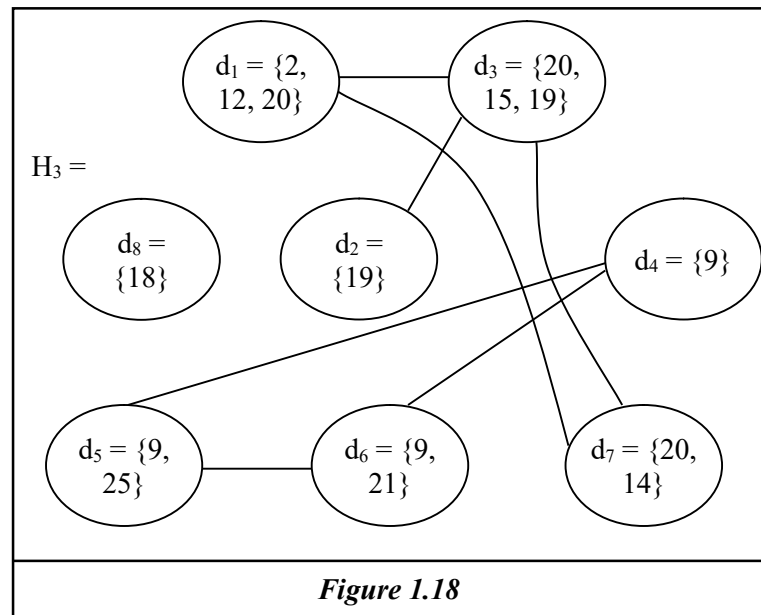

Clearly the special subset vertex subgraph H_3 of G is disconnected. It has 2 triads which forms the clique of H_3 however G is connected.

In the following we give the local complements of H_1 , H_2 and H_3 relative to G .

Let P_1 be the local complement of H_1 relative to G given by the following figure.

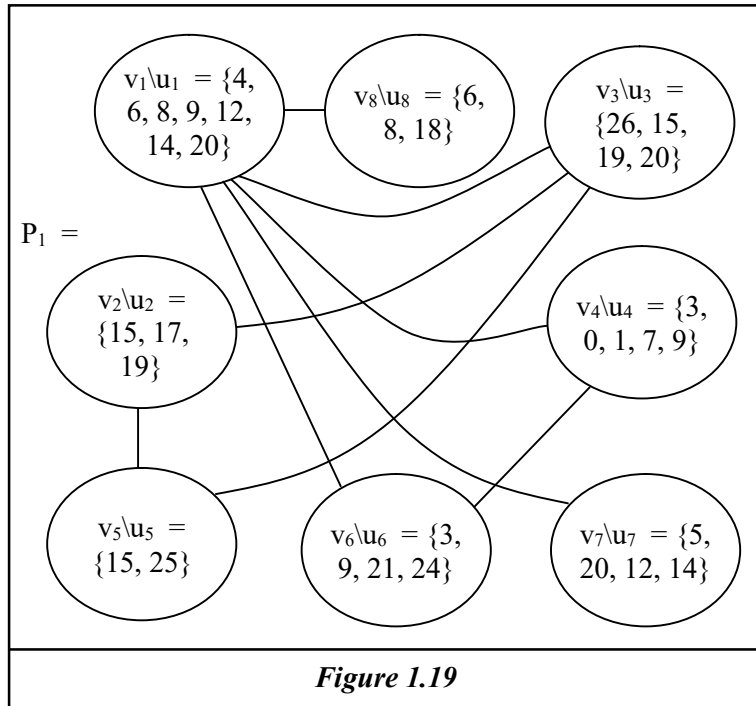

We see the local complement P_1 of H_1 does not enjoy the same structure as H_1 for P_1 is pseudo complete where as P_1 is not. Clearly the nodes of P_1 are $v_i \setminus u_i; i = 1, 2, \dots, 8$.

Let P_2 be the local complement of H_2 given by the following figure.

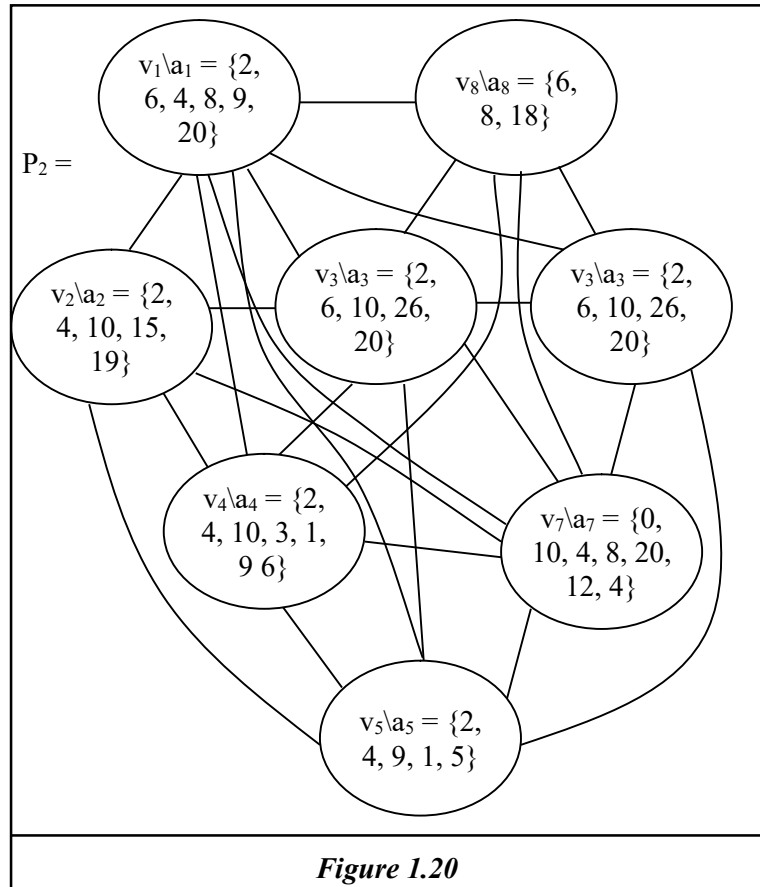

H_2 is an empty special subset vertex subgraph of G whereas its local complement P_2 relative to G is a pseudo complete special subset vertex subgraph of G .

Let P_3 be the local complement of H_3 relative to G given by the following figure.

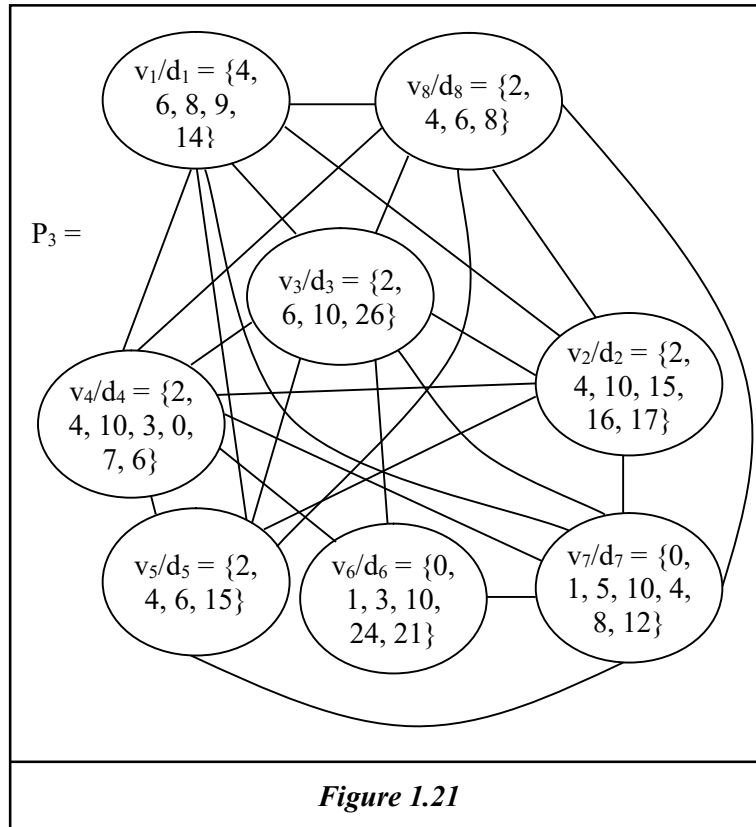

We see the local complement P_3 of H_3 is a pseudo complete special subset subgraph of G where as H_3 is disconnected. This P_3 has a clique of order 7 and is a powerful hyper subgraph of P_3 .

These very special features enjoyed by these subset vertex graphs G and their special subset vertex subgraphs makes these structures very powerful in general for networks and in particular in case of social networks.

Study in these directions are open to any interested researcher in social information networks.

Next, we proceed onto to recall the definition of projective (injective) subset vertex graph. For more about these notions please refer [53-5].

Definition 1.2. Let S be a set and $P(S)$ the power set of S . Let v_1, v_2, \dots, v_n be n distinct vertex subsets from $P(S)$. We define an edge from v_i to v_j if and only if $v_i \subset v_j$ ($i \neq j$) and it is defined as injective edge if we draw the line from v_i to v_j and a projective edge if we draw a line from v_j to v_i .

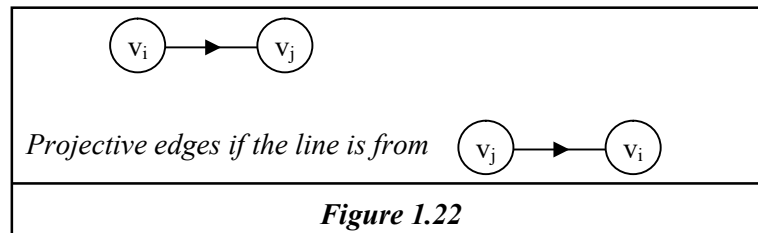

So G is defined as a injective (projective) subset vertex graph if the injective (projective) edges are defined on it. These graphs are known as subset vertex graphs of type II.

We will give one or two examples of them.

Example 1.7. Let G be a directed subset vertex graph given by the following figure. The vertex subsets are from $P(S)$ of the set S ; where $S = Z_{12}$.

We give both injective subset vertex graph G as well as projective subset vertex graph H .

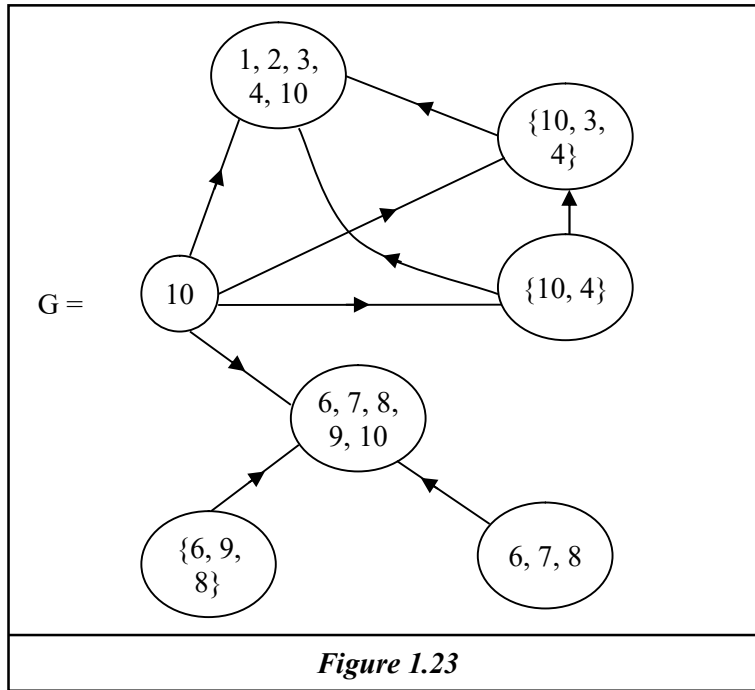

For the same set of vertices, the projective subset vertices graphs of G and H are as follows.

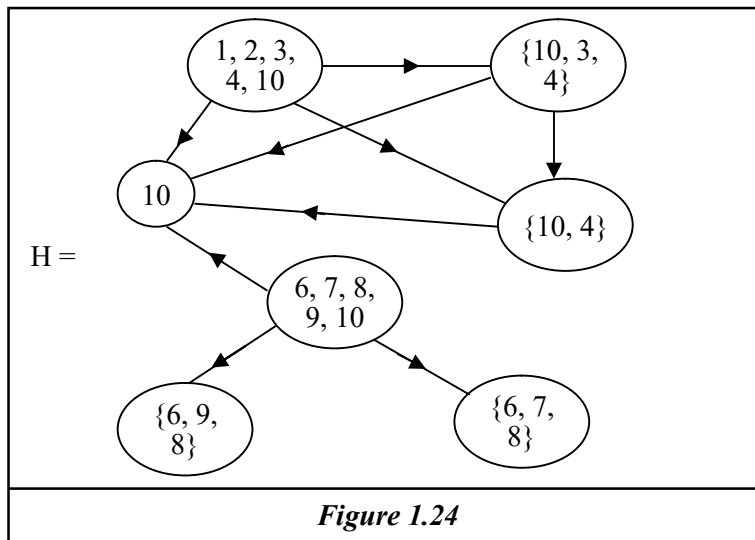

We see the directions in G and H are in opposite directions.

We can get subset vertex subgraphs of G and H in the following.

Let K_1 be the subset vertex subgraph of G given by the following figure.

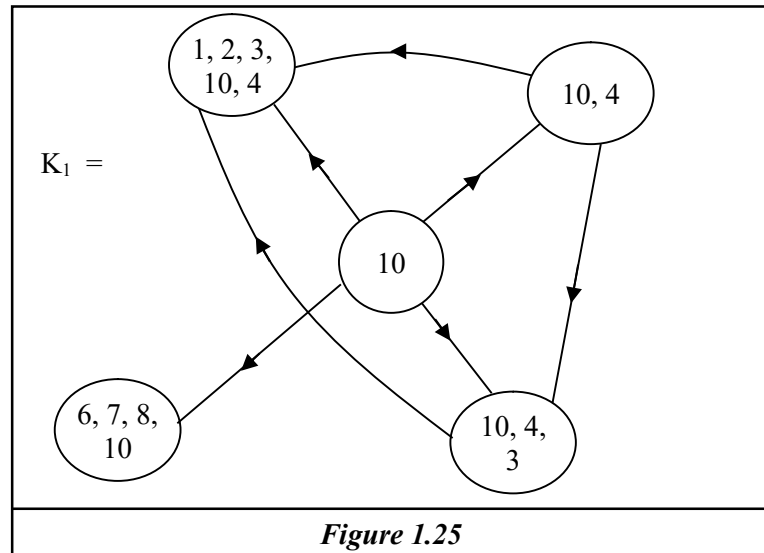

Let H_1 be the subset vertex subgraph of H given by the following figure.

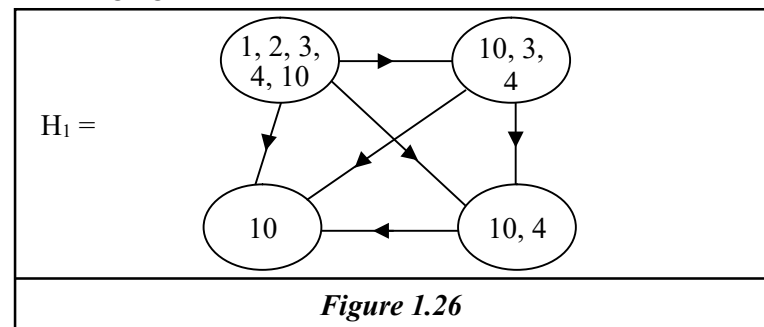

Clearly H_1 is a complete subset vertex subgraph of H .

Infact H_1 is the subset vertex clique of H .

Next, we give examples of subset - subset vertex subgraphs of both G and H in the following.

Let P_1 be the subset - subset vertex subgraph of G given by the following figure.

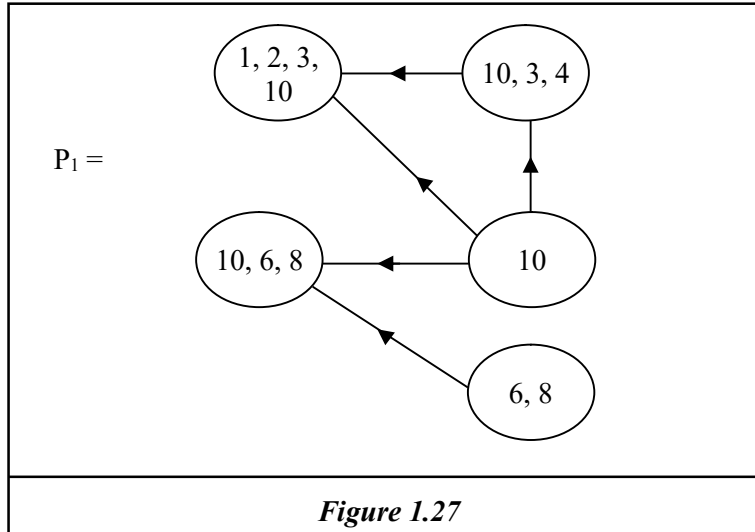

Now let P_2 be the subset - subset vertex subgraph of H given by the following figure.

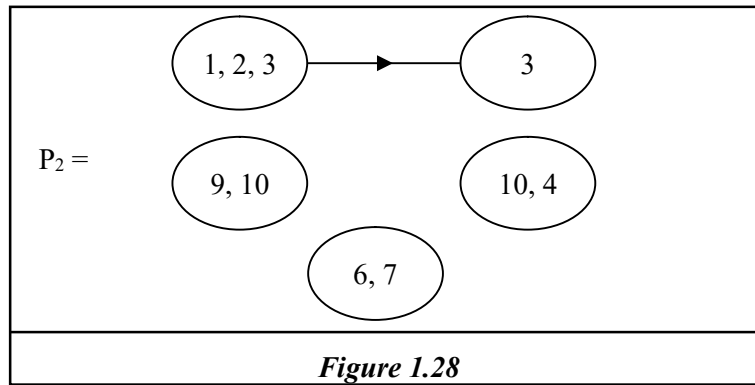

We see P_2 is a disconnected subset - subset vertex subgraph of H . Clearly H is connected but its subset - subset vertex subgraph P_2 is not connected. So the properties in general is not inherited by its substructures.

Now we study the condition whether G or H can have special subset vertex subgraphs. The answer is no as both the subset vertex graphs G and H contain the vertex subset $\{10\}$ which is a singleton.

We give one more example of a directed subset vertex graph which has special subset vertex subgraphs.

The main criteria for the existence of the special subset vertex subgraph is that no vertex subset of G should be singleton. It even one of the vertex subset is a singleton then that subset vertex graph cannot have proper subsets.

Example 1.8. Let G be a subset vertex graph given by the following figure whose vertex sets are from $P(S)$, the power set of $S = \{Z_{18}\}$.

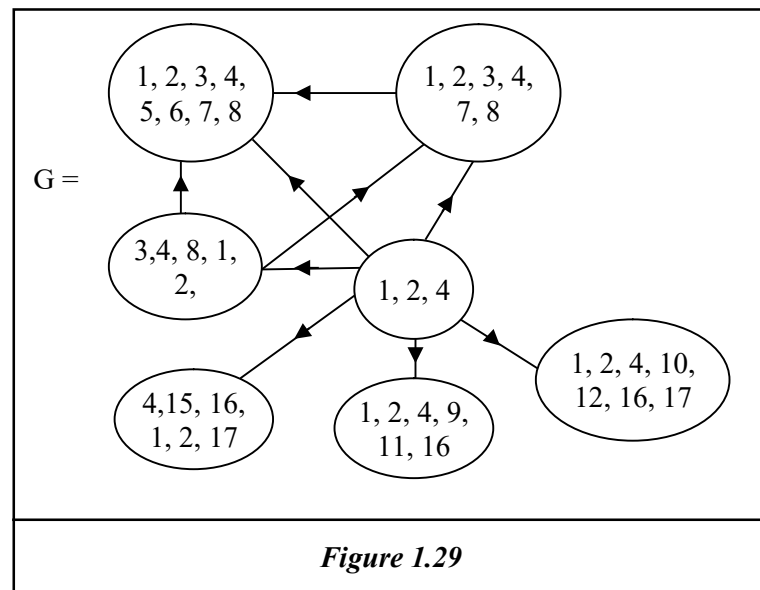

Now we give the special subset vertex subgraphs of G .

Let H_1 be the special subset vertex subgraph of G given by the following figure.

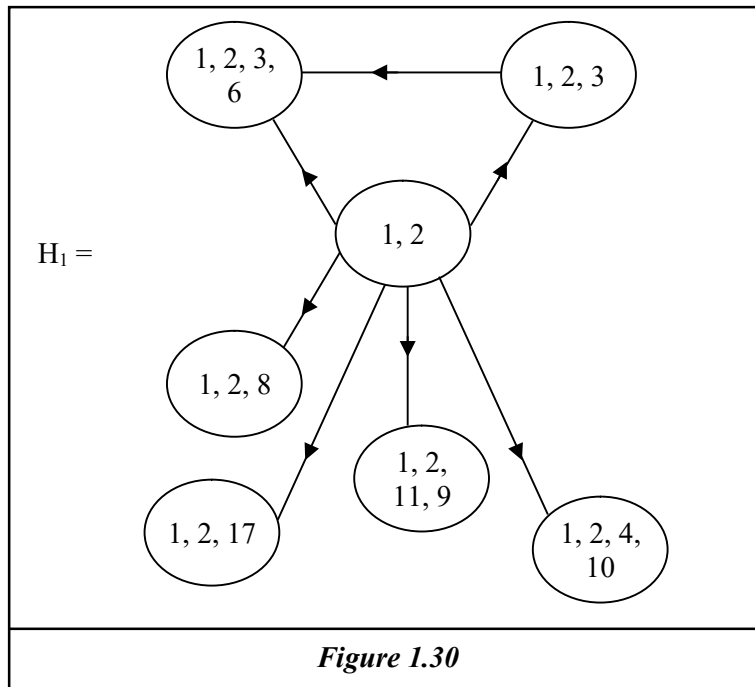

We give the local complement B_1 of H_1 in G which is given by the following figure.

Vertex subgraph of G but it is disconnected.

Let H_2 be another special subset vertex subgraph H_2 of G given by the following figure.

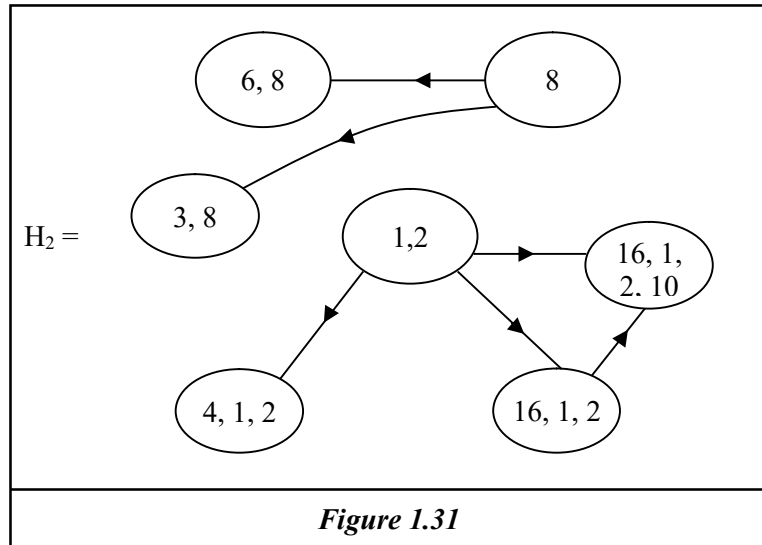

H_2 is a special subset vertex subgraph of G which is disconnected

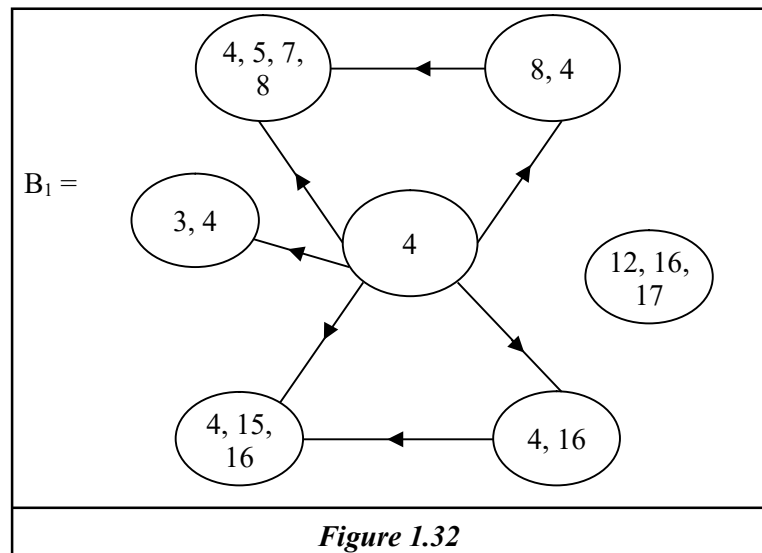

We see the local complement of H_1 in G is a special subset.

Now we find the local complement B_2 of H_2 in G .

B_2 is given by the following figure.

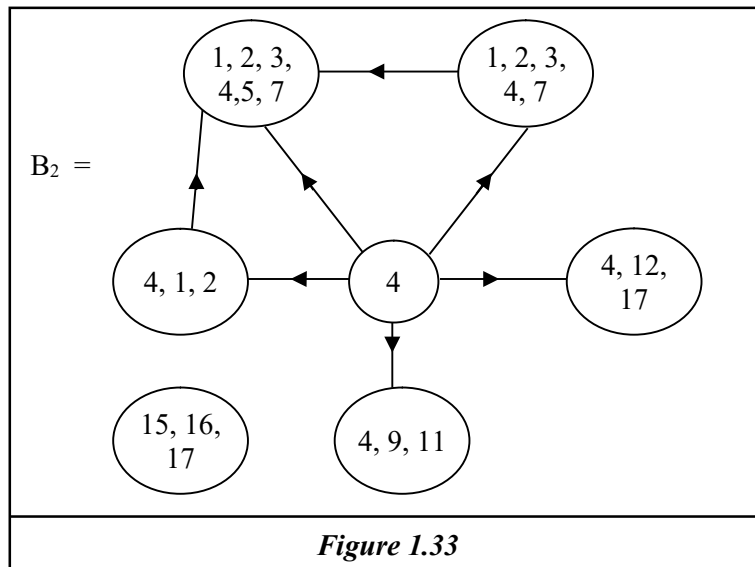

We see B_2 is also a disconnected special subset vertex subgraph of G with two components. Subset vertex subgraphs can also be obtained by removing edges. This concept is elaborately dealt in Chapter III of this book.

Now we proceed onto describe subset vertex multigraphs of type I and type II [53-5].

We define a subset vertex multigraph G with vertex subsets $v_1, v_2, \dots, v_n \in P(S)$ where $P(S)$ is a power set of the set S as follows the vertices v_i and v_j has t edges if (i) $v_i \cap v_j \neq \phi$ ($i \neq j$) (ii) If $v_i \cap v_j = A_{ij}$ then there are $|A_{ij}|$ (order of A_{ij} ; the subset that is number of elements in A_{ij}) number of edges between v_i and v_j .

Thus in case of subset vertex multigraphs of type I also the number of edges between any two subset vertices is automatically fixed.

We will provide one example as this concept of special subset vertex multisubgraphs are elaborately dealt in chapter II of this book.

Example 1.9. Let G be the vertex multigraph given by the following figure. Vertex subsets of G are from the power set $P(S)$ where $S = Z_{18}$.

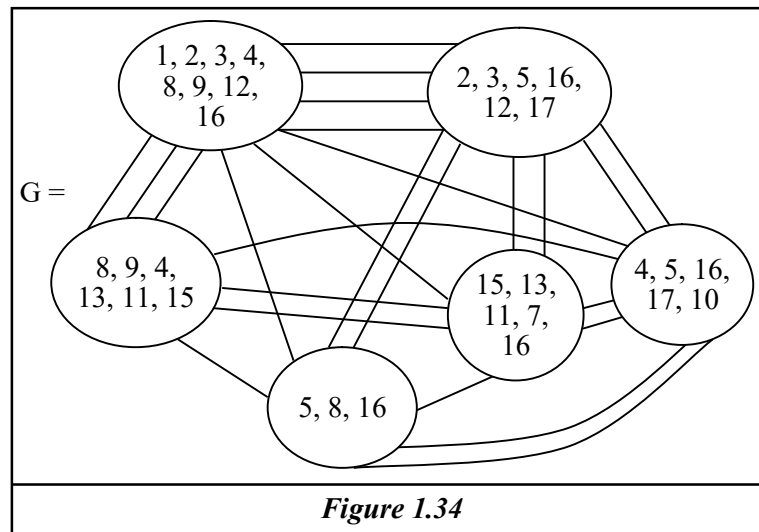
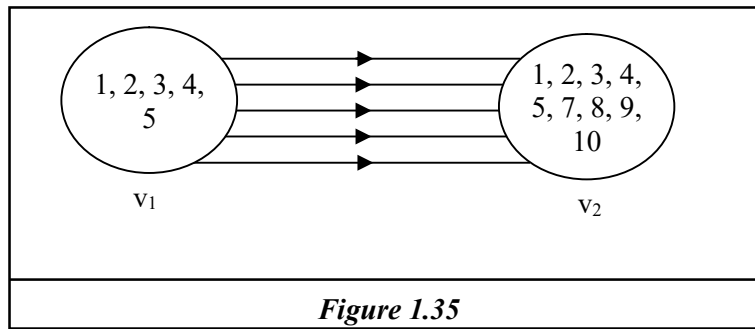

Figure 1.34

Clearly G is a type I subset vertex multigraph. The number of edges is automatically fixed and also the edges are automatically fixed in G . For more refer [53-5].

However, we have not dealt with type II subset vertex multigraphs we briefly describe them in the following.

Suppose we have two vertex subsets.



This will be defined as injective multigraph with subset vertices, basically we need $v_1 \subseteq v_2$.

If we have the relation or directed edges as

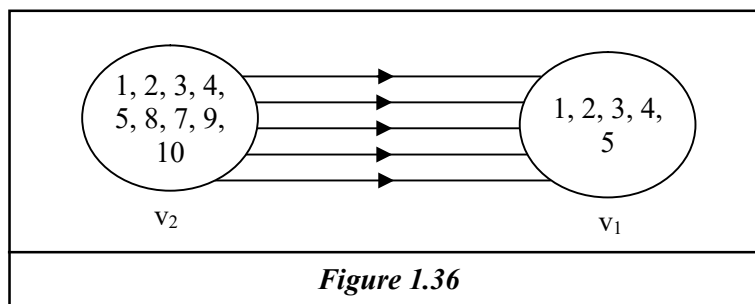

This sort of relating the edges will be defined as projective multigraphs of vertex subsets.

In view of all these we have the following definition.

Definition 1.3. Let S be a finite set, $P(S)$ the power set of S .

Let $v_1, v_2, \dots, v_n \in P(S)$ be the vertex set of the directed subset vertex multigraph G , we say there exist t edges between v_i and v_j if $v_i \subset v_j$ ($i \neq j$), v_i is a proper subset of v_j and $|v_i| = t$; $1 \leq t \leq |S|$. This is true for every i, j ; $1 \leq i, j \leq n$.

We call this subset vertex multigraph as injective or type II directed subset vertex multigraph.

If on the other hand, we draw t edges from v_j to v_i ($v_i \subseteq v_j$; $|v_i| = t$) then we call the resulting subset vertex multigraph as projective subset vertex multigraph.

We provide examples of them in the following.

Example 1.10. Let G be a directed subset vertex multigraph with vertex set from $P(S)$ the power set of S where $S = Z_{18}$ given by the following figure.

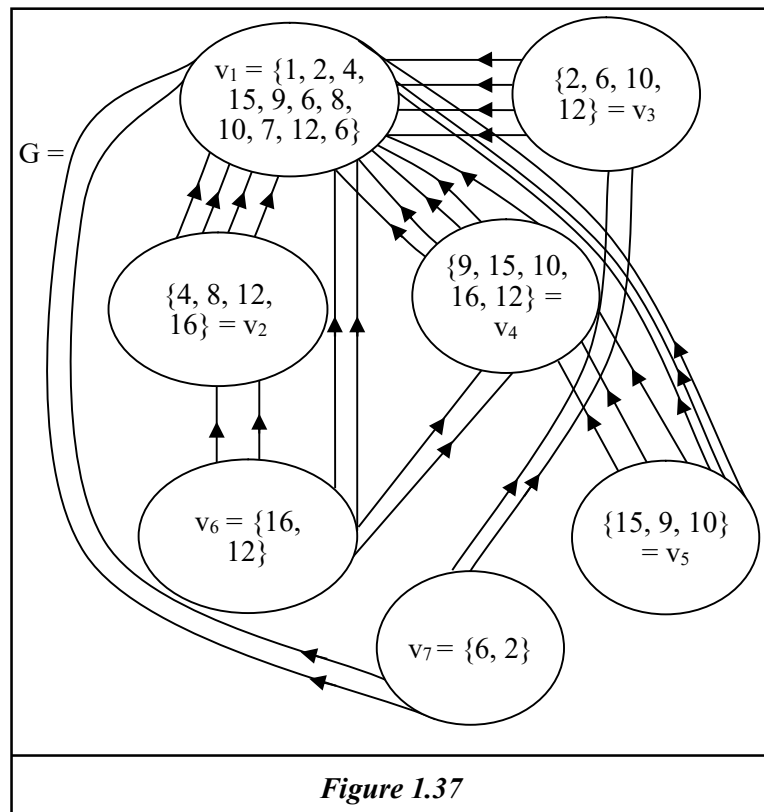

Finding subset vertex multisubgraphs and subset - subset vertex multisubgraphs is a matter of routine.

However we provide a few examples of them.

Let H_1 be a subset vertex multisubgraph of G given by the following figure.

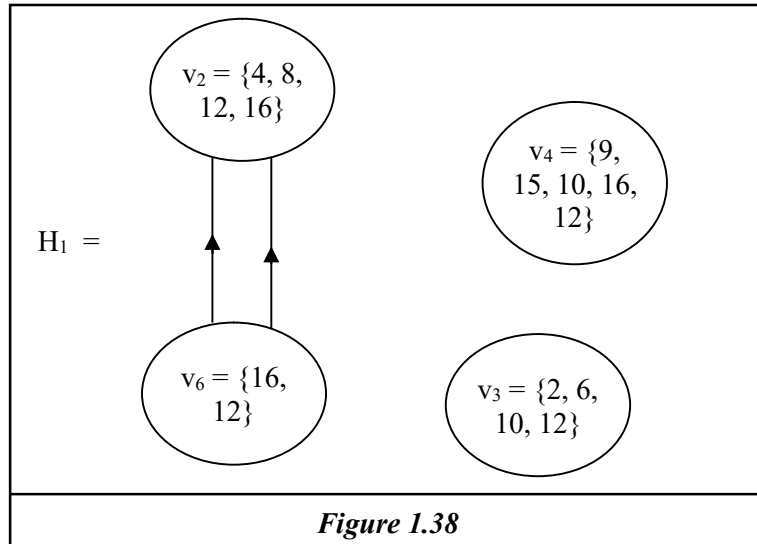

H_1 is a disconnected subset vertex multisubgraph of G .

Let P_1 be a subset - subset vertex multisubgraph of G given by the following figure.

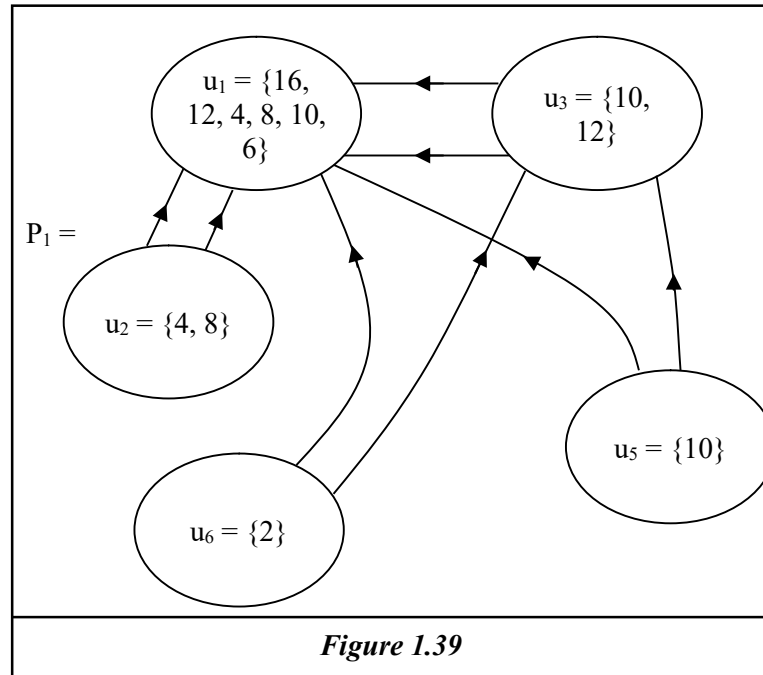

where $u_i \subseteq v_i, i=1, 2, 3, 6, 5$.

Clearly P_1 is a connected subset - subset vertex multisubgraph of G .

Now we give one example of a special subset vertex multisubgraph B_1 of G given by the following figure.

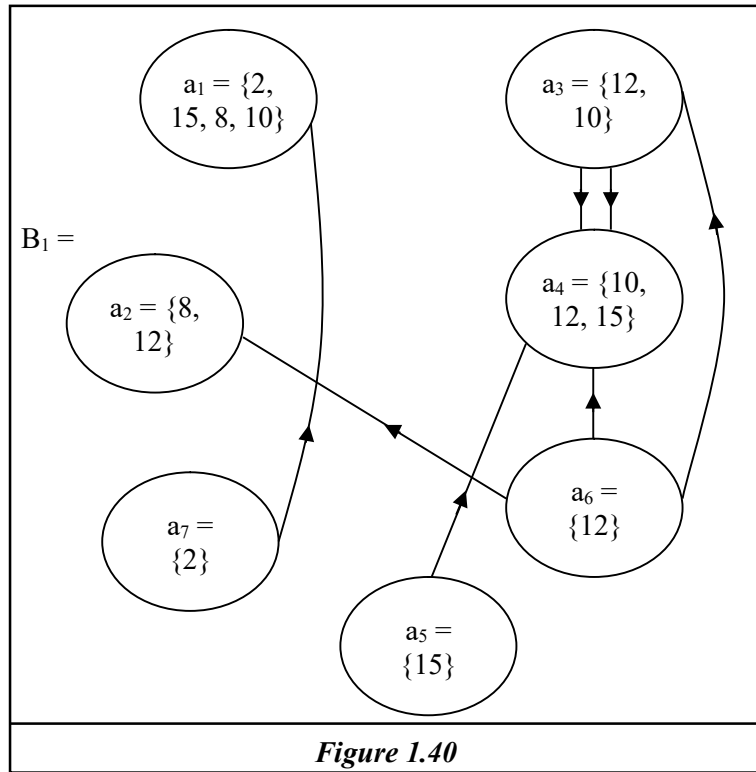

Here $a_i \subset u_i$; $1 \leq i \leq 7$ are the vertex subset of B .

B_1 is a special subset vertex multisubgraph of G .

We now find the local complement T_1 of B_1 relative to G . T_1 is given by the following figure.

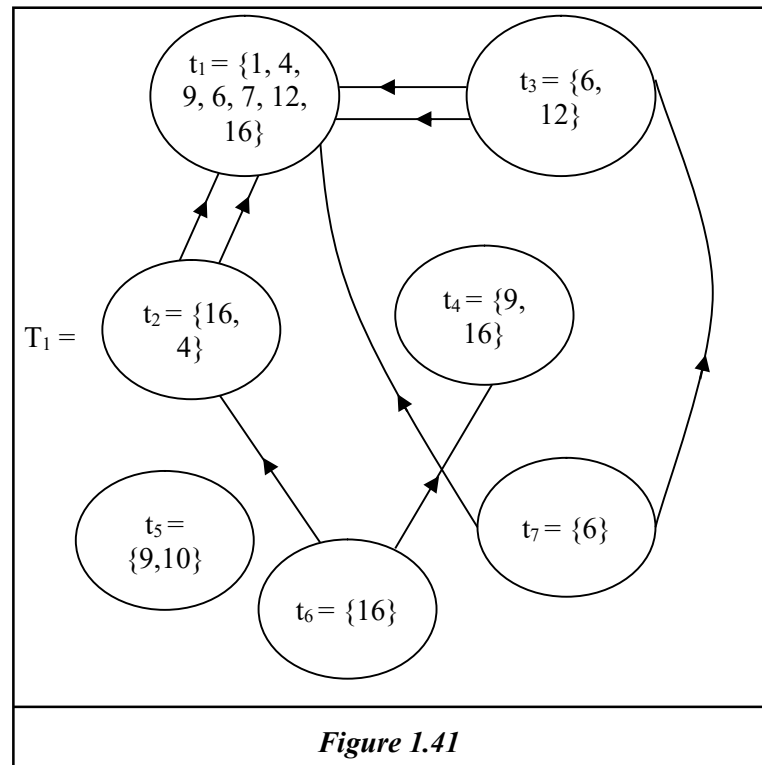

Clearly T_1 the local complement of B_1 is also a special subset vertex multisubgraph of G . T_1 will not be defined even if one pair of vertices $v_i \setminus u_i = v_j \setminus u_j$, $i \neq j$; $u_i \subseteq v_i$ and $u_j \subseteq v_j$.

Interested reader is requested to refer [53-5].

We now proceed onto explain that in case of directed special subset vertex multisubgraphs also behave more like undirected special subset vertex multisubgraphs only the direction is maintained.

When the study of subset vertex multisubgraphs got by removing edges is dealt, we see it is very important to note that when the edges get removed correspondingly the subsets of

these vertex subsets also lose one or more elements. It is mandatory if an edge from v_i to v_j is removed where there are more than one edge from v_i to v_j then one element say $t \in v_i \cap v_j$ is removed. So it has become a dire necessity to label the edges also as in that case there will not ambiguity which edge is removed. For instance if there are four edges from v_i to v_j given by the following figure.

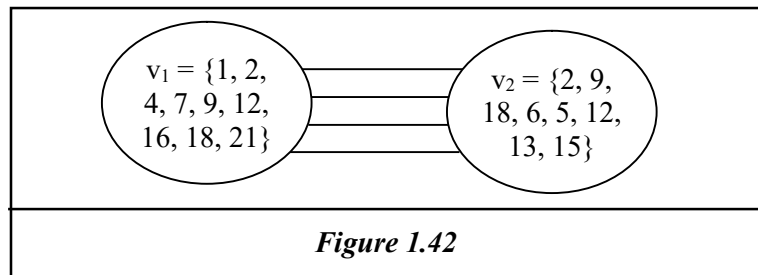

We see if one edge is removed one element from v_1 and v_2 is to removed and it should be same in both v_1 and v_2 ; which can be 2 or 9 or 12 or 18.

But which will one remove there are 4 ways this can be done so the solution or the result one gets may not be unique for this in turn will also affect the other edges of the mutligraph G so it is mandatory we should label also the edges of a subset vertex multigraphs be it of type I or type II.

Example 1.11. Let G be a subset vertex multigraph of type I given by the following figure for which both edges and vertices are labeled. G is given by the following figure.

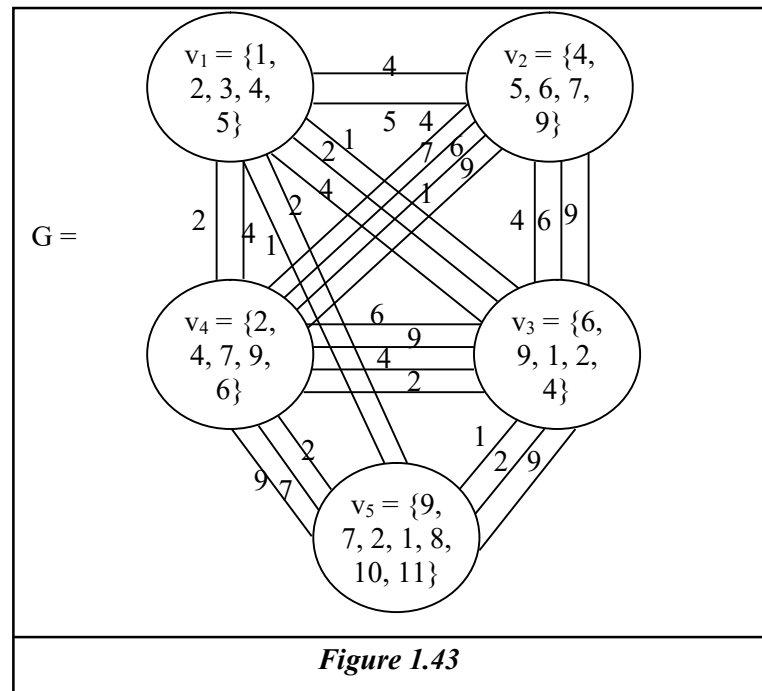

Suppose the edge labeled 4 is to be removed connecting v_1 and v_2 .

Then the vertex sets of v_1 and v_2 are $\{1, 3, 2, 5\} = u_1$, $u_2 = \{5, 6, 7, 9\}$ respectively rest of the vertices remain the same.

The resulting subset vertex multisubgraph is as follows.

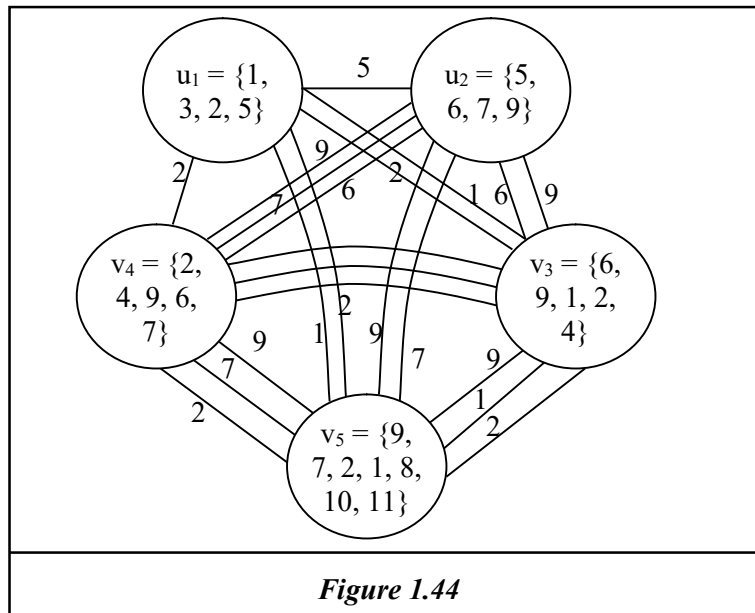

Unlike usual graph removal of one edge may result automatically by the definition remove more edges. In this case it has resulted in the removal of four edges.

This study is interesting and is carried out in chapter III of this book.

Suppose we are interested in removing two edges say edge with label four from v_1 to v_2 and edge with label 9 from v_4 to v_5 .

We find out how many edges in total are removed.

Let K be the subset vertex multisubgraph got from G after the removal of the above mentioned edges.

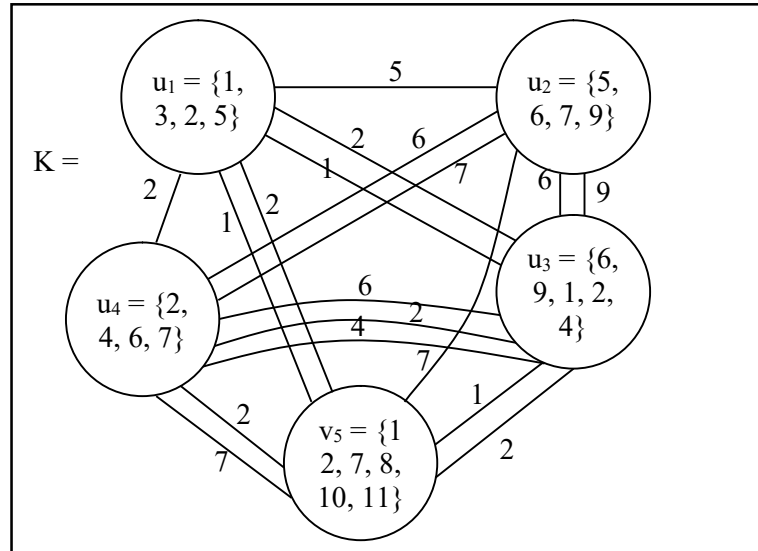

Figure 1.45

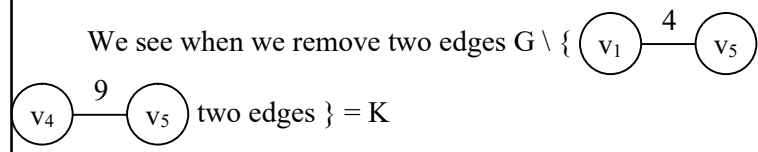

Figure 1.46

in the resulting subset vertex multisubgraph we see 10 edges are removed by the very definition of subset vertex multigraphs.

This is not the case with usual graphs.

Now we study the same situation in case of vertex subset graphs. We realize in that case even more changes may occur.

We first illustrate this situation by some examples.

Example 1.12. Let G be a subset vertex multigraph given by the following figure.

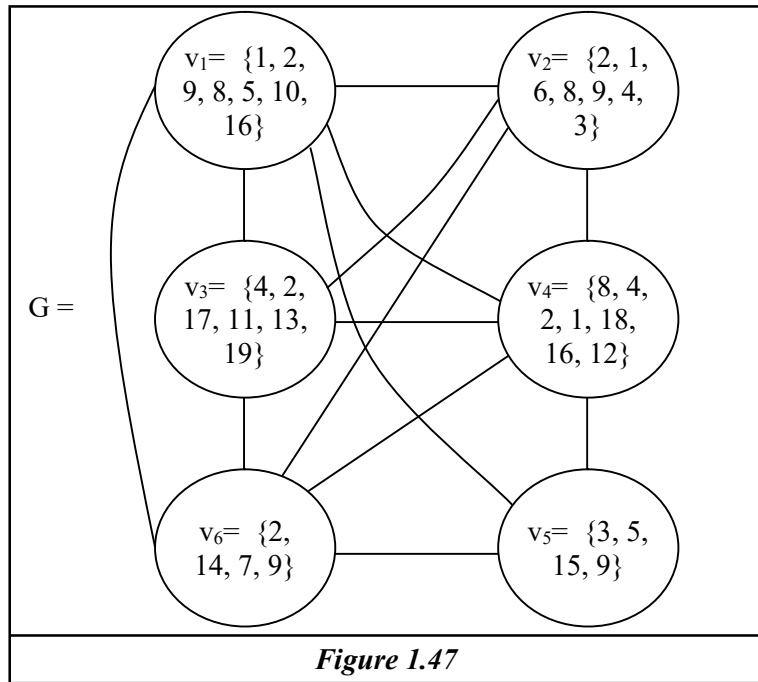

The vertex subsets v_1, v_2, v_3, v_4, v_5 and v_6 are from the power set $P(S)$ where $S = Z_{20}$.

Suppose the edge from v_1 to v_2 is removed from G then $G \setminus \{\text{edge } v_1 v_2\}$, the subset vertex subgraph is given by the following figure.

We see the edge is constructed from v_1 to v_2 as $v_1 \cap v_2 = \{1, 2, 9, 8\}$ all these elements from both v_1 and v_2 is to be removed.

Let H_1 be the resulting subset vertex subgraph given by the following figure.

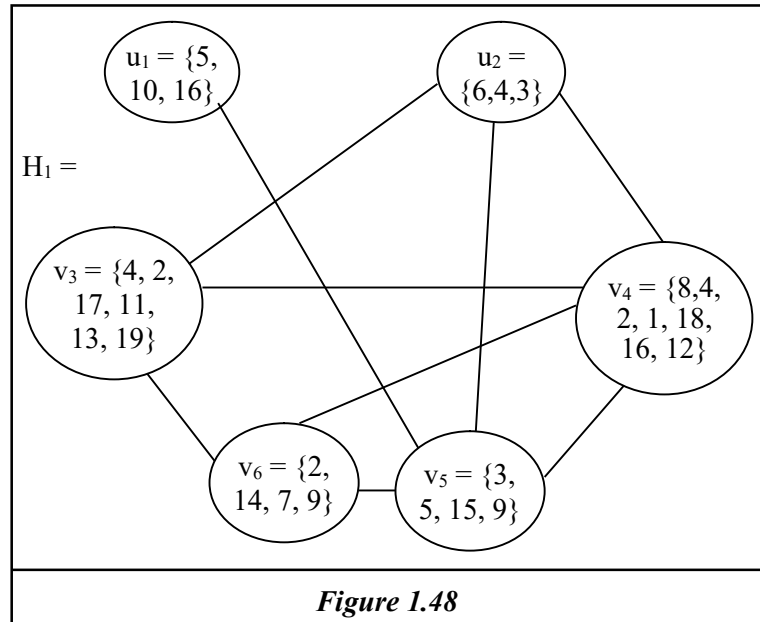

We see 6 edges are automatically removed when only one edge is removed in G .

Let H_2 be the subset vertex subgraph for which edges v_1 to v_2 and v_4 to v_3 are removed. That is $H_2 = G \setminus \{v_1, v_2, v_3, v_4\}$ is given by the following figure.

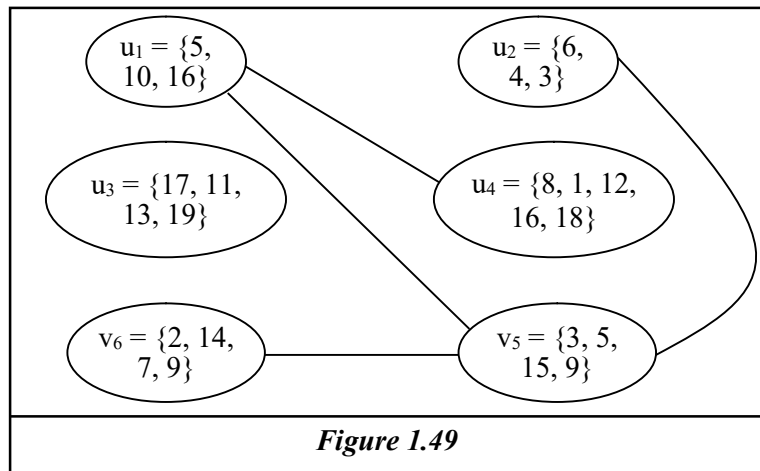

We see in H_2 the subset vertex graph all edges except 4 are removed.

Thus removal of all edges makes the subset vertex graph as one with only 4 edges.

Study of this type is carried out in chapter III of this book.

It is interesting to note removal of two or more edges may result even in an empty graph or a disconnected one. Study in this direction is completely carried out in the chapter III of this book.

In case of directed subset vertex graphs the procedure is little different. We will describe this by an example.

Example 1.13. Let G be directed subset vertex graph given by the following figure.

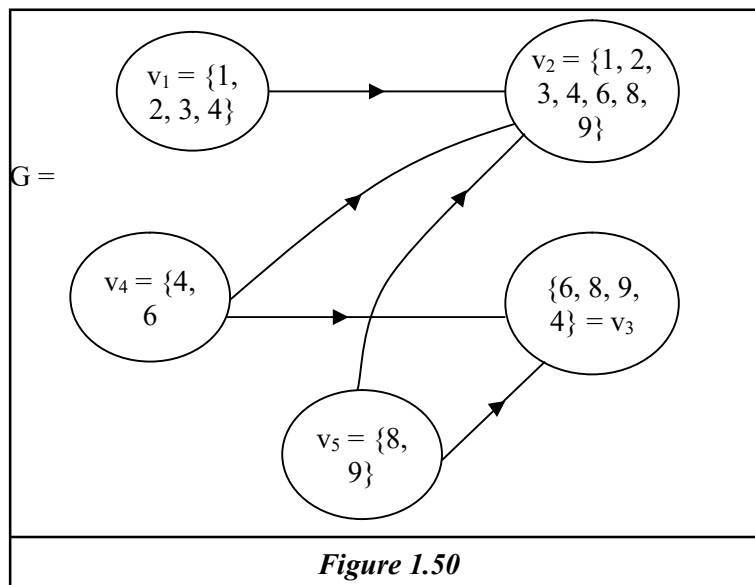

We find $G \setminus \{\overline{v_1 v_2}\}$ edge removed. Let H_1 be the subset vertex subgraph of G given by the following figure.

This automatically removes $\{1, 2, 3, 4\}$ that is v_1 so H_1 will have only 4 vertices.

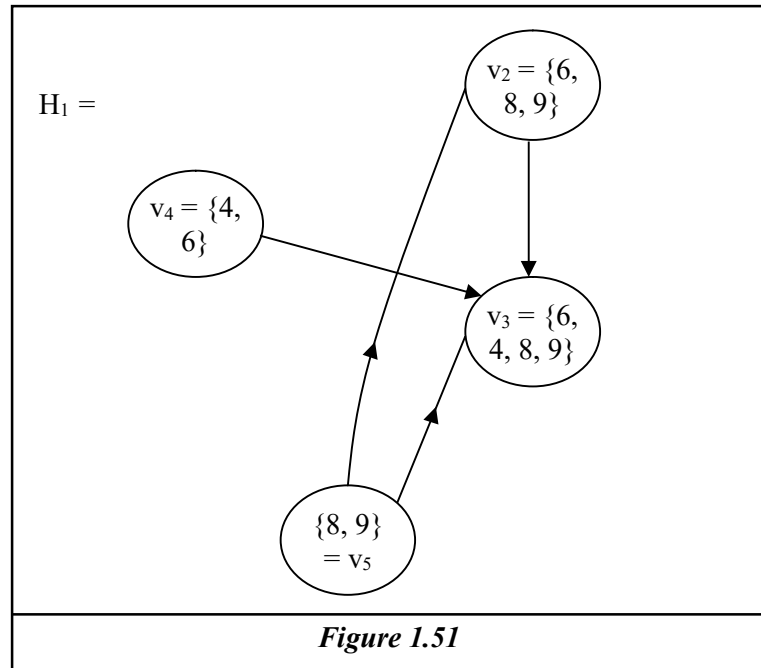

H_1 is disconnected it has 3 edge one edge and a vertex subset v_1 is lost.

Now consider $H_2 = G \setminus \{\overline{v_1 v_2}, \overline{v_5 v_3}\}$ given by the following figure.

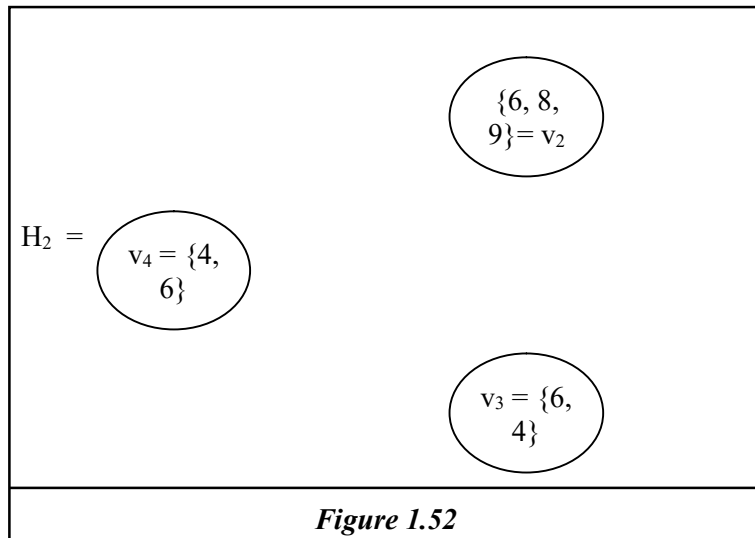

We see H_2 is not even defined as the node v_4 and $v_3 \setminus v_5$ is same as v_4 .

This is an extreme case. However in case when two edges are removed from G the subset vertex subgraph $G \setminus \{ \overline{v_1 v_2}, \overline{v_5 v_3} \}$ does not exist.

This is never the case in usual graphs when that graph has more than 2 edges.

Study in this direction is in fact very challenging.

Chapter Two

SPECIAL SUBSET VERTEX MULTISUBGRAPHS

In this chapter authors for the first time introduce a new notion of special subset vertex multisubgraphs of a subset vertex multigraph. The notion of special subset vertex subgraphs was introduced in [53]. These special subset vertex subgraphs can find the best applications in fault tolerant networks or they can be also precisely defined as fault tolerant graphs (or subset vertex graphs). These special subset vertex multisubgraphs can be used in fault tolerant multi-networks; to be more appropriate they can be also known as fault tolerant multisubgraphs or fault tolerant subset vertex multisubgraphs.

We will first illustrate this situation by some examples.

Example 2.1. Let $S = \{Z_{18}\}$ be a set of finite order. $P(S)$ be the powerset of S . $P(S)$ consists of all subsets of S including the empty set and the set S itself.

Let G be an ordinary subset vertex multigraph with vertex set v_1, v_2, v_3, v_4 and v_5 where $v_1 = \{0, 1, 3, 5, 7, 11, 12\}$, $v_2 = \{0, 1, 11, 2, 4, 6, 8\}$, $v_3 = \{2, 4, 6, 8, 9, 11, 12\}$, $v_4 = \{0, 1, 3, 6, 9, 10, 12, 14\}$ and $v_5 = \{9, 10, 2, 4, 11, 7, 0\}$ are subsets from $P(S)$.

The ordinary subset multigraph G is as follows.

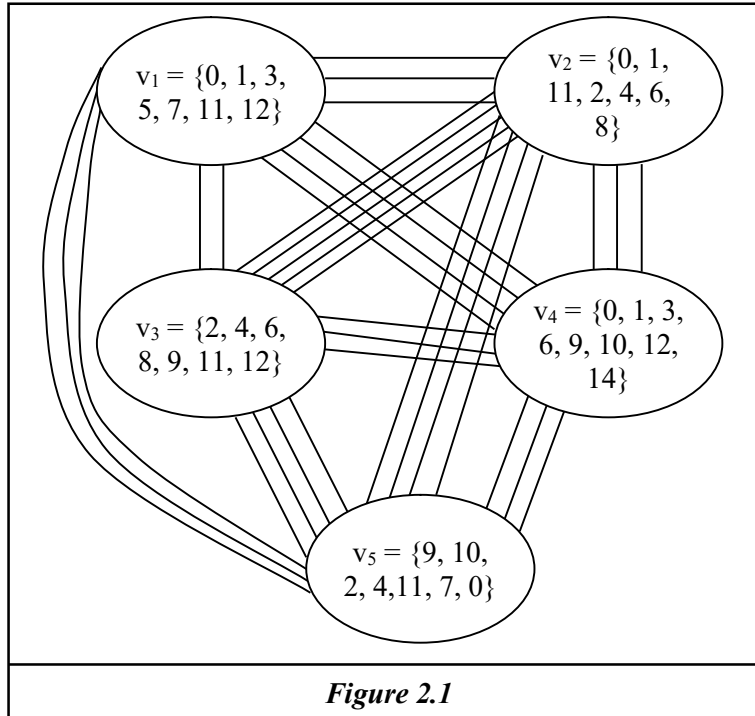

Clearly G is an ordinary pseudo complete subset vertex multigraph of type I.

Now we find ordinary special subset vertex multisubgraphs of type I in the following.

Let H_1 be an ordinary special subset vertex multisubgraph of type I given by the following figure.

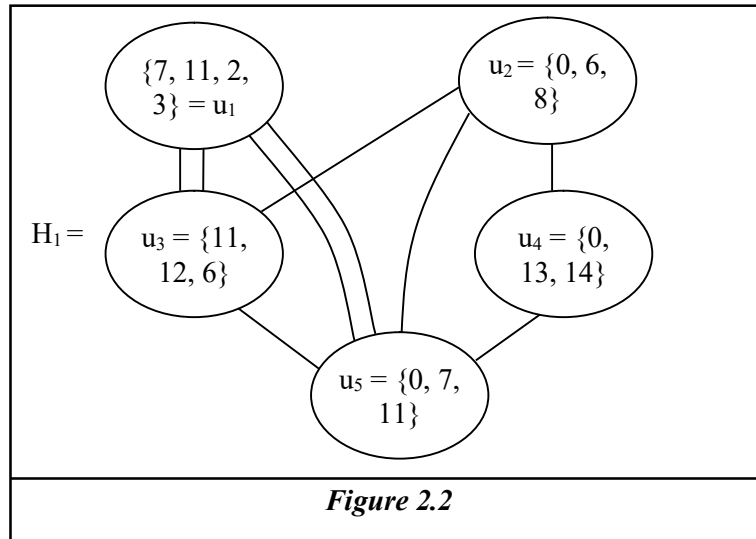

H_1 is not pseudo complete, H_1 is only an ordinary special subset vertex multisubgraph of type I.

Consider the ordinary special subset vertex multisubgraph H_2 of type I given by the following figure;

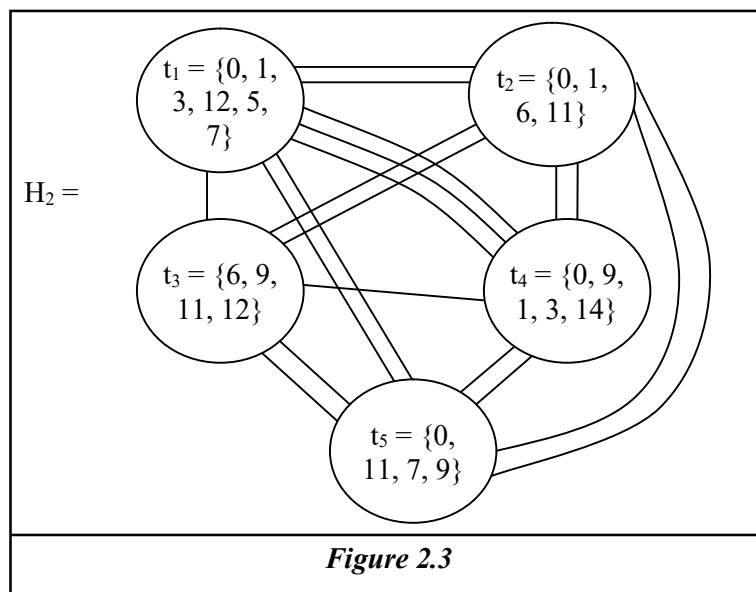

Clearly H_2 the ordinary special subset vertex multisubgraph of G of type I is also pseudo complete.

However, the number of multi-edges of G and H_2 are not the same.

Now we find the local complements of H_1 and H_2 relative to G .

Let K_1 be the local complement of H_1 relative to G given by the following figure.

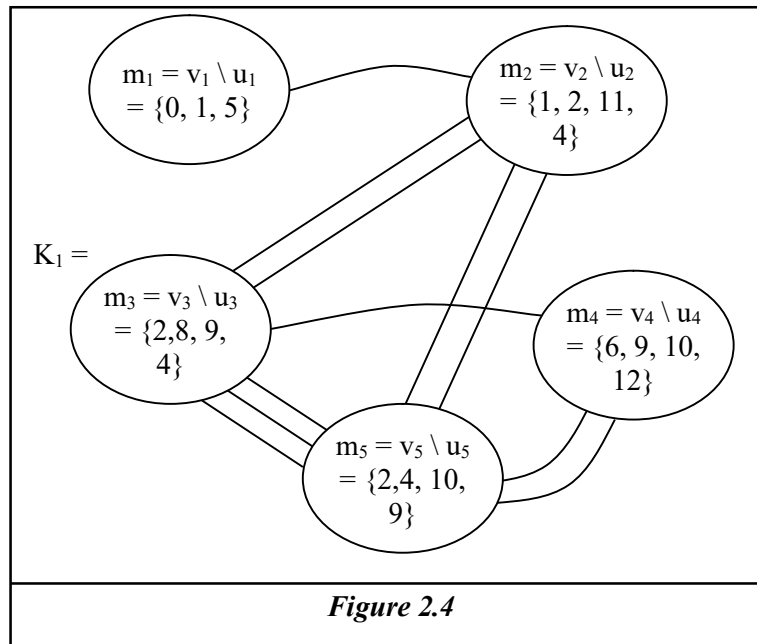

We see K_1 the ordinary special subset vertex multisubgraph of type I is also not complete or pseudo complete.

Let K_2 be the local complement of H_2 relative to G given by the following figure.

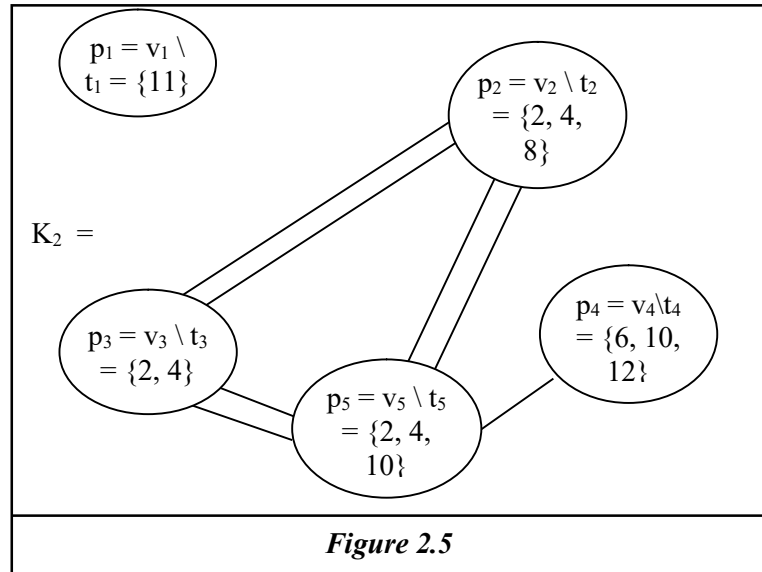

K_2 the special subset vertex multisubgraph of G which is the local complement of H_2 and is not pseudo complete; however, H_2 is pseudo complete.

Let H_3 be a special subset vertex multisubgraph of G given by the following figure.

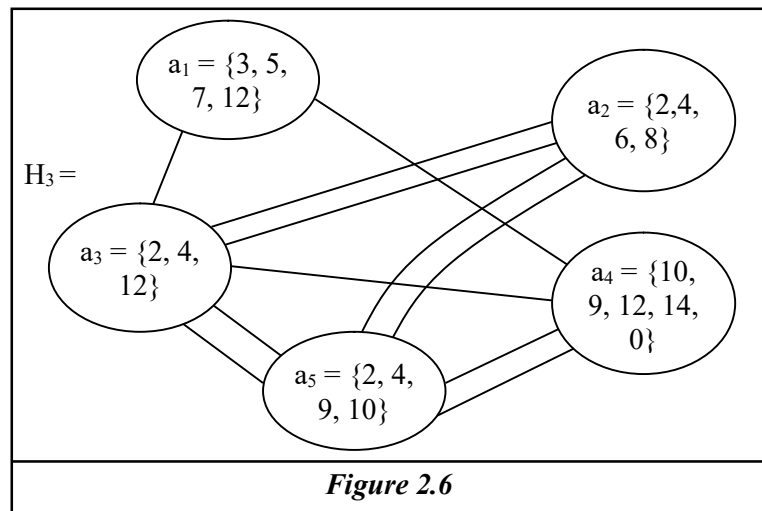

H_3 is the ordinary special subset vertex multisubgraph of G of type I. Clearly H_3 is not pseudo complete.

Now let K_3 be the local complement of H_3 relative to the subset vertex multigraph G the figure of which is given below.

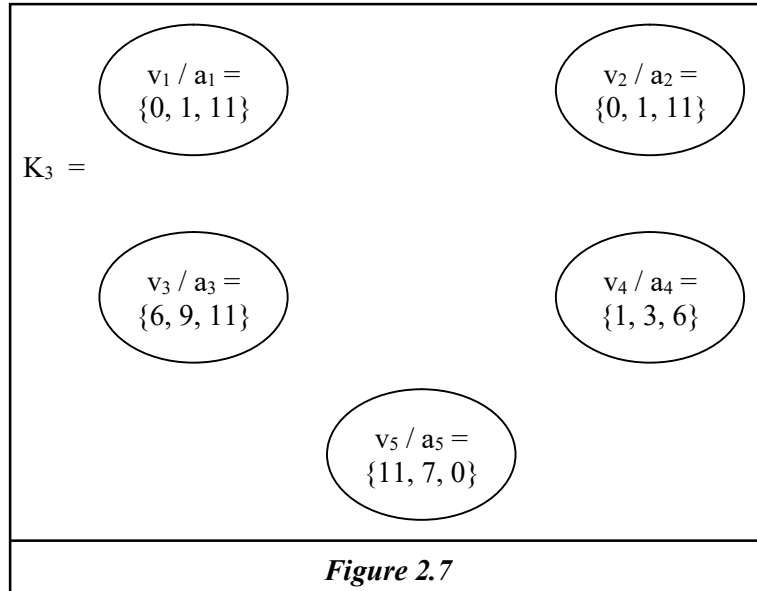

We see $v_1 \setminus a_1 = v_2 \setminus a_2 = \{0, 1, 11\}$ hence the local complement does not exist for this H_3 , we do not call this even as empty subset vertex multigraph.

Thus it is important to keep on record that given a subset vertex multigraph of type I, G for any special subset vertex multisubgraph H of G we are not always guaranteed in general of the local complement for any special subset vertex multisubgraph.

The condition for the same is described by the following theorem.

Theorem 2.1. Let S be any set of finite order $P(S)$ the powerset of S . Let G be any ordinary subset vertex multigraph of type I with v_1, v_2, \dots, v_n as the n -vertex subsets from $P(S)$. Let H be a subset special vertex multisubgraph of G with $u_i \subseteq v_i; i = 1, 2, \dots, n$. The local complement of H relative to G exists if and only if $v_i \setminus u_i \neq v_j \setminus u_j; i \neq j; 1 \leq i, j \leq n$.

Proof is direct and hence left as an exercise to the reader.

We proceed onto provide some more examples of this situation.

Example 2.2. Let $S = \{Z_{27}\}$ be a set of order 27; $\{a_1, a_2, \dots, a_{27}\} = S$ can also represent what we basically need only a set with 27 elements it can be imaginary or complex or indeterminate or even dual numbers. $P(S)$ be the powerset of S . Let G be a ordinary subset vertex multigraph of type I given by the following figure.

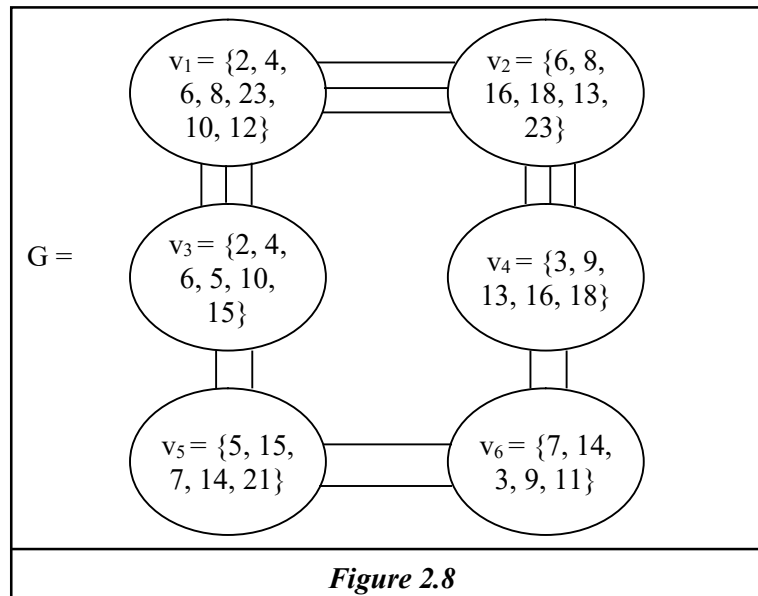

We see G is a circle subset vertex multigraph (multi circle graph) of type I. We find some special subset vertex multigraphs of G .

Let H_1 be the subset vertex special multisubgraph of G given by the following figure.

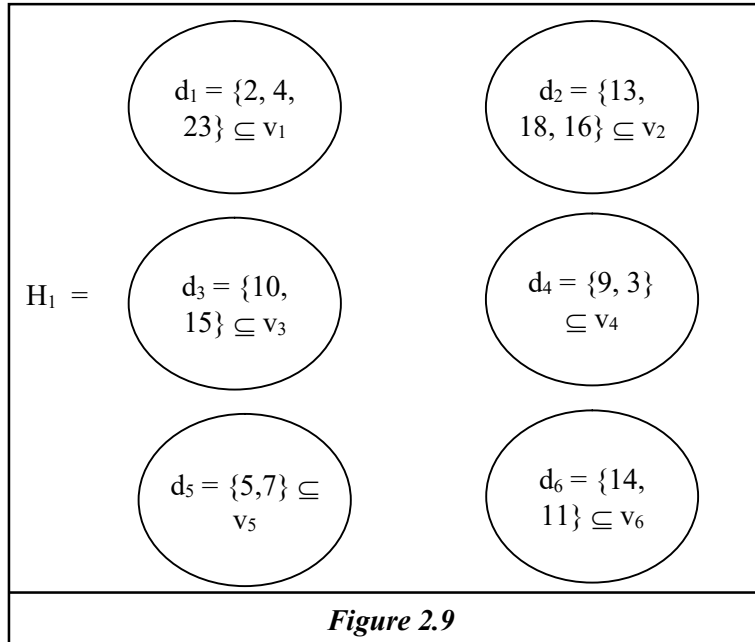

Clearly H_1 is a special subset vertex empty multisubgraph of G .

Let K_1 be the local complement of H_1 relative to G given by the following figure.

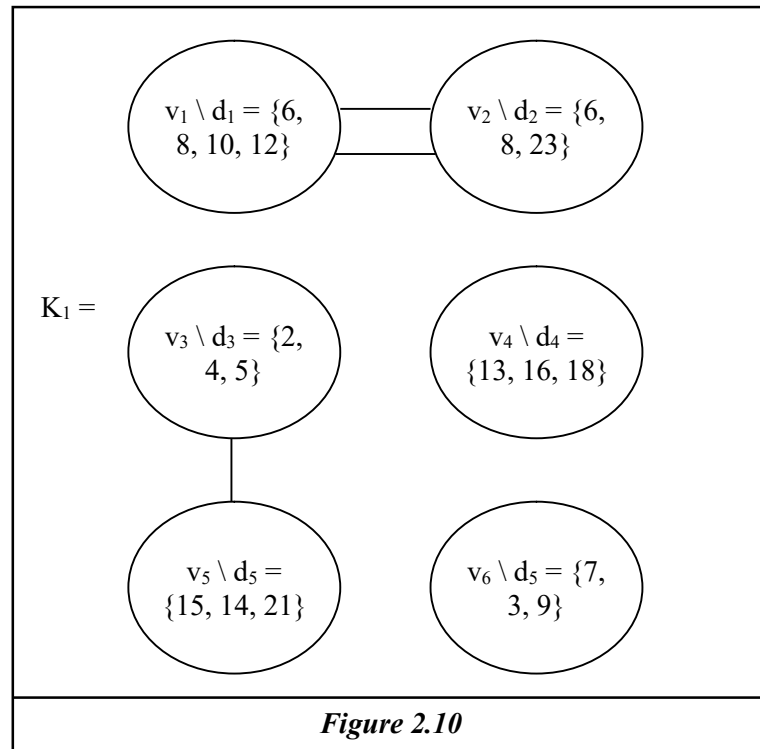

We see K_1 the special subset vertex multisubgraph of G which is the local complement of the empty special subset vertex multisubgraph relative to G is only a disconnected subset vertex special multisubgraph.

Let H_2 be the subset vertex special multisubgraph of G given by the following figure.

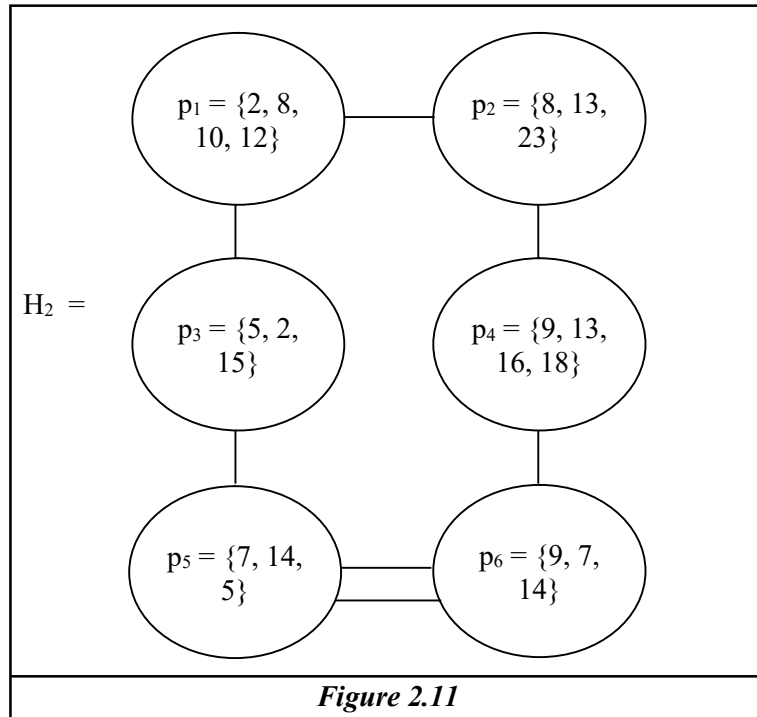

H_2 is a special subset vertex multisubgraph which is the also a multicircle.

We find the local complement K_2 of H_2 relative to G . Let K_2 be the special subset vertex multisubgraph, which is the local complement of H_2 .

The figure of K_2 is as follows.

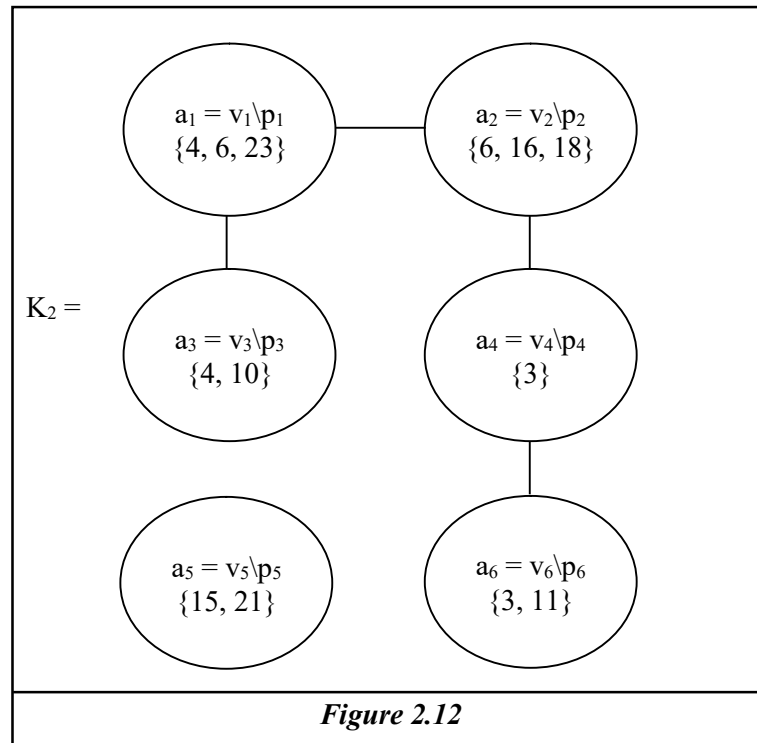

Clearly K_2 is not a circle subset vertex multisubgraph. K_2 is only a subset special vertex multisubgraph which is disconnected.

So we can make the following statements.

Theorem 2.2. *Let S be any finite set, $P(S)$ the powerset of S . G be a subset vertex multigraph. H be a special subset vertex multisubgraph of G . In general H or the local complement of H relative to G may not have the same structure as that of G .*

The reader can prove this theorem by giving example, so the proof is left as an exercise to the reader.

Next we describe some interesting results about the universal complement of an ordinary subset vertex multigraphs of type I by some illustrate examples.

Example 2.3. Let $S = \{a_1, a_2, a_3, a_4, \dots, a_{18}\}$ be a set of order 18. $P(S)$ the powerset of S .

Let G be an ordinary subset vertex multigraph of type I given by the following figure.

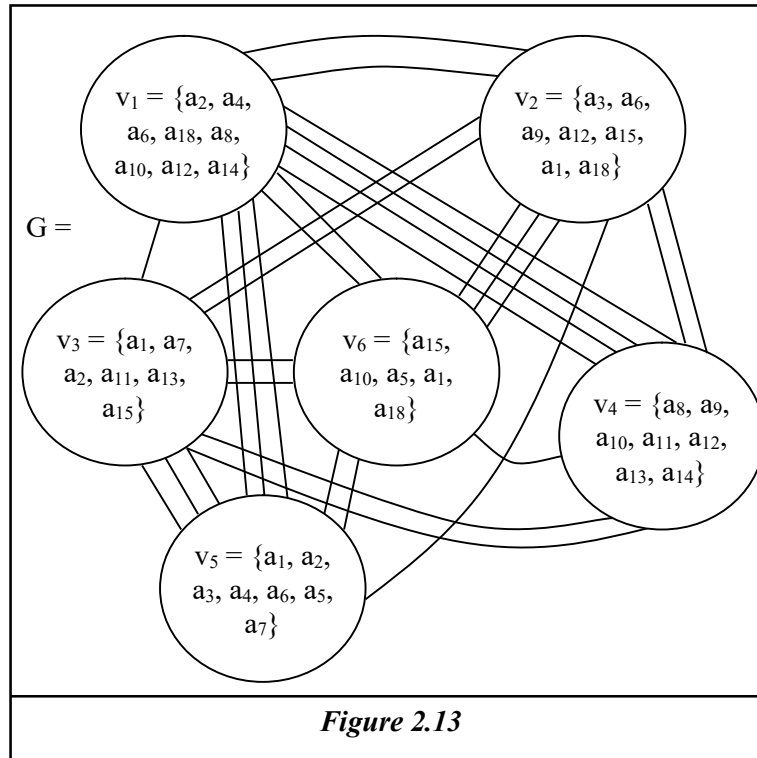

Clearly G is a not pseudo complete subset vertex multigraph of type I.

Now we find the universal complement of G. Let H be the universal complement of G given by the following figure.

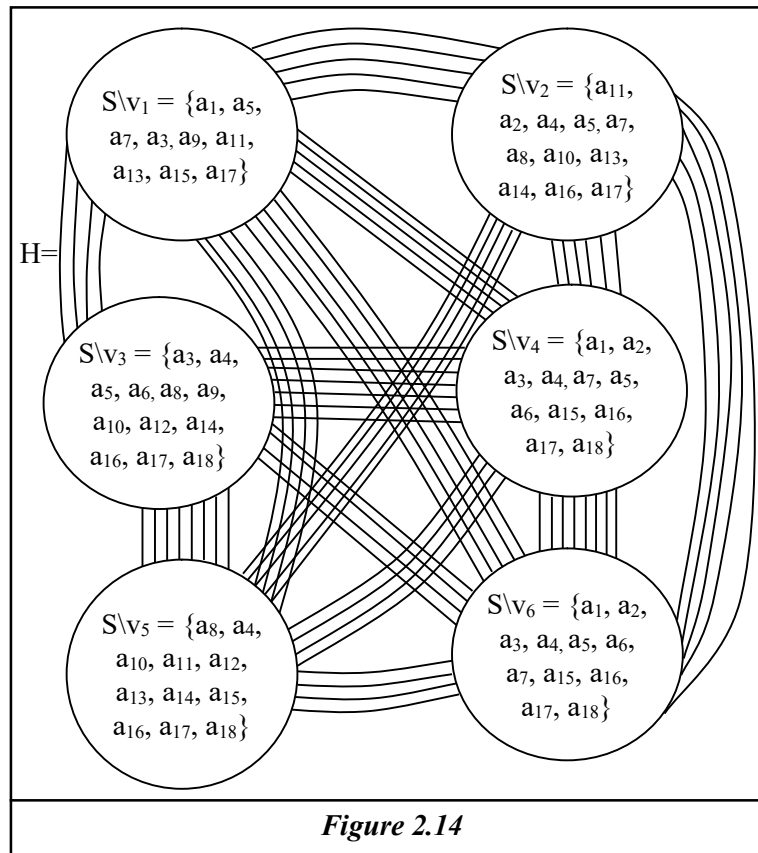

We see the universal complement of G is a subset vertex multigraph of type I which is pseudo complete.

One of the natural questions would be given a subset vertex multigraph of type I G do we have the universal complement for ever such G. The answer is yes.

Theorem 2.3. *Let S be any finite set. $P(S)$ the powerset of S . Let G be the ordinary subset vertex multigraph of type I with n -vertices G has a universal complement G^C however G and G^C in general may not enjoy the same number of multiedges.*

The proof can be given by examples. The reader is left with the task of giving some examples.

The existence of G^C is evident from the fact that if v_1, v_2, \dots, v_n are n subset vertices from $P(S)$ then $S \setminus v_i \neq S \setminus v_j$; if $i \neq j$ as $v_i \neq v_j$; $1 \leq i, j \leq n$. Hence the claim.

Thus G^C the global or universal complement of G always exists for every subset vertex multigraph G of type I.

It is important to note that in case of local complements of a special subset vertex multisubgraphs H of a subset vertex multigraph G . We are not always guaranteed of a local complement. The necessary and sufficient condition for the local complement to exist is given by the following theorem.

Theorem 2.4. *Let S be a finite set $P(S)$ be the powerset of S . G be any subset vertex multigraph with vertex subsets v_1, v_2, \dots, v_n . Let H be the special subset vertex multisubgraph of G . The local complement H^c of H of G exists if and only if $v_i \setminus u_i \neq v_j \setminus u_j$; $i \neq j$; $1 \leq i, j \leq n$.*

Proof. Given $P(S)$ is the powerset of a set S and G is a subset vertex multigraph with vertex set v_1, \dots, v_n . Let H be a special subset vertex subgraph of G with vertex subsets u_1, u_2, \dots, u_n where $u_i \leq v_i$, $i = 1, 2, \dots, n$.

We see if a_1, \dots, a_n be the subset vertices got from v_i and u_i as $a_i = v_i \setminus u_i; i = 1, 2, \dots, n$ then a subset vertex multigraph K with vertex subsets a_1, a_2, \dots, a_n exist if and only if $a_i \neq a_j (i \neq j)$ if $1 \leq i, j \leq n$. For if $a_i = a_j; i \neq j$ then the subset vertex graph K does not exist. Hence the claim.

Example 2.4. Let $S = Z_{18}$ and $P(S)$ the powerset of S . Let G be the subset vertex multigraph given by the following figure.

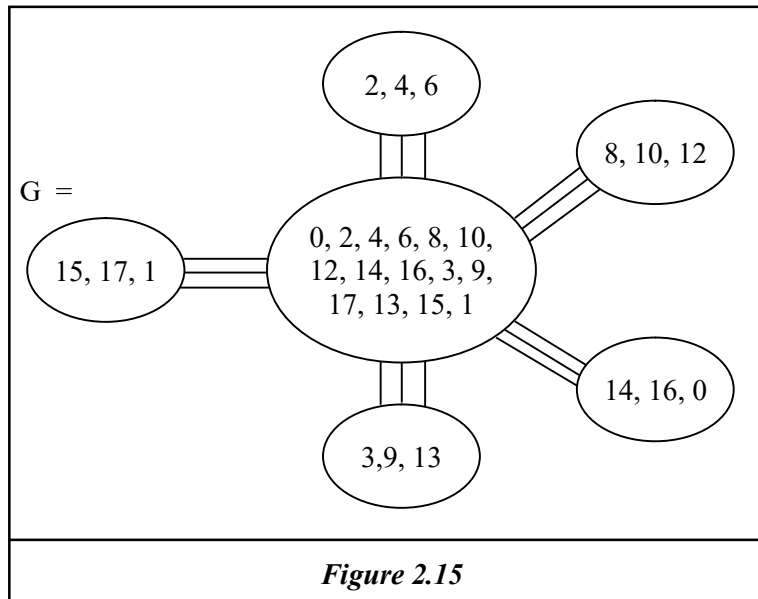

Clearly G is a uniform subset vertex multigraph of type I; infact G is a subset vertex multi star graph. The universal complement of G is given by the following figure.

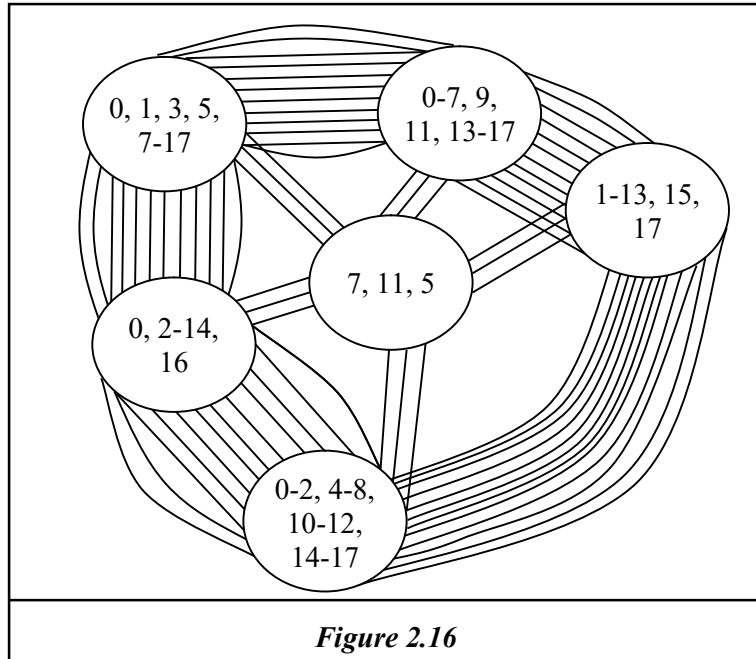

We see the universal complement is a subset vertex multigraph which is a wheel where the star multigraph inside the wheel is uniform and enjoys the same structure as G however the ring or circle is uniform and there are 12 edges between any node barring the centre of the multiwheel.

Now for this G we find some special subset vertex multisubgraphs.

Let H_i be special subset vertex multisubgraph of G given by the following figure.

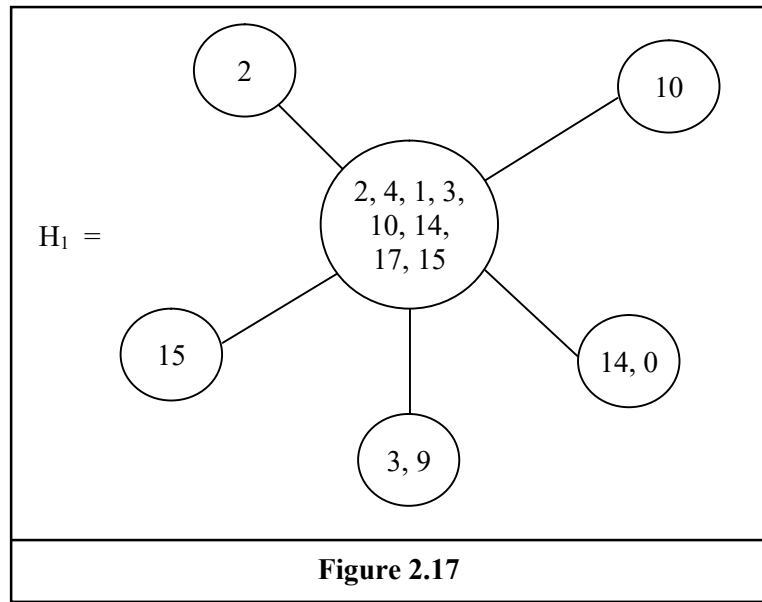

Clearly H_1 is again a subset vertex multisubgraph which enjoys the structure as G but has less number of edges.

Now we find the local complements of H_1 relative to G .

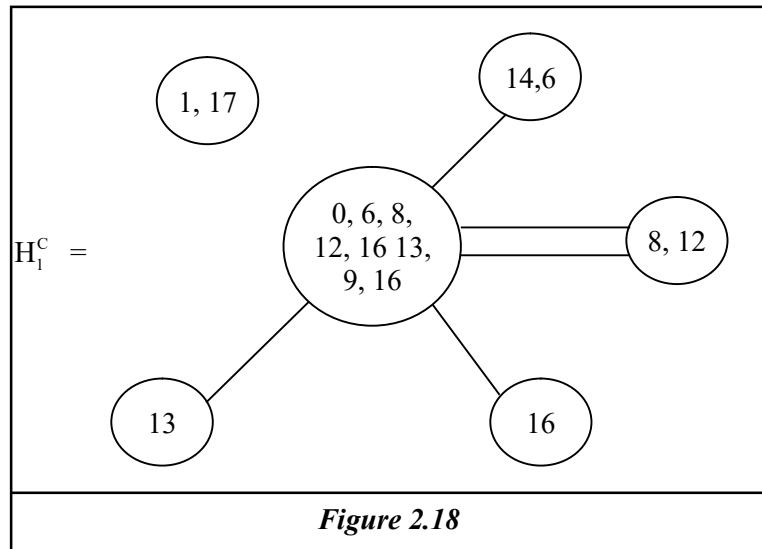

Clearly the local complement is not a star subset vertex multisubgraph. In fact H_1^c is disconnected.

In view of all these we put forth the following result.

Theorem 2.5. *Let $P(S)$ be the powerset of a set S . Let G be the subset vertex multigraph with vertex set from $P(S)$.*

- i) *The universal complement of G need not in general be structure preserving.*
- ii) *Any special subset vertex multisubgraph of G need not in general be structure preserving.*
- iii) *The local complements of special subset vertex multisubgraphs need not in general be structure preserving.*

Proof can be given using examples and counter examples.

We provide some more examples of this situation, which will also be a proof for readers.

Example 2.5. Let $S = \{7, 8, \dots, 15\}$ be a set and $P(S)$ the powerset of S . G be the vertex subset graph with vertex subset from $P(S)$ where $v_1 = \{15\}$, $v_2 = \{15, 14\}$, $\{15, 14, 13\} = v_3$, $v_4 = \{15, 14, 13, 12\}$, $\{15, 14, 13, 12, 11\} = v_5$, $v_6 = \{15, 14, 13, 12, 11, 10\}$ and $v_7 = \{9, 10, 11, 12, 13, 14, 15\}$ is given by the following figure.

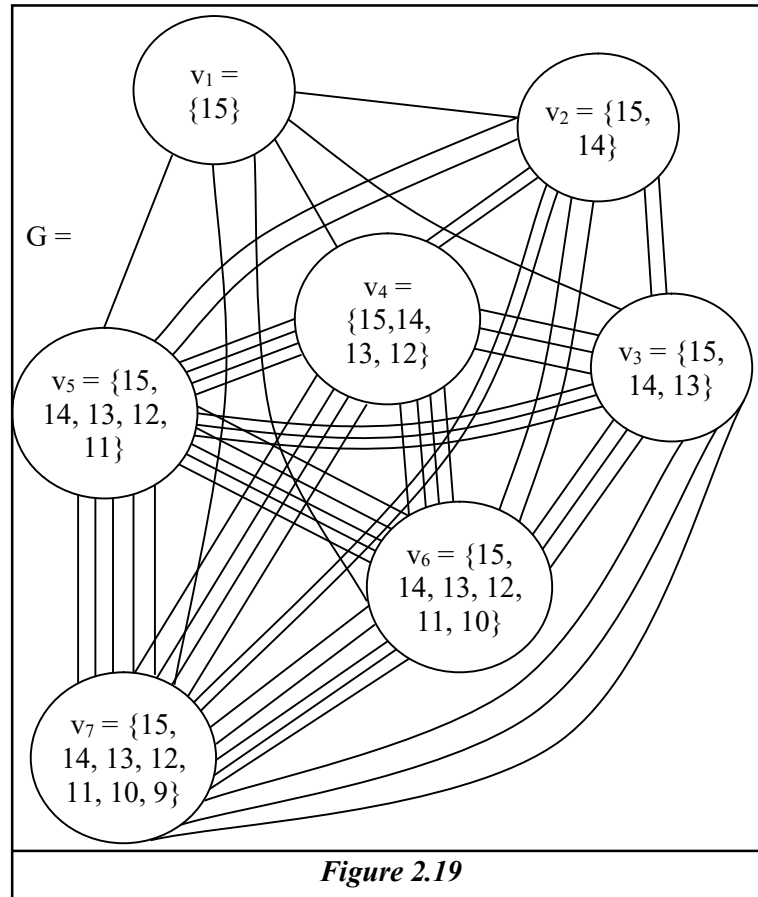

Clearly G is a subset vertex pseudo complete multigraph. Now we find the universal complement G^C of G in the following.

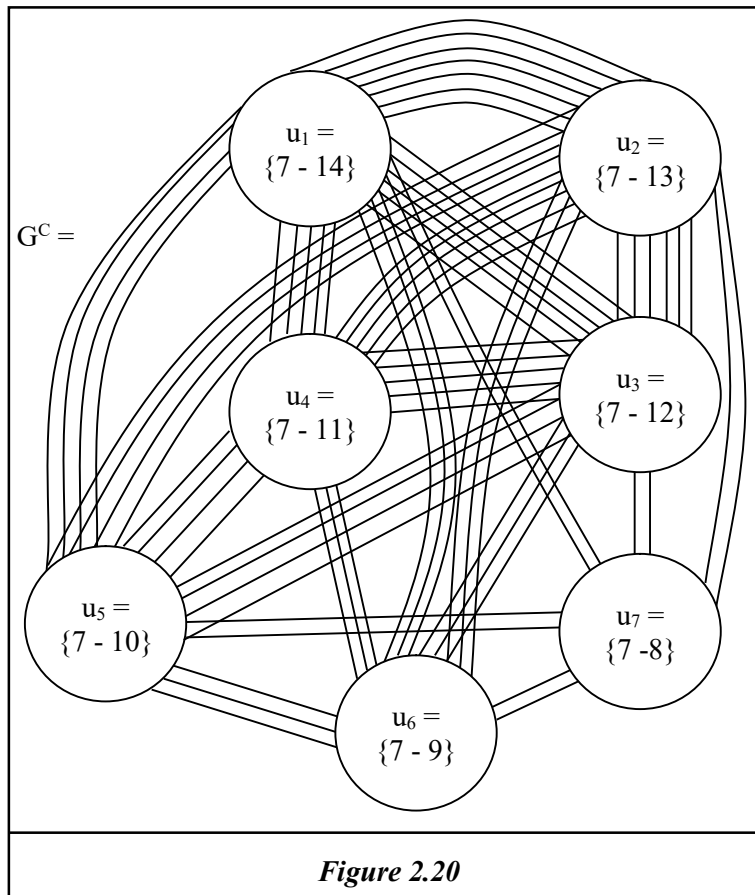

Clearly G^C is also a pseudo complete subset vertex multigraph which is structure preserving. However, number of edges connecting any two nodes are different. In this case $u_i = \{7, 8, \dots, 15\} \setminus v_i$ $i = 1, 2, \dots, 7$, the universal complement of each v_i .

Now we provide yet another examples.

Example 2.6. Let $P(S)$ be the powerset of $S = \{2, 6, 8, 9, 11, 12, 13, 15, 16, 18, 27\}$. Let G be the subset vertex multigraph

whose vertices form a totally ordered chain given by the following figure.

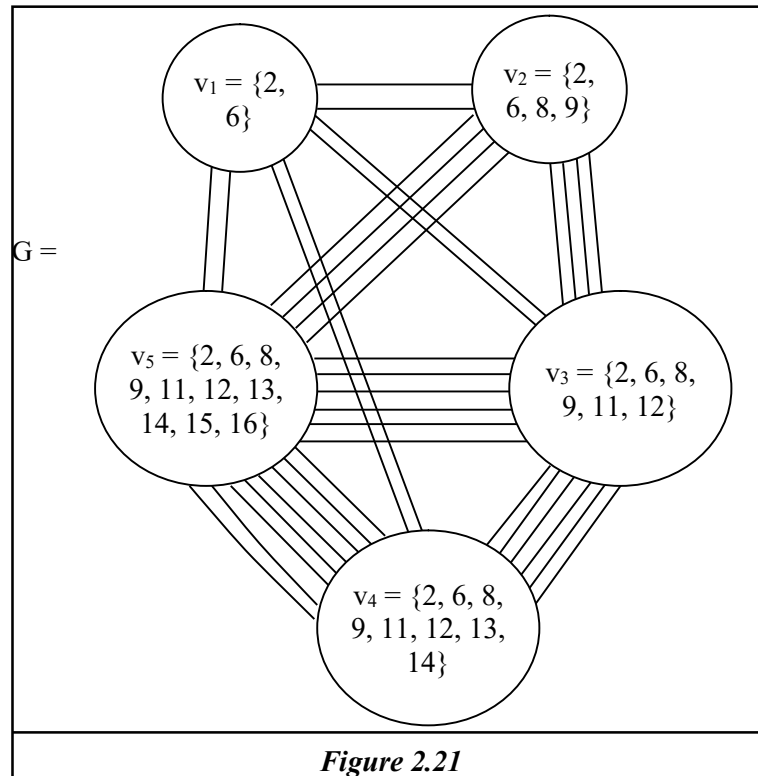

We now find the universal complement of G . The vertex subsets of the universal complement are given by $u_i = S \setminus v_i$; $i = 1, 2, \dots, 5$ where $S = \{2, 6, 8, 9, 11, 12, 13, 14, 15, 16, 18, 27\}$. The universal complement is given by the following figure.

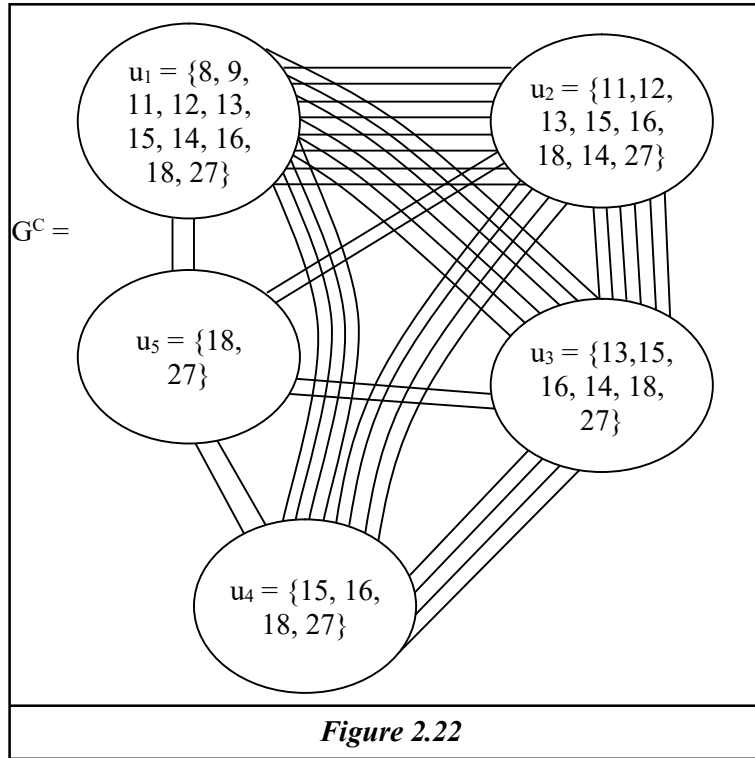

We see G^c the universal complement of G is also pseudo complete and is structurally the same.

In view of all these we develop the following result.

Theorem 2.6 Let S be any set and $P(S)$ the powerset of S .

If $a_1 \subseteq a_2 \subseteq a_3 \subseteq \dots \subseteq a_n$ is a chain such that if $|a_i| = r$ then $|a_2| = 2r, |a_3| = 3r, \dots, |a_n| = nr$ with $|S \setminus a_n| = r$; then

- i) The subset vertex multigraph G with vertex set $\{a_1, a_2, \dots, a_n\}$ is a pseudo complete subset vertex multigraph.

ii) *The universal complement G^C of G is again a pseudo complete multigraph which enjoys the same structure as that of G .*

Proof. Given $P(S)$ is a power set of S . G is a subset vertex multigraph with subset vertex set forming a chain such that

$$a_1 \subseteq a_2 \subseteq \dots \subseteq a_n \text{ with } |a_1| = r, |a_2| = 2r, \dots, |a_n| = nr \text{ and } |S \setminus a_n| = r.$$

Clearly the subset vertex multigraph G results in a pseudo complete subset vertex multigraph, with number edges from a_1 to every a_i , $i \neq 1$ is r and the number of edges from a_2 to a_j ; $j \neq 2$ and 1 is $2r$ and so on.

Now let G^C denote the universal complement of G ; the vertex subset of G^C is $\{u_1 = S \setminus a_1, u_2 = S \setminus a_2, \dots, u_n = S \setminus a_n\}$ and this also forms a chain of the form $u_n \subseteq u_{n-1} \subseteq \dots \subseteq u_1$ where $|u_n| = r, u_{n-1} = 2r, \dots, |u_1| = nr$ with $|S \setminus u_1| = r$.

Thus the universal complement of G also enjoys the same structure as that of G and G^C is also a pseudo complete subset vertex multigraph. Hence the theorem.

We give some examples in which if the conditions of the chain in the theorem are not satisfied then the subset vertex multigraph G and its universal complement may not enjoy the same structure.

Example 2.7. Let $S = \{1, 2, 3, \dots, 16\}$ be a set of order 16 and $P(S)$ the power set of S . Let $a_1 = \{2, 4\} \subseteq \{2, 4, 6, 8\} = a_2 \subseteq \{2, 4, 6, 8, 10, 12\} = a_3 \subseteq \{2, 4, 6, 8, 10, 12, 14, 3\} = a_4 \subseteq \{2, 4, 6,$

$8, 10, 12, 14, 3, 5, 7\} = a_5$ be the vertex subset of the subset vertex multigraph G given by the following figure.

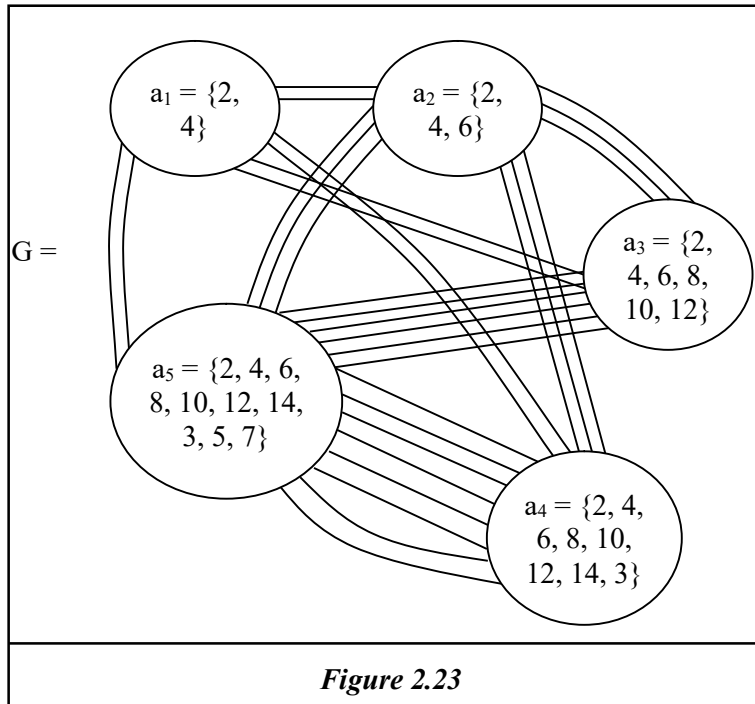

Figure 2.23

Clearly G is a pseudo complete subset vertex multigraph. We now find the universal complements G^C of G .

The vertex subset of G^C is as follows.

$$u_1 = S \setminus a_1 = \{1, 3, 5, 7, 8, 9, 10, 11, 12 - 16, 6\},$$

$$u_2 = S \setminus a_2 = \{1, 3, 5, 7, 8, 9, 10, 11, 12 - 16\}$$

$$u_3 = S \setminus a_3 = \{1, 3, 5, 7, 9, 11, 13 - 16\},$$

$$u_4 = S \setminus a_4 = \{1, 5, 7, 16, 9, 11, 13, 15\},$$

$u_5 = S \setminus a_5 = \{1, 9, 11, 13, 15, 16\}$ and is such that $u_5 \subseteq u_4 \subseteq u_3 \subseteq u_2 \subseteq u_1$. The subset vertex multigraph with vertex set u_1, u_2, \dots, u_5 is as follows.

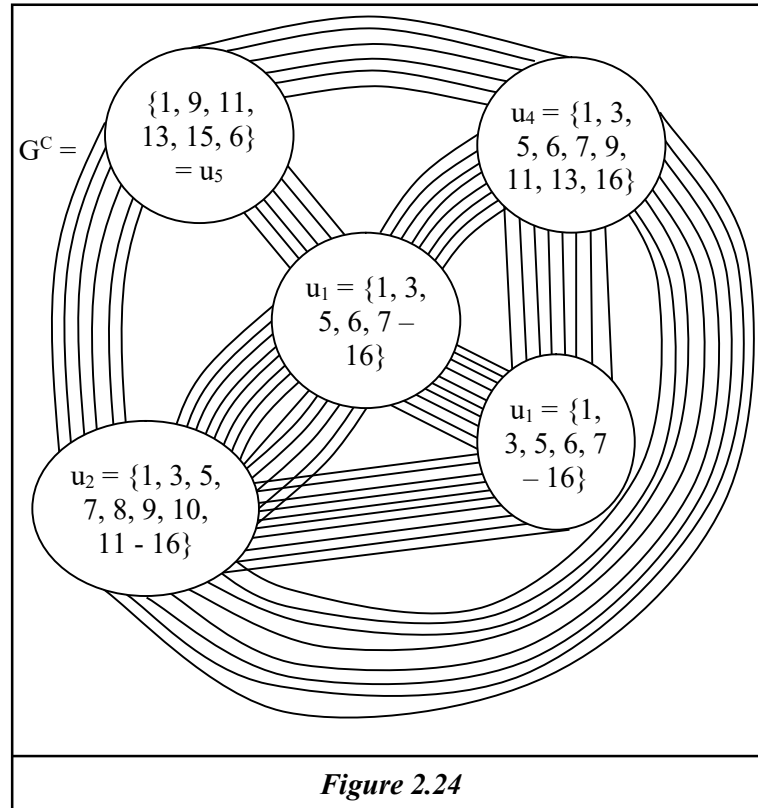

Figure 2.24

Clearly G^c is again a pseudo complete subset vertex multigraph but both G and G^c have different structures.

In view of all these we have the following result.

Theorem 2.7. Let $P(S)$ be the powerset of S . Let T be a chain of subsets of $P(S)$ given by $a_1 \subseteq a_2 \subseteq \dots \subseteq a_n$ where $a_i \in P(S)$; $1 \leq i \leq n$.

If $|a_i|$ is very arbitrary then the subset vertex multigraph G is pseudo complete such that its universal complement G^C and G do not in general enjoy the same structure.

Proof is left as an exercise to the reader.

We give a few examples for the reader.

Example 2.8. Let $S = \{1, 0, 2, 4, 7, 8, 6, 9, 10, 11, 15, 16, 18, 5\}$ be the finite set. $P(S)$ be the power set of S . Let G be the vertex subset multigraph given by the following figure.

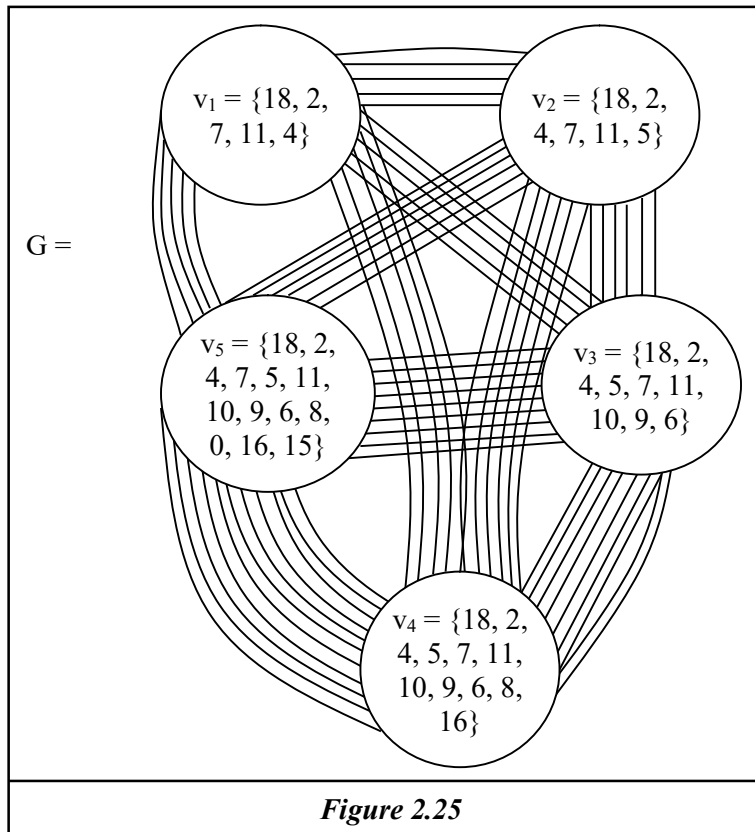

The universal complement G^C of G is as follows

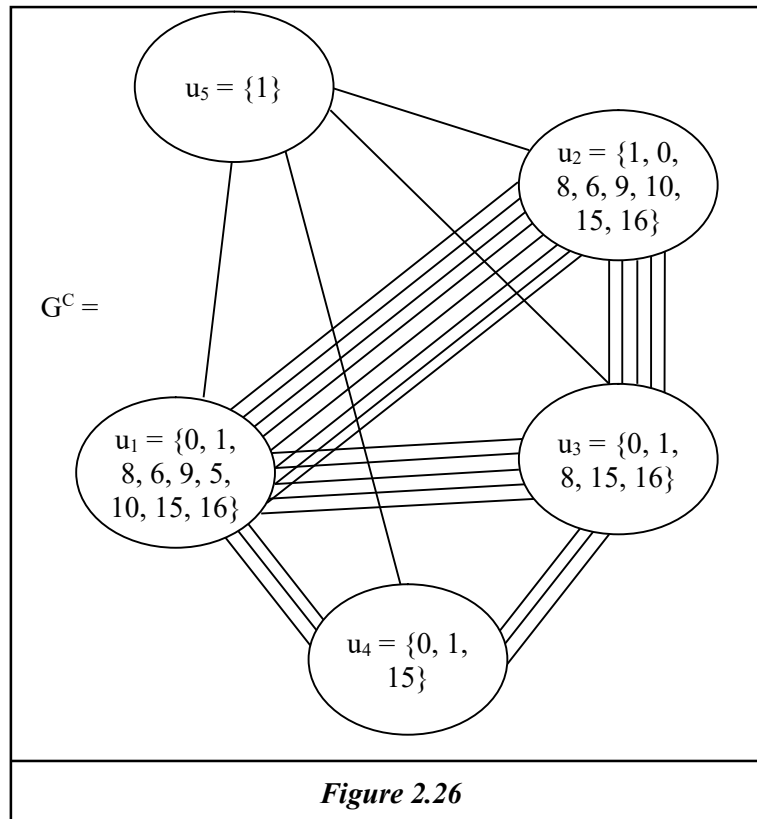

We see both G and G^C are pseudo complete subset vertex multigraphs but they are structurally different.

Now we analyse the vertex subsets which forms the chain both in case of G and G^C .

The vertex subset chain of G .

$v_1 = \{18, 2, 7, 11, 4\} \subseteq v_2 = \{2, 4, 7, 11, 18, 5\} \subseteq v_3 = \{18, 2, 4, 5, 7, 11, 10, 9, 6\} \subseteq v_4 = \{2, 4, 5, 7, 11, 18, 10, 9, 6, 16\} \subseteq v_5 = \{2, 4, 5, 11, 10, 9, 6, 8, 0, 16, 15, 18, 7\}$; we see $|v_1| = 5$, $|v_2| = 6$,

$|v_3| = 9$, $|v_4| = 10$ and $|v_5| = 13$. Clearly the difference $|v_2 - v_1| = 1$, $|v_3 - v_2| = 3$, $|v_4 - v_3| = 1$ and $|v_5 - v_4| = 3$.

Now the pseudo complete subset vertex multigraph's universal complement has the associated chain follows.

$$u_5 = \{1\} \subseteq u_4 = \{0, 1, 15\} \subseteq u_3 = \{0, 1, 8, 15, 16\} \subseteq u_2 = \{1, 0, 8, 6, 9, 10, 15, 16\} \subseteq u_1 = \{1, 0, 8, 6, 9, 5, 10, 15, 16\}$$

$|u_5 - u_4| = 2$, $|u_4 - u_3| = 2$, $|u_3 - u_2| = 3$, $|u_2 - u_1| = 1$.

This obviously gives different number of multiedges between any two nodes.

Thus if the chain has different orders for vertex subsets not uniformly increasing (constant increase) then the structure of the subset vertex multigraphs and its universal complement would be different.

Interested reader can work in this direction. Every chain produces a pseudo complete subset vertex multigraph.

It is left as a open problem for the readers to find the following.

Problem 2.1. Let S be a set of order n and $P(S)$ the powerset of S .

- i) Find all maximal chains in $P(S)$.
- ii) Prove there exists subset vertex multigraph which is complete and the vertex subsets do not form a chain? Justify.

- iii) Find all maximal chain of the Boolean algebra formed by $P(S)$ which results in subset vertex multigraphs G so that G and G^c enjoy the same structure.

Now we proceed onto describe the subset vertex multigraphs which are trees by some examples.

Example 2.9. Let $S = Z_{27}$ and $P(S)$ the powerset of S .

The subset vertex multigraph G which is a tree is as follows.

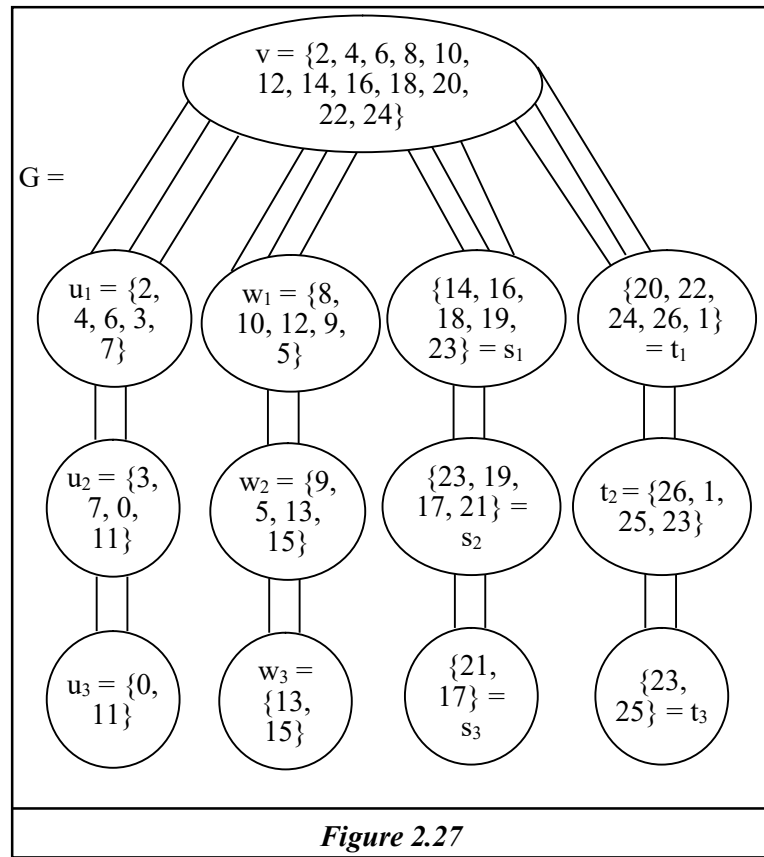

We find the universal complement of G in the following.

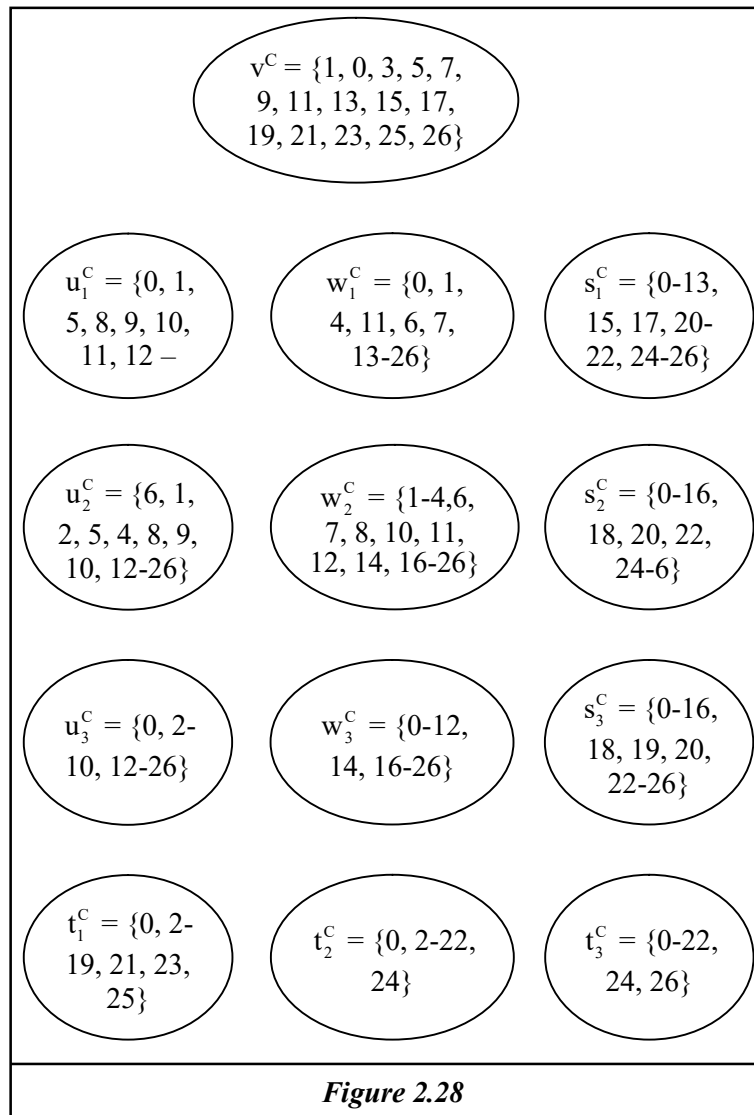

From the vertex subsets we see G^c of G is a pseudo complete multigraph. Thus the multitree's complement is a pseudo complete multigraph.

Study in this direction is interesting.

Example 2.10. Let $S = \{1, 2, \dots, 12\}$ be a set and $P(S)$ the powerset of S .

Let G be the subset vertex multiset given by the following figure.

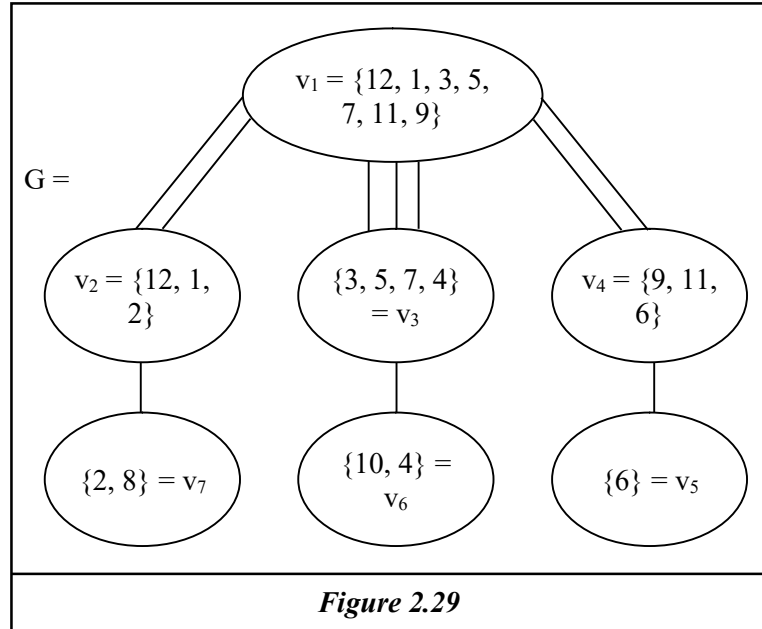

Now we give the universal complement G^c of G in the following.

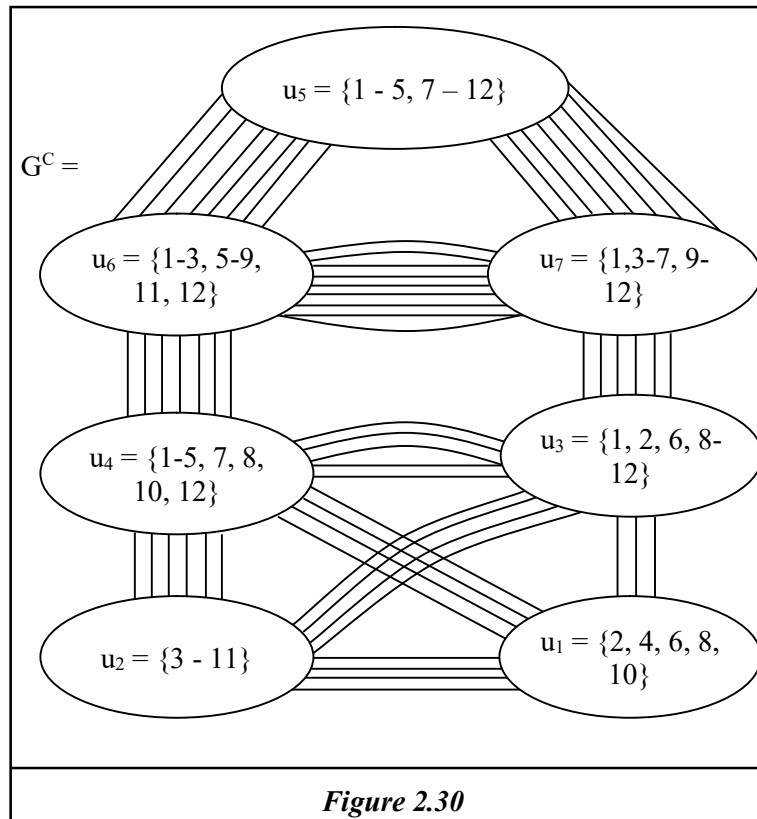

The task of completing the pseudo complete subset vertex multigraph G^C is left as an exercise to the reader.

Now in view of all these we suggest the following problems.

Problem 2.2. Let $P(S)$ be the power set of S . Let G a subset vertex multitree with vertex subset from $P(S)$. Is G^C the universal complement of G a pseudo complete subset vertex multigraph?

Problem 2.3. Is it ever possible for a subset vertex multitree to have its universal complement also to be a subset vertex multitree?

Consider the following example.

Example 2.11. Let $S = \{1, 2, 3, 4, \dots, 9\}$ be a set of order 9.

Let G be a subset vertex multitree given by the following figure.

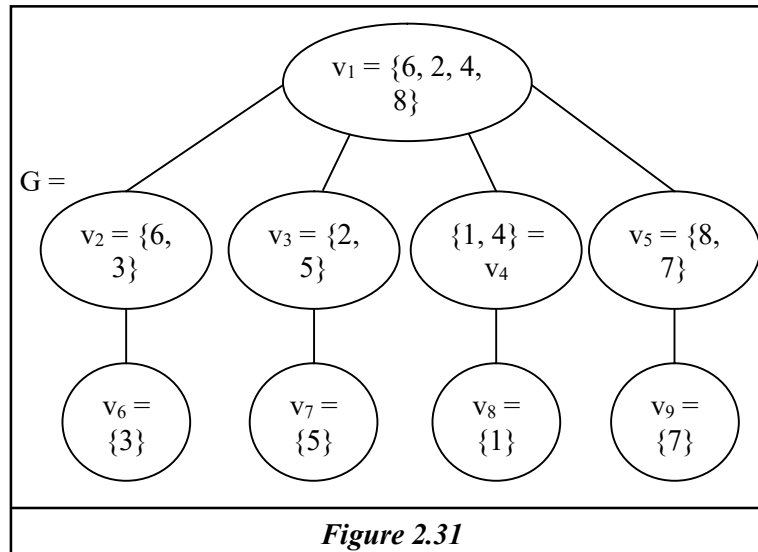

Let $u_i = S \setminus v_i$; $i = 1, \dots, 9$; and G^c be the universal complement of G .

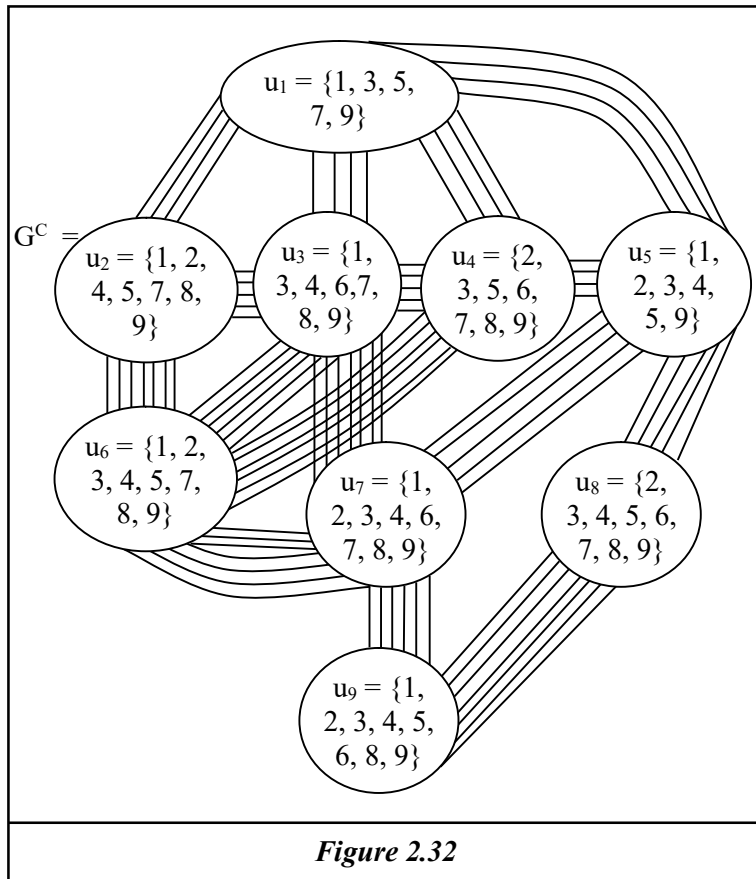

We have not completed the universal complement subset vertex multigraph G^c of G and leave this task for the reader.

However, from the subset vertex we see the multigraph is a pseudo complete subset vertex multigraph.

But G is only a tree which has no multiedges but G^c the universal complement of G is a pseudo complete subset multigraph which has at least 4 edges between any two subset vertices.

Next, we proceed onto discuss about the universal complements of circle or ring subset vertex multigraphs using examples.

Example 2.12. Let $S = \{1, 2, \dots, 12\}$ be a set of order 12 and $P(S)$ the powerset of S . Let G be the subset vertex multigraph which is a circle (ring) given by the following figure.

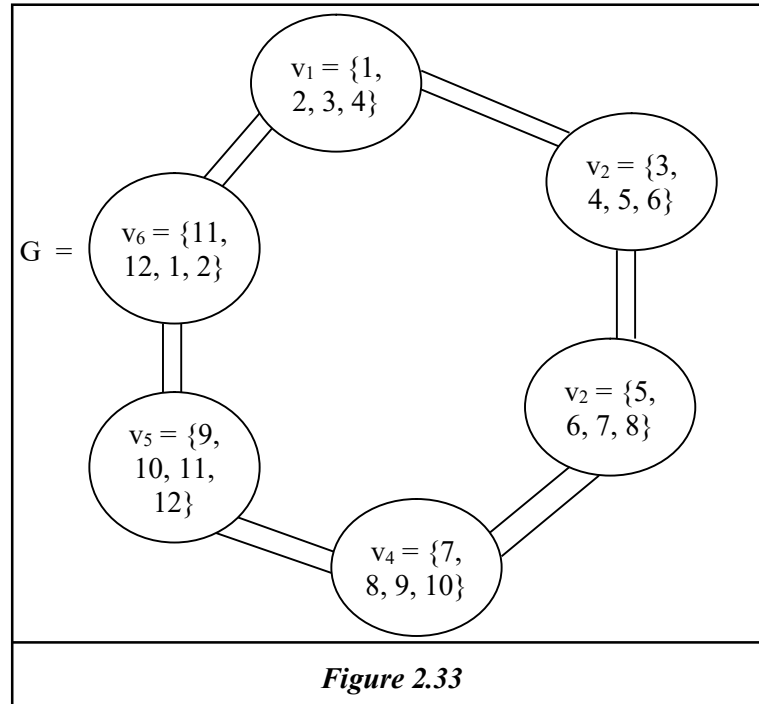
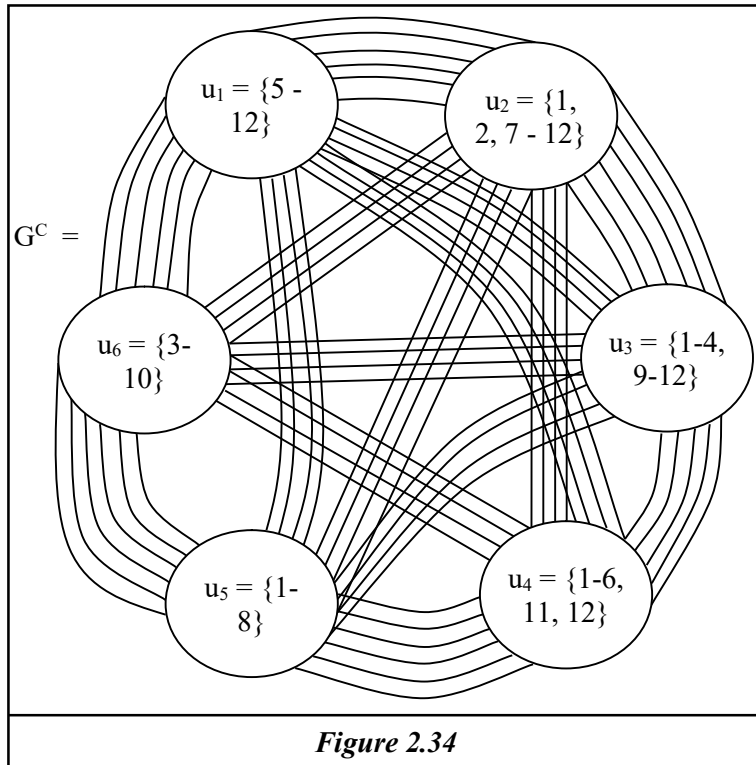

Figure 2.33

Clearly G is a uniform subset vertex multicircle. Now we find the universal complement of G .

Let G^c be the universal complement of G given by the following figure.



Here $u_i = S \setminus v_i; i = 1, 2, \dots, 6$.

Clearly G^c is a pseudo complete subset vertex multigraph.

Example 2.13. Let $S = \{1, 2, \dots, 6\}$ be a set of order 6 and $P(S)$ be the powerset of S .

Let G be a subset vertex multigraph given by the following figure.

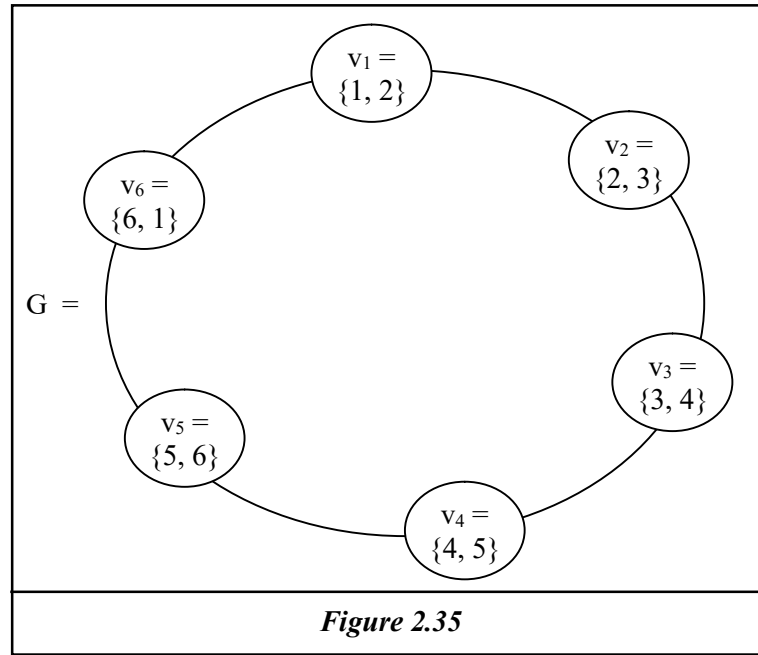

G^c the universal complement of a is as follows

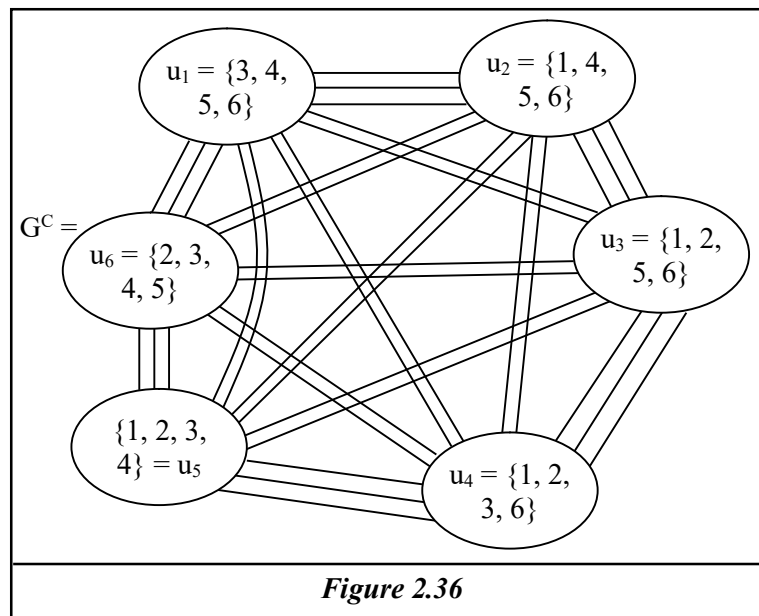

Clearly G^c is a pseudo complete subset vertex multigraph. The outer circle is a uniform subset vertex multigraph.

Now we propose the following problem.

Problem 2.4. Prove or disprove that subset vertex multicircle (ring) G has its universal complement to be a pseudo complete subset vertex multigraph.

Example 2.14. Let $S = \{1, 2, 3, 4, 5, 6, 7, 8, 9\}$ be a set of order nine and $P(S)$ the powerset of S . Let G be the subset vertex multicircle given by the following figure.

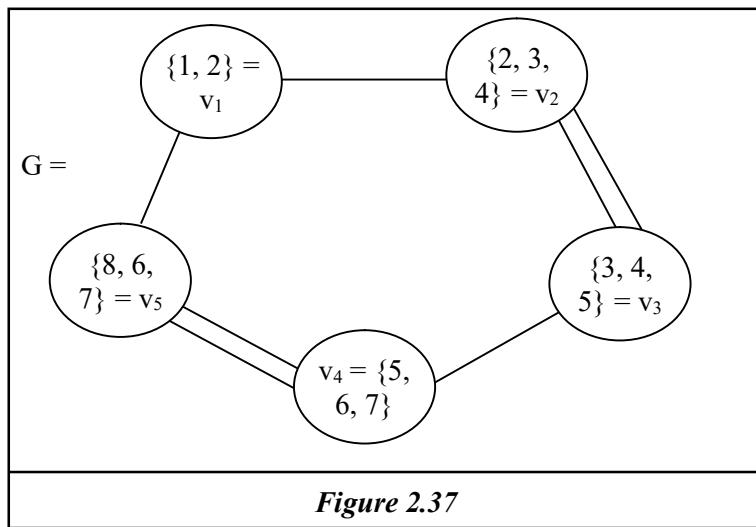

Clearly G is not a uniform subset vertex multicircle.

Let G^c denote the universal complement of G given by the following figure.

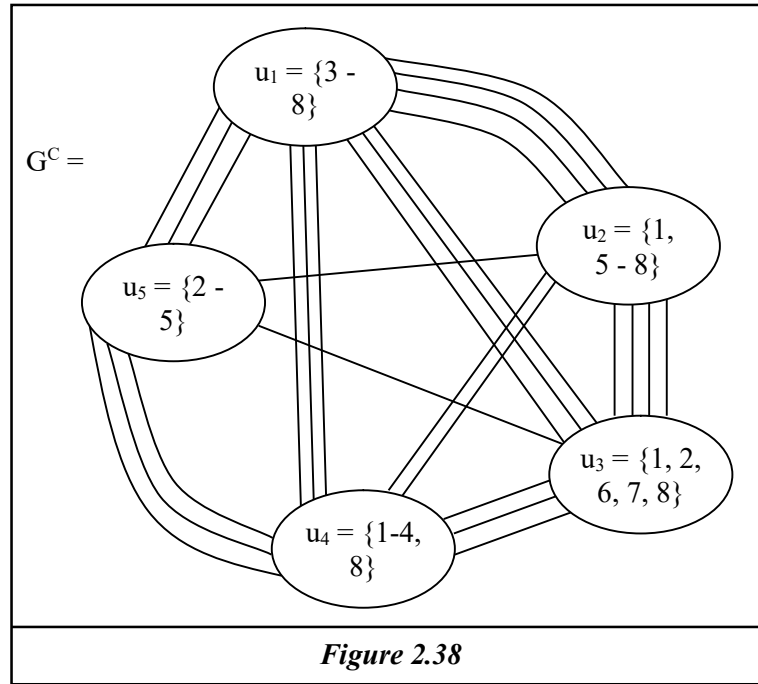

$$u_i = S \setminus v_i; i = 1, 2, 3, 4, 5.$$

We see the subset vertex multicircles (multirings) will have their universal complement to be pseudo complete subset vertex multigraphs.

Now we want to study the universal complements of subset vertex multigraphs which are wheels by some examples.

Example 2.15. Let $S = \{1, 2, \dots, 18\}$ be a set of order 18 and $P(S)$ be the powerset of S . Let G be the subset vertex multiwheel given by the following figure.

Clearly G is a subset vertex multiwheel. We now find the universal complement G^C of G in the following;

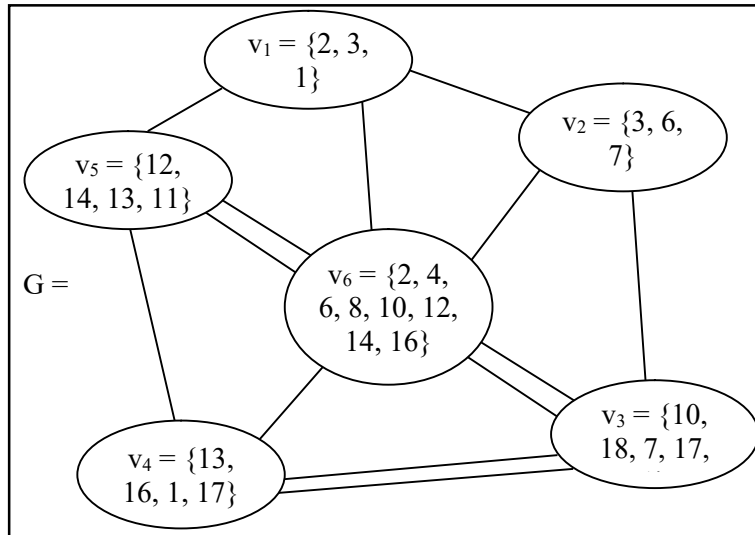

Figure 2.39

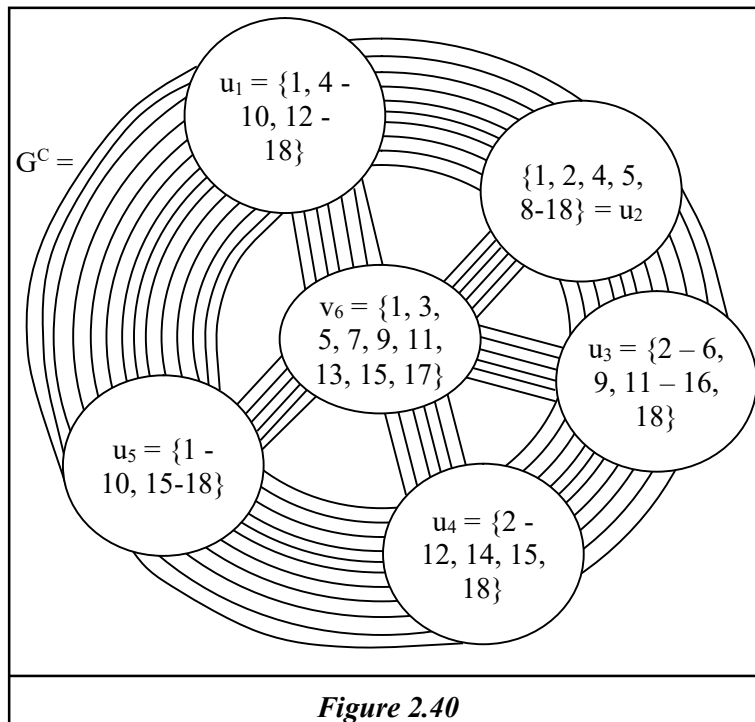

Figure 2.40

Here $u_i = S \setminus u_i$; $i = 1, 2, \dots, 6$. However G^C is a pseudo complete subset vertex multigraph. The reader is left with the task of completing the multigraph diagram.

So the conclusion drawn from this example is that the universal complement of a subset vertex multiwheel is also a pseudo complete subset vertex multigraph.

We provide yet another example of this situation.

Example 2.16. Let $S = \{1, 2, \dots, 12\}$ be a set of order 12. $P(S)$ be the powerset of S . Let G be the subset vertex multiwheel given by the following figure.

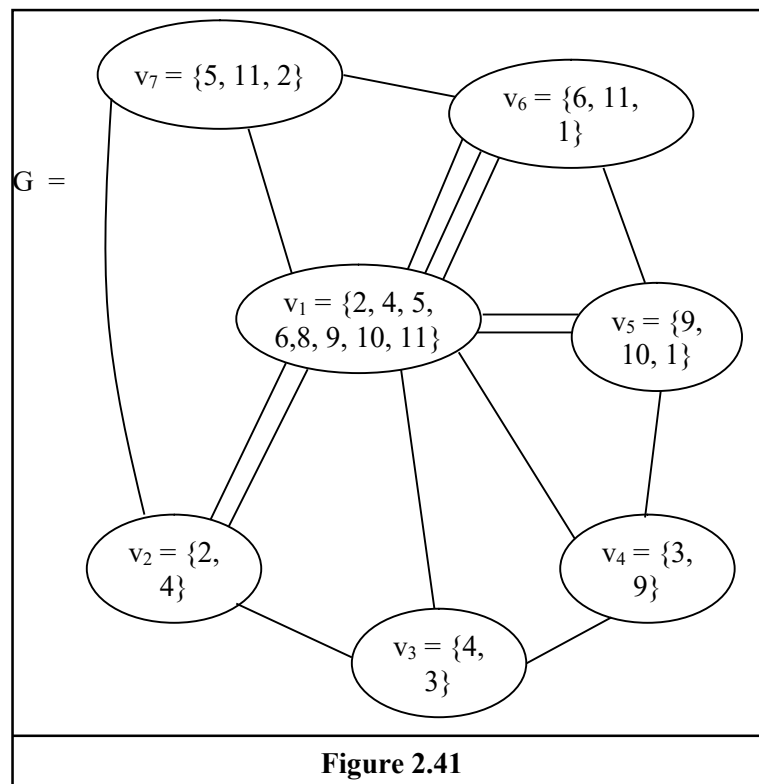
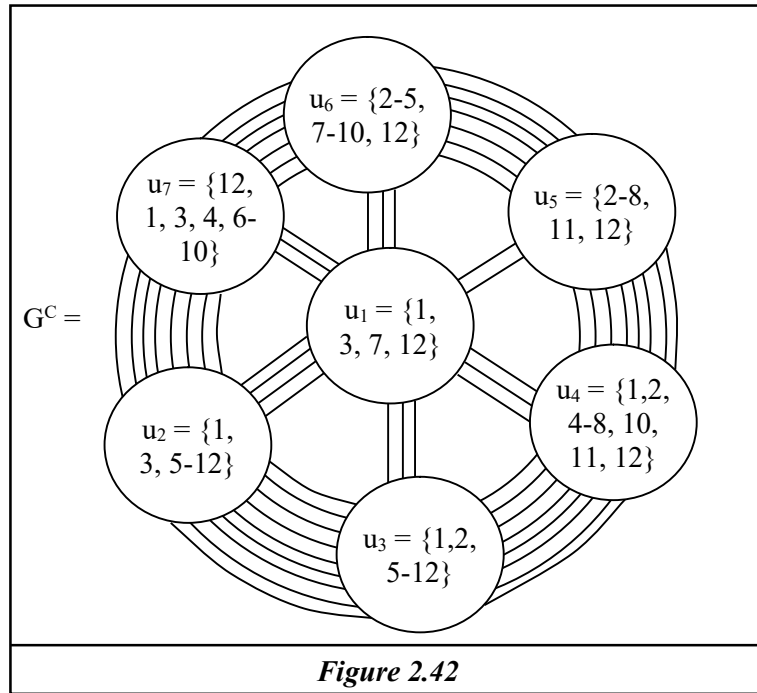

Figure 2.41

We now give the universal complement G^C of G where $u_i \subseteq V$; $i = 1, 2, \dots, 7$ by the following figure.



The reader is left with the task of connecting u_i with u_j $i \neq j$; $2 \leq i, j \leq 7$. It is easily verified that G^C is a pseudo complete subset vertex multigraph.

In view of all these we propose the following problem.

Problem 2.5. Let S be any set of order n . $P(S)$ the powerset of S .

Let G be a subset vertex multiwheel, then prove or disprove the universal complement G^C of G is a pseudo complete subset vertex multigraph.

Next we proceed onto study, the universal complements of pseudo complete subset vertex multigraphs by some examples.

Example 2.17. Let $S = \{1, 2, 3, \dots, 15\}$ be a set of order fifteen. $P(S)$ the powerset of S . Let G be a pseudo complete subset vertex multigraph given by the following figure.

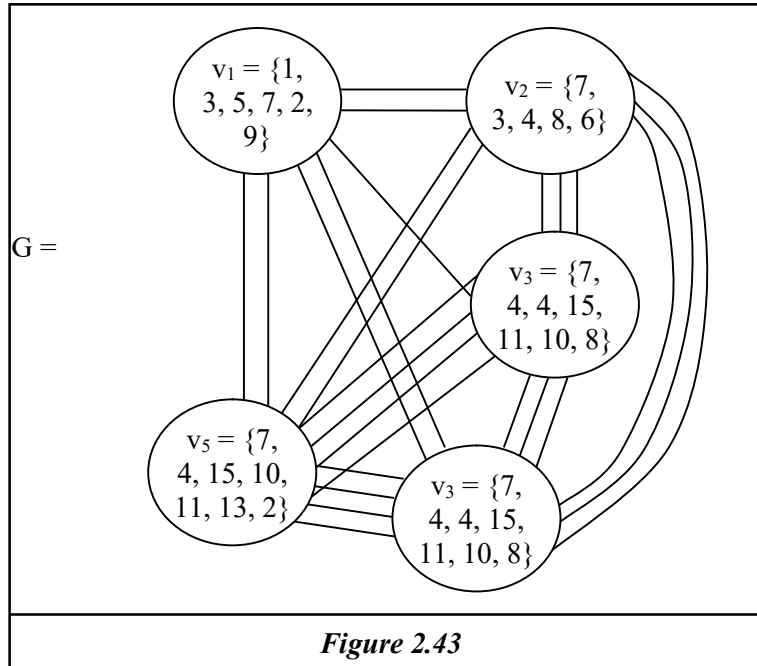

Now we find the universal complement G^C of G . Clearly G is a pseudo complete subset vertex multigraph.

Let $u_i = S \setminus v_i; i = 1, 2, 3, 4, 5$.

The universal complement G^C of G is as follows.

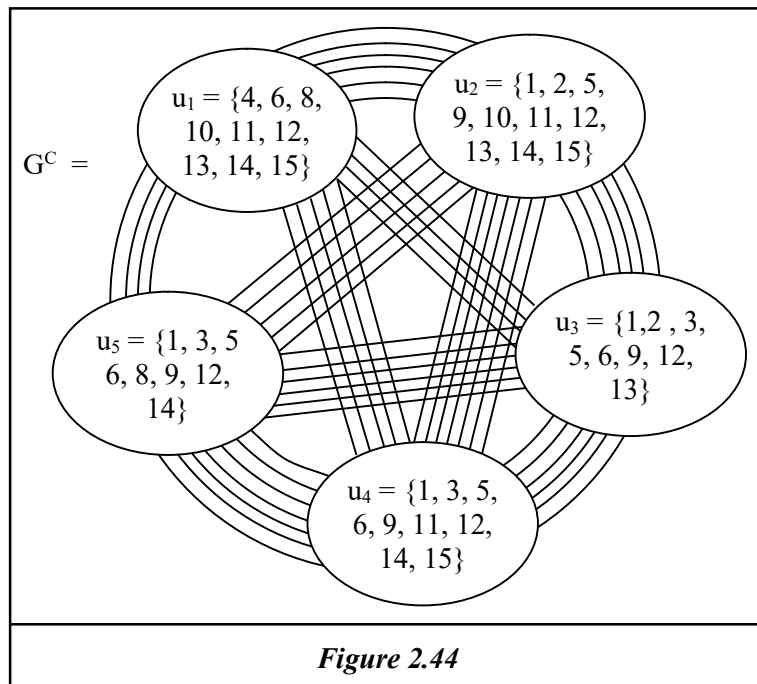

G^C is again a pseudo complete subset vertex multigraph.

However structure is not preserved in this case.

Example 2.18. Let $P(S)$ be the powerset of $S = \{1, 2, 3, 4, \dots, 9\}$.

Let G be the pseudo complete subset vertex multigraph given by the following figure.

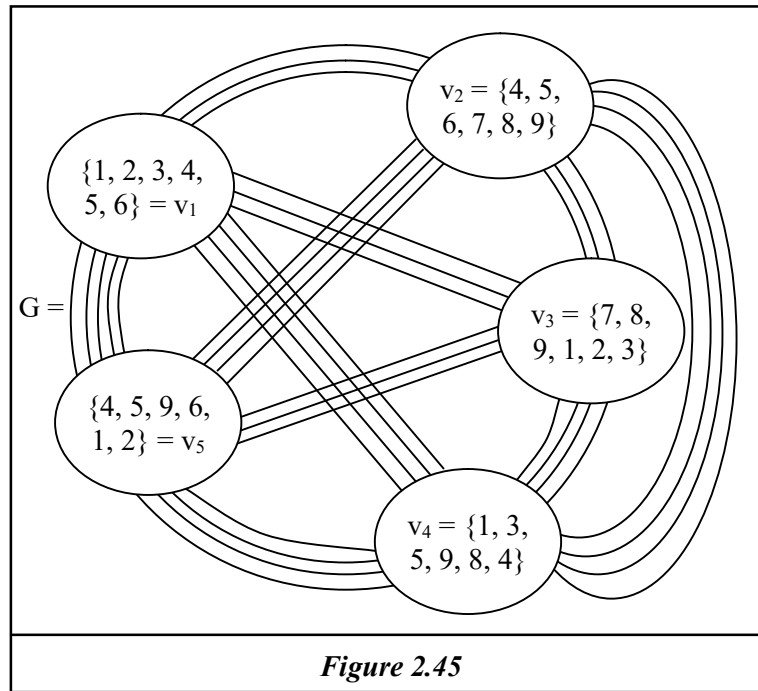

The universal complement G^c of G is as follows where $u_i = S \setminus v_i; i = 1, 2, 3, 4, 5$.

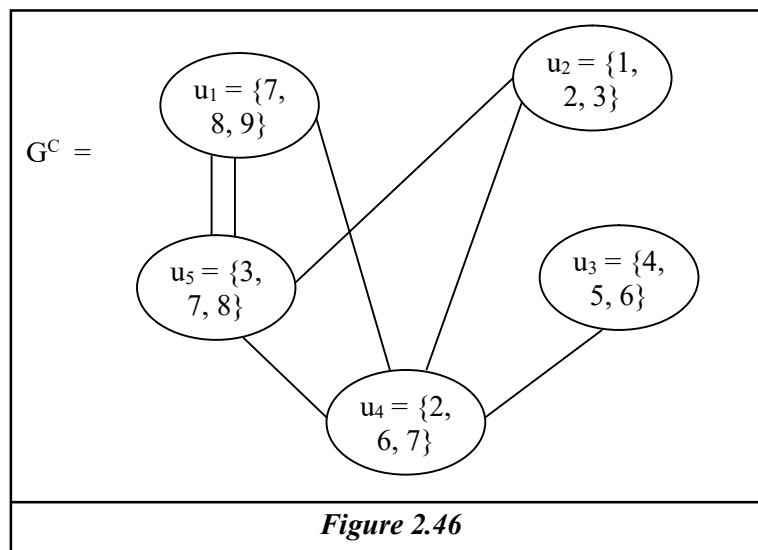

Clearly G^C the universal complement of G is not pseudo complete hence structure is not preserved.

In view of this example we have the following result.

Theorem 2.8. *Let $P(S)$ be the powerset of S . G be a pseudo complete subset vertex multigraph with vertex set from $P(S)$. The universal complement G^C of G in general is not a pseudo complete subset vertex multigraph, that is structure in general is not preserved.*

Proof follows from the above example.

We provide yet another example of pseudo complete subset vertex multigraphs and their universal complement in the following.

Example 2.19. Let $S = \{1, 2, 3, \dots, 16\}$ be the set of order 16 and $P(S)$ the powerset of S . Let G be a pseudo complete subset vertex multigraph given by the following figure.

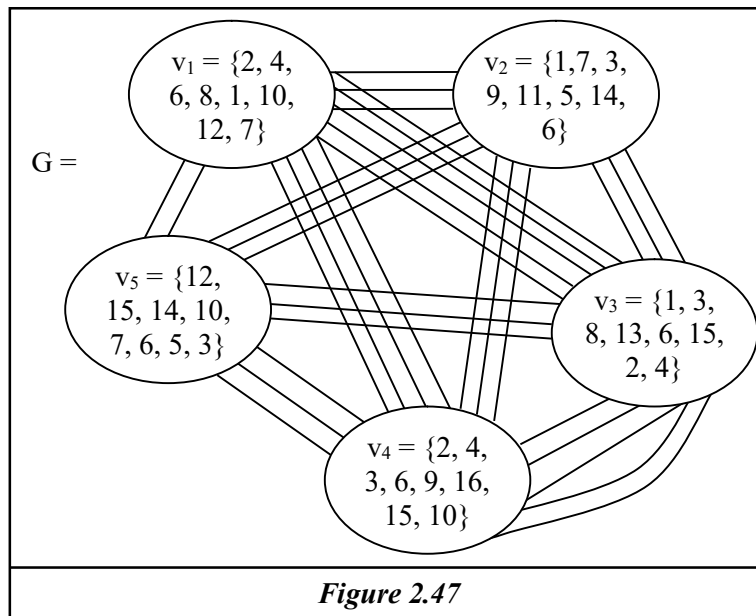

Let $u_i = S \setminus v_i; i = 1, 2, \dots, 5$. The universal complement G^c of G has vertex subsets u_1, u_2, \dots, u_5 given by the following figure.

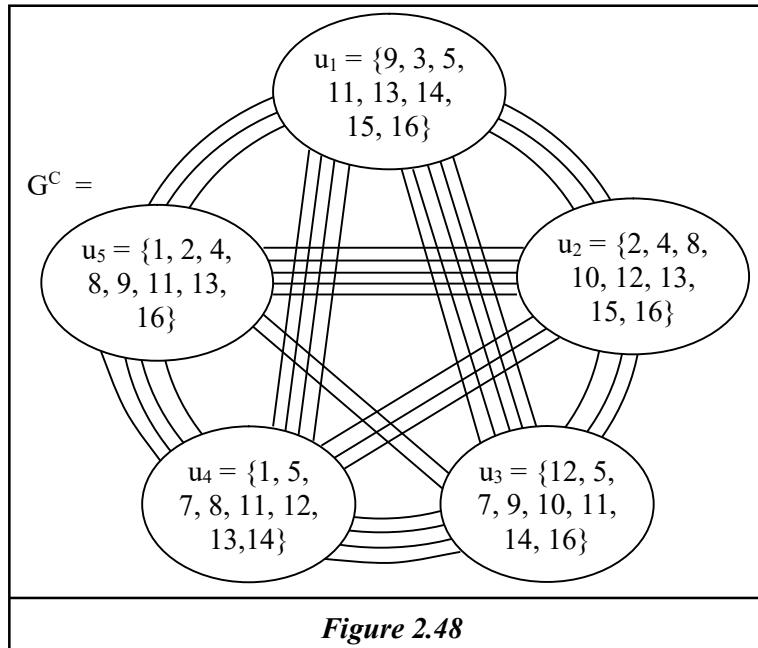

Clearly though structure is not preserved by G^c , but G^c is also a subset vertex multigraph which is pseudo complete.

Thus from these two examples we see the universal complement may or may not be again a pseudo complete subset vertex multigraph.

We provide some more examples of subset vertex multiraphs and their universal complements.

Example 2.20. Let $S = \{1, 2, \dots, 12\}$ be a set of order 12. $P(S)$ the power set of S . Let G be the subset vertex multigraph with

vertex subsets v_1, v_2, \dots, v_7 from $P(S)$ given by the following figure.

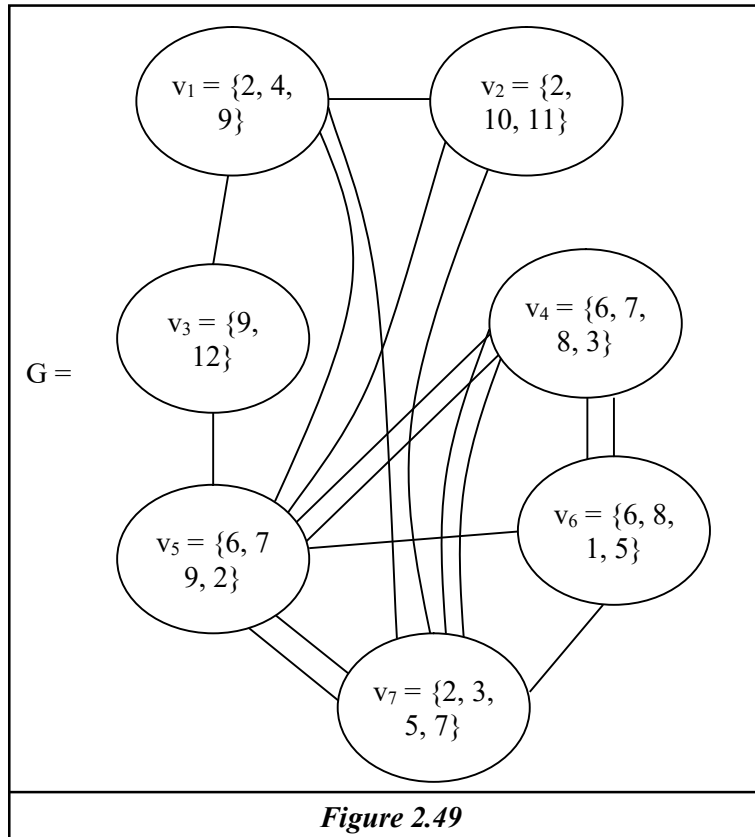

Clearly G is not pseudo complete subset vertex multigraph.

Now we give in the following figure the universal complement of G .

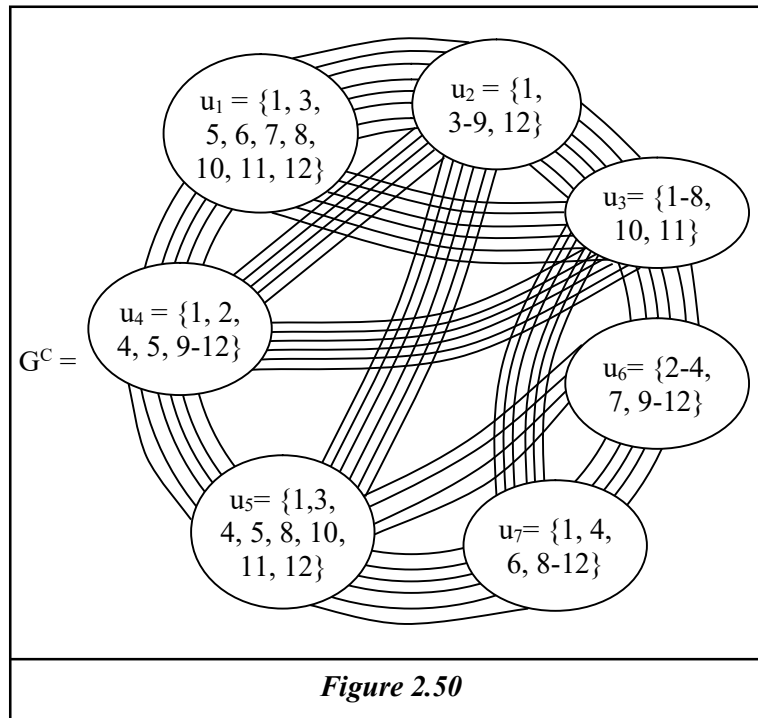

Here $u_i = S \setminus v_i; i = 1, 2, \dots, 7.$

It is easily verified by the reader after completing G^c the universal complement of G the resulting graph is pseudo complete subset vertex multigraph.

Thus non pseudo complete subset vertex multigraph G can yield pseudo complete subset vertex multigraph as universal complement of G .

Characterize such graphs using the subset vertices happens to be a challenging open problem in the theory of subset vertex multigraphs.

Now we propose yet another problem.

Problem 2.6. Let G be a subset vertex multigraph with vertex subsets from $P(S)$. If G is a complete subset vertex multigraph when will G^c the universal complement of G be a complete or a pseudo complete subset vertex multigraph?

Example 2.21. Let $S = \{1, 2, \dots, 9\}$, $P(S)$ the powerset of S . Let G be the subset vertex multigraph given by the following figure which is clearly a disconnected subset vertex multigraph.

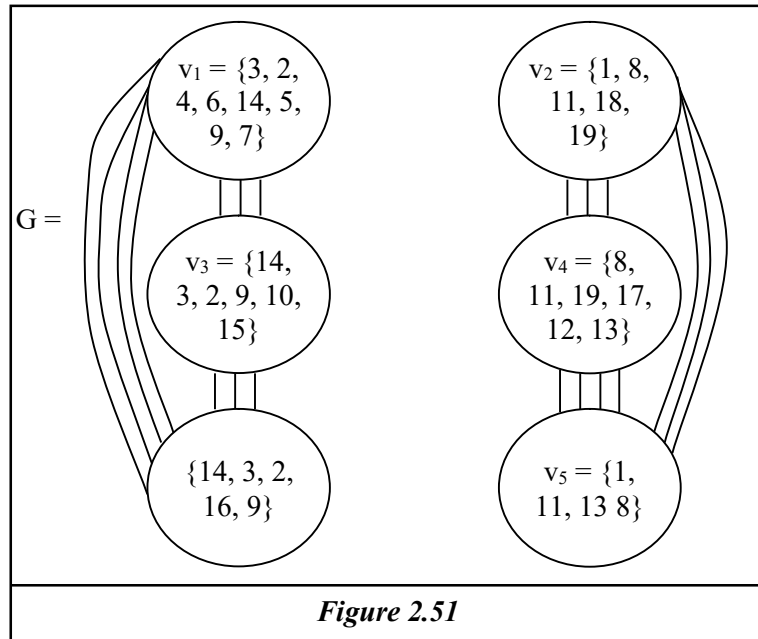

Figure 2.51

Clearly G is disconnected it has two triad components.

Now we find out whether the universal complements are connected or disconnected.

The figure of G^c of G given below here $u_i = S \setminus v_i$; $i = 1$ to 6.

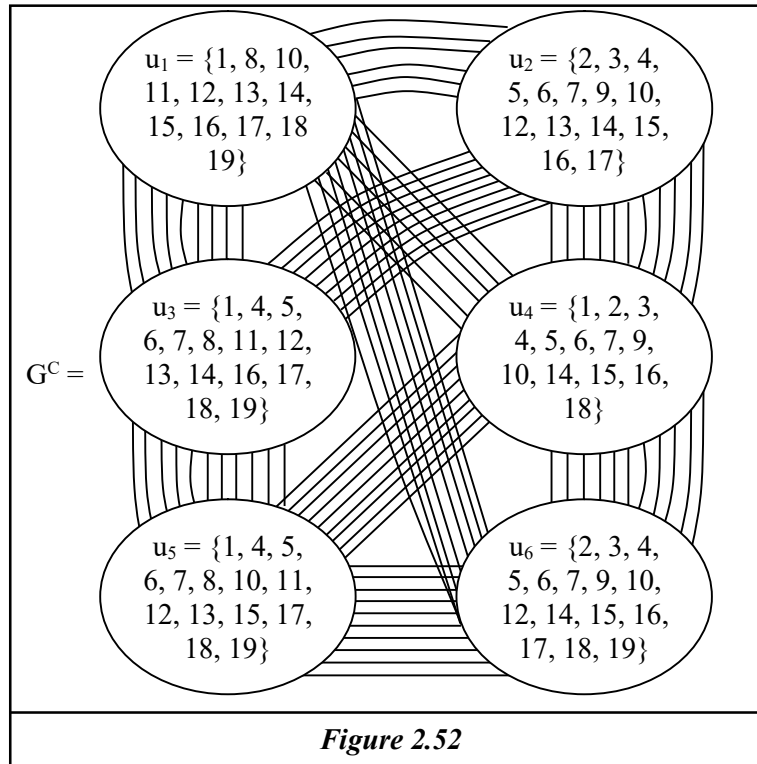

Figure 2.52

The reader is left with the task of completing the complement G of the multigraph G and prove G^c is a pseudo complete subset vertex multigraph though G is a disconnected subset vertex multigraph.

Our next study is to test whether we can have disconnecte subset vertex multigraphs whose universal complements are also disconnected. To this effect we try to find some examples.

We give a few examples of this situation in the following.

Example 2.22. Let $S = \{1, 2, 3, 4, \dots, 10\}$ be a set of order 10 and $P(S)$ the powerset of S .

Let G be the subset vertex multigraph which is disconnected is given below.

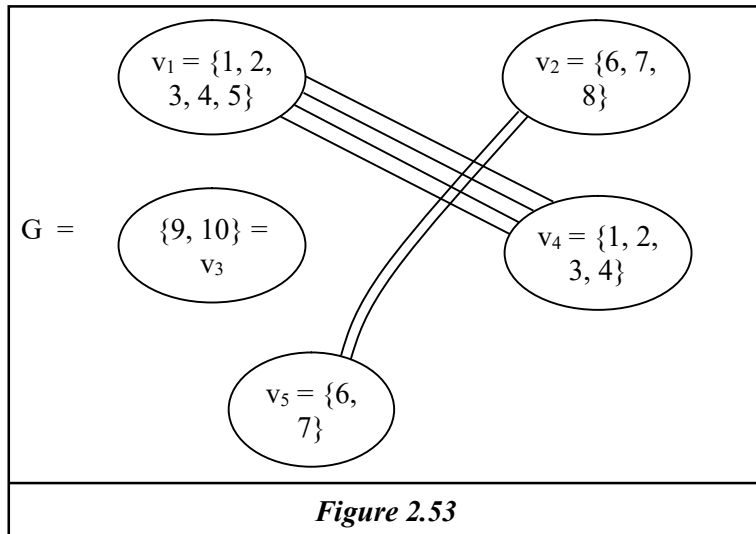

Clearly G is a disconnected subset vertex multigraph.

Let G^c be the universal complement of G given by the following figure.

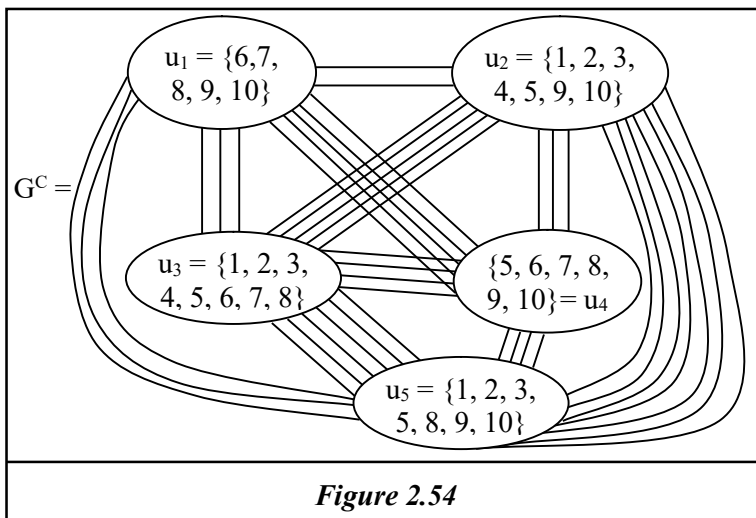

Let $u_i = S \setminus v_i; i = 1, 2, 3, 4.$

Let G^C be the universal complement of G which is given by the following figure.

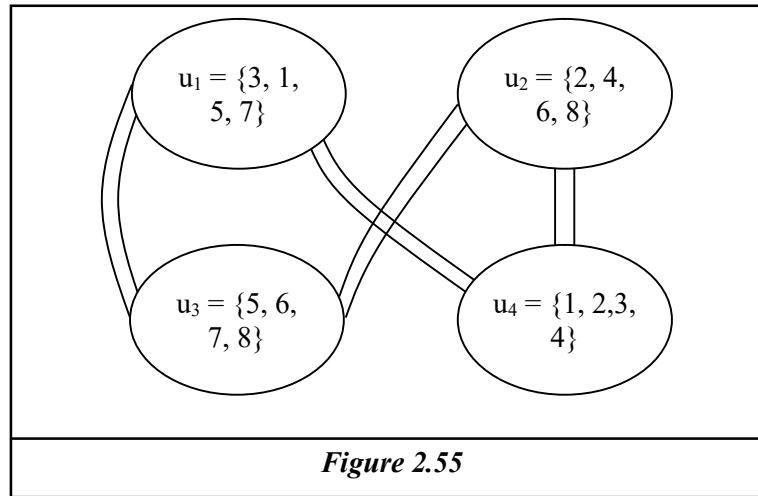

We see G^C is the same as G that is they are identical so $G^C = G$. We call such subset vertex multigraph as full subset vertex multigraphs as $G = G^C$ each of the vertex subset in G and G^C are the same except for the labeling.

Example 2.23. Let $S = \{1, 2, 3, 4, 5, 6, 7, 8, 9\}$ be a set of order 9. $P(S)$ the powerset of S . Let G be a subset vertex multigraph given by the following figure.

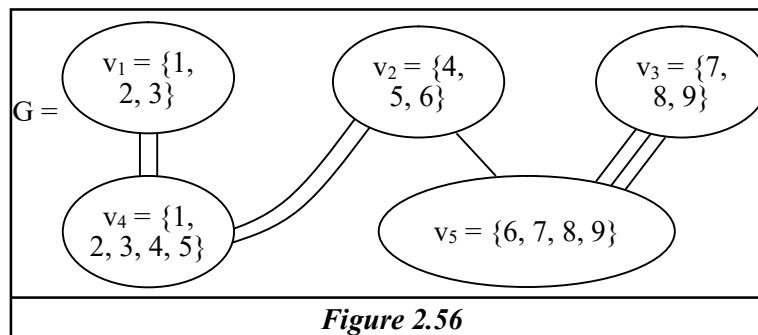

Let the universal complement G^c of G be given by the following figure.

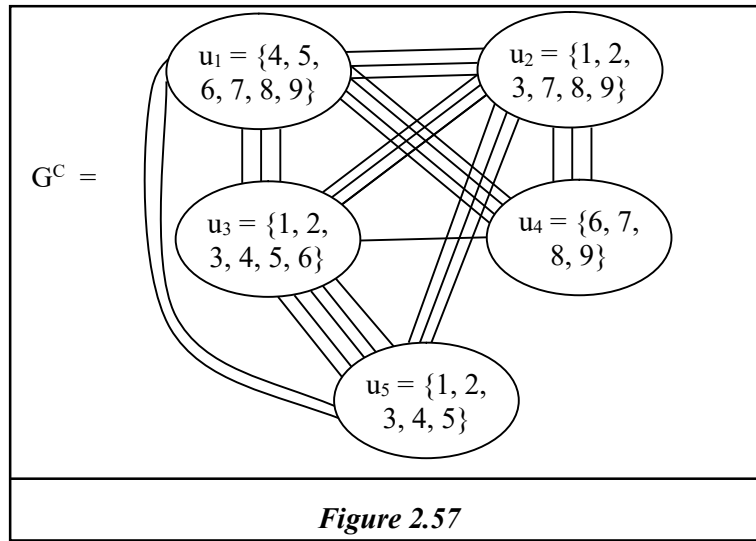

Clearly G^c is not a pseudo complete subset vertex multigraph.

Clearly G and G^c enjoy different structures.

We give get another example.

Example 2.24. Let $S = \{1, 2, \dots, 10\}$ be a set of order 10. $P(S)$ be the powerset of S . Let G be a subset vertex multigraph given by the following figure.

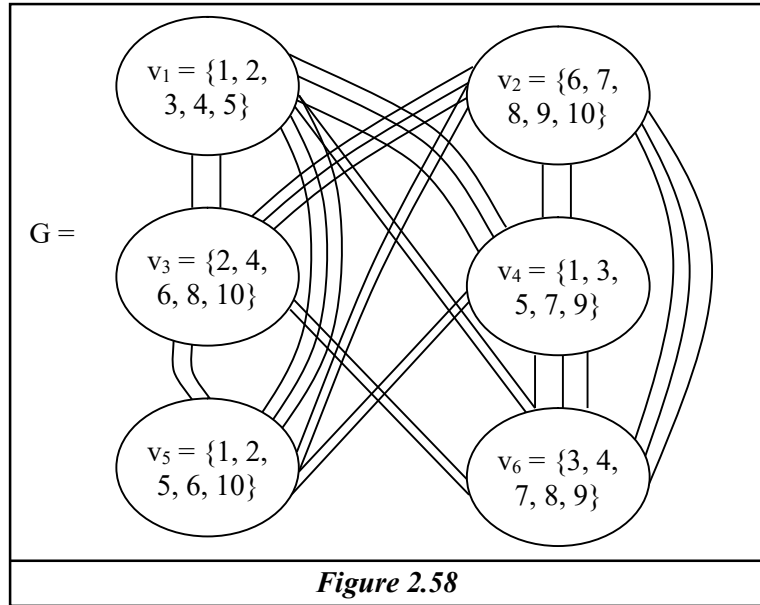

The universal complement G^c of G is given in the following figure, $u_i = S \setminus v_i; i = 1, 2, \dots, 6$.

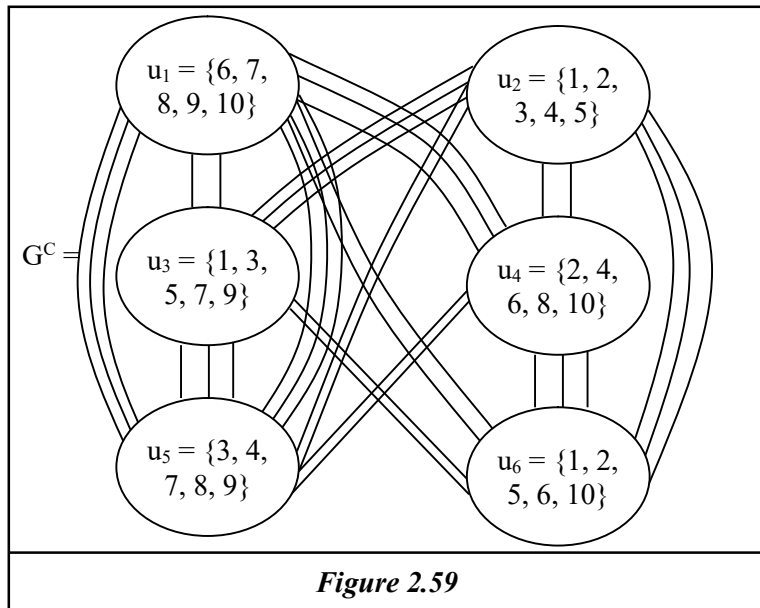

We see the subset vertex multigraph G^C of G is identical with G .

We say two graphs G and H are identical if they have same set of vertices and same set of edges.

In view of this we have the following.

Theorem 2.9. *Let $P(S)$ be the powerset of a set S . G be a subset vertex multigraph with vertex sets $V = \{v_1, \dots, v_{2n}\}$ such that for every v_i there is a unique v_j in V such that $v_i \cap v_j = \phi$ and $v_i \cup v_j = S$; $i \neq j$; $1 \leq i, j \leq 2n$. ($2 \leq n$).*

Then the G^C the universal complement of G and G are identical; that is $G = G^C$.

Proof. Follows from the fact that as each $v_i \in V$ has its complement v_j to be in V the vertex subsets of G and G^C are the same.

Further by the definition of these subset vertex multigraphs the edges are unique once the vertex subsets of the multigraph G is given. Hence the claim.

Example 2.25. Let $S = \{1, 2, 3, 4, 5, 6\}$ be a set of order six and $P(S)$ be the powerset of S . Let G be the subset vertex multigraph with 8 vertices given by the following figure.

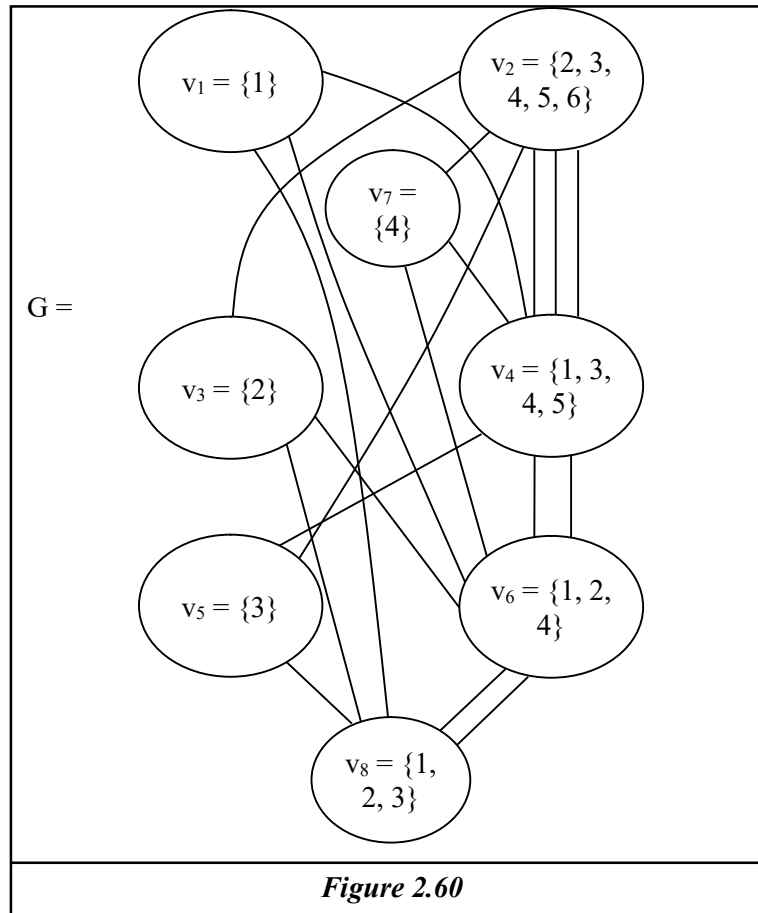

It is left as an exercise for the reader to prove $G = G^C$ that is the universal complement G^C of G is G . We call such multigraphs as self complemented vertex subset multigraphs.

It is interesting to find the largest such subset vertex multigraph G such that $G = G^C$.

Example 2.26. Let $S = \{1, 2, 3\}$ and $P(S)$ the powerset of S .

Let $V = \{\{1\}, \{2, 3\}, \{2\}, \{3, 1\}, \{3\}, \{1, 2\}, \{\phi\}, \{1, 2, 3\}\}$ be the subset vertex of G given by the following figure.

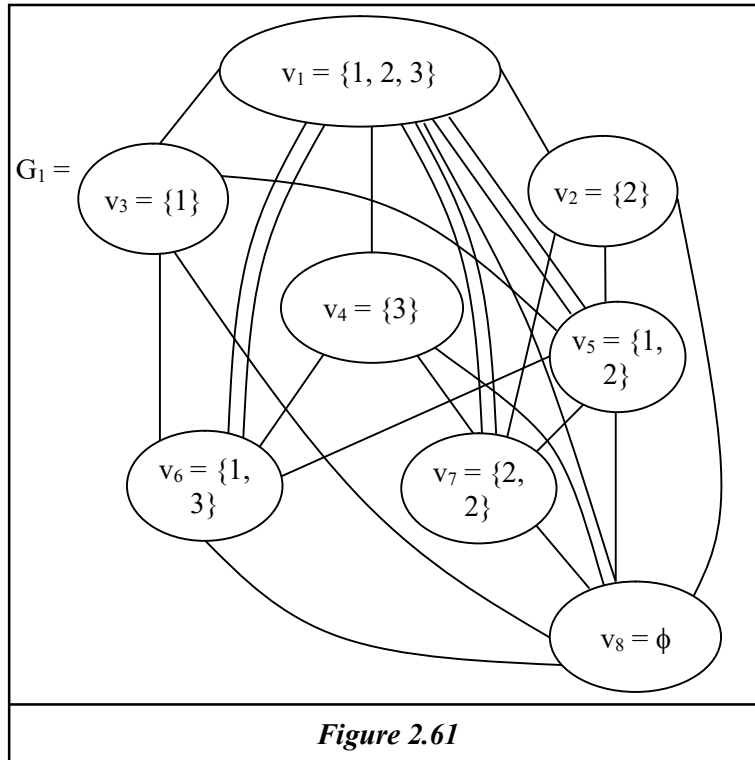

$G_1 = G_1^c$ so G_1 is a subset vertex self complemented multigraph.

In fact G_1 is the largest subset vertex self complemented multigraph.

Let G_2 be a subset vertex multigraph given by the following figure.

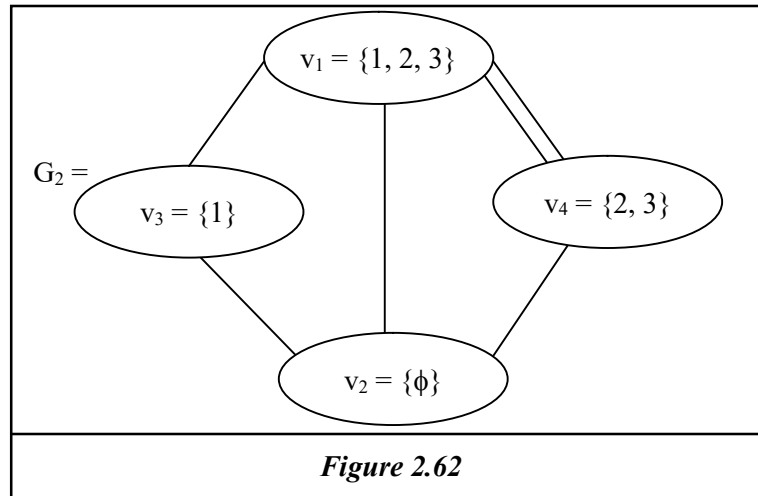

We have 3 self complemented vertex subset multigraphs with 4 vertex subsets.

Consider the subset vertex multigraph given by G_3 .

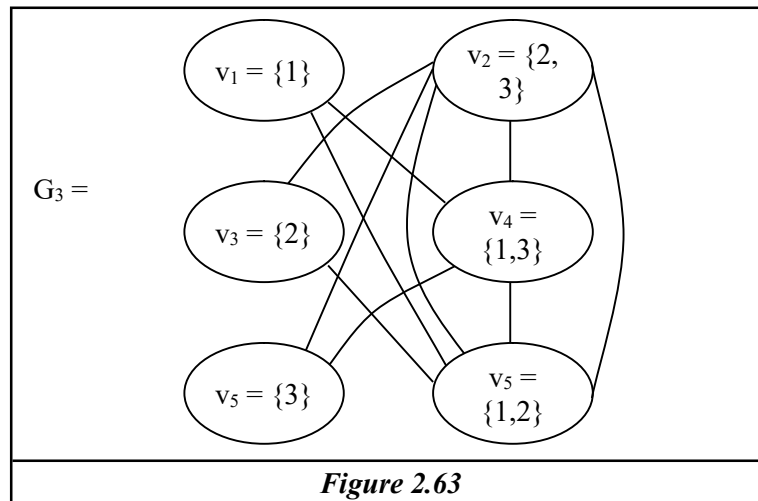

$G_3 = G_3^c$ so G_3 is also a self complemented subset vertex multigraph.

Consider G_4 given by the following figure.

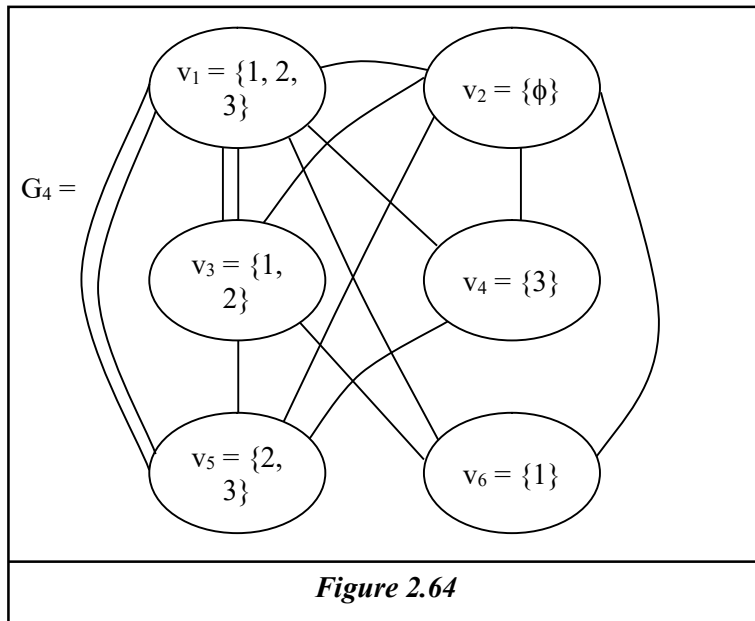

Clearly $G_4 = G_4^c$ so G_4 is also a self complemented subset vertex multigraph. We give some examples of disconnected subset vertex multigraph and their universal complement.

Example 2.27. Let $S = \{1, 2, 3, \dots, 19\}$ be a set $P(S)$ be the power set of S . Let G be the disconnected subset vertex multigraph.

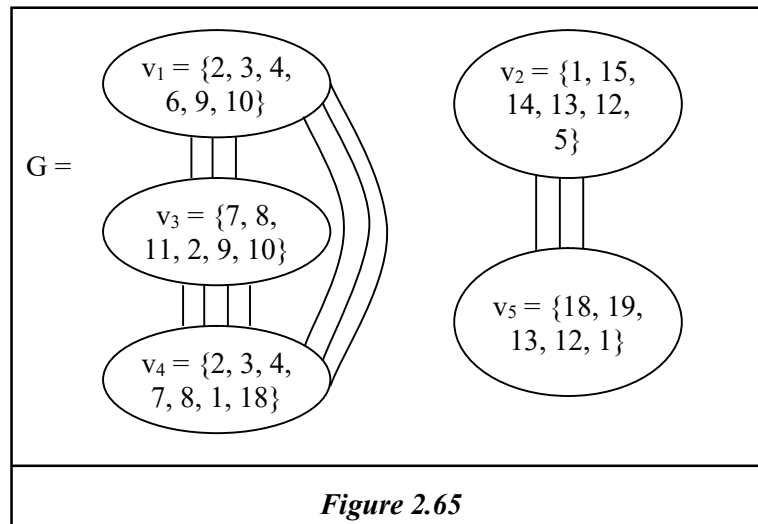

Now we find the universal complement G^c of G and it is given by the following figure; here $u_i = S \setminus v_i$; $i = 1, 2, \dots, 5$.

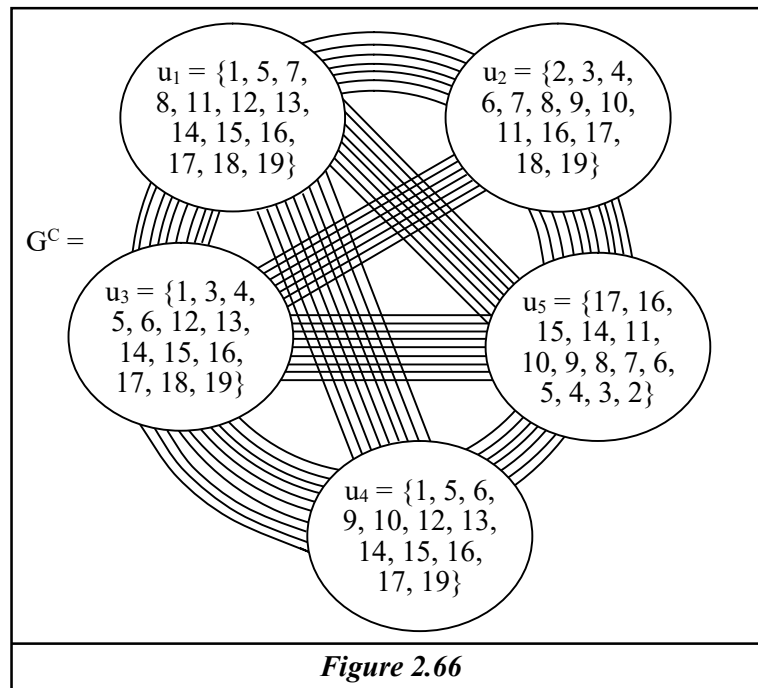

The reader is left with the task of completing the graph G^C and it is easily verified G^C is pseudo complete however G is a disconnected subset vertex multigraph.

Hence there are possibilities in general that a disconnected subset vertex multigraph has its universal complement to be a pseudo complete one and vice versa.

Thus we have the following result.

Theorem 2.10. *Let S be any set. $P(S)$ the powerset of S . Let G be a subset vertex multigraph which is disconnected. The universal complement G^C of G need not in general be disconnected subset vertex multigraph.*

Proof is left as an exercise to the reader. This is evident from the above example.

Now we propose some problems for the reader.

Problems

1. What are the important features enjoyed by special subset vertex multisubgraphs of a subset vertex multigraph?
2. Given $P(S)$ is the powerset of $S = \{1, 2, \dots, 18\}$. Let G be the subset vertex multigraph given by the following figure.

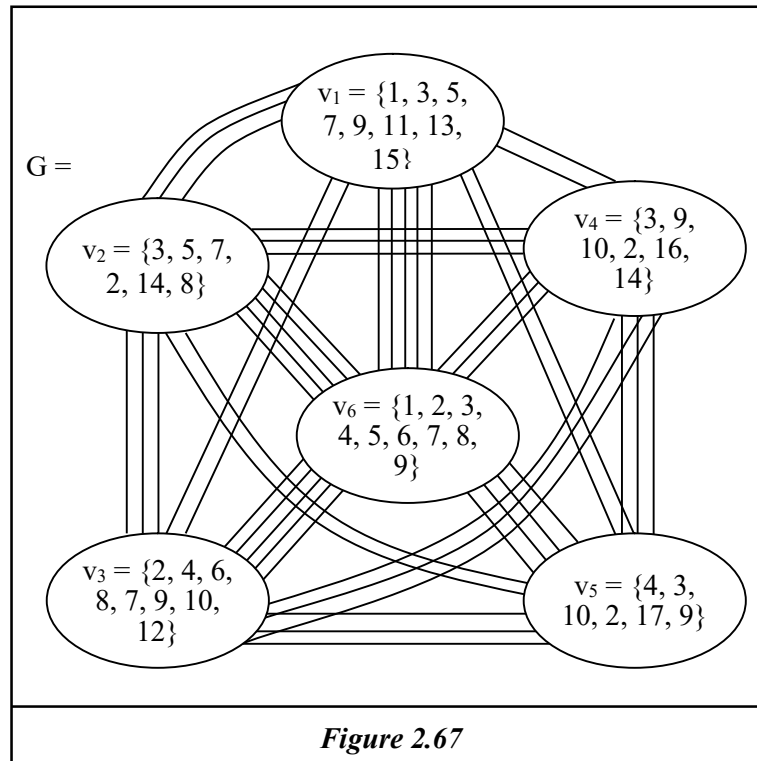

- i) Complete the subset vertex multigraph G .
- ii) Find all special subset vertex multisubgraphs of G .
- iii) Find the universal complement of G .
- iv) Is the universal complement of G enjoy the same structure as that of G ?
- v) How many special subset vertex multisubgraphs of G are multihypergraphs?
- vi) Enumerate all special subset vertex multisubgraphs of G which do not have local complements.

- vii) Can this G have special subset vertex multisubgraph which is a tree?
- viii) Find all special subset vertex multisubgraphs of G which are empty.
- ix) Find the local complements of these empty multisubgraphs.
 - a) Are they defined?
 - b) Can they be also empty multigraphs? Justify your claim.

3. Let $S = Z_{40}$ be a set and $P(S)$ the powerset of S . Let H be a subset vertex multigraph with vertex subset $v_1, v_2, v_3, \dots, v_6$ where $v_1 = \{2, 4, 6, 8, 10, 12, 14, 18\}$, $v_2 = \{3, 6, 9, 12, 15, 18, 21, 24, 27\}$, $v_3 = \{2, 4, 6, 27, 15\}$, $v_4 = \{2, 27, 15, 11, 7, 13, 19, 23\}$, $v_5 = \{2, 15, 29, 31, 33, 38\}$ and $v_6 = \{38, 7, 9, 10, 39\}$ given by the following figure.

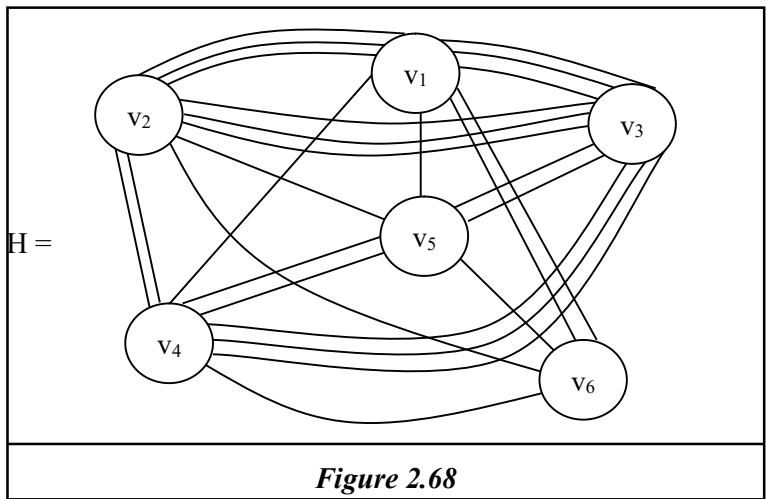

Figure 2.68

Study question (i) to (ix) of problem 2 for this H .

4. Obtain a necessary condition for a special subset vertex multisubgraph of G to contain local complements.
5. Can there be subset vertex multigraphs G whose subset vertex multisubgraphs and their local complements have same structure?
6. Let $S = \{1, 2, \dots, 18\}$ be a set of order 18. $P(S)$ be the powerset of S .
 - a) Prove the largest subset vertex multigraph which is self complemented has $|P(S)|$ vertices that is it has 2^{18} vertices.
 - b) How many self-complemented subset vertex multigraphs can be contributed using this $P(S)$?
 - c) Hence or otherwise give the total number of subset vertex multigraphs which are self complemented using this $P(S)$ from which vertices are taken where $|S| = n$.
7. Let $S = \{1, 2, 3, \dots, 27\}$ be a set. $P(S)$ the powerset of S .

Study questions (a), (b) and (c) of problem 6 for this $P(S)$.
8. Let $S = \{a_1, a_2, \dots, a_{45}\}$ be a set and $P(S)$ be the power set of S . Let G be a self complemented largest subset vertex multigraph.

Prove / disprove G has no nontrivial special subset vertex multisubgraph.

9. Let $S = \{Z_{12} \cup I\}$ be a set and $P(S)$ be the power set of S .
- i) Prove both the subsets $P(B) = P(Z_{12})$ and $P(C) = P(Z_{12}I)$ contribute to same number of subset vertex multigraphs using vertex sets $P(B)$ and $P(C)$ respectively.
 - ii) Obtain all special features associated with subset vertex multigraphs using vertex subsets from $P(S)$.
 - iii) How many subset vertex multigraphs using $P(S)$ will not contain special subset vertex multisubgraphs?
 - iv) How many subset vertex multigraphs using $P(S)$ contain hyper multisubgraphs?
 - v) Is $|P(\langle A \cup B \rangle) = |P(A) \cup P(B)|$?
10. Let $S = \{a_1, \dots, a_{27}\}$ be a set of order 27. $P(S)$ the power set of S .
- i) How many star subset vertex multigraphs can be constructed using $P(S)$?
 - ii) How many circle subset vertex multigraphs can be constructed using $P(S)$?
 - iii) How many complete subset vertex multigraphs can be constructed using $P(S)$?
 - iv) How many pseudo complete subset vertex multigraphs are there using $P(S)$?

- v) Find the number of star subset vertex multigraphs which has its universal complement also to be a star subset vertex multigraph.
 - vi) Find all special subset vertex multisubgraphs of a star subset vertex multigraph whose local complement is also a star subset vertex multisubgraph.
11. Let $S = \{\langle Z_{18} \cup g \rangle\}$ be the given set of multidual numbers. $P(S)$ its power set.
- a) Study questions (i) to (vi) of problem (10) for this S .
 - b) Derive any other special feature enjoyed by the subset vertex multigraphs using this $P(S)$.
12. Let $S = \{1, 2, \dots, 15\}$ be a set of order 15. $P(S)$ the powerset of S .

Let G be the star subset vertex multigraph given by the following figure.

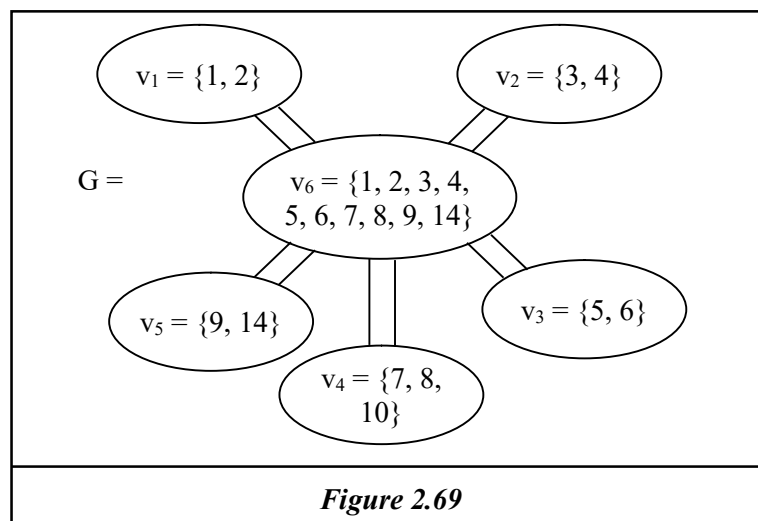

- a) Find the universal complement of G .
- b) How many special subset vertex multisubgraphs of G exist which are star subset vertex multisubgraphs?
- c) Find the local complements of these subset vertex multisubgraphs which are also star subset vertex multisubgraphs?
- d) What is the structure enjoyed by G^C , the universal complement of G ?

13. Let $S = \{1, 2, \dots, 18\}$ be a set of order 18. $P(S)$ the powerset of S . Let G be the circle subset vertex multigraph given by the following figure.

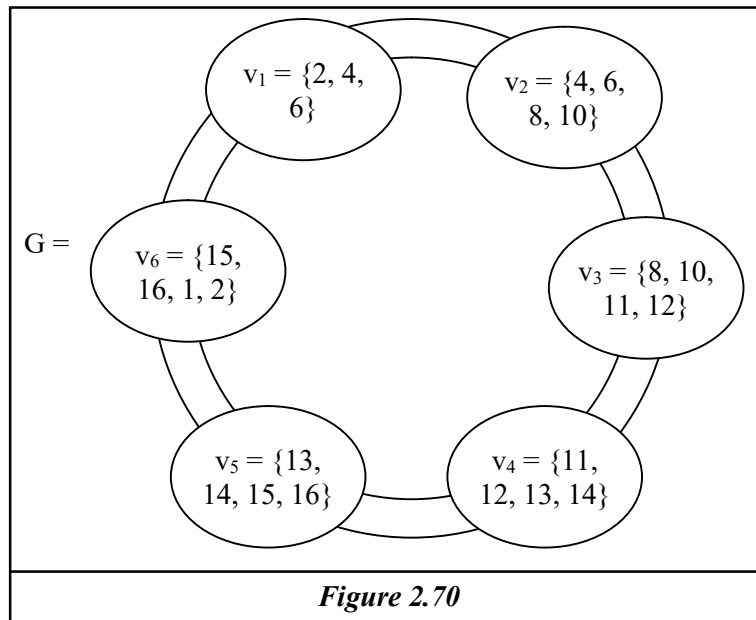

- a) Find the universal complement G^C of G .
 - b) Is G^C a circle subset vertex multigraph?
 - c) Find all special subset vertex multisubgraphs of G .
 - d) Find the local complements of these special subset vertex multisubgraphs of G .
 - e) How many of these local complements of special subset vertex multisubgraphs of G are circle multisubgraphs?
 - f) Can G have hyper special subset vertex multisubgraphs?
14. Let $S = \{a_1, \dots, a_{24}\}$ be a set. $P(S)$ the powerset of S . Find the subset vertex multigraph G using the vertex subsets which is a chain given below.

$$v_1 = \{a_{10}\} \subseteq \{a_{10}, a_{11}, a_2, a_4\} = v_2 \subseteq v_3 = \{a_2, a_4, a_{10}, a_{11}, a_6, a_7, a_8\} \subseteq \{a_2, a_4, a_6, a_7, a_{16}, a_8, a_{10}, a_{11}\} = v_4 \subseteq \{a_2, a_4, a_6, a_7, a_{16}, a_8, a_{11}, a_{10}, a_{17}, a_{20}, a_{24}\} = v_5.$$

- a) Is G a complete subset vertex multigraph?
- b) Can G have complete special subset vertex multisubgraphs?
- c) What is the structure enjoyed by the universal complement G^C of G ?
- d) Is G^C a pseudo complete subset vertex multigraph?
- e) Find all special subset vertex multisubgraphs of G ?

- f) Prove there is no local complement for any special subset vertex multisubgraph of G .

15. Let $S = \{1, 2, 3, \dots, 27\}$ be a set of order 27. $P(S)$ the powerset of S .

Let G_1 be the subset vertex multigraph with subset vertices $v_1 = \{3, 5, 7, 8, 10\}$, $v_2 = \{1, 2, 7, 8, 12, 16\}$, $v_3 = \{10, 11, 12, 13, 14, 16, 17, 18, 19\}$, $v_4 = \{3, 4, 5, 6, 7, 8, 20, 21, 22, 23, 24\}$, $v_5 = \{1, 2, 3, 5, 9, 10, 12, 18, 25, 26, 27\}$ and $v_6 = \{1, 2, 3, 6, 8, 9, 15, 16, 18, 27, 25\}$.

- i) Draw the subset vertex multigraph G_1 using the vertex subsets $\{v_1, v_2, \dots, v_6\}$.
- ii) Is G_1 a pseudo complete subset vertex multigraph?
- iii) Study questions (a), (b), (c), (d), (e) and (f) of problem (14) for this G_1 .
- iv) Compare the subset vertex multigraph G of problem (14) with this G_1 .

16. Let $S = \{1, 2, \dots, 36\}$ be a set of order 36. $P(S)$ the power set of S .

- a) Find all self-complemented subset vertex multigraphs that can be got using $P(S)$.
- b) Give the total number of vertices of the largest subset vertex multigraph.
- c) For the given set of subset vertices draw the subset vertex multigraph G . $v_1 = \{2, 6, 8, 10,$

12, 14, 16, 18}, $v_2 = \{14, 16, 18, 20, 22\}$, $v_3 = \{20, 22, 24, 26, 28\}$, $v_4 = \{28, 30, 32\}$, $v_5 = \{32, 34, 36\}$ and $v_6 = \{32, 2, 6, 8, 10\}$.

- d) Is G a circle subset vertex multigraph?
- e) Find the universal complement G^C of G ?
- f) Is G^C a pseudo complete subset vertex multigraph?
- g) Find all special subset vertex multisubgraphs of G .
- h) Can G contain a hyper special subset vertex multisubgraph?

17. Let $S = \{1, 2, \dots, 45\}$ be a set of order 45. $P(S)$ a powerset of S .

- a) Draw the subset vertex multigraph using the vertex subsets given in the following $v_1 = \{1, 2, 3\}$, $v_2 = \{4, 5, 6, 7\}$, $v_3 = \{8, 9, 10, 11, 12\}$, $v_4 = \{13, 14, 15, 16, 17, 18\}$, $v_5 = \{19, 20, 21, 22, 23, 24, 25\}$, $v_6 = \{26, 27, 28, 29, 30, 31, 32, 33\}$, $v_9 = \{34, 35, 36, 37, 38, 39, 40, 41, 42\}$ and $v_{10} = \{1 \text{ to } 43\}$.
- b) Is G a pseudo complete subset vertex multigraph?
- c) Is G a star subset vertex multigraph?
- d) Find the universal complement G^C of G .
- e) What is the structure enjoyed by G^C ?
- f) Find all special subset vertex multisubgraphs of G and G^C ?

- g) How many hyper multigraphs are there in G and G^c ?
 - h) Study any other special feature associated with this G .
 - i) Compare this G with G , of problem 15.
18. Show these special subset vertex multigraphs can be best suited for fault tolerant multinetworks.

Chapter Three

EDGE MULTISUBGRAPHS (SUBGRAPHS OBTAINED BY REMOVING EDGES OF MULTIGRAPHS)

In this chapter we proceed onto define the notion of edge subgraphs of a graph G . Edge subgraphs are those subgraphs of G for which one or more number of edges are removed akin to our classical subgraphs of a graph G for which one or more vertices are removed.

We first illustrate this situation by some examples.

Example 3.1 Let G be a graph given by the following figure.

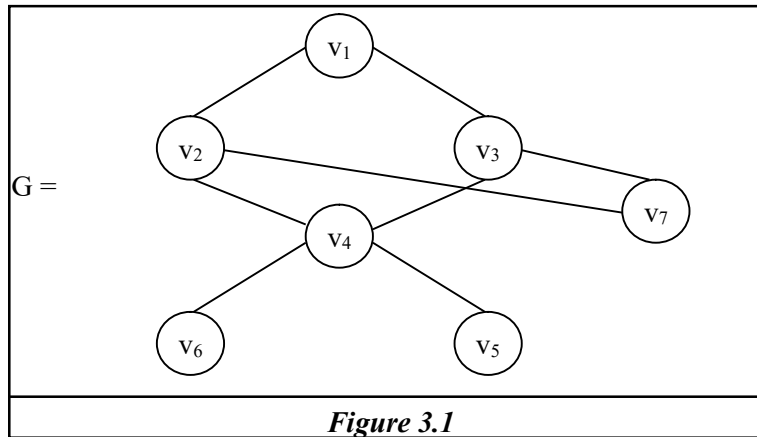

Now the edge is denoted by $v_i v_j$ if v_i and v_j has an edge connecting them.

If edge $\overline{v_6 v_4}$ is removed the resulting edge subgraph H_1 of G is given by the following figure.

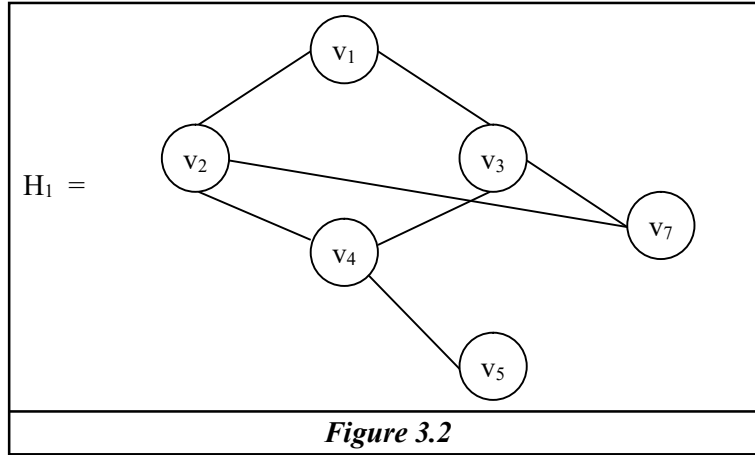

Let H_2 be the edge subgraph H_2 got by removing edge $\overline{v_4 v_5}$ is as follows.

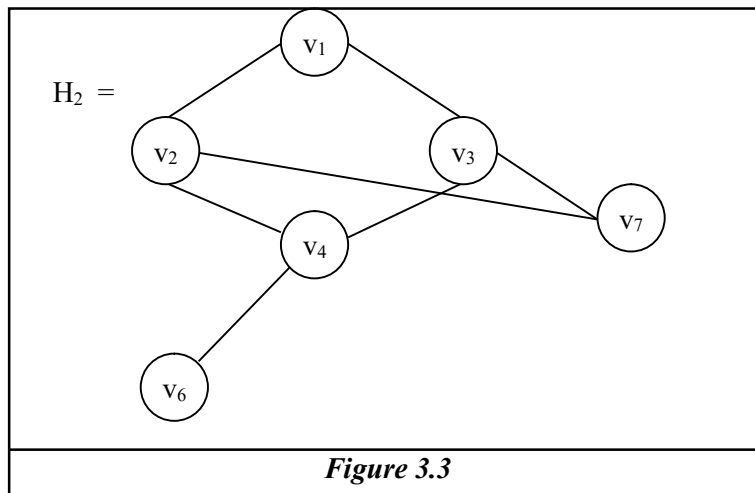

If edge $\overline{v_4v_3}$ is removed from the graph G the resulting edge subgraph H_3 is as follows.

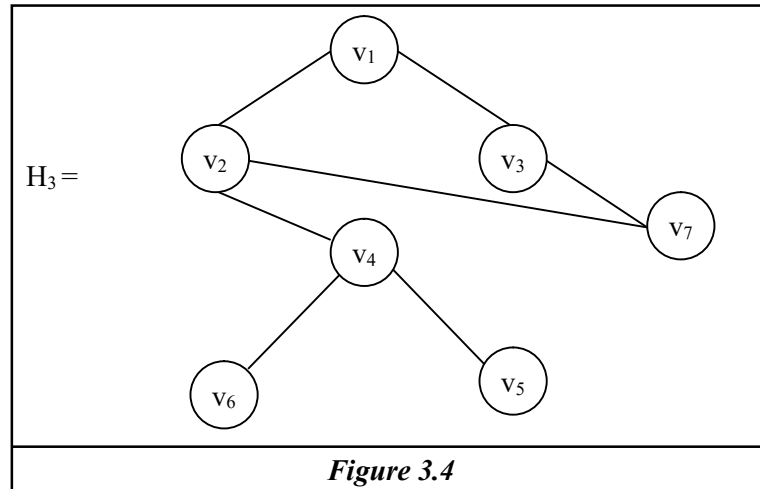

Let H_4 be the edge subgraph of the graph G which is got by the removing $\overline{v_4v_2}$ which is given by the following figure.

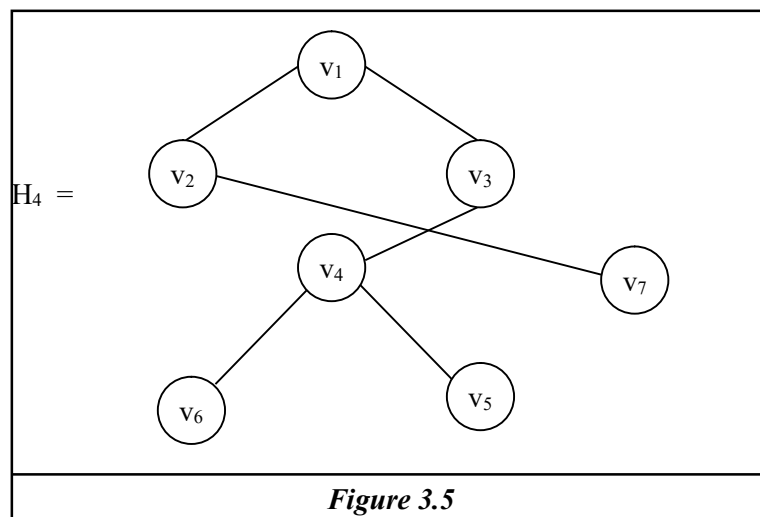

If edge $\overline{v_3v_7}$ is removed from G the resulting edge subgraph H_5 is as follows.

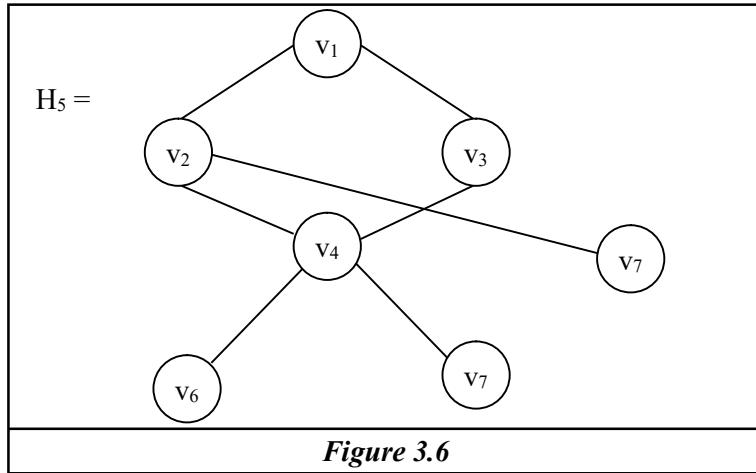

If the edge $\overline{v_3v_1}$ is removed the resulting edge subgraph H_6 is as follows.

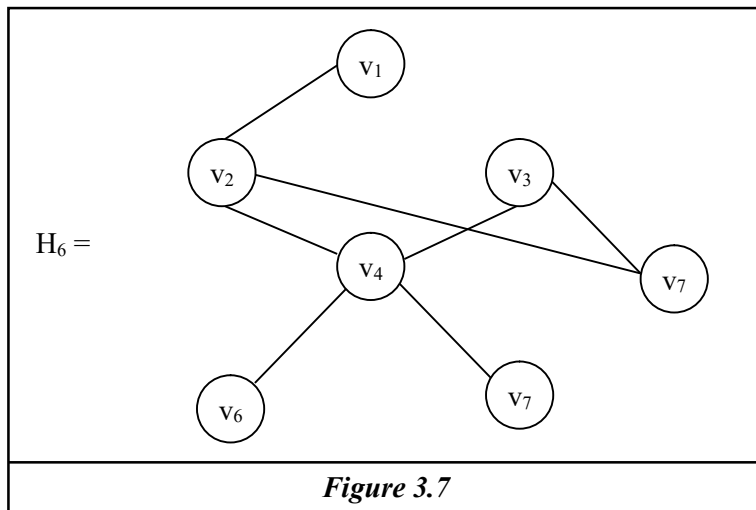

Let H_6 be the edge subgraph got by removing the edge $\overline{v_7v_2}$ from G ; which is given by the following figure.

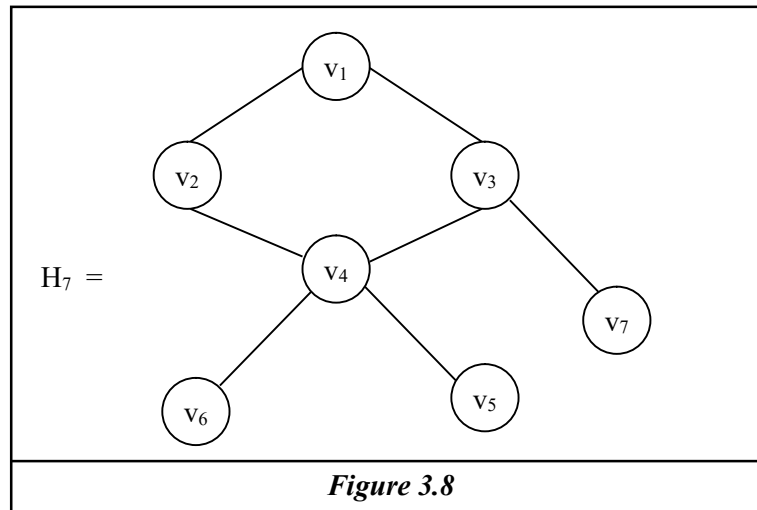

If the edge $\overline{v_1v_2}$ is removed from G let the edge subgraph H_7 be given by the following figure.

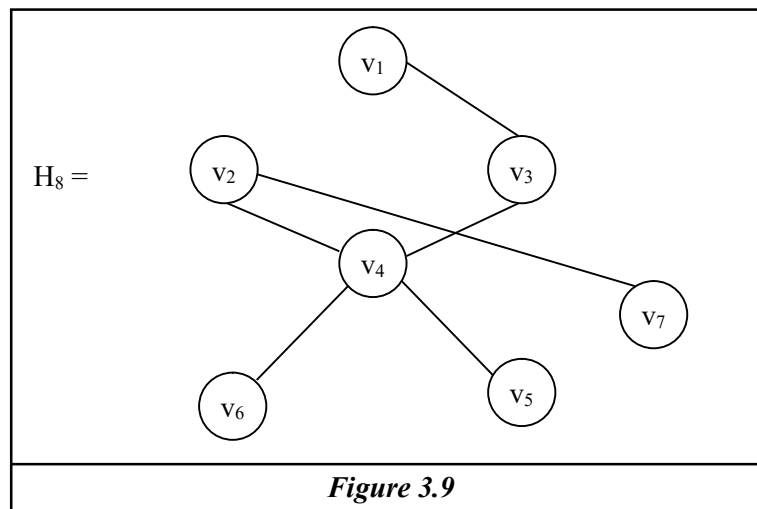

We see in this particular graph G all edge subgraphs got by removing one edge is connected and the vertices remain as seven or six.

Now we have 8 edges removal of two edges can be done in $8C_2$ ways that is there are 28 edge subgraphs of G .

We give a few edge subgraph of G after removing 2 edges in the following.

Let K_1 be the edge subgraph of G given by the following figure.

Edges $v_1 v_2$ and $v_3 v_1$ are removed and the resulting edge subgraph is as follows. This K_1 has only 6 vertices.

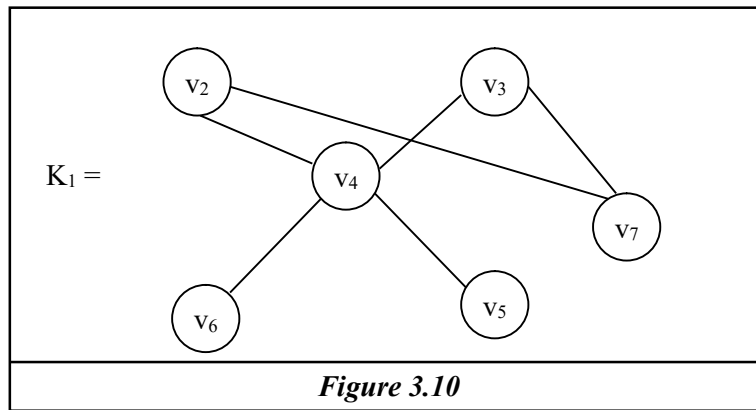

Let K_2 be the edge subgraph of G got by removing the edges $v_4 v_6$ and $v_4 v_5$. The resulting edge subgraph has only 5 vertices given by the following figure.

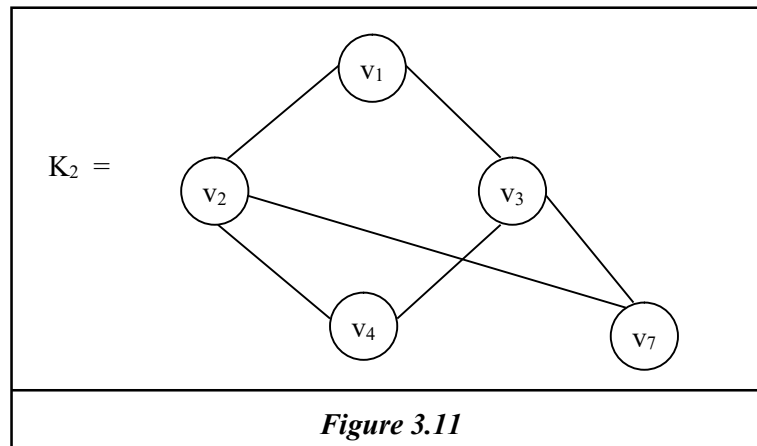

Let K_3 be the edge subgraph which is got by removing the edges v_3v_7 and v_7v_2 ; which is given by the following figure.

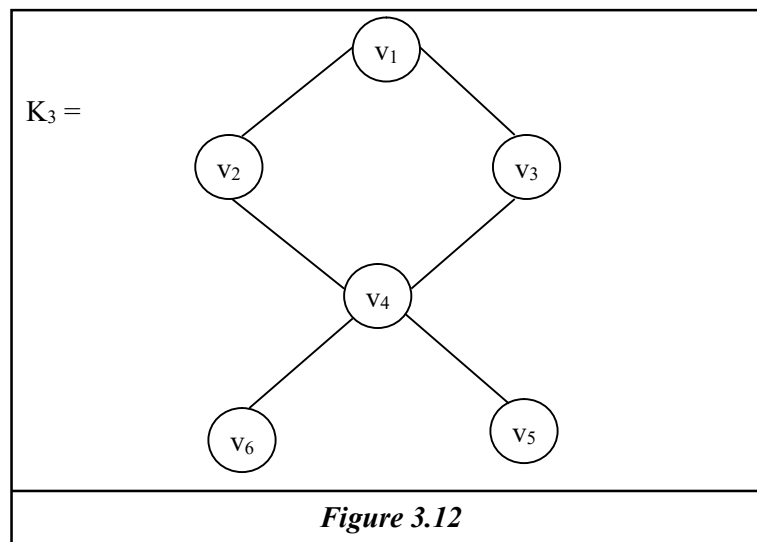

Only one vertex v_7 is removed.

Now we give a few examples in which 3 edges are removed from G .

Let L_1 be the edge subgraph of G in which edges v_2v_1 , v_2v_4 and v_2v_7 are removed, which is given by the following figure.

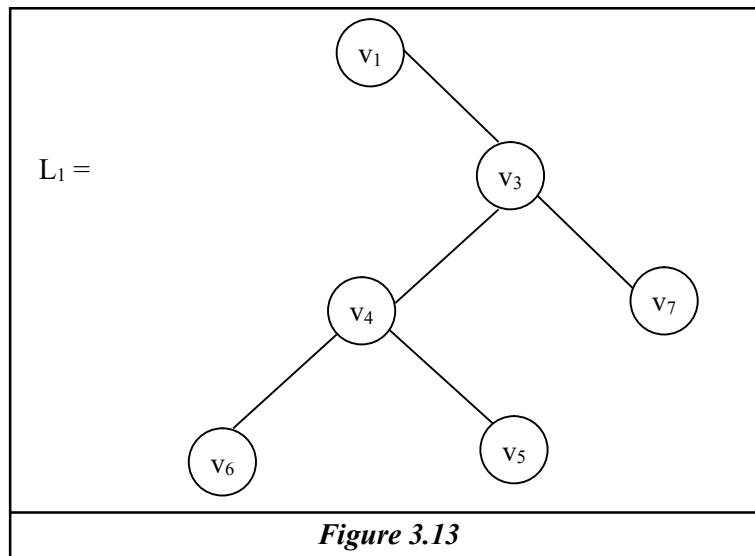

L_1 is connected edge subgraph and only one vertex v_2 is removed.

Let L_2 be a edge subgraph of G in which edges v_1v_3 , v_3v_7 , v_3v_4 and v_1v_2 is removed. The figure of L_2 is as follows.

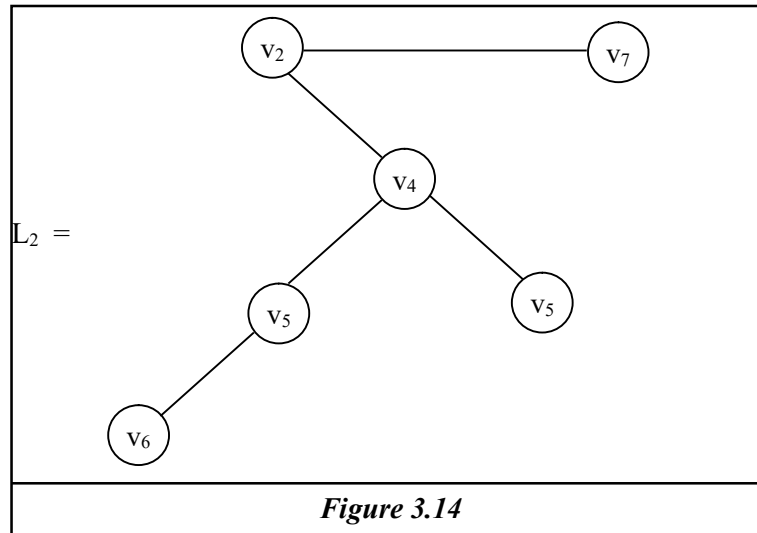

Still the edge subgraph is connected and 2 vertices v_1 and v_3 are removed by the moral of these edges.

Now let L_3 be the edge subgraph of G for which the edges v_1v_2 , v_2v_4 , v_2v_7 and v_3v_4 are removed. L_3 is given by the following figure.

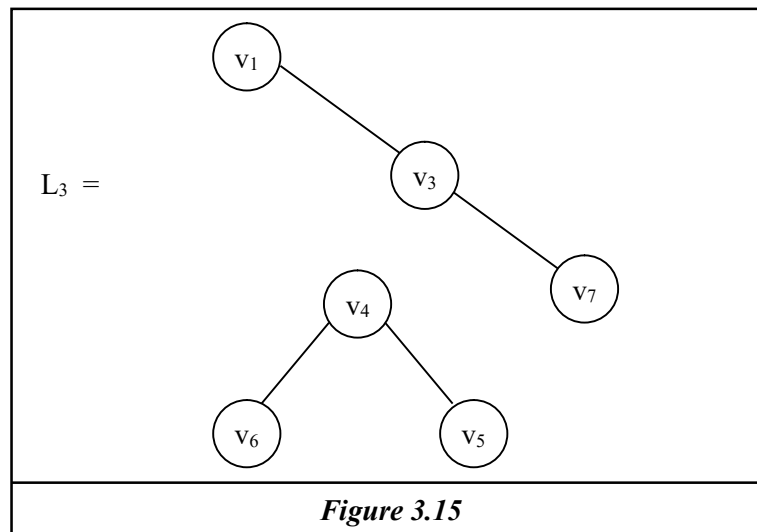

Clearly L_3 is a disconnected graph with 4 edges and only 6 vertices. The vertices v_2 alone is removed.

Thus we see it needs a minimum of four edges to be removed in G so that the resulting edge subgraph is not connected. However, for this graph G removal of any edges does not make the resulting edge subgraph to be disconnected.

Further we cannot always says in case of this G , removal of four edges will make the edge subgraph a disconnected one. For L_4 be the edge subgraph of G got by removing the edges v_4v_2 , v_4v_3 , v_4v_6 and v_4v_5 . The resulting edge subgraph of G is given by the following figure.

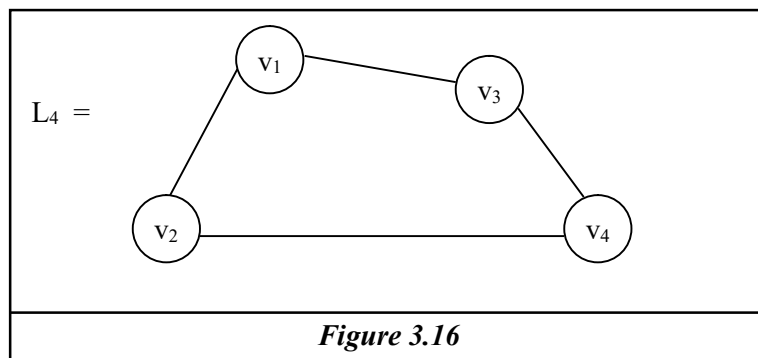

We see L_4 is a circle or a ring edge subgraph with four vertices and 4 edges and 3 vertices are automatically removed from G .

So we cannot say removal of 4 edges will result in a edge subgraph which is a ring.

Thus we see it is very difficult disconnected a graph by removing edges.

This study is vital for this is nothing but the edge cut method used in social information multi networks to get the resulting dendrogram.

Thus this study will be helpful in any other form of communication network for everything can continue to work even if some of the connections of relational ties are removed. Thus this edge subgraph can be a boon to fault tolerant multi networks also. In case of social information multi network we can get the overall nodes remaining the same even if some edges are removed.

Thus the introduction and a systematic development of edge subgraphs will be a boon to multi networks communications of all form.

We saw in the example this G could remain connected without even losing the nodes of vertices up to the removal of 3 edges maximum.

Now we will proceed onto describe by some more examples the notion of edge subgraphs of a graph G before. We make the abstract definition of it.

Example 3.2. Let G be a graph given by the following figure.

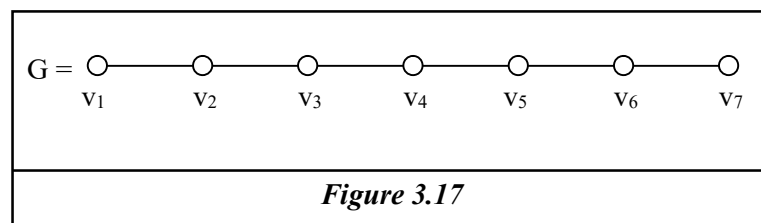

Removal of any edge other than v_1v_2 and v_6v_7 results in a disconnected edge subgraph of G given by the following figure.

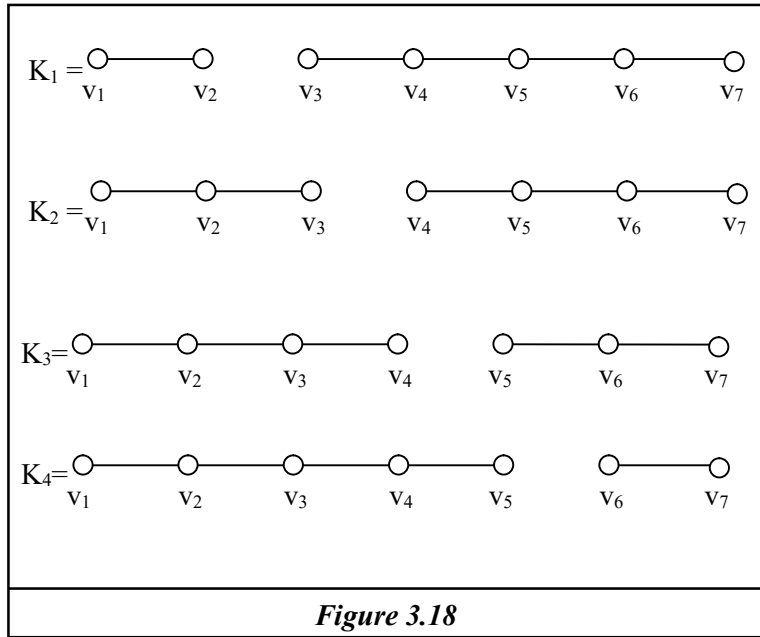

There are 4 disconnected edge subgraphs of G given by K_1, K_2, K_3 and K_4 with 7 nodes. The number of nodes / vertices remain the same for G and all these four edge subgraphs.

Let L_1 and L_2 be the edge subgraphs of G got by removing the edge v_1v_2 and v_6v_7 respectively given by the following figures.

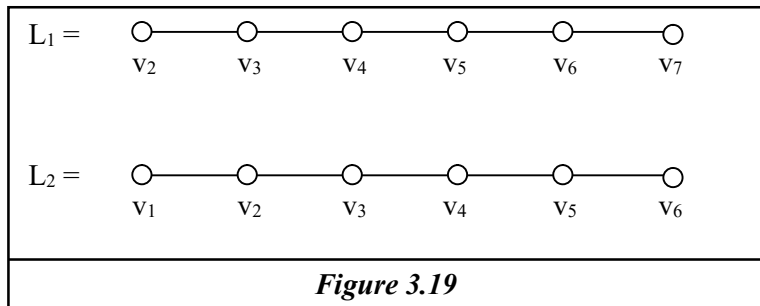

Both L_1 and L_2 are connected the number of vertices in both of them is only 6.

Now we give edge subgraphs of G for which we have removed 2 edges.

Let D_1 be the edge subgraph of G where edges v_1v_2 and v_2v_3 are removed given by the following figure.

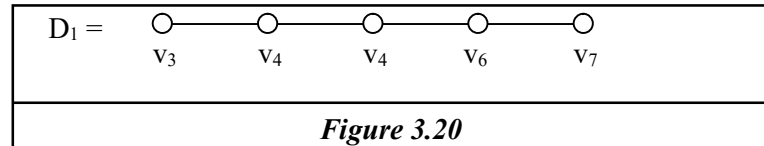

This has only 5 vertices.

Let D_2 be the edge subgraph of G obtained by removing the edges v_6v_5 and v_6v_7 .

D_2 is given by the following figure.

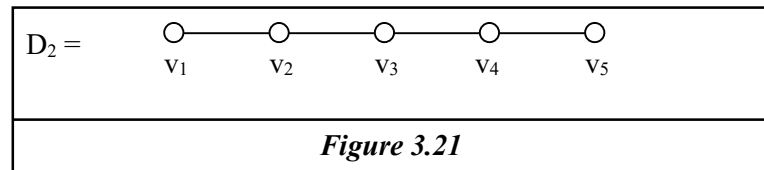

We see in case of D_1 and v_2 when two edges are removed automatically two vertices are also removed.

Let D_3 be the edge subgraph of G got by removing the edges v_2v_3 and v_5v_6 .

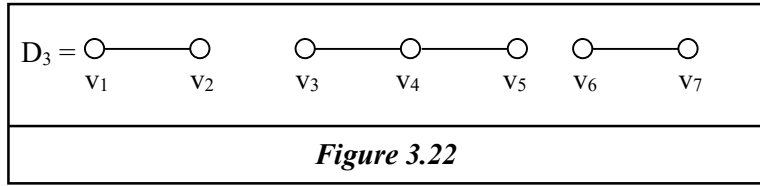

D_3 is a edge subgraph of G which is disconnected and has 3 components.

Let D_4 be the edge subgraph of G got by removing the edges v_2v_3 and v_3v_4 from G ; which is given by the following figure.

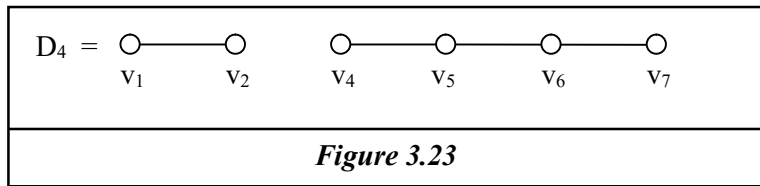

This edge subgraph D_4 has only two component and is disconnected. However, G has 6 vertices.

We cannot always say the edge subgraphs will have 6 vertices after removal of 2 edges it can have also 5 vertices.

For remove the edges v_1v_2 and v_2v_3 in G we get D_5 as the resulting edge subgraph of G given by the following figure.

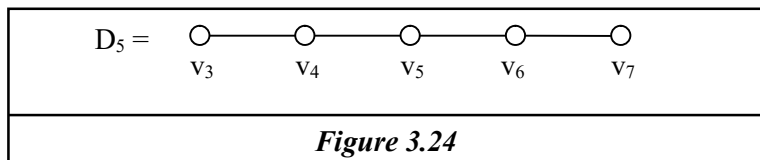

The vertices v_1 and v_2 are removed.

Similarly, if edges v_5v_6 and v_6v_7 are removed from the graph G the resulting edge subgraph of G is as follows.

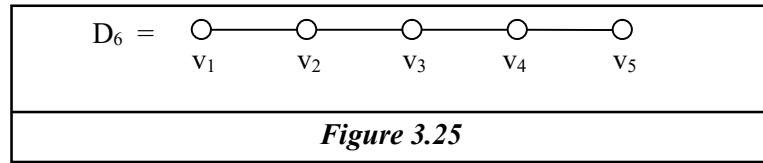

D_6 is connected by has only 5 vertices.

Now we will just give one or two examples in which 3 edges from G are removed.

Let D_7 be the edge subgraph of G given by the following figure where edges v_1v_2 , v_2v_3 and v_3v_4 are removed.

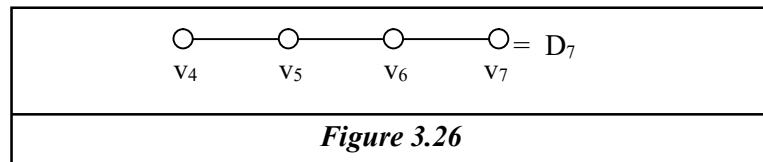

Clearly D_7 has only 4 vertices.

Let D_8 be the edge subgraph of G given by the following figure after removal of the edges v_2v_3 , v_5v_6 and v_6v_7 from G .

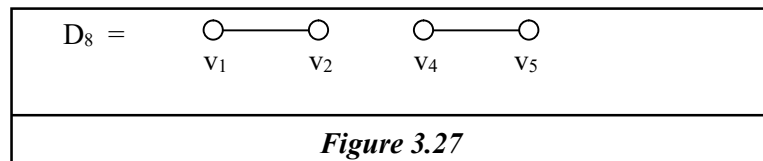

Example 3.3. Let G be circle graph given by the following figure.

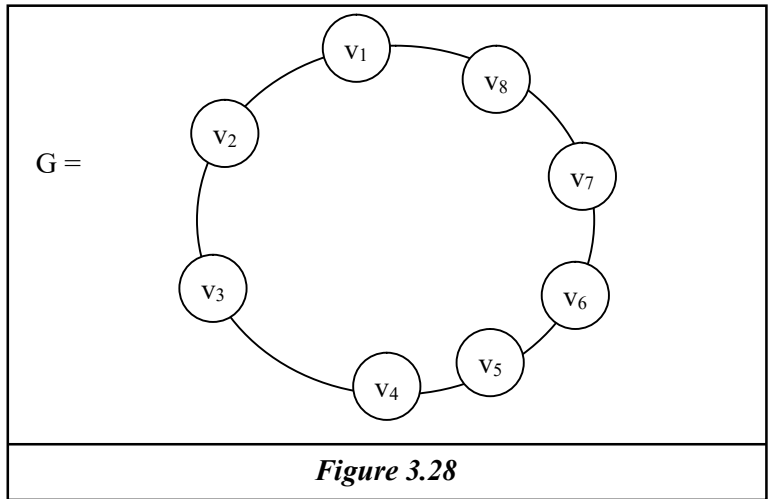

Clearly G is a circle graph with 8 edges.

Removal of any one edge from G results in a connected edge - subgraph but it is not a circle with 8 vertices.

We see removal of two edges from G can result in a connected edge subgraph with 7 vertices or a disconnected edge subgraph with 8 vertices given by the following figures.

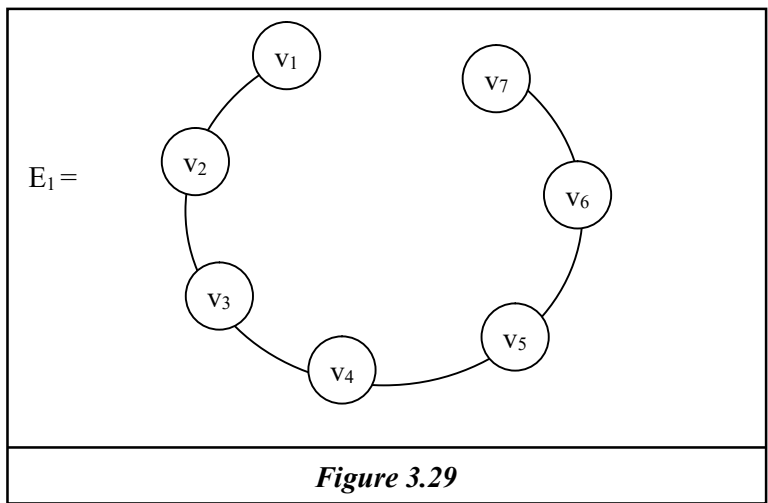

Edges v_1v_8 and v_8v_7 are removed from G so E_1 remains to be connected edge subgraph of G .

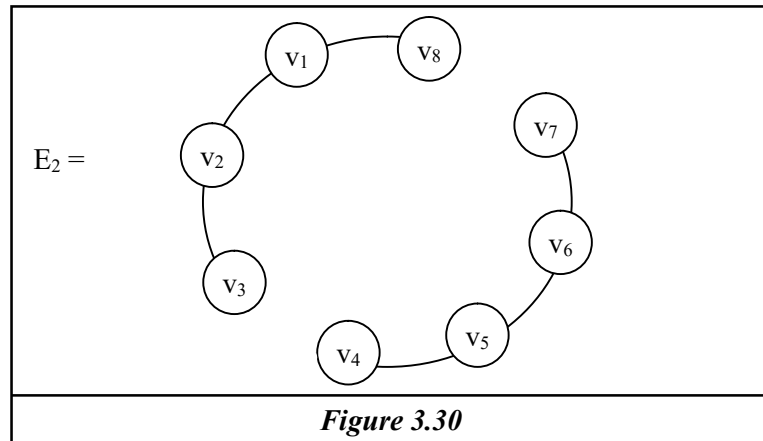

E_2 is a edge subgraph of G for which the edges v_8v_7 and v_3v_4 are removed. We see E_2 is disconnected but has 8 vertices.

When 3 edges are removed from G we can have connected edge subgraph with 6 vertices or disconnected edge subgraph with two components seven vertices or disconnected edge subgraph with 3 components with 8 vertices all these 3 types of edge subgraphs of G are described by the following figures.

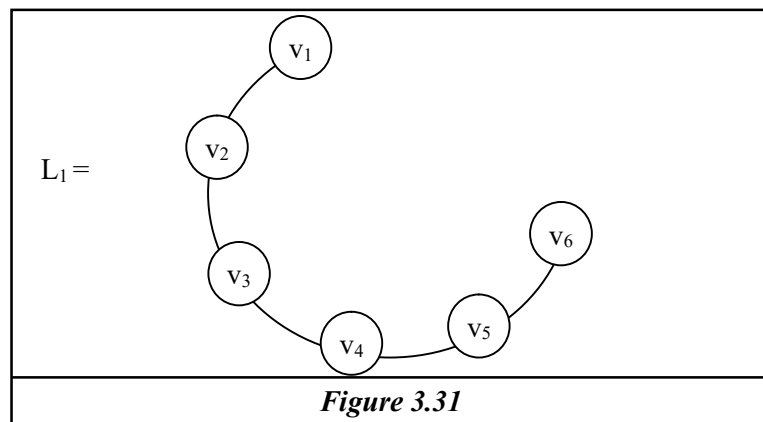

The edges v_1v_8 , v_8v_7 and v_7v_6 are removed.

L is a edge subgraph of G which is connected but has only 6 vertices.

Now let L_2 be the edge subgraph of G for which the edges v_1v_8 , v_8v_7 and v_4v_5 are removed from G . The resultant edge subgraph L_2 of G is as follows.

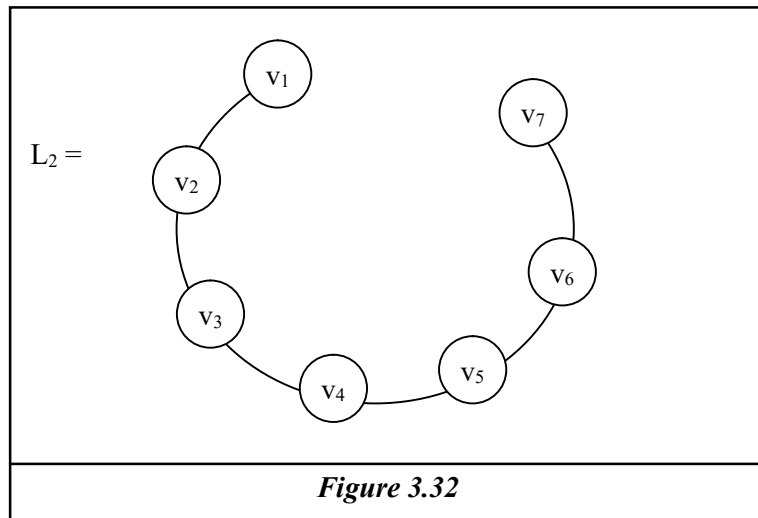

We see L_2 is a edge subgraph of G where it is disconnected with two complements and has only 7 vertices.

Let L_3 be the edge subgraph of G got by removing the edges v_1v_8 , v_4v_5 and v_2v_3 given by the following figure.

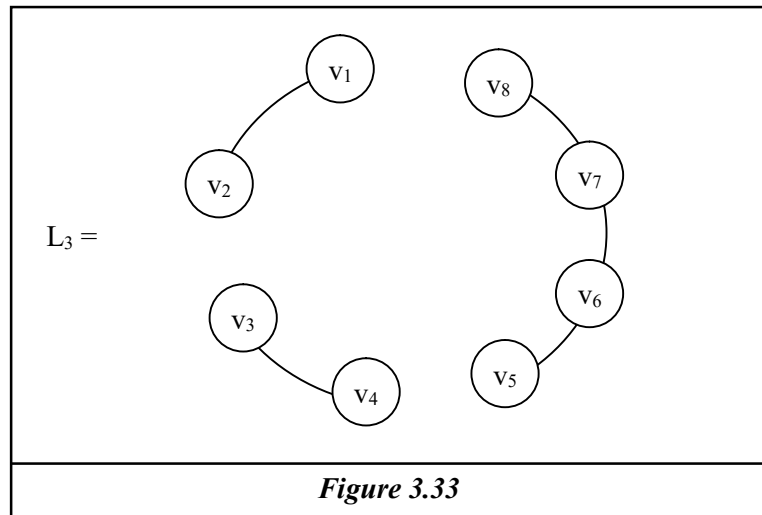

We see L_3 is a disconnected edge subgraph of G has 3 components and has 8 vertices.

None of the edge subgraphs of G are circle graphs.

In view of all these we now proceed onto define the edge subgraph of a graph.

Definition 3.1. Let $G = (p, q)$ be a graph with p vertices and q edges. We call H an edge subgraph of G if one or more edges from G are removed, while removing the edges the connected vertices at times may also be removed.

The edge subgraph H is a (r, s) subgraph where $0 < r \leq p$ and $0 < s < q$.

We will provide some more examples of them.

Example 3.4. Let G be a star graph given by the following figure.

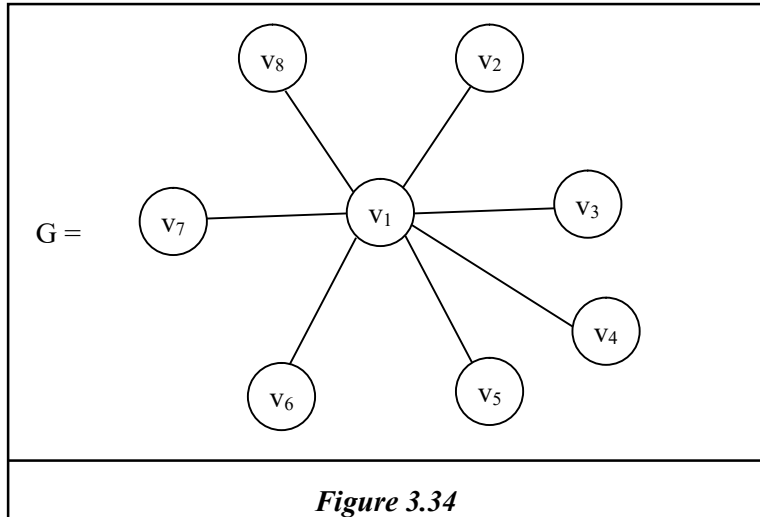

Suppose any edge v_1v_j is removed ($j \neq 1, 2 \leq j \leq 8$) then the resulting edge subgraph H_1 is a star graph with one vertex also removed when the edge v_1v_8 is removed.

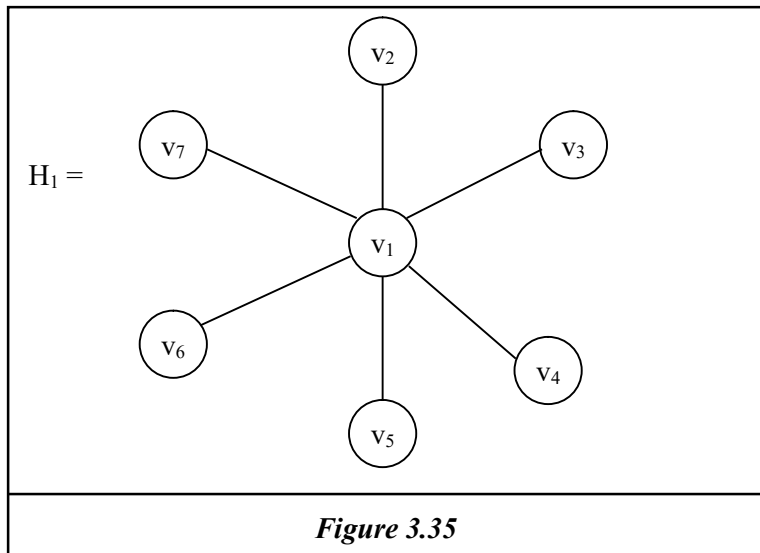

Suppose two edges of the star graph is removed then the resulting edge subgraph H_2 is only a star graph given by the following figure.

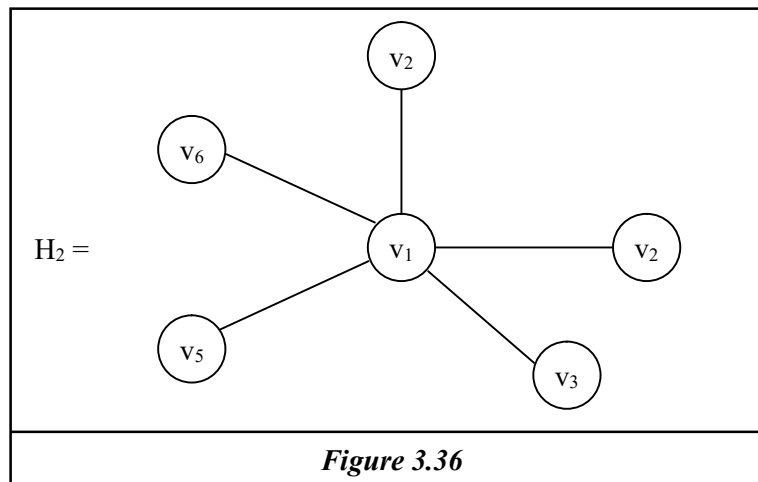

We see in H_2 there are only six vertices. Thus in a star graph G if t edges are removed in the resultant edge subgraph will have t vertices removed automatically.

Example 3.5. Let G be a complete graph with 7 vertices.

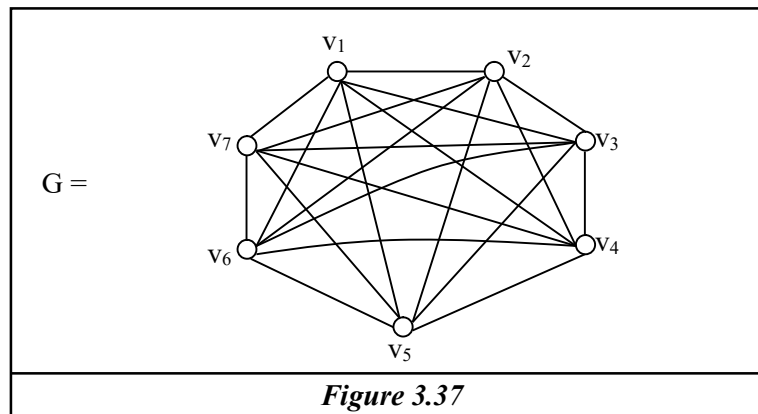

Any edge subgraph of G got by removing one edge is connected. In fact all edge subgraphs of G for which less than or equal to 5 edges are removed will remain to be connected and it will have all the 7 vertices to be intact.

We given in the following some edge subgraphs of G .

Let H_1 be the edge subgraph for which the edges v_1v_2 , v_2v_3 , v_3v_4 and v_4v_5 are removed.

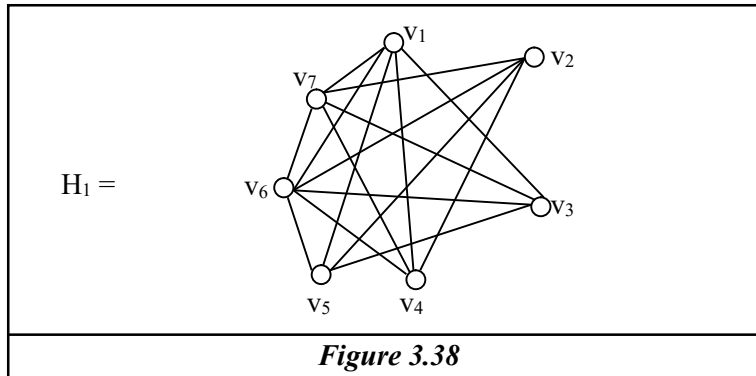

Let H_2 be the edge subgraph of G got by removing the edges v_1v_2 , v_2v_3 , v_3v_4 , v_4v_5 and v_5v_6 . The graph of H_2 is given in the following.

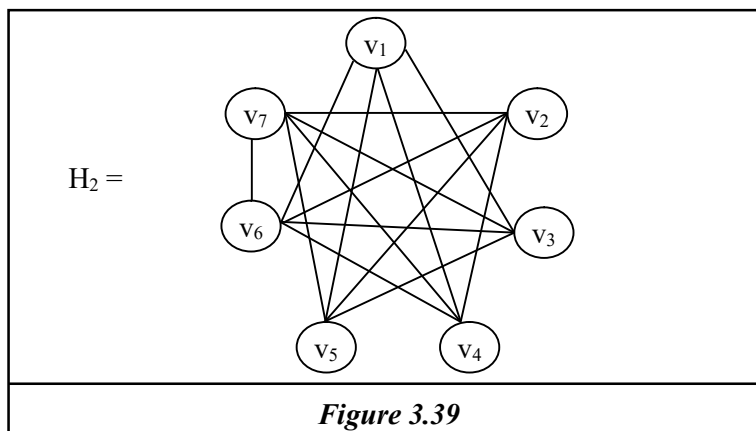

Clearly H_2 is also connected but has all the seven vertices.

Let H_3 be the edge subgraph of G got by removing the edges v_1v_2 , v_2v_3 , v_3v_4 , v_4v_5 , v_5v_6 , v_6v_7 and v_7v_1 given by the following figure.

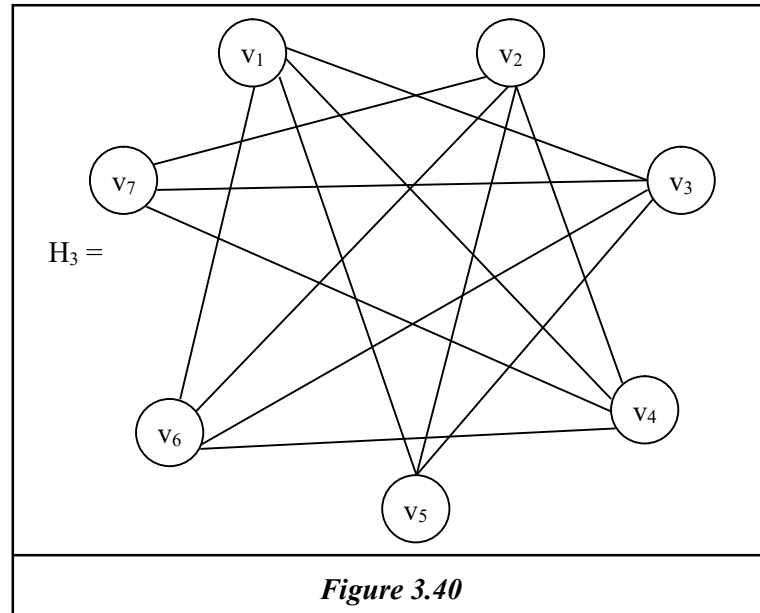

Though seven edges have been removed from G the resulting edge subgraph is connected with seven vertices.

If instead the edges v_1v_2 , v_1v_3 , v_1v_4 , v_1v_5 , v_1v_6 , v_1v_7 and v_2v_3 is removed the resulting edge subgraph H_4 is as follows.

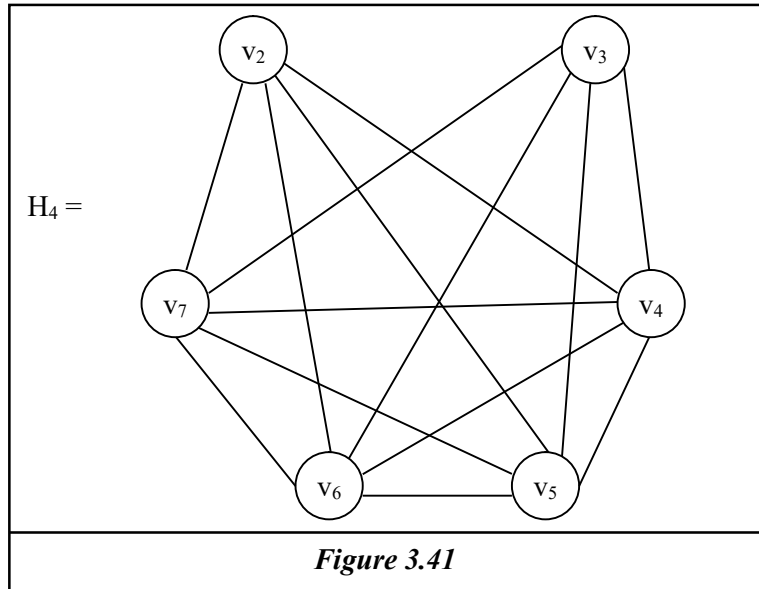

Clearly H_4 is connected still it has only six vertices and H_4 is not a complete graph.

Thus we can make the following comments in view of all these examples.

Theorem 3.1. *Let G be a star graph with $(n + 1)$ vertices. All edge subgraphs of G are star subgraphs with $(n + 1 - t)$ vertices if t edges are removed, $1 \leq t < n + 1$.*

Proof. Given G is a star graph with $(n + 1)$ vertices. Clearly if one edge is removed from G say, $v_i v_1$ where v_1 is the vertex which is adjacent with all other vertices we see the edge subgraph is a star graph with n vertices as vertex i is removed. Likewise, for any t number of edges say $v_j v_1$; $2 \leq j \leq n + 1$.

Removal of edges or cut edge graphs find applications in several fields. As our main concern is only the study of edge removal in case of subset vertex multigraphs and subset vertex graphs. It is important to note that in both these cases the removal of one edge may result in the removal of more edges and sometimes more vertices and the resulting subgraph may not be defined or may be disconnected and may also be empty.

We will illustrate these situations by some examples.

Example 3.6. Let G be a subset vertex graph given by the following figure.

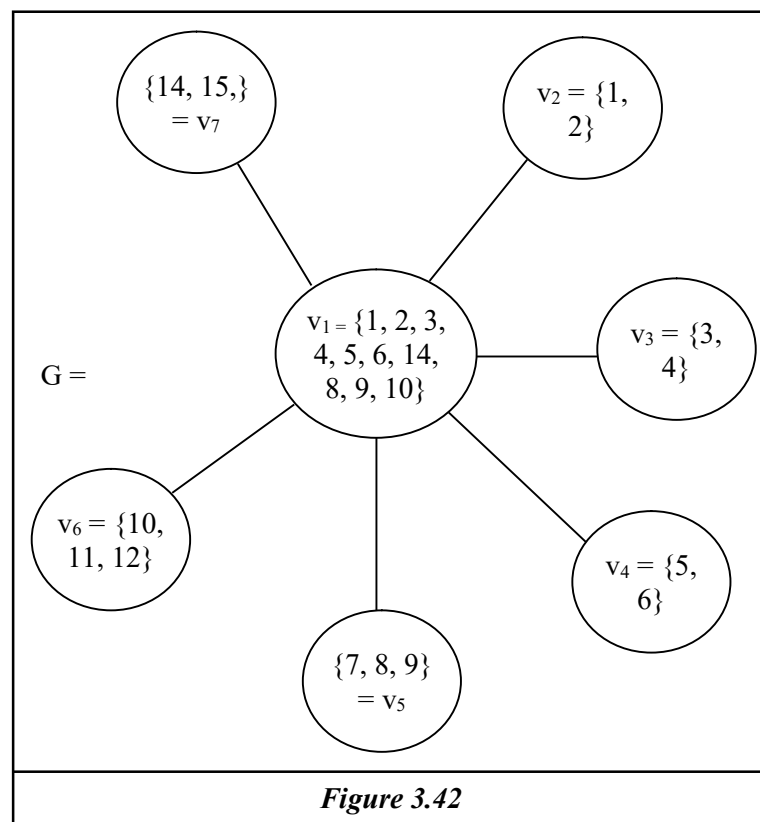

where $v_i \in P(S)$ the power set of S ; $S = Z_{16}$, $1 \leq i \leq 7$.

In this case if one edge is removed from G automatically one edge and one vertex are removed in G .

For if edge v_1 to v_3 is removed from G . Let $G \setminus \{v_1 v_3\} = H_1$. H_1 is given by the following figure.

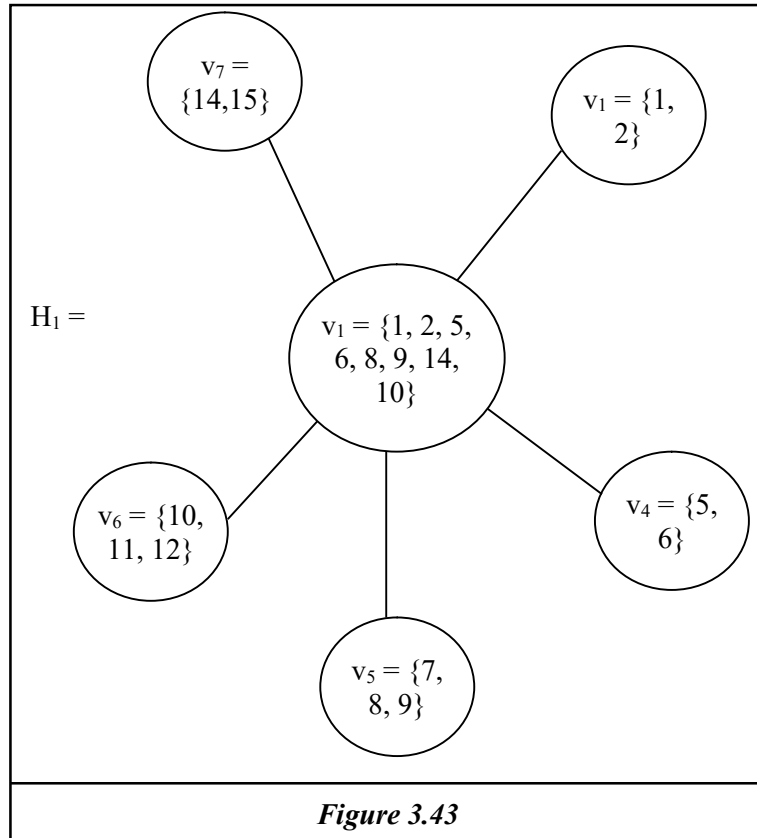

As in case of usual star graphs in case of star vertex subset graphs also when one edge is removed one vertex subset is removed.

So the theorem for star graphs holds good in case of subset vertex star graphs also.

Now we test directed subset vertex star graphs how many edges get dismantled if only one edge is removed by the following examples.

Example 3.7. Let G be a directed subset vertex star graph given by the following figure.

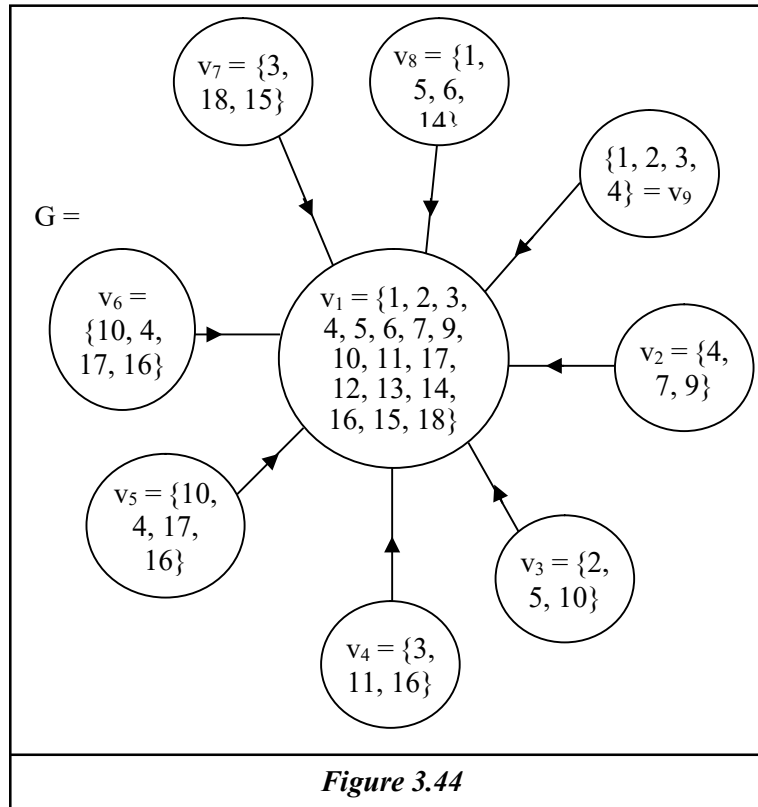

Suppose edge $\overrightarrow{v_1 v_9}$ is removed from G ; let $H_1 = G \setminus \{\overrightarrow{v_9 v_1}\}$.

The vertex subsets of G are from $P(S)$ where $S = Z_{19}$. The subset vertex subgraph $H_1 = G \setminus \{\overline{v_1 v_9}\}$ is given by the following figure.

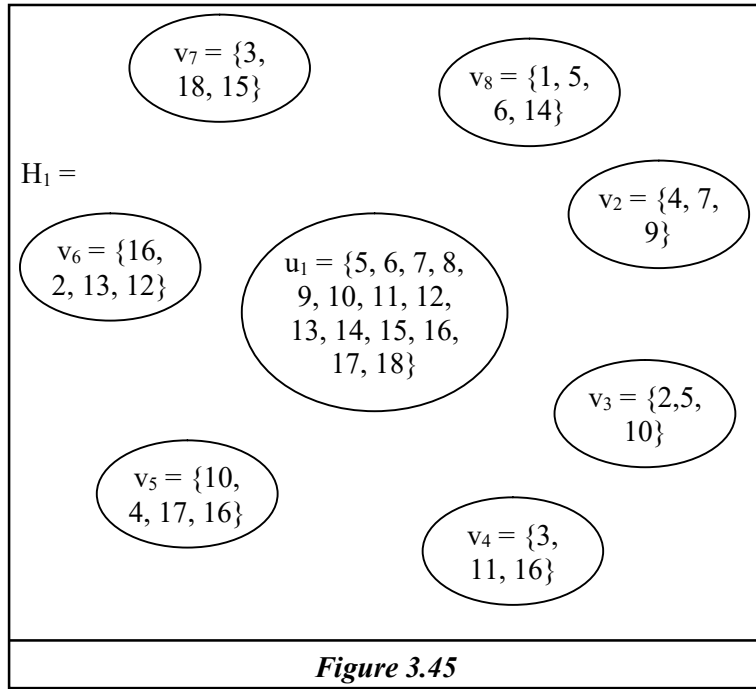

H_1 is only a empty subset vertex graph all edges of G are removed when the edge $\overline{v_1 v_9}$ is removed from G . As none of the vertex subsets $v_i \subseteq u_1; i = 2, 3, \dots, 8$ as $u_1 = v_1 \setminus \{1, 2, 3, 4\}$.

Consider the directed star subset vertex graph which is projective given by the following figure.

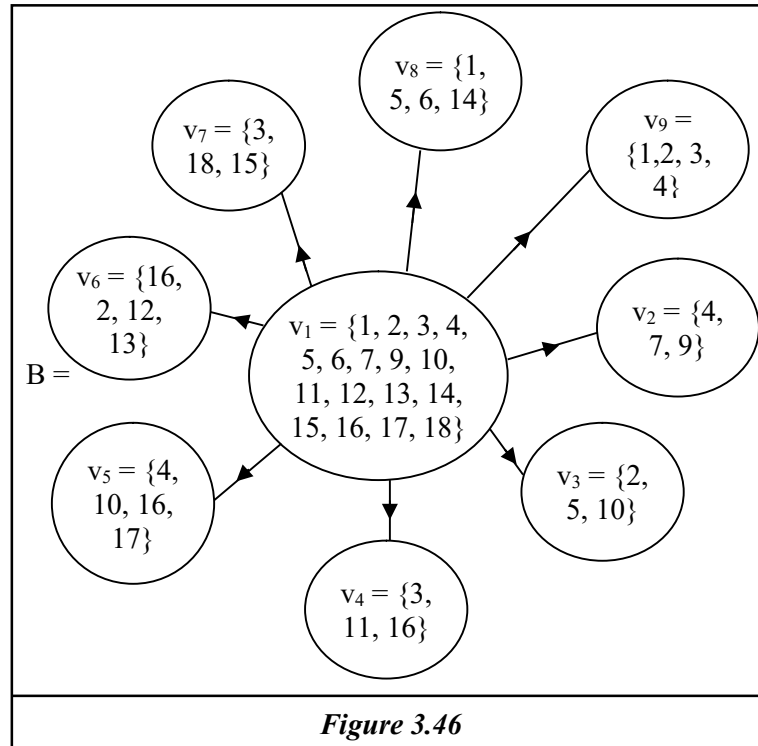

Figure 3.46

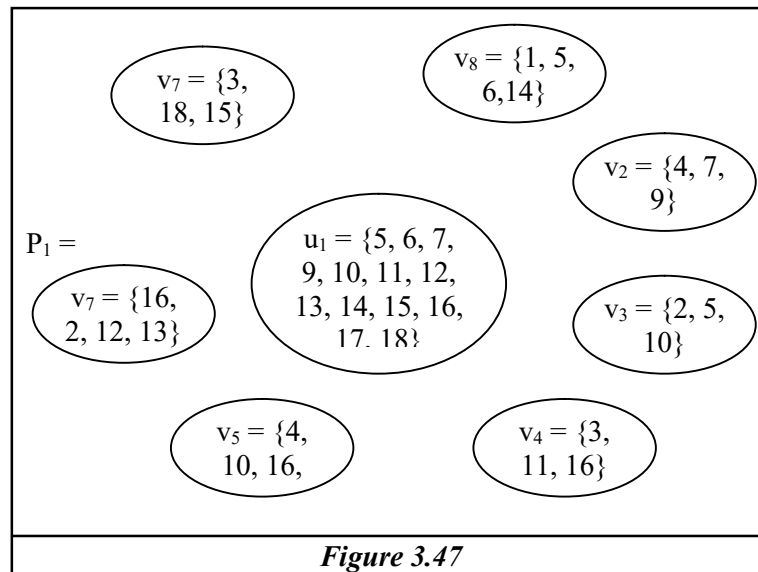
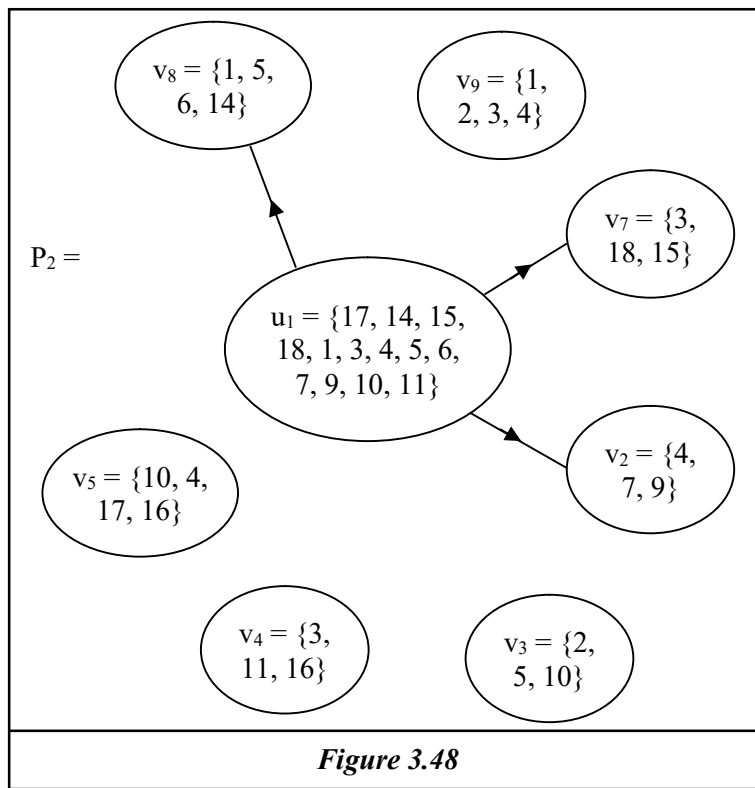

Figure 3.47

We remove the edge $\overline{v_1v_9}$ from B. Let P_1 be the resulting edge subset vertex subgraph of B; $P_1 = B \setminus \{ \overline{v_1v_9} \}$ given by the Figure 3.47.

P_1 is also an empty subset vertex subgraph. Thus the star graph when an edge $\overline{v_1v_9}$ is removed becomes empty. This is a very special feature associated with edge subset vertex subgraphs of a star subset vertex graph which is directed.

Suppose for the same star subset vertex graph (directed) B the edge $\overline{v_1v_6}$ is removed. We find $P_2 = B \setminus \overline{v_1v_6}$, which is given by the following figure.



P_2 is disconnected but has one connected component which is a star subset vertex directed subgraph. Thus from this example it is clear that removal of an edge in a directed subset vertex subgraphs need not always result in an empty subset vertex subgraph.

Thus we give the following theorem.

Theorem 3.2. *Let G be a star directed subset vertex graph which has vertex set $\{v_1, v_2, \dots, v_n\}$ from a power set $P(S)$ of a set S , with v_1 the central element of the star graph.*

The edge subset vertex subgraph of G is an empty subset vertex subgraph if and only if there exist an edge $\overline{v_1 v_t}$ ($\overline{v_t v_1}$) whose vertex set v_t is such that $v_t \cap v_j \neq \phi$, $t \neq j$ or 1 and for all $2 \leq j \leq n$ is removed.

Proof. Suppose we have G to be a directed subset vertex star graph with vertex set v_1, v_2, \dots, v_n from a power set $P(S)$ of a set S with v_1 as the ego centric element (or central element) of G . Suppose v_t is a vertex subset such that if $\overline{v_1 v_t}$ (or $\overline{v_t v_1}$) $t \neq 1$ is removed is a empty subset vertex subgraph, then we have to prove $v_t \cap v_j \neq \phi$ for all $j \neq t$; $2 \leq j \leq n$.

If on the contrary $v_t \cap v_j = \phi$ for some $j \neq t$ and $j \neq 1$ then we will have $v_j \subseteq v_1$ as it is given G is a star graph and we have an edge from $\overline{v_1 v_j}$ ($\overline{v_j v_1}$), so the resulting subset vertex subgraph is not empty contradiction. Hence the claim.

Suppose if there is a vertex v_t ; $t \neq 1$ such that $v_j \cap v_t \neq \phi$ for all $j \neq t$, $2 \leq j \leq n$ then we have to prove the edge $\overline{v_1 v_t}$

$(\overline{v_t v_1})$ if removed from G then $G \setminus \overline{v_1 v_t}$ (or $G \setminus \overline{v_t v_1}$) is a empty subset vertex multisubgraph of G .

To this end we have to prove $P_1 = G \setminus \overline{v_1 v_t}$ ($G \setminus \overline{v_t v_1}$) is a empty subset vertex subgraph of G .

By definition of directed vertex subset graphs we know if $\overline{v_j v_1}$ ($\overline{v_j v_1}$) is to be an edge then $v_j \subset v_1$ but this is not true as when the edge $\overline{v_1 v_t}$ ($\overline{v_t v_1}$) is removed no longer $v_j \subset v_1$ as $v_j \cap v_t \neq \phi$ and there is an element in v_j which is not in $\{v_1 \setminus v_t\}$ which now forms the center so there will be no edge in the subset vertex subgraph $G \setminus \{\overline{v_1 v_t}$ or $\overline{v_t v_1}\}$. Hence the claim.

In fact it is pertinent to keep on record that not all directed subset vertex star graphs will enjoy this property. This property will be enjoyed only by those subset vertex star graphs in which there is one vertex which is such that it has some common elements with all other vertices. Thus such star graphs can easily dismantle the ego centric networks. Hence in this case always the central ego character faces a threat by such strategic vertex. This can be applied in political scenario or in even marketing etc. For such star graphs or ego centric graphs will be termed in social network language as weak ego centric structures. Not all star subset vertex graphs are weak ego centric in nature.

Only those satisfying the conditions of the theorem are so in their structure.

Now we provide yet another example.

Example 3.8. Let G be a directed star subset vertex graph given by the following figure whose vertex subset is from $P(S)$ where $S = \mathbb{Z}_{27}$.

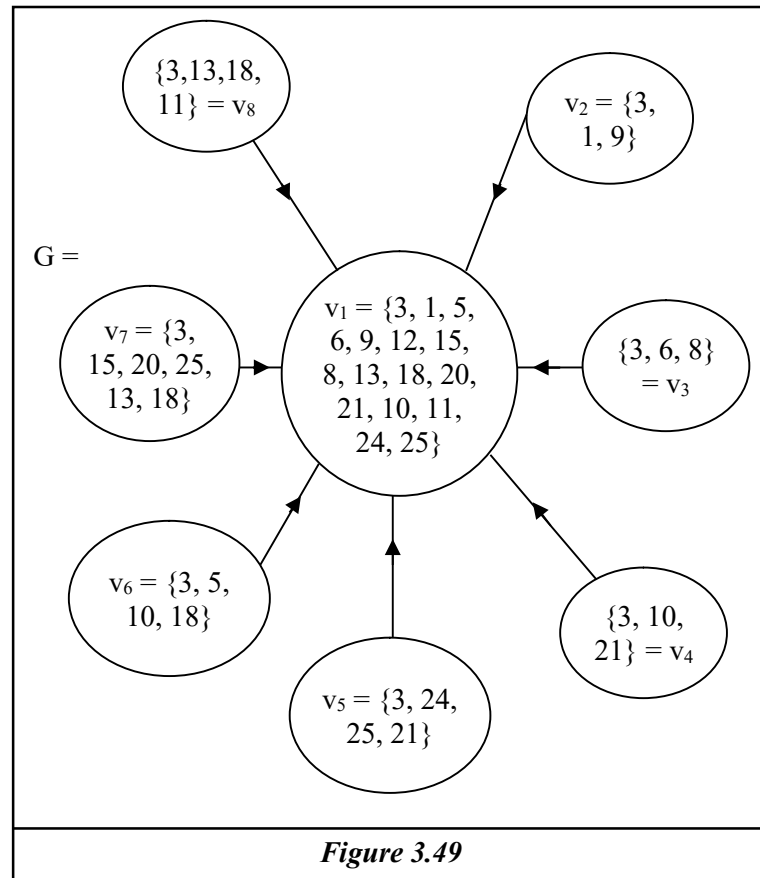

Any edge is removed from G we get only an empty subset vertex subgraph.

For instance remove the edge $\overline{v_6 v_1}$; let $H_1 = G \setminus \{\overline{v_6 v_1}\}$. The resulting figure is given below.

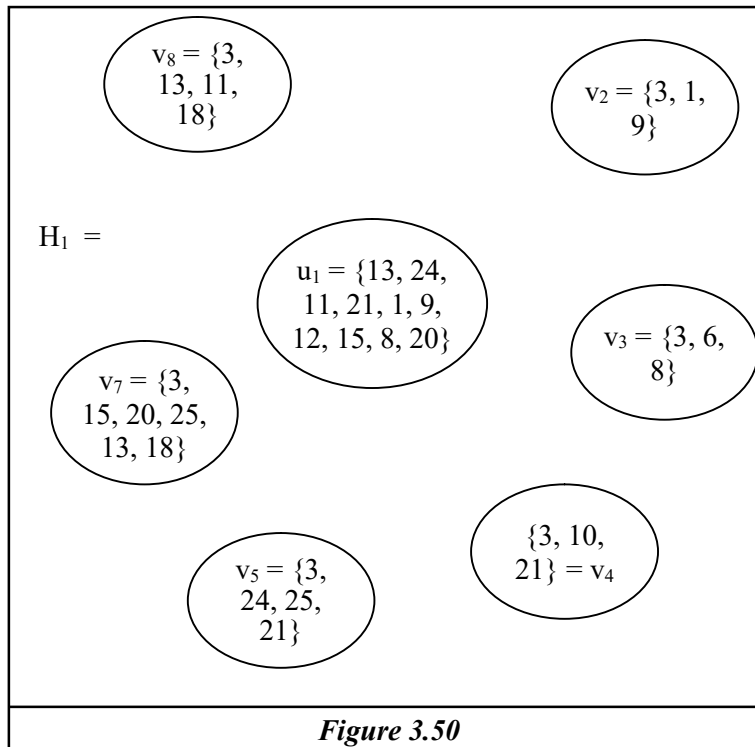

Figure 3.50

H_1 is a empty subset vertex subgraph of G .

This is true whatever the edge removed from G . Further it is observed.

$$\bigcap_{i=1}^8 v_i = \{3\}.$$

In view of this we have the following theorem.

Theorem 3.3. Let S be a set and $P(S)$; the power set of S . G be a directed subset vertex star graph with vertex set v_1, v_2, \dots, v_n such that any edge subset vertex subgraph of $G \setminus \{\overline{v_1 v_i} \text{ or } \overline{v_i v_1}\}$

is just a empty subset vertex subgraph of G_n ($2 \leq t \leq n$) if and only if $\bigcap_{i=1}^n v_i = \{s\} \neq \phi \in P(S)$.

Proof. Given G is a star directed vertex subset graph with vertex subsets $\{v_1, v_2, \dots, v_n\}$ with v_1 as the central (ego centric element). If a removal of any one of the edges $\overline{v_1 v_j}$ (or $\overline{v_j v_1}$) results in empty subset vertex subgraph; that is $G \setminus \{\overline{v_1 v_j}\}$ is an empty graph to prove

$$\bigcap_{i=1}^n v_i = \{s\} \neq \phi.$$

Clearly $v_1 \cap v_j = \{t\} = v_j$ and $v_j \subseteq v_1$; $2 \leq j \leq n$ as there is an edge $\overline{v_1 v_j}$ (or $\overline{v_j v_1}$).

Now as $G \setminus \{\overline{v_1 v_j}$ or $\overline{v_j v_1}\}$ is an empty graph we see none of the v_i is contained in $v_1 \setminus v_j$; j ; fixed $i \neq j$; $2 \leq i \leq n$; so we see removal of a single vertex set results in non-containment relation which in turn implies $\bigcap_{i=1}^n v_i = \{s\}$ as this situation is valid for any vertex v_p , $p \neq 1$; $2 \leq p \leq n$. Hence the claim.

On the contrary if $\bigcap_{i=1}^n v_i = \{s\}$ then we have to prove $B = G \setminus \{\overline{v_1 v_j}$ or $\overline{v_j v_1}\}$ is a empty subset vertex subgraph of G (for $j \neq 1$, $2 \leq j \leq n$). We know $\bigcap_{i=1}^n v_i = \{s\}$ so $\{s\}$ is contained in $v_1 \cap v_j$ so if there v_j elements are removed from v_1 then that will

include the elements also resulting in non-containment of every v_p in v_1 . Hence B will be a empty subset vertex subgraph.

Thus it is very important to note while forming the ego centric star graph the central person should be very cautions to see that no common feature from these concepts are enjoyed by every other person or that no other vertex shares properties with every other vertex if the central person should continue to function in the same way.

This will be applicable in a political scenario, in union leaders or any other relevant situations. For ego centric networks are directed ones.

If this property is taken carefully one can avoid the unnecessary collapsing of the ego centric network.

Next, we provide a few examples of directed subset vertex graphs which are rings or complete ones.

Example 3.9. Let $S = Z_{27}$ and $P(S)$ the power of S.

Let G be a directed subset vertex graph which is a ring given by the following figure with vertex subsets from $P(S)$.

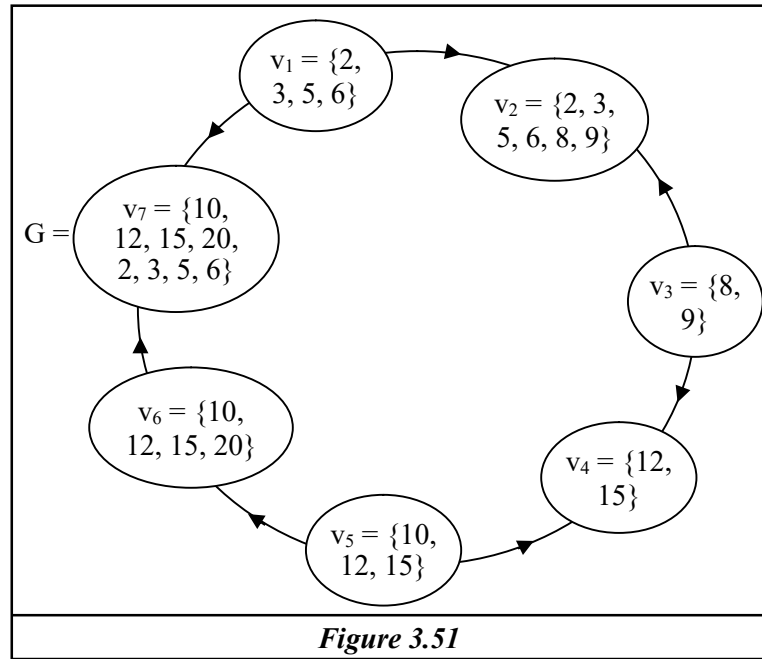

Suppose the edge $\overline{v_1 v_7}$ is removed from G ; $H_1 = G \setminus \overline{v_1 v_7}$ is given by the following figure.

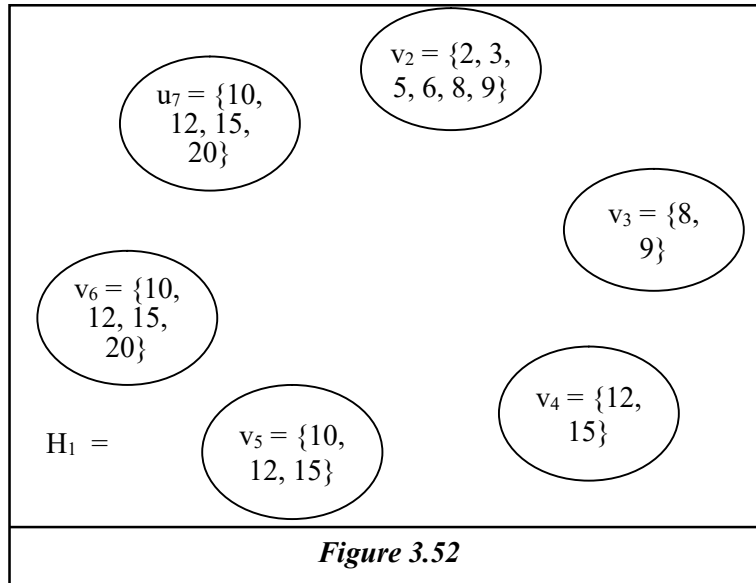

H_1 is not defined as $v_6 = u_7$ so when one edge is removed the subset vertex subgraph becomes undefined.

So a removal of an edge can dismantle and leave no reminiscence by making the very network undefined or is annihilated and the network becomes a nonexistence thing.

So only in case of subset vertex graphs which are directed we may get removal of an edge can make nonexistence of the graph. This will not occur in case of usual graphs.

Thus certain ring directed subset vertex graph by the removing an edge may become undefined as two vertices become equal.

Now we give an example of a complete directed subset vertex graph G in the following.

Example 3.10. Let G be a directed subset vertex multigraph with vertex subsets from the power set $P(S)$ where $S = Z_{27}$.

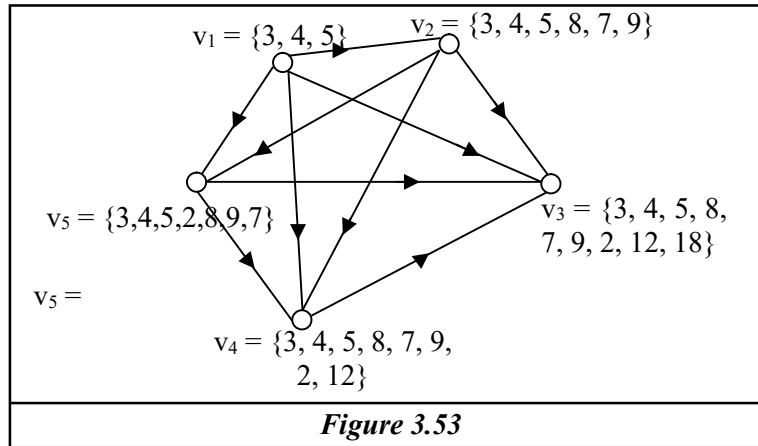

Now we find the subset vertex subgraph $G \setminus \overrightarrow{v_2 v_3} = H$;

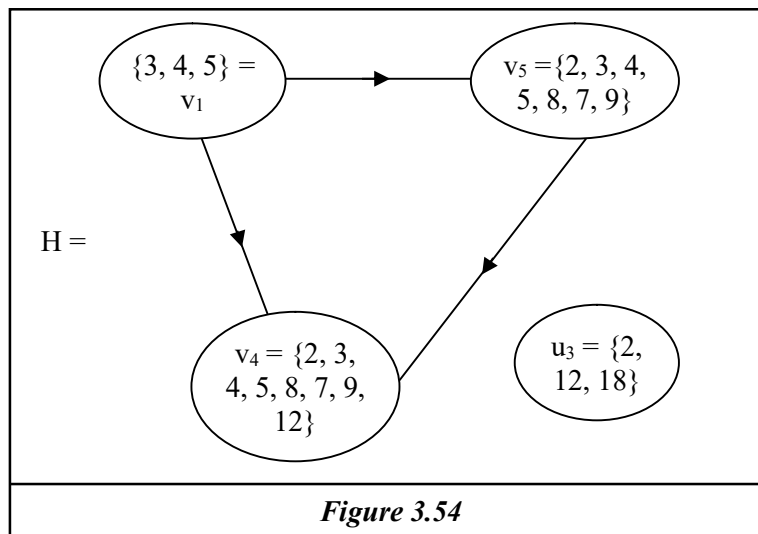

We see H the directed subset vertex subgraph of G has four vertices and only 3 edges it is disconnected with two components one a complete triad and other just a vertex subset.

Suppose from G two edges are removed $G \setminus \{\overrightarrow{v_2 v_3}, \overrightarrow{v_5 v_4}\} = K$, the figure of K is as follows.

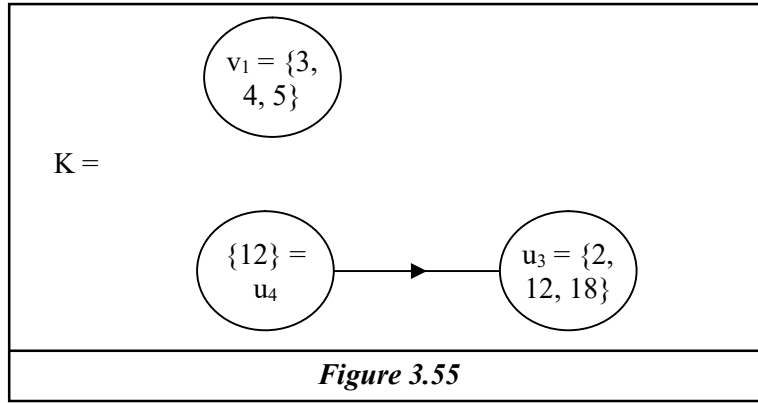

K is a disconnected subset vertex subgraph which just has two components directed dyad and subset vertex v_1 .

In view of this we propose the following problem for researchers.

Problem 3.1. Let S be any set, P(S) the power set of S. G be a directed complete subset vertex graph with n vertices $\{v_1, v_2, \dots, v_n\}$ ($v_1 \subset v_2 \subset v_3 \subset \dots \subset v_n$)

- i) If the edge $\overline{v_1 v_n}$ or $\overline{v_{n-1} v_n}$ is removed then the resulting subset vertex subgraph $H_1 = G \setminus \{v_i v_n / i = 1 \text{ or } n - 1\}$ is a complete directed subset vertex subgraph which has $(n - 2)$ vertices together with the subset vertex $(v_n \setminus v_i = u_i; i = 1 \text{ or } n - 1)$ so H_1 is disconnected with two components.
- ii) If any edge $\overline{v_i v_j}$ is removed from G, $j \neq n, 1 \leq i \leq n - 2$ then the subset vertex subgraph $P = G \setminus \overline{v_i v_j}$ is a connected subset vertex subgraph with a clique of order $n - 2$.

Proof is direct and hence left as an exercise to the reader.

Example 3.11. Let G be a directed complete subset vertex graph with vertex subsets v_1, v_2, \dots, v_8 from $P(S)$ where $S = Z_{36}$ given by the following figure.

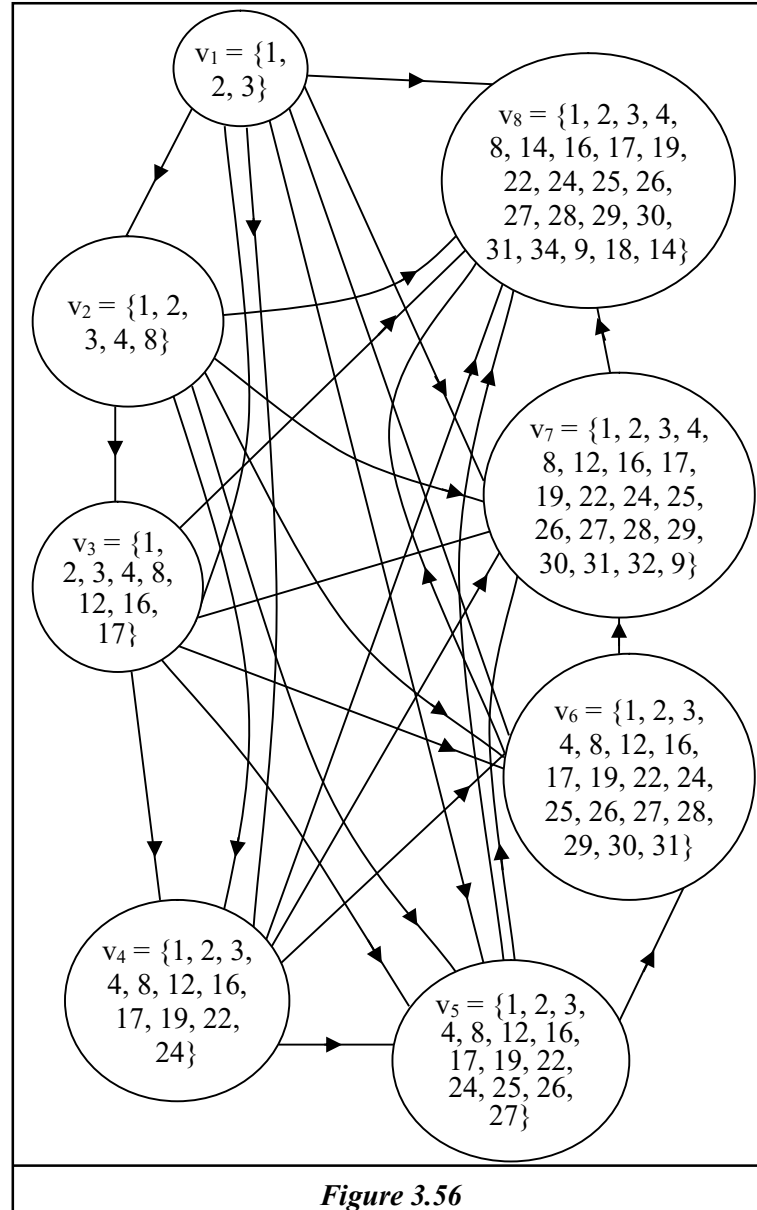

We find $H_1 = G \setminus \overline{v_7 v_8}$ the subset vertex subgraph. H_1 is given by the following figure with vertex subsets $\{v_1, v_2, v_3, v_4, v_5, v_6, v_8\}$.

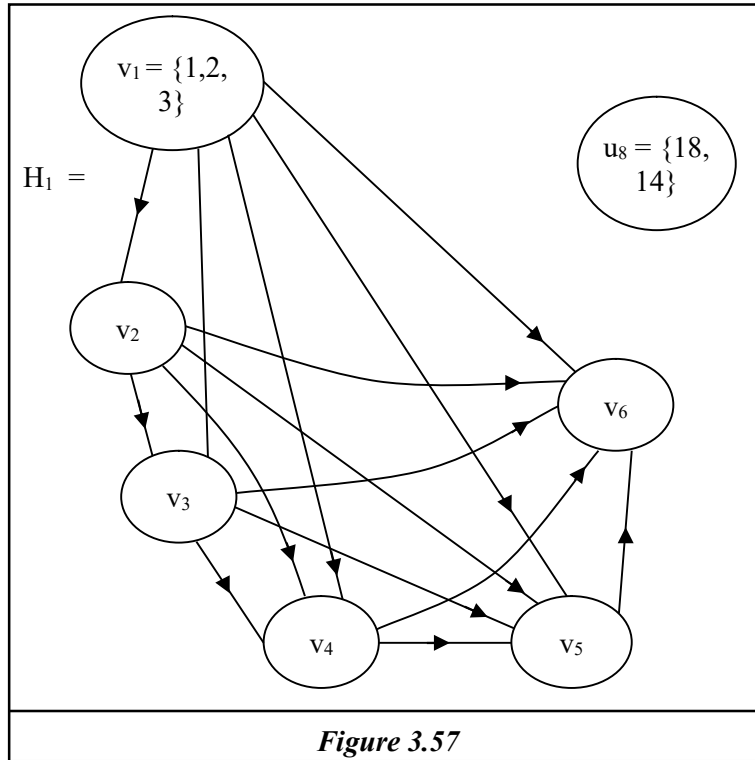

H_1 is a directed subset vertex subgraph which is disconnected has two components one is just a complete subset vertex subgraph of order six and other is just a vertex subset $u_8 = \{18, 14\}$.

Now we find $H_2 = G \setminus \{\overline{v_1 v_8}\}$ given by the following figure.

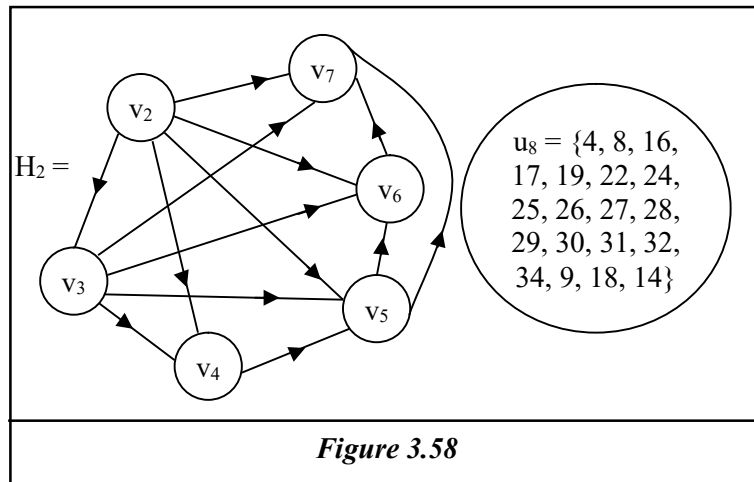

Figure 3.58

H_2 is a disconnected subset vertex subgraph with two components one is the complete directed subset vertex subgraph of order six other is just the vertex subset u_8 .

Let $H_3 \setminus \{\overline{v_4 v_5}\}$ be the edge subset vertex subgraph given by the following figure.

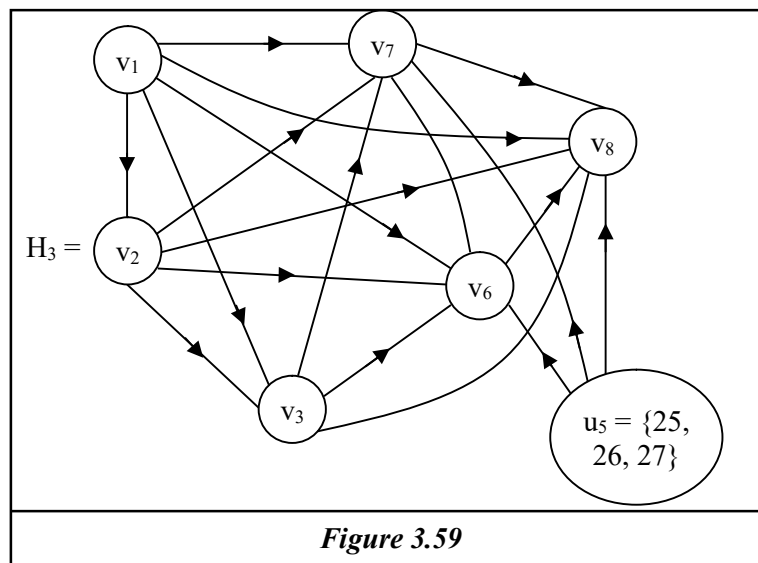
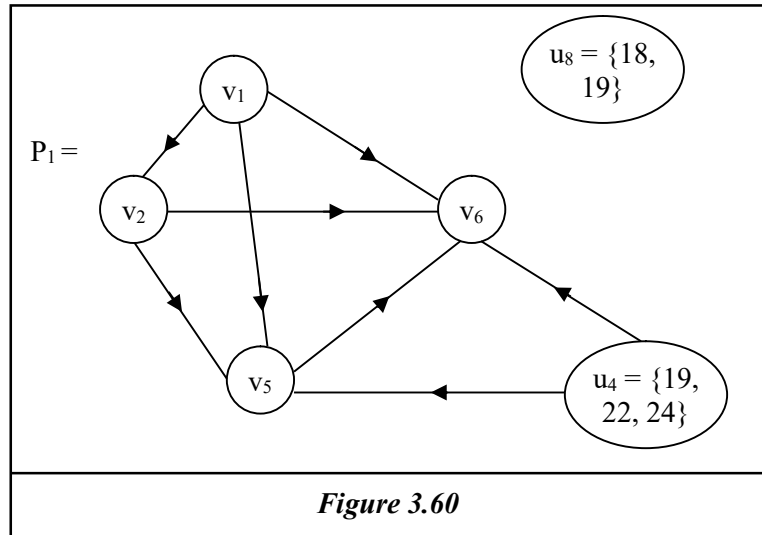

Figure 3.59

P_1 is a connected subset vertex multisubgraph of G which has a clique subset vertex subgraph of order 6.

Let $P_1 = G \setminus \{\overline{v_7v_8}, \overline{v_3v_4}\}$ be the edge subset vertex subgraph given by the following figure.



We see P_1 is also a disconnected subset vertex subgraph of G with two components a vertex subset subgraph and a vertex subset $u_8 = \{18, 19\}$. However, the big component has a clique of order four.

Let P_2 be the subset vertex subgraph; $P_2 = G \setminus \{\overline{v_4v_5}, \overline{v_6v_7}\}$ is given by the following figure.

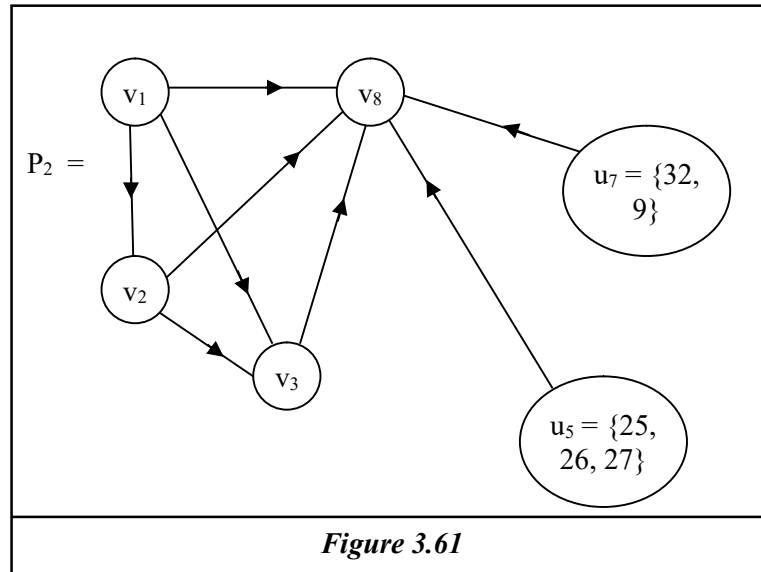
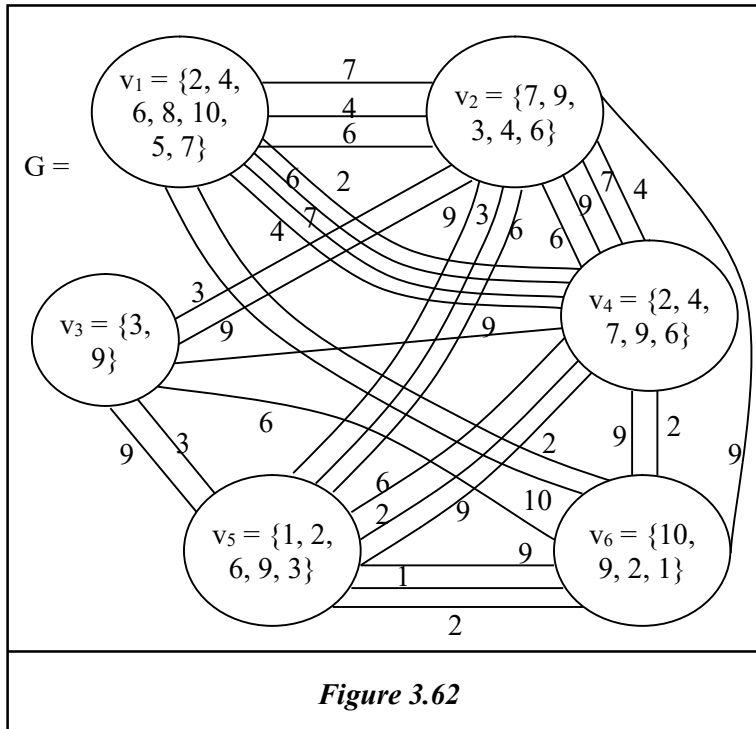

Figure 3.61

Clearly P_2 is a connected subset a vertex subgraph with a clique of order four.

Next we proceed onto study edge subset vertex multisubgraphs, that is subset vertex multisubgraphs when one or more edge is removed first by examples.

Example 3.12. Let G be a subset vertex multigraph for which both edges and vertex subsets are labeled. G is given by the following figure. The vertex subsets are from $P(Z_{11})$.



Suppose the edge with labeled 2 is removed from v_1v_5 the resulting figure H_1 is given by the following figure.

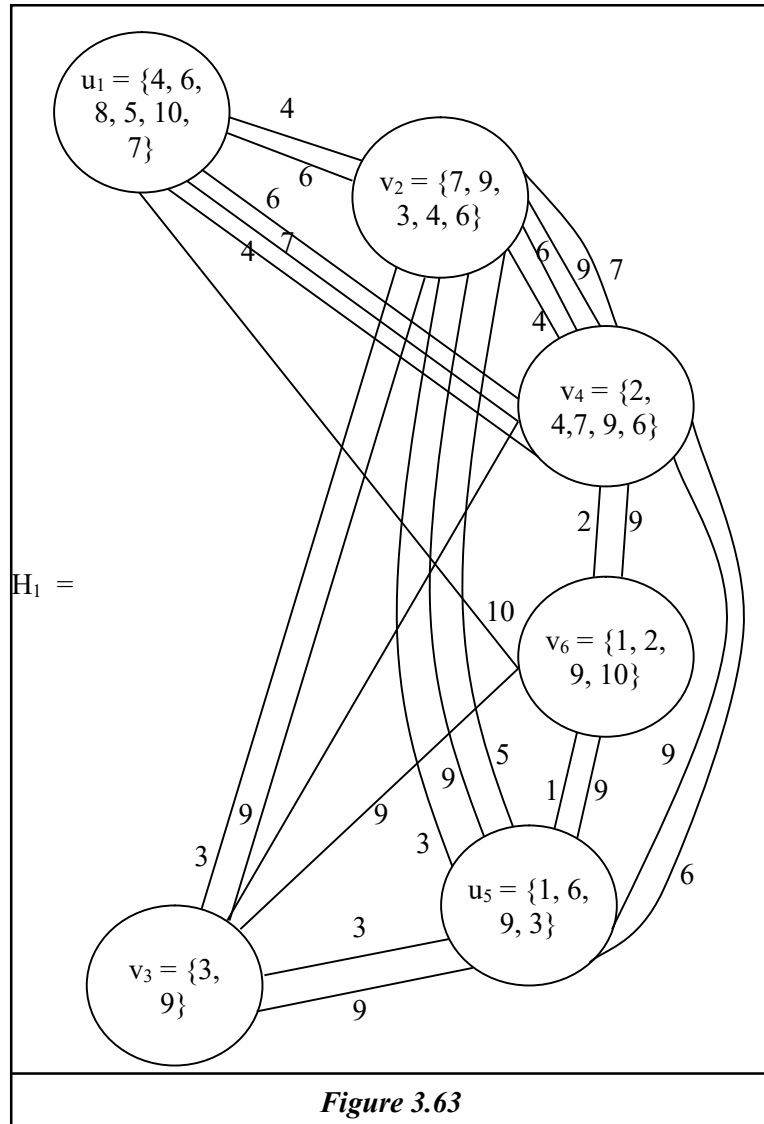

Figure 3.63

Though only one edge is removed several edges are removed from G in H_1 .

Suppose K be the subset vertex multigraph where the edge of labeled 6 from v_2v_4 and edge labeled 9 from edge v_3v_6 are removed K is given by the following figure.

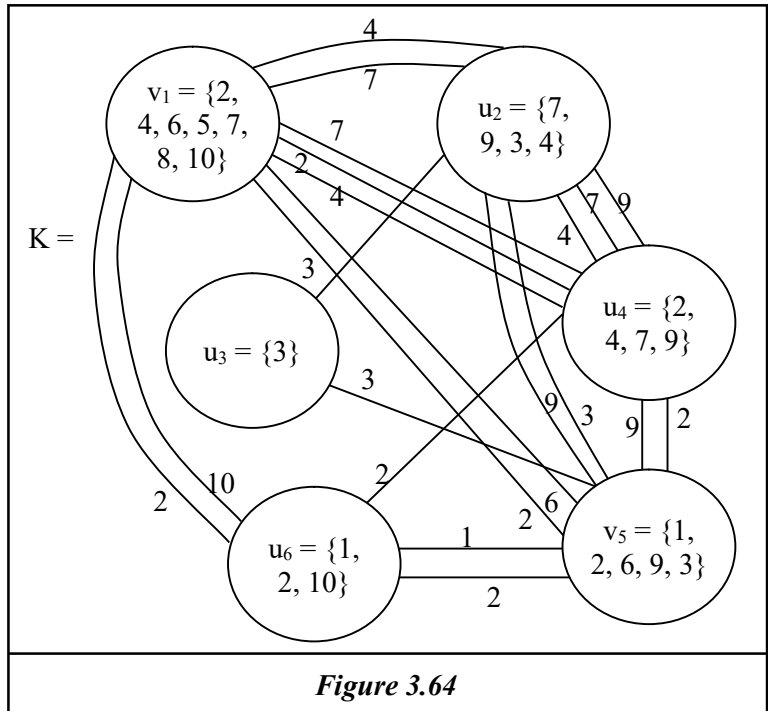

Figure 3.64

K got from removing 2 edges v_2v_4 and v_3v_6 labelled 6 and 9 respectively has lost many more edges.

Thus in case of subset vertex multigraphs G we cannot say a removal of one edge from G will not result in the edge vertex subset multisubgraph for which only one edge removed from G . Those subset vertex v_i and v_j is removed.

Suppose the edge $v_i v_j$ with label n is removed then the element n will be removed from v_i and v_j and all those edges

which are labeled n that are incident to v_i and v_j will also be removed.

If there is only one edge labeled n which are incident to both v_i and v_j and no edge labeled n is incident with either v_i or v_j then the number of edges removed will be only one from G in other cases the number of edges will be more.

This situation is described by the following example.

Example 3.13. Let G be a subset vertex multigraph given by the following figure with vertex subsets from the power set $P(S)$ where $S = Z_{18}$.

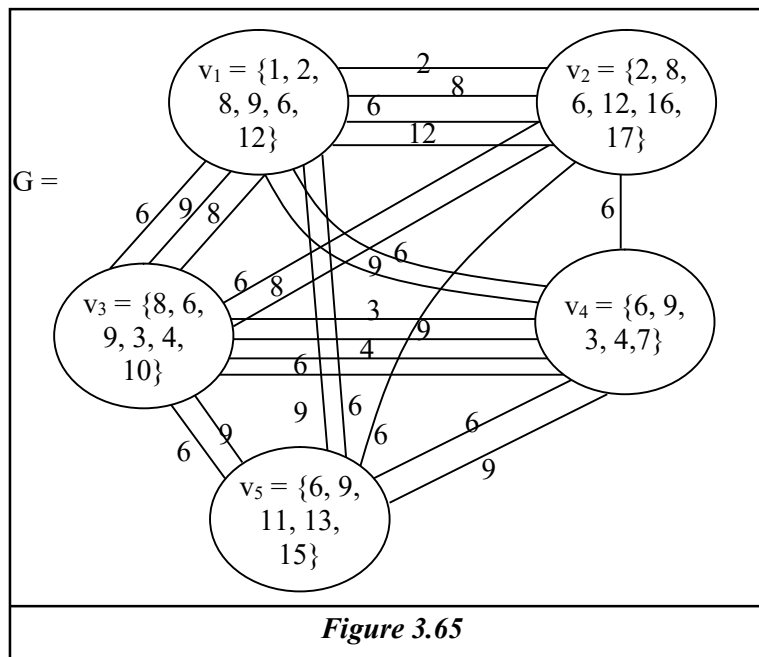

$H_1 = G \setminus v_1v_2$ the edge labeled 2 is removed.

We see H_1 is a subset vertex multisubgraph of G got from G by removing the edge labeled 2 and all other edges and nodes remain intact.

Thus we see the element 2 is present only in v_1 and v_2 so there is no edge with label 2 incident to v_1 and v_2 other than one edge from v_1 to v_2 .

Suppose the edge labeled 6 is removed from v_3 to v_5 let $H_2 = G \setminus$ edge labeled 6 from v_3 to v_5 is removed. The resulting subset vertex multisubgraph is described below.

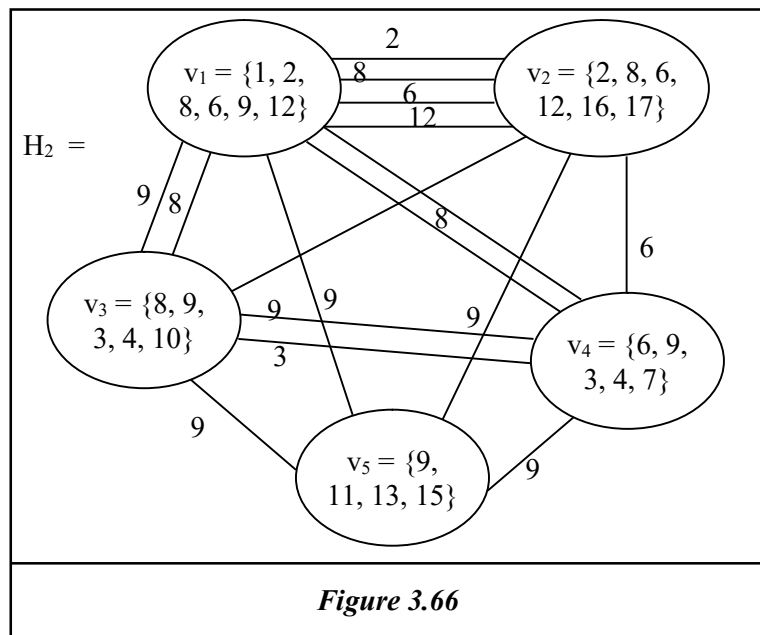

We see if one edge labeled 6 is removed from v_3 to v_5 from G then automatically 7 edges are removed from G in the resulting subset multisubgraph H_2 which clearly shows the other extreme case.

For G is a quasi complete subset vertex graph.

In view of all these are prove the following theorem.

Theorem 3.4. *Let S be a set $P(S)$ the power set of S . Let G be a quasi complete subset vertex multigraph with vertex and edge labeled and vertex subsets $v_1, v_2, \dots, v_n \in P(S)$.*

- i) *The 1 edge subset vertex multisubgraph H of G is such that one edge is removed from G if and only if that edge say $v_i v_j$ and labeled as t then $t \notin v_k$ for any $1 \leq k \leq n, k \neq i$ or $k \neq j$.*
- ii) *If the 1 edge subset vertex multisubgraph K of G is such that K in G in which $2n - 3$ edges are lost then each v_i has the element s where edge from v_i to v_j is labeled by s which is removed and conversely.*

Proof: Given $P(S)$ is the power set of the set S . G is a subset vertex multigraph with vertex subsets $v_1, v_2, \dots, v_n \in P(S)$. Recall if two vertex subsets v_i and v_j have x_1, x_2, \dots, x_t as common elements then there are t edges from v_i to v_j or equivalently v_j to v_i as G is not a directed multigraph labeled as x_1, x_2, \dots, x_t .

Proof of (i) Let G be the subset vertex multigraph and $v_i v_j$ be that subset vertex of G such that there is an edge labeled t from v_i to v_j and t is not in any of the other subset vertices of G . Let $H = G \setminus \{\text{edge labeled } t \text{ from } v_i \text{ to } v_j\}$; that is the edge labeled t connecting $v_i v_j$ is removed from G .

Now resulting 1 edge subset vertex multisubgraph H of G is different from G , only by the edge labeled t .

Suppose K be a 1 edge subset vertex multisubgraph of G got by removing one edge labelled m from v_p to v_s and G and K are different from each other only by the edge labeled m from v_p to v_s ($p \neq s$). To show none of the other vertices v_l ; $l \neq p, l \neq s$; $1 \leq l \leq n$ has the element m in the vertex subsets v_l .

On the contrary if there is a vertex subset v_r , $r \neq p$; $r \neq s$ such that $m \in v_r$ then by the definition of subset vertex multigraphs the subset vertex multigraph G must have an edge labeled m from v_r to v_p and another edge labeled m from v_s to v_r . When the edge labeled m is removed from $v_p v_s$ automatically the edges labeled m from $v_p v_r$ and $v_s v_r$ will be removed amounting to the removal of at least 3 edges from G a contradiction to our assumption. Hence the claim.

Proof of (ii) Given G is a subset vertex quasi complete multigraph with n vertices K is a 1 edge subset vertex multisubgraph of G in which any one edge from G is removed then this multisubgraph K is different from G and in $K = G \setminus \{2n - 3\}$ edges.

So removal of one edge in G results in a multisubgraph of G which loses $2n - 3$ edges.

To prove that there is one common element in all v_i 's; $1 \leq i \leq n$. We see if the element labeled say q is present in all vertices then we have an edge labeled q incident to all vertices so if that edge is removed say from v_i and v_j that is q labeled edge $v_i v_j$ is removed we see $v_i \setminus q = u_i$ and $v_j \setminus q = u_j$ and rest of

the vertices remain the same however from the vertex set v_i and v_j there are $(n - 1)$ edges labeled q incident to both of them so when q is removed from $v_i v_j$ all the $2n - 3$ edges are removed from G . Hence the claim.

Conversely if an element is in every v_i that is $q \in \cap v_i$ then we see if the edge with label q is removed from G and that $G \setminus v_i v_j$ ($i \neq j$) then all other $2n - 3$ edges labeled q are automatically removed from G hence the claim.

Note: As the very labeling of edges in subset vertex multigraphs are done according to the elements present in the vertex subsets of $P(S)$, power set of the set S .

However we wish to record that removing edges from the directed subset vertex multigraphs happens to be entirely different.

We will illustrate this situation by an example or two. First we work for a subset vertex graph.

Example 3.14. Let G be a directed subset vertex graph with vertex subsets $v_1, v_2, \dots, v_6 \in P(S)$. $P(S)$ the power set of $S = Z_{19}$ given by the following figure.

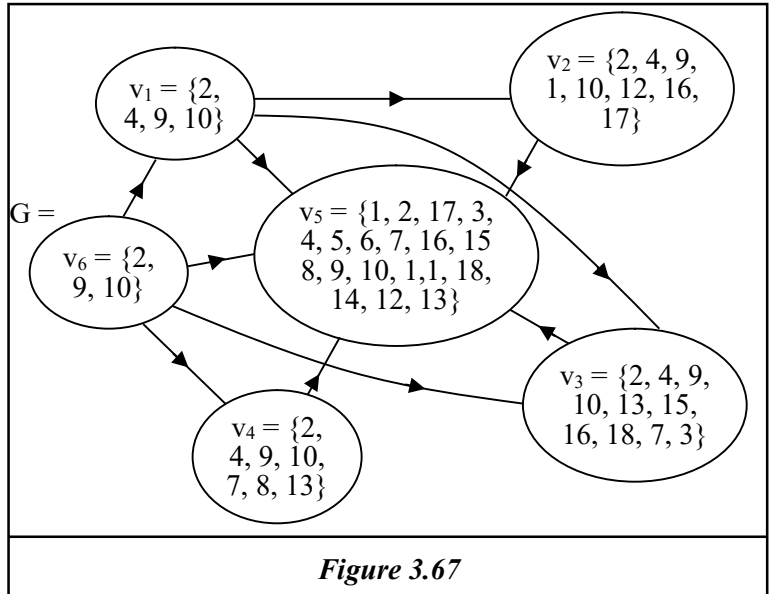

Suppose the edge $\overrightarrow{v_1 v_5}$ is removed from G , let $H_1 = G \setminus \overrightarrow{v_1 v_5}$ be the subset vertex subgraph given by the following figure.

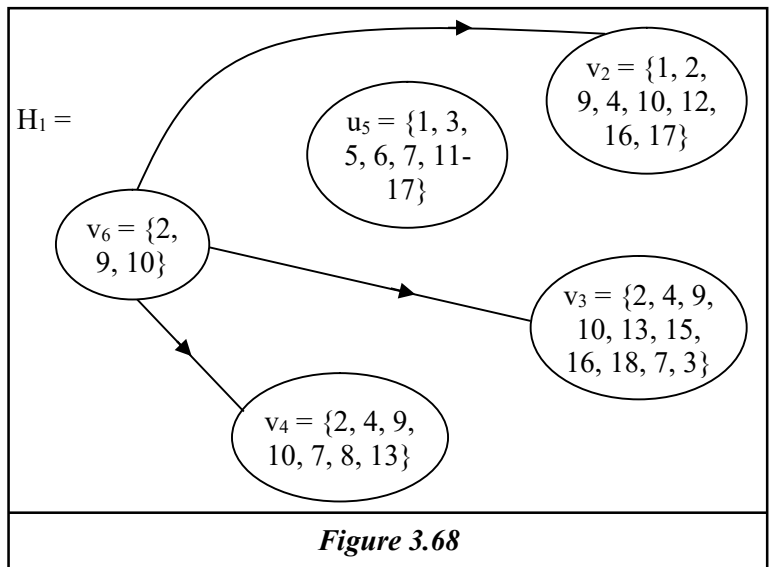

H_1 is a disconnected directed subset vertex subgraph with two components and has only three edges and 5 subset vertices.

Now let $H_2 = G \setminus \{\overrightarrow{v_6 v_3}\}$ given by the following figure.

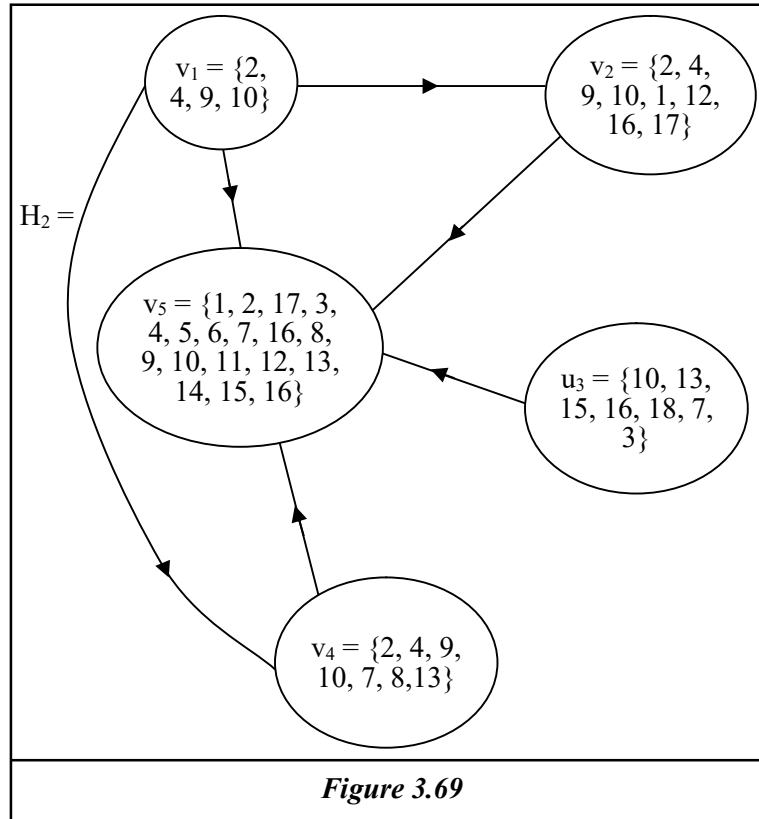

Clearly H_2 is a connected directed subset vertex subgraph with 5 vertex subsets.

Suppose $K_1 = G \setminus \{\overrightarrow{v_1 v_3}, \overrightarrow{v_6 v_5}\}$ be the subset vertex subgraph given by the figure.

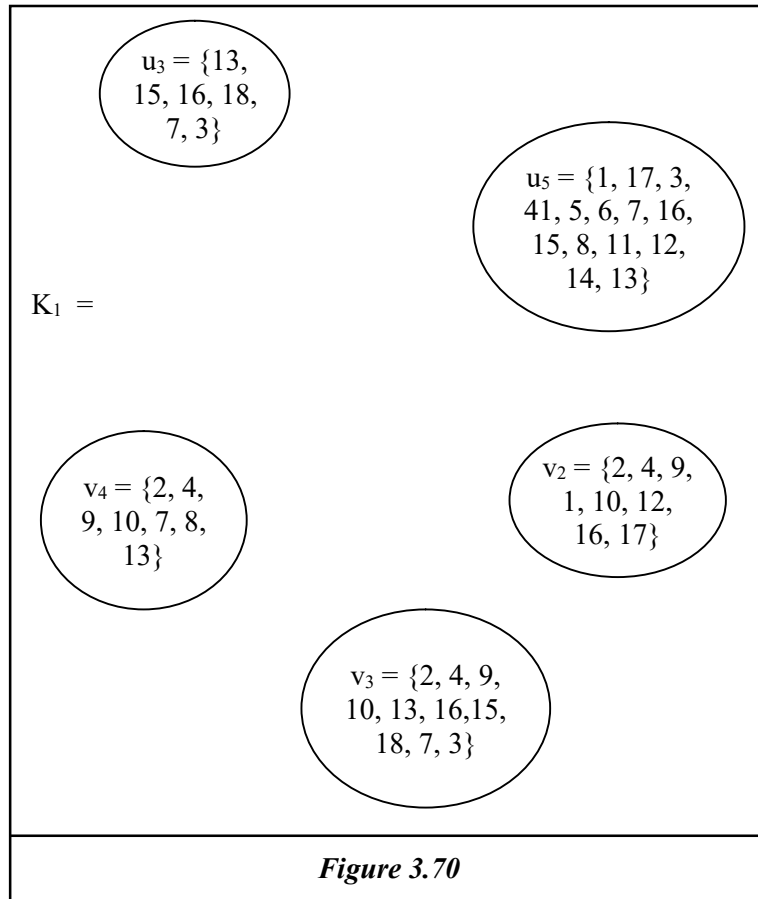

Clearly K_1 is a empty subset vertex subgraph of G with 4 vertex subsets. So even a removal of two edges in a directed subset vertex graph may make the subset vertex subgraph which is empty.

Study in the direction of directed multigraphs is interesting and innovative which will be described for the same directed subset vertex graph as directed subset vertex multigraph.

The G described in figure as a directed subset vertex multigraph M is as follows.

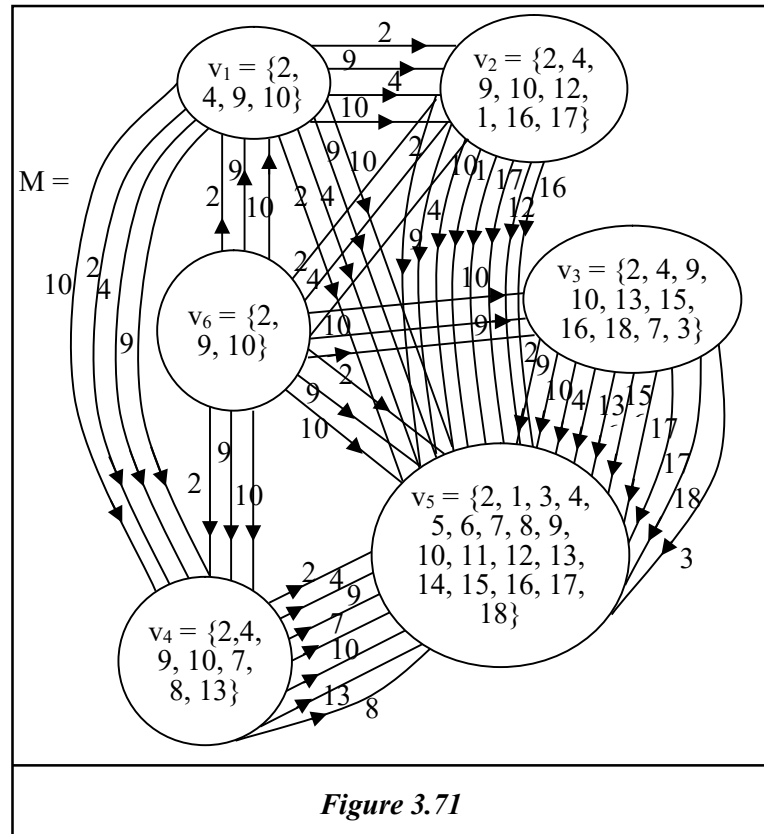

Here we just recall directed edges from v_i to v_j exists if $v_i \subset v_j$ and if $|v_i| = t$ we have t such edges from v_i to v_j and the edges are accordingly labeled.

Let $K_1 = G \setminus \{\text{edge labeled } 2 \text{ from } \overline{v_1 v_2}\}$, K_1 is given by the following figure.

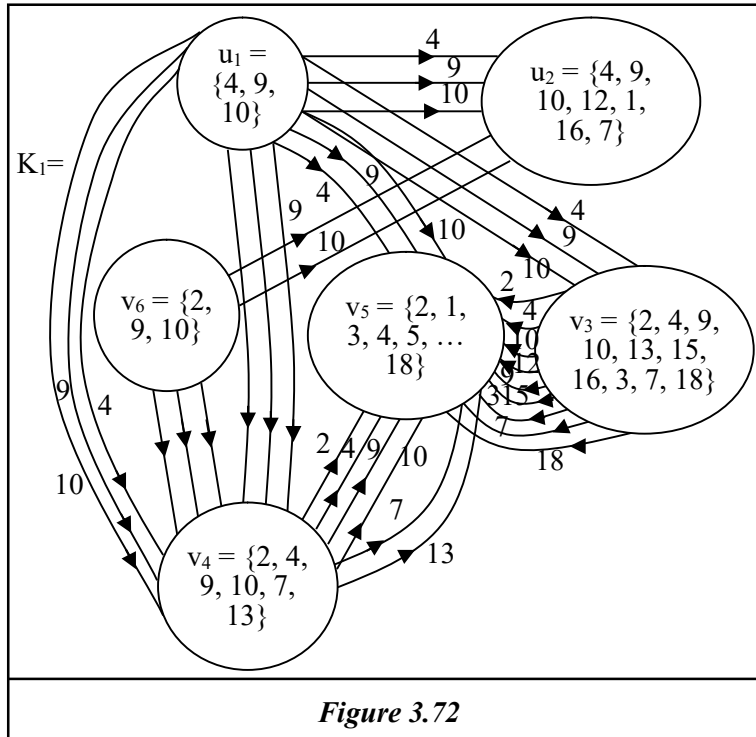

Figure 3.72

6 edges will be removed from G . Other labeled edges remain the same.

Suppose 2 labelled two edges are removed from v_1 to v_2 and v_1 to v_5 then we leave it as an exercise for the reader to find out the number of edges removed in the edge subset vertex multisubgraph $P = G \setminus \{\overline{v_1 v_2}$ and $\overline{v_1 v_5}$ labeled 2 $\}$.

We give another example of a directed subset vertex multigraphs given in the following.

Example 3.15. Let G be a directed multigraph given by the following figure.

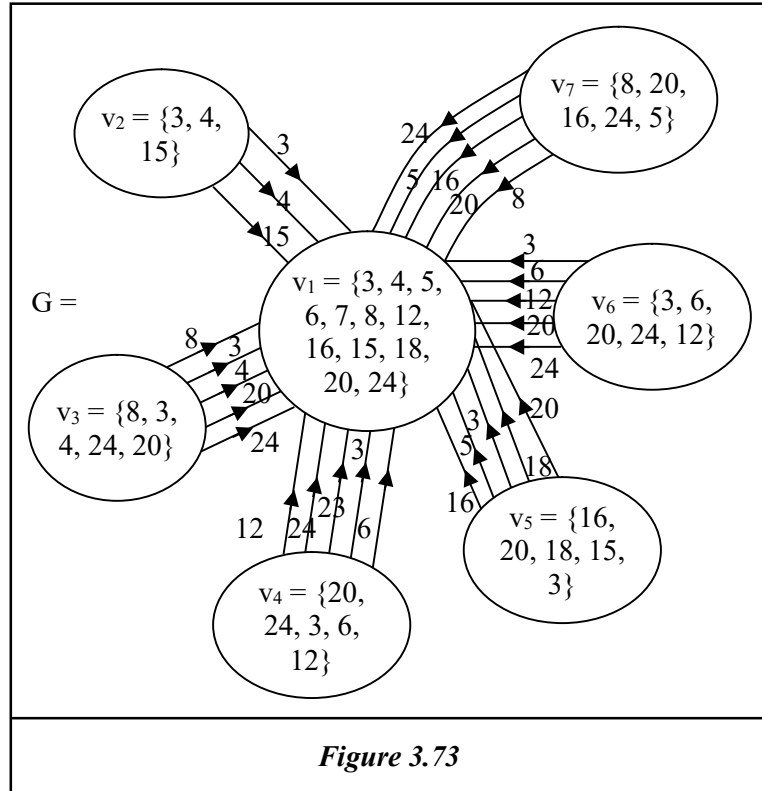

Suppose the v_2v_1 labelled 3 is removed from G . We get $H = G \setminus \overline{v_2v_1}$ given by the following figure.

The edge directed subset vertex multisubgraph is as follows.

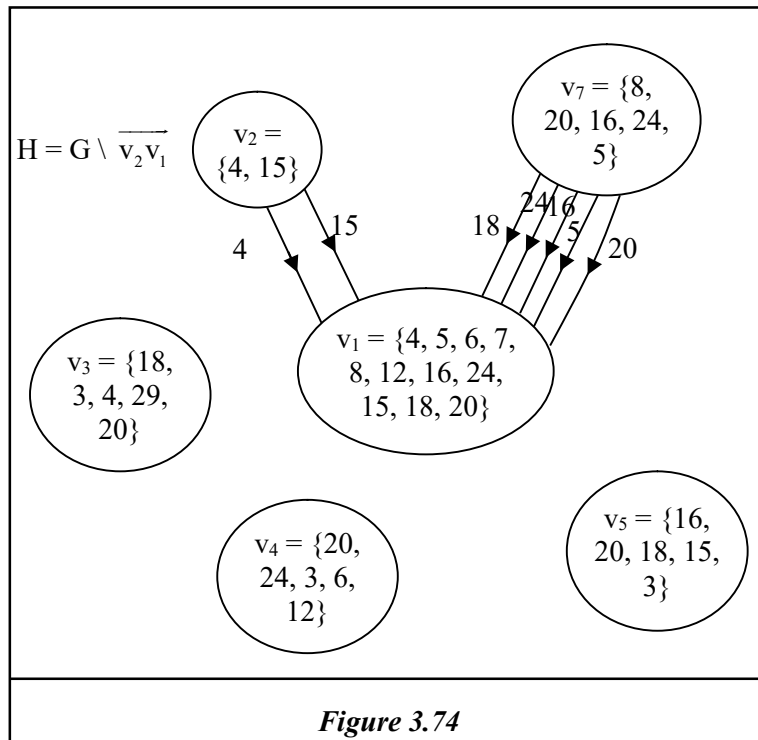

Clearly H is a 1-edge disconnected directed subset vertex multisubgraph of G it has four components 5 are just vertex subsets and one of them is a directed subset vertex multisubgraph and the remaining four are just vertex subsets.

We now proceed onto describe the those subset vertex multigraphs directed which are trees and the structure enjoyed by these edge subset vertex multisubgraphs by some examples.

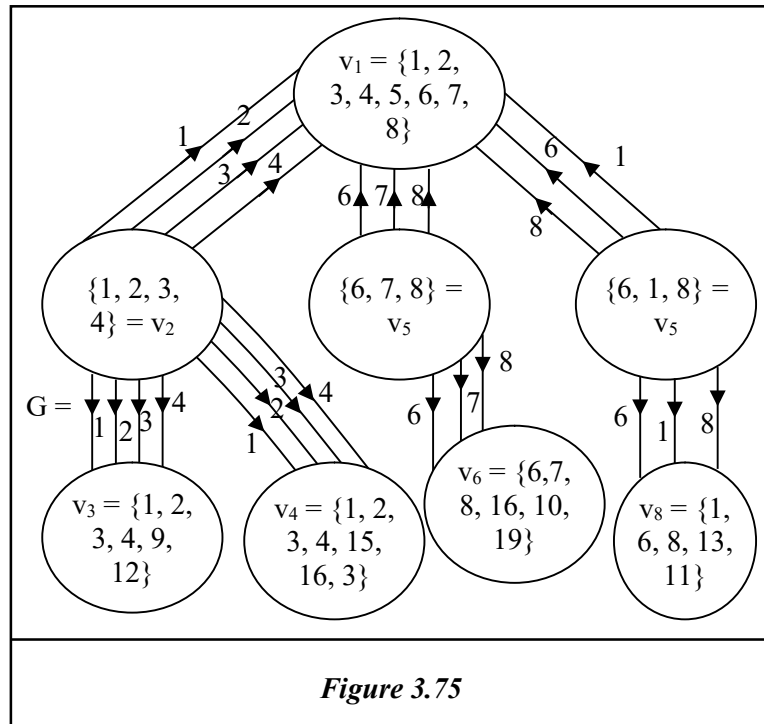

Let H be a edge subset vertex multisubgraph of G from which all edges labeled 6, 8 and 8 are removed. The figure of H is follows.

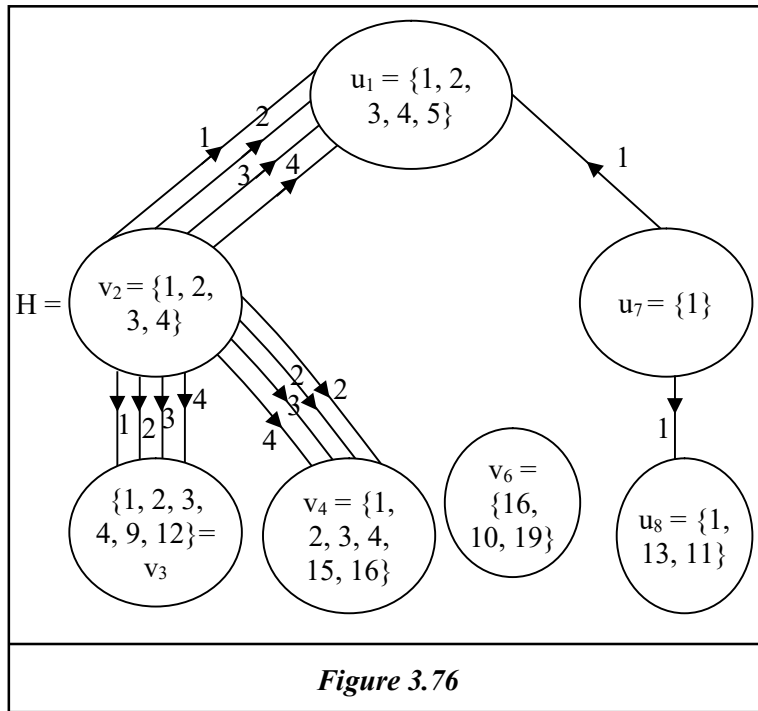

Clearly H is disconnected and has two components the big component is a tree whereas the other is just a subset vertex.

Let K be the edge subset vertex multisubgraph got from G by removing all the edges labeled 1, 2, 4, 6 and 8. K is given by the following figure.

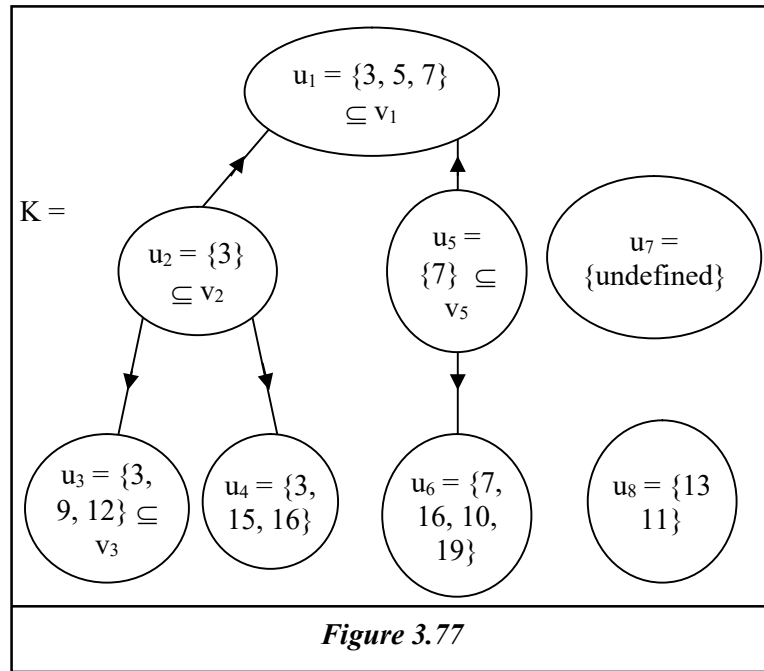

So K is not defined as the vertex subset difference cannot be put as ϕ .

So we see only under certain conditions the edge - subset vertex multisubgraph will exist.

We will some examples we substantiate this situation.

Example 3.16. Let $S = \mathbb{Z}_{36}$ and $P(S)$ the power set of S . G be a subset vertex multigraph given by the following figure.

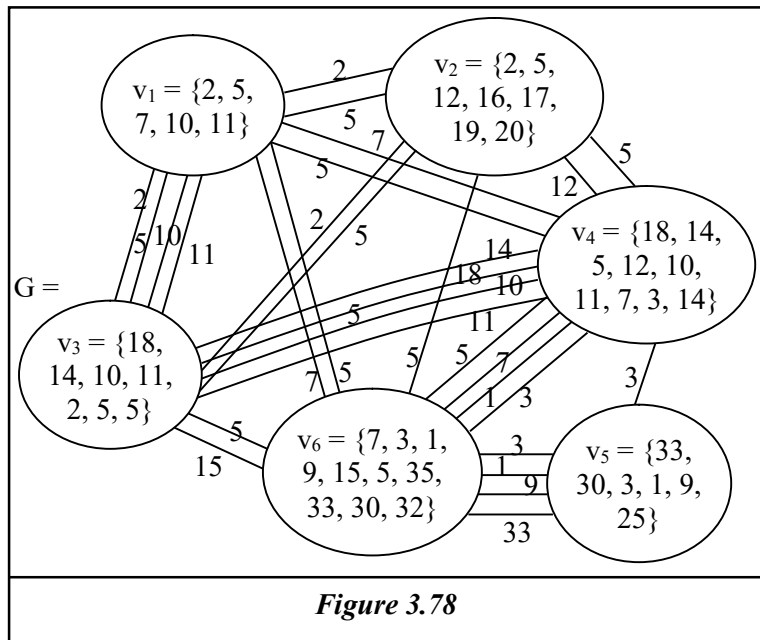
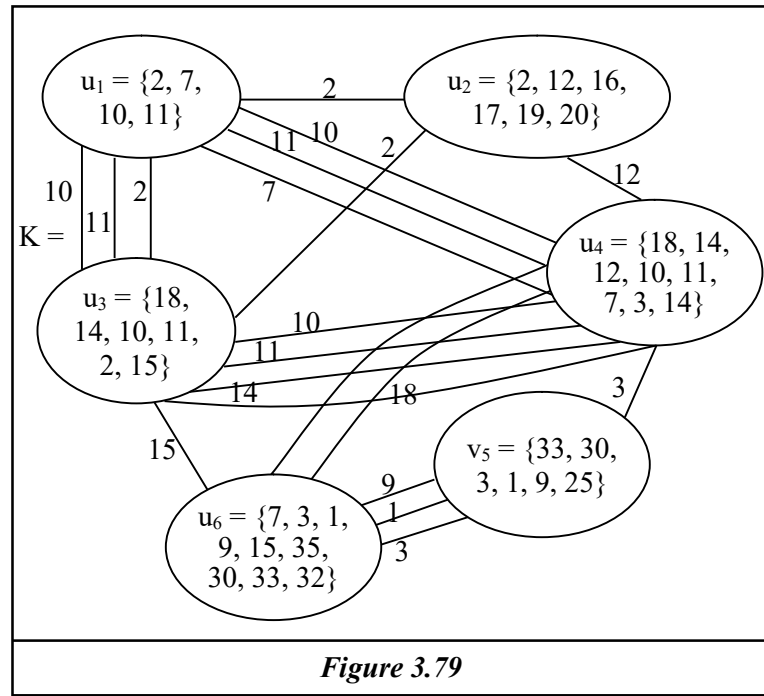

Figure 3.78

Let K be the edge subset vertex multisubgraph for which all edges labeled 5 are removed from G . K is given by the following figure.



We see both G and K are pseudo complete edge subset vertex multisubgraph. We see this K can also be realized as special subset vertex multisubgraph of G .

Suppose multigraph for which all the edges labeled 2 and 5 are removed, is given by the following figure.

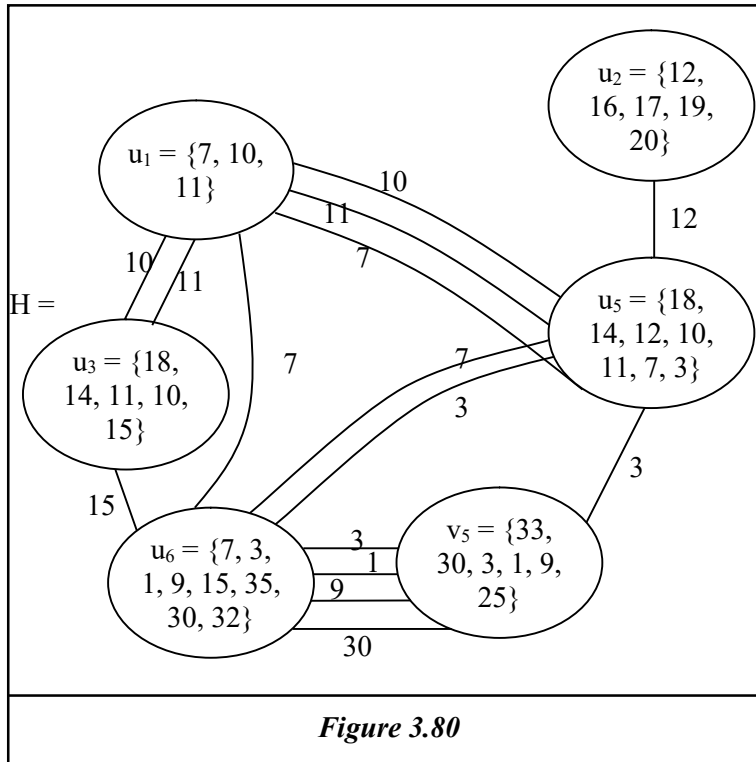

Figure 3.80

Clearly H is not pseudo complete subset vertex multisubgraph of G.

One of the natural conjectures is given in the following.

Conjecture 3.1. Let $S = \{Z_n\}$; $2 < n < \infty$ be a set of order n (Z_n is used mainly to avoid suffixes) or any set of order n. $P(S)$ be the power set of S. Let G be a subset vertex edge labeled and vertex labeled multigraph with m subset vertices which is complete or pseudo complete.

- i) What is the minimal number of labeled edges that should be removed from G so that G is an empty multigraph?

- ii) What is the minimum number of labeled edges removed so that the multigraph loses its capacity to be complete or pseudo complete.
- iii) The maximum number of labeled edges that can be removed and still it will remain to be complete or pseudo complete?

It is important and interesting to record that subset vertex multigraphs which are not directed but both edge and vertex labeled happens to give edge subset vertex multisubgraphs most of which are special subset vertex multisubgraphs provided there are several multiedges. Study in this direction is innovative interesting and also difficult.

Further these multigraph can have their edges labeled as triples in case they are entries from Single Valued Neutrosophic Sets(SVNS), quads in case of Fuzzy Complex Neutrosophic valued sets and so on [].

Will these multiedges also transform the structure into multistructures or multigraphs.

Study in this direction is made in the final chapter of this book.

Finally, we see in case of directed subset vertex multigraphs the situation works in an entirely different way.

Many a times removal of certain multiedges makes the multisubgraphs empty.

When we work with directed labeled subset vertex multigraphs the removal of one edge may affect the entire structure of the multigraph.

To this effect we have provided several examples.

Example 3.17. Let G be a labeled subset vertex multigraph of type II given by the following figure.

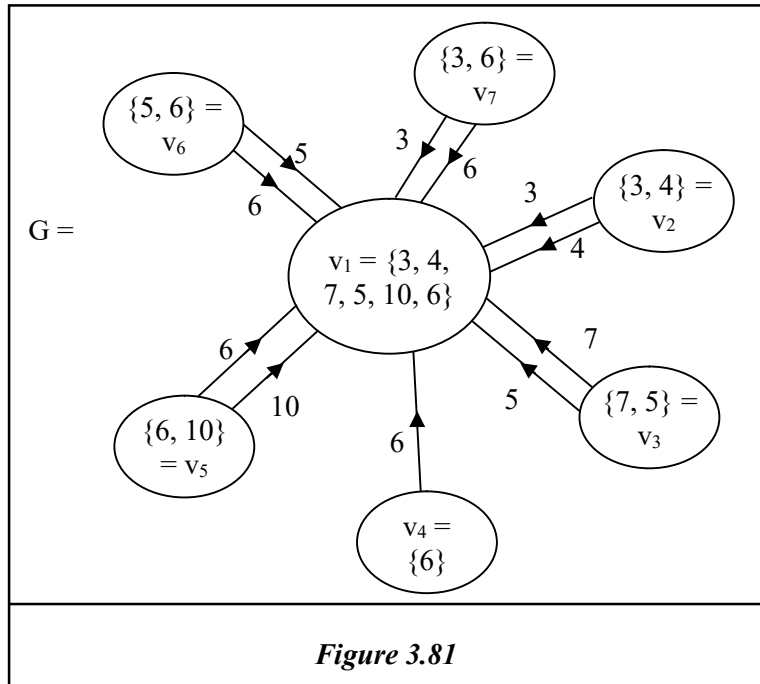

Let $G = K \setminus \{ \overline{v_4 v_1} \text{ with edge labeled } 6 \}$ The edge directed subset vertex multisubgraph K of G is given by the following figure.

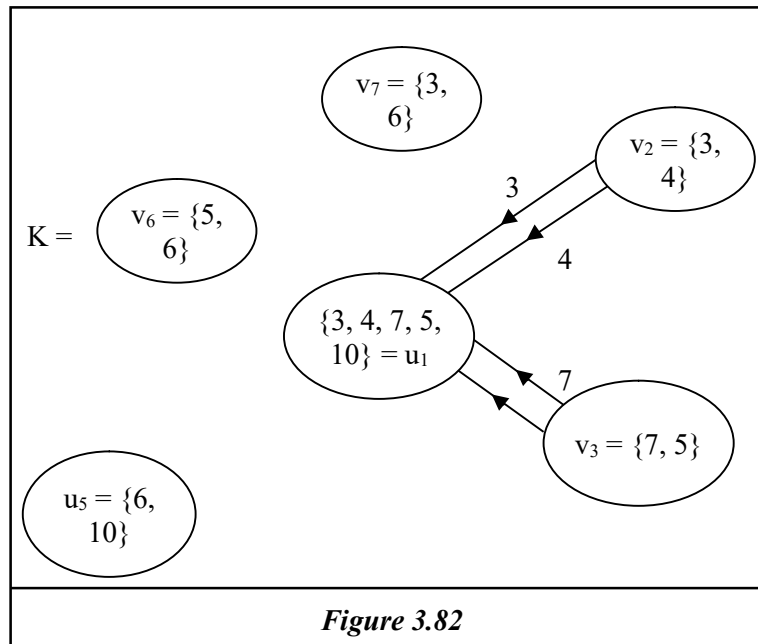

We see K is a disconnected directed subset vertex multisubgraph with four components.

Example 3.18. Let G be a directed subset vertex multigraph given by the following figure.

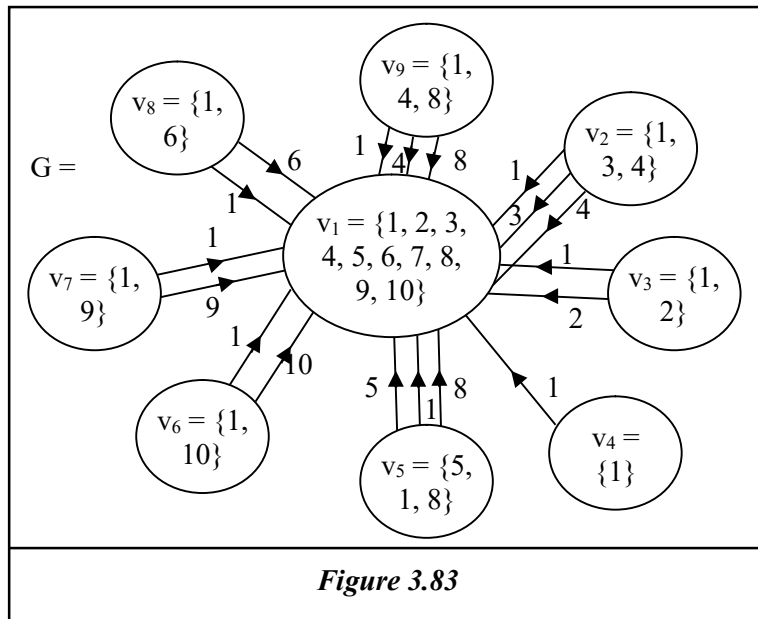

The edge labeled 1 from $\overline{v_2 v_1}$ is removed from G , let K be the resulting multigraph given by the following figure.

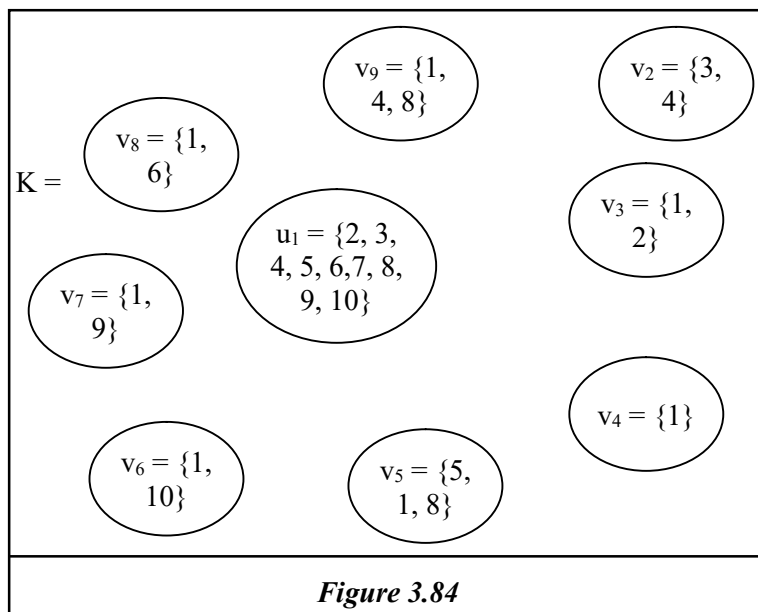

Clearly just by a removal of one edge the resulting edge directed subset vertex multisubgraph becomes empty.

Now if we take the same vertex subset draw the multigraph of type I and remove only one edge we see the configuration is different the same G_1 the vertex subset multigraph with vertex set v_1, v_2, \dots, v_9 is as follows.

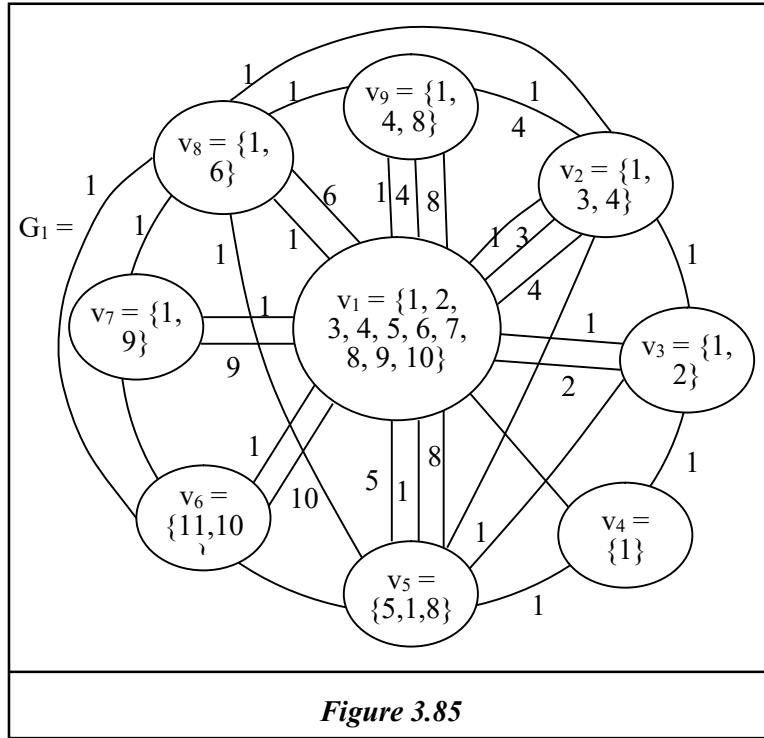

$H = G \setminus \{v_1v_4\}$ the edge subset vertex multigraph is as follows.

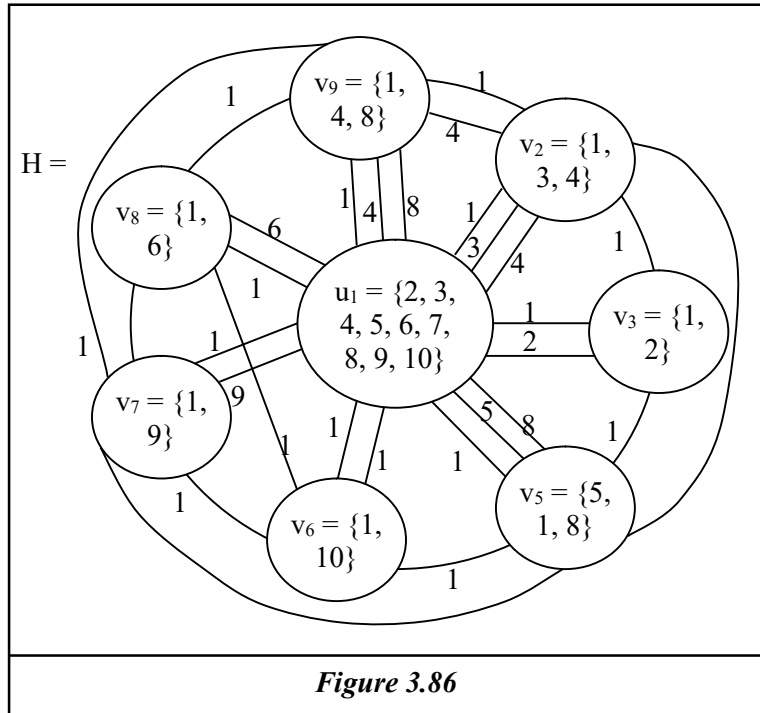

We have not completed both G and K multigraphs with 9 and 8 vertices respectively structure is preserved. The reader is assigned the task of completing them.

We suggest the following problems so that the reader becomes familiar with this new concept.

Problems

1. Bring out the difference between the edge-subset vertex subgraphs and just subset vertex subgraphs.
2. What are the conditions on the vertex subsets under which in a edge subset vertex subgraph H of G when one edge is removed several edges are removed?

3. Find for the following subset vertex graph G , all edge subset vertex subgraphs.

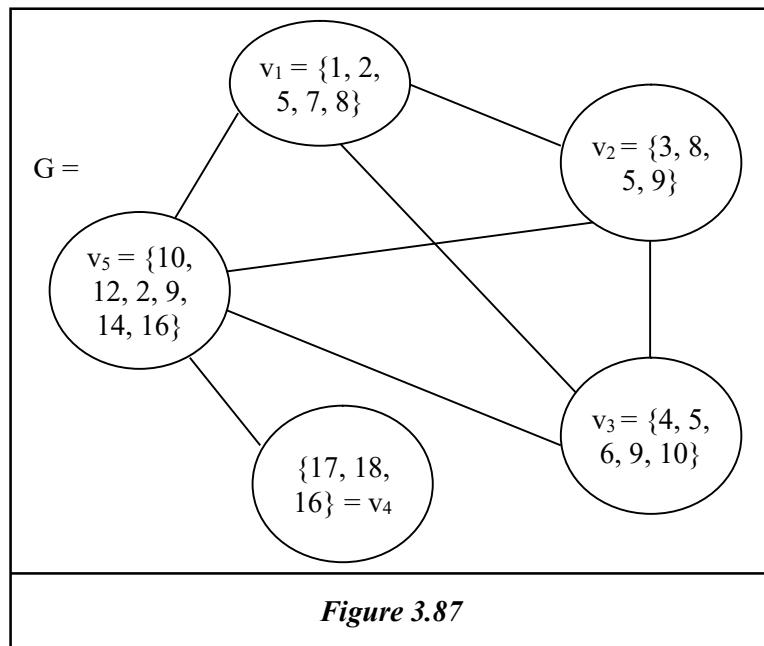

4. There $v_1, v_2, \dots, v_5 \in P(S)$ where $S = Z_{27}$. For the subset vertex graph given in problem 3 find all subset vertex subgraphs which are neither edge subset vertex subgraphs nor vertex subset vertex subgraphs.
5. How is a directed vertex subset graphs behave when edges are removed?
Is it like type I subset vertex graphs?
6. Compare the edge subset vertex subgraphs in case of directed subset vertex graphs with just subset vertex graphs. Illustrate by an example.

Let G be a subset vertex graph with vertex set v_1, v_2, v_3, v_4, v_5 and v_6 of type I.

Let H be the directed subset vertex graph using the same set of vertices $v_1, v_2, \dots, v_6 \in P(\mathbb{Z}_{27})$; the power set of \mathbb{Z}_{27} given by the following figures.

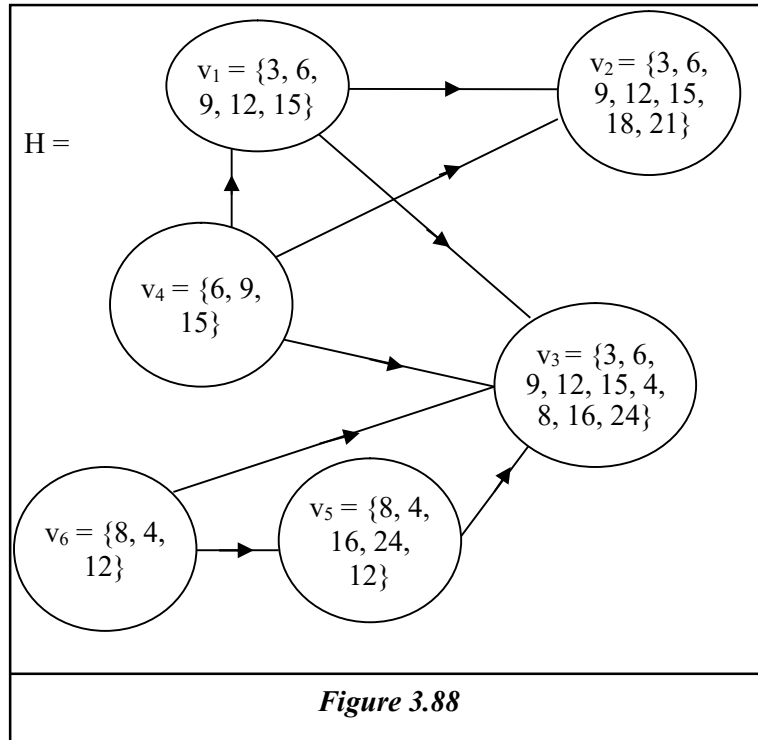

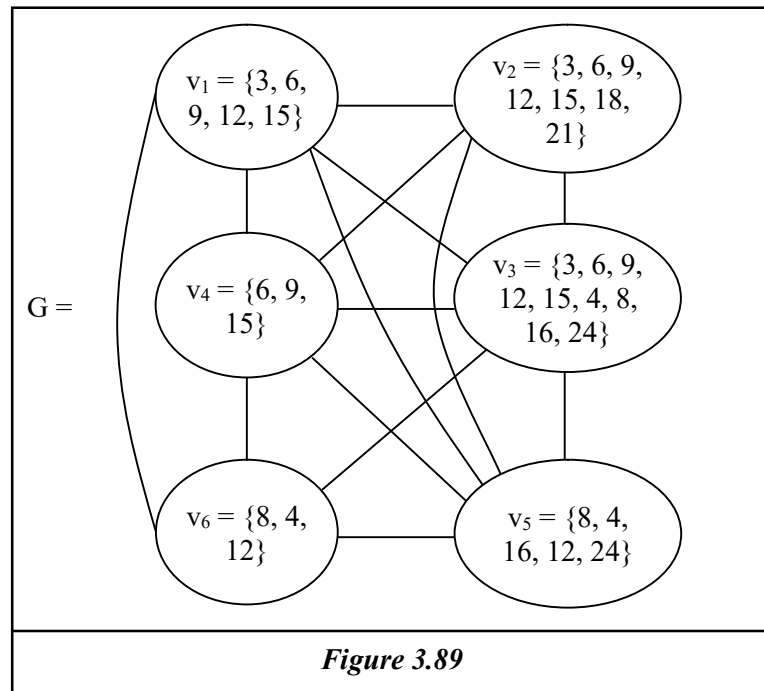

We see though both the subset vertex graphs have same set of vertices yet they have different structures for G is a complete subset vertex graphs however H is not a complete directed subset vertex graph.

- i) Find the edge subset vertex subgraphs $G \setminus v_1v_2$ and $H \setminus \overline{v_1v_2}$.
- ii) How many edge subset vertex subgraphs of G are empty?
- iii) Find all edge subset vertex directed subgraphs of H which are empty?
- iv) Find $K_1 = G \setminus \{v_6v_5, v_2v_3\}$ and compare it with $P_1 = H \setminus \{\overline{v_6v_5}\}$.

8. Does there exist any subset vertex graph G with vertex set v_1, \dots, v_n and H the directed subset vertex graph with same set of vertices v_1, v_2, \dots, v_n ?

Justify your claim or characterize your claim!

9. If we have a star subset vertex graph show it will not in general be a directed star subset vertex graph.
10. Let G be a subset vertex ring graph give by the following figure.

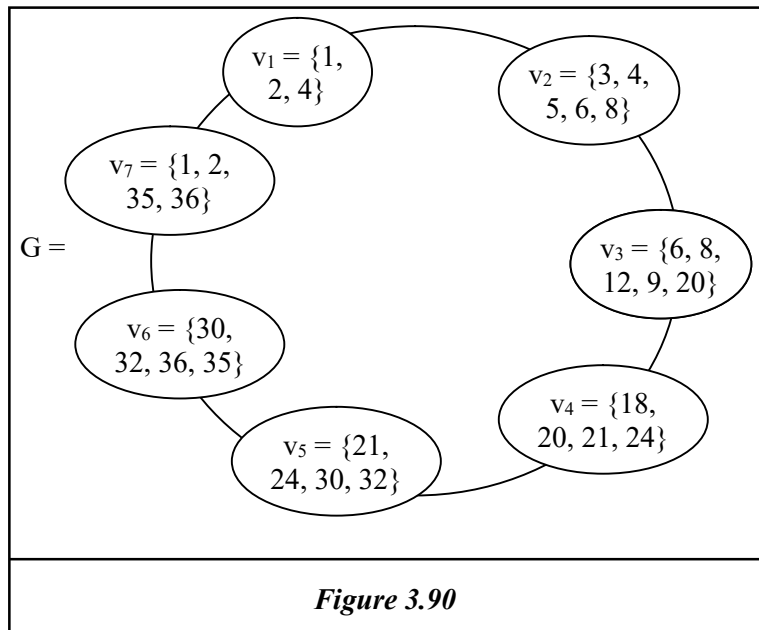

- i) If we try to get the directed subset vertex graph using v_1, v_2, \dots, v_7 as vertex subsets. What is its structure?
- ii) Find the following edge subset vertex subgraphs.
- a) $G \setminus \{v_1 v_2\}$

- b) $G \setminus \{v_1v_7, v_6v_5\}$
- c) $G \setminus \{v_4v_3, v_5v_4\}$
- d) $G \setminus \{v_3v_4, v_4v_5, v_5v_6\}$.

Compare these four edges subset vertex subgraphs with each other.

11. Find conditions on the vertex subsets of the ring vertex subset graph G so that the directed vertex subset graph with the same set of vertices is also a ring directed subset vertex graph.
12. When will a complete subset vertex graph also be a directed complete subset vertex graph?
13. Let G be a subset vertex graph with the vertex subset $v_1 = \{1, 2\}$, $v_2 = \{1, 2, 3, 4\}$, $v_3 = \{1, 3, 4, 2, 5, 6\}$, $v_4 = \{1, 2, 3, 4, 5, 6, 7, 8\}$, $v_5 = \{1, 2, 3, 4, 5, 6, 7, 8, 9, 10\}$ and $v_6 = \{1, 2, \dots, 12\}$.

If H is the directed subset vertex graph will H be complete? Justify your claim.

14. Let G be a subset vertex multigraph with labeled edge and vertex given by the following figure.

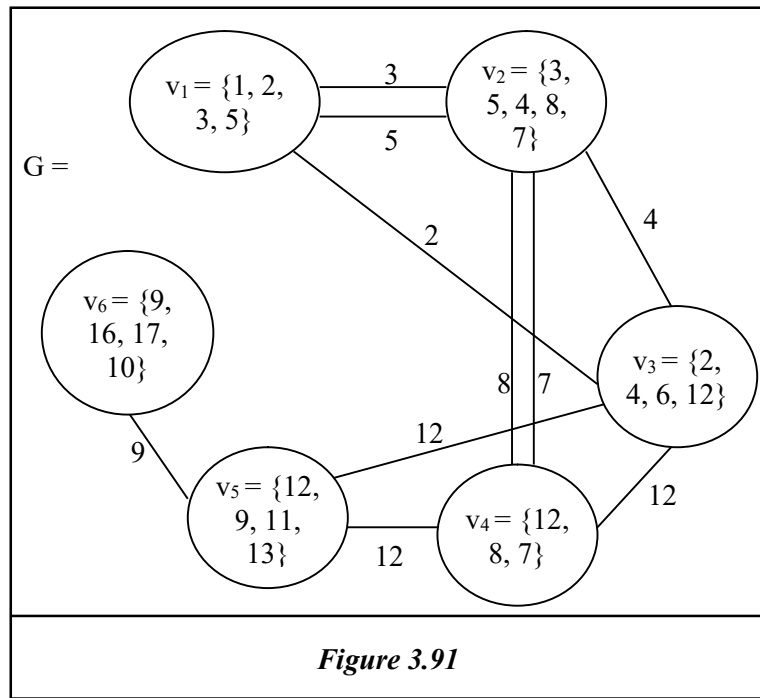

$v_i \in P(\mathbb{Z}_{18}), 1 \leq i \leq 6.$

- i) Find the edge subset vertex multisubgraph $K_1 = G \setminus \{v_1 v_2\}$ with only labeled edge 5 is removed.
- ii) Find $K_2 = G \setminus \{v_5 v_3 \text{ the edge labeled } 12\}$ is removed?
- iii) Compare K_2 with K_1 .
- iv) Characterize all those 1-edge subset vertex multisubgraphs.
- v) Find the directed subset vertex multigraph H using the vertices v_1 to v_6 of G it with H and compare.

15. For the following subset vertex multigraph G which is both edge and vertex labeled is given by the following figure.

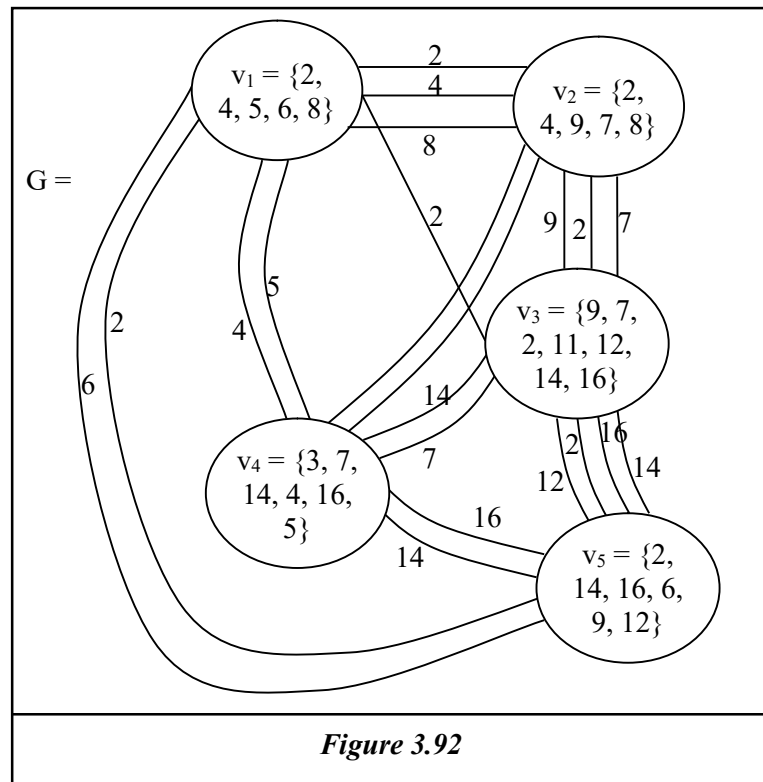

- a) Find the following edge - subset vertex sub multigraphs
- i) $G \setminus \{v_1v_2 \text{ with edge label } 2\}$
 - ii) $G \setminus \{v_2v_3 \text{ and } v_3v_5 \text{ with edge label } 2\}$
 - iii) $G \setminus \{v_2v_3 \text{ and } v_3v_5 \text{ with label } 2 \text{ and } 14 \text{ respectively}\}$
 - iv) $G \setminus \{v_1v_2 \text{ with label } 2 \text{ and } v_2v_4 \text{ with label } 7\}$

Compare these edges subset vertex multisubgraphs with each other.

b) What are the labeled edges that should be removed so that the edge subset multisubgraph becomes a empty multisubgraph?

16. Let $S = Z_{45}$ be a set with 45 elements labeled from 0 to 44. $P(S)$ the power set of S .

Let G_1, G_2, G_3 and G_4 be four directed subset vertex multigraphs which are both edge and vertex labeled given by the following figure.

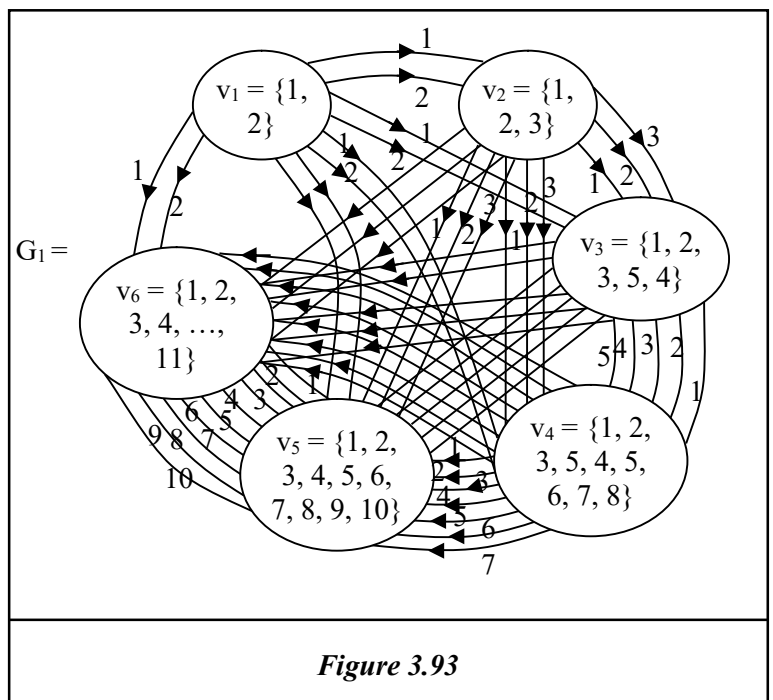

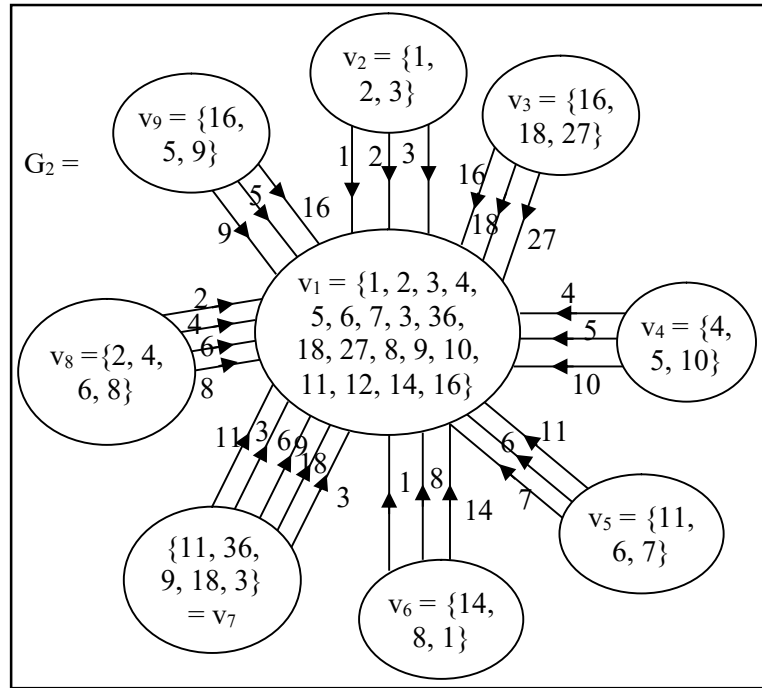

Figure 3.94

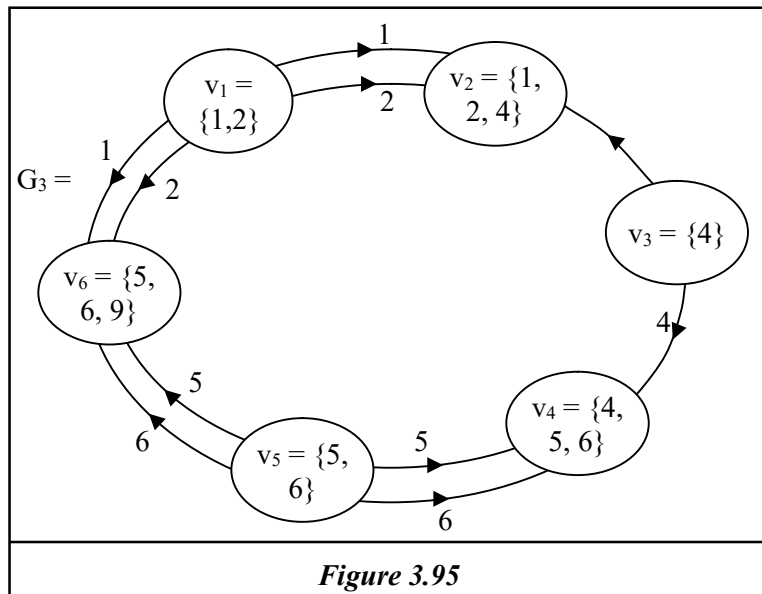

Figure 3.95

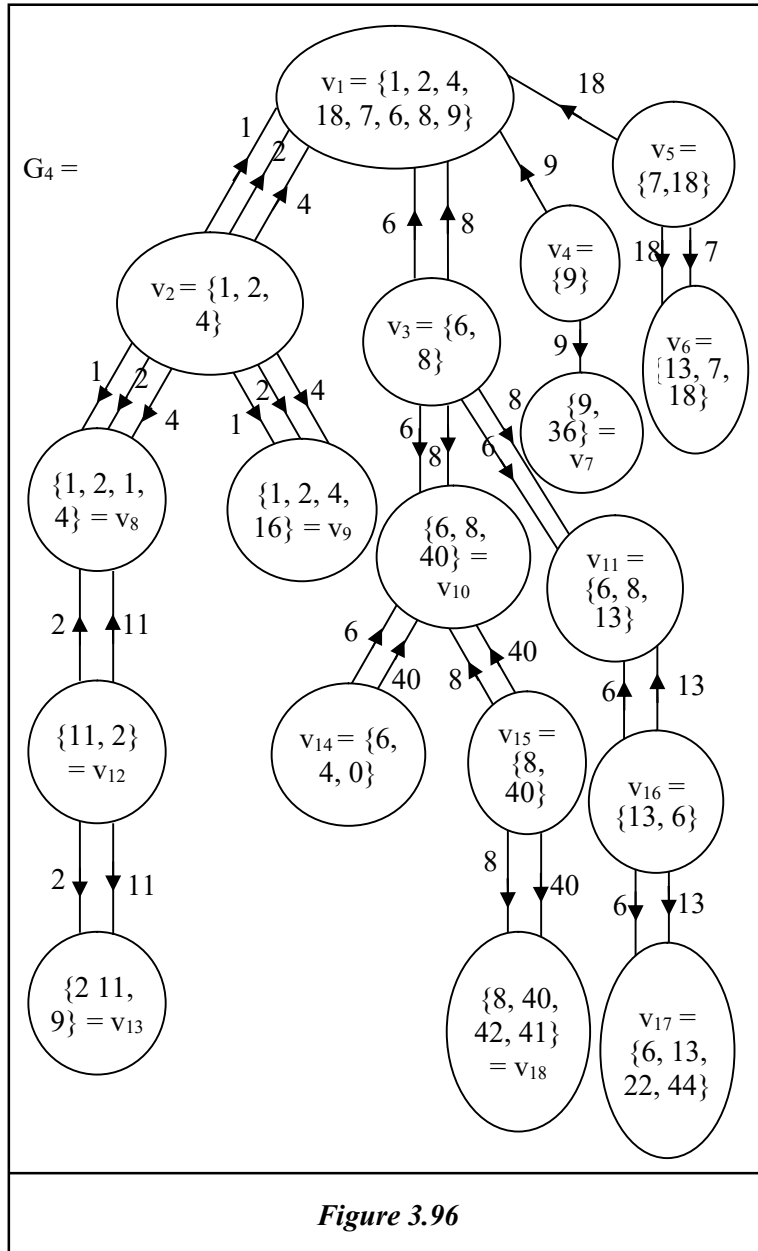
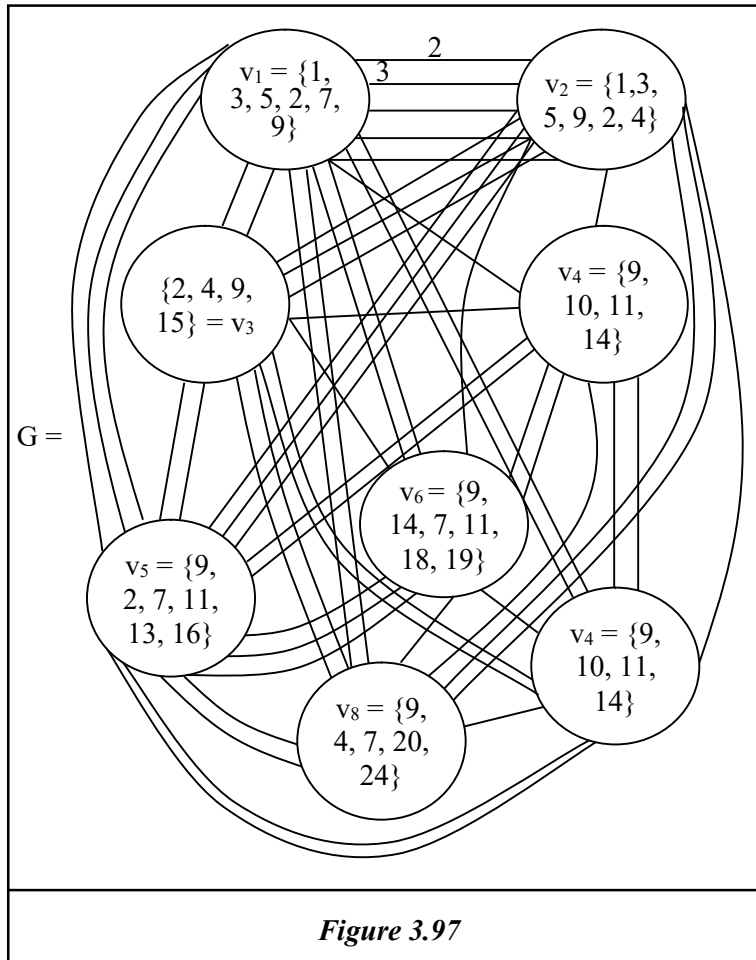

Figure 3.96

- i) Find corresponding to the directed labeled subset vertex multigraphs G_1, G_2, G_3 and G_4 find H_1, H_2, H_3 and H_4 subset vertex edge labeled multisubgraphs respectively taking the corresponding vertex subsets.
- ii) Find $K_1 = G_1 \setminus \{\overline{v_1 v_2} \text{ labeled } 2\}$ the edge subset vertex directed multi subgraph of G_1 .
- iii) Draw $P_1 = H_1 \setminus \{v_1 v_2 \text{ labelled } 2\}$, the edge subset vertex multisubgraph of H_1 .
- iv) Compare K_1 with P_1 in (ii) and (iii).
- v) Find $K_2 = G_2 \setminus \{\overline{v_2 v_1} \text{ the edge labeled } 1\}$ the edge directed subset vertex multisubgraph of G_2 .
- vi) Find $P_2 = H_2 \setminus \{v_1 v_1 \text{ the edge labeled } 1\}$, the edge subset vertex multisubgraph of H_2 .
- vii) Compare K_2 and P_2 in (v) and (vi) respectively.
- viii) Find $K_3 = G_3 \setminus \{\overline{v_1 v_2} \text{ labeled } 1\}$ the edge directed subset vertex multisubgraph.
- ix) Find $P_3 = H_3 \setminus \{v_1 v_2 \text{ labelled } 1\}$ the edge subset vertex multisubgraph.
- x) Compare K_3 with P_3 in (viii) and (ix) respectively.
- xi) Find $K_4 = G_4 \setminus \{\overline{v_2 v_1} \text{ with label } 2\}$ the edge subset vertex directed multisubgraph of G_4 .
- xii) Find $P_4 = H_4 \setminus \{v_1 v_2 \text{ the edge labeled } 2\}$ the edge subset vertex directed multisubgraph of H_4 .
- xiii) Compare P_4 and K_4 of xi and xii and find the number of edges in them.

17. Let G be the subset vertex multigraph with vertex subsets from $P(S)$ where $S = \{Z_{27}\}$ given by the following figure.



- i) How many edges (minimum) must be removed so that the multigraph G becomes disconnected? and label the edges of G .

- ii) Find the minimum number of edges that must be removed so that G loses the pseudo completeness.
 - iii) Does the directed subset multigraphs exists with the same set of subset vertices v_1, v_2, \dots, v_6 .
 - iv) Which labeled edge gives the connection to all nodes?
 - v) Find all edge subset vertex multisubgraph of G .
 - vi) Find the number in (v).
18. Find some suitable applications of subset vertex multigraphs.
19. Can subset vertex multigraphs be used in social networking?
20. List out the differences between directed subset vertex multigraphs and subset vertex multigraphs.
21. Can one claim subset vertex multigraphs of type I will be more powerful for easy retrieval of the multinet network than directed subset vertex multigraphs?
22. Can one prove if directed subset vertex multigraphs are used in social multinet networks then it is mandatory that a relational map (edges of $\overline{v_i v_j}$ exists only when one subset is fully contained in another $v_i \subset v_j$.
- i) What are the advantages of using them?
 - ii) What are the limitations?
 - iii) Compare type I and type II subset vertex multigraphs.

23. Give an example of a subset vertex multigraph of type I which is complete and uniform. What is its structure when they are converted to type II?
24. Give an example of an uniform directed subset vertex multigraph which is a uniform star graph with n vertex subsets.
 - a) What will be its structure if same vertex subsets are used for the type I multigraph?
 - b) Will it continue to be a uniform star subset vertex multigraph of type I? Justify.
25. Give an example of a subset vertex multigraph G of type II which is a ring / circle multigraph with vertex subset v_1, v_2, \dots, v_n .
 - a) Using the same set of vertices v_1, v_2, \dots, v_n draw the subset vertex multigraph R of type I.
 - b) Is R a circle subset vertex multigraph?
 - c) Find the conditions under which both G and R will be subset vertex circle multigraphs.
26. For what set of subset vertices will both the type I and type II multigraphs will be identical?
27. If problem (26) is true give one example.
28. Let G be a subset vertex multigraph of type II given by the following figure.

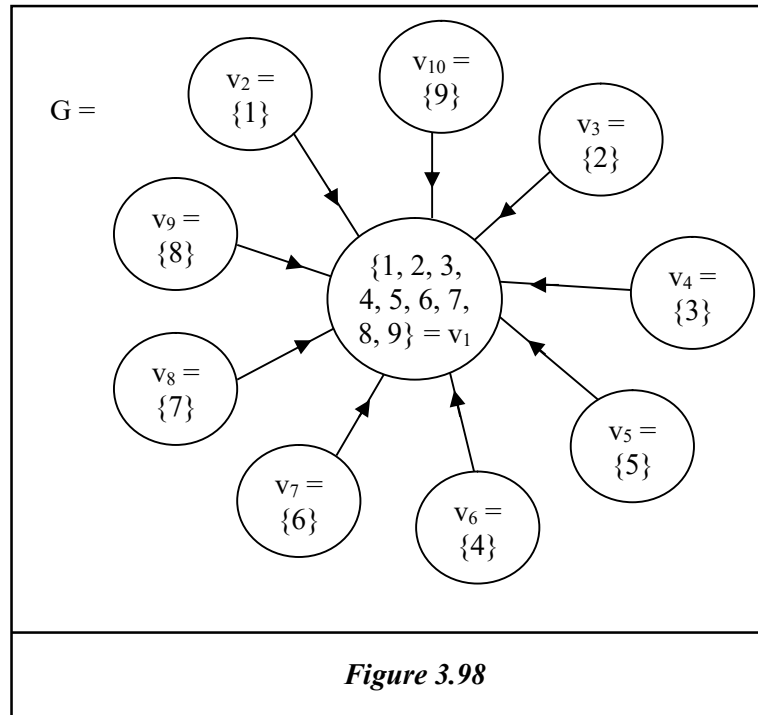

- i) Show H the subset vertex multigraph of type I with vertex subsets v_1 to v_{10} of G , then H is identical with G except for directed lines.
 - ii) If in G v_{10} is changed to $\{9, 6\}$ and v_5 to $\{5, 2\}$ prove G is a multistar graph of type II but H the type I subset vertex multigraph is not a star graph.
29. Give an example of a subset vertex multigraph of type I which is wheel.
 30. Does there exist a subset vertex multigraph of type II which is a wheel?

31. Let G be a vertex subset multigraph of type II which is a line what will be type I subset vertex multigraph H using the same vertex subset of G ?
32. Let G be the subset vertex multigraph of type II given by the following figure.

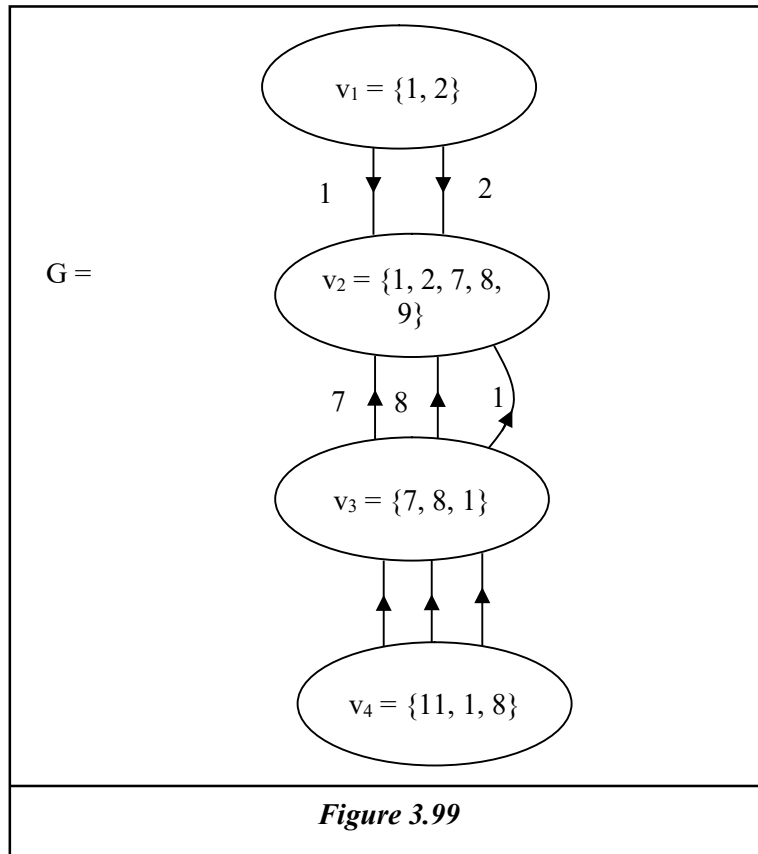

- i) Find H (with vertex subsets v_1, v_2, v_3 and v_4) the subset vertex multigraph of type I.
- ii) Is H a pseudo complete subset vertex multigraph of type I.

Chapter Four

SPECIAL SUPER - SUBSET VERTEX MULTIGRAPH FOR MULTINETWORK

Study of subset vertex multigraphs happens to be a very new notion. The concept of subset vertex graphs have been introduced in 2018 [53]. Further the notion of multigraphs are well-know from [55-6] however, the notion of subset vertex multigraphs and their applications are given in this chapter.

As in case of multinetworks using multigraphs subset vertex multigraphs can be used for multinetworks. One of the special features about them is that once the vertex subsets are provided the resulting subset vertex multigraph is unique. This property enables the resulting multiedges to be unique and these multiedges are not arbitrarily fixed.

Further the concept of special subset vertex multisubgraphs happens to be a big boon in fault tolerant multinetworks as when they are used it will save both money and time. That too when we use the hyper multisubgraphs which are special subset vertex multisubgraphs it will still be very useful.

Here we use these special type of hyper-multisubgraphs for fault tolerant multi-networks.

To this end we also introduce the new notion of super special subset vertex multigraphs. We will describe this situation by some examples.

Example 4.1. Let $S = \{1, 2, \dots, 20\}$ be a set and $P(S)$ the power set of S .

Let G be the subset vertex multigraph given by the following figures.

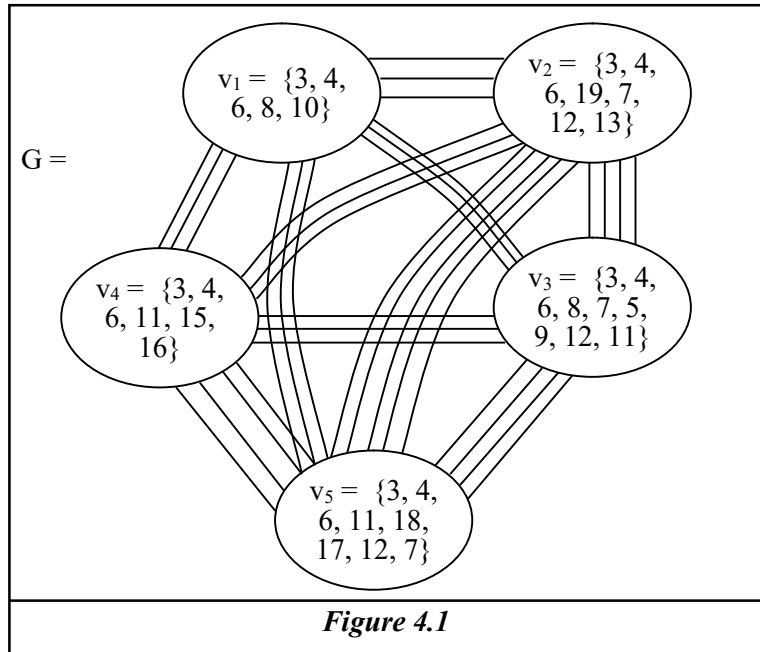

We see the subset vertex multigraph G can serve as the network for some multi network. By observation of the subset vertices we find all the 5 subset vertices have the elements $\{3,$

4, 6} to be common may be they are vital ones in this multi networks and it may so happen failure of any of these nodes in any of these subset vertices may give problem or make the multi network nonfunctional in this multi network.

Further the multi network is a pseudo complete subset vertex multigraph. So how to save this multi network in time of one or two or all of the nodes in {3, 4, 6} fail to function. To over come this problem we build a super special subset vertex multigraph which is built using G. In this example we add a triple {9, 19, 20} to each of the vertex subsets which are replacement in time of need of full {3, 4, 6} or one of {3, 4, 6} or two of {3, 4, 6}.

We can assume the role of 9 would be exactly as that of 3 that of the functions of 4 would be done by 19 and that of 6 would be done exactly by 20.

We will have the multinetwork which will be called as super multinetwork or subset vertex super-multigraph or super subset vertex multigraph.

Let w_1, w_2, \dots, w_5 denote the new set of vertices of the super subset vertex multigraph and let $S(G)$ denote this super subset vertex multigraph of G which is given by the following figure.

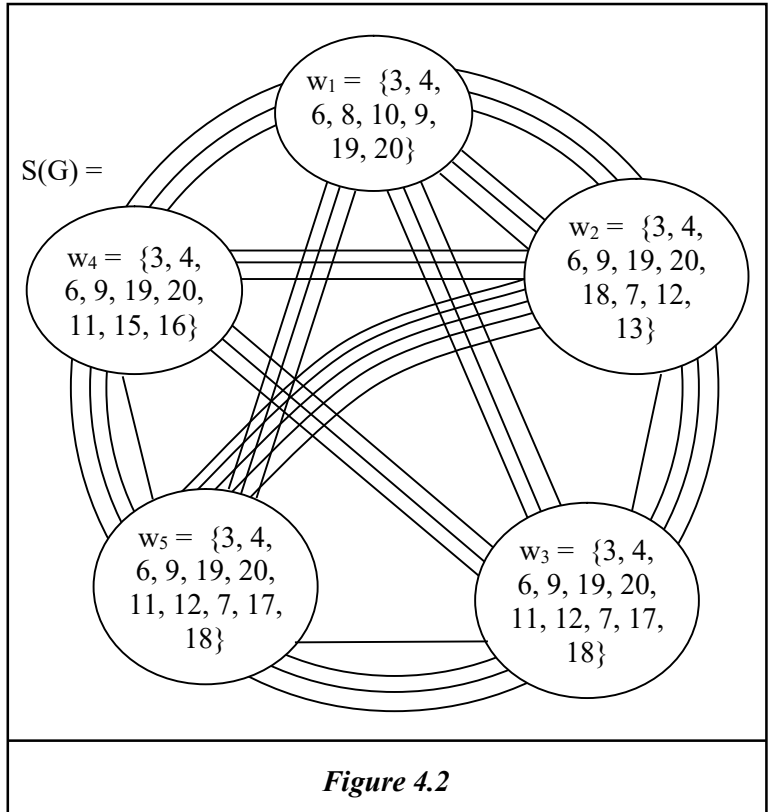

Figure 4.2

In $S(G)$ we can mark the 3 edges or need not mark it in time of emergency they will be so appropriately constructed they automatically fix themselves. For instance, if node 3 fails in the unit v_1 that is in the subset vertex set v_1 then 3 node of v_1 cannot connect to v_2, v_3, v_4 and v_5 however v_2, v_3, v_4 and v_5 will function on node $\{3\}$. Now if 3 node in v_1 is replaced by node $\{9\}$ then it is mandatory $\{3\}$ in nodes of v_2, v_3, v_4 and v_5 are muted and $\{9\}$ starts to connect itself automatically that is the way the multi network functions.

Thus use of these super subset vertex multigraphs can be very helpful it can save the multi network in time of need. These

connections can also be termed as special neutral connections and need not be explicitly shown by edges but they exist in $S(G)$ and in time of emergency; that is failure of any of the vital node or nodes they will take their appropriate role and keep the multi network to function as original one.

Suppose we have an instance say the node $\{3\}$ has failed in v_1 and node $\{4\}$ has failed in v_5 then how to switch on to the super special subset vertex multigraph. It is mandatory both nodes 3 and 4 are replaced by 9 and 19 respectively in all the five nodes. Similarly, 6 by 20 in all nodes in time of need. So the multinet network failure is taken care of these vital nodes.

We can also represent $S(G)$ as the edge labeled multigraph which is as follows.

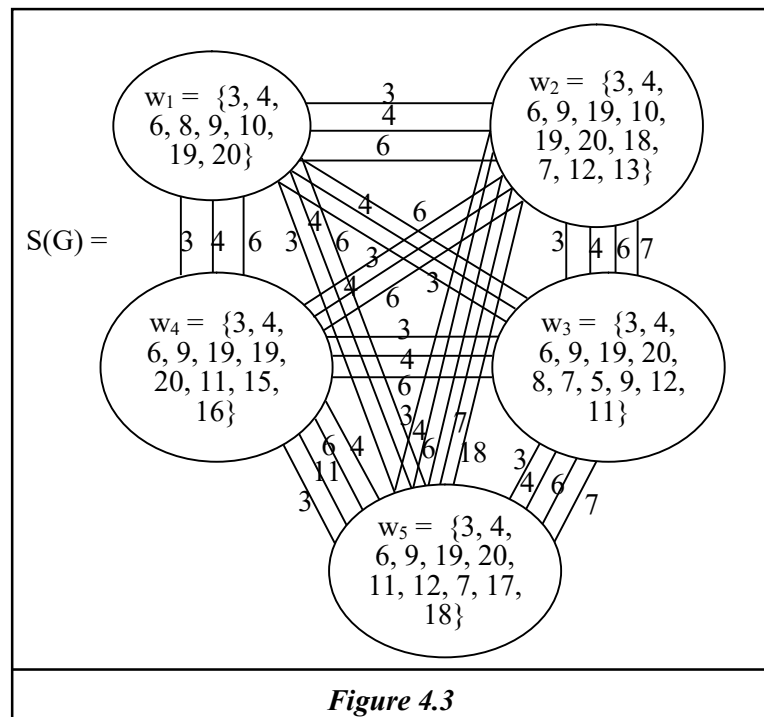

We see only the nodes {3, 4, 6} contribute to the multigraph or equivalently multinetwork.

Other nodes even if they fail may not totally dismantle the multi network. So the role of supersubset special vertex multigraphs is to preserve the network at times of failure. Thus every multi network if it has vital nodes (vital nodes in the multi network are those nodes if when fails to function, the multi network will be paralyzed) they are replaced in every vertex by special nodes when these vital nodes fail they automatically switch onto these replaced nodes their by saving cost, time and above all the repugnance of such parallelization of the multi network.

We now give yet another example before we proceed onto define super special subset vertex multigraphs.

Example 4.2. Let G be a subset vertex multigraph given by the following figure.

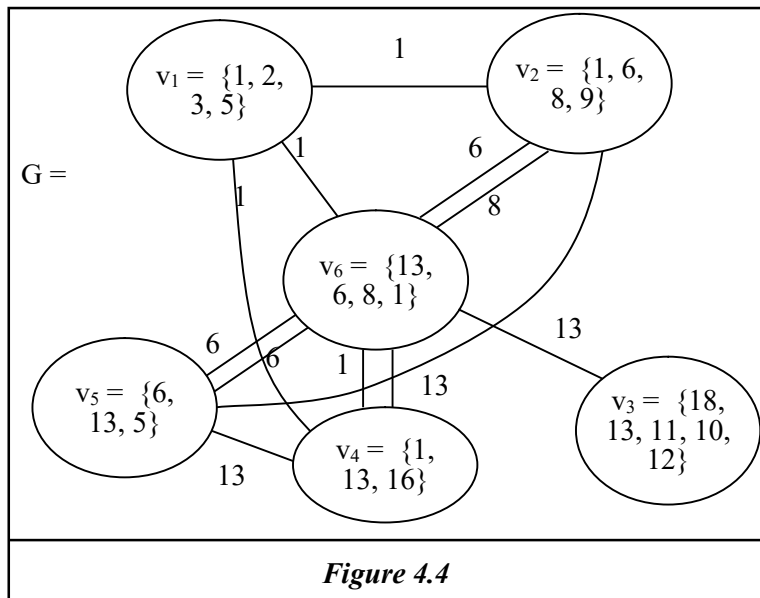

Now we see if the edge labeled 1 is removed that is the node 1 becomes nonfunctional then the very vertex v_1 will become disconnected from the multi network G so in the super special subset vertex multigraph we include in v_1, v_6, v_4 and v_2 a term 17 to replace 1 in time of need. Similarly if the edge labeled 13 becomes nonfunctional the vertex v_3 will become disconnected in the multi network so we include 14 to replace 13 in times of need.

Thus the super special subset vertex multigraph $S(G)$ of G is as follows.

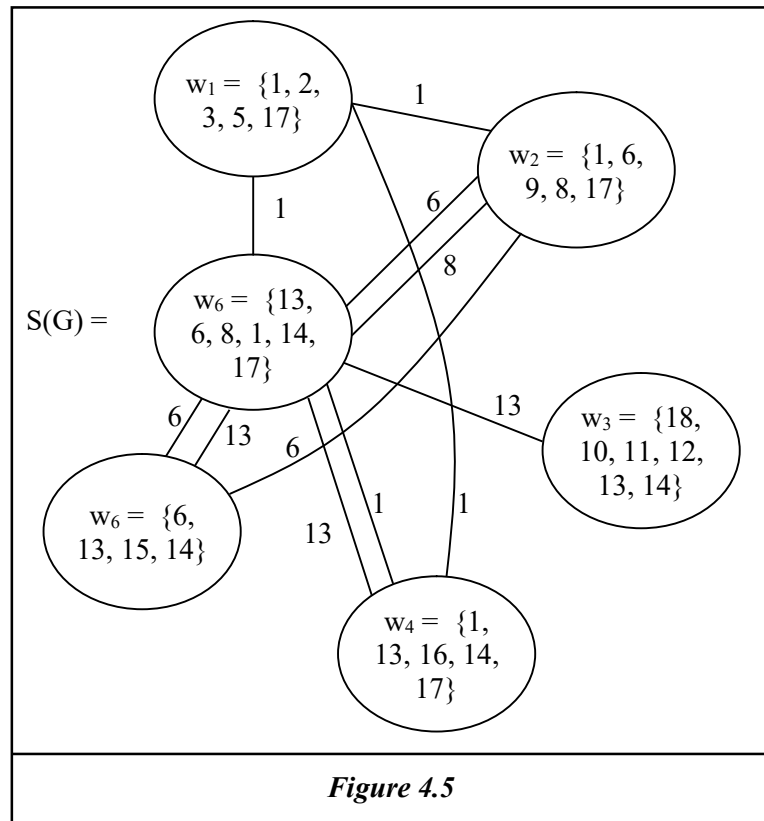

However the super special subset vertex multigraph $S(G)$ also will have the same number of labeled edges as that of the original subset vertex multigraph G .

We provide yet another example of the subset vertex multigraph G by the following figure.

Example 4.3: Let G be a subset vertex multigraph given by the following figure. The vertex subsets $v_i \in P(S)$ where $S = \{1, 2, \dots, 37\}; 1 \leq i \leq 8$.

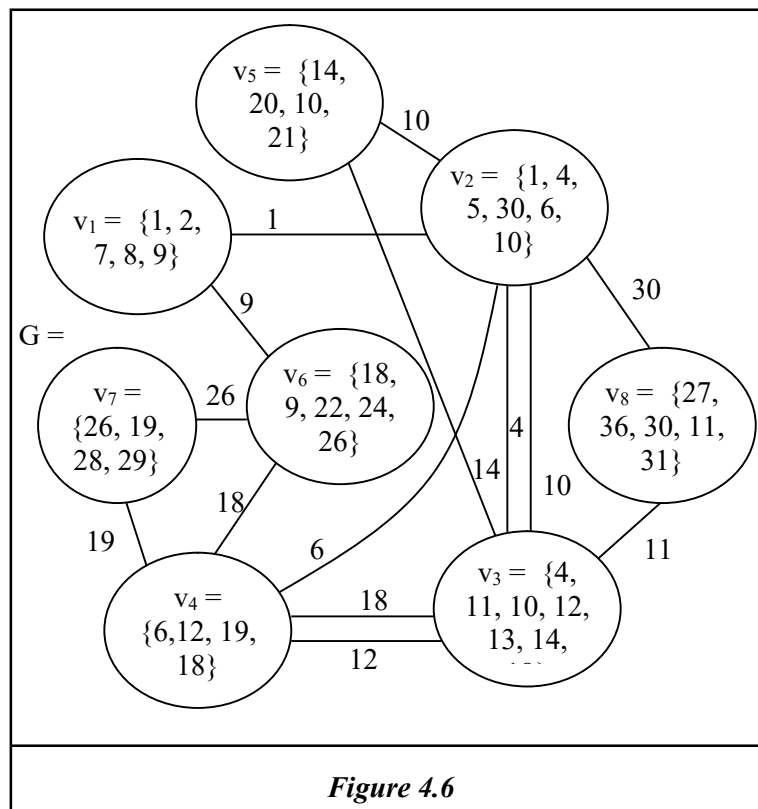

We see this G is a subset vertex multigraph for which we cannot build any super special subset vertex multigraph $S(G)$ for we do not have any special elements in vertex subset which when becomes non functional the multinetwork will become paralyzed or some vertex subsets becomes disconnected. So we cannot in general make a statement that every subset vertex multigraph G has the super special subset vertex multigraph $S(G)$.

Now we proceed onto give the abstract definition of the same.

Definition 4.1. Let $S = \{1, 2, \dots, n\}$ be any finite set. $P(S)$ the power set of S . G be a subset vertex multigraph with m vertices v_1, v_2, \dots, v_m ; $v_i \in P(S)$ $1 \leq i \leq m$ which is edge and vertex labeled.

Suppose G is a pseudo complete subset vertex multigraph and it has certain edges to be vital then we add elements or nodes to those vertex subsets and rename the vertices as w_1, \dots, w_m where $v_i \subseteq w_i$; $1 \leq i \leq m$; in case there are elements or nodes added in w_i then the containment will be proper otherwise it is not so.

Then we define the multigraph with vertex subsets w_1, w_2, \dots, w_m as the super special subset vertex multigraph $S(G)$ of

G which will have only the same number of multiedges as that of *G*.

We call the multigraph *G* as multinetwork.

In case vital edge/edges becomes nonfunctional then in $S(G)$ the replaced ones in w_i automatically starts to keep the multi network to function normally ($1 \leq i \leq n$) as they are in each vertex subset interconnected for replacement in times of nonfunctioning.

These multi networks are fault tolerant multi networks.

Theorem 4.1. *Let S be a finite set, $S = \{1, 2, \dots, n\}$; $P(S)$ the power set of S . G be a labeled subset vertex multigraph; $S(G)$ the super special subset vertex multigraph exists if and only if G has vital edges.*

Proof is direct hence left as an exercise to the reader.

It is important to note that every subset vertex multigraph need not have super special subset vertex multigraph associated with it.

These multigraphs will find its place in the fault tolerant multinetworks.

We give yet another example in case the multinetworks are disconnected how to work for the super special subset vertex multigraphs of them.

Example 4.4. Let G be a vertex and edge labeled subset vertex multigraph with vertex subsets from $P(S)$ where $S = \{1, 2, \dots, 36\}$ given by the following figure.

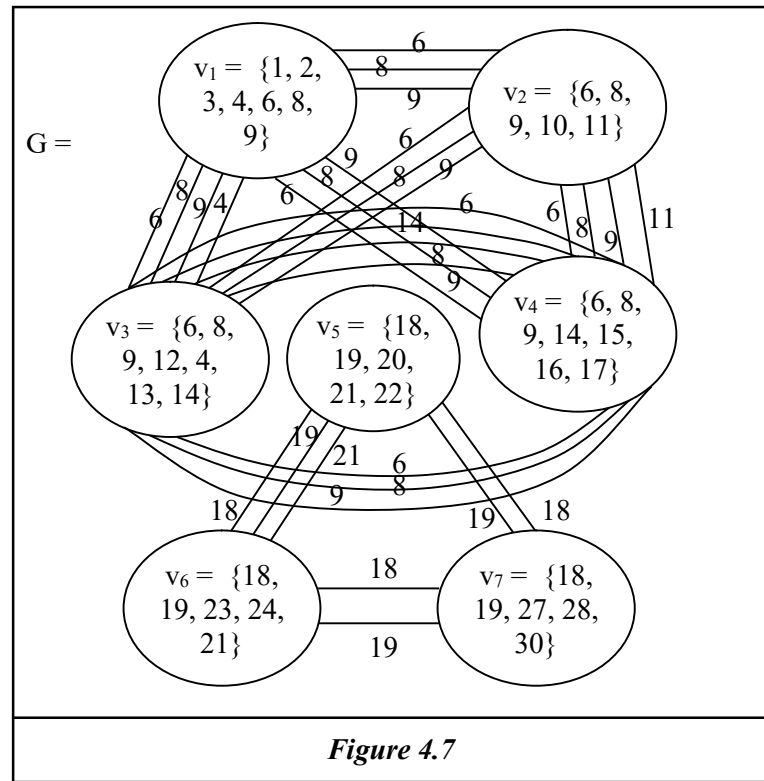

We see G is a disconnected subset vertex multigraph which are edge labeled.

The vital elements are $\{6, 8, 9\}$ and $\{18, 19\}$ of G . We now give the super special subset vertex multigraph $S(G)$ of G given by the following figure.

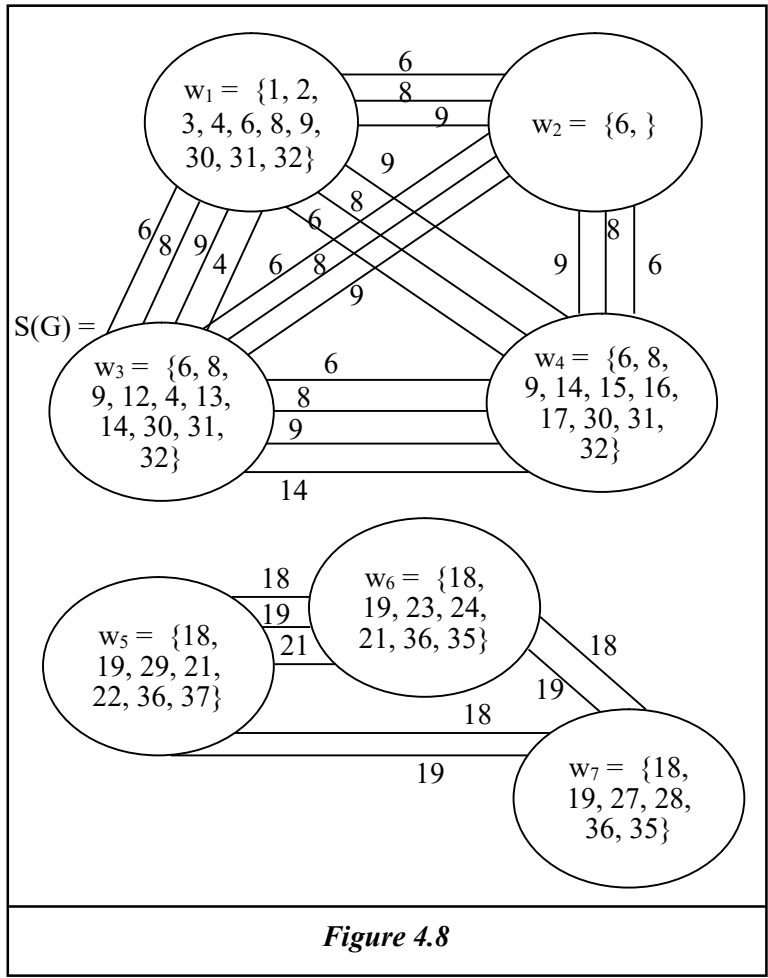

For the other 3 vertex subsets w_5 , w_6 and w_7 we include the set $\{36, 35\}$ as replaceable for $\{18, 19\}$ respectively.

This is yet another type of multi networks for which we can construct a super special subset vertex multigraphs or super special multinetworks.

As in case of special subset vertex multisubgraphs of a subset vertex multigraph G in general is not always defined.

Similarly, in case of subset vertex multigraphs also we are not always guaranteed of super special subset vertex multigraphs.

Both these types of multigraphs will be useful in fault tolerant multinetworks.

It is still interesting to find and characterize those subset vertex multigraphs G which has both special subset vertex multisubgraphs H and that of the super special subset vertex multigraphs $S(G)$ thus $H \subseteq G \subseteq S(G)$.

The reader is left with the task of finding H , G and $S(G)$ for suitable subset vertex multigraph G .

We will describe a few examples to this effect.

Example 4.5. Let $S = \{1, 2, \dots, 45\}$ $P(S)$ the power set of S . Let G be the edge and vertex labeled subset vertex multigraph given by the following figure.

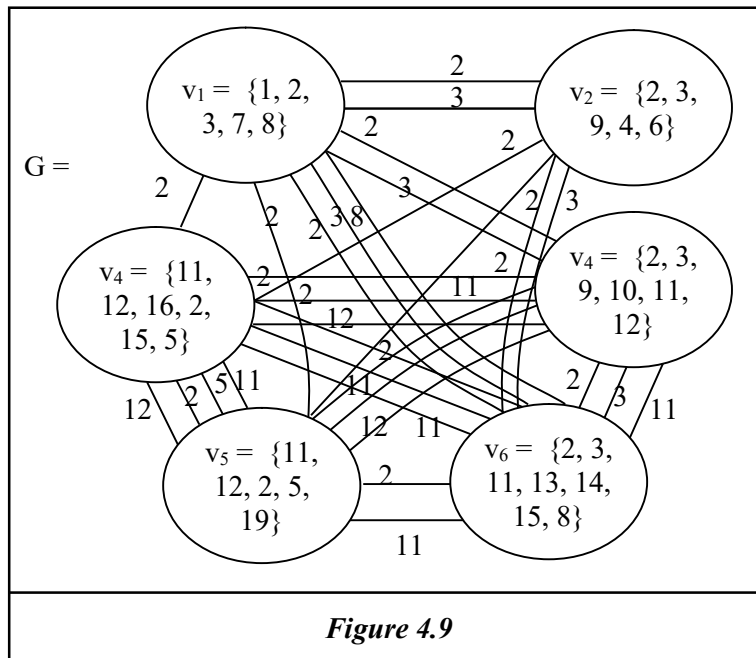
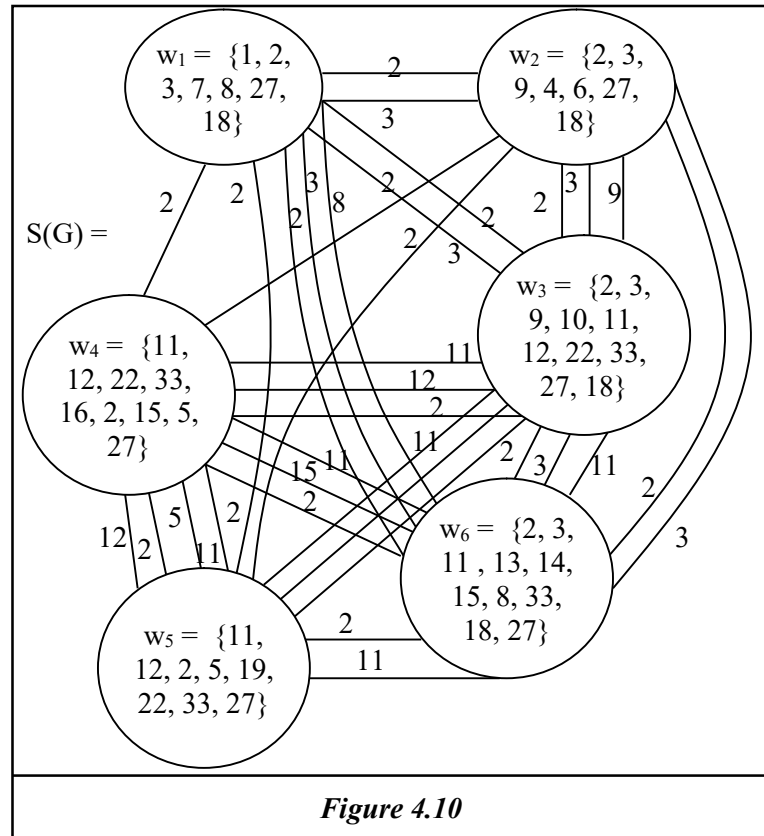

Figure 4.9

The super special subset vertex multigraph $S(G)$ of G is got by including in the vertex subset which contains 2 the element 27. In all vertex subsets which contains 3 include the element 18. In all vertex subsets which contains 11 and 12 we include the element 33 and 22 respectively. The resulting super special subset vertex multigraph $S(G)$ of the subset vertex multigraph G is given by the following figure.



Clearly $v_i \subseteq w_i; i = 1, 2, \dots, 6$. The edges are taken as the same as in case of G for $S(G)$ also.

Now we provide an example of a special subset vertex multisubgraph H of G .

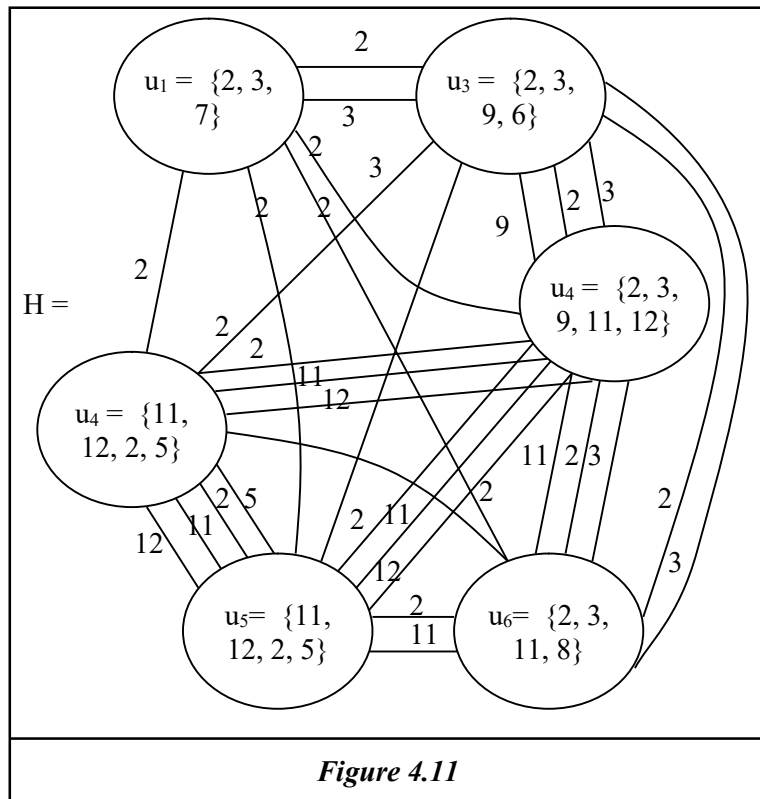

Clearly H is a special subset vertex multisubgraph of G.

It is pertinent to keep on record that there can be more than one special subset vertex multisubgraph of G however the super special subset vertex multigraph $S(G)$ of G is only one.

In case of disconnected subset vertex multigraphs interested reader can study them.

However in [53-5] we have clearly given condition for the existence of the special subset vertex multisubgraphs. Further it is interesting to note that in case we want to use the special subset vertex multisubgraph we can use it for retrieval of the network. If we want the multinetworks to function, in times when vital nodes affected, we can use the notion of super special subset vertex multigraphs for fault tolerant multinetworks which has the capacity to switch or replace vital nodes in time of need.

Interested researcher is advised to develop real world models in case of computer multinetworks and other multinetworks which has several vital nodes.

Next some authors felt why not build super special subset vertex multisubgraphs using the special subset vertex multisubgraph itself. To this end we do built super special subset vertex multisubgraphs using special subset vertex multisubgraphs which is explained by an example. Using Example 4.5 and for the H given we find $S(H)$ which is as follows. We use vertex subsets a_i where $u_i \subseteq a_i$; $i = 1, 2, \dots, 5$ the multisubgraph $S(H)$ is as follows.

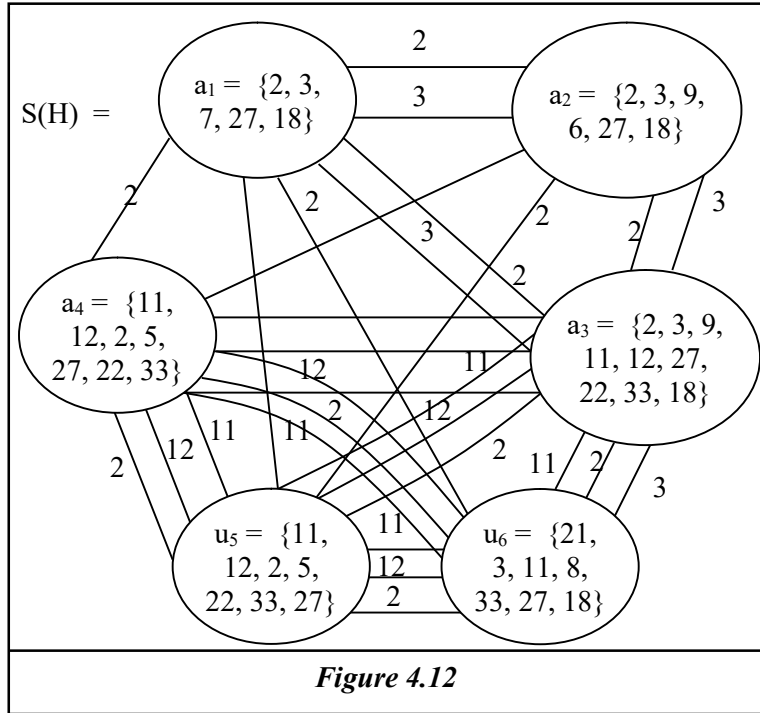

The following observations are vital.

We have now multigraphs G and $S(G)$ and multisubgraphs H and $S(H)$.

$$v_i \subseteq w_i, a_i \subseteq w_i, u_i \subseteq w_i \text{ and } u_i \subseteq a_i \subseteq w_i, 1 \leq i \leq 5.$$

Edges with labels which correspond to vital nodes are always preserved in G , $S(G)$, H and $S(H)$. However, $S(H)$ or the super special subset vertex multisubgraph happens to be the most economic one. Further for every H the special subset

vertex multisubgraph we can always built a super special subset vertex multisubgraphs, so we have more choices unlike $S(G)$.

We suggest the following problems.

Problems

1. Does every subset vertex multigraph has a super special subset vertex multigraph? Justify your claim.
2. Compare a super special subset vertex multigraph with, a special subset vertex multigraph.
3. Let G be a subset vertex multigraph given by the following figure.

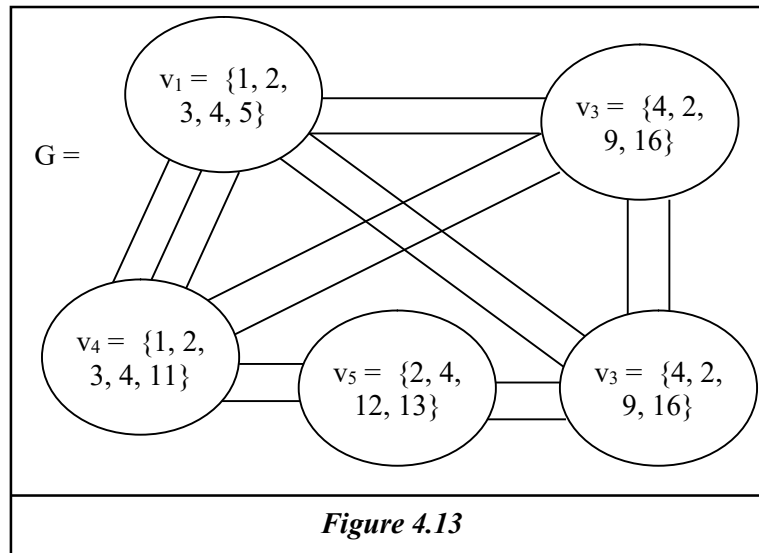

$v_1, v_2, v_3, v_4, v_5 \in P(S)$ where $S = \{1, 2, 3, \dots, 18\}$.

- i) Edge label the subset vertex multigraph G.
 - ii) Find all the special subset vertex multisubgraphs of G.
 - iii) Find the super special subset vertex multigraph of G.
4. Let G be a subset vertex multigraph with vertex set $v_i \in P(S)$ where $S = \{1, 2, \dots, 36\}$; $1 \leq i \leq 9$; given in the following.
- $v_1 = \{2, 4, 6, 8, 9, 12\}$, $v_2 = \{9, 12, 7, 1, 3\}$
- $v_3 = \{9, 12, 8, 1, 5, 11\}$, $v_4 = \{9, 12, 13, 14, 16\}$
- $v_5 = \{9, 12, 1, 5, 21, 23, 24\}$ $v_6 = \{9, 12, 5, 24, 26, 27\}$
- $v_7 = \{9, 5, 29, 30, 31\}$, $v_8 = \{1, 12, 13, 17\}$ and
- $v_9 = \{9, 12, 1, 5, 7, 2, 6\}$.
- i) Draw the subset vertex multigraph G with vertex subsets $\{v_1, v_2, \dots, v_9\}$ given above.
 - ii) Label the edges of G.
 - iii) Which are the vital nodes of G?
 - iv) Find all special subset vertex multisubgraphs of G.
 - v) Construct the corresponding super special subset vertex multisubgraphs.
 - vi) Which of the super special subset vertex multisubgraph is most economical?
 - vii) Which of the super special subset vertex multisubgraph is most powerful? (Powerful in the sense that it is capable of replacing the original multinetwork).

- viii) Find the super special subset vertex multigraph $S(G)$ of G and compare it with $S(H)$ of any H .
- ix) Is G a pseudo complete subset vertex multigraph?
- 5. Give an example of a subset vertex multigraph G which has no special subset vertex multisubgraph or a super special subset vertex multigraph.
- 6. Does there exist a subset vertex multigraph G which has no super special subset vertex multigraph but has several special subset vertex multisubgraphs?
- 7. Give an example of a subset vertex multigraph which has only one special subset vertex multisubgraph.
- 8. Show that subset vertex multigraphs can be used in the study of HITS in the context of web page ranking.
- 9. Illustrate the use of subset vertex multigraphs in social information multinetwork.
- 10. Discuss the role of super special subset vertex multigraphs in the social information multinetworks if the researcher is keen on retrieving the dead or dying social customs.
- 11. For the subset vertex multigraph G given by the following figure can we have a super special vertex subset multigraph. The vertex subsets are from $P(S)$ where $S = \{1, 2, \dots, 54\}$;

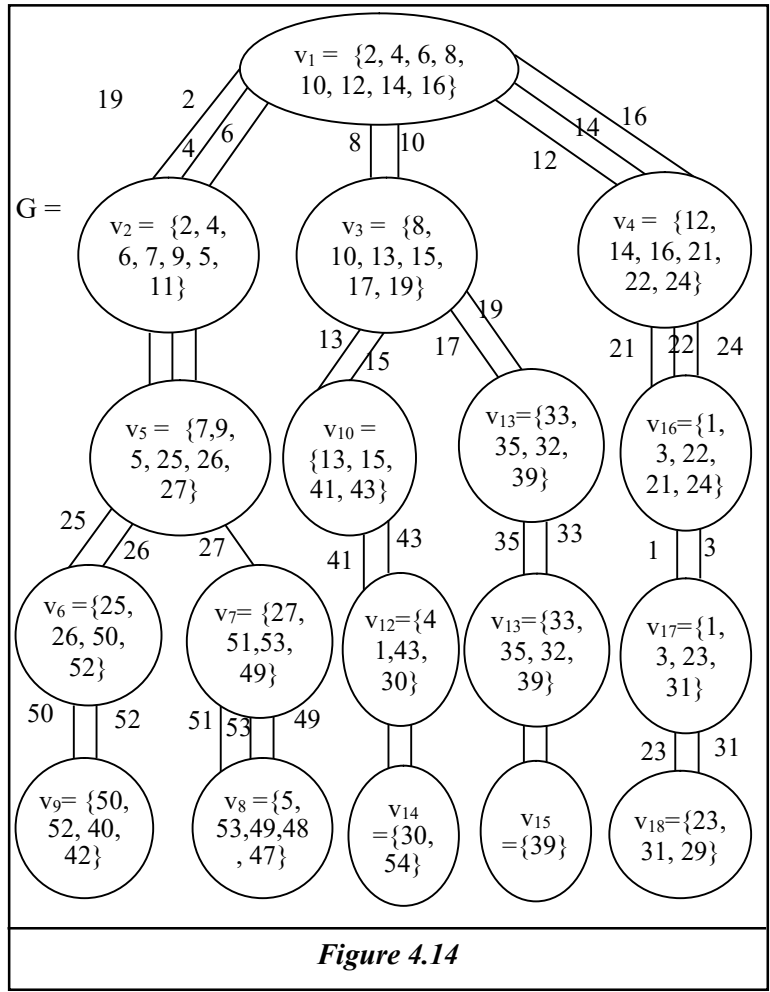

- i) Does this multigraph G has super special subset vertex multigraph?
- ii) Does there exist for this G a special subset vertex multisubgraphs?
- iii) Obtain all other special properties associated with this type of multigraph G.

12. Can we generalize and say subset vertex multitrees cannot have super subset vertex multigraphs?
13. Can a subset vertex multiring contain super special subset vertex multigraph?
14. Let G be a subset vertex multigraph given by the following figure.

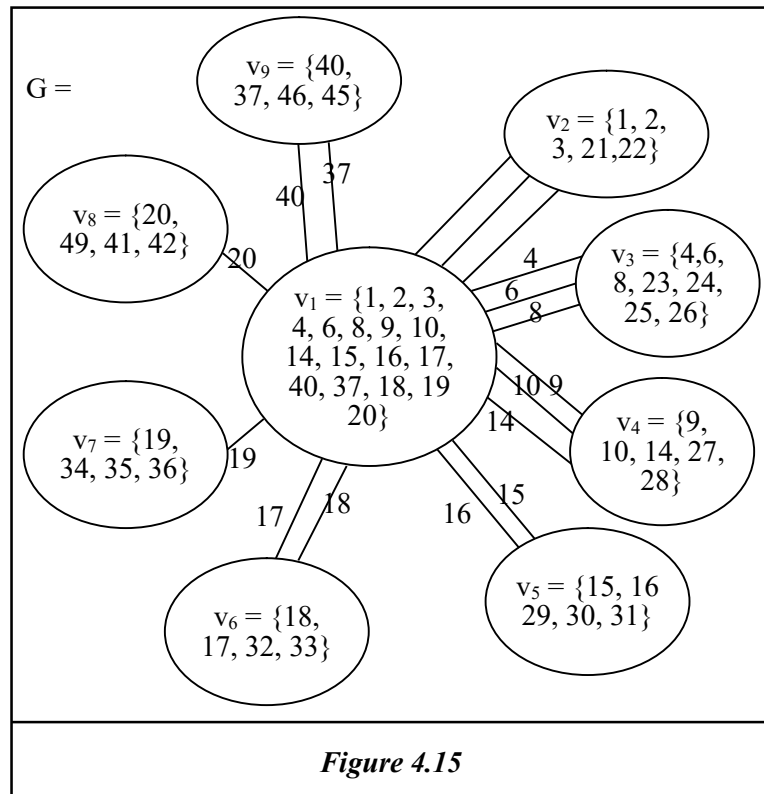

where $v_i \in P(S)$; $S = \{1, 2, \dots, 49\}$ $1 \leq i \leq 9$. Study questions (i) to (iii) of problem 11 for this G .

15. Characterize those types of subset vertex multigraphs which has no super special subset vertex multigraphs.

16. Can a subset vertex multigraph which is a multiring have special subset vertex multisubgraphs?
17. Does a subset vertex multitree contain special subset vertex multisubgraphs?
18. Does a subset vertex multistar graph contain a special subset vertex multisubgraph?
19. Obtain any special feature enjoyed by super special subset vertex multigraph $S(G)$ of a subset vertex multigraph G .
20. Let G be a subset vertex multigraph given by the following figure.

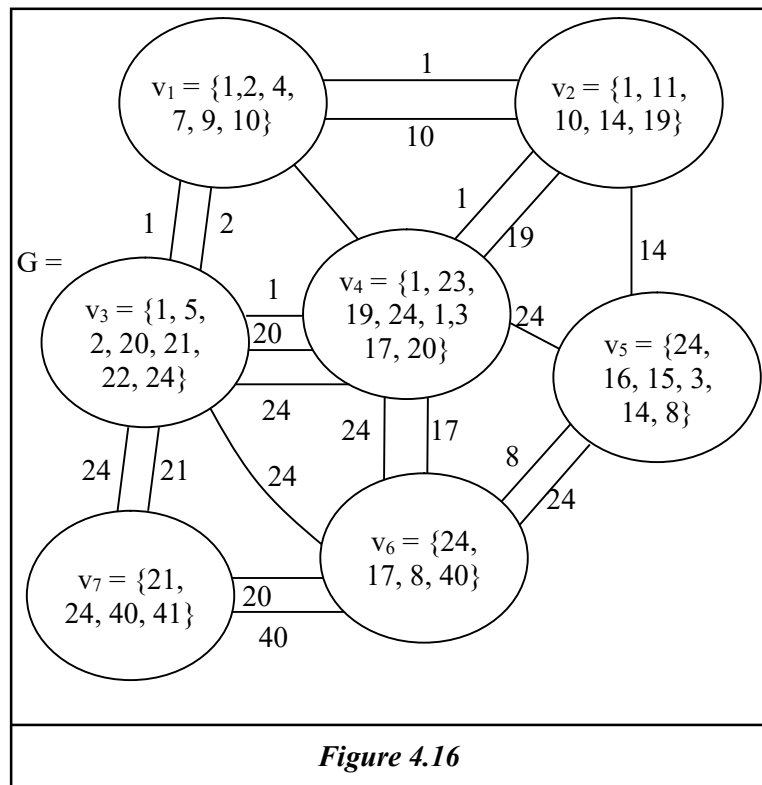

where $v_i \in P(S)$, with $S = \{1, 2, \dots, 49\}$; $1 \leq i \leq 7$.

- i) Find all special subset vertex multisubgraphs of G .
- ii) How many will be eligible to be constructed as super special subset vertex multisubgraphs? Justify your answer!
- iii) Find the super special subset vertex multigraph $S(G)$ of G .
- iv) Which of the nodes / elements in the vertex subsets are vital? (that is mention also the vital edges of G)

21. Find a suitable and appropriate application of super special subset vertex multigraph $S(G)$ of G .
22. Test whether it is possible to replace the super special subset vertex multigraph $S(G)$ of G by a super special subset vertex multisubgraph of G .
23. Suppose G is a subset vertex multiwheel given by the following figure with vertex subsets from $P(S)$ where $S = \{1, 2, \dots, 63\}$

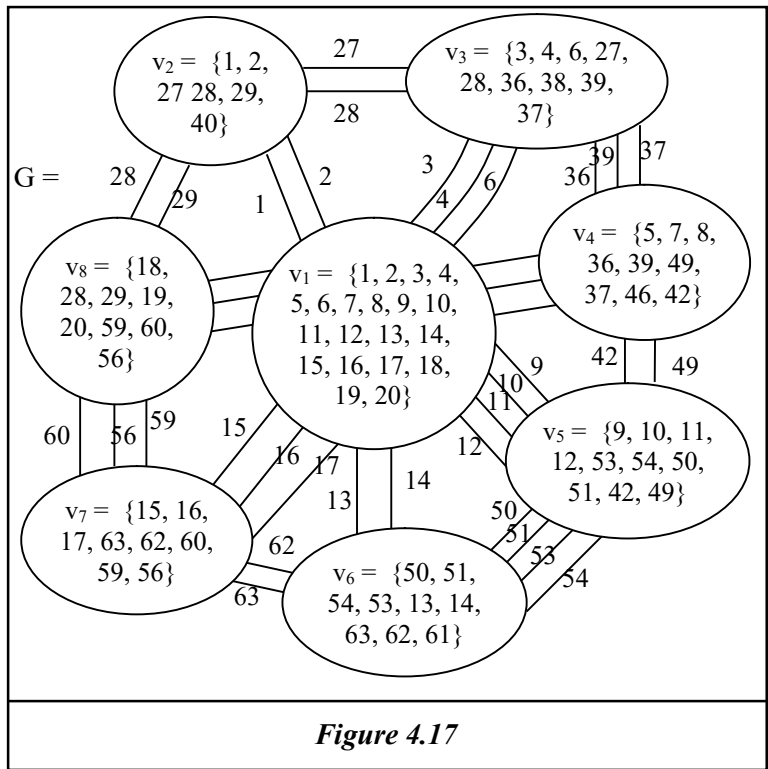

- i) How many special subset vertex multisubgraphs of G are there?

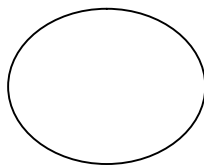

- ii) Can G have the concept of super special subset vertex multigraph?
 - iii) Can G contain super special subset vertex multisubgraphs?
 - iv) Find any other special feature enjoyed by subset vertex multiwheel.
24. Can subset vertex multigraphs G which are multiwheels have super special subset vertex multigraphs? Justify your claim.
25. List those subset vertex multigraphs which cannot have super special subset vertex multigraphs or super special subset vertex multisubgraphs. Prove your claim for general such structures.
26. Give applications of subset vertex multigraphs in social media multinetworks.
27. Can it be established that by using subset vertex multigraph the bias of marking relations or edges be minimized?
28. Enumerate the advantages and disadvantages in using subset vertex multigraphs as multinetworks.
29. Enumerate all special features enjoyed by subset vertex multigraphs as multinetworks.
30. Prove / disprove in general subset vertex multigraphs G which has both super special subset vertex multisubgraphs and super special subset vertex multigraphs $S(G)$ then it is advantages to use super special subset vertex multisubgraphs.
31. Let G be a subset vertex multigraph which is complete.
i) Can G have super special subset vertex multigraph?

- ii) Can G have super special subset vertex multisubgraphs?
 - iii) Can G have special subset vertex multisubgraphs?
32. Study questions (i) to (iii) of problem (31) in case of subset vertex multigraphs which are quasi / pseudo complete.
33. Let G be a disconnected subset vertex multigraph.
- i) Can G have vital nodes?
 - ii) Prove / disprove your claim by examples.
34. Can we prove if the subset vertex multigraph G has vital nodes in more than two vertex subsets then G has super special subset vertex multigraphs and super special vertex subset multisubgraphs?
35. Let G be a subset vertex multigraph which is uniform pseudo complete.
- i) Does the super special subset vertex multigraph $S(G)$ of G exist?
 - ii) Does G contain special subset vertex multisubgraphs H of G ?
 - iii) Does the super special subset vertex multisubgraph $S(H)$ of H of G exist?
36. Can subset vertex multigraphs be used in fuzzy cognitive multi maps models? Justify your claim!
37. Prove the notion of super special subset vertex multisubgraphs of any special vertex multigraph can find its applications in the study of Link Analysis Techniques in behaviour of HITS in the context of web page ranking? (Mainly in the analysis of near - zero authority score, strong authority score etc).

38. Can the notion of subset vertex multibipartite graphs be used in the study of Artificial Neural Networks?
39. Can subset vertex n-partite multigraph find their applications in Deep Neural Networks?
40. Let G be a subset vertex multi 3 partite graph given by the following figure.

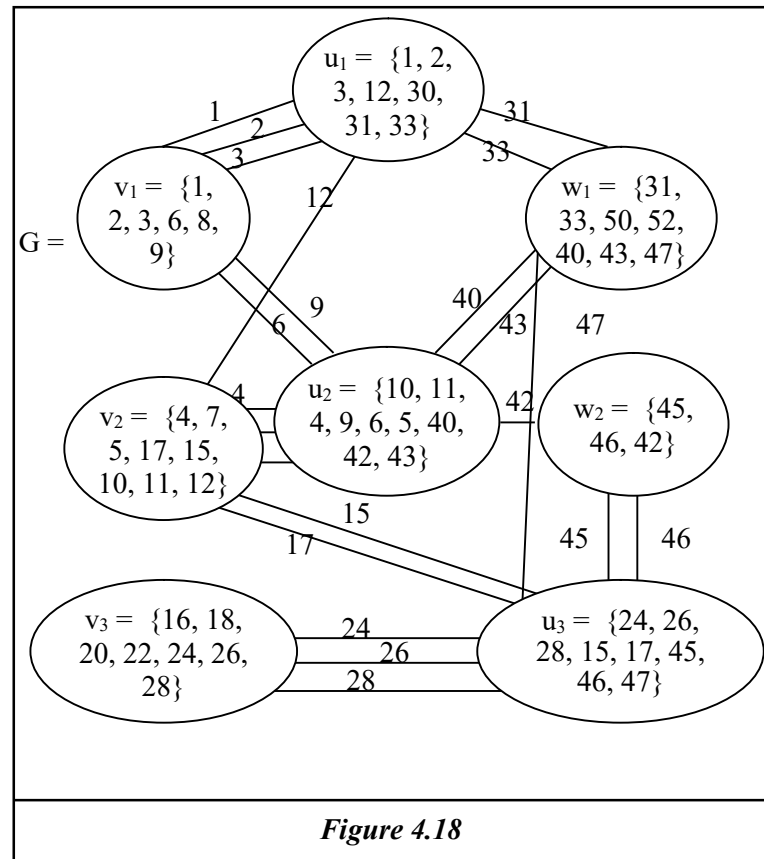

Figure 4.18

- i) Can G have a super special vertex multigraph $S(G)$?

- ii) Can G have special subset vertex multisubgraphs?
 - iii) Can G be used in DNN?
 - iv) Obtain any other special feature associated with G .
 - v) What is the hidden layer of the DNN if G is used as a multinetwork?
41. Can the concept of subset vertex multibipartite graphs be used in depicting the dynamical system of Fuzzy Relational Maps or Neutrosophic Relational Maps?
 42. Give an example of a subset vertex multigraphs which has weighted edges.
 43. Use the concept of subset vertex multigraphs in real world problem.
 44. Build a mathematical model which adopts the concept of subset vertex multigraphs G and super special subset vertex multigraph $S(G)$ of G .
 45. Obtain any other special property of subset vertex multigraphs so that they function better than the other multigraphs in multinetworks.

FURTHER READING

1. Bank, Randolph E., and R. Kent Smith. "An algebraic multilevel multigraph algorithm." *SIAM Journal on Scientific Computing* 23, no. 5 (2002): 1572-1592.
2. Broumi, Said, Mohamed Talea, Assia Bakali, and Florentin Smarandache. "Single valued neutrosophic graphs." *Journal of New theory* 10 (2016): 86-101.
3. Broumi, Said, Florentin Smarandache, Mohamed Talea, and Assia Bakali. "Single valued neutrosophic graphs: degree, order and size." In 2016 IEEE international conference on fuzzy systems (FUZZ-IEEE), pp. 2444-2451. IEEE, 2016.
4. Durkheim, Emile *De la division du travail social: étude sur l'organisation des sociétés supérieures*, Paris: F. Alcan, 1893. (Translated, 1964, by Lewis A. Coser as *The Division of Labor in Society*, New York: Free Press.)
5. Freeman, L.C.; Wellman, B., A note on the ancestral Toronto home of social network analysis, *Connections*, **18** (2): 15–19 (1995).

6. Gilbert, Jeffrey M. "Strategies for multigraph edge coloring." Johns Hopkins APL technical digest 23, no. 2/3 (2002): 187-201.
7. Gjoka, M., Butts, C. T., Kurant, M., & Markopoulou, A. (2011). Multigraph sampling of online social networks. *IEEE Journal on Selected Areas in Communications*, 29(9), 1893-1905.
8. Godehardt, Erhard A.J. "Probability models for random multigraphs with applications in cluster analysis." In *Annals of Discrete Mathematics*, vol. 55, pp. 93-108. Elsevier, 1993.
9. Godehardt, Erhard. *Graphs as structural models: The application of graphs and multigraphs in cluster analysis*. Springer Science & Business Media, 2013.
10. Harary, F., *Graph Theory*, Narosa Publications (reprint, Indian edition), New Delhi, 1969.
11. Kadushin, C., *Understanding Social Networks: Theories, Concepts, and Findings*. Oxford University Press, 2012.
12. Koehly, Laura M., and Phillipa Pattison. "Random graph models for social networks: Multiple relations or multiple raters." *Models and methods in social network analysis* (2005): 162-191.
13. Kosko, B., Fuzzy Cognitive Maps, *Int. J. of Man-Machine Studies*, 24 (1986) 65-75.
14. Kosko, B., *Fuzzy Thinking*, Hyperion, 1993.
15. Kosko, B., Hidden Patterns in Combined and Adaptive Knowledge Networks, *Proc. of the First IEEE International*

- Conference on Neural Networks (ICNN-86), 2 (1988) 377-393.
16. Kosko, B., *Neural Networks and Fuzzy Systems: A Dynamical Systems Approach to Machine Intelligence*, Prentice Hall of India, 1997.
 17. Moreno, J.L., *First Book on Group Therapy*. Beacon House, 1932.
 18. Moreno, J.L., *Sociometry and the Science of Man*, Beacon House, 1956.
 19. Moreno, J.L., *Sociometry, Experimental Method and the Science of Society: An Approach to a New Political Orientation*. Beacon House, 1951.
 20. Scott, J.P., *Social Network Analysis: A Handbook* (2nd edition). Sage Publications, Thousand Oaks, CA, 2000.
 21. Shafie, Termeh. "A Multigraph Approach to Social Network Analysis." *Journal of Social Structure* 16 (2015).
 22. Simmel, Georg, *Soziologie*, Leipzig: Duncker & Humblot, 1908.
 23. Smarandache, F. (editor), *Proceedings of the First International Conference on Neutrosophy, Neutrosophic Set, Neutrosophic Probability and Statistics*, Univ. of New Mexico – Gallup, 2001.
<http://www.gallup.unm.edu/~smarandache/NeutrosophicProceedings.pdf>
 24. Smarandache, F. *Neutrosophic Logic - Generalization of the Intuitionistic Fuzzy Logic*, presented at the Special Session on Intuitionistic Fuzzy Sets and Related Concepts, of

International EUSFLAT Conference, Zittau, Germany, 10-12 September 2003.

<http://lanl.arxiv.org/ftp/math/papers/0303/0303009.pdf>

25. Smarandache, F., *Collected Papers III*, Editura Abaddaba, Oradea, 2000.
<http://www.gallup.unm.edu/~smarandache/CP3.pdf>
26. Tönnies, Ferdinand, *Gemeinschaft und Gesellschaft*, Leipzig: Fues's Verlag, 1887. (Translated, 1957 by Charles Price Loomis as *Community and Society*, East Lansing: Michigan State University Press.)
27. Vasantha Kandasamy, W.B. and Smarandache, F., *Algebraic Structures using Subsets*, Educational Publisher Inc, Ohio, (2013).
28. Vasantha Kandasamy, W.B. and Smarandache, F., *Dual Numbers*, Zip Publishing, Ohio, (2012).
29. Vasantha Kandasamy, W.B. and Smarandache, F., *Finite Neutrosophic Complex Numbers*, Zip Publishing, Ohio, (2011).
30. Vasantha Kandasamy, W.B. and Smarandache, F., *Natural Product on Matrices*, Zip Publishing Inc, Ohio, (2012).
31. Vasantha Kandasamy, W.B. and Smarandache, F., *Special dual like numbers and lattices*, Zip Publishing, Ohio, (2012).
32. Vasantha Kandasamy, W.B. and Smarandache, F., *Special quasi dual numbers and Groupoids*, Zip Publishing, Ohio, (2012).

33. Vasantha Kandasamy, W.B., and Anitha, V., Studies on Female Infanticide Problem using Neural Networks BAM-model, *Ultra Sci.*, 13 (2001) 174-183.
34. Vasantha Kandasamy, W.B., and Balu, M. S., Use of Weighted Multi-Expert Neural Network System to Study the Indian Politics, *Varahimir J. of Math. Sci.*, 2 (2002) 44-53.
35. Vasantha Kandasamy, W.B., and Indra, V., Applications of Fuzzy Cognitive Maps to Determine the Maximum Utility of a Route, *J. of Fuzzy Maths*, publ. by the Int. fuzzy Mat. Inst., 8 (2000) 65-77.
36. Vasantha Kandasamy, W.B., and Pramod, P., Parent Children Model using FCM to Study Dropouts in Primary Education, *Ultra Sci.*, 13, (2000) 174-183.
37. Vasantha Kandasamy, W.B., and Praseetha, R., New Fuzzy Relation Equations to Estimate the Peak Hours of the Day for Transport Systems, *J. of Bihar Math. Soc.*, 20 (2000) 1-14.
38. Vasantha Kandasamy, W.B., and Ram Kishore, M. Symptom-Disease Model in Children using FCM, *Ultra Sci.*, 11 (1999) 318-324.
39. Vasantha Kandasamy, W.B., and Smarandache, F., Analysis of social aspects of migrant labourers living with HIV/AIDS using fuzzy theory and neutrosophic cognitive maps, Xiquan, Phoenix, 2004.
40. Vasantha Kandasamy, W.B., and Smarandache, F., Basic Neutrosophic algebraic structures and their applications to fuzzy and Neutrosophic models, Hexis, Church Rock, 2004

41. Vasantha Kandasamy, W.B., and Smarandache, F., *Fuzzy and Neutrosophic analysis of Periyar's views on untouchability*, Hexis, Phoenix, 2005.
42. Vasantha Kandasamy, W.B., and Smarandache, F., *Fuzzy Cognitive Maps and Neutrosophic Cognitive Maps*, Xiquan, Phoenix, 2003.
43. Vasantha Kandasamy, W.B., and Smarandache, F., *Fuzzy Relational Equations and Neutrosophic Relational Equations*, Neutrosophic Book Series 3, Hexis, Church Rock, USA, 2004.
44. Vasantha Kandasamy, W.B., and Smarandache, F., *Groups as Graphs*, Editura CuArt, Romania, (2009).
45. Vasantha Kandasamy, W.B., and Smarandache, F., *Introduction to n-adaptive fuzzy models to analyse Public opinion on AIDS*, Hexis, Phoenix, 2006.
46. Vasantha Kandasamy, W.B., and Smarandache, F., *Pseudo Lattice graphs and their applications to fuzzy and neutrosophic models*, EuropaNova, (2014).
47. Vasantha Kandasamy, W.B., and Smarandache, F., *Semigroups as graphs*, Zip publishing, (2012).
48. Vasantha Kandasamy, W.B., and Uma, S. *Combined Fuzzy Cognitive Map of Socio-Economic Model*, Appl. Sci. Periodical, 2 (2000) 25-27.
49. Vasantha Kandasamy, W.B., and Uma, S. *Fuzzy Cognitive Map of Socio-Economic Model*, Appl. Sci. Periodical, 1 (1999) 129-136.

50. Vasantha Kandasamy, W.B., and Yasmin Sultana, Knowledge Processing Using Fuzzy Relational Maps, *Ultra Sci.*, 12 (2000) 242-245.
51. Vasantha Kandasamy, W.B., Ilanthenral, K., and Smarandache, F., *Complex Valued Graphs for Soft Computing*, EuropaNova, (2017).
52. Vasantha Kandasamy, W.B., Ilanthenral, K., and Smarandache, F., *Neutrosophic graphs: a new dimension to graph theory*, EuropaNova, (2016).
53. Vasantha Kandasamy, W.B., Ilanthenral, K., and Smarandache, F., *Special subset vertex subgraphs for networks*, EuropaNova, (2018).
54. Vasantha Kandasamy, W.B., Ilanthenral, K., and Smarandache, F., *Subset Vertex Graphs for social network*, EuropaNova, (2018).
55. Vasantha Kandasamy, W.B., Ilanthenral, K., and Smarandache, F., *Subset Vertex Multigraphs and Neutrosophic Multigraphs for Social Multi Networks*, EuropaNova, (2019).
56. Vasantha Kandasamy, W.B., Ilanthenral, K., and Smarandache, F., *Multigraphs for Multi Networks*, EuropaNova, (2019).
57. Vasantha Kandasamy, WB., K. Ilanthenral, and Florentin Smarandache. *Strong Neutrosophic Graphs and Subgraph Topological Subspaces*. Infinite Study, 2016.

58. Vasantha Kandasamy, W.B., Smarandache, F., and Ilanthenral, K., Elementary Fuzzy matrix theory and fuzzy models for social scientists, automaton, Los Angeles, 2006.
59. Vasantha Kandasamy, W.B., Smarandache, F., and Ilanthenral, K., Special fuzzy matrices for social scientists, InfoLearnQuest, Ann Arbor, (2007).
60. Wasserman, S., and Katherine F., Social network analysis: methods and applications, Cambridge Univ. Press, Cambridge, 1998.
61. Wikipedia- Social Network, last retrieved on 11-05-2018 https://en.wikipedia.org/wiki/Social_network
62. Zadeh, L.A., A Theory of Approximate Reasoning, Machine Intelligence, 9 (1979) 149- 194.
63. Zhang, W.R., and Chen, S., A Logical Architecture for Cognitive Maps, Proceedings of the 2nd IEEE Conference on Neural Networks (ICNN-88), 1 (1988) 231-238.
64. Zimmermann, H.J., Fuzzy Set Theory and its Applications, Kluwer, Boston, 1988.

INDEX

C

Complete subset vertex graph, 12-9

Complete special subset vertex multigraph of type I, 54-63

D

Directed subset vertex graph of type II, 27-35

E

Edge labelled subset vertex multigraphs, 168-75

Edge multisubgraphs, 123-45

Edge subgraphs, 123-48

I

Injective (projective) subset vertex directed graph, 27-35

L

Local complement of a subset- subset subgraph, 16-9

Local complement of special subset vertex multigraph,
67-9

M

Multisubgraphs, 68-73

Multi networks, 212-28

O

Ordinary special subset vertex multisubgraph of type I,
52-9

P

- Powerful subset vertex hyper subgraph, 26-9
- Pseudo complete special subset vertex multisubgraph of type I, 54-63
- Pseudo complete subset vertex graph, 21-8

S

- Special subset vertex multisubgraph of type I, 51-9
- Special subset vertex subgraph, 19-24
- Subset –subset vertex subgraph, 16-21
- Subset vertex complete graph, 12-9
- Subset vertex directed multigraph of type II, 35-45
- Subset vertex empty subgraph, 15- 20
- Subset vertex graph of type I, 7-19
- Subset vertex multigraph of type I, 35-45
- Subset vertex ring / circle graph, 11-9
- Subset vertex star graph, 9-19
- Subset vertex subgraph, 13-9
- Super special subset vertex multigraph, 213-9
- Super special subset vertex multisubgraph, 216-23

U

- Uniform subset vertex multicircle, 85-9
- Uniform subset vertex multigraph of type I, 65-9
- Universal complement of an ordinary subset vertex multigraph, 64-72

W

- Weak ego centric graphs, 154-9
- Weak ego centric star graphs, 153-65

ABOUT THE AUTHORS

Dr.W.B.Vasantha Kandasamy is a Professor in the School of Computer Science and Engg., VIT University, India. In the past decade she has guided 13 Ph.D. scholars in the different fields of non-associative algebras, algebraic coding theory, transportation theory, fuzzy groups, and applications of fuzzy theory of the problems faced in chemical industries and cement industries. She has to her credit over 700 research papers. She has guided over 100 M.Sc. and M.Tech. projects. She has worked in collaboration projects with the Indian Space Research Organization and with the Tamil Nadu State AIDS Control Society. She is presently working on a research project funded by the Board of Research in Nuclear Sciences, Government of India. This is her 130th book.

On India's 60th Independence Day, Dr.Vasantha was conferred the Kalpana Chawla Award for Courage and Daring Enterprise by the State Government of Tamil Nadu in recognition of her sustained fight for social justice in the Indian Institute of Technology (IIT) Madras and for her contribution to mathematics. The award, instituted in the memory of Indian-American astronaut Kalpana Chawla who died aboard Space Shuttle Columbia, carried a cash prize of five lakh rupees (the highest prize-money for any Indian award) and a gold medal.

She can be contacted at vasanthakandasamy@gmail.com

Web Site: <http://www.vasantha.in>

Dr. K. Ilanthenral is Assistant Professor in the School of Computer Science and Engg, VIT University, India. She can be contacted at ilanthenral@gmail.com

Dr. Florentin Smarandache is a Professor of Mathematics at the University of New Mexico in USA. He published over 75 books and 200 articles and notes in mathematics, physics, philosophy, psychology, rebus, literature. In mathematics his research is in number theory, non-Euclidean geometry, synthetic geometry, algebraic structures, statistics, neutrosophic logic and set (generalizations of fuzzy logic and set respectively), neutrosophic probability (generalization of classical and imprecise probability). Also, small contributions to nuclear and particle physics, information fusion, neutrosophy (a generalization of dialectics), law of sensations and stimuli, etc. He got the 2010 Telesio-Galilei Academy of Science Gold Medal, Adjunct Professor (equivalent to Doctor Honoris Causa) of Beijing Jiaotong University in 2011, and 2011 Romanian Academy Award for Technical Science (the highest in the country). Dr. W. B. Vasantha Kandasamy and Dr. Florentin Smarandache got the 2012 New Mexico-Arizona and 2011 New Mexico Book Award for Algebraic Structures. He can be contacted at smarand@unm.edu

Special feature of these subset vertex multigraphs is that we are aware of the elements in each vertex set and how it affects the structure of both subset vertex multisubgraphs and edge multisubgraphs. It is pertinent to record at this juncture that certain ego centric directed multistar graphs become empty on the removal of one edge, there by theorising the importance, and giving certain postulates how to safely form ego centric multinetworks.

US \$40.00

EuropaNova

ISBN 978-1-59973-633-4

